

EDN

SPECIAL ISSUE—Part 2
Product Showcase No 24

Highlighting key trends in
components, instruments,
computers & peripherals, and
computer-aided engineering

Expanded literature section

ELECTRONIC TECHNOLOGY FOR ENGINEERS AND ENGINEERING MANAGERS

PRODUCT SHOWCASE

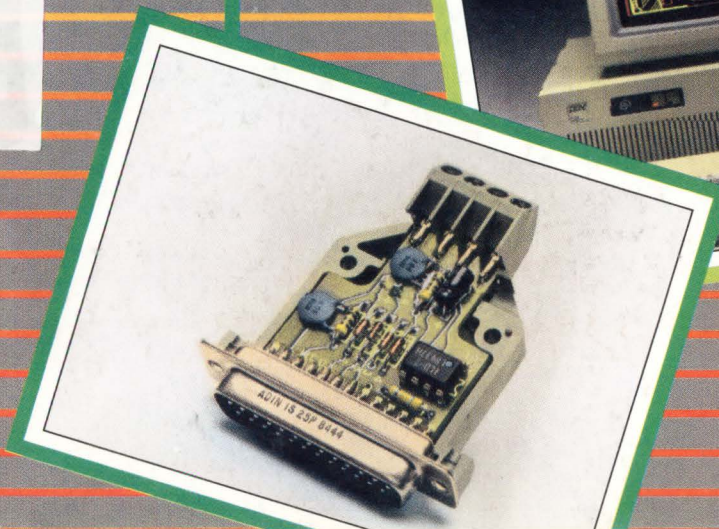
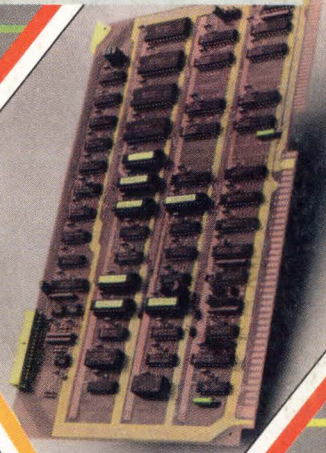

Total Integration. From Concept to Prototype.

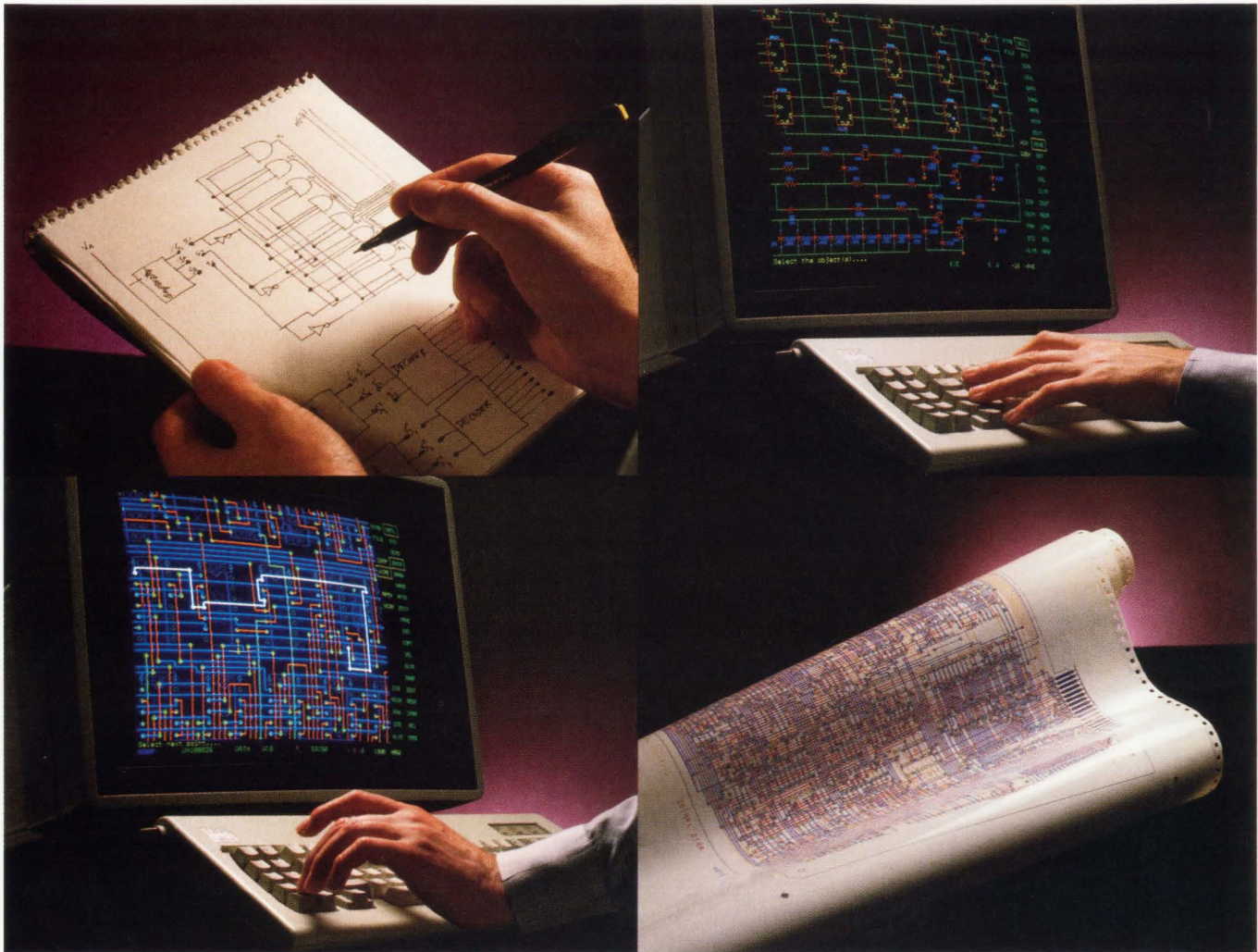

P-CAD's newest generation CAE/CAD design tools can take you all the way from concept to finished design on one system. That's why it's the Benchmark against which other design automation products are being judged.

FIRST, COMPARE FUNCTION.

P-CAD provides a true end-to-end PCB design solution. From interactive schematic capture, through automatic component placement and routing of trace interconnections and beyond, to paper tapes for NC drilling machines. All the way from concept to prototype on a single, integrated system.

NEXT, COMPARE PRICE.

P-CAD's modular PCB design software runs on a standard IBM

PC-XT, AT™, or compatible computer. So you get the functionality of a high-priced workstation at a fraction of the cost.

THEN, COMPARE OUR FEATURES WITH EVERYONE ELSE.

Other CAE/CAD systems give you some of P-CAD's features. Only P-CAD has them all. PLD and semi-custom IC design, in-circuit simulation, and comprehensive libraries are all available on a single P-CAD PC-based system.

NOW, COMPARE COMPANIES.

P-CAD's customer commitment doesn't stop once your system is delivered. Our comprehensive product documentation, customer service hotline, on-site and localized training programs, active user's group,

electronic bulletin board, quarterly newsletter, and 75-office worldwide network make us the benchmark in customer support.

For more information, or a product demonstration, call P-CAD toll-free at (800) 628-8748 (in CA: (800) 523-5207; Internationally: (408) 971-1300). Or write: Personal CAD Systems Inc., 1290 Parkmoor Ave., San Jose, CA 95126. TELEX 3717199. (P-CAD products also available for rent or lease from US Instrument Rentals.)

And put the benchmark to work for you.

© 1986, Personal CAD Systems, Inc. IBM, PC, XT, and AT are registered trademarks of International Business Machines Corp.

p-cad
THE BENCHMARK

Starting now, this is the standard every phase must face.

You're looking at a phase synthesizer so accurate it should become the standard for every phase meter in existence. An instrument so versatile it can revolutionize every phase-dependent testing procedure.

The Model 650 Variable Phase Synthesizer from Wavetek.

Model 650 uses the NBS digital signal synthesis technique to produce waveforms with 0.005° phase accuracy and 10 digits of frequency resolution.

Phase Meter Calibration

Now, instead of using two signal generators, a phase meter, a computer, and several hours of time, you can calibrate a phase meter in minutes. With Model 650's phase sweep and an x-y plotter, you can quickly map a meter's response over 360°.

But Model 650 is more than accurate. It is powerful—up to 50 Vp-p into 50 ohms. It is versatile—a wide range of waveforms and modes over 100 μ Hz to 2 MHz. It is expandable—the standard two-channel or optional four-channel output can be multiplied by cascading up to 10 instruments for as many as 40 channels.

Synchro/Resolver Simulation

Since it is completely GPIB programmable, Model 650 is ideal for synchro and resolver simulation. You can preprogram a robot's full sequence of actions, create a radar tracking scenario, or put a weapons guidance system through its paces.

Powerful Easy To Use

For all its power, Model 650 is surprisingly simple to use. Plain English menus in the display guide you through every procedure, and up to 25 complete instrument setups can be stored in non-volatile memory.

Another surprise is the price. If you could assemble a system that provided comparable capabilities, it would cost many times more. And, to be safe, you would still want to check it against the ultimate phase synthesizer: Model 650.

For more information, call or write Wavetek San Diego, Inc., 9045 Balboa Ave., P. O. Box 85265, San Diego, CA 92138. Tel. (619) 279-2200; TWX-335-2007.



REAL-TIME MULTITASKING INDUSTRIAL CONTROL WITHOUT BEING LOCKED INTO A PROGRAMMABLE CONTROLLER

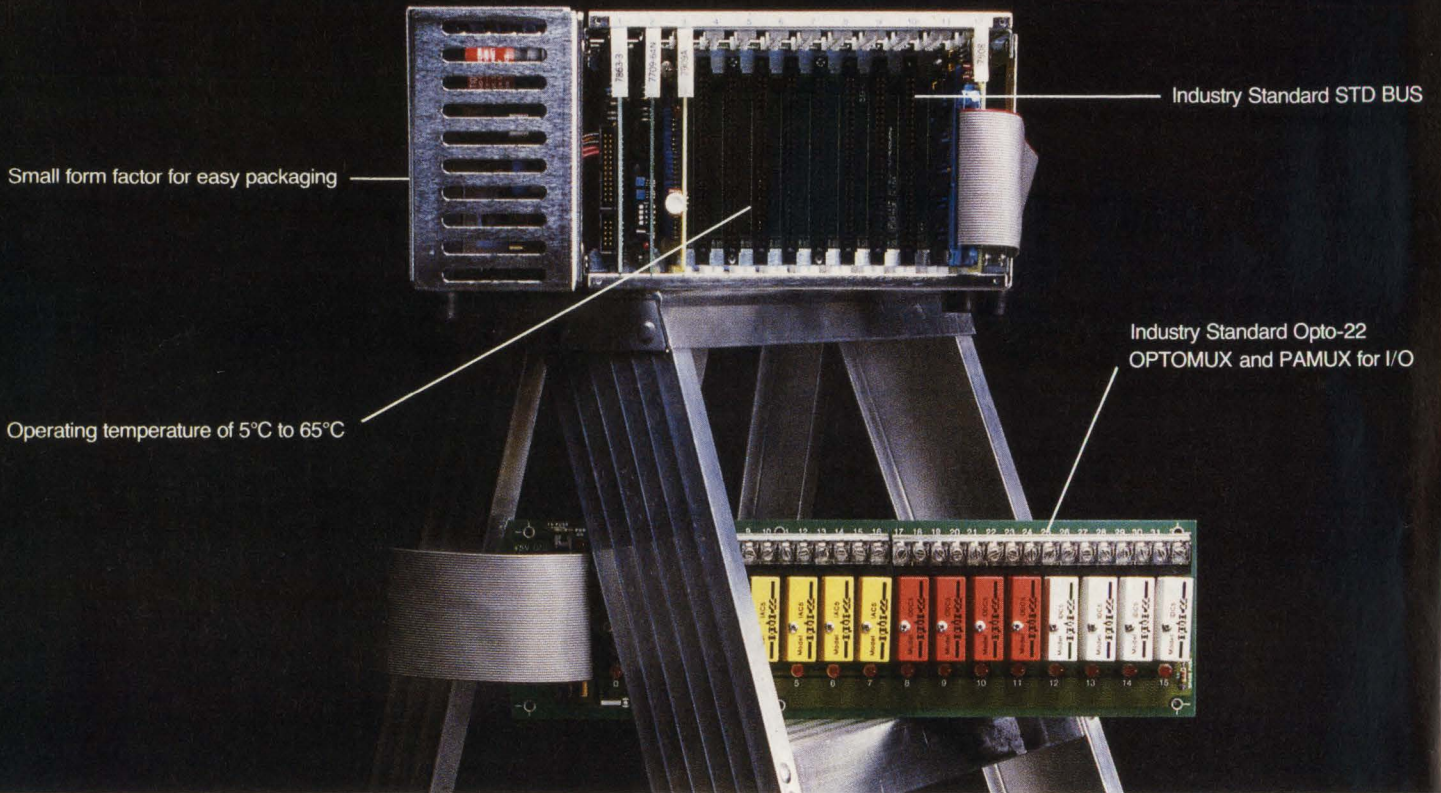

How? By using Pro-Log's new System 1 Industrial Computer.

Like a programmable controller, System 1 runs relay ladder programs . . . but with many enhanced features such as 4-function math, stepper drums, and PID loops.

Unlike a programmable controller, System 1 is based on an industry standard: the STD BUS. So you get a modular system that you can easily upgrade — a system supported by a large number of vendors and one that won't change next year. I/O expansion is also based on industry standards, like Opto-22's OPTOMUX and PAMUX.

Reliability is the number one concern on the factory floor. System 1 has a Mean Time Between Failures (MTBF) of over 5 years, a Mean Time To Repair (MTTR) of under 5 minutes, and Pro-Log covers it with a 5-year parts and labor warranty.*

*Excludes power supply

And, if you're not convinced yet that System 1 suits your control application, we've built in the capability to add a second processor that runs Microsoft's MS-DOS. (MS-DOS is the operating system of the personal computer.)

So, while one processor is handling the real-time demands of your control system, the other is handling the real-time demands of your job: Like data analysis, communications, or generating management reports.

You program System 1 with an IBM PC or compatible and the RD-1000 Relay Ladder Logic Editor/Monitor, at your desk or on the factory floor. RD-1000 lets you create, modify, document, download, and test your relay ladder control program. RD-1000 is distributed by Pro-Log.

Unlock yourself from the programmable controller! Call Pro-Log today: (800) 538-9570, inside California (408) 372-4593. Or write to Pro-Log Corporation, 2560 Garden Road, Monterey, CA 93940.

SYSTEM 1 SUPPORTS:

4-Function math	20 Shift registers
Compare and jump	32 Stepper drums
1040 Digital I/O	2000 Set points
416 Analog I/O	6000 Control relays
120 Timers	40 PID loops
100 Counters	

RD-1000 is a trademark of CPI Industrial Software, a division of Control Process.

Microsoft and MS-DOS are registered trademarks of Microsoft Incorporated.

IBM PC is a registered trademark of International Business Machines.

 **PRO-LOG[®]**
CORPORATION

USA TLX: 171879; Australia (02) 419-2088; Canada (416) 625-7752; England (0276) 26517; France (1) 3956-8142; Germany (07131) 50030; Italy (2) 498-8031; Switzerland (01) 62 44 44.

ADGROUP INTERNATIONAL PL053

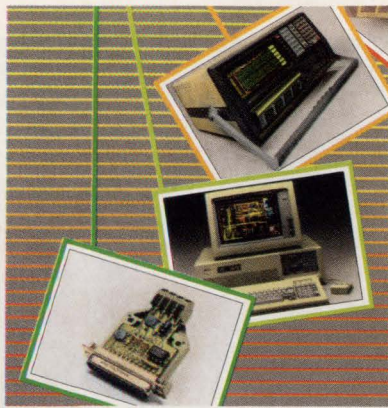

On the cover: Part 2 of EDN's Product Showcase No 24 highlights innovative computers and peripherals (pg 57), computer-aided-engineering products (pg 89), instruments (pg 107), and components (pg 133) introduced since July. (Cover concept by Kathleen Ruhl, photos hand tinted by Wayne Dreese)

DESIGN FEATURES

Computers and Peripherals

Optical-disk drives target standard 5¼-in. sites 42

Optical-disk drives are now available in the 5¼-in. format. You can currently choose from two types: optical ROM and write-once, read-many drives. A third type of optical drive, the erasable optical drive, is still under development.—*Steven H Leibson, Regional Editor*

Computer-Aided Engineering

Expert designers evaluate PC-based schematic editors 82

To make your selection easier, EDN obtained information about three popular schematic editors from experienced users of the packages.—*Eva Freeman, Associate Editor*

Instruments

Fiber-optic testers determine faults in short-haul networks 98

Fiber-optic cables in short-haul data-communications networks are becoming increasingly popular, and as a result you may find yourself chasing photons as well as electrons while debugging your next system/network interface.—*Margery S Conner, Regional Editor*

Components

Display modules span existing technologies, suit diverse uses 124

Your choices in building a display subsystem are to buy displays by the character and then design the drive electronics yourself, or to save design time by purchasing a turnkey, intelligent display module.—*Tarlton Fleming, Associate Editor*

PRODUCT REVIEWS

Computers and Peripherals	57
Computer-Aided Engineering	89
Instruments	107
Components	133

Continued on page 7

EDN (ISSN 0012-7515) is published biweekly with one additional issue in January, February, and March, and two additional issues in April through December by Cahners Publishing Co, a Division of Reed Publishing USA, 275 Washington Street, Newton, MA 02158. William M Platt, President; Terrence M McDermott, Executive Vice President; Jerry D Neth, Vice President of Publishing Operations; J J Walsh, Financial Vice President/Magazine Division; Thomas J Dellamaria, Vice President Production & Manufacturing; Frank Sibley, Group Vice President. Copyright 1986 by Reed Publishing USA, a division of Reed Holdings Inc; Saul Goldweitz, Chairman; Ronald G Segel, President and Chief Executive Officer. Circulation records maintained at Cahners Publishing Co, 270 St Paul St, Denver, CO 80206. Second class postage paid at Denver, CO 80202 and additional mailing offices. Postmaster: Send address changes to EDN, 270 St Paul St, Denver, CO 80206.

Superior performance now runs in the family.



Introducing the 8842A digital multimeter.

Choices. Choices.

Should you choose the powerful Fluke 8840A? Or the new, advanced 8842A?

Depending on the level of performance you need, consider this:

Enhanced capabilities for new applications.

The new 8842A is so technologically superior, it can outperform DMMs costing twice as much. Its capabilities include 0.003% 1-year basic accuracy and 100 nV resolution for dc voltage measurements. And it incorporates exclusive new thin film resistors* for a two-year calibration cycle.

The widely-accepted 8840A on the other hand, offers value unmatched by any other

DMM in its class. Like the 8842A, it's simple to operate. It gives you long-term reliability. And it delivers high productivity with a low overall cost of ownership.

Choose either model for under \$1,000.

The 8840A starts at \$760, the 8842A at \$995. With inexpensive IEEE-488 and true RMS AC options available for both models.

Which one is right for you? The choice may not be easy.

But at least now, it's a family decision.



**Call toll-free 1-800-44-FLUKE
(1-800-443-5853) Ask for extension 140.**

Talk to our sales engineers about the

8840A and the new 8842A. Take advantage of our **no-risk 15-day trial period.**

FROM THE WORLD LEADER IN DIGITAL MULTIMETERS.

FLUKE 8840A	FLUKE 8842A
0.005% basic dc accuracy (1 Yr.)	0.003% basic dc accuracy (1 Yr.)
0.16% basic ac accuracy (1 Yr.)	0.08% basic ac accuracy (1 Yr.)
0.013% basic ohms accuracy (1 Yr.)	0.008% basic ohms accuracy (1 Yr.)
Resolution to 1 μ V dc, 10 μ A dc, 1m Ω	Resolution to 100nV dc, 1 μ A dc, 100 μ Ω
One-year specifications and warranty	Two-year specifications and warranty
8840A \$760	8842A \$995
8840A-05 IEEE-488 Interface \$150	8842A-05 IEEE-488 Interface \$150
8840A-09 TRMS AC option \$185	8842A-09 TRMS AC option \$250



* Patent pending
IN THE U.S. AND NON-EUROPEAN COUNTRIES: John Fluke Mfg. Co., Inc., P.O. Box C9090, M/S 250C, Everett, WA 98206, Sales: (206) 356-5400, Other: (206) 347-6100.
EUROPEAN HEADQUARTERS: Fluke (Holland) B.V., P.O. Box 2269, 5600 CG Eindhoven, The Netherlands, (040) 458045, TLX: 51846.
© Copyright 1985 John Fluke Mfg. Co., Inc. All rights reserved. Ad No. 2801-8842

VP/Publisher
F Warren Dickson

VP/Associate Publisher/Editorial Director
Roy Forsberg

Editor
Jonathan Titus

Managing Editor
Rick Nelson

Assistant Managing Editor
Joan Morrow

Special Projects
Gary Legg

Home Office Editorial Staff
275 Washington St, Newton, MA 02158
(617) 964-3030

Tom Ormond, *Senior Editor*
Bill Travis, *Senior Editor*
Deborah Asbrand, *Staff Editor*
Joanne Clay, *Staff Editor*
Tarlton Fleming, *Associate Editor*
Eva Freeman, *Associate Editor*
Clare Mansfield, *Staff Editor*
Charles Small, *Associate Editor*
George Stubbs, *Staff Editor*
Chris Terry, *Associate Editor*
Jim Wiegand, *Associate Editor*
Valerie DeSalvo, *Assistant Editor*
Helen McElwee, *Assistant Editor*
Cynthia B Rettig, *Assistant Editor*
Steven Paul, *Production Editor*

Editorial Field Offices

Margery S Conner, *Regional Editor*
Newbury Park, CA: (805) 499-7901

Denny Cormier, *Regional Editor*
San Jose, CA: (408) 296-0868

Bob Cushman, *Special Features Editor*
Port Washington, NY: (516) 944-6524

Chris Everett, *Regional Editor*
San Jose, CA: (408) 296-0868

Steven H Leibson, *Regional Editor*
Boulder, CO: (303) 494-2233

J D Mosley, *Regional Editor*
Arlington, TX: (817) 465-4961

David Shear, *Regional Editor*
San Jose, CA: (408) 296-0868

Maury Wright, *Regional Editor*
San Diego, CA: (619) 748-6785

Peter Harold, *European Editor*
0603-630782
(St Francis House, Queens Rd,
Norwich, Norfolk NR1 3PN, UK)

Contributing Editors
Robert Pease, Bob Peterson, Don Powers

Editorial Services
Kathy Leonard, *Office Manager*
Loretta Curcio, Nancy Weiland
Sharon Gildea

Art Staff
Kathleen Ruhl, *Art Director*
Roseanne D Coveney, *Graphic Designer*
Chin-Soo Chung, *Graphic Designer*
Deborah Queally, *Graphic Designer*

Production/Manufacturing Staff
William Tomaselli, *Production Supervisor*
Donna Pono, *Production Manager*
Jane W Sullivan, *Production Manager*
Beth Ann Cooper, *Production Assistant*
Diane Malone, *Composition*

Graphics Director
Norman Graf

VP/Production/Manufacturing
Wayne Hultizky

Director of Production/Manufacturing
John R Sanders

VP/Research
Ira Siegel

Director of Marketing Communications
Deborah Virtue

Marketing Communications
Jennifer Ware, *Communications Manager*
Corie Rand, *Promotion Coordinator*
Susan Odell, *Promotion Assistant*

EDITORIAL

35

Communication is the key to building profitable bilateral trade relations with foreign companies.

PRODUCT UPDATE

38

250-MHz, triple 8-bit video DAC

LITERATURE

Hardware and Interconnect Devices

161

Power Sources

162

Software

164

ICs and Semiconductors

165

PROFESSIONAL ISSUES

169

Former engineers parlay technical expertise into new careers.—*Deborah Asbrand, Staff Editor*

LOOKING AHEAD

179

Optical-disk-drive market to reach \$2 billion by 1991 . . . Communications equipment to show increased use of ICs.

DEPARTMENTS

News Breaks	14
Signals & Noise	21
Calendar	30
Readers' Choice	41
Business/Corporate Staff	155
Career Opportunities	173
Advertisers Index	178

A product-oriented design aid

EDN's editors have surveyed the new-product offerings from thousands of companies, selecting only the most significant of those offerings introduced in the last six months. You can use this Product Showcase as a reference until the next one that covers these four key product areas appears in July.

EDN's Design Ideas department will return next issue.

Advertising and editorial offices: 275 Washington St, Newton, MA 02158. Phone (617) 964-3030. Subscription offices: 270 St Paul St, Denver, CO 80206. Phone (303) 388-4511. EDN is circulated without charge to those qualified. Subscription to others: Continental US \$90/year, \$5/copy; Canada and Mexico \$100/year, \$6/copy; Europe Air Mail \$125/year, \$7/copy; all others surface mail \$155/year; all other airmail \$175/year. Special issue prices may vary. Send requests for qualification forms and/or change of address to subscription office.
© 1986 by Reed Publishing USA, Division of Reed Holdings Inc. All rights reserved.



▽BPA ABP

Cahners Publishing Company A Division of Reed Publishing USA
Specialized Business Magazines for Building & Construction Electronics & Computers Foodservice Manufacturing Book Publishing & Libraries Medical/Health Care

Hitachi's One-Time Programmable CMOS Microcontroller

Arctic foxes are incredibly resourceful. They have to be, to survive a harsh environment where others, less clever, can perish.

In today's competitive design environment, you too have to keep moving. The fast and clever win. Hitachi makes winning possible with ZTAT™—an 8-bit CMOS microcontroller with a built-in user-programmable ROM, in an economical package. ZTAT—Zero Turn-Around Time—eliminates the need to wait three to four months to receive your mask ROM devices. Think what this means to your entire design and marketing process.

The very *day* you finish development, ZTAT gets you into production. No mask charges. No minimum order quantities. No working sample approvals. No waiting for mask ROM devices. Just issue a purchase order. And, if you should decide to modify your software, you're not stuck with a useless inventory of programmed devices. That's because

ZTAT lets you make code changes quickly—even *during production*.

High performance with unsurpassed versatility. ZTAT is a whole family of CMOS 8-bit microcontrollers that are code compatible with Motorola's 6800 series. These devices contain virtually all the subsystems *on-chip* that are necessary to design sophisticated systems. They include 4K of one-time user-programmable ROM, 192 bytes of RAM for data storage, I/O ports, and a serial communications interface. All of this comes in a cost-effective plastic package. The packaging is one of the reasons why ZTAT only costs slightly more than mask ROM microcontrollers, and is *a lot* cheaper than ceramic reprogrammable devices. Hitachi is the first to offer you this total CMOS system.

The features of ZTAT are impressive. And they will outperform the competition.



Clever

ZTAT is part of a total design package. ZTAT is a member of Hitachi's 6301/6305 8-bit CMOS microcontroller family, which includes ceramic reprogrammable devices, ZTAT devices and plastic packaged mask ROM devices. This means Hitachi is the only company to offer you a choice of CMOS microcontrollers that are right for every phase of your product's life cycle: development, pilot production, and large-scale production. The reprogrammable, ZTAT, and mask ROM devices are all pin-for-pin compatible, making it easy to shift from one phase to another. Key members of the 6301 family are second-sourced by Motorola.

And, if your marketing strategy focuses on niche markets with smaller production volumes, ZTAT saves you the expense of having to use ceramic devices in production. The cost savings are substantial, even in single lot quantities.

It's easy to be clever. ZTAT makes time work for you, not against you—without your having to make large commitments; while preserving your flexibility. To learn more, call your local Hitachi Sales Representative or Distributor Sales Office today.

Fast Action: To obtain product literature immediately, CALL TOLL FREE, 1-800-842-9000, Ext. 6809. Ask for literature number R15.

Hitachi America, Ltd.
Semiconductor and IC Division
2210 O'Toole Avenue, San Jose, CA 95131
Telephone 1-408/435-8300

 **HITACHI**
We make things possible



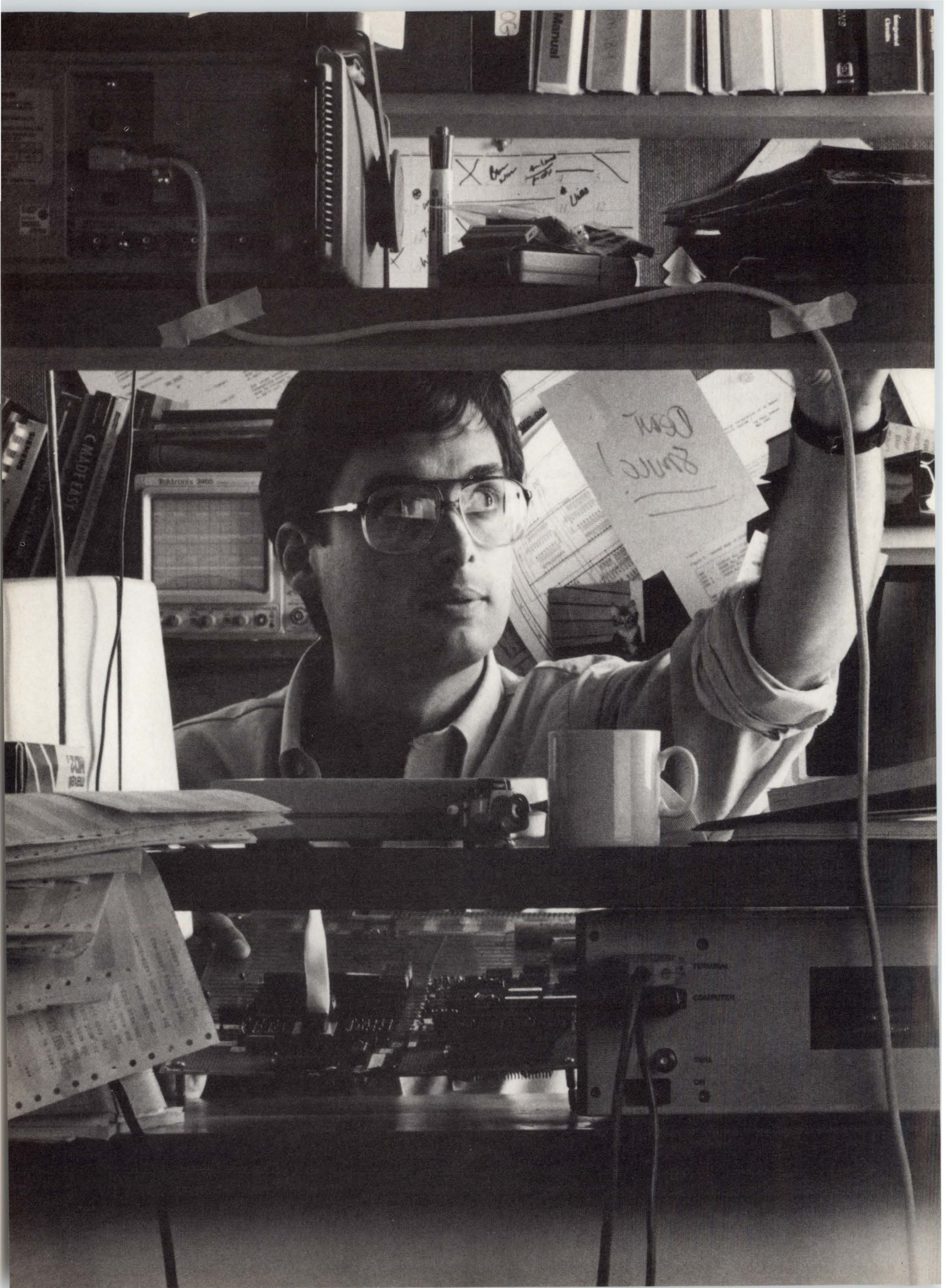

The difference between a few more tweaks and a few more weeks.

Introducing the CIDS method from Applied Microsystems. The first painless way to assemble the debug environment you really need.

You could spend weeks looking for the right tools, plus months trying to make them work together, and still not have a system that was truly integrated. That's why Applied Microsystems has developed the CIDS method.

CIDS stands for Customer Integrated Development Systems and the concept is simple. You choose your hardware and software tools. Applied Microsystems makes sure they work together seamlessly.

An overview of Customer Integrated Development Systems.

Whether you're working on an 8-bit, 16-bit or even a 32-bit design, we let you tailor the emulation and debug tools you need. Everything from symbolic and source-level debuggers to assemblers, cross-compilers and utilities. The chart gives you some idea of the power and convenience of the CIDS method, but it can only hint at the control and visibility you will enjoy.

Validate™ links emulation with source-level debugging.

When your software engineers only speak C and your emulator

HOSTS	OPERATING SYSTEMS	TARGETS	LANGUAGES	TOOLS
VAX	VMS	8048 family	C	Assemblers
MicroVAX	ULTRIX	8080, 8085, 8086/88, 80186/188 and 80286	Pascal	Linkers
UNIX-oriented workstations	UNIX		FORTTRAN	Locaters
• Apollo	XENIX		PL/M	Compilers
• Sun	MS-DOS	68HC11, 6800/2/8, 6809/9E, 68000/8/10 and 68020	Assembler	Symbolic debuggers
• IBM AT		Z80, MK3880/4 and Z8001/2/3		Source-level debuggers
MS-DOS workstations		NSC-800		Emulators
• PC				
• PC XT				
• PC AT				

A stand-alone or host-control system of fully integrated debug tools built on high performance emulation.

only speaks assembler, your tools are worthless. Or if your function is in assembler and your debugger only speaks C, it's the same dead end.

The power of the Validate environment is that it works equally in high level languages and in assembler. You don't sacrifice any power or comfort.

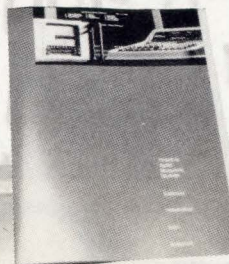

Real-time emulation for the 68020 and 80286.

Applied Microsystems lets you emulate high performance targets at top speed. Up to 16.6 MHz for the 68020. And 12.5 MHz for our new 80286 with full function implementation. Free access to the virtual protect mode makes transparent emulation possible using logical or physical addresses.

Call toll-free and ask for the proof.

Discover why the CIDS method is the fastest, easiest way to start and finish a design project. For technical and application details call 1-800-426-3925. In Washington state call (206) 882-2000. Or write Applied Microsystems Corporation, P.O. Box 97002, Redmond, WA 98073-9702.

In Europe: Applied Microsystems, Brooke House, Market Square, Aylesbury, Buckinghamshire, HP20 1SN, England. Tel: 44 (0296) 34822.



Applied Microsystems Corporation

CIRCLE NO 77



We've Come Light Electro Optic

Our line of electro optic components is backed by years of experience in fiber optics. We've designed and manufactured hundreds of reliable fiber optic products, representing many significant advancements.

And with Siecor, you not only get all that expertise, you get everything you need for fiber optic data transmission. Including the 200 MBaud data link with excellent sensitivity and wide dynamic range. Clock recovery mod-

ules with precision SAW filters. Reliable couplers and WDM's that feature low loss and mode independence. And compact fiber optic switches which pass stringent tests for vibration, shock and temperature while maintaining



Years To Bring You Components.

superior repeatability at high switching rates.

With Siecor, you've got the tools you need to expand the existing boundaries of computer systems design. So get with a company that's come a very long way to bring you

the electro optic components you've been waiting for.

Call or write us. Siecor Corporation, Electro-Optic Products, Post Office Box 13625, Research Triangle Park, North Carolina 27709-3625. Telephone 919/549-6571.

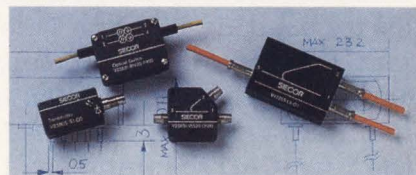

Left to right: 200 MBaud transmitter, fiber optic switch, WDM, T-coupler with pigtail.

SIECOR

NEWS BREAKS

EDITED BY JOAN MORROW

SUBNANOSECOND COMPARATOR INCLUDES GLITCH CAPTURE, HYSTERESIS

Suited to high-speed data capture in logic analyzers, counters, and data-conversion systems, the SP93808 octal comparator from Plessey Semiconductors (Swindon, UK, TLX 449637) features a typical propagation delay of 950 psec. Individual comparator delays in the device differ by ± 100 psec max. In addition, the comparator incorporates an output data latch and glitch-capture circuitry to capture subnanosecond glitches on individual channels. The eight comparators are divided into two groups of four; each group is controlled by a separate clock input. The comparators have a differential input range of $\pm 4V$, an input offset voltage of ± 5 mV, and an input capacitance of 1.5 pF typ. You can set the comparators' input hysteresis with one external resistor. The SP93808 costs \$39 (1000); quad and dual comparator versions, which will cost \$26 and \$15 (1000), respectively, will be available within two months.—Peter Harold

STD BUS MEMORY CARD MIXES 1M BYTES OF RAM AND EPROM

The SB8122 Byte-wide universal memory card from Micro/sys Inc (Glendale, CA, (818) 244-4600) can hold 8k to 1M bytes of a combination of EPROM and RAM. The board uses relatively expensive static RAMs (instead of dynamic RAMs) because the static RAMs do not require refresh signals, which can conflict with the STD Bus DMA signals. If your system requires a mixture of RAM and EPROM, the 40 to 50% price premium for the static RAMs can be offset by the cost savings of eliminating a second memory board. The board has eight 32-pin JEDEC sockets, which are upwardly compatible with 28-pin devices. The unpopulated SB8122 is \$145; with 512k bytes of static RAM, it costs \$595.—Margery S Conner

MACROCELLS ALLOW DESIGN OF SEMICUSTOM 1-CHIP MICROCOMPUTERS

By providing macrocells for a core μP and a variety of memory and peripheral devices, S9 family components from SGS Microelettronica SpA (Agrate Brianza, Italy, TLX 330131) allow you to design application-specific CMOS single-chip microcomputers. The core μP includes an 8/16-bit ALU, a 256-byte register file, a programmable interrupt controller, and a multichannel DMA controller. The processor can address as much as 128k bytes of address space, and it operates with an external clock frequency as high as 24 MHz. On-chip memory options include static RAM, nonvolatile RAM, EPROM, EEPROM, and ROM. On-chip peripheral devices include a serial communications controller, 8-bit I/O ports, an 8-bit A/D converter, and an on-chip gate array for custom logic. S9 designs can also incorporate customer-specific macrocells. In high volume, a minimal system part costs \$2.50 to \$3.—Peter Harold

SCANNING ATTACHMENT FOR PLOTTER DIGITIZES ANY E-SIZE DRAWING

For \$2995, you can add the Scan-CAD (Model 128) scanning input-device from Houston Instrument (Austin, TX, (512) 835-0900) to one of the company's DMP-50 Series drafting plotters. This scanning head will let you digitize hand-drawn or machine-generated hard copy as large as 36x48 in. for storage in an IBM-compatible computer. Scan-CAD converts an original image into a raster data file that you can manipulate with a variety of software packages. Installation takes only a few minutes; the Scan-CAD scanning head snaps onto your plotter without any modification to the plotter. Scanning resolution is 200 dots/in., and the scanning head can detect lines as fine as 0.007 in. on paper, vellum, and acetate film. Although scanning time depends on the complexity of the drawing, Scan-CAD can input a D-size drawing in about 12 minutes and an E-size drawing in about 24 minutes.—J D Mosley

TRW LSI

now offers you a second source for the Weitek WTL1032/1033...

at a lower price!

Now available in
68-lead Type A
package.

Until now, there has been only one source for these 32-bit floating point multipliers and ALUs. Now there is a second source—and it's even better!

TRW's new TMC3032 multiplier and TMC3033 ALU are your ideal alternatives to the WTL1032 and WTL1033. Pin and function compatible with the Weitek devices. 1/2-watt CMOS rather than 2-watt NMOS. And both have a throughput capability of 10 Megaflops.

The TMC3032 and TMC3033 are packaged in 64-pin DIPs and conform to IEEE 754.

Price (in 1000s) is only \$95 per chip. And—immediately available.

So for an alternative to what has been—until now—a single source, turn to TRW LSI Products

Division for an even better, and lower priced, second source. You can order these new devices now by contacting your local TRW Sales Office or distributor. The TMC3032J3C and TMC-3033J3C are in stock at Arrow Electronics, Hall-Mark and Hamilton/Avnet.

**Remember, you always get
FULL SPEC PERFORMANCE
from TRW LSI.**

For a data sheet or for super-fast information, call or write our Literature Service Department:

LSI Products Division,
TRW Electronic Components Group,
P.O. Box 2472, La Jolla, CA 92038,
619.457.1000

In Europe, call or write:
TRW LSI Products,
Konrad-Celtis-Strasse 81,
8000 Muenchen 70, W. Germany, 089.7103.115

In the Orient, phone:
Hong Kong, 3.856199;
Tokyo, 03.461.5121; Taipei, 751.2062

©TRW Inc. 1986-TRS-6100



LSI Products Division
TRW Electronic Components Group

NEWS BREAKS

32-BIT TRANSPUTER INCLUDES FLOATING-POINT INSTRUCTIONS

For math-intensive applications involving high-speed floating-point computations, consider using the IMS-T800 32-bit Transputer from Inmos (Bristol, UK, TLX 444723). The 20-MHz version of this Transputer performs 1.5M flops for 32-bit floating-point calculations and 1.1M flops for 64-bit calculations. The IMS-T800 is not a coprocessor for other members of the Transputer family, but it can be mixed with them in a multiprocessor environment. Communicating via four Transputer links, the IMS-T800 is pin- and software-compatible with the IMS-T414 32-bit Transputer, but it includes an on-chip 64-bit floating-point processor in addition to its 32-bit integer processor, 4k bytes of RAM, and the Transputer links. The 20-MHz versions, which will be available during the second quarter of 1987, will cost \$487.50, and the 17-MHz version will cost \$406.25 (100).—Peter Harold

FOUR COMPANIES ANNOUNCE PROPOSED WORM OPTICAL FORMAT

Optical Storage International, a division of Laser Magnetic Storage (Colorado Springs, CO), Alcatel Thomson Gigadisc Corp (France), Philips and Dupont Optical Co (The Netherlands), and Sony Corp (Japan) have jointly proposed a standard for 130-mm optical WORM (write-once, read-many) disks. The joint proposal is based on the standardization discussions currently underway in both US (ASC X3B11) and international (ISO) committees (for more information on this topic, turn to pg 42). The proposal uses a differential 4/15 modulation code with a Reed-Solomon product code for error detection and correction. Disk drives would use sampled servo information on the disks. The proposal allows either 512 or 1024 bytes per track and 20,000 tracks per side for a total disk-storage capacity of 300M bytes per side. The disk is clamped with a 25-mm magnetic hub on a 4-mm spindle.—Steven H Leibson

STORAGE-SCOPE CURSORS SET UP DELAYED TIMEBASE PARAMETERS

The PM3320 digital storage oscilloscope from Philips I & E Div (Eindhoven, The Netherlands, TLX 51573) has two input channels that sample waveforms to 10-bit resolution at 250M samples/sec, allowing you to capture repetitive waveforms with a bandwidth as high as 200 MHz. On-screen cursors allow you to measure captured waveforms and define the trigger point and timebase setting for subsequent measurements made with the delayed timebase function. The scope also features an 8x10-cm trace area on the CRT, in which you can simultaneously display as many as eight traces annotated outside the trace area, and an autoselection function for automatic selection of suitable vertical deflection and timebase sensitivities. The PM3320 sells for less than Gld 30,000 and has an optional IEEE-488 interface.—Peter Harold

IEEE TO FORM TESTABILITY-BUS AND SYSTEM-ARCHITECTURE GROUPS

Two industry-based committees recently submitted project authorization requests to the IEEE to form official working groups. The Testability Bus Standards Committee (TBSC), spearheaded by co-chairmen Jon Turino of Logical Solutions Technology Inc (Campbell, CA) and Mike Stora of GenRad Inc, comprises 41 members and plans to develop a standard test bus for electronic systems. The System Architecture Study Group also has co-chairmen: Thomas Harkaway of XYCOM (Saline, MI) and Shlomo Pri-Tal of Motorola (Tempe, AZ).

Basing its work on IEEE's P896 System Architecture Specification Outline, this group plans to develop higher-level compatibility standards, such as address map assignments and extended message-passing protocols for standard μ P buses.

—Steven H Leibson

THE FIRST NAME IN DIGITAL SCOPES

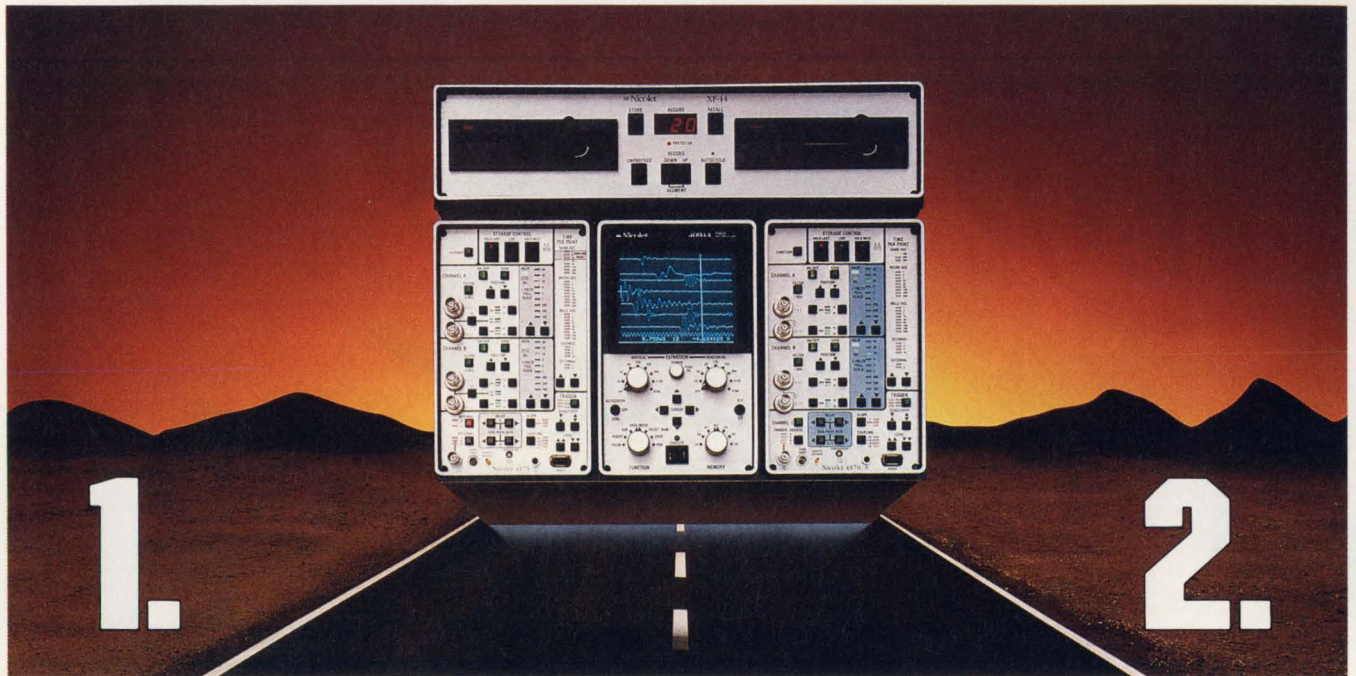

TWO DIGITAL SCOPES IN ONE.

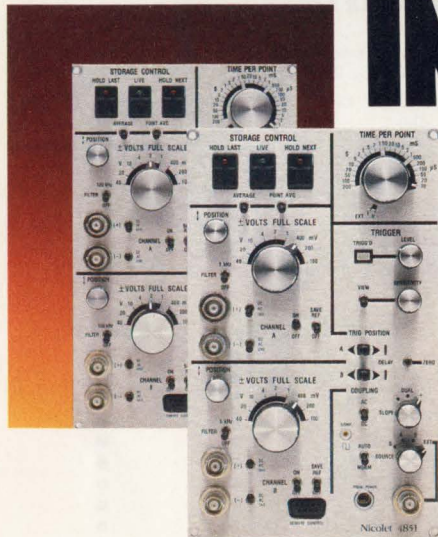

The Acquisition.

With sweep speeds from days to nanoseconds and resolution up to 15 bits, the 4094 digital 'scope can capture the most elusive signals. Every plug-in has 16K of memory, viewable trigger set-up and independent pre- or post-trigger delay on each channel. Signal averaging is standard and our latest 10 MHz/12-bit plug-in even offers real time manipulation of the incoming signals. With two plug-ins the 4094 can record four channels simultaneously. Or even monitor two slow signals and capture high speed glitches at the same time. All under computer control or via manual operation: whatever your application demands.

The Analysis.

Expand and examine any waveform feature in detail. Use the dual cursors and numerics to measure the time or voltage of any point. Compare live or stored waveforms with each other or with pre-recorded references. Store signals on disk manually or automatically. Use pushbutton programs to manipulate the data or send it to your computer via GPIB or RS232 interface. Complete your report with a hardcopy plot using the XY/YT recorder or digital plotter outputs.

First Time, Everytime.

Don't miss important data because of set-up errors. From the World's first in 1973 to the latest models, Nicolet 'scopes are easy to use. Find out how they can be the quickest solution to your signal problems. For more information call 608/273-5008, or write Nicolet Test Instruments Division, P.O. Box 4288, 5225 Verona Road, Madison, WI 53711-0288.

 Nicolet

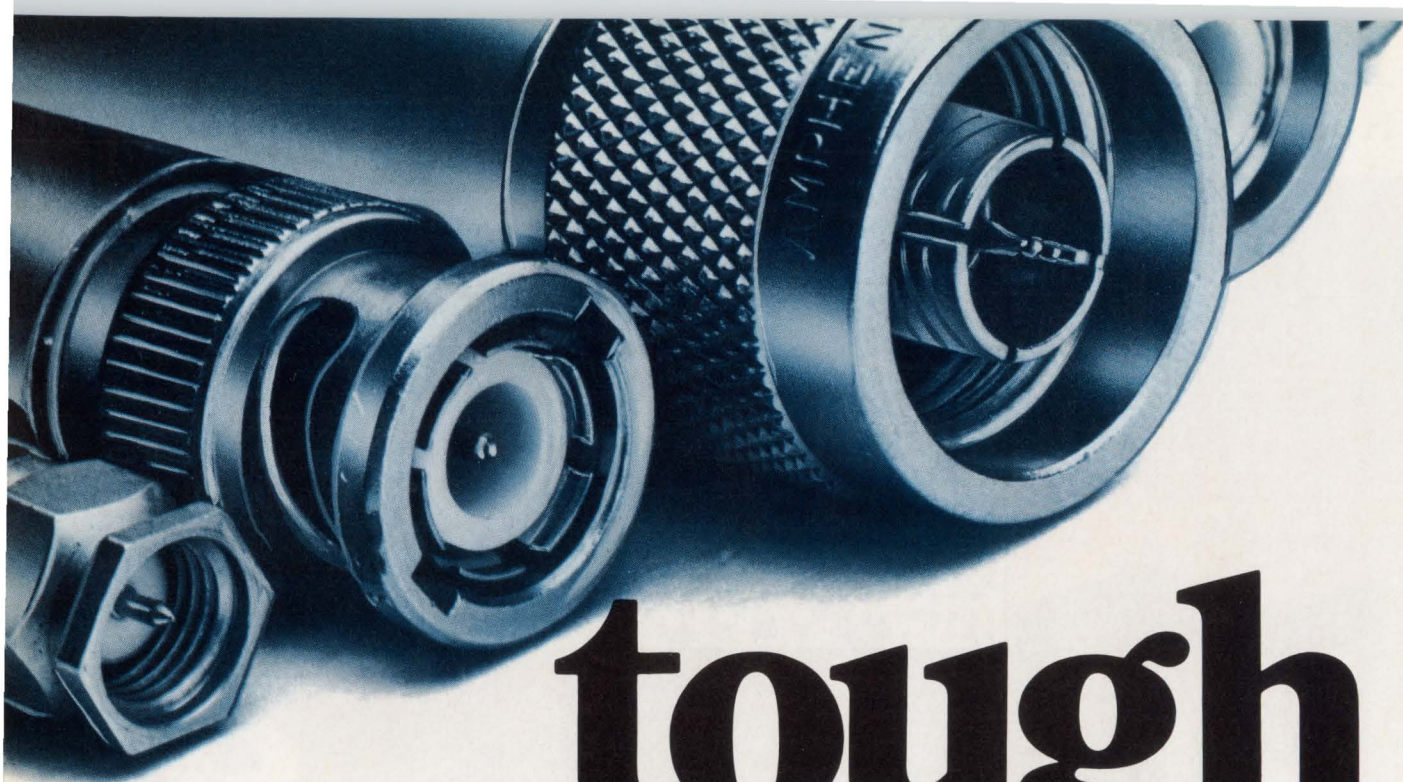

tough attenuators

from **\$11⁹⁵**
(1-49)

one-piece design defies rough handling

Check these features:

- ✓ Each unit undergoes high-impact shock test
- ✓ Available from 1 to 40 dB
- ✓ DC to 1500 MHz
- ✓ Unexcelled temperature stability, .002 dB/°C
- ✓ 2W max. input power (SMA is 0.5W)
- ✓ BNC, SMA, N and TNC models
- ✓ Immediate delivery, 1-yr. guarantee

NEW!

Precision 50-ohm terminations ... only \$6.95 (1-24)
 DC to 2 GHz, 0.25W power rating, VSWR less than 1.1
 BNC (model BTRM-50), TNC (model TTRM-50)
 SMA (model STRM-50), N (model NTRM-50)

finding new ways ...
 setting higher standards

Mini-Circuits

A Division of Scientific Components Corporation
 P.O. Box 166, Brooklyn, New York 11235 (718) 934-4500
 Domestic and International Telexes: 6852844 or 620156

*Freq. (MHz)	Atten. Tol. (Typ.)	Atten. Change, (Typ.) over Freq. Range		VSWR (Max.)	
DC-1500 MHz	±0.3	DC-1000 0.6	1000-1500 0.8	DC-1000 MHz 1.3	1000-1500 MHz 1.5

*DC-1000 MHz (all 75 ohm or 30 dB models) DC-500 MHz (all 40 dB models)

MODEL AVAILABILITY

Model no. = a series suffix and dash number of attenuation.

Example: CAT-3 is CAT series, 3 dB attenuation.

■ denotes 75 ohms; add -75 to model no.

● denotes 50 ohms

ATTEN	SAT (SMA)	CAT (BNC)	NAT (N)	TAT (TNC)
1	●	●	●	●
2	●	●	●	●
3	●	●■	●	●
4	●	●■	●	●
5	●	●■	●	●
6	●	●■	●	●
7	●	●■	●	●
8	●	●■	●	●
9	●	●■	●	●
10	●	●■	●	●
12	●	●■	●	●
15	●	●■	●	●
20	●	●■	●	●
30	●	●■	●	●
40	●	●■	●	●

PRICING (1-49 qty.): CAT (BNC)..\$11.95, SAT (SMA)..\$14.95
 TAT (TNC)..\$12.95, NAT (N)..\$15.95

C 92 REV. B

RF switches

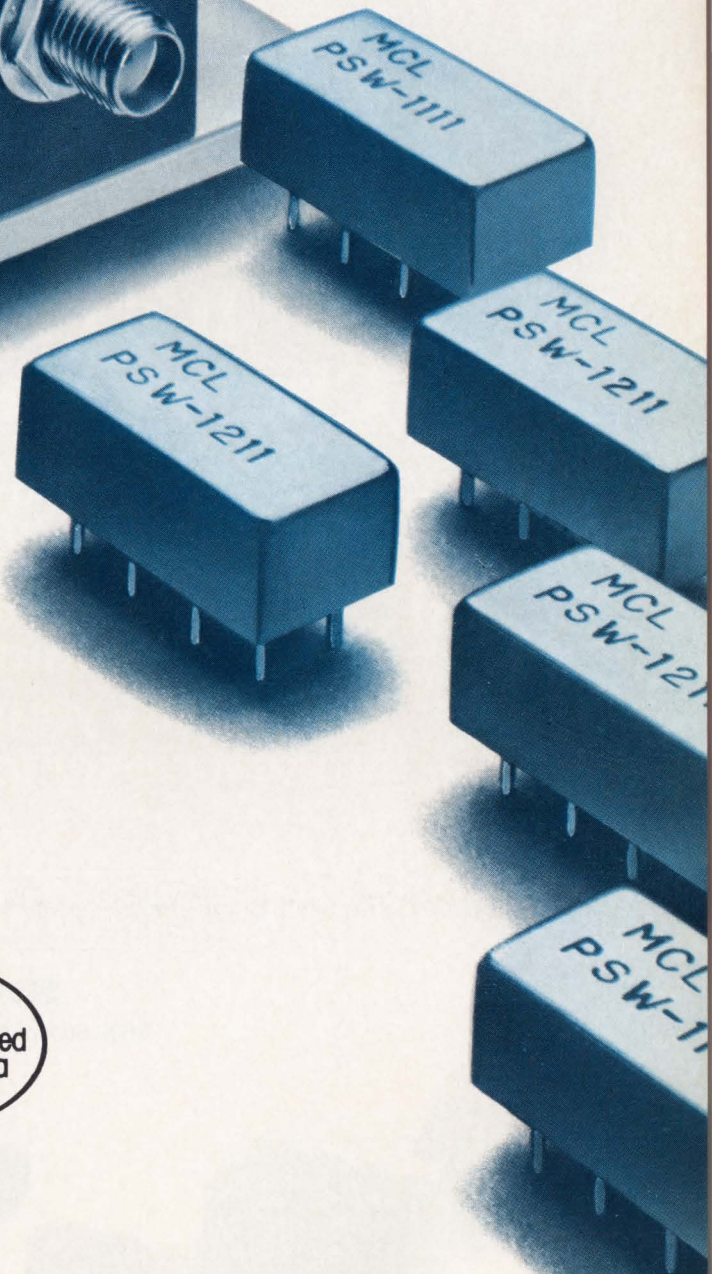
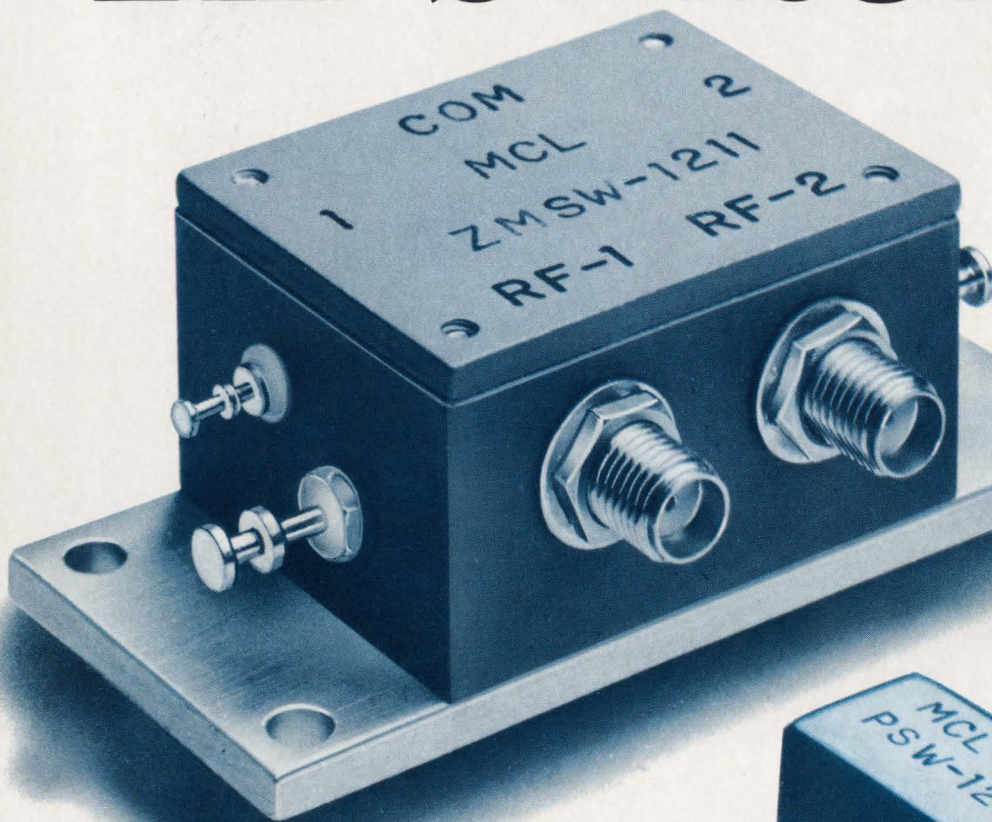

10 to 2500 MHz
from \$19⁹⁵ PSW 1211 (500 qty.)

Now, for your wideband systems design, under —\$20.00 SPST and SPDT pin diode switches that operate over the 10 to 2500 MHz range with less than 1 dB (typ.) insertion loss at 1000 MHz, 1.5 dB at 2500 MHz.

No waiting, immediate delivery . . . with one year guarantee. Call or write for our catalog or see our catalog in the Gold Book, EBG, EEM or Microwaves Product Data Directory.

SPECIFICATIONS for
PSW 1111 (SPST) and PSW 1211 (SPDT)
ZMSW 1111 and ZMSW 1211

FREQUENCY RANGE	10-2500 MHz
INSERTION LOSS	
10-2000 MHz	1.7 dB max.
2000-2500 MHz	2.7 dB max.
ISOLATION	
10-500 MHz	40 dB min.
500-1000 MHz	30 dB min.
1000-2000 MHz	25 dB min.
2000-2500 MHz	20 dB min.
SWR	1.5 max. ("on" state)
SWITCHING SPEED	1 μ sec. (max.)
MAXIMUM RF INPUT	+20 dBm
CONTROL	+5 V (5 mA max.)
OPERATING TEMPERATURE	-54°C to +100°C
STORAGE TEMPERATURE	-54°C to +100°C

PRICE (6-24)	(1-4)		
PSW 1111	\$29.95	ZMSW 1111	\$59.95
PSW 1211	\$29.95	ZMSW 1211	\$59.95



finding new ways ...
setting higher standards

Mini-Circuits

A Division of Scientific Components Corporation
P.O. Box 166, Brooklyn, New York 11235 (718) 934-4500
Domestic and International Telexes: 6852844 or 620156

CIRCLE NO 57

C80 REV. B



It's crystal clear Cherry has your switch.

Because you demand maximum reliability in the latest state-of-the-art components; cost effective and delivered on time, clearly your choice is Cherry. Take a closer look. Send for catalog.



SWITCHES

3600 Sunset Avenue, Waukegan, IL 60087
(312) 360-3500

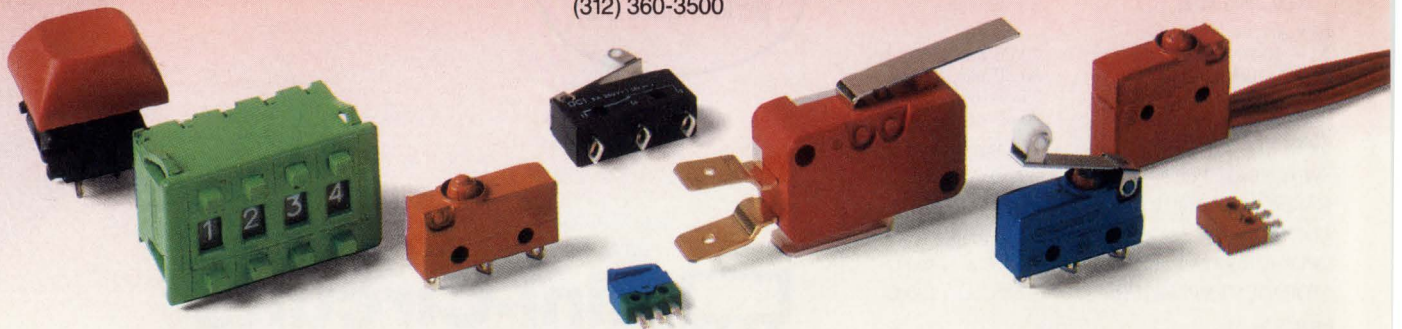

SIGNALS & NOISE

Caveat emptor

Dear Editor:

I was quite interested in the article "IBM PC-based software for CAE and CAD" in the September 18 issue of EDN (pg 162). The article does not, however, alert its audience to certain pitfalls of CAE packages.

I recently returned a CAE package to its manufacturer following a 2-week evaluation period. This package did not live up to its billing. On the surface, the product—a well-known schematic-capture package and its companion pc-board-layout package—appeared to fill the combined needs of our company and that of the service bureau working with us. In practice, it turned out otherwise.

The CAE and CAD packages each come with a binder containing product documentation. Because the CAE company doesn't offer any classes, the purchaser must famil-

iarize himself with the product primarily by studying the documentation on his own. Problems that cannot be cleared up by studying the documentation can supposedly be resolved by calling the firm's customer-service office.

During our evaluation, it soon became obvious that the documentation was inadequate, and the customer-service office was of little help. Specific flaws in the documentation included inaccurate installation directions and illustrations (these may have been accurate for an earlier release), and a lack of examples and illustrations associated with each command. The examples and illustrations that were present were not consistent with the results we obtained when we ran the package.

Furthermore, the text lacked clarity and was weakly organized; quite clearly, the documentation re-

flects a poor understanding of the needs of the engineer or designer. This was most unfortunate, I thought, because it was quite possible that the product itself was not nearly as weak as the documentation. The minimal support provided by the customer-service office primarily reflects inexperience with the product and some degree of insensitivity to the customer's needs for a timely and succinct clarification.

The CAD package, unfortunately, exhibited the same flaws. The problem I found the most aggravating, however, was that the manufacturer claims that this package is completely adequate to support a design of upward of 120 ICs, when in actual operation in a system configured as specified, it fails to reach 75 components. I subsequently learned that the 120-component count applies only if all components have the same

POWERFUL NEW HAND-HELD TERMINALS FOR DATA COLLECTION AND ON-SITE COMPUTING

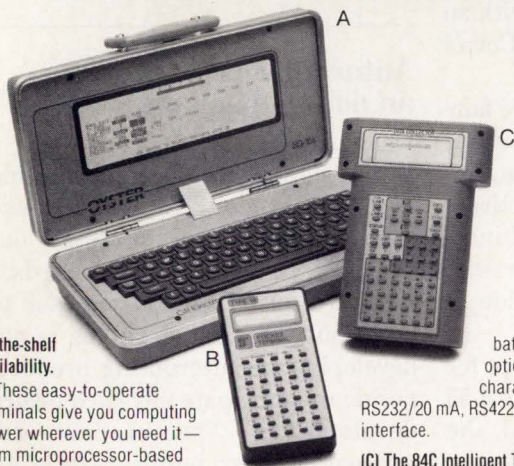

Off-the-shelf availability.

These easy-to-operate terminals give you computing power wherever you need it—from microprocessor-based systems interfacing to inventory control and data collection.

(A) The incredible Oyster: laptop terminals. Ruggedized for field service. Compatible with VT-100 terminals, 80 col. x 24 line screen.

(B) Pocket Terminals with up to 4K of EPROM; choice of LED/LCD displays and

battery power options. Full ASCII character set.

RS232/20 mA, RS422/423, or TTL interface.

(C) The 84C Intelligent Terminal: programmable in BASIC, compatible with IBM PCs, has 8, 32, 64 or 256K of RAM. 20 x 4 line (80 characters) LCD. Reads all commonly used bar codes.

All models can be customized to meet your requirements. Call or write today for details. Representative inquiries welcome.

G.R. Electronics

1640 Fifth St., Santa Monica, CA 90401 • Phone: (213) 395-4774 • Telex: 652337 (BT Smedley SNM) • Telefax: (213) 393-6040

CIRCLE NO 8

EDN December 25, 1986

An in-circuit emulator this powerful should cost ten times more!



ICEBOX gives you more than 65,000 breakpoints for less than \$600.00

For true full-speed emulation, ICEBOX is the portable alternative.

Small and compact, ICEBOX is the most cost-effective microprocessor emulation tool available. Perfect for troubleshooting, hardware and software development, production test and repair.

- 65,535 hardware breakpoints
- Built-in RAM and ROM tests
- Runs at target system speed
- Finds software bottlenecks in code
- Simple, powerful operator interface
- Z80, 64180, NSC800, 8085, 8086, and 8088 supported

Optional ICEpack software is available for symbolic debugging and special applications.

Find out how ICEBOX combines power and price to save time, money and guesswork!

Call 800/433-8812!

Ask About Our 14-Day Money Back Guarantee!

VISA, MasterCard, American Express Accepted!



SOFIAID, Inc.

8930 Route 108
Columbia, MD 21045-2101
301-964-8455

NOW AVAILABLE!
Models 8088 and 8086

CIRCLE NO 9

21

AMERICA'S BEST PROGRAMMERS

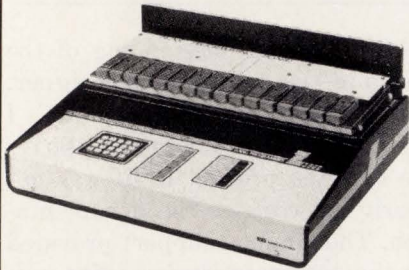

Z-3000 HIGH VOLUME GANG/SET PROGRAMMER

- 14,000 27256s programmed per day.
- 32 EPROMs simultaneously with 1 to 8 DATA BLOCKS.
- 16 Intel or Motorola MCUs at a time.
- 64K to 256K bytes of DATA RAM.
- Simple one key programming operation.
- Two RS-232 ports with data transfer formats included.

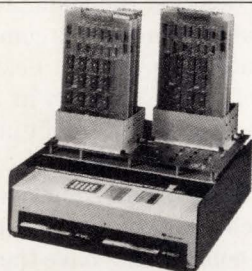

Z-2500B IN-CIRCUIT MEMORY CARD PROGRAMMER

- Programs up to 32 memory cards with EPROMs or microcomputers at a time.
- Two 1.2 Mbyte DSDD floppy disk drives. Optional 20 Mbyte hard disk.
- Turnkey systems include programmer, terminal, custom interface hardware and software.
- Simple menu driven operation.

Z-1000B UNIVERSAL PROGRAMMER

- Over 600 PLDs, EPROMs, EEPROMs, bipolar PROMs and INTEL MCUs.
- Upgradeable PROM based software.
- Stand alone or PC/XT/AT operation.
- Two independent RS-232 ports.
- 64K or 256K bytes of DATA RAM.
- EXATRON handler interface is standard.

Z-1200B TWELVE SOCKET GANG/SET PROGRAMMER

- 2716-27512, 1 to 4 DATA BLOCKS.
- 64K to 256K bytes of DATA RAM.
- Software personality. No plug-ins.

ZAP SERIES low cost programmers for EPROMs and single-chip MCUs.

Z-400 for bipolar PROMs and EPROMs.



SUNRISE ELECTRONICS, INC.

524 South Vermont Avenue
Glendora, California 91740
(818) 914-1926

SIGNALS & NOISE

physical dimensions—they must all be 16-pin ICs! Can anyone call this a fair representation? This fact alone makes the product unsuitable for its intended purpose, and the service bureau wasted several precious weeks before discovering this simple fact. (Incidentally, the CAE firm is now refusing to return payment on the CAD package. They claim that the 2-week evaluation period had been exceeded.)

The CAE field badly needs some sunlight. It may take an engineer a few hours to evaluate a \$5000 to \$10,000 piece of hardware, and that doesn't constitute a major investment, but a \$5000 to \$10,000 software product usually requires several man-weeks of evaluation.

Name withheld upon request

Op-amp comparison is misleading

Dear Editor:

In the September 18 issue of EDN, a Product Update introduces Precision Monolithics Inc's (PMI) new quad op amp, the OP-400 (pg 143). However, the introduction of this fine new device is combined with an attack on Linear Technology Corp's popular LT1014 quad op amp.

In the interest of journalistic fairness, I suggest that, in the future, you should check with the manufacturer of the device being selectively "compared," because several inaccuracies are contained in the article, which presents only PMI's side of the coin.

The article states that "except for power-supply current (0.725 vs 0.55 mA max per amplifier section), the OP-400 beats the LT1014 in substantially all key specs." Yet the LT1014's slew rate is twice that of the OP-400. Despite the LT1014's lower power dissipation, the LT1014 drives a 600Ω load to ±10V, with a gain of 2 million. The OP-400's gain is not specified for loads lower than 2 kΩ. The common-mode input range and output-voltage swing are

also significantly higher on the LT1014. As to channel separation, the LT1014's is 140 dB. I could not find this spec in the preliminary data sheet for the OP-400.

Probably most important is the fact that the LT1014 has a full set of specs for operation with a single 5V supply with the input and the output both extending to ground. Therefore, it can upgrade systems that use the LM324 single-supply quad op amp. The OP-400, need I say, does not function with a single supply.

I could go on (for example, the LT1014's typical capacitive-load-handling capability is 1200 pF, not 500 pF as stated in your article), but by now the point is made.

Sincerely yours,

George Erdi

Linear Technology Corp

Milpitas, CA

Ed Note: We agree with Mr Erdi that a more even-handed comparison would have been appropriate. Regarding the channel-separation spec, PMI's definitive data sheet for the OP-400 lists that spec as 123 dB min, the same spec that LTC's data sheet lists for the LT1014.

Autorouter is an add-on package

Dear Editor:

With reference to your autorouting systems article ("Autorouters use sophisticated algorithms to lay out complex, multilayer pc boards," EDN, August 7, pg 67), we wish to point out that Autodesk Inc is not developing an autorouting product, nor do we anticipate any such future development. The product described in your publication is an add-on package for use with our general-purpose drafting and design software, AutoCAD, and was developed by an independent software vendor.

Sincerely yours,

Laura A London

Autodesk Inc

Sausalito, CA

NEW REGULATOR KNOWS WHEN YOUR BATTERY IS LOW.

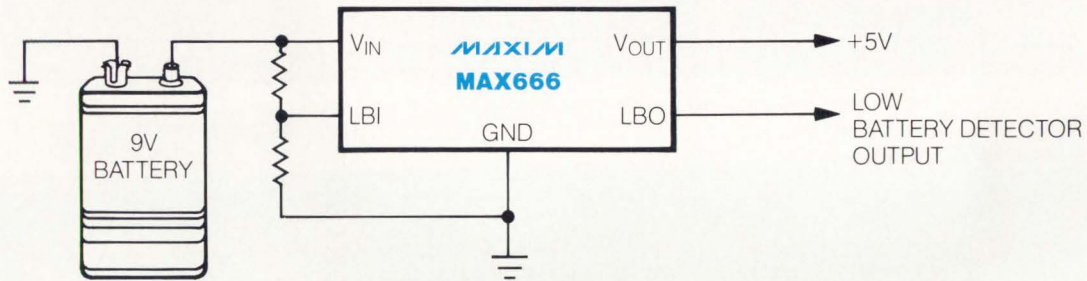

And there are more micropower regulators where that came from.

Function	I Supply (typ.)	Part #	Low Battery Indicator	Fixed V _{out}	Programmable V _{out}	Accuracy	Price (100 up)
Positive Regulator	6 μ A	MAX666	Yes	Yes (+5V)	+1.3V to +16V	\pm 5.0%	\$2.45
Positive Regulator	6 μ A	MAX663	No	Yes (+5V)	+1.3V to +16V	\pm 5.0%	2.15
Negative Regulator	6 μ A	MAX664	No	Yes (-5V)	-1.3V to -16V	\pm 5.0%	2.63
Positive Regulator	4 μ A	ICL7663A	No	No	+1.3V to +16V	\pm 1.0%	\$2.15
Negative Regulator	4 μ A	ICL7664A	No	No	-1.3V to -16V	\pm 1.0%	2.63
Voltage Detector	5 μ A	MAX8211	Yes	Adjustable Hysteresis	Open Drain	\pm 3.5%	\$1.53
Voltage Detector	5 μ A	MAX 8212	Yes	Adjustable Hysteresis	Open Drain	\pm 3.5%	1.53
Dual Voltage Detector	3 μ A	ICL7665A	Yes	Adjustable Hysteresis	Open Drain	\pm 2.0%	2.42

Plus features like low-power shutdown and pre-set outputs.

And the MAX666 is just the tip of the iceberg. If you don't need its on-chip low battery detector/indicator, take a look at the MAX663 and MAX664.

Like the MAX666, they come with pre-programmed 5V outputs, thereby eliminating external pots in most applications. All three can be trimmed to other output voltages (see table).

And to extend battery life, all three parts feature a low-power (logic level) system shutdown capability.

So call your authorized Maxim representative or distributor for samples and datasheets. Quick, before your batteries run down.

Maxim Integrated Products, 510 N. Pastoria Avenue, Sunnyvale, CA 94086, (408) 737-7600.



Distributed by Hall-Mark, Pioneer, Graham, Diplomat and Bell. Authorized Maxim Representatives: Alabama, (205) 536-3044; Arizona, (602) 860-2702; California, (408) 727-8753, (619) 279-0420, (714) 739-8891; Colorado, (303) 841-8440; Connecticut, (203) 269-7964; Florida, (305) 365-3283; Georgia, (404) 448-1215; Idaho, (503) 620-1931; Illinois, (312) 956-8240; Indiana, (317) 849-4260; Iowa, (319) 377-8275; Kansas, (316) 838-0884; Maryland, (301) 583-1360; Massachusetts, (617) 444-8071; Michigan, (313) 499-0188; Minnesota, (612) 941-7181; Missouri, (314) 291-4777, (816) 356-6340; Montana, (503) 620-1931; New Hampshire, (603) 772-3300; New Jersey, (609) 933-2600; New Mexico, (505) 884-2256; New York, (516) 543-0510, (716) 385-7744; North Carolina, (919) 847-8800; Ohio, (216) 659-9224, (513) 278-0714, (614) 895-1447; Oklahoma, (918) 832-7747; Oregon, (503) 620-1931; South Carolina, (803) 233-4637/8; Texas, (214) 386-4888, (512) 451-2757, (713) 778-0392; Utah, (801) 266-9939; Washington, (206) 453-8881; Wisconsin, (414) 476-2790. Canada, (416) 238-0366, (604) 464-7620, (613) 762-9562.

United Kingdom, Maxim UK Ltd., 0735-75255, Dialogue Distribution, Ltd., 0276-682001, Thame Components, Ltd., 084-421-4561, STC Electronic Services, 02-792-6777.

Maxim is a registered trademark of Maxim Integrated Products. © 1986 Maxim Integrated Products.

TEK'S NEW COLOR LOGIC ANALYZER: MORE ACCURACY FOR MORE PRODUCTIVITY.

Tektronix

1241 LOGIC ANALYZER

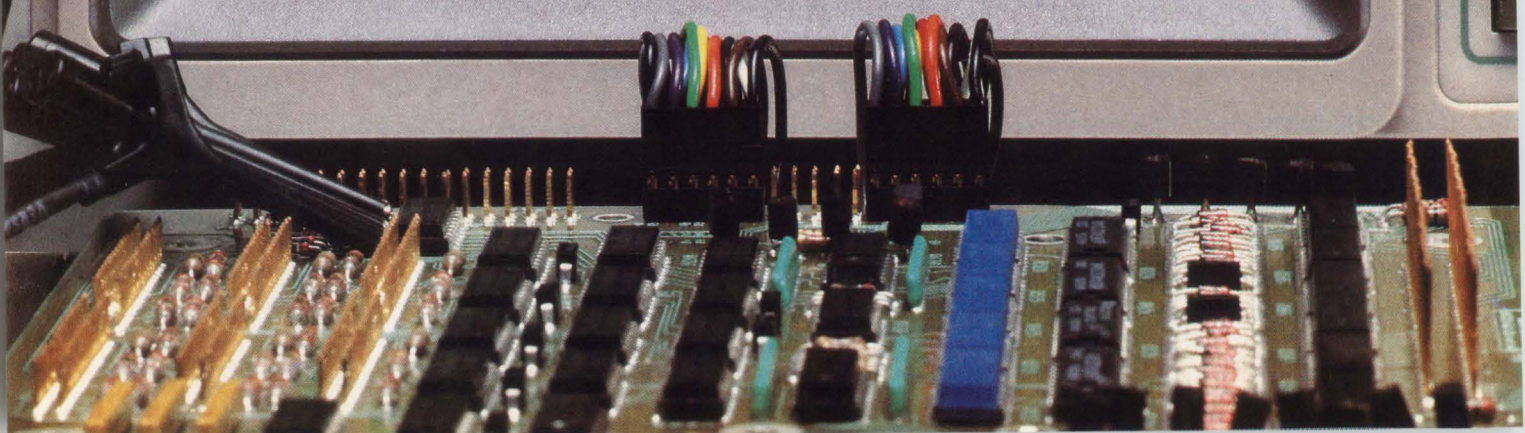
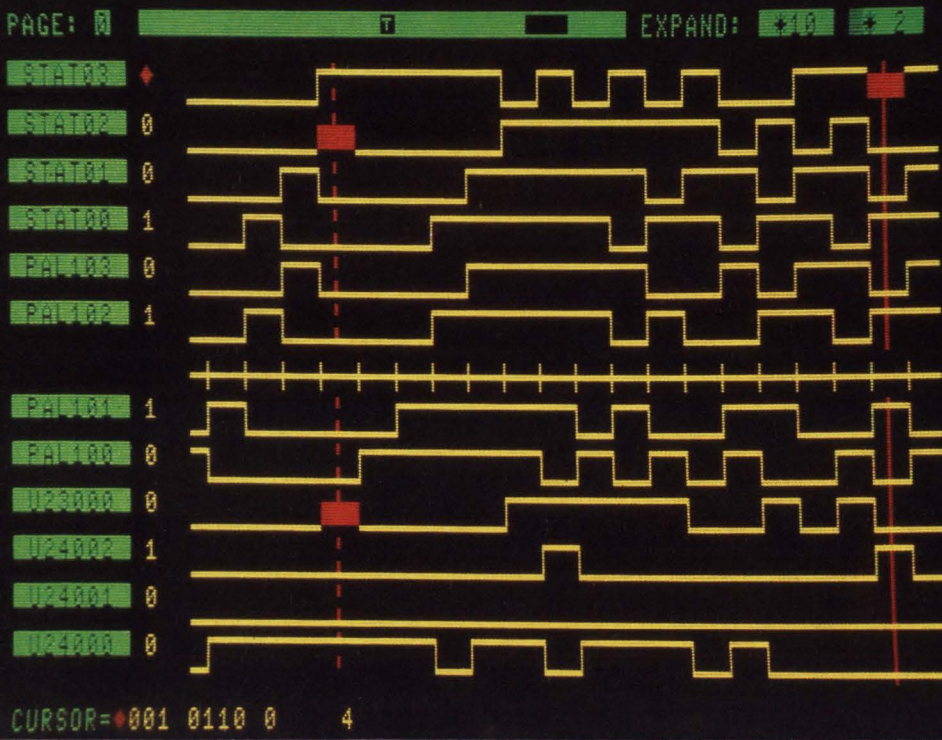

Meet the new 1241—one more reason why Tek's versatile 1200 Series offers you the best of the leading logic analyzers:

1 The 1241's color interface quickly guides your eye to the most relevant information.

Analysis is faster. Easier on the eyes. You are more accurate, more productive. For extra readability, a vertical expansion feature doubles the height of the timing diagrams.

2 Like all members of the 1200 Series, the 1241 clearly

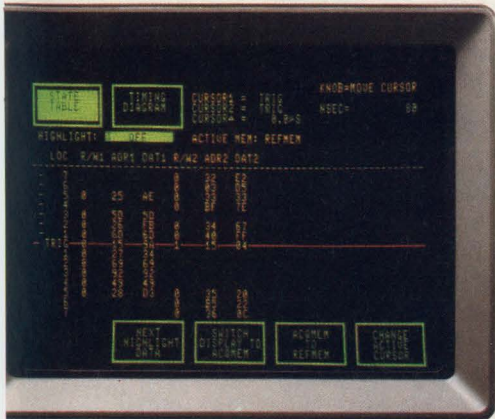

shows what your hardware and software are doing at the same time.

For integrating partitioned designs, only the 1200 Series' Dual Timebase feature accurately depicts real-time interactions between independently clocked modules. This lets you monitor relationships between two processors, or between hardware and software. Combine Dual Timebase with performance analysis on the 1241 to analyze the entire system and software performance. Monitor,

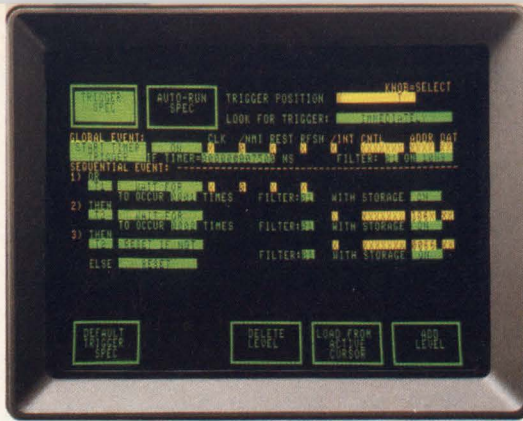

for example, the range of time spent by one processor waiting for a service request response from a second processor. The 1241's histogram display and 10ns resolution make these measurements clear and precise.

3 For both hardware and software analysis, Tek offers unsurpassed triggering.

Software problems are pinpointed by 14 levels of conditional triggering combined with data and program flow qualification. Triggering on the timing characteristics, as well as the state of the hardware activity, is made possible by counters, timers, and duration filters.

4 Ease of use extends beyond the color screen.

Four distinct levels of operation add features as your design challenges require. A unique touch-screen menu display lets you select over 50 high-level commands right off the screen. The big front panel knob provides flicker-free scrolling.

5 Modular, expandable and versatile, Tek's 1200 Series keeps costs low and compromises few. Support

for all major microprocessors includes three types of disassembly. With 14 combinations of 9- or 18-channel acquisition cards, you configure the best data width (up to 72 channels), memory depth

(up to 2K) and sample rate (up to 100 MHz). Add ROM packs for data analysis; RAM packs for storage; COMM packs for RS-232 and GPIB links to computers, plus printer interfacing; and master/slave capability

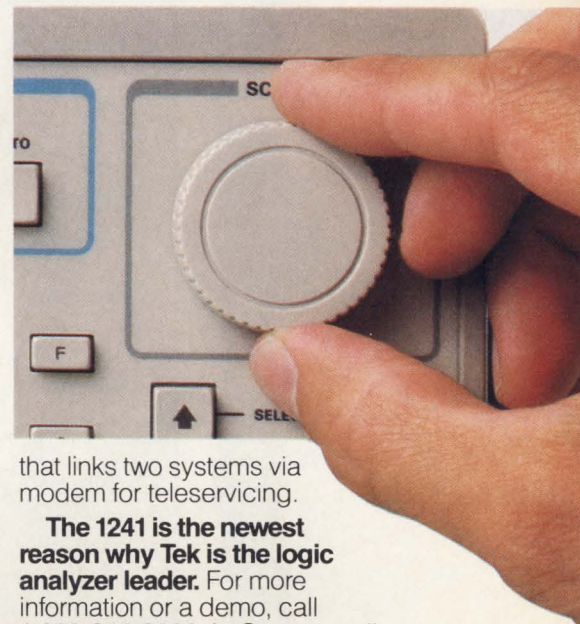

that links two systems via modem for teleservicing.

The 1241 is the newest reason why Tek is the logic analyzer leader.

For more information or a demo, call 1-800-245-2036. In Oregon, call 231-1220. Or contact your local Tek Sales Engineer.



SCSI DAYS



"Pass it on. Ralph still thinks SCSI is only for small computers."

SCSI, the Small Computer Systems Interface, is far more powerful than the name implies.

To prove it, we asked an independent consultant to compare the throughput of our SCSI to SMD controller (with our MULTIBUS® host adapter) to one of the fastest MULTIBUS SMD controllers around. So he ran a series of UNIX™ benchmarks doing random reads and writes.

The outcome? With two drives connected, we beat them. With four drives and more than a gigabyte on line, we hung them out to dry.

How did we do it? Adaptec's multithreading, that's how. It let us execute tasks on each drive at the same time. Of course features like 1:1 Interleave and Disconnect/Reconnect didn't hurt.

What's more, our controllers bring the same kind of performance to ST506, ESDI or even 15MHz ESMD drives. So now, whatever your application, you can get a faster controller with the added flexibility of SCSI, for a lot less money.

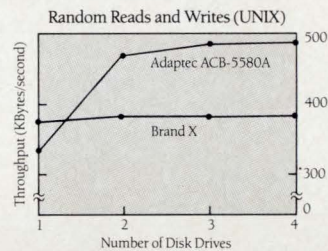

For complete benchmark results and more about our line of high-performance SCSI controllers, call **408-432-8600**, ext. 400. Or write Adaptec, Marketing Dept. (TH), 580 Cottonwood Drive, Milpitas, CA 95035.

And start thinking big.

adaptec

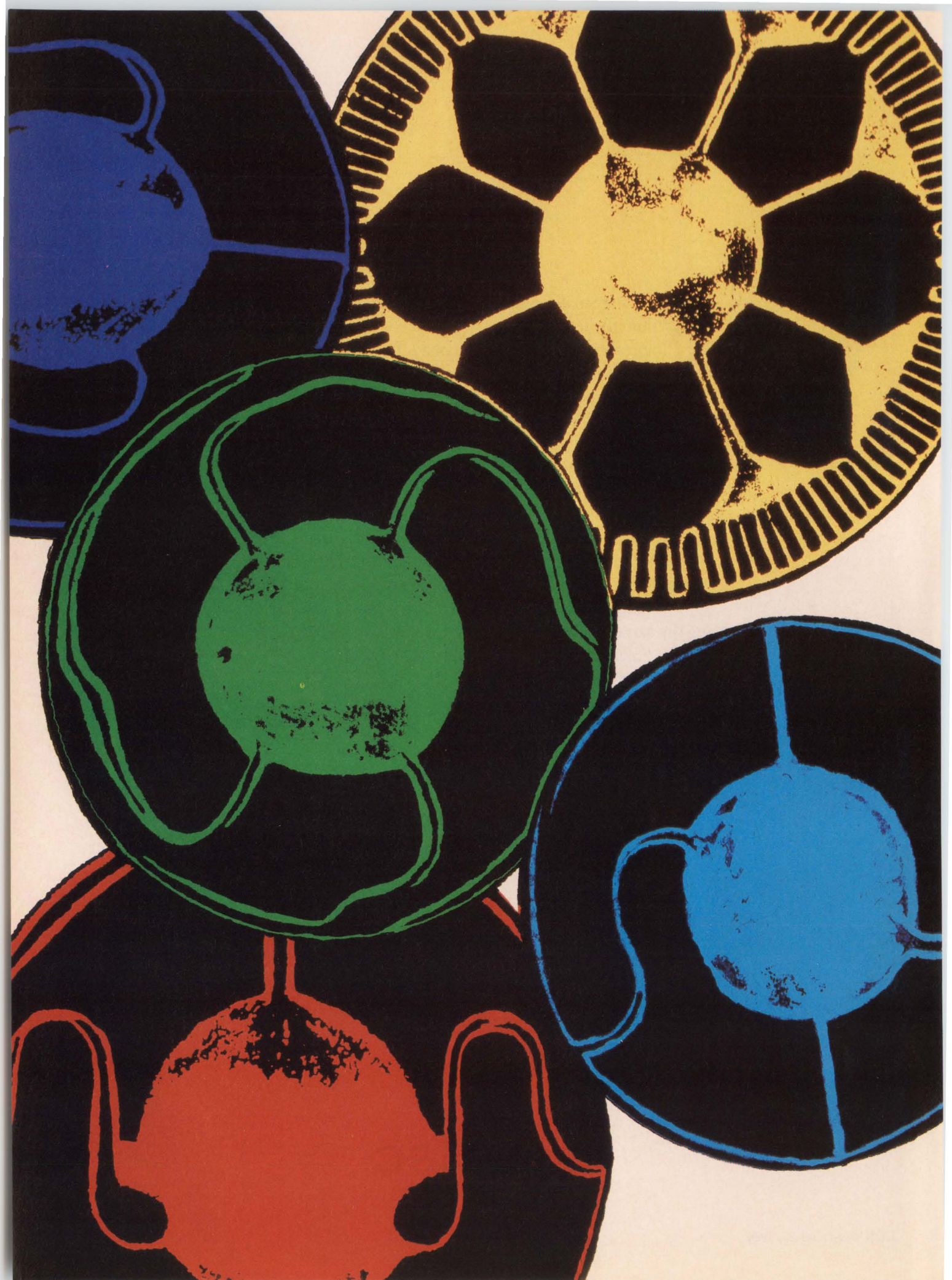

State-of-the-Art Magnetics from Hitachi Metals

Innovative magnets for motors. Magnets of every kind, shape and design. Through intensive R & D activities and a commitment to excellence, Hitachi Metals has become a leader in the production of a wide range of advanced magnetic materials. For computers. For robots. For VTRs, automobiles, and more. In fact, these materials are essential in all types of office, factory, and home automation equipment.

Our magnetic materials exhibit superior performance and reliability, along with compactness. And polarization can be custom designed to suit your exact applications needs. What's more, we've developed high-performance magnets, multi-pole oriented magnets, and magnetic resistivity sensors that are activated by light.

For all your magnetics applications, rely on Hitachi Metals — a comprehensive manufacturer of advanced materials that serve the needs of today's industry.

Rare-Earth Magnet HICOREX			
Characteristics (Typical)	H-18B	H-23CV	H-30CH
Br (G)	8,500	9,700	10,600
bHc (Oe)	8,300	8,500	9,000
(BH) max. (MG·Oe)	17	22	26

Ferrite Magnets			
Characteristics (Typical)	YBM-2BB	YBM-2BE	YBM-2BF
Br (G)	4,200	3,900	3,700
Hc (Oe)	2,800	3,700	3,500
iHc (Oe)	—	4,000	5,000

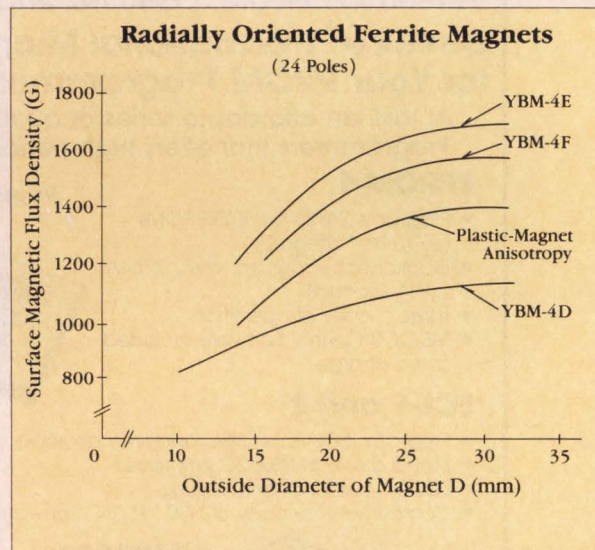

Tomorrow's Materials Begin Today.

 **Hitachi Metals, Ltd.**

Hitachi Magnetics Corporation

Head Office: 7800 Neff Road, Edmore, Michigan 48829, U.S.A. Phone: (517) 427-5151 Telex: WU 226309 HITACHI EDME

Other Offices: Border Region (517) 427-5151, New England Region (603) 882-5204, Empire Region (201) 263-8675, Southeast Region (704) 525-4136, East Central Region (216) 871-8993, Central Region (312) 934-0707, South Central Region (713) 931-0875, Northwest Region (408) 745-7224, Southwest Region (714) 756-8594, Western Region (714) 549-2945

Systems Magnetic Company, Inc.

2837 Coronado Street, Anaheim, California 92806, U.S.A. Phone: (714) 632-8400 Telex: (910) 591-1191

CIRCLE NO 53

HAVE A FIT.

Our new Model 462 subminiature joystick lets you squeeze maximum design into the tightest area. It's only $\frac{3}{8}$ inch in diameter and requires less than $\frac{1}{2}$ inch of back of panel space. So you can mount it almost anywhere—including low-profile keyboards.

Like the larger members of our family of small force-operated controls, the Model 462 performs positioning and tracking tasks with impressive speed and accuracy. It provides high resolution and continuous output, with no dead zone. And it promises outstanding reliability and long life, thanks to its solid state construction with no moving parts to wear out.

The Model 462 is designed as a commercial unit, but it's rugged enough for military use. And it's attractively priced to fit the needs of the OEM user.

For more on getting a good fit, call or write us.



MS Measurement Systems, Inc.

121 Water Street, Norwalk, CT 06854, U.S.A. (203) 838-5561

CIRCLE NO 11

Attention EPROM, EEPROM, and PLD users! Check International Microsystems for Your PROM Programmer Needs.

At last, an affordable series of quality PROM
Programmers that offers high performance.

EPROM-1

Prices start at \$495

- Programs 24/28 pin E/EEPROMs (2716 to 1 megabit)
- Blankcheck, Program, Verify 2764A in 1.1 seconds
- Three modes of operation
- MS-DOS Control Software included at no charge

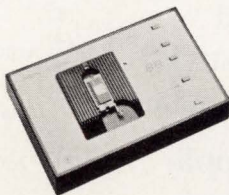

ECL-1 and 2

- Programs ECL PLDs (NSC and MMI devices)
- Stand alone or RS232C interface
- ECL-2 does functional testing
- Complimentary copy of NSC "PLAN" Software included



IM3016A

- 16-socket production E/EEPROM programmer
- Gang or Set programming
- Intelligent and Quick algorithms

We invite you to Check Us Out!

800-237-4734

408-245-7180

Outside CA
790 EAST ARQUES AVENUE SUNNYVALE,
CA 94086

UV Erase Lights
Available

OEM and
Distributor
Inquiries
Welcome



**INTERNATIONAL
MICROSYSTEMS
INCORPORATED**

CIRCLE NO 12

CALENDAR

Introduction to Digital Signal Processing and Filtering (short course), Milwaukee, WI. University of Wisconsin-Milwaukee/Extension, 929 N 6th St, Milwaukee, WI 53203. (414) 224-4193. January 7 to 8.

Invitational Computer Conference, Irvine, CA. B J Johnson & Associates, 3151 Airway Ave, #C-2, Costa Mesa, CA 92626. (714) 957-0171. January 8.

American Society of Test Engineers Annual Conference, Anaheim, CA. ASTE, 114 N Hale St, Suite 2B, Wheaton, IL 60187. (312) 260-1055. January 8 to 9.

Improve Printed Wiring Assembly—Use Statistical Quality Control (short course), Milwaukee, WI. Center for Continuing Engineering Education, University of Wisconsin-Milwaukee, 929 N 6th St, Milwaukee, WI 53203. (414) 224-3952. January 12 to 14.

Annual Battery Conference on Applications and Advances, Long Beach, CA. Roseann Schaff-Matheny, Dept of Electrical Engineering, California State University, 1250 Bellflower Blvd, Long Beach, CA 90840. (213) 498-4605. January 13 to 15.

PC Fab Expo, Orlando, FL. PMS Industries, 1790 Hembree Rd, Alpharetta, GA 30201. (404) 475-1818. January 13 to 15.

Buscon West (Bus/Board Users Show and Conference), Los Angeles, CA. Buscon, 17100 Norwalk Blvd, #116, Cerritos, CA 90701. (213) 402-1610. January 20 to 21.

Syscon (Subsystems Conference and Exposition), Los Angeles, CA. Syscon, 17100 Norwalk Blvd, #116, Cerritos, CA 90701. (213) 402-1610; (714) 552-4617. January 20 to 21.

Usenix Technical Conference, Washington, DC. Usenix Associa-

VICTREX[®] RESINS. WE'VE GONE THROUGH HELL TO PROVE WE'RE THE BEST.

The heat was on. And in test after grueling test for high-temperature performance, Victrex[®] resins beat the leading competition.

Our Victrex PES (polyethersulfone) has a continuous temperature rating of 180C—that's 10C higher than polyetherimide, and 30C higher than polysulfone.

And though you may not see the difference between PES and polyetherimide in a UL breakdown, you will see it in the life of your product. Fact is, at 170C PES has twice the lifetime of polyetherimide.

Maximum continuous use temperature based on UL ratings.

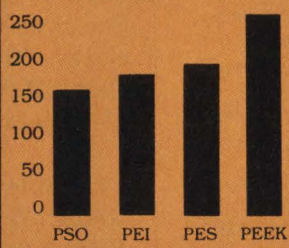

At 180C, PES delivers superior creep strength. A UL 94 V-O flammability rating—one of the best in the industry. And excellent load bearing capabilities.

And for even higher temperature performance up to 250C*,

we've got Victrex PEEK (polyetheretherketone). It's the ideal choice for applications demanding exceptional thermal, chemical and combustion properties.

So if you're starting to cool off to your present thermoplastic, talk to us. Send in the coupon and we'll prove just how hot Victrex resins are.

CIRCLE NO 52

Show me how far you've really gone. Send more information on Victrex resins.

Name _____

Title _____

Company _____

Address _____

City _____

State _____

Zip _____

Mail to: ICI Americas Inc., Corporate Communications Dept., Wilmington, DE 19897

Victrex[®]
PES/PEEK

OIL6

*Expected UL rating.

Victrex is a registered trademark of Imperial Chemical Industries PLC



ICI Advanced Materials

CALENDAR

tion, Box 385, Sunset Beach, CA 90742. (213) 592-3243. January 21 to 23.

Annual Reliability and Maintainability Symposium, Philadelphia, PA. J L Rodriguez, Allied Bendix Aerospace, 15825 Roxford St, Sylmar, CA 91342. (818) 367-0111, x2276. January 27 to 29.

ASEE (Advanced Semiconductor Equipment Exposition and Technical Conference), Santa Clara, CA. Carlidge & Associates, 1101 S Winchester Blvd, M259, San Jose, CA 95128. (408) 554-6644. January 27 to 29.

Computer Graphics New York '87, New York, NY. Exhibition Marketing and Management, 8300 Greensboro Dr, Suite 690, McLean, VA 22102. (703) 893-4545. January 28 to 30.

Invitational Computer Conference, Fort Lauderdale, FL. B J Johnson & Associates, 3151 Airway Ave, #C-2, Costa Mesa, CA 92626. (714) 957-0171. January 29.

Modern Electronic Packaging, Orlando, FL. Technology Seminars, Box 487, Lutherville, MD 21093. (301) 269-4102. February 9 to 11.

Invitational Computer Conference/Computer Graphics Series, San Jose, CA. B J Johnson & Associates, 3151 Airway Ave, #C-2, Costa Mesa, CA 92626. (714) 957-0171. February 10.

Principles of Pulse Doppler Radar: High, Medium, and Low PRF (short course), Atlanta, GA. Georgia Institute of Technology, Department of Continuing Education, Atlanta, GA 30332. (404) 894-2547. February 10 to 12.

Invitational Computer Conference, Raleigh, NC. B J Johnson & Associates, 3151 Airway Ave, #C-2, Costa Mesa, CA 92626. (714) 957-0171. February 19.



CONTROLLED MOTION
...fast and easy

Optical encoders are an available option for every Pittman® motor and gearmotor. Brush-commutated motors with continuous duty torques from 1.2 oz.-in. to 32 oz.-in. High performance ELCOM® brushless servo motors with continuous duty torques from 6.4 oz.-in. to 52 oz.-in. Spur gearheads to 500 oz.-in. — Planetary gearheads to 125 lb.-in.

Mate any of these motor-encoder assemblies to your choice of a modern digital motion controller and get precision shaft positioning with programmable acceleration and slew rates without lengthy and complex servo loop development.

Call (215) 256-6601 today.

PITTMAN
HARLEYSVILLE, PA 19438-0003 USA
A DIVISION OF PENN ENGINEERING & MANUFACTURING CORP
© Pittman, 1986 31-C

CIRCLE NO 13

QUALITY TANTALUM CAPACITORS RELIABILITY

When your design calls for performance, you can rely on tantalum capacitors from Matsuo — where "Quality First" has always been our motto.

Matsuo tantalum capacitors give you high reliability and superior design. Twelve different types of capacitors with over 50 case sizes to meet your application needs. Emphasis is placed on highly reliable radial lead dipped and chip tantalum capacitors. Also available are subminiatures, and molded & dip versions of polyester & polypropylene film types.

What's more, Matsuo offers very competitive prices and fills most orders from stock. Call or write today for samples, prices and literature.

MATSUO ELECTRONICS
2134 Main Street, Suite 200
Huntington Beach, CA 92648
(714) 969-2491 FAX (714) 960-6492
TWX (910) 596-1828

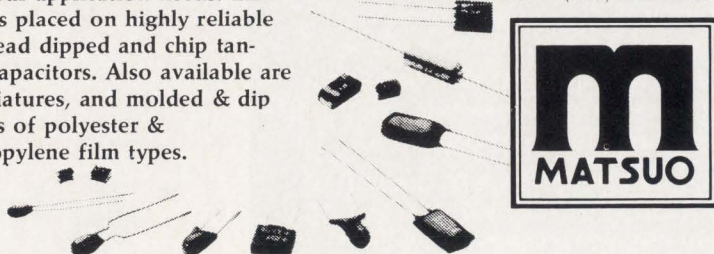

CIRCLE NO 14

Omron switches are slightly unconventional

Omron responds to your application needs by adding innovation to even the most basic switch. Automated assembly and 100% quality assurance are just the beginning of our attention to detail; we take pride in designing the "fine points" that distinguish an Omron switch from the others.

Internal Seals Reduce Soldering and Cleaning Time

Our internally-sealed DIP switches, basic switches and mechanical keyswitches are immersible for cleaning without a time-consuming taping operation. Sealed construction also prevents flux entry during automatic flow soldering. Designed for efficiency, our top-actuated DIP switches are also auto-insertable for quick assembly.

Advanced Computer Design Maximizes Performance

Omron's extensive line of pushbutton and lighted pushbutton switches are designed with the operator in mind. Using advanced computer techniques, we've designed a unique "triangle structure" actuator which provides constant force and ideal operating feel for maximum performance. Omron lighted pushbutton switches also feature uniform color illumination to add a quality appearance to your control panels.

Custom Options Accommodate Unique Applications

Omron's snap-action, miniature and subminiature basic switches are available in a wide variety of actuator types and contact configurations to meet your specifications.

Switching capacities range from 0.1 to 21 amps, and sealed versions are available for direct soldering to PC boards. In addition, our new A3B lighted pushbutton switches provide water and oil resistance ideal for your machine tool and other harsh industrial applications.

Unconventional Switches for Exceptional Performance

Remember Omron when your switch application requires more than just standard performance. We'll work with you to develop solutions to your specific application problems, if we haven't developed one already. When it comes to photomicrosensors (optical), thumbwheel, basic snap action, keyswitches, DIP, or pushbutton switches, we don't mind being a little unconventional.

1-800-62-OMRON

OMRON[®]
Responsive Innovation

OMRON ELECTRONICS, INC.
One East Commerce Drive
Schaumburg, Illinois 60173

Circle Reader Service Number **30** for more information on Keyswitches, Pushbutton, Thumbwheel or DIP Switches.

Circle Reader Service Number **69** for more information on Basic Switches.

EDN REPRINTS

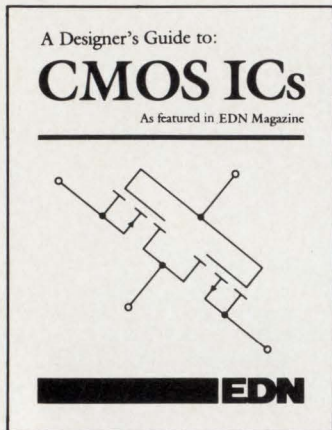

A Designer's Guide to CMOS ICs

CMOS is fast becoming the chosen technology for developing integrated circuits. That's because CMOS ICs are able to implement ultra-complex system-level functions on a chip! Now you can meet the special challenges posed by this new breed of ICs with *A Designer's Guide to CMOS ICs*. You'll learn the advanced design and fabrication techniques required. Plus the latest linear and digital CMOS ICs available.

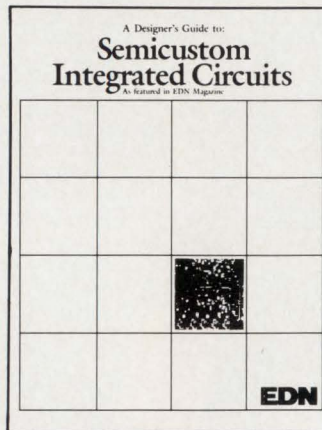

A Designer's Guide to Semicustom Integrated Circuits

Learn how to design a semicustom IC with *A Designer's Guide to Semicustom Integrated Circuits*. Based on EDN's own design experience, this nine-chapter booklet outlines the complete procedure used to design, fabricate, and test EDN 1, a chip with a 1200 equivalent-gate complexity. You'll not only learn the steps to take when creating ICs, but also the design/cost analyses and vendor-interface methods that lead to successful semicustom chips.

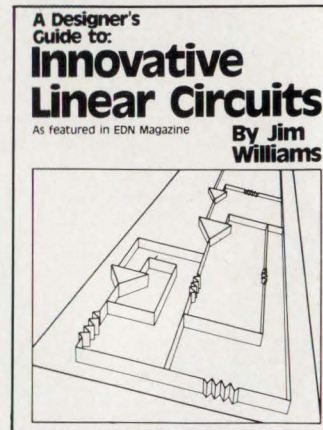

A Designer's Guide to Innovative Linear Circuits

As exciting as digital technology is, you still need analog circuitry to operate on signals from real-world sources. Now, EDN is offering a wealth of analog design information in *A Designer's Guide to Innovative Linear Circuits*. This 186-page collection of articles was developed by Jim Williams, one of America's foremost linear-circuit designers. It includes practical and efficient ways to use op amps, comparators, data converters, and other analog ICs, and discusses the theories behind all the design techniques presented.

Mail coupon to:

Please print clearly. This is your mailing label.

EDN Reprints
EDN Magazine
Cahners Building
275 Washington Street
Newton, MA 02158-1630

NAME _____

Please send the following **Designer's Guide(s)**:

TITLE _____

_____ copies of *A Designer's Guide to CMOS ICs*
 \$ 6.95 UPS \$10.95 non USA
(BANK DRAFT ONLY)

COMPANY _____

_____ copies of *A Designer's Guide to Semicustom Integrated Circuits*
 \$ 6.95 UPS \$10.95 non USA
(BANK DRAFT ONLY)

ADDRESS _____

_____ copies of *A Designer's Guide to Innovative Linear Circuits*
 \$14.95 UPS \$19.95 non USA
(BANK DRAFT ONLY)

CITY _____ STATE _____ ZIP _____

Check or money order made out to **EDN REPRINTS** must accompany each order. No COD. Mass. residents add 5% sales tax.

EDN122586

EDITORIAL

Communication is the key to overseas success

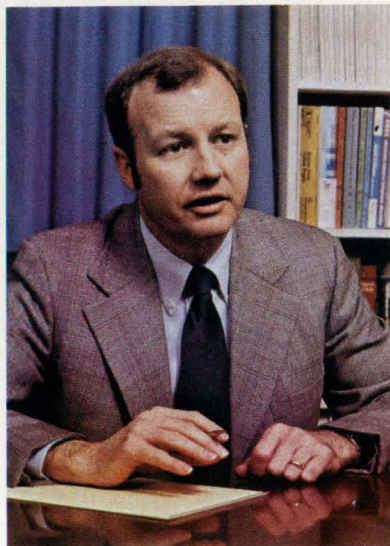

Although many small- and medium-sized Asian companies want to sell their products in the US, lack of competence in speaking and writing the English language is a formidable barrier. Also, many foreign companies do not understand how to work with US electronics publications to get new-product information to engineers.

After presenting one of my business cards in the small press booth at the Japan Electronics Show in Tokyo, I got back a hand-lettered (in English) press badge. "Sorry," said the booth's Japanese receptionist, "but there's no room for the word 'press' in Japanese." Thus my press badge, clearly lettered in English, made no impression on the exhibitors, few of whom spoke or read English. Getting information about products was frustrating: Companies provided neither catalogs nor press releases in English. Exhibit signs were written in Japanese, so it was impossible to tell the new products from the old, or the future products from the ones already in production. Even when exhibitors spoke English I was told either to call the factory for more information or that the person with the technical information I wanted wasn't at the booth. Press relations could even be hostile. When one exhibitor discovered I represented a publication, he said his company's product wasn't for me and yanked the data sheet out of my hands.

As in Japan, the press got no special treatment at the Taiwan Electronics Show in Taipei. A receptionist simply gave me a "Buyer" badge. In Taiwan, if you're not an exhibitor, you're a buyer. Most of the exhibitors did offer English-language data sheets, and price and delivery information was at hand. In addition, someone at almost every booth spoke English, so language wasn't as great a barrier as it was in Japan. Still, none of the companies supplied press releases or photographs. They couldn't understand why someone wanted information unless he was going to actually buy and import a product. Thus, the lack of understanding of how the trade press operates in the US hampered the ability of companies to promote their products to US engineers.

It's easy to be chauvinistic and demand that foreign companies communicate with us in English and give us exactly the information we need. Let's keep in mind, however, that successful communication is usually a two-way process. Change the names and the languages and the above situations could apply to a foreigner visiting the US. We must be sure the foreign companies know what information we need and we must help them provide it. We must also be willing to communicate in foreign languages.

Many electronics-industry leaders demand that the Japanese open their markets to US products. But few US companies provide native-language information to foreign visitors who attend Wescon, Electro, and other US trade shows. Likewise, exhibit signs, show booklets, and other information is in English. Although many foreigners speak English, it's naive to expect it to be their first choice for technical communications. I'll bet that few US public-relations companies understand how foreign trade publications work, and thus they find it difficult to promote US products overseas. By understanding each others' information and language needs, we'll find it easier to build profitable bilateral trade relations with foreign companies.

Jon Titus
Editor

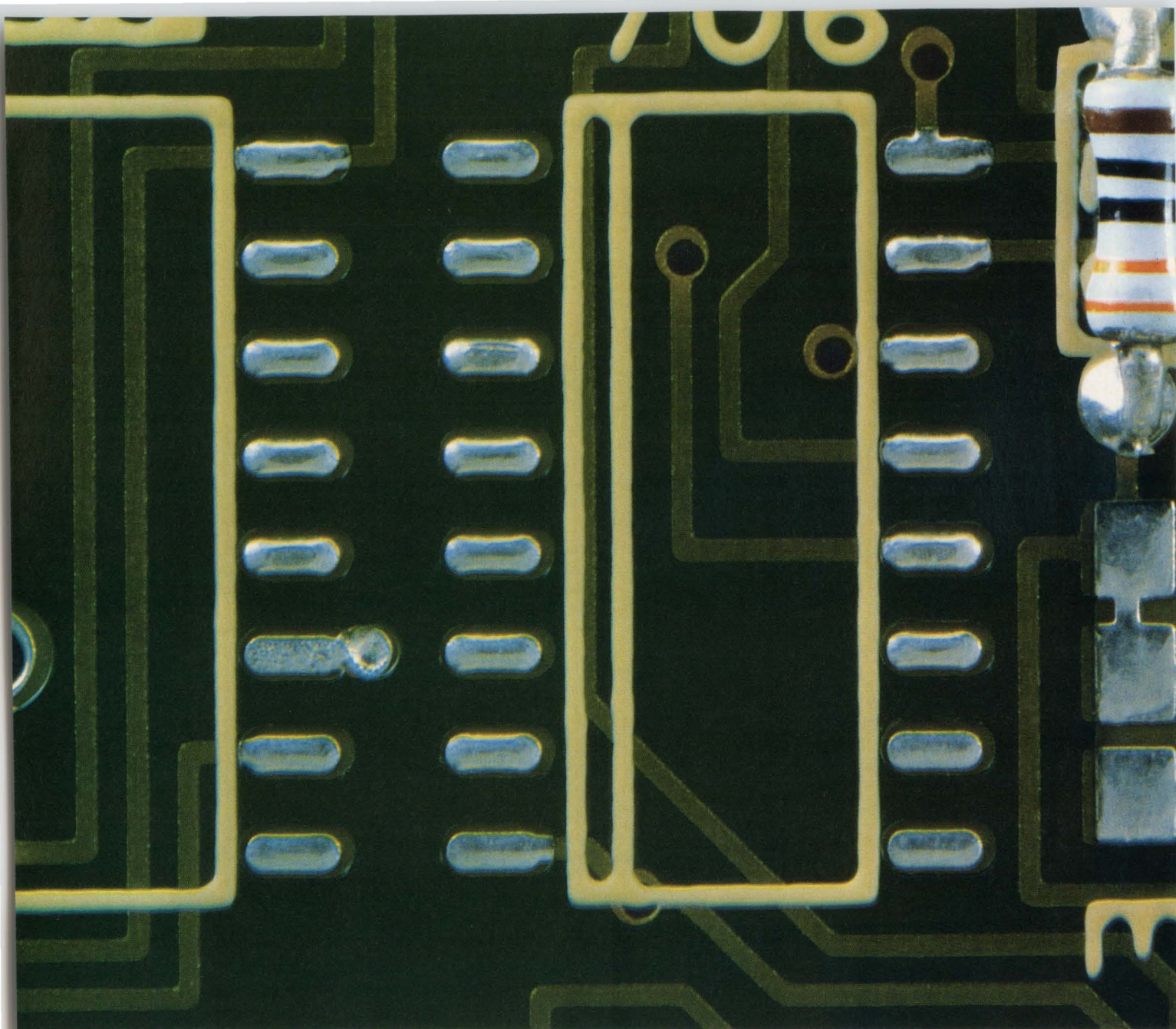

VACREL[®] lets you design more electrical

The performance of VACREL gives you the added design freedom you need when using surface-mount technology (SMT), the state of the art in printed wiring board and printed wiring assembly design.

Du Pont VACREL photopolymer film solder masks totally encapsulate fine-line circuits with a tough, uniform, high-resolution photopolymer film that provides excellent dielectric, mechanical, and electrical protection.

Because VACREL is uniformly thick, it consistently covers without skips, pinholes, or voids in a single pass—unlike screened or photoimageable liquid systems.

Tighter designs, better use of real estate.

Tighter designs are possible due to accurate image registration and reproduction with masks of VACREL, even on large panels having two or more



VACREL photopolymer film solder mask (left). Total encapsulation means less damage in assembly, greater reliability in use, and reduced potential for field failures. Screen-printed solder mask (right) may leave voids, pinholes, and incomplete encapsulation.

circuit lines between pads and as little as 0.13-mm (5-mil) spacing between conductors. VACREL helps lower per-function cost by allowing more functions

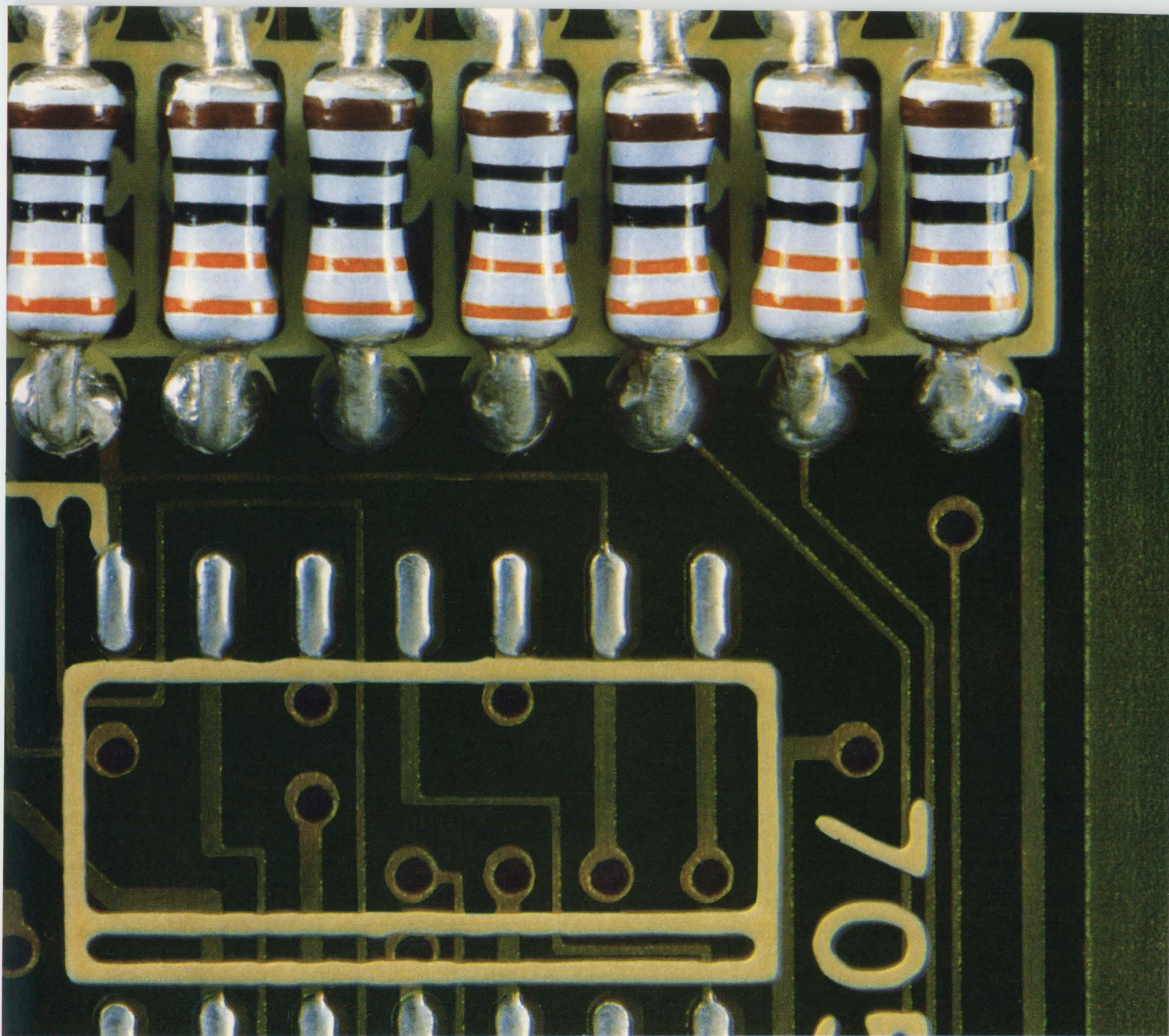

Photograph is 13.47 times original size.

functions into less real estate at less cost.

per board, with high first-pass assembly yields, less solder bridging, fewer retests and rejects, and less potential for field failures. Lower incoming inspection costs are possible, thanks to the accuracy of VACREL.

Accurate component location aids SMT design.

For surface mounting, VACREL goes beyond tighter designs and maximized real-estate utilization. It tents via holes to prevent solder wicking, bridging, and shorting. Components may be placed directly over tented via holes, with virtually no chance of contamination from the other side.

Because VACREL is photoimaged, a precisely shaped "well" for solder paste can be created, even

with closely spaced pads, to ensure proper placement and alignment of components. VACREL is compatible with wave, vapor-phase, and infrared soldering systems.

Send for VACREL design and productivity package.

Send today for more information on designing printed wiring boards with VACREL. Write to Du Pont Company, Room G51085, Wilmington, DE 19801. Or call 800-527-2601, Extension 311

VACREL photopolymer film solder mask is made only by Du Pont.



250-MHz, triple 8-bit video DAC supports 2048×1536-pixel screen resolution

The Bt109 triple video D/A converter is an ECL device that suits application in high-resolution (1024×1024- to 2048×1536-pixel) color graphics systems. It includes three 8-bit DACs that operate at video rates as high as 250 MHz. In addition to the three DACs, the IC includes a latch for each 8-bit input (red, green, and blue) and a latch for sync, blank, and overlay signals. The chip generates RS-343A-compatible red, green, and blue video signals, and it drives doubly terminated 75Ω coaxial cable directly. Housed in a 40-pin DIP, the triple DAC typically dissipates 1750 mW. It specs ±½-LSB differential linearity and a 1-nsec max rise/fall time.

The Bt109 can simplify the design of high-resolution video systems. To drive an RGB monitor, you need to combine only the video DAC, screen memory, glue logic, and the μP. However, because the DAC is an ECL device that operates at a high video rate, you must employ ECL devices for screen memory, and you must provide an ECL/TTL interface to the controlling μP.

The manufacturer recently introduced two other ICs that further simplify video-system design. The Bt401 pipelined static RAMs each provide 256 bytes of screen memory. The Bt501 interface chips provide an octal transceiver and ECL/TTL translator function.

By employing one of the 256-byte static RAMs for each of the three DACs on the Bt109, you can design a video system that supports 256 colors. The static RAMs can be cascaded; a design with 16 of the static RAMs per DAC can support 4096 colors. The Bt401/402 chips each include an I/O pipeline consisting of address and data latches that allow

the ICs to achieve a 4-nsec access time in synchronous operation.

Each Bt401/402 device also includes three 8-bit overlay registers. The overlay registers allow designers to add three colors or to provide features such as cursor functions and highlighting. Bt403/404 devices don't include the pipeline or overlay registers. Fig 1 depicts the video DAC, static RAMs, and octal transceivers/ translators in a typical configuration. The static-RAM and transceiver ICs also suit other applications. For example, you can use the static RAM for cache and micro-code storage.

The Bt109, Bt401 family, and Bt501 family can all operate from one 5V supply or from split ECL supplies. All of the chips are now

available. The Bt109 costs \$39 (1000), the Bt401 sells for \$29 (1000), and the Bt501 is \$13.50 (1000).—**Maury Wright**

Brooktree Corp, 9950 Barnes Canyon Rd, San Diego, CA 92121. Phone (619) 452-7580. TLX 383596.

Circle No 738

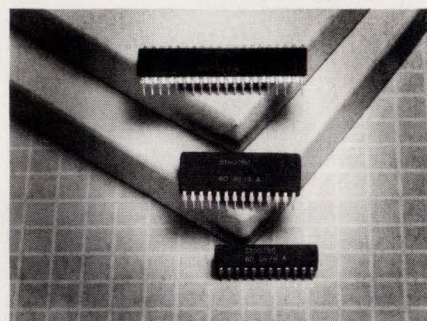

Supporting 250-MHz operation, the Bt109 video D/A converter drives RGB monitors directly.

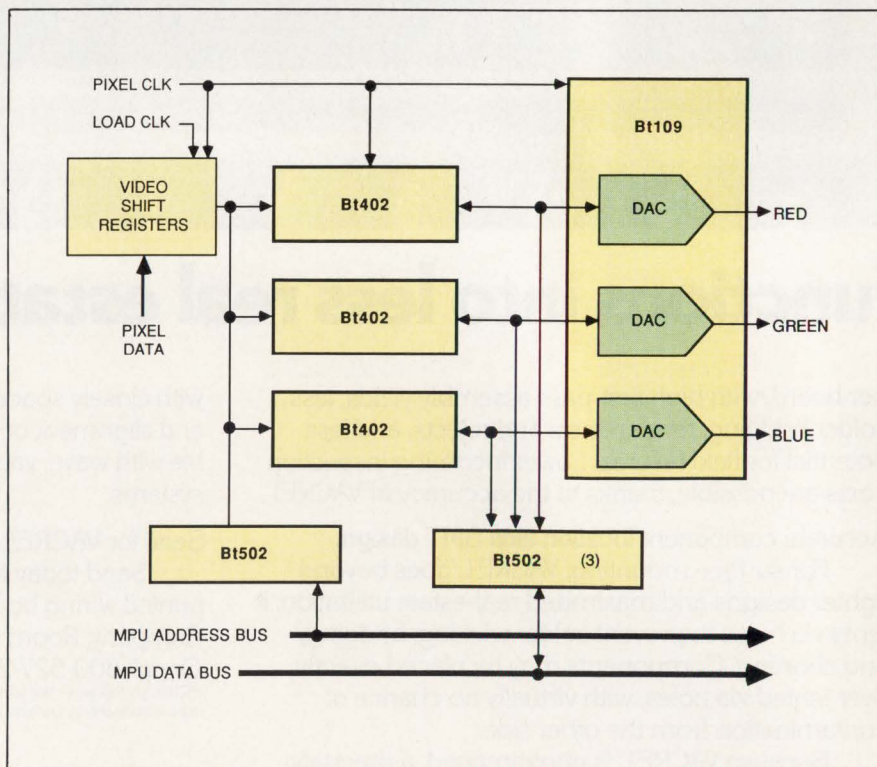
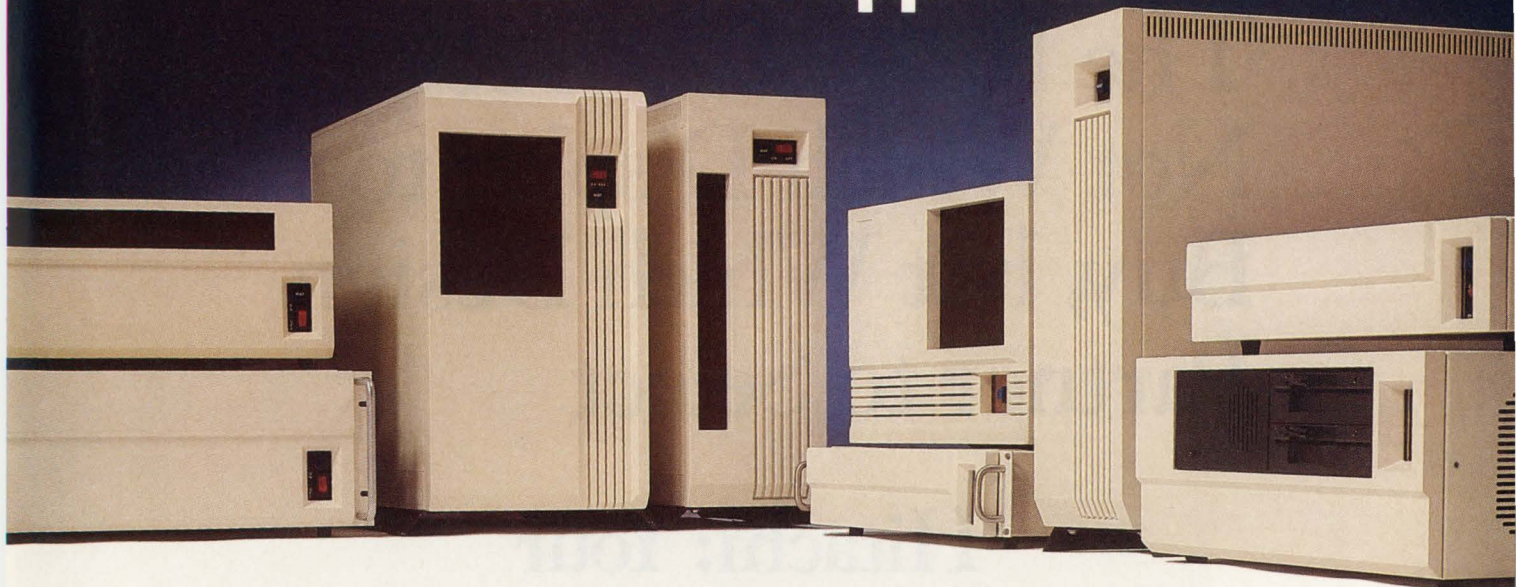

Fig 1—A triple 8-bit video DAC, 256-byte ECL static RAMs, and octal transceivers combine to simplify the design of video systems.

VME, Multibus and Multibus II: Package Your System to Win World-Wide Approval



If you sell systems anywhere, you face an increasing number of safety and performance standards. Tough design specs that cost plenty to meet and cost plenty to prove you meet them.

So package your system in an Electronic Solutions enclosure. One that has already met these standards:



Canadian Standards Association



International Electrotechnical Commission

—plus FCC Part 15 Class A EMI/RFI compliance that most VME or Multibus II card racks miss by a wide margin.

All you need to add are the cards.

Choose from a huge selection of attractive tabletop, rack-mount and floor-standing DeskMate enclosures with 3,4,5,7,10,11,12,13 or 15 card slots. In sizes from only 3½" high. Choose from many options: front, rear, or top card loading; mounting of up to eight half-height 5¼" peripherals; P1 and P2 backplane configurations; and power supply capacity up to 500 Watts.

So to help build your reputation take a little of ours. Our reputation for strength, ruggedness, reliability—and, of course, appearance.

To find an enclosure that meets your approval, call us today for complete catalogs on VME, Multibus and Multibus II System Packaging.

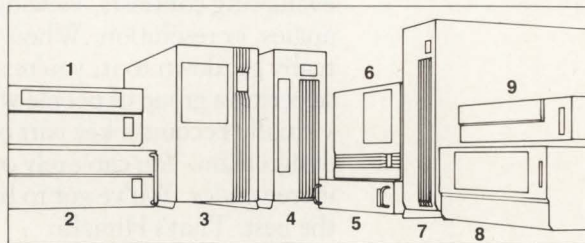

1. Series 7 with 2 half-height peripherals
5 slots VME, Multibus II; 7 slots Multibus I
2. Series 7 (shown with rack mounting)
7 slots VME, Multibus II; 10 slots Multibus I
3. Series 10 DeskMate with 4 full-/8 half-height peripherals
12 slots VME; 10 slots Multibus II; 15 slots Multibus I
4. Series 7 DeskMate
5 slots VME, Multibus II; 7 slots Multibus I
5. Series 3 (shown with rack mounting)
3 slots VME, Multibus II; 4 slots Multibus I
6. Series 10 with 4 full-/8 half-height peripherals
12 slots VME; 10 slots Multibus II; 15 slots Multibus I
7. Series 7 DeskMate
7 slots VME, Multibus II; 10 slots Multibus I
8. Series 7 with 2 full-/4 half-height peripherals
7 slots, VME, Multibus II; 10 slots Multibus I
9. Series 3
3 slots VME, Multibus II; 4 slots Multibus I



Electronic Solutions
UNIT OF ZERO CORPORATION

9255 Chesapeake Drive, San Diego, CA 92123 • (619) 292-0242 Telex II (TWX): 910-335-1169
Call Toll Free: (800) 854-7086 In Calif: (800) 772-7086

The Real LCD Decision: Not Which Display to Buy, but Which Design Partner to Select

Hitachi: Your LCD Design Partner

Choosing an LCD is more than just evaluating contrasts, viewing angles, or resolution. When you really get down to it, you're also selecting a group of people who will virtually become a key part of your design team. You can't rely on a mere vendor. You've got to have the best. That's Hitachi.

Whether you need thorough engineering support, leading-edge technology, or high production volume, Hitachi should be your source for LCDs. From our smallest 8-character-by-1 line display, to the 640-by-400 pixel LM252X, every product gives you Hitachi's

famous quality and reliability. And now, many of our displays are available with backlight capability.

Hitachi's sheer experience base and substantial resources make us your most powerful ally in today's marketplace/battlefield. There isn't a design situation you could dream up that Hitachi hasn't already worked on.

Just consider how important the display is to your product. Then call Hitachi.



HITACHI

Hitachi America, Ltd.
Electron Tube Division
300 Martingale Road, Suite 600
Schaumburg, IL 60173
Telephone 1-312/843-1144

READERS' CHOICE

Of all the new products covered in EDN's **October 16, 1986**, issue, the ones reprinted here generated the most reader requests for additional information. In case you missed them the first time, find out what makes them special: Just circle the appropriate numbers on the Information Retrieval Service card, or refer to the indicated pages in our **October 16, 1986**, issue.

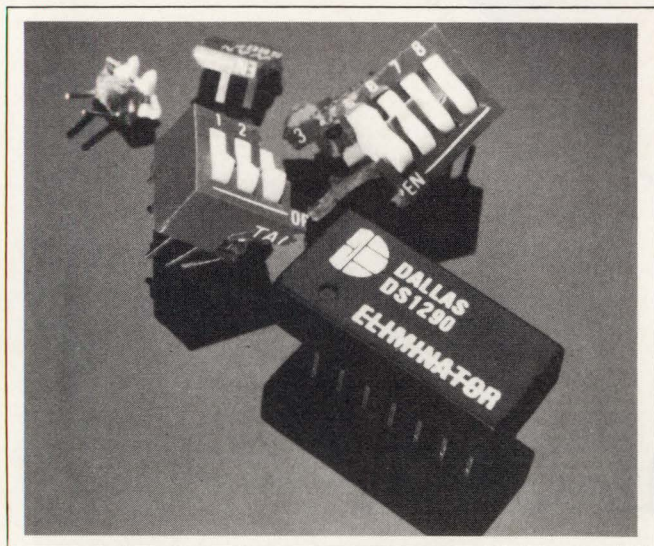

▲ CMOS IC

The Eliminator (DS1290), a 14-pin, battery-backed CMOS IC, lets you use software control to define computer parameters that are ordinarily selected by hand with onboard DIP switches (pg 143).

Dallas Semiconductor Corp.

Circle No 504



▲ TERMINAL

The FT-50 flat-panel terminal features an 8.5x11x2.5-in. electroluminescent or gas-plasma display and a 1.5x14x5-in. keyboard (pg 135).

Emerald Computers Inc.

Circle No 503

AMPLIFIER ►

The CLC940 high-speed, hybrid track/hold amplifier specs a 12-nsec track-to-hold settling time and a 1-psec aperture jitter, making it easy to drive flash A/D converters (pg 140).

Comlinear Corp.

Circle No 505

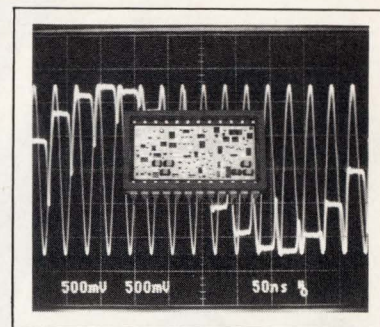

IBM PC LINK

The PC1796 Link connects the IBM PC to Multibus computers and I/O boards via two circuit boards connected by a ribbon cable (pg 259).

Ultralink.

Circle No 502

DEBUGGER

The dBUG/EGA assembly-code assembler sets breakpoints, selects colors, and allows you to create custom fonts for use with Enhanced Graphics Adapter (EGA) programs (pg 136).

Cybernetic Micro Systems.

Circle No 506

◀ SMD DESIGN

Surface Mount Design Analysis Software determines surface-mount board density and size and whether it should be single- or double-sided (pg 243).

Surface Mount Technology Plus.

Circle No 501



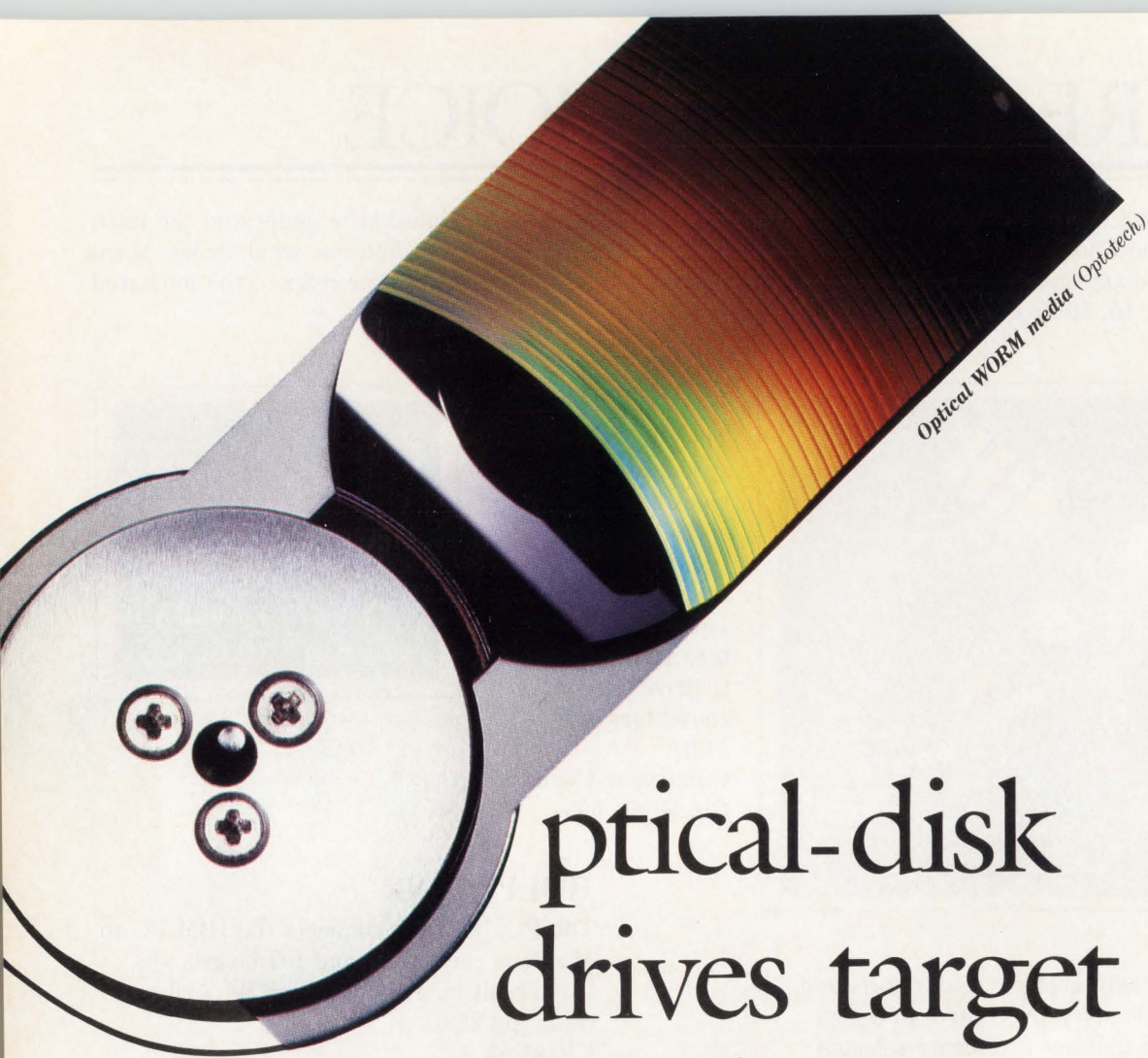

Optical-disk drives target standard 5¼-in. sites

Add optical-disk drives to your list of data-storage peripherals that are available with a 5¼-in. footprint. These drives, which offer several hundred megabytes of removable storage, now come in optical-ROM (OROM) and write-once, read-many (WORM) versions. A third type of drive, the erasable optical drive, is still a year or more away from full-scale production in the 5¼-in. configuration.

If you choose an optical drive for your system, be aware that 5¼-in. removable optical-drive products don't yet conform to standards; incompatibility is the rule for either the disk format, the drive interface, or both. No alternate sources exist for any of

Optical-disk drives are now available in the 5¼-in. format. You can currently choose from two types: optical-ROM (OROM) and write-once, read-many (WORM) drives. A third type of optical drive, the erasable optical drive, is still under development and won't be ready for at least a year.

the optical-disk drives now available. Nevertheless, standards under consideration could make some 5¼-in. optical-drive products as interchangeable as floppy- and hard-disk drives.

Each of the three major technologies for optical-drive products—the OROM, WORM, and erasable-disk technologies—suit a particular purpose. OROM and WORM disks, because they're indelible once data is placed on them, are useful for information distribution. OROM disks, which are mass produced from a master disk, allow for inexpensive large-volume distribution of information, such as encyclopedias, public-domain software, and other read-only

Steven H Leibson, *Regional Editor*

Computers and Peripherals

applications. WORM disks, which can be written to individually, are suitable for small-volume information distribution or for applications that require updating of data. The future erasable optical disks will be able to replace hard magnetic disks.

5¼-in. CD-ROMs

Manufacturers of 12-in. optical disks originally created several formats for OROM disks, but the CD-ROM format, which is based on the audio compact disks (CDs) developed by Philips and Sony, quickly became the technology of choice among manufacturers of 5¼-in. OROM disk drives. The 120-mm size of the audio CD fit well into the 5¼-in. drive's form factor. Moreover, disk-pressing plants and equipment already existed for audio CDs, and they were already churning out millions of audio CDs yearly.

The CD-ROM format stores roughly 540M bytes of data on the 120-mm, 1-sided disk. You can obtain 5¼-in. CD-ROM drives from several manufacturers; **Table 1** gives a sample of these drives. Except for the one-time disk-mastering charge of a few thousand dollars (Hitachi, for example, charges \$2000 for mastering a CD-ROM), CD-ROM disks are inexpensive; they cost about \$5 to \$25 each in hundreds. Generally, you would choose OROMs for distributing more than one hundred copies.

Although the CD-ROM format is standardized, the interface to CD-ROM drives is not. Each manufacturer of CD-ROM drives uses a proprietary drive interface. Consequently, each manufacturer supplies a proprietary drive-controller card. Almost universally, these CD-ROM drive vendors base their controller boards on the IBM PC bus. Two companies, however, offer drives based on the SCSI bus. If you want to use a CD-ROM drive with systems that aren't compatible with the IBM PC bus or the SCSI bus, you'll have to design your own controller.

The SCSI-based optical drives are the CM210 and stand-alone CM110 from Laser Magnetic Storage International (LMS), and the stand-alone CDU-400 drive from Sony. (LMS is a joint venture of Philips and Control Data, which absorbed disk and drive maker Optical Storage International.) The drives' SCSI ports allow you to interface the drives to a variety of μ P systems. In the next year, you can expect several manufacturers to introduce other CD-ROM drives with

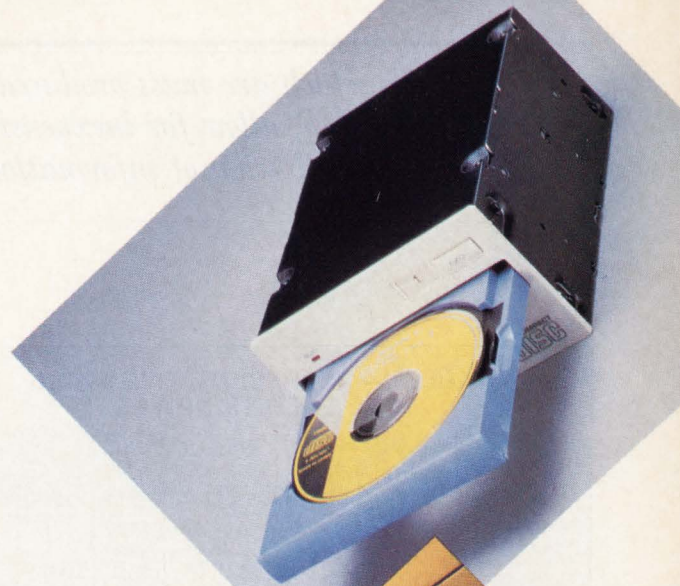

Full-height CD-ROM drive (Sony)



*Half-height CD-ROM drive
with disk in protective cartridge
(Laser Magnetic Storage International)*

SCSI interfaces. (See EDN, September 18, pg 97 and EDN, October 16, pg 81.)

Standard specifies data-storage method

The de facto standard for CD-ROMs, the "Yellow Book," specifies two physical block (or sector) formats for storing digital data on the disk (**Fig 1a**). The standard doesn't, however, address the contents of the data field (audio, video, graphics, or database files) or the way in which the data is to be encoded (ASCII, text compression, graphic data representation, or video or audio representation). Neither does the Yellow Book specify logical-file structure or directory format.

OROM disks, which are mass produced from a master disk, allow for inexpensive large-volume distribution of information.

TABLE 1—REPRESENTATIVE 5¼-IN. CD-ROM DISK DRIVES

MANUFACTURER	MODEL	ACCESS TIME (SEC)		PRICE	COMMENTS
		MAX	AVG		
HITACHI SALES	CDR-2500	1.0	0.5	\$592 (25)	
	CDR-2500S	1.0	0.5	\$641 (25)	STAND-ALONE VERSION OF CDR-2500
LMS	CM110	2.0	1.0	\$690 (1000)	STAND-ALONE VERSION, SCSI INTERFACE
	CM201	1.0	0.5	\$400 (1000)	USES LMS OYSTER CARTRIDGE
	CM210	1.0	0.5	\$420-\$500 (1000)	CM201 WITH SCSI INTERFACE
PANASONIC	SQ-D1	0.65	*	\$1495	PRICE INCLUDES PC-BUS CONTROLLER, CABLE
	SQ-D101	0.65	*	\$1795	STAND-ALONE VERSION OF SQ-D1
SONY	CDU-5002	1.1	0.7	\$590	
	CDU-100	1.1	0.7	\$690	STAND-ALONE VERSION OF CDU-5002
	CDU-400	1.1	0.7	\$890	SCSI VERSION OF CDU-100 (AVAILABLE IN MARCH 1987)

*NOT SPECIFIED

Because of the lack of standards for the logical-file structure and directory format, early CD-ROM software developers were forced to create their own formats. As a result, most currently available CD-ROM titles from different manufacturers are incompatible.

One solution to this incompatibility problem might be the logical-file-format standard proposed by the High Sierra Group, an ad hoc advisory committee comprising a dozen manufacturers of CD-ROM products. Combined with the Yellow Book standard, High Sierra Group's proposal would make CD-ROM files independent of the host computer's file structures. The format would allow applications software developers to create only one set of CD-ROM disks for each application, and not one for each application running on each computer system. The National Information Standards Organization (NISO) and the European Computer Manufacturers Association (ECMA) are currently considering High Sierra's proposal.

Big files for MS-DOS

One software company is already putting High Sierra's proposed standard to use: Microsoft (Redmond, WA) recently introduced software extensions to MS-DOS that allow that operating system to access CD-ROM drives and CD-ROM disks that use the High Sierra format. The extensions, which Microsoft licenses to drive vendors on a per-drive basis, overcome the 32M-byte size limitation that MS-DOS imposes on any drive. The Microsoft code is device-independent, so you can use it with any CD-ROM drive and any manufacturer's interface. You must implement the device-depen-

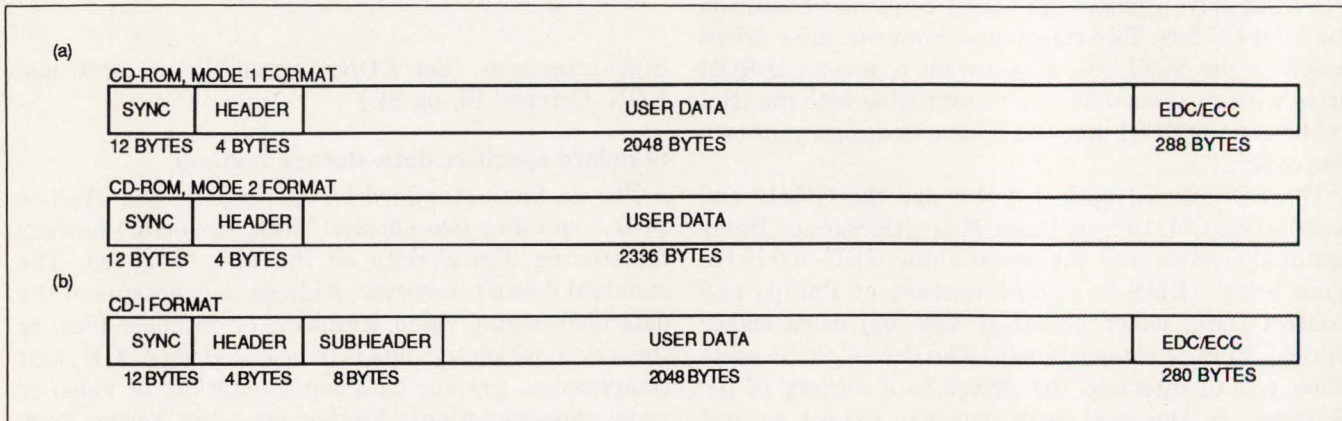

Fig 1—The Yellow Book standard for CD-ROMs (a) defines two block formats: Modes 1 and 2. The CD-I format (b) uses Mode 2 and places three fields into the 2336 user-data bytes available in that mode: an 8-byte subheader field defining the type of data stored in the block (video, graphics, text, executable code, or sound), a 2048-byte data field, and a 280-byte error-detection-code and error-correction-code (EDC/ECC) field.

dent driver software yourself.

A different solution to the logical-file-incompatibility problem of CD-ROMs was introduced last February by Philips and Sony. This new format, CD-I (CD-Interactive), is a subset of the CD-ROM format but targets a specific application: interactive consumer products having video, sound, and text capabilities.

The CD-I physical-block format (**Fig 1b**) uses the CD-ROM Mode 2 data-block format. The CD-I format differs slightly from the CD-ROM Mode 1 format in that it reduces the error-correction block by eight bytes and adds these bytes to a subheader field, which follows the block's header field and precedes the data field. The subheader field in the CD-I format specifies the type of information contained within the block's data field. The CD-I format supports text, video, audio, executable code, and graphics in the data field. It also defines a logical file format for all data files on the disk.

The Sony/Philips CD-I proposal specifies a host based on a Motorola 68000-family μ P and Microware Systems Corp's (Des Moines, IA) OS-9 operating system, along with custom decoder chips for the graphics, video, and sound files. The CD-I format is strictly a file format, however.

Computer systems based on other μ Ps also can make use of CD-I disks, either by emulating the hardware needed to reproduce the sounds and display the video, text, and graphics or by adding the required decoder chips. Because the CD-I data-block format conforms to the CD-ROM Mode 2 data block, you can expect to see more drives (such as the CM201 and CM210 half-height drives from LMS) that handle both CD-ROM and CD-I disks.

The CM201 and CM210 drives feature a removable cartridge to hold the CD-ROM disk. This cartridge, the Oyster from Philips, protects the disk from being scratched during handling. Such protection is critical for CD-ROMs, though it's not strictly necessary for audio CDs.

Scratches on the surface of an audio CD aren't much of a problem because of the disks' simple error-correction scheme. Should the audio CD's surface become sufficiently scratched so that a block can't be read or corrected, circuitry in the player simply repeats the previous block.

Although this technique works well for music (the repetition is either barely audible or undetectable), it's not at all applicable to CD-ROMs. Repeating the data from a previous block is not a viable solution for data-processing applications. Scratches on a CD-ROM

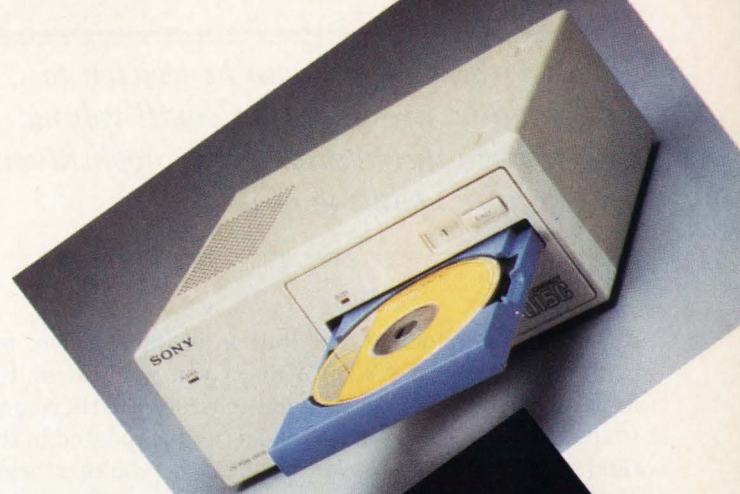

*Stand-alone
CD-ROM
drive (Sony)*

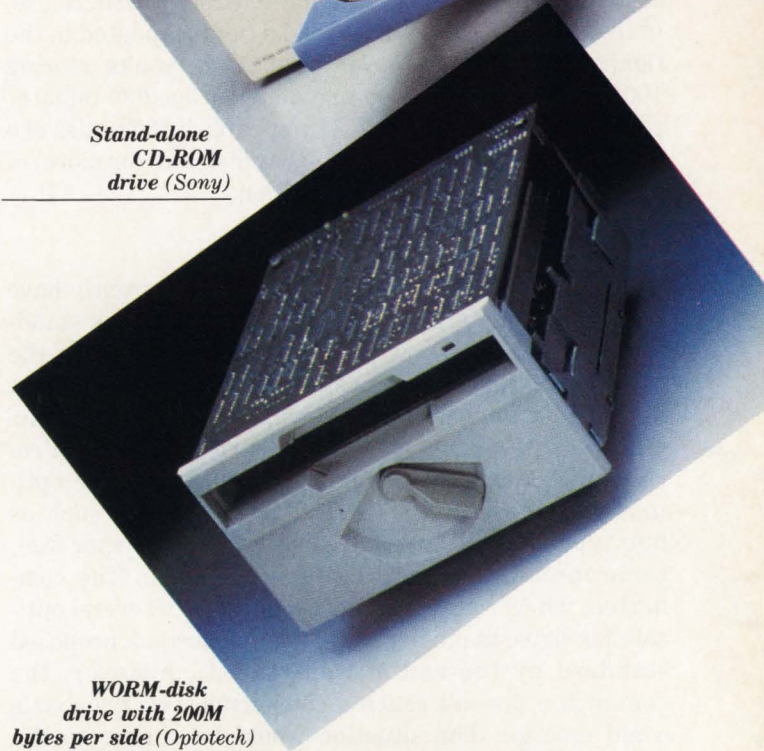

*WORM-disk
drive with 200M
bytes per side (Optotech)*

disk can slow data access: As the disk ages, more and more sectors come back with errors, and the error correction takes more and more time. Worse, scratches could even make a data block totally inaccessible. Philips has proposed its cartridge design for industry-wide use.

WORM disks are indelible

Some applications can't tolerate the unalterable nature of optical ROM disks. If your application requires frequent updating of data, WORM disks are currently your only choice in 5¼-in. optical-disk storage. Although you can't alter a file once it's written to a WORM disk, you can always write the updated version of your data to a new file.

Data-processing applications such as accounting, therefore, are well suited to WORM-disk storage. Not only do accounting records require frequent updating, but the inherently indelible storage provided by WORM drives creates an automatic audit trail. Government records and legal documents are also candidates for WORM-disk storage, for similar reasons.

WORM disks are often a better choice than OROM

WORM disks, which can be written to individually, are useful for small-volume information distribution or for applications that require updating of data.

disks for small-volume distribution of information, because when you use WORM disks you don't incur the expense or delay of a stamping master. Furthermore, unlike OROM disks, WORM disks can be updated in the field. Remember, however, that when you're storing 100M bytes or more, you may need at least 30 minutes to write each WORM disk. If you publish 100 copies of a database, for example, you'll incur 50 hours (or more) of continuous disk writing per edition.

WORMs don't have standard formats

Unlike CD-ROMs, WORM disks don't currently have standard formats. In fact, the only WORM-disk standard achieved until now is a proposed standard for the disk cartridge, the plastic shell encapsulating the disk. Technical committee X3B11, which reports to the Accredited Standards Committee on Information Processing Systems (X3) is at present debating the optimum specifications for optical-drive features such as hub type, spindle-hole size, data encoding, sector size, servo format, and error-correction scheme. The committee, which comprises representatives of several optical-disk-drive manufacturers, may generate a proposed standard by the end of this year. If, however, the committee doesn't reach a consensus, two proposals could emerge: The situation would be similar to the Beta/VHS-format duel in the VCR market or the multiplicity of LAN standards generated by the IEEE 802 committee.

Despite the lack of a standard for optical WORM disk drives, several vendors introduced optical WORM

drives at Comdex/Fall 86. Most of the WORM drives available today use the proposed X3B11 cartridge, but a couple of exceptions do exist. Maxtor's RXT-800S, for instance, uses a disk cartridge that's half as thick as that specified by the proposed standard. In addition, the RXT-800S uses a dye-polymer disk; most other WORM drives use disks coated with tellurium film. (Dye polymer is one of the three technologies under consideration for use in the forthcoming erasable optical disks; see **box**, "Erasable optical disks await compatible drives.")

Although the various WORM-disk formats may not be compatible, the situation for WORM-drive interfaces is much better. Manufacturers of 5¼-in. WORM drives appear to have rallied behind the ESDI and SCSI interface standards (**Table 2**). The drives that have embedded controllers have SCSI ports; the drives that don't have embedded controllers predominantly have ESDI ports. The rest have proprietary interfaces; manufacturers of these drives offer companion controller cards for the IBM PC bus, the SCSI bus, or both buses.

Most currently available WORM drives use disks based on a reflective tellurium film. A laser diode in the drive writes data on the disk by ablating spots, or burning pits, on the film (**Fig 2**). Burning the film destroys the reflectivity of that spot on the disk, so when the laser again illuminates that spot, most of the light passes through the pit and little light is reflected.

Optical media contain flawed areas, so not all attempted burns are successful. To ensure data integrity,

TABLE 2—REPRESENTATIVE 5¼-IN. OPTICAL WORM DISK DRIVES

MANUFACTURER	DRIVE MODEL	CAPACITY (M BYTES/SIDE)	AVG ACCESS TIME (mSEC)	DRIVE INTERFACE	PRICE	AVAILABILITY	CONTROLLER MODEL	CONTROLLER INTERFACE	CONTROLLER PRICE	MEDIA PRICE	
										1-SIDE	2-SIDE
FUJITSU	M2505	300	100	ESDI	\$2850 (100)	1ST QTR 1987	M1080	SCSI	\$595	N/A	\$100
HITACHI AMERICA	OD-101	300	100	ESDI	\$4380	JUNE 1987	OFC	SCSI	INCLUDED		
ISI	525 WC	115	150	ESDI	\$1655 (100)	NOW	PC/525 SCSI/525	IBM PC BUS; SCSI	\$400 (100); \$500 (100)	\$75 (100)	\$125 (100)
LASERDRIVE	LD-33	354	170	PROPRIETARY	\$2000 (1000)	2ND QTR 1987	LD-33	SCSI	\$1000 (1000)	\$40	\$60
LMS	LD500	≥300	<100	SCSI	<\$4000 (1000)	2ND HALF 1987	N/A	N/A	N/A	N/A	\$40-\$60
MAXTOR	RXT-800S	400	108	SCSI	\$1500 (2500)	JANUARY 1987	N/A	N/A	N/A	N/A	<\$100 (1000)
OPTOTECH	5984	200	220	PROPRIETARY	\$1500 (250)	NOW	PC; SCSI	IBM PC BUS; SCSI	\$350 (250); \$350 (250)	\$125	\$225

N/A=NOT APPLICABLE

Erasable optical disks await compatible drives

Depending on whose predictions you believe, you won't see commercially available erasable optical 5¼-in. drives for one to four years. Although no vendor currently offers such a drive, several manufacturers have demonstrated prototypes. At present, three media technologies exist for these drives: magneto-optic (MO), phase-change, and dye-polymer technologies.

Magneto-optic writing uses both thermal heating from illumination by a laser diode and an externally applied magnetic field to write data onto an MO disk, which is coated with a ferromagnetic metal film. The laser raises the temperature at one spot on the film above the ferromagnetic material's Curie point so the applied magnetic field can flip electron spins. During a read, an incident beam of polarized light is rotated through one of two small angles, depending on the electron spin's orientation (a phenomenon called the Kerr effect). A polarized analyzer in the drive's read/write head discriminates between the two polarizations, which represent the binary information stored on the disk.

MO-disk sectors can't be erased and rewritten in one process. The drive must erase the sector before rewriting it. In most drives, this process requires two disk revolutions, which degrades the drive's writing performance and may degrade its overall performance in some applications. Some MO-disk vendors claim that most software applications perform far more reads than writes, so the extra time needed to erase a sector before writing is not significant.

Makers of MO media claim to be closer to the production stage than are makers of other erasable-optical-drive media. In the last year, MO manufacturers

managed to exceed the 45-db carrier-to-noise ratio (CNR) deemed necessary for reliable recording and playback. Several vendors of MO disks, including KerDix (Boulder, CO) and Plasmon Data Systems (San Jose, CA), currently offer media samples. Although you can't obtain an MO drive yet, California Peripherals (Torrance, CA) offers the \$125,000 OMS-500 optical media tester. The tester lets you evaluate both MO and WORM media.

Phase-change media

The second type of media technology for erasable optical disks, phase-change technology, uses the difference in reflectivity between the crystalline and amorphous states of a chalcogenide film (usually based on selenium or tellurium) to store information on the disk. A short, intense burst of light from a laser diode disrupts the atomic structure at one spot on the metal film, creating an amorphous region. A longer, less intense light beam thermally anneals the same spot, restoring the crystalline state. During a read, the intensity of the reflected beam varies as the read/write head passes over the amorphous and crystalline regions. The resulting intensity modulation returns the information recorded on the disk. The reflectivity ratio between the amorphous and crystalline areas is large: Some media are capable of producing 95-db CNRs.

Dye-polymer technology

Unlike the MO and phase-change media technologies, dye-polymer technology places an organic coating on the disk. Optical Data's (Portland, OR) dye-polymer disk comprises two layers: an elastomeric layer covered by a thermoplastic layer.

The two layers absorb light at different frequencies, so a drive based on this technology must have two laser diodes (or a 2-frequency laser). Heating a spot on the lower, elastomeric layer with one frequency of light raises a bump, which decreases the spot's reflectivity (because the bump scatters light). Heating the upper, thermoplastic layer with a different frequency of light flattens the spot, increasing its reflectivity.

Like phase-change technology, dye-polymer technology relies on the intensity modulation of a reflected light beam to read information from the disk. Ultimately, the dye-polymer disks may be less expensive to manufacture because they use simple web- and spin-coating techniques for film deposition. In contrast, MO and phase-change films must be sputtered onto disk blanks in a vacuum.

All three technologies are still young. Detractors of the MO technology claim that the film on MO disks oxidizes easily, thus degrading the disk's performance and perhaps eventually destroying information already written on the disk. MO vendors say that proper protective coatings prevent such oxidation.

Critics of the phase-change and dye-polymer techniques say that phase-change and dye-polymer films are subject to fatigue, and thus shorter life, caused by the mechanical changes inherent in the two technologies. At present, none of the erasable-optical-disk technologies is yet mature enough to irrefutably disprove its critics.

Reference

1. McLeod, Jonah, *Optical Memory's Impact on Magnetic Storage and Computer System Architecture*, Electronic Trend Publications, Cupertino, CA, 1985.

Although the CD-ROM format is standardized, the interface to CD-ROM drives is not. Each manufacturer of CD-ROM drives uses a proprietary drive interface.

the disk-drive electronics must verify each burn. Optical-disk drives use two different techniques to check for successful burns: DRAW (direct read after write) and DRDW (direct read during write). Data sheets for WORM drives don't generally specify what type of verification the drive uses; you may have to ask the vendor to find out.

In DRAW verification (used in early WORM drives), the drive waits until the freshly written sector rotates back into view of the read/write head. It then reads and verifies that sector. The DRAW method slows drive performance, because verifying each sector requires an extra rotation of the disk.

In contrast, a drive that uses DRDW verification checks the success of a burn during the writing process, so that when the next sector moves into place, the drive is ready to write on it if necessary. Drives that use DRDW verification, therefore, generally have higher performance during file-writing operations than do DRAW drives.

The mechanics of verification

In single-laser WORM drives, the laser diode operates at high power during a write operation and at a lower setting during a read operation. The signal returned to the drive's optical detector during a write doesn't resemble a normal read signal **Fig 3**. At the beginning of a burn, the illuminated spot is reflective, returning a relatively strong signal to the detector. As the illuminated spot melts and the pit begins to form, reflectivity drops, and so does the returned signal. At

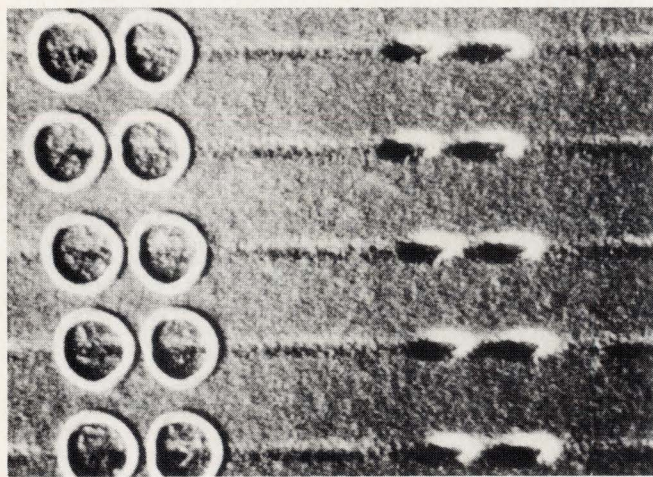

Fig 2—Pits burned into a WORM disk (right) are less reflective than unburned areas on the disk. The differential reflectivity reproduces the zeros and ones of the written data. (Photo courtesy Laser Magnetic Storage International.)

the end of the burn, after the pit is formed, the return signal is much smaller than it was at the beginning of the burn.

Because this returned signal is not close enough to a normal read pulse for the drive's read electronics to recognize it as such, most single-laser WORM drives lack the necessary electronics to perform DRDW verification. An exception is Optotech's 5984 drive, which incorporates a single-laser read/write head, yet employs DRDW verification. Circuitry in the drive senses the rate of drop of the returned signal and uses that information to determine whether the burn has succeeded.

Fujitsu takes a different approach to DRDW verification: Its M2505A WORM drive incorporates a 2-laser read/write head. One laser burns the pits; the other reads data from the disk. The read laser, which is adjacent to the write laser, verifies freshly burned pits immediately.

A few manufacturers build rugged WORM drives for environments ranging from factory floors to shipboard and avionic platforms. Rugged drives operate over extended temperature ranges and are more resistant to shock and vibration than commercial drives are. The drives' temperature-limit specifications are straightforward, but their shock and vibration specifications aren't standardized.

The rugged Model 200SE WORM drive from Mountain Optech is based on the Optotech 5984. The 200SE uses the basic 5984 drive mechanisms but operates over a wider temperature range. The Optotech 5984 is rated for operation over a 0 to 45°C range; the rugged 200SE drive operates over a 0 to 65°C range and can survive temperatures of -55 to +90°C. To protect the 200SE from shock, Mountain Optech wraps a cable-suspension system (**Fig 4**) around the drive mechanism. The company also packages the assembly in a ½ ATR (air transport racking) cabinet. NASA granted the firm a contract for the model 200SES, a space-rated version of its 200SE drive, which will be available in the first half of 1987.

Unlike the 200SE, which is basically a commercial drive in a shock mounting, the Pathfinder drive from Cherokee Data Systems is designed as a rugged drive from the ground up; it incorporates shock protection into the basic mechanism. The drive operates over -20 to +55°C and survives -50 to +75°C. It fits the standard 5¼-in. footprint.

Model 51R, a rugged WORM drive from Sperry, also fits the a 5¼-in. footprint. The company supplies the

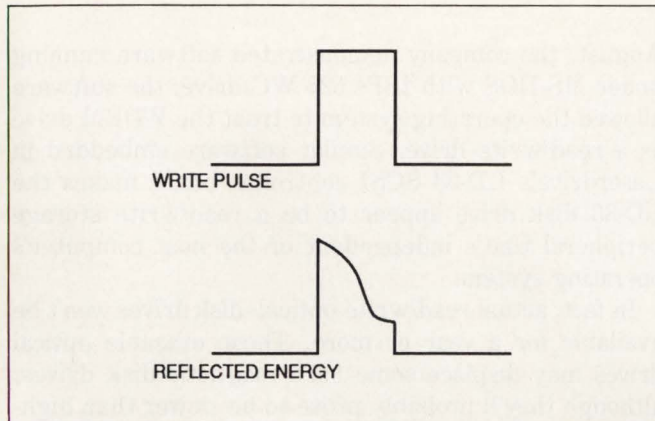

Fig 3—When a drive burns a pit into a WORM disk, the intensity of the reflected light is initially high because the coating has not yet been ablated. As the film burns, reflectivity drops, as does the reflected beam's intensity. The Optotech 5984 drive uses the dropping light intensity to verify the burn, a technique called direct read during write (DRDW).

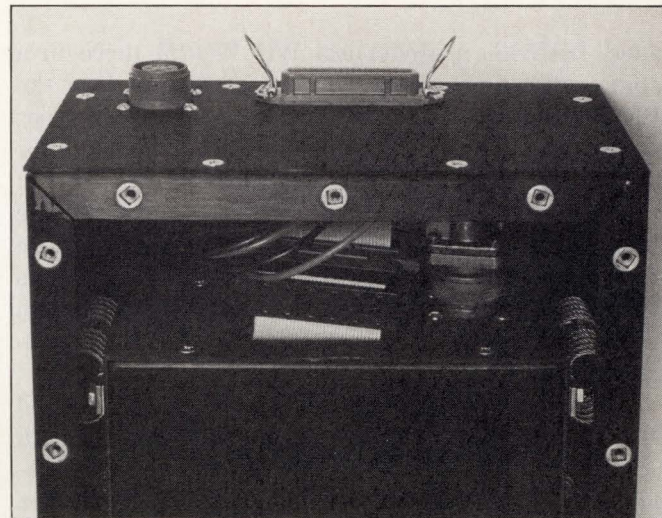

Fig 4—A cable-suspension system gives the Mountain Optech 200SE WORM drive extra resistance to shock and vibration.

drive with a controller card and your choice of five interfaces (see **Table 3**). The 51R operates over 0 to 50°C and survives temperatures from -40 to +71°C. The manufacturer is also designing the 51S (shipboard) and 51A (avionic) WORM drives to the corresponding military specifications; delivery of the 51S and 51A is scheduled for 1988. Each will be supplied in a rack cabinet and will come with a controller card, interface, and power supply.

WORM drives pose a unique problem for software integrators. Unlike OROMs, which operationally resemble write-protected magnetic disks (files can be read but not written), a WORM disk allows an operat-

ing system to write to a sector, but only once. At the very least, this restriction creates problems with directory handling.

Most operating systems can't handle WORM drives unaided because of this characteristic, so WORM-drive vendors developed utility programs to aid in the integration of their hardware products with popular operating systems, primarily that of the IBM PC. (The MS-DOS disk-size limitation of 32M bytes is as much a problem for WORM drives as it is for the CD-ROMs, because both drives have more than 32M bytes.)

Information Storage Inc (ISI) offers a \$3995 evaluation system, which includes a set of software utilities

TABLE 3—REPRESENTATIVE 5¼-IN., RUGGED, OPTICAL WORM DISK DRIVES

MANUFACTURER	MODEL	CAPACITY (M BYTES/SIDE)	AVG ACCESS TIME (mSEC)	DRIVE INTERFACE	PRICE	AVAILABILITY	COMMENTS
CHEROKEE DATA	PATHFINDER	315	53	ESDI	\$5000	1ST QTR 1987	
MOUNTAIN OPTECH	200SE	200	220	PROPRIETARY	\$8500	NOW	RUGGEDIZED VER- SION OF OPTOTECH 5984, ½ ATR PACKAGE
SPERRY	51R	260	100	*	\$15,000	APRIL 1987	PRICE INCLUDES CONTROLLER
	51S	260	100	*	\$40,000	JANUARY 1988	PRICE INCLUDES POWER SUPPLY, CON- TROLLER, CASE (MIL-E16400)
	51A	260	100	*	\$45,000	JANUARY 1988	PRICE INCLUDES POWER SUPPLY, CONTROLLER, CASE (MIL-E5400-CLASS 2)

*AVAILABLE INTERFACES: IEEE-488, SCSI, RS-449, MIL-STD-1397B, MIL-STD-1553B

CD-I is strictly a file format; computer systems based on μ Ps other than 68000-family μ Ps can also make use of CD-I disks.

called ISIDOS, a Model 525 WC WORM drive in a cabinet with a power supply, a controller card for the IBM PC bus, and an interface cable. ISIDOS comprises two low-level driver programs and five commands for copying files, managing the WORM drive's directory, and ejecting the disk cartridge. The software solves the MS-DOS drive-size limitation by breaking a physical drive into several logical drives, each with as many as 511 files. ISIDOS's low-level drivers allow application programs to access files on the optical drive via operating-system calls.

A \$5000 starter kit from Optotech includes a 5984 WORM drive, a controller card, and software for both file management and low-level interfacing. The file-management software allows you to treat the drive as a 200M-byte disk with one root directory and many subdirectories or several logical disks. Low-level device drivers in the software allow standard MS-DOS commands and utilities to operate on files stored on the optical disk. The low-level language interface in the Optotech software is compatible with the Lattice (Glen Ellyn, IL) and Microsoft C compiler calling conventions. Optotech is developing similar software for Unix systems.

Laserdrive may offer the easiest solution to the problem of integrating WORM drives in a system. In

August, the company demonstrated software running under MS-DOS with ISI's 525 WC drive; the software allowed the operating system to treat the WORM drive as a read/write drive. Similar software embedded in Laserdrive's LD-33 SCSI controller board makes the LD-33 disk drive appear to be a read/write storage peripheral that's independent of the host computer's operating system.

In fact, actual read/write optical-disk drives won't be available for a year or more. These erasable optical drives may displace some hard magnetic disk drives, although they'll probably prove to be slower than high-performance magnetic disk drives. However, erasable optical drives will provide hundreds of megabytes of removable read/write storage, a capability that even high-capacity 5¼-in. hard magnetic disk drives don't have.

EDN

Article Interest Quotient (Circle One)
High 470 Medium 471 Low 472

For more information . . .

For more information on the 5¼-in. optical-disk drives described in this article, contact the following manufacturers directly or circle the appropriate numbers on the Information Retrieval Service card.

Cherokee Data Systems
1880 S Flatiron Ct, Suite H
Boulder, CO 80301
(303) 449-8850
Circle No 725

Fujitsu America Inc
3055 Orchard Dr
San Jose, CA 95134
(408) 946-8777
Circle No 726

Hitachi America Ltd
Computer Div
950 Elm Ave
San Bruno, CA 94066
(415) 872-1902
Circle No 727

Hitachi Sales Corp of America
401 W Artesia Blvd
Compton, CA 90220
(213) 537-8383
Circle No 728

Information Storage Inc
2768 Janitell Rd
Colorado Springs, CO 80906
(303) 579-0460
Circle No 729

Laser Magnetic Storage International
4425 ArrowsWest Dr
Colorado Springs, CO 80907
(303) 593-7900
Circle No 730

Laserdrive Ltd
1101 Space Park Dr
Santa Clara, CA 95054
(408) 970-3600
Circle No 731

Maxtor Corp
150 Rivers Oak Parkway
San Jose, CA 95134
(408) 942-1700
Circle No 732

Mountain Optech Inc
2830 Wilderness Pl, Suite F
Boulder, CO 80301
(303) 444-2851
Circle No 733

Optotech Inc
770 Wooten Rd
Colorado Springs, CO 80915
(303) 570-7500
Circle No 734

Panasonic Industrial Co
One Panasonic Way
Secaucus, NJ 07094
(201) 392-4263
Circle No 735

Sony Corp of America
1359 Old Oakland Rd
San Jose, CA 95112
(408) 280-0111
Circle No 736

Sperry Computer Systems Div
Box 3525
St Paul, MN 55165
(612) 456-4605
Circle No 737

THE ANSWER IS IN TEK DIGITAL STORAGE. FOR AS LITTLE AS \$4150!



Now get the best of both worlds, analog and digital, in one familiar, easy-to-use package. With the 100 MHz Tek 2230 and 60 MHz 2220 you benefit from 20 MS/s digitizing plus analog operation to each scope's bandwidth. Just push a button for real-time display analysis!

Expect the most for your money—and get it—with Tek. You can capture events as narrow as 100 ns at any sweep speed—using Tek's proprietary peak detect mode. Trigger on complex waveforms using variable sweep holdoff. View events prior to or following a trigger event with pre/post trigger. Eliminate noise with built-in signal averaging. Store acquired waveforms as either 1K or 4K records. All with unrivalled convenience and confidence in your

Features	2230	2220
Analog/Digital Storage BW	100 MHz	60 MHz
Max. Sampling Speed	20 MS/s	20 MS/s
Record Length	4K/1K (selectable)	4K
Save Reference Memory	One, 4K Three, 1K	One, 4K
Vertical Resolution	8 bits 10 bits (AVG mode) 12 bits (AVG mode over bus)	8 bits
CRT Readout	Yes	No
Cursor Measurements	Yes (storage mode)	No
GPIB/RS-232-C Options	Yes (\$850)	Yes (\$550)
Battery-Backed Memory (save 26 waveform sets)	Yes (inc. with 2230 communications options)	No
Price	\$5150	\$4150

measurement results.

Both scopes offer optional GPIB or RS-232-C interfaces. With either

option the 2230 also includes battery-backed memory that provides 26K of keep-alive CMOS memory

—for storing up to 26 waveform sets.

Call Tek direct to get your free video or diskette demo. Or to place an order! Ask about free Tek digital storage application notes and educational materials. Technical personnel will answer your questions, take an order and expedite delivery. Orders include complete documentation, operating manuals, worldwide service back-up and Tek's 3-year warranty that even covers the CRT.

Call Tek direct:
1-800-433-2323 for video or diskette demo
1-800-426-2200 for orders and/or technical advice

In Oregon, call collect:
1-627-9000

Tektronix
COMMITTED TO EXCELLENCE

CIRCLE NO 33

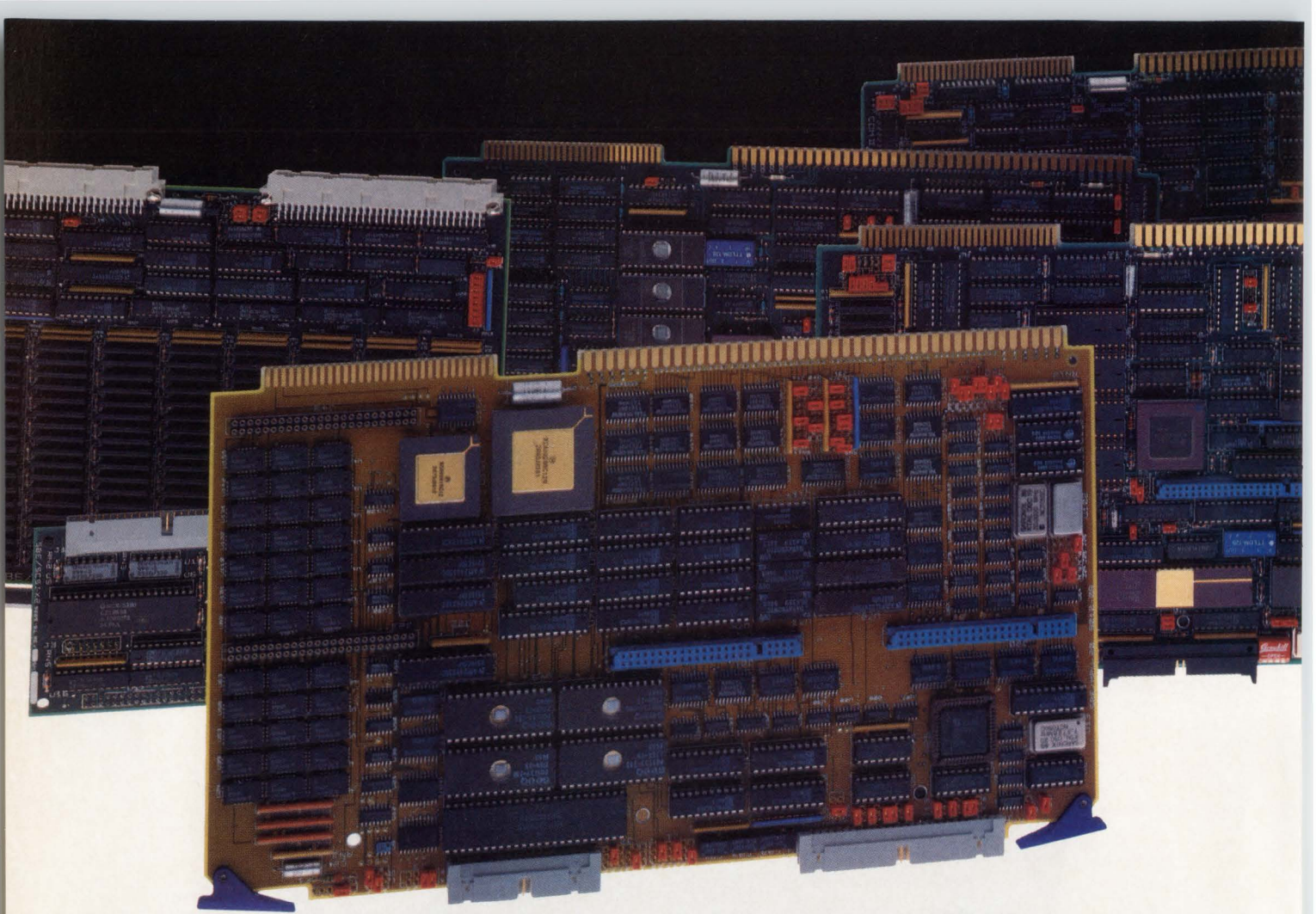

No compromises.

The new SBE MPU-20 for Multibus.

If you'd like to add 32-bit performance to your 68000-based system, the MPU-20 makes it simple. Pull your 68000 board. Plug in the SBE IEEE-796 compatible MPU-20. That way, you'll get the power (typically 2.5X to 5.0X faster) and flexibility of an MC68020 system while you protect your investment in existing hardware and software. If you could use a little help, our team joins your team. And our customers will tell you we're second to no one in engineering and software support.

Top-end performance.

No compromises. The MPU-20 is designed to function as a standalone microcomputer, as a single CPU controller in a Multibus system, or, as one of many CPUs in a multiprocessor configuration. Running at your choice of 12.5 or 16.7 MHz, the MPU-20 combines high performance with versatile I/O components. The combination is particularly applicable to process control, robotics, data acquisition and machine vision. And if you're turbocharging an existing system, the MPU-20 runs most 68000 software immediately. It's loaded with powerful features like 1 to 8 Megabytes of on-board, parity-protected, dual-ported

RAM and two independent, full duplex RS-232-C channels. And optionally, a 68881 floating point coprocessor and memory management.

Bottom-end prices.

No compromises. With SBE, you can build in the performance your customers need, at a price you and your customers can afford. \$1995 in 100's. Other people may compare with that price, but they can't compare with the performance of the MPU-20. And we encourage you to shop them all.

A no compromise offer.

If you'd like to evaluate the MPU-20 for yourself, we make it easy. We offer systems designers and engineers our "Starter Kit," an MPU-20 standalone computer board with 1 Megabyte of RAM, plus PROBUG® software and cabling at the quantity 100 piece price of \$1995. And we offer our guarantee: If it isn't everything we say it is, just return it for a refund. And if you ever have a problem, we want to hear about it.

Better boards. Better prices.

We're committed to the price/performance equation. And we're equally committed to better engineering, better software,

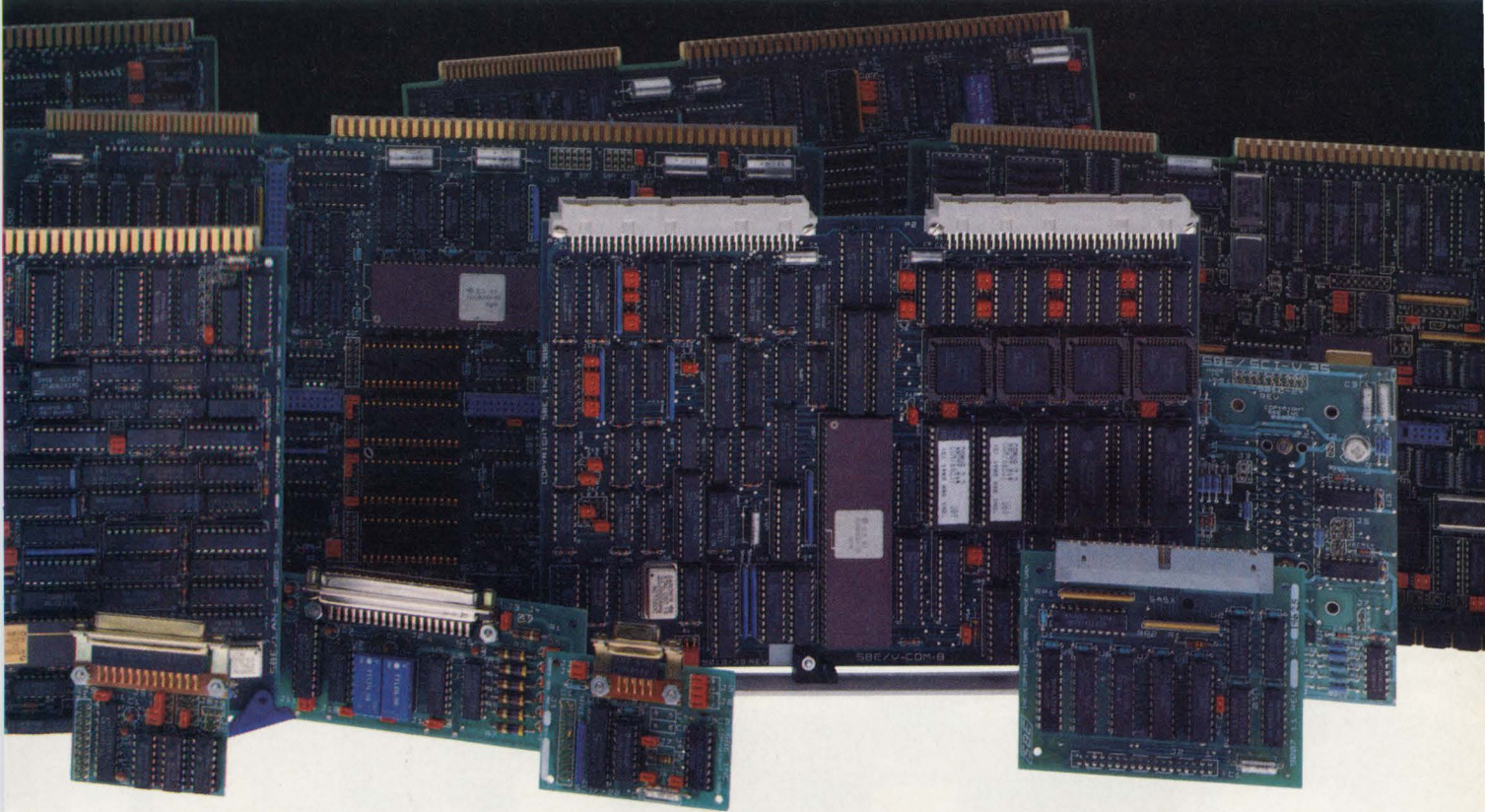

and better support. That's a tall order. But we're delivering.

Across-the-board Multibus.

If you need it, you can probably get it from SBE. Turnkey Multibus computer systems, standalone CPU boards, memory management boards, intelligent communications boards, SERX and SCSI interface modules to operating systems, languages and utilities.

More than boards. Solutions.

When you look to SBE as your supplier you get boards, in quantity, on time. You also get our support team in both hardware and software. Because we want to offer you total solutions. Even custom solutions for qualified OEMs. Our aim is to see that you get better systems, faster, and at better prices. No compromises.

One stop shopping.

Check off your interests on the adjacent coupon. Mail it to us and we'll mail back our short form catalog plus spec sheets on the boards and software that particularly interest you. Can't wait? Call us Toll Free: (800) 221-6458. In California: (800) 328-9900. Tell us what you need. We'll get back to you with solutions. Fast.

EDN122586

O.K., I'm interested. Please send me information and specs on the SBE products I've checked below:

<p>CPU BOARDS</p> <p><input type="checkbox"/> MPU-20</p> <p><input type="checkbox"/> MPU-12</p> <p><input type="checkbox"/> M68K10</p> <p><input type="checkbox"/> M68CPU/M68MEM</p>	<p>COMMUNICATIONS BOARDS</p> <p><input type="checkbox"/> COM-2</p> <p><input type="checkbox"/> COM-4</p> <p><input type="checkbox"/> COM-8</p> <p><input type="checkbox"/> MLAN-E</p>	<p>SYSTEMS</p> <p><input type="checkbox"/> SBE 200</p> <p><input type="checkbox"/> SBE 250</p> <p><input type="checkbox"/> SBE 300</p> <p><input type="checkbox"/> SBE 350</p>	<p>BOARD SOFTWARE</p> <p><input type="checkbox"/> UNIFY™</p> <p><input type="checkbox"/> UltraCalc™</p> <p><input type="checkbox"/> FORTRAN 77</p>
<p>I/O EXPANSION</p> <p><input type="checkbox"/> SCSI</p> <p><input type="checkbox"/> SASX</p> <p><input type="checkbox"/> SERX-232</p> <p><input type="checkbox"/> SERX-422</p>	<p>VME BOARDS</p> <p><input type="checkbox"/> VCOM-8</p> <p><input type="checkbox"/> VMEM-4</p>	<p>SYSTEMS SOFTWARE</p> <p><input type="checkbox"/> UNIX™ V</p> <p><input type="checkbox"/> REGULUS™</p> <p><input type="checkbox"/> System III Utilities</p>	<p><input type="checkbox"/> Add me to your mailing list.</p>

Name _____

Title _____ Phone () _____

Firm _____ State _____ Zip _____

Address _____

City _____

SBE, INC.
 MICROCOMPUTER BOARDS AND SYSTEMS
 2400 Bisso Lane, Concord, CA 94520
 Toll Free: (800) 221-6458
 In Calif.: (800) 328-9900
 TWX: 910-366-2116 (SBE CNCD)



“LEADING THE INDUSTRY IN VME SOLUTIONS”

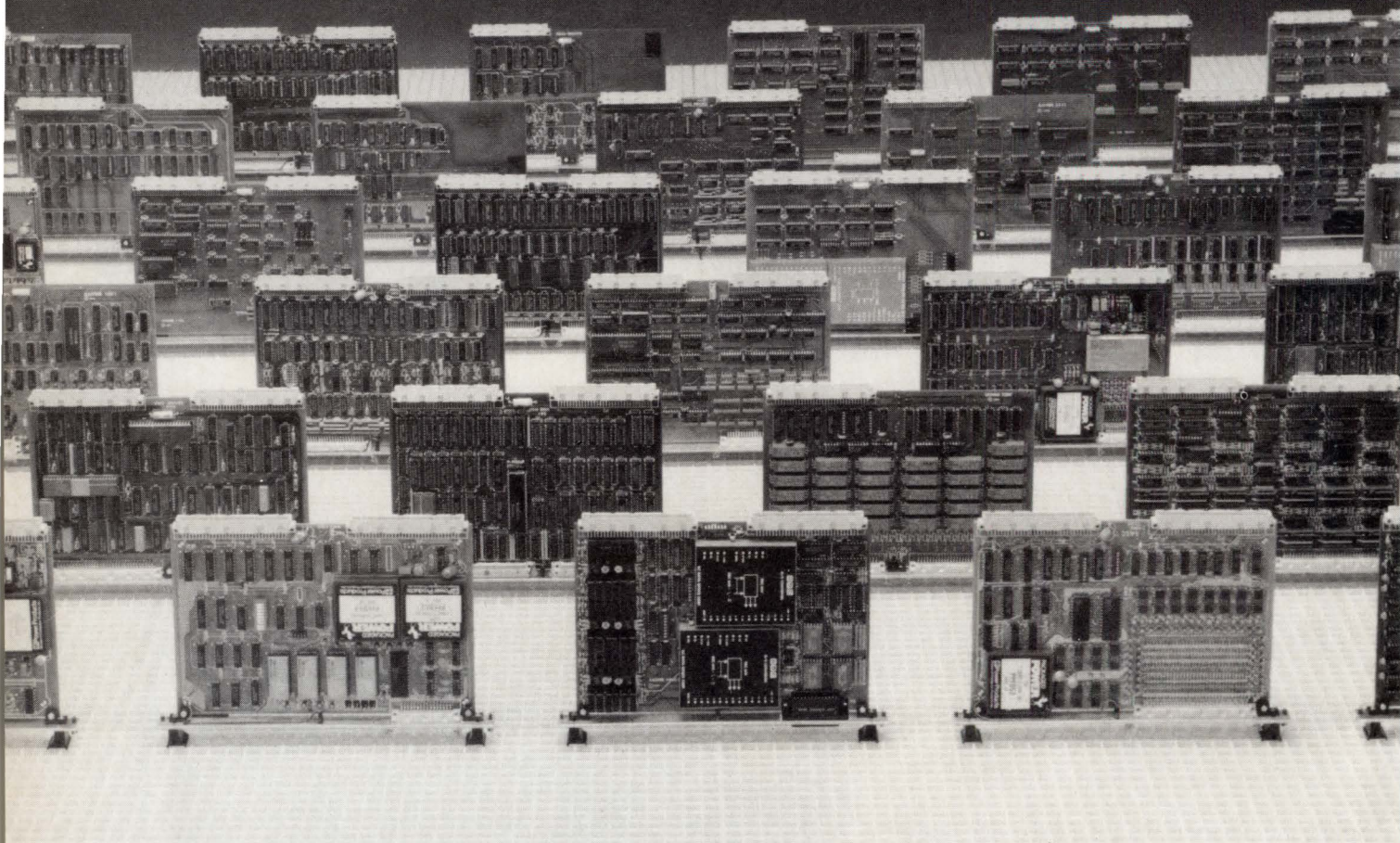

Our Full Line of VMEbus Modules includes:

VME Microsystems International Corporation

12021-N South Memorial Parkway
Huntsville, Alabama 35803
(205) 880-0444
Telex# 593128

- HOST INTERFACES
- DIGITAL I/O
- SYNCHRO/RESOLVER
- COUNTER/PULSE RATE
- INTELLIGENT I/O CONTROLLERS
- VME to VME LINKS
- ANALOG I/O
- CHANGE-OF-STATE
- SERIAL I/O
- ANALOG & SYNCHRO BACK PLANES

One-year warranty on all modules

European Office
Diamond Point International Corporation

22 Riverside Park
Farnham, Surrey 9GU7UG,UK
(44) (0252) 716006
Telex: 946240 Ref. 19019110

Computers and Peripherals

PC-based board, software, and VAX link expand resources for 32-bit workstation

The Sun Integrated Personal Computer (IPC) coprocessor board plugs into Sun workstations to provide compatibility with the PC/AT. The board lets you run MS-DOS applications in a window under the company's Unix operating system. The \$1995 IPC board contains a 10-MHz 80286 μ P and 1M byte of memory, but an expanded-memory spec lets MS-DOS applications access as much as 4M bytes of memory. Accompanying software costs \$395 for a single-user version; the multiple-access version costs \$995.

The PC-NFS program lets PCs access files in a Sun workstation. The program automatically converts local MS-DOS file names to network-compatible Network File System (NFS) path names. When you use PC-NFS, your network server can store data from a PC and



transfer files from the PC to the workstation. PC-NFS costs \$225 (100) without documentation, \$305 with documentation.

By linking PC-based software to Unix-based databases, Network Innovations' Multiplex/NFS complements PC-NFS. Multiplex/NFS lets you read the contents of a database on a Sun workstation and transfer the data—in PC format—to a PC. The program also lets your workstation run programs that require greater computational power than a PC can provide. Site licenses of the

program cost \$1195.

Win/VX, a VAX-based package from the Wollongong Group, lets you access VAX and MicroVAX computers from your PC via Sun Microsystems' NFS. Using this software you can run an application on a VAX and transfer the output of the program to a Sun workstation. The VAX version of Win/VX costs \$5000; the MicroVAX version costs \$2500.

Sun Microsystems Inc, 2550 Garcia Ave, Mountain View, CA 94043. Phone (415) 960-1300. TLX 287815.

Circle No 565

Network Innovations Corp, 4691 Albany Circle, San Jose, CA 95129. Phone (408) 249-6767.

Circle No 566

Wollongong Group Inc, 1129 San Antonio Rd, Palo Alto, CA 94303. Phone (415) 962-7100.

Circle No 567

3½-in. Winchester disk drive features integral SCSI controller

The 8425S 3½-in. Winchester disk drive incorporates a SCSI controller and provides a capacity of 21.3M bytes (formatted). The drive's MTBF rating is 20,000 hours. The average access time for the drive is 68 msec; track-to-track access time is 15 msec. The 8425S drive dissipates an average of 12.4W.

An integral controller permits transfer rates of 1M byte/sec and supports all commands in the SCSI Common Command Set (CCS). Additional commands that the controller supports include Verify, Start/Stop, Seek Extended, Read Buffer, Write Buffer, Read Extended, Write Extended, Mode Select, Re-

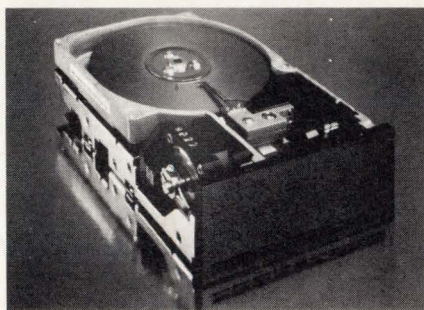

assign Blocks, Receive Diagnostic Results, Send Diagnostic Results, Write and Verify, and Read Capacity. The controller has a dual-ported sector buffer that allows a 1:1 sector interleaving.

The drive uses the same head/disk assembly that the company's 8425

3½-in., ST506/412HP Winchester disk drive uses. The manufacturer uses additional tracks on the platters in the 8425S to install a media-defect management scheme that allocates one spare track per data cylinder. A read-only track is reserved for diagnostic information and media-degradation tracking over the life of the drive. The manufacturer also suggests a format for a track that you can use to record the drive's performance history. The 8425S costs \$375 (1000).

Miniscribe, 1861 Lefthand Circle, Longmont, CO 80501. Phone (303) 651-6000.

Circle No 568

What if...

**YOU COULD PULL OFF
A PERFECT DRAWING
FOR ONLY \$5,400?**

Ah, the big idea. Everyone has one. But not everyone can afford a plotter to plot one on. Which got us thinking. What if there was an HP quality plotter so reasonably priced you could afford to hook one up to every PC CAD workstation in the office?

Introducing the HP DraftPro Plotter. Now for only \$5,400 any architect, engineer or designer can create perfect plots time after time. Consider what the DraftPro can do:

It can draw straight lines, smooth arcs and perfectly-formed characters. All on C and D-size drafting film, paper or vellum, using eight different pen colors.

Furthermore, it works with just about any PC, like the HP Vectra PC and IBM PC's. As well as popular PC CAD programs like VersaCAD and AutoCAD.

If the idea of having HP reliability with a low price tag makes sense to you, call us now. For a brochure and sample plot, call 1 800 367-4772, Dept. 215F.

The HP DraftPro Plotter: high-quality drafting for only \$5,400.*

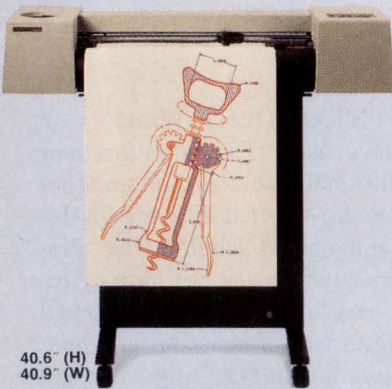

40.6" (H)
40.9" (W)

This diagram is an unretouched reproduction of a drawing produced on the HP DraftPro with VersaCAD software.



**HEWLETT
PACKARD**

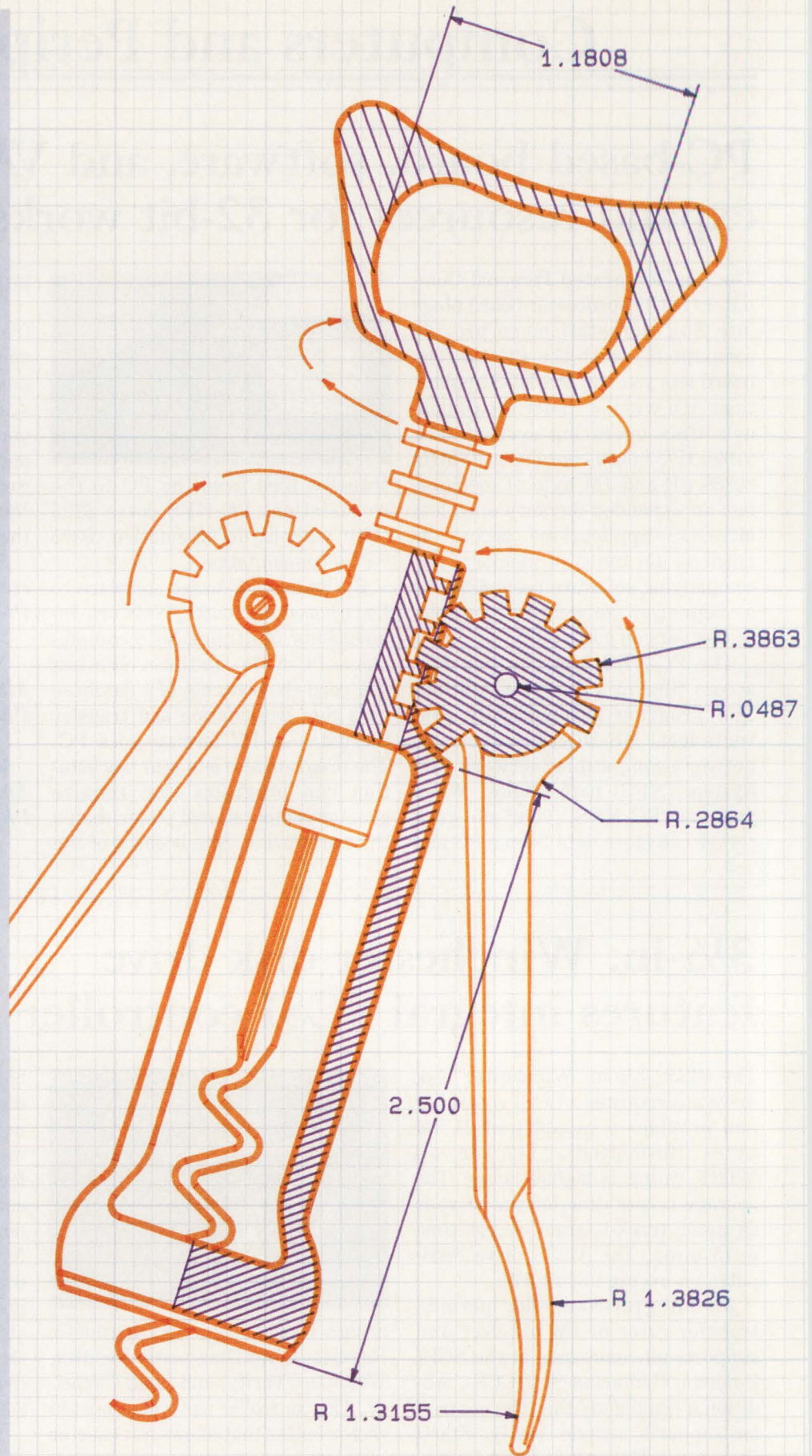

*Suggested U.S. list price.

HP Vectra PC is a trademark of Hewlett-Packard. IBM PC is a registered trademark of International Business Machines. VersaCAD is a registered trademark of T & W systems. AutoCAD is a registered trademark of Autodesk, Inc. © 1986 Hewlett-Packard Co.

PG604EMY

Computers and Peripherals

VME Bus graphics board specs resolution of 1024×1024 pixels, 10 bits per pixel

The 1024×1024-pixel, bit-mapped video RAM on the double-Eurocard TSVME-602 intelligent graphics-controller board holds 10 bits per pixel, eight of which allow you to display as many as 256 colors from a palette of 256k colors via an on-board color look-up table. The other two bits per pixel provide you with two pixel-masking planes.

The video RAM is accessible via the VME Bus and operates under the control of a TS68483 graphics-controller chip. This chip provides several graphics primitives, including vector, arc, and circle drawing, and area-fill commands. For 8-bit pixels, the board can draw vectors at a rate of 0.6M pixels/sec, and fill areas at a rate of 5M pixels/sec. The board drives a color monitor via

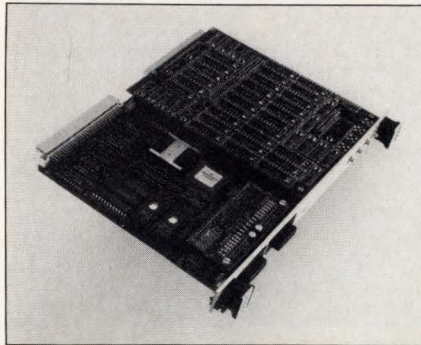

75Ω, 1V p-p RGB outputs, plus a composite-sync TTL-level output. The driven monitor's resolution is 1024×768 pixels with a 75-Hz interlaced scan rate.

An onboard 12.5-MHz 68010 μP provides local intelligence for the execution of higher level graphics commands. The μP can access 512k bytes of zero-wait-state dynamic

RAM, 64k bytes of which are dual-ported to the VME Bus for byte or word access by host processors. The board also includes sockets for as much as 128k bytes of EPROM firmware, a VME Bus interrupter with programmable interrupt vectors and interrupt levels, and two RS-232C serial I/O ports. It comes with onboard monitor/debugger firmware. Fr fr 33,000.

Thomson Semiconducteurs, 45 Ave de l'Europe, 78140 Velizy, France. Phone (1) 39469719. TLX 204780.

Circle No 579

Thomson Components-Mostek Corp, 7950 E Redfield Rd, Scottsdale, AZ 85260. Phone (602) 951-2900.

Circle No 580

Image-processing system for the IBM PC/AT computes a 3×3 convolution in 0.85 sec

The DT2851 frame grabber, in concert with the DT2858 auxiliary frame processor and DT-Iris image-processing software, allows you to perform sophisticated image-processing functions on an IBM PC/AT in real time. The basic system consists of one board, the DT2851 frame grabber, which digitizes, stores, processes, and displays video images. You speed system operation by adding the DT2858 auxiliary frame processor. This 16-bit pipelined processor connects directly to the DT2851 frame grabber through I/O ports that are separate from the PC/AT's bus.

The DT2851 operates with both standard and nonstandard video inputs, including inputs from all video

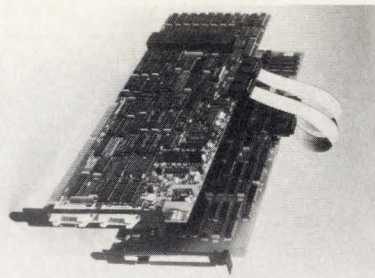

cameras, VCRs, and slow-scan devices. The board digitizes all images into a 512×512×8-bit array. The DT2851 can perform such common processing operations as merging, subtracting, and constant offsetting, and the concatenation of frames via AND, OR, and Exclusive-OR gates.

The DT2858 uses a RAM conversion table and a 16-bit ALU to accel-

erate arithmetic-intensive image-processing operations. For example, it processes a 3×3 convolution on a 512×512×16-bit image frame in 0.85 sec, or 250 times as fast as the PC/AT could perform the same operation. DT-Iris, a package of support software for the two boards, includes such routines as N×M convolution, windowing, frame averaging, histograms, zoom, pan, and scroll.

The DT2851 frame grabber costs \$2995, the DT2858 auxiliary frame processor costs \$1495, and the DT-Iris software costs \$995.

Data Translation Inc, 100 Locke Dr, Marlboro, MA 01752. Phone (617) 481-3700. TLX 951646.

Circle No 576

Computers and Peripherals

IEEE-488 controller card operates alone or serves as subsystem in VME Bus systems

Incorporating an onboard 68000 or 68010 μ P, as much as 2M bytes of dual-port RAM, and an interface and driver firmware for the IEEE-488 bus, the double-Eurocard PME68-14 board is suited for use as an intelligent IEEE-488 subsystem for VME Bus systems, or as a stand-alone IEEE-488 controller.

The board is capable of operating as an IEEE-488 talker, listener, or system controller. A DMA channel, operating in either a block-transfer or cycle-steal mode, transfers data between the IEEE-488 bus and either the VME Bus's global memory or the onboard dual-port RAM. In block-transfer mode, the DMA channel is capable of transferring data across the IEEE-488 bus at the standard's full 1M-byte/sec data rate.

An interrupt handler allows the

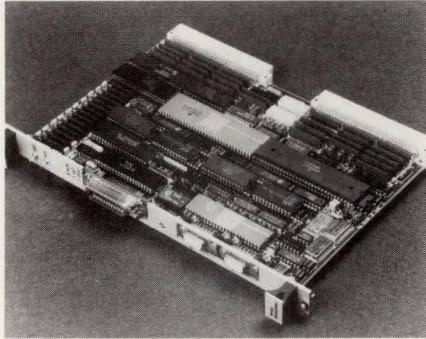

onboard μ P to respond to local or VME Bus interrupts, and the board can also generate VME Bus interrupts with programmable interrupt vectors and interrupt levels. The PME68-14's 512k bytes or 2M bytes of dual-port RAM provide zero-wait-state local access for μ P clock rates as high as 10 MHz. VME Bus access to the RAM is via an A32/A24, D16/D8 VME Bus interface. To alert the onboard processor of

mailbox messages in the dual-port RAM, a reserved 32-word area of the dual-port RAM generates a local interrupt when written to via the VME Bus. The board also includes slot-1 VME Bus functions.

Additional onboard features include four 32-pin sites for static RAM, EPROM, or EEPROM, two RS-232C I/O ports (optionally RS-422A), a real-time clock, and three counter/timers. An optional daughter board with a 68881 math coprocessor is also available. \$2081.

Plessey Microsystems Ltd, Water Lane, Towcester, Northants NN12 7JN, UK. Phone (0327) 50312. TLX 31628.

Circle No 581

Plessey Microsystems, 1 Blue Hill Plaza, Pearl River, NY 10965. Phone (914) 735-4661.

Circle No 582

Color-graphics board for DEC computers provides a selection of 16 million colors

The VCX-Q/U color-graphics board for DEC computers can create images that are 24 planes deep. This capability allows the board to display a theoretical limit of 2^{24} , or 16 million, colors at any given moment. You can add an alphanumeric overlay to the image as well.

The board is a quad-height card configurable for either Q Bus or Unibus computers. The display is organized as 512x512 pixels. The board determines the color of each pixel by designating eight bits each for the red, green, and blue elements of the color. An independent frame buffer and look-up table generate each 8-bit set, allowing maximum flexibility in color selection.

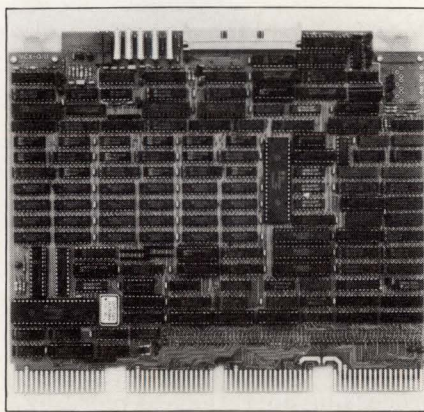

The independent, memory-mapped alphanumeric overlay measures 50 linesx80 characters. You have a choice of 64 character colors and 64 background colors, all independent of the choice of graphics colors. The

character set is stored in RAM and is user programmable.

An RS-330-compatible output carries graphic and alphanumeric elements on separate connectors or mixed on a single set of connectors. A composite-sync input accepts an external signal to synchronize the board's operation with peripheral equipment. A direct port, independent of the computer bus, enables an external device to operate directly on the board's registers and memory. The board costs \$5895; delivery is 45 days ARO.

Peritek Corp, 5550 Redwood Rd, Oakland, CA 94619. Phone (415) 531-6500.

Circle No 573

Computers and Peripherals

Stand-alone expansion chassis lets Macintosh use PC/AT boards

You can turn an Apple Macintosh Plus computer into a μ P-based data-acquisition and instrumentation-control system by plugging the MacBus stand-alone expansion chassis into the Apple's SCSI port. An 8-MHz, 16-bit NEC V50 μ P controls the expansion bus. The expansion unit provides an IEEE-488 interface, which lets the computer control a wide range of instruments. In addition, the MacBus lets you use as many as three IBM PC/AT add-on boards with your Macintosh Plus.

The unit's PC/AT-compatible SCSI interface allows data transfer between the MacBus and the Macintosh Plus at 250k bytes/sec max. The chassis contains five card slots; one is occupied by an NCR 5380-based SCSI-bus card, and another contains the GPIB-V50 μ P board.

The V50 card includes an EPROM



that contains the company's proprietary MacBus operating system, ICBL. You can add as many as 512k bytes of RAM to the μ P card. To perform floating-point calculations without intervention by the host computer, you can plug an optional 8-MHz NEC 72191 numeric coprocessor into the V50 card. Depending on the cards you choose for the remaining three slots, you can turn the MacBus into a serial communi-

cation link, an A/D converter, a video frame grabber, or some other kind of instrument.

The IBCL gives you a command set with which to control the IEEE-488 interface. The IBCL's interactive program-development facilities let you develop and debug instrumentation-control programs that the MacBus can then execute without host intervention.

The MacBus enclosure measures 6×11.75×15.25 in. Its backplane bus offers four DMA channels and six interrupt lines. The unit has an integral fan and power switch. The MacBus sells for \$1495. Its interface software costs \$200.

National Instruments Corp., 12109 Technology Blvd, Austin TX 78727. Phone (800) 531-4742; in TX, (800) 433-3488.

Circle No 569

Fiber-optic modem allows multidropping, brings security to local-area networks

The LDM85 fiber-optic modem offers multidrop capability, which means you can connect several stations of the associated data terminal equipment (DTE) along a single line. This capability allows you to form local-area networks (LANs) that feature the isolation, EMI immunity, and data security inherent in fiber-optic systems. The LDM85 handles data rates from dc to 5M baud at distances to 2 km. It features a serial port that conforms to the full RS-232C standard, as well as high-speed TTL/RS-422/-423 transmit and receive capability.

The extremely low pulse distur-



tion of fiber-optic cables allows you to use pairs of LDM85 units as repeaters, thus extending data-transmission distances. LDM85 fiber-optic modems withstand high voltages and eliminate electrical surges. Typical applications for the modem

include process control, communications, factory automation, CAD/CAM installations, and distributed computer systems.

The LDM85 is housed in a 2.1×1.0×3.75-in. aluminum package. Other features include a DCE/DTE switch, a choice of pin or socket connectors, three diagnostic LED indicators, and SMA connectors for the fiber-optic cables. The modem costs \$169 to \$179.

Burr-Brown Corp, Box 11400, Tucson, AZ 85734. Phone (602) 746-1111.

Circle No 575

Computers and Peripherals

Drive includes ESDI or embedded SCSI, packs 760M bytes into a 5¼-in. size

The EXT-8000 family of 5¼-in. Winchester disk drives includes models that store 760M bytes. The drives feature an 18-msec average access time. You can choose from ESDI or embedded-SCSI models.

The EXT-8760 760M-byte drive stores data on 15 surfaces of its eight platters; the sixteenth surface is reserved for housekeeping. Each disk surface contains 1632 tracks at a density of 1376 tpi; the recording density is 31,429 bpi. Together, the track and recording densities give the drive a total density of 43.25M bits/in². Offering similar bit densities on fewer platters, the EXT-8380 stores 380M bytes and has an average access time of 16 msec.

A 16-bit μ P resident on each drive-interface board controls the servo system. The μ P and the controlling firmware optimize head ac-

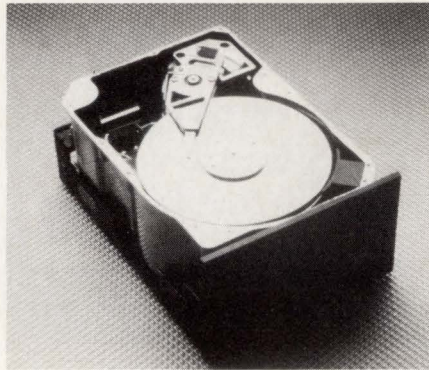

celeration and deceleration during seek operations. In addition to minimizing access time, the μ P control reduces noise. The servo system allows the drives to support hard- or soft-sector data formats.

EXT-8000 ESDI models support a 15M-bps data-transfer rate. At present, the ESDI spec defines maximum transfers of 10M bps, but the spec may soon be modified for

faster operation. Several companies already offer faster controller boards that would support the EXT-8000 drive.

The SCSI I/O bus model embeds the I/O bus directly in the drive. The SCSI model supports the specified 1.5M-byte/sec asynchronous transfer rate; it will also be compatible with the expected host-supported 4M-byte/sec synchronous SCSI transfer rate.

The EXT-8000 ESDI models cost between \$4 and \$5 per megabyte (1000). For embedded SCSI drives, expect to add about \$150 to \$200 to the cost. Production quantities will be available in the first quarter of 1987.

Maxtor Corp, 150 River Oaks Parkway, San Jose, CA 95134. Phone (408) 942-1700.

Circle No 570

Monitor handles multiple input formats, varies in brightness, phosphor persistence

Each member of the ECM 13XX family of color monitors allows you to choose from a variety of color cards for high-quality CAD/CAM, business-graphics, and process-control presentations. These cards include the IBM Enhanced Graphics Adapter and Conographics, Tecmar, Persyst, and STB color cards for the IBM PC.

The ECM 1311 is a high-contrast, long-persistence-phosphor monitor with a dark body. Antiglare features render it suitable for applications in environments subject to high ambient light levels. The ECM 1310 also has a dark body and anti-

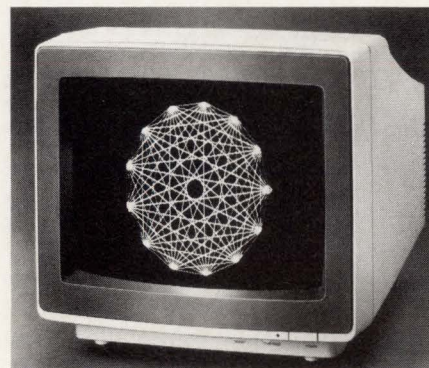

glare features. However, it uses a short-persistence phosphor and is intended for CAD/CAM graphics.

The ECM 1312 is a long-persistence-phosphor monitor with

a clear body. It serves in applications that require high brightness levels. The 1312 is the brightest of the 3-monitor family.

The resolution of all the monitors is 720×540 pixels. Automatic frequency-adjustment facilities allow you to attach any personal-computer color card with a horizontal frequency less than 34 kHz. All three monitors accept RGB/RS-170 and IBM TTL inputs. The price is \$1195 for each monitor.

Electrohome Ltd, 809 Wellington St N, Kitchener, Ontario, Canada N2G 4J6. Phone (519) 744-7111.

Circle No 578

Computers and Peripherals

Host adapter ties SCSI bus and peripherals to VME Bus

The PT-VME400 SCSI host adapter for the VME Bus ties the SCSI bus and its associated peripheral devices to the VME Bus. The host adapter includes a 68010 μ P, a 68450 4-channel DMA controller, and 512k bytes of memory. The 68010 supervises all SCSI-bus activity; the host CPU communicates with the adapter via high-level macro commands. You can use the DMA controller to move data from the SCSI bus to local onboard buffer memory, from the local onboard memory to the VME Bus, or from the SCSI bus directly to the VME Bus. You can also use the DMA controller to manage VME Bus memory-to-memory operations. Data moves to or from the VME Bus at rates in excess of 2.2M bytes/sec and to or from the SCSI bus at rates in excess of 1.4M

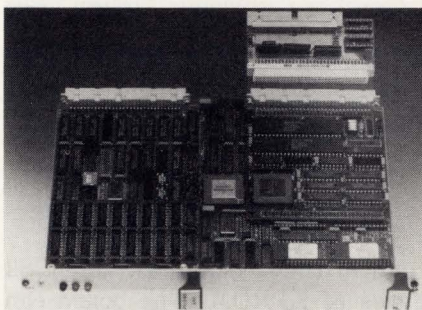

bytes/sec.

According to the company, the board can reduce the VME Bus bandwidth that's required when communicating with the SCSI bus by as much as 70%. Also, the board supports the SCSI Common Command Set, which helps ensure compatibility with a range of SCSI-bus products.

Onboard firmware provides a diagnostic tracing capability. The

trace mode provides an audit of host-CPU-to-adapter communications, plus a display of all SCSI-bus transactions.

The PT-VME400 supports the target mode of SCSI-bus operation. This mode allows the host adapter to function not only as the traditional SCSI initiator, but also as the target of communications from another host adapter on the SCSI bus. By supporting both the target and initiator modes, the PTE-VME400 allows you to use the SCSI-bus structure for high-speed, bidirectional, CPU-to-CPU communication. The PT-VME400 costs \$2095.

Performance Technologies Inc,
435 W Commercial St, East Rochester, New York 14445. Phone (716) 586-6727. TWX 650-293-8297.

Circle No 571

Optical-storage subsystems hold 1.2G bytes for Q Bus and Unibus computer systems

An LX400 Series optical-storage subsystem provides 1.2G bytes of storage for Q Bus and Unibus systems. The series comprises three major elements: the UC04/UC14 host adapter, an optical disk drive, and application software.

UC04/UC14 host adapters connect DEC's Q Bus and Unibus systems to the LX400 via the SCSI bus. The host adapters implement DEC's Mass Storage Control Protocol (MSCP), giving users transparent access to storage devices attached to the system. Other features of the UC04/UC14 include adaptive and block-mode DMA and a self-test capability.

The disk drive offers a 250k-byte/sec sustained data-transfer rate,

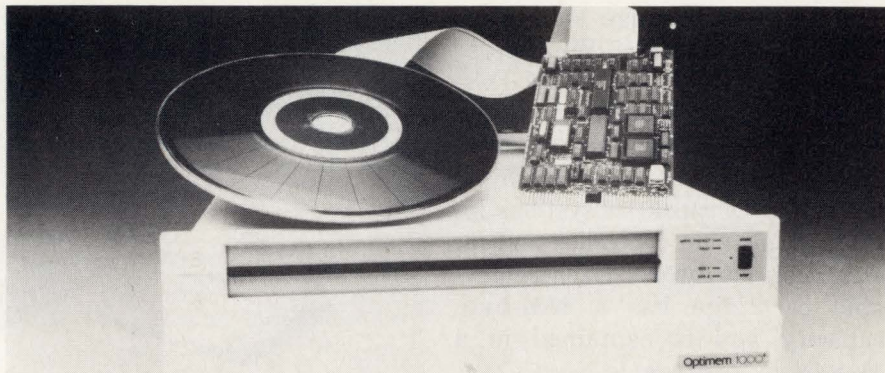

media-flaw management, and an embedded SCSI controller. The application software features on-disk, VMS-compatible directories and such capabilities as file deletion, renaming, and extending. Standard VMS utilities can gain access to the subsystem. Access from user pro-

grams is transparent. \$17,000 to \$31,000, depending upon configuration.

Emulex Corp, 3545 Harbor Blvd,
Box 6725, Costa Mesa, CA 92626.
Phone (714) 662-5600.

Circle No 572

Computers and Peripherals

Single-board μ C brings IBM PC programs to STD Bus-based computer systems

The CPU-188 is a single-board STD Bus computer that's software compatible with the IBM PC; that is, it makes the appropriate translations from PC format to STD Bus format. IBM PC software compatibility renders the computer useful as a link between the engineer's desk and the factory floor; in a typical application, the design engineer develops the desired program on the PC, downloads and tests the program on the CPU-188, and then burns the program into EPROM and runs it in a CPU-188-based target system.

The CPU-188 is based on the 80188 CPU, a 16-bit μ P that's faster than the 8088 processor. The computer is available with either the 6- or 8-MHz version of the 80188, 24 lines of parallel I/O, 1M byte of onboard RAM, two serial ports, 12

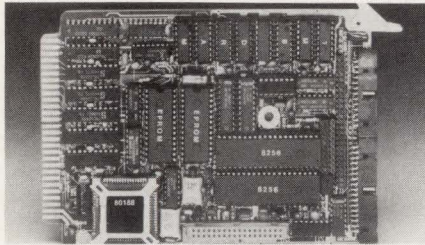

counter/timer channels, and 128k bytes of EPROM. The board can also address an additional 128k bytes of STD Bus memory, and it offers an SBX interface for piggy-backing extra functions via SBX boards.

You can connect several CPU-188s in a network, enabling and disabling specific computers via software. The network employs a multimaster approach; that is, any CPU-188 in the network can operate as a master. The CPU-188's STD Bus inter-

face can also handle 8088 or Z80 mode-2 interrupts. The board comes with a serial channel that has an RS-485 interface in addition to the standard RS-232C interface. This feature allows you to establish multidrop, asynchronous communications links with as many as 31 other RS-485 nodes.

The CPU-188's 24 parallel I/O lines interfaced with other systems via a 50-pin connector, which is Opto-rack compatible. No extra cabling is required. You can configure the CPU-188 with 64k bytes, 266k bytes, or 1M byte of RAM. Prices for the CPU-188 start at \$350 (OEM qty).

Computer Dynamics Inc, 107 S Main St, Greer, SC 29651. Phone (803) 877-8700.

Circle No 577

Internal, removable hard-disk subsystem serves IBM PC family and compatibles

The Durapak storage subsystem features removable Winchester hard-disk cartridges for IBM PCs, PC/XTs, PC/ATs, and compatible systems. Available as single-drive (15M-byte) or dual-drive (30M-byte) units, the Durapak subsystems include a bootable controller and installation hardware. Each removable cartridge has a 15M-byte capacity and is contained in a $4\frac{1}{4} \times 4\frac{3}{8}$ -in. package.

The use of hard disks results in an average life expectancy of 11,000 operating hours for each cartridge. The Durapak system combines the advantages of hard-disk technology and the ability to create extensive archives, the distinct virtue of removable media.

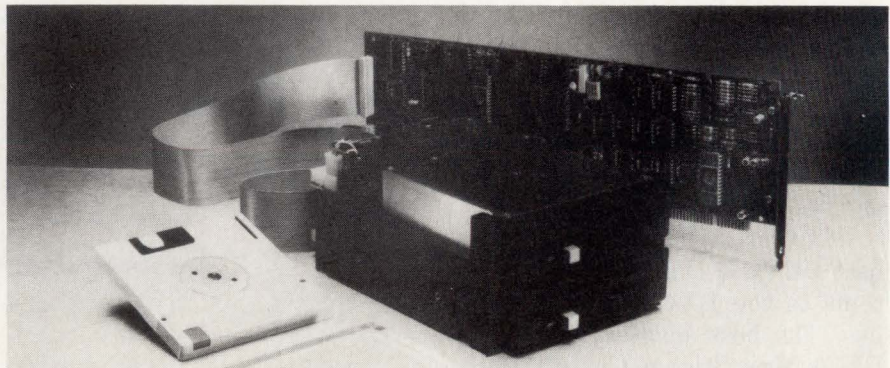

The hard-disk drive transfers data at a 7.5M-bps rate. The average access time is 85 msec, and the track-to-track access time is 13 msec. The average latency period is 8.46 msec. The soft read error rate is one per 10^9 bits, the hard read error rate is one per 10^{12} bits.

A 15M-byte system, including controller, costs \$1295. The 30M-byte system costs \$2095.

Sysgen Inc, 47853 Warm Springs Blvd, Fremont, CA 94539. Phone (415) 490-6770.

Circle No 574

The fastest SCSI controllers in the West.

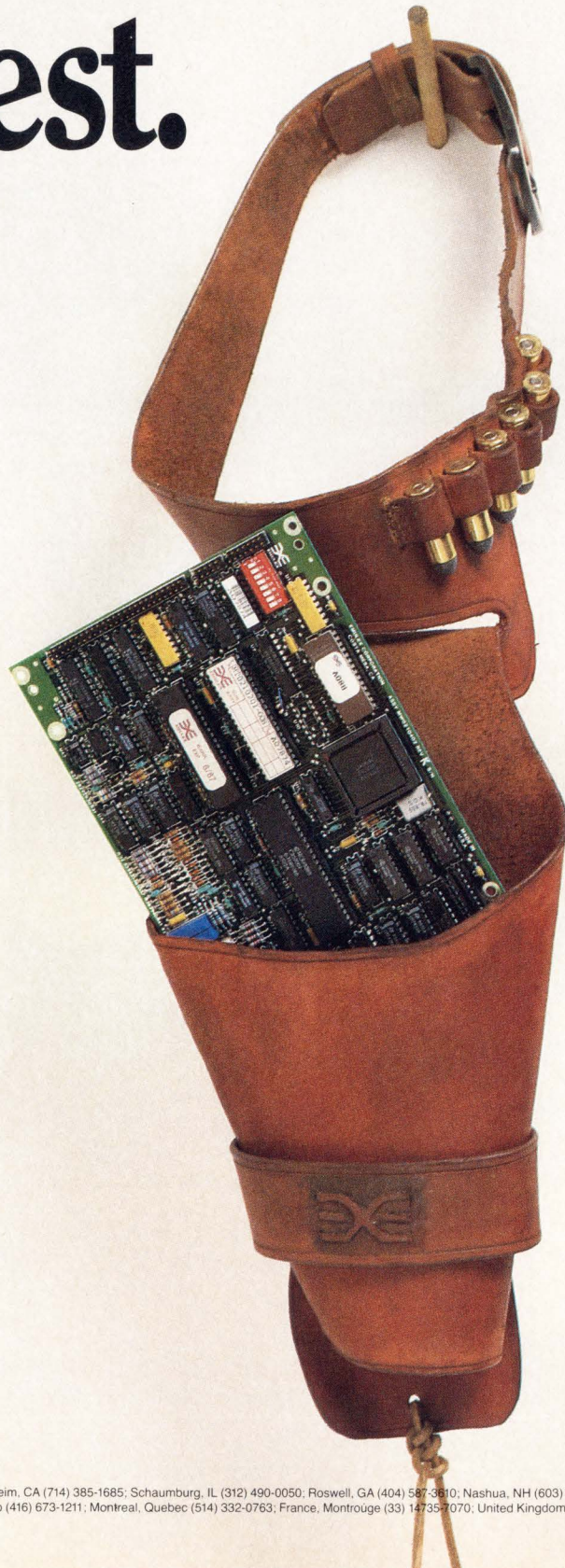

Emulex blows away the competition with lightning fast SCSI performance. Up to 24MHz disk interface transfer rates, the fastest in the industry, by using our own VLSI technology. Intelligent controller firmware for optimum efficiency, allowing overlapping operations on up to four peripherals to reduce system delays. And comprehensive implementation of the Common Command Set.

Our controllers even reduce SCSI overhead by 50% with command queuing/linking. Plus, we provide peak SCSI bus optimization with a powerful disconnect/reconnect algorithm.

EMULEX SCSI PERFORMANCE MATRIX

CONTROLLER	MT02	MT03	MD01	MD21/S2	MD23
TYPE (# of Drives)	TAPE (1)	TAPE (1)	DISK (2)	DISK (2)	DISK (4)
FIFO	16KB	16KB	16KB	32KB	64KB
LOGICAL BLOCK SIZE (Bytes)	256/512	256/512	256/512	256/4096	256/4096
CCS	N/A	N/A	NO	YES	YES
ECC	16-Bit CRC	16-Bit CRC	48-Bit	48-Bit	48-Bit
DRIVE INTERFACE SPEED	90 KBYTES	90 KBYTES	Up to 24 MBits	Up to 24 MBits	Up to 24 MBits
DRIVES SUPPORTED	QIC-36 Type	QIC-44 Type	ST506	ESDI	ESDI

With this kind of commitment to performance and efficiency, it's easy to see why Emulex is the top gun in SCSI. To find out more about our fast SCSI solutions call 1-800-

EMULEX3. In California (714) 662-5600. Or write Emulex Corporation, 3545 Harbor Blvd., P.O. Box 6725, Costa Mesa, CA 92626.



Emulex SCSI products are stocked nationally by Hamilton/Avnet, Kieruff Electronics and MTI Systems Corp.

Gotcha!

CIRCLE NO 37

We bring a new dimens



ion to performance.

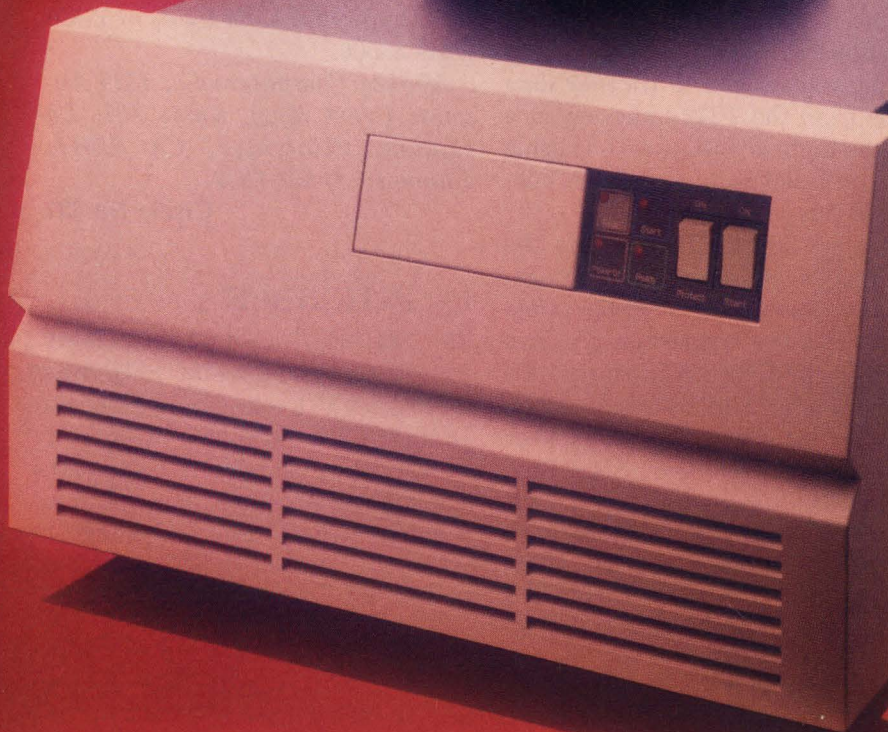
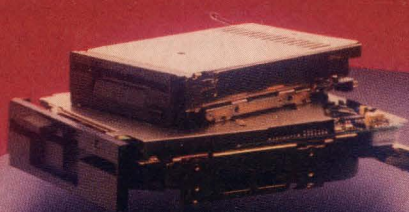

Our comprehensive line of data storage products outshines all the competition, thanks to two of Fujitsu's best ideas. Quality that is uncompromising. And reliability that is absolute.

Every Fujitsu disk and tape drive is built to the highest standard in the data storage industry. Ours.

That means you get high-performance drives without being in the dark about whether or not they'll keep performing.

Reliability is designed into every Fujitsu drive and built into every component. And we have the superior reliability ratings to prove it. In addition, Fujitsu's advanced, highly automated production and exhaustive quality control procedures assure that every product we deliver lives up to our reputation.

You won't find another manufacturer with a family of data storage products as strong as ours. Or as complete.

You can be sure Fujitsu America will have the storage devices you need. From our high-quality flexible disk drives to our famous large capacity "Eagles." Including a complete family of SCSI disk and tape drives. Superior 8-inch Winchesters that set new performance standards for the industry. Plus cost-effective streaming and cartridge tape drives.

And, at Fujitsu America, our customers are our first priority. Our fast-growing U.S. operation is proof of that. We've opened a major new manufacturing plant in Hillsboro, Oregon, dedicated to meeting your data storage requirements now, and in the future. We also provide you with full service and technical support — including training and a complete domestic repair center.

Call the company that's qualified and committed to meeting your long-term data storage requirements, at (408) 946-8777. Or write Fujitsu America, Inc., Storage Products Division, 3055 Orchard Drive, San Jose, CA 95134-2017.

Data storage products from Fujitsu America. They shed new light on the meaning of quality, reliability and performance.

WE'RE DEVELOPING TECHNOLOGY FOR YOU.

FUJITSU

FUJITSU AMERICA

CIRCLE NO 38

Computers and Peripherals

COLOR PRINTER

The MP-1300 is a 300-cps, 80-column dot-matrix printer that can convert from black-ink printing to 7-color printing. The conversion requires an optional color-printing kit, which snaps into the printer, so there's no need for special tools. The kit is compatible with Epson JX-80 color software. The MP-1300 specs a noise level of less than 59 dB and comes with 185 software-generated character sets and eight international fonts. You can also download your own character set to the printer's 10k-byte buffer. The printer spaces characters proportionally and has graphics capabilities. \$799; color-printing kit, \$155; a 136-column version, \$900.

Seikosha Co, 10080 N Wolfe Rd, Suite SW3/249, Cupertino, CA 95014. Phone (408) 446-5820.

Circle No 635



HIGH-SPEED MODEM

Capable of transmitting error-free data at 1000 cps, the Race-AF modem also lets you communicate with slower Bell 212A or 103/113 modems. To obtain the fast communication speeds, both the receiving and the transmitting modems must use the same data-compression and -flow techniques. This full-duplex modem offers an IBM PC/AT-compatible dial-up command set for computer-controlled operation.

The modem is available as the Race-AF I, a single-channel full-duplex modem, or as the Race-AF II, which adds a second, independent printer channel. This channel is statistically multiplexed with the primary keyboard/screen channel to give you simultaneous control over a

remote terminal and a printer via one dial-up connection.

You can order the unit in a standard low-profile modem case, or you can specify a small-footprint, vertical enclosure that the company calls a tower package. Race-AF I, \$1645; Race-AF II, \$1845.

Data Race Inc, 5839 Sebastian Pl, San Antonio, TX 78249. Phone (512) 692-3909. TLX 517659.

Circle No 636

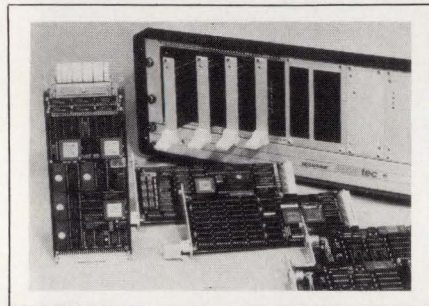

TRANSPUTER BOARD

Targeted for high-speed control and data-acquisition systems, the VTF single-Eurocard computer board contains one T414 transputer and two T212 transputers. The 17-MHz, 32-bit T414 transputer comes with 256k bytes of local memory, and each of the 17-MHz, 16-bit T212 transputers has 32k bytes of local memory. The transputers are linked to one another and to off-board devices via 20-MHz transputer links. In addition, two 16-bit parallel interfaces allow you to transfer data to or from the T212's memory at a rate as high as 50M bytes/sec using program controlled or DMA controlled burst transfers.

You can install the board in the company's 4U-high, 19-in. Mega-frame system unit, or it can stand alone with the application program residing in EPROM in the T414's memory map. Link boards are available to interface the transputer board with VME Bus, SMP Bus, and ECB Bus systems. The VTF board is optionally available with 20-MHz transputer devices. DM 12,900.

Parsytec GmbH, Julicher Stra-

se 336, 5100 Aachen, West Germany. Phone (0241) 1822275. TLX 8329659.

Circle No 583

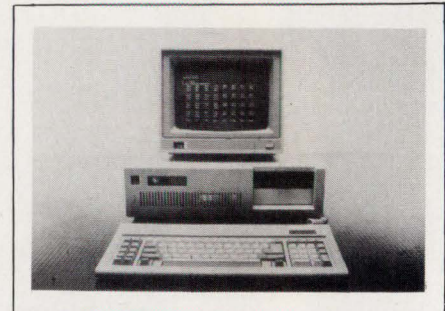

32-BIT PC

Offering 32-bit power in an IBM PC-compatible desktop unit, the MC-32 uses a 10-MHz 32032 coprocessor to produce an architecture similar to that found in VAX superminicomputers. The unit also comes with an 8088 CPU and a 32081 floating-point accelerator. It runs PC-DOS and MS-DOS software and offers Unix System V Rel 5.2 as an optional operating system. Other options include C, Pascal, and Fortran development tools, Virtual MS-DOS, a 32082 MMU, scientific subroutine libraries, and multiuser/multitasking support. A standard configuration with a parallel port, three serial ports, one 360k-byte floppy-disk drive, a 20M-byte hard-disk drive, and 1.5M bytes of RAM costs \$3500.

Mighty Computers Co, 4529 Angeles Crest Hwy, Suite 207, La Canada Flintridge, CA 91011. Phone (818) 952-8832.

Circle No 637

PC INTERFACE

The SMP-E570-A1 interface allows you to control an 8-bit SMP Bus industrial I/O subsystem from an IBM PC, PC Portable, PC/XT, or PC/AT, or a compatible computer. The interface comprises one plug-in card for the PC bus and another plug-in card for the SMP Bus, linked by a 1.5m-long, 50-way ribbon cable. The PC operates as the bus

MASTERSTROKE.

Powerful, single board imaging and graphics systems for the VMEbus.

A requirement for high performance graphics or imaging is no longer a limitation for designers who are building on strengths of the VMEbus. Matrox has brought its video board expertise to the VMEbus with two powerful new single board products. You'll know them as the masterstroke. Call us, and you'll understand why.

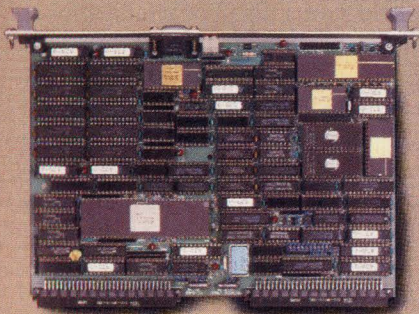

VG-640 Color Display Processor

- Versatile high level 2D/3D command set
- $640 \times 480 \times 8$ bit resolution
- 256 colors from a palette of 262,144
- 32/16-bit display list processor
- 35,000 vectors/second drawing speed
- single VME dual height board

VIP-1024 Real-Time Image Digitizer

- Single board input, output, storage
- $1024 \times 1024 \times 8$ bit frame buffer
- $512 \times 512 \times 8$ bit display resolution
- Internal or gen-lock sync capability
- 8 bit flash frame grabber
- 256 colors from a palette of 16.7 million



matrox

1055 St. Régis,
Dorval, Quebec, Canada H9P 2T4
Tel.: (514) 685-2630 Telex: 05-822798
Toll-free no.: 1-800-361-4903

Computers and Peripherals

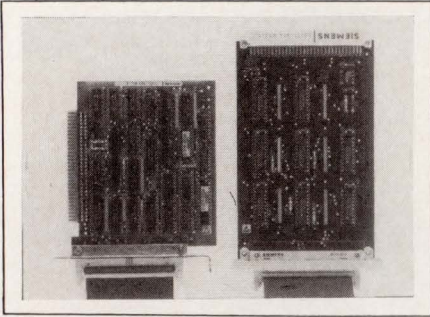

master for the SMP Bus system, but you can still use SMP Bus I/O cards, which provide onboard slave-CPU functions.

The interface maps the SMP Bus system into 64k bytes of the PC's memory space and 256 bytes of its I/O space. The interface supports direct and memory-mapped I/O operations from the PC to the SMP Bus, and DMA transfers to and from the SMP Bus system using the PC's DMA controller. Jumper links on the PC-bus card allow you to set between one and seven wait cycles for SMP Bus accesses, to set up interrupt channels (IRQ2 through IRQ7), and to set the location of the SMP Bus's memory, memory-mapped I/O, and direct I/O in the PC's address map. You can also select the frequency of the SMP Bus master clock to be 1× or 0.5× the PC's clock frequency. You can interface as many as four SMP Bus systems to one PC. The SMP-E570-A1 costs DM 1875.

Siemens AG, Zentralstelle für Information, Postfach 103, 8000 Munich 1, West Germany. Phone (089) 2340. TLX 5210025.

Circle No 584

3½-IN. WINCHESTER

Featuring 40M bytes of storage capacity, the 3540 drive is a half-height, 3½-in. hard-disk drive that weighs 2 lbs and consumes 12W. Its average access time is 40 msec, and the track-to-track access time is 9 msec. The drive is compatible with ST-506 and ST-412 interface standards. The unit measures 1.6×4×5.75 in. and specs an MTBF of 20,000 hours and an MTTR of 20

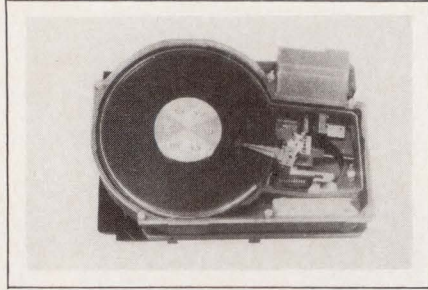

minutes. The recording density is 13,171 bpi, and the track density is 1019 tpi. \$1000.

C Itoh Electronics Inc, 5301 Beeethoven St, Los Angeles, CA 90066. Phone (213) 306-6700.

Circle No 638

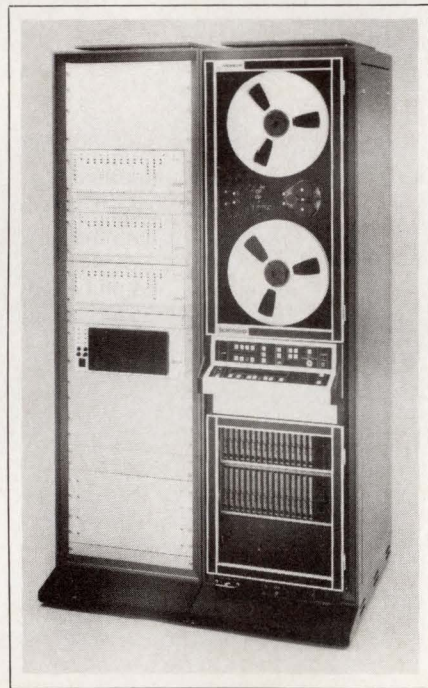

DIGITAL RECORDER

By adjusting its tape speed within the range 178 to 240 in./sec, the SE9000 digital instrumentation recorder automatically adjusts itself to suit the data rate required by a connected processor. In its data-on-demand mode, the recorder can connect directly to the processor system's clock, after which the recorder automatically selects a tape speed that keeps data output synchronous with the clock signal, to avoid overload of the processing system's input buffer.

For one recording mode, you only

need to select the required bit-packing density, and the recorder then reads the incoming data and calculates the tape speed necessary to maintain a constant data density on the tape. Subsequent variations in data rate result in the recorder's increasing or decreasing the tape speed to maintain the data-packing density.

Standard facilities include wideband-direct and wideband-group-2 FM recording at standard IRIG (Inter-Range Instrumentation Group) tape speeds, and IEEE-488 and RS-449 interfaces. You can cascade SE9000 recorders, and you can use the SE9000 with the company's SE9500, 9502, and 9503 data formatters. From approximately £40,000. Delivery, 16 weeks ARO.

Thorn EMI Datatech Ltd, Spur Rd, Feltham, Middlesex TW14 0TD, UK. Phone 01-890 1477. TLX 23995.

Circle No 585



LAP COMPUTER

The T1100 Plus weighs less than 10 lbs and can run programs almost twice as fast as IBM's PC Convertible. Based on a 7.16-MHz, 16-bit 80C86 CPU (the convertible uses a 4.77-MHz 80C88), the T1100 Plus comes with MS-DOS 2.11, an ac adapter, two 3½-in., 720k-byte disk drives, 256k bytes of RAM, parallel and serial ports, an 81-key keyboard, and an 80 character×25-line LCD.

The unit measures 12.1×2.6×12 in.; IBM's Convertible is 20% larger and 22% heavier. The T1100 Plus runs for eight hours on a recharge-



The 200°C, 16-Bit Computing Solution.

Room temperature computing applications are usually pretty easy. But, when you start running into severe, high-temperature environments, sometimes problems develop. Our new Hybrid Microcomputer System can solve most of those problems before they start. It's just as comfortable at 200°C as it is at -55°C, and it's right at home with those tough temperature-critical, Hi-Rel, Military, and High-Performance Commercial applications.

It's a *complete* and *self-contained* 8088-based 16-bit microcomputer system. This fully CMOS high-performance stand-alone system includes the 16-bit 8088 microprocessor, a crystal clock oscillator, buffering, hardware UART, monitor, power-on reset, 16 Kbytes of CMOS EEPROM, and 16 Kbytes of CMOS RAM, all housed in a neat little standard 40-pin package. The system draws only 50mA from a +5 volt source (30mA when it's asleep), and has a memory access time of 250 nanoseconds.

Best yet, it's easy to use. Its powerful built-in terminal monitor lets you hook the module up to a terminal, apply power, and start talking to the computer. After you get familiar with the system, just turn off the monitor and write your software to any standard 16K EEPROM, then debug it.

Software can be developed on any IBM PC or PC clone. Once written, debugging and downloading is extremely easy. Programming, too, is easy and can be done "on the fly" with the software that's in the module. The module is compatible with the IBM PC Assembler, and with the proper BIOS written, it's completely PC compatible.

If you need more memory, the system can be expanded up to 1 Mbyte using our 8kx8, 16kx8, 32kx8, 64kx8, 128kx8, or 256kx8 memory modules. The system is also completely compatible with all our I/O and Data Acquisition modules. So, with little effort, you can interconnect a number of modules and come up with a wide variety of data acquisition and control functions. Factory control, aircraft and avionics, precise measurements, data conversion, and even as a building block for a smart controller.

Package design is also flexible. The module is available in ceramic, a hermetic metal DIP, and a hermetic metal flat-pack. And, if you don't need the 200°C, you can get the -65°C to +125°C version to satisfy a wide range of Military applications.

Call or write us for your solution. *Remember, we speak fluent hybrid.*

 **Bowmar/White Technology**

4246 E. Wood Street • Phoenix, Arizona 85040 • (602) 437-1520 • TWX 910-951-4203

CIRCLE NO 48

Computers and Peripherals

able NiCd battery. With 256k-byte RAM, \$1999; with 640k-byte RAM, \$2399; external 5¼-in. floppy-disk drive, \$499; additional 384k-byte memory card, \$499; 5-slot I/O expansion bus, \$999; 300/1200-bps modem card, \$399.

Toshiba America Inc, Information Systems Div, 2441 Michelle Dr, Tustin, CA 92680. Phone (714) 730-5000.

Circle No 639

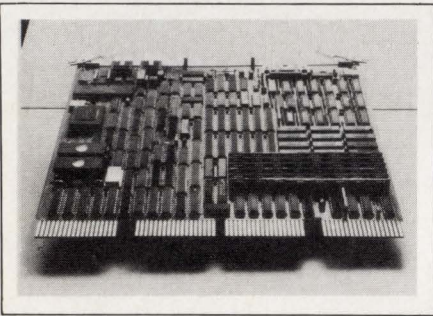

GRAPHICS BOARD

The Supervisor SBD-C is a Q Bus-compatible color-graphics board for use with DEC MicroVAX II computers. It provides 1280×1024-pixel color graphics at a 60-Hz noninterlaced refresh rate. For applications requiring higher resolution, you can modify the board to provide 2560×1024-pixel resolution. It contains almost 2M bytes of onboard memory, providing double-buffered display storage and segment storage, plus sufficient memory for system setup and onboard graphics software.

Host software available includes DMA device drivers and host-system graphics libraries for MicroVMS, Unix, and VAX-ELN, plus a GKS level-2b implementation for a MicroVAX or VAX host. Supporting software is also available for VMS, RSX11-M, and RT11. The board also supports the company's Glida interactive graphics editor software, which runs under RT11, RSX, VMS, and Micro-VMS. Also available are a Unibus version of the board and a version with its own Ethernet interface for networked systems. £3500.

Gresham Lion (PPL) Ltd, Lower Way, Thatcham, Berkshire RG13 4RE, UK. Phone (0635) 68686. TLX 847417.

Circle No 586

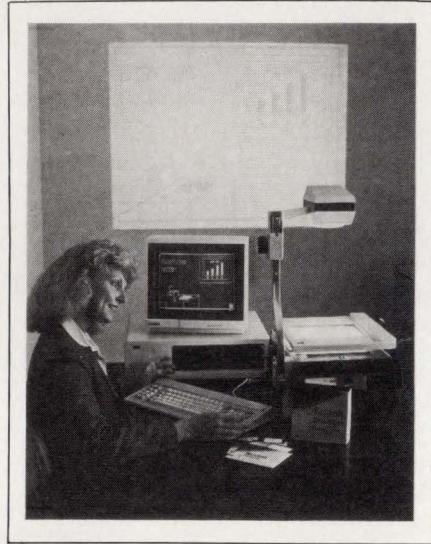

PC-IMAGE PROJECTOR

By producing electronic transparencies, System 10 lets you display computer-generated text and graphics on a standard overhead projector. The unit includes an LCD panel, an infrared remote-control device, and embedded operating software. You place the unit's LCD panel directly on the glass platen of an overhead projector. An interface lets you use the RGB output of any IBM-compatible PC for remote control of images on the LCD. The system includes software that lets you manipulate images during a presentation; it lets you employ split screens, image reductions, highlighting, and image sequencing. The portable LCD panel and remote-control device fit into a briefcase. \$1300.

Eastman Kodak Co, 343 State St, Rochester, NY 14650. Phone (716) 724-4980.

Circle No 640

SERIAL I/O BOARD

Incorporating an onboard 10-MHz 68010 μ P and 128k bytes of dual-port RAM, the SYS68K/ISIO-2 dou-

ble-Eurocard board for VME Bus systems is an intelligent serial I/O controller that handles eight RS-232C or RS422 serial ports. The μ P, operating with zero wait states, can run communications software either from the board's 128k-byte EPROM area, or from the dual-port RAM. The RAM also provides communication with the host processor, and the board contains a VME Bus interrupter capable of generating four different interrupt signals with software-programmable interrupt levels and vectors.

The eight serial I/O channels are routed to the board's P2 connector,

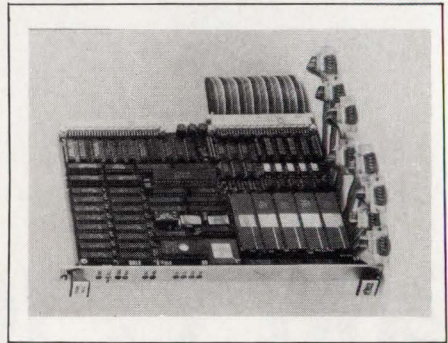

and each channel supports the request-to-send (RTS), clear-to-send (CTS), data-set-ready (DSR), data-terminal-ready (DTR), and data-carrier-detect (DCD) signals in addition to Rx and Tx data lines. Each channel is software programmable to operate at baud rates from 50 to 38,400 baud; synchronous data rates as high as 4M bps are possible. DM 5245.

Force Computers GmbH, Daimlerstrasse 9, 8012 Ottobrunn, West Germany. Phone (089) 600910. TLX 524190.

Circle No 587

Force Computers Inc, 727 University Ave, Los Gatos, CA 95030. Phone (408) 354-3410.

Circle No 588

40M-BYTE TAPE DRIVE

Suitable for use with your IBM PC or with a compatible computer, the TD440 gives you ¼-in.-tape storage to back up your hard-disk drive. It emulates a hard-disk drive and re-

Computers and Peripherals

sponds to all DOS 2.x and 3.x commands. Because it's DOS compatible, you can use it for extended data storage of large spreadsheets or databases.

You can run programs directly from tape; no backup utilities are required to store data from an application program. However, the drive comes with a sector-by-sector backup utility that backs up a full 10M-byte hard disk in approximately 10 minutes. After backup, you can access data on a file-by-file basis using DOS commands. You can format each tape cartridge into one 32M-byte logical drive or two 17.8M-byte logical drives. Error-correction techniques conform to the QIC-100 format. \$1490.

Advanced Digital Information Corp, Box 2996, Redmond, WA 98073. Phone (206) 881-8004. TLX 350830.

Circle No 641

PC/XT COMPATIBLE

The IBM PC/XT-compatible Cyborg-M computer furnishes an 8088 CPU that operates at 4.77 MHz. The computer's mother board contains 256k bytes of RAM, which you can expand to 640k bytes. The mother board also contains a floppy-disk controller, which operates with as many as two 5¼-in. disk drives. The computer's video-display controller drives either monochrome or color monitors. The monochrome monitor displays a screen of 720×400 pixels and the color monitor displays 320×200 pixels in as many as 16 colors.

The manufacturer supplies the Phoenix BIOS software as well as Basic in ROM chips that plug into the mother board. An extra socket lets you insert an 8087 math coprocessor chip in the computer. The computer offers standard features, such as an 83-key keyboard, a battery-backed clock calendar, a parallel Centronics-compatible port, and an RS-232C I/O port. Seven IBM PC-compatible expansion slots let

you add extra disk controllers and peripheral-interface boards. The manufacturer has FCC approval for the computer. With 256k bytes of RAM, two floppy-disk drives, and a monochrome monitor, \$800.

Samchang Electronics Inc, 63-1, 3KA, Choong Jeong-Ro, Seodaemun-Ku, Seoul, Korea. Phone (02) 392-6611. TLX K28168.

Circle No 589

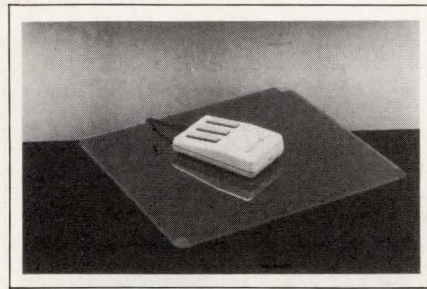

ELECTRONIC MOUSE

Featuring onboard μ Ps that provide processing power and program memory, the SummaMouse can both receive and send data, which simplifies repair of the mouse. The mouse can respond to variable data formats, and it specs a resolution of 100 dots/in. and a life expectancy of 2000 mi. Its driver and menu-selection system provide an interface for software programs such as Lotus 1-2-3 and Wordstar. This electronic mouse uses light reflecting from a special pad to sense motion. The unit is quiet and requires no periodic maintenance. \$119.

Summagraphics Corp, 777 State St Extension, Fairfield, CT 06430. Phone (203) 384-1344. TLX 964348.

Circle No 642

MODEM

The Smart Link 1200B modem is available on a half-size card that fits in a short slot in IBM PCs, PC/XTs, PC/ATs, and many IBM-compatible computers. The modem is compatible with standard Hayes software commands, and it supports most standard communication programs, such as Crosstalk, PC-Talk, and Smartcom. The modem operates as

a standard Bell-103 or -212A device and it features autodial, autoanswer, and bit-rate-selection capabilities. The circuits are compatible with pulse- or tone-dialing systems. \$75 (100).

Link Technology Corp, second floor, No 1, Alley 8, Szu-We Lane, Chung-Cheng Rd, Hsin-Tien, Taipei, Taiwan, ROC 23136. Phone (02) 918-9281. TLX 22352.

Circle No 590

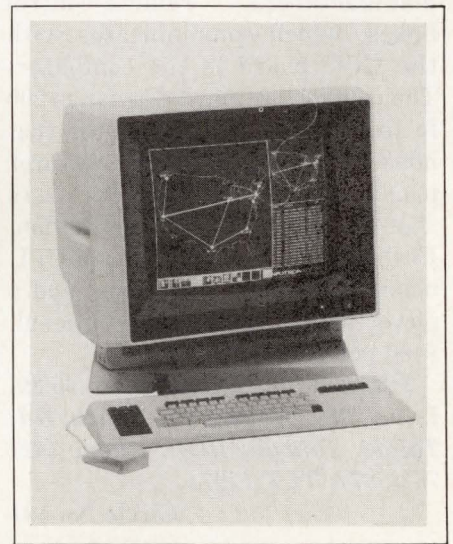

LAN MANAGER

Allowing T1 users to manage their networks from a single point via a multifunction, high-resolution color graphics μ C, the INM integrated network manager can manage both backbone and access networks. It detects existing and potential problems, isolates faults, and restores the network via automatic alternate routing. The menu-driven interface uses a mouse for feature selection. The manager has multitasking capabilities for concurrent network monitoring, diagnostic test initiation, and parameter alteration. For real-time graphic display of the network and site, the user controls windows that monitor these concurrent functions. \$85,000 to \$120,000.

Infotron Systems Corp, Cherry Hill Industrial Center-9, Cherry Hill, NJ 08003. Phone (800) 345-4636 or (609) 424-9400.

Circle No 643

Computers and Peripherals

MULTIUSER ADAPTER

The Ours expansion system lets you expand an IBM PC/XT or PC/AT computer to serve as many as eight simultaneous users. The expansion system includes a CPU board and a remote control box for each user. The plug-in board occupies one expansion slot in the computer, and it provides the user with an 8088-compatible CPU and as much as 704k bytes of RAM. Each user also requires a terminal and one of the manufacturer's remote-control boxes, which communicates with the CPU board in the computer. The control box may be as far as 200 ft from the central computer that houses the CPUs. The manufacturer provides software that lets users share peripherals and information. Each multiuser set includes a CPU board, a remote-control box, and a power supply. Cables are optional. \$400 per user.

Plustek Inc, second floor, No 29, Lane 308, Koung Fu South Rd, Taipei, Taiwan, ROC. Phone (02) 752-6874. TLX 11974.

Circle No 591

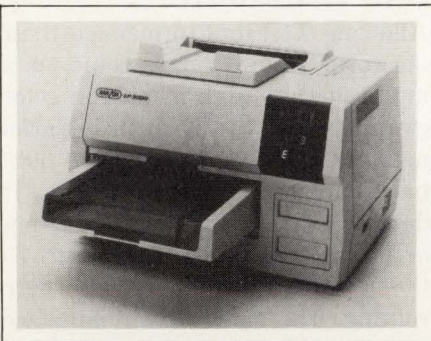

LASER PRINTER

Capable of printing full-page bit-mapped graphics with a resolution of 300×300 dots/in., the LP-3000 laser printer supports the full IBM graphics character set and emulates the HP Laserjet and Laserjet+, Diablo 630, and Epson FX-80. The printer has six standard fonts: Courier 10, Courier 10 Italic, Prestige Elite, Compressed (16.67 cpi), Times Roman PS, and the IBM Character Set. You can order addi-

tional fonts as options on cartridges. The buffer memory is expandable to 2M bytes. In addition, the unit can print eight pages per minute in either landscape or portrait mode. The paper tray holds 250 sheets; pages are automatically collated. From \$3980, with 512k bytes of RAM.

Hanzon Data Inc, 18732 142nd Ave NE, Woodinville, WA 98072. Phone (206) 487-1717. TLX 317899.

Circle No 644



RISC

Offering a computational speed of 4.5 MIPS, Model 840 is a reduced-instruction-set computer (RISC) for engineering applications that require high performance. The computer uses a Unix-based operating system that adheres to AT&T's System V interface definition. The 840 links the manufacturer's CAD and CAE systems with its computer-integrated-manufacturing (CIM) systems. The computer features industry-standard networking, graphics, languages, and databases. From \$113,500.

Hewlett-Packard Co, Box 10301, Palo Alto, CA 94303. Phone (415) 857-1501.

Circle No 645

HARD-DISK CARDS

This family of hard-disk cards ranges from a 20M-byte AT Backup DiskCard to the 60M-byte Hard DiskCard. The boards offer 60- to 80-msec average access speeds at 5M- and 7.5M-bps transfer rates. Each board comes with software, cables, and instructions. When

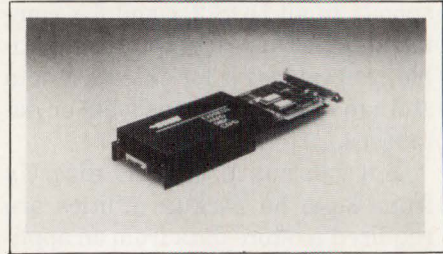

power is on, the boards have between 6 and 8g shock resistance; when power is off, their shock resistance is 50 to 60g.

Using the company's Coalesce software, you can add the 20M- or 30M-byte card to a computer that contains a hard disk. When combined, the two units work together as one disk and provide as much as 144M bytes of hard-disk capacity. The company's backup disk card comes with Auto DiskSave software, which lets you identify backup files by date, time, archive bit, subdirectory, file name or groups of files, or any name combination using DOS wild Cards. All Hard DiskCards include the DS Backup program. AT Backup DiskCard, \$449; Hard DiskCard, \$1095.

Express Systems Inc, 1254 Remington Rd, Schaumburg, IL 60195. Phone (800) 341-7549; in IL, (312) 882-7733.

Circle No 646

VIDEO BOARDS

The RTI-400 Series includes the PX-401V intelligent pipelined pixel processor, the AS-401V analog subsystem for video inputs and outputs, and two image-memory boards, the DS-401V and the DS-441V, for machine vision and image processing. The PX401V is a 10-MHz, 16-bit, pipelined pixel processor that performs arithmetic operations, such as AND, OR, and XOR, as well as conditional processing operations. It also features a 12-bit multiplier and a 16-bit look-up table for high-precision linear and nonlinear operations on 8- and 16-bit data streams.

The AS-401V analog subsystem digitizes images to a 512×512-pixel

Computers and Peripherals

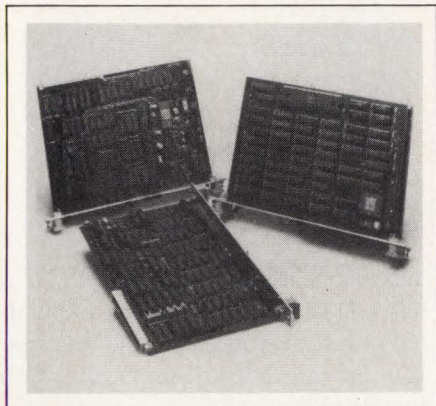

resolution with 8-bit accuracy. The analog subsystem accepts analog signals from as many as four devices, such as cameras or videocassette recorders. Input and output look-up tables provide point-processing operations and input-signal correction. An output look-up table lets you select a 1024-pseudocolor palette from more than 16 million colors. Two separate memory boards are available.

The DS-401V stores one 512x512x8-bit image; the DS-441V stores four. Both memory boards feature hardware pan and scroll on a per-pixel basis. A typical vision-engine subsystem consists of one AS-401V, one PX-401V, and three or four frame stores. The RTILIB/400 software is a real-time image-processing and machine-vision subroutine package that contains more than 300 C-callable routines. PX-401V, \$3495; AS-401V, \$2995; DS-401V, \$2495; DS-441V, \$3495; RTILIB/400, \$1500.

Recognition Technology Inc, 335 Fiske St, Holliston, MA 01746. Phone (617) 429-7804.

Circle No 647

VME CPU BOARD

Incorporating 68000 or 68010 processors, the CPU-6 Series offers 512k bytes of dedicated onboard dynamic RAM that allows zero-wait-state operation at 8 MHz and 1-wait-state operation at 12.5 MHz. All software that executes on the manufacturer's CPU-1 computer also runs on the CPU-6 Series without

modification. Four 28-pin JEDEC sockets accommodate high-density 27512 EPROMs or byte-wide static RAMs. The EPROMs supply as many as 256k bytes of user and system memory. Three RS-232C serial ports and one parallel port accommodate external I/O devices. The computer includes firmware that supplies a 16k-byte monitor

and a line-at-a-time assembler/disassembler. \$1845.

Force Computers Inc, 727 University Ave, Los Gatos, CA 95030. Phone (408) 354-3410.

Circle No 648

VISION SYSTEM

Designed for use with an IBM PC,

Bubble-cassette memory systems from Bubbl-tec®

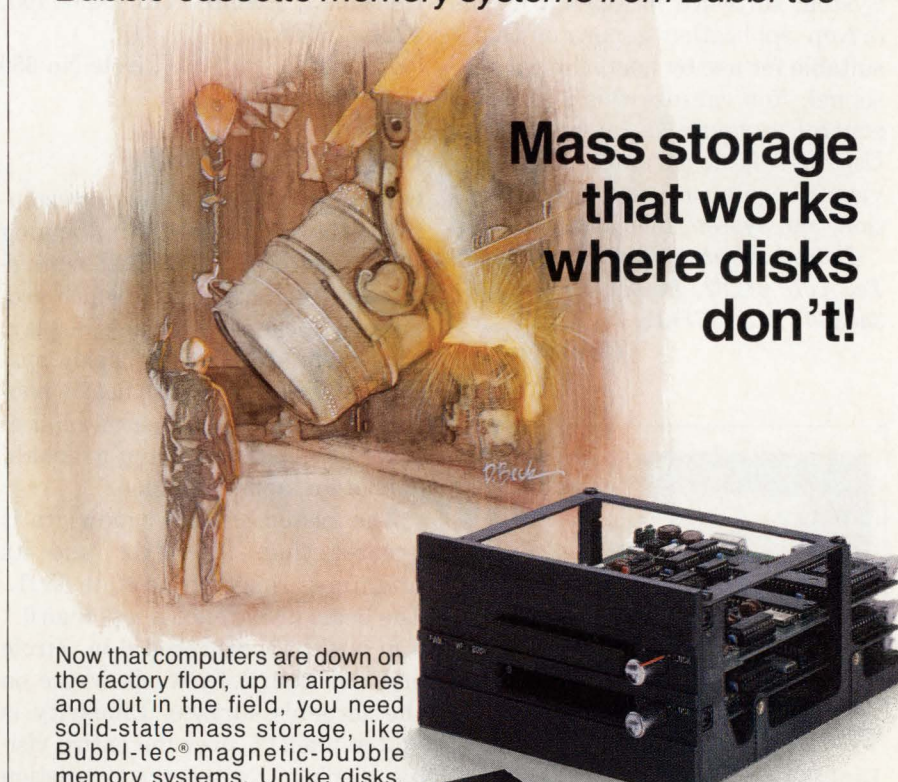

Mass storage that works where disks don't!

Now that computers are down on the factory floor, up in airplanes and out in the field, you need solid-state mass storage, like Bubbl-tec® magnetic-bubble memory systems. Unlike disks, they stand up to the dirt, dust, temperature extremes, shock and vibration that plague real-world computing.

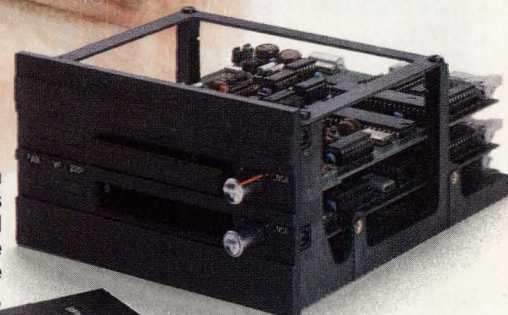

BDH-1 BUBBL-DEK™
Up to 2 Mbytes in popular 5 1/4" format. Uses non-volatile, plug-in BUBBL-PAC® cassettes.

Bubbl-tec systems provide battery-free, non-volatile mass storage from 128 Kbytes to 32 Mbytes, with extremely fast access to every data block. Many of these systems plug directly into your microcomputer bus — no extra chassis or power supply.

Since 1979, we've been shipping systems for every popular micro bus. In fact, we have more systems in the field than any other bubble-system supplier. Systems are now available for Q®, MULTI™ STD, VERSA™ VME and IBM® PC buses.

Send today for your free catalog. Our mass storage solutions have a solid foundation.

BUBBL-TEC INTERNATIONAL DISTRIBUTORS:

France: Sacasa (1) 46.30.68.39 • Italy: Telcom 02-404-7648 • Japan: Marubun Corp. 03-6399857 • Netherlands: Diode B.V. 030-884214 • Norway: HCA Melbye 02-106050 • Sweden: TH Elektronik AB 08-362970 • Switzerland: Micro-System-Technik, AG 01-4920355 • U.K.: Amplicon, Ltd. 0273-608331 • West Germany: Scantec GmbH 089-859-8021

Bubbl-tec and BUBBL-PAC are registered TMs of PC/M, Inc. MULTI-bus is a registered TM of Intel Corp. VERSAbus is a Motorola, Inc. TM. Q-Bus is a registered TM of Digital Equipment Corp. IBM is a registered TM of International Business Machines.



Division of PC/M Inc.

6805 Sierra Court
Dublin, California 94568
Telephone: 415/829-8700
TWX/Telex: 910-389/6890

Computers and Peripherals

PC/XT, or PC/AT, or with a compatible computer, the Viewflex vision system provides a hardware and software package that allows your computer to process visual data and recognize as many as 255 objects in a single scene. A control box included with the system has a frame digitizer and I/O ports suitable for an industrial environment. The digitizer can address 64,000 pixels with 64 levels of gray scaling. System software includes a menu-driven application generator that's suitable for use by nontechnical personnel. You can use this system to control as many as four cameras. User-definable parameters include visual resolution, feature extraction, and system tolerances. \$6000.

Eshed Rbotec Ltd, Box 28346, Tel Aviv 61282, Israel. Phone (03) 340860. TLX 361131.

Circle No 649

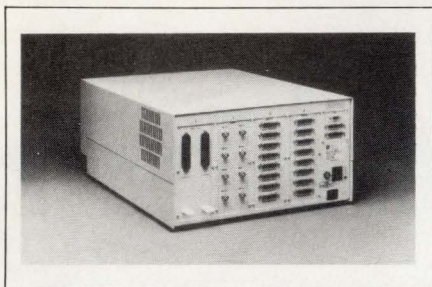

TOKEN-RING SERVER

Linking as many as 64 terminals, hosts computers, and other devices to a token-ring LAN, the CS/1-TR communications server uses an IEEE 802.5 Multibus token-ring network controller, based on the TMS380 VLSI token-ring chip set. The server supports any mix of as many as four I/O options, including I/O modules with eight or 16 RS-232C ports, eight 3270-compatible, coaxial, Type A ports, and bisynchronous and bit-synchronous RS-232C ports.

In a 64-port configuration, servers can allow as many as 16,640 users to communicate on one ring, based on a 260-node maximum per ring. The unit also lets you implement password security, broadcast

messages among users, and select parameters for individual ports. Its network-management features include onboard collection and display of CPU and buffer utilization, traffic errors at either the port or ring level, and provisions for call queuing and automatic flow control. The 64-port version, \$16,000; controller board, \$2000.

Bridge Communications Inc, 2081 Stierlin Rd, Mountain View, CA 94043. Phone (415) 969-4400. TLX 176544.

Circle No 650

COLOR MONITOR

Offering 1600x1280-pixel resolution, the MX-4190 19-in. analog RGB monitor has a 60-Hz noninterlaced refresh capability, which provides a flicker-free image display. This raster-scan color display system offers displays with nearly photographic quality, for such applications as CAE, computer graphics, animation, and simulation.

The system's video bandwidth is greater than 160 MHz, and its brightness ranges from 40 to 55 fL. The beam divergence is less than 0.1 mm within a centered 6-in. circle and less than 0.4 mm elsewhere on the screen's surface. Linearity is better than 1% over the entire visible display. Raster-size regulation is 0.5% overall, from 0 to 100% APL (average-picture-level). For CAE applications, the monitor's high dimensional accuracy lets you take measurements directly from the screen. \$5995.

Monitronix Corp, 2971 Silver Dr, Columbus, OH 43224. Phone (614) 262-0334.

Circle No 651

10-MHz COMPUTER

Offering a 25% improvement over the IBM PC/AT, the pc-286 contains a 10-MHz μ P, but also provides a 6-MHz mode for full software compatibility with the slower, original version of the PC/AT. The basic unit

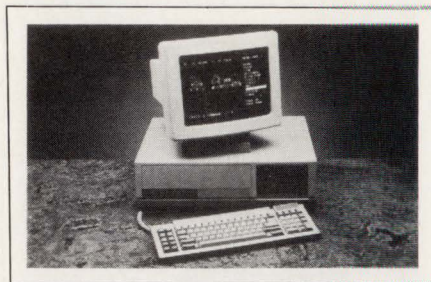

has 1.2M bytes of memory, expandable to 81.2M bytes of disk storage. It's also hardware compatible with the PC/AT.

Standard features include Microsoft MS-DOS 3.1, GW-Basic 3.1, a choice of keyboard layouts, 640k bytes of RAM, eight expansion slots, a real-time clock with battery backup, an RS-232C port, and a parallel port. You can configure a computer with a combination of 1.2M-byte, half-height floppy-disk drives; 20M-byte, half-height hard-disk drives; and 40M-byte, full-height hard-disk drives. \$2499 to \$4199.

Wyse Technology, 3571 N First St, San Jose, CA 95134. Phone (408) 433-1000. TLX 3719730.

Circle No 652

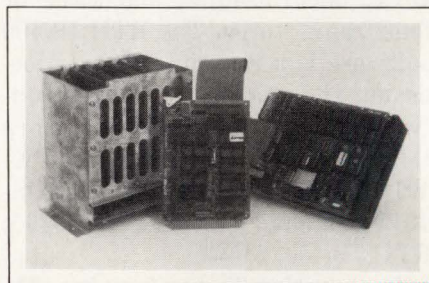

SCSI I/O PROCESSOR

The SCSI/IOP, an intelligent I/O processor, adds real-time control and measurement capabilities to computers that furnish a SCSI interface. The processor plugs into a normal STD Bus card cage and controls STD Bus I/O boards, such as A/D converters, video-display controllers, speech synthesizers, and network interfaces. To use the SCSI/IOP, you need a SCSI host adapter. (These low-cost adapters are available for many system architectures, including the IBM PC,

Computers and Peripherals

DEC, Multibus, and VME Bus architectures.)

SCSI bus arbitration allows as many as eight host computers and processors to share resources. The processor includes a 4- or 6-MHz Z80 μ P, eight byte-wide memory sockets that can accommodate as much as 64k bytes of EPROM or RAM (or combinations thereof), and a Z80 family counter/timer controller. An NCR 5380 SCSI protocol controller with ANSI X3T9.2 SCSI compatibility provides the interface to the SCSI bus. Basic firmware operations include reading and writing I/O-port data, creating and suspending tasks, and initializing the device. The processor implements the STD Bus's vectored-interrupt structure. It provides both the SCSI initiator and target functions, including the peer-to-peer message function. STD Bus SCSI/IOP with 4k bytes of EPROM and 2k bytes of RAM, \$95 (100).

Ampro Computers Inc, Box 390427, Mountain View, CA 94039. Phone (415) 962-0230. TLX 4940302.

Circle No 653

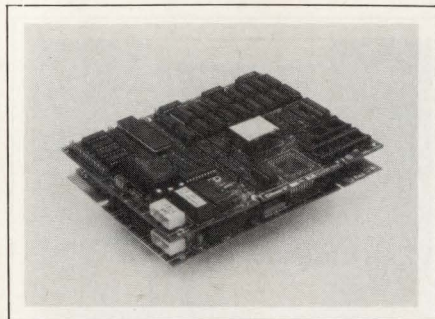

COMPUTER

A 2-board microcomputer and a multitasking operating system together occupy nearly the same space as a half-height 5¼-in. disk drive. The 2-board set comprises the Little Board/186 single-board computer and the Expansion/186 daughter board. Measuring 5.75 x 7.751 in., the board set includes an 8-MHz 80186 CPU, 1M byte of RAM, 128k bytes of EPROM, four serial ports (RS-232C or RS-422), a

floppy-disk controller, a SCSI bus interface, a printer port, an 8087 math coprocessor, a battery-backed real-time clock, an I/O expansion bus, and asynchronous or synchronous protocols.

The multitasking operating system is Concurrent DOS 4.1 (Goodall Computer Systems, San Francisco, CA). You can use unmodified MS-DOS programs and many IBM PC applications that don't access video RAM or logic. Little Board/186 and Expansion/186, \$895; Concurrent DOS 4.1, \$250 (2-user version) and \$300 (4-user version).

Ampro Computers Inc, Box 390427, Mountain View, CA 94039. Phone (415) 962-0230. TLX 4940302.

Circle No 654

SCSI OPTICAL DRIVE

Providing 200M bytes of storage on each side of a removable, write-once optical disk, the SCSI 5984 disk drive also supports the entire SCSI Common Command Set (CCS). This feature allows you to use existing driver codes as a foundation for specific applications, thus reducing system-development time. Features include 1:1 interleaving, multitrack buffering, a data-transfer rate of 2.2M bps, and a 195-msec average access time.

The unit contains a proprietary error-correction-code (ECC) chip that can correct as many as 24 bad bytes per sector while using 9.4% overhead. To facilitate data transfer between incompatible computers, this SCSI storage system can read and write optical-disk cartridges used in any of the manufacturer's other 5¼-in. optical drive systems. You can connect as many as four drives to a single controller. A SCSI 5984 system evaluation kit, including a drive, controller, optical-disk cartridge, and software tools, costs \$5000. Drives, \$975 to \$3400; controllers, \$350 to \$650 (both OEM qty).

Optotech Inc, 770 Wooten Rd,

Suite 109, Colorado Springs, CO 80915. Phone (303) 570-7500. TLX 592966.

Circle No 655



FILM RECORDER

Providing internal vector-to-raster processing, the Turbograph 2100 translates graphics data from your host computer system and records the data as images on photographic film, allowing you to make slides or prints of your computer-generated graphics. You can connect the Turbograph to your host computer via an RS-232C interface. A digital controller in the recorder then converts the computer image into a 2048 x 2048-pixel raster format and sends the rasterized image to a digital film recorder. The unit uses Kodak Ektachrome, Polaroid Polachrome, and Polaroid Polacolor ER film. \$6995. Delivery, 60 to 90 days ARO.

AMF Logic Sciences Inc, 10808 Fallstone Rd, Houston, TX 77099. Phone (713) 879-0536.

Circle No 656

OPTICAL STORAGE

This optical-storage peripheral, the OAS 4300, requires no changes to host hardware or software. The unit operates in three application modes: on-line, off-line, and pass-through. In its on-line mode, the OAS 4300 appears to the host as a tape formatter and drive and uses standard I/O commands. In its off-line mode, the OAS 4300 lets you control tape-to-disk and disk-to-tape data transfers without host intervention, using menu-driven software accessed

Computers and Peripherals

through the OAS terminal. You can copy an entire tape, copy records between file marks, or copy a specific number of records. The menu also lets you display the optical disk's directory and compare data from disk and tape for copy verification. The pass-through mode lets your host communicate through the peripheral. From \$38,500.

Aquidneck Data Corp, 170 Enterprise Center, Middletown, RI 02840. Phone (401) 847-7260.

Circle No 657

INK-JET PRINTER

Generating color images that approach photographic quality, the Chromajet 4000 ink-jet printer uses a 4-color ink array, a rotating drum, and a belt-driven head transport to produce a palette of 1000 distinct color shades for images with resolution approaching 300 dots/in. The Chromajet 4000 can also print seven colors of text in letter quality or draft mode, and in bold, italic, double-width, and condensed-type styles. The letter-quality mode has a 360×144-dot/in. resolution. The printer is self-priming and self-feeding for unattended operation. Each of the unit's four ink jets is capable of delivering 8000 drops/sec. A single, no-drip ink cartridge contains all four colors. From \$2000 (OEM qty).

Polaroid Corp, 575 Technology Sq, Cambridge, MA 02139. Phone (617) 577-3796.

Circle No 658

50-MIPS COMPUTER

Using parallel-processing techniques, the Flex/32 is a 32-bit real-time multicomputer that can perform 5 to 50 MIPS in a machine that's contained in one cabinet. You can achieve higher performance levels by linking several Flex/32 cabinets together in one system. This system is based on the company's C2C computer. Each C2C has a 16- or 20-MHz 68020 μ P and a 68881

floating-point unit. The C2C is compatible with the manufacturer's C1C units, which are based on 32032 μ Ps. A typical configuration of the Flex/32 multicomputer with two C2C computers, 2M bytes of RAM, an 80M-byte hard-disk drive, and the necessary software, costs approximately \$87,000 (OEM qty).

Flexible Computer Corp, 1801 Royal Lane, Bldg 8, Dallas, TX 75229. Phone (214) 869-1234.

Circle No 659

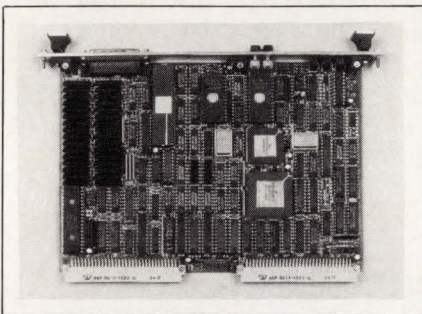

32-BIT COMPUTER

The MVME133, a 32-bit VME Bus-compatible μ C board, incorporates the MC68020 μ P, the MC68881 floating-point math coprocessor, and 1M byte of dynamic RAM. This single-board computer comes in two versions: the MVME133 with a 12.5-MHz clock frequency, and the MVME133-1 with a 16.67-MHz clock frequency. Both have four 28-pin JEDEC sockets for ROM, PROM, EPROM, and EEPROM. Other features include serial debugging and two RS-232C multiprotocol ports, three 8-bit timers, a real-time clock, and an A24/D32 VME Bus master interface that can act as a system controller. An optional firmware package, the MVME133bug debug monitor, offers 32 debugging, up/downline-loading, and disk-bootstrap-load commands; onboard diagnostics; and a 1-line assembler/disassembler with MC68881 support. MVME133 with 12.5-MHz MC68020, \$1700 (OEM qty).

Motorola Semiconductor Products Inc, Box 20912, Phoenix, AZ 85036. Phone (602) 438-3501.

Circle No 660

PC/AT GRAPHICS DISPLAY

Featuring single-slot connection to an IBM PC/AT or RT PC host and a vector-drawing speed of 240 nsec per pixel, the Owl display system produces 1280×1024-pixel color graphics. It also provides a bit-block-transfer speed of 24 nsec per pixel and a block-fill speed of 12 nsec per pixel. Based on a proprietary ASIC design, the system is an integrated display generator and monitor for local graphics-display list processing. The 19-in. screen can simultaneously display as many as 256 colors from a palette of 4096 at a 60-Hz flicker-free refresh rate. The display's graphics-instruction firmware implements the proposed ANSI CGI standard, but you can also use the system with VDI or GKS applications software and with AutoCAD. A 40k-byte buffer lets you store and access display segments without host intervention. \$5595.

Ramtek Corp, 2211 Lawson Lane, Santa Clara, CA 95052. Phone (408) 988-2211. TWX 910-338-0027.

Circle No 662

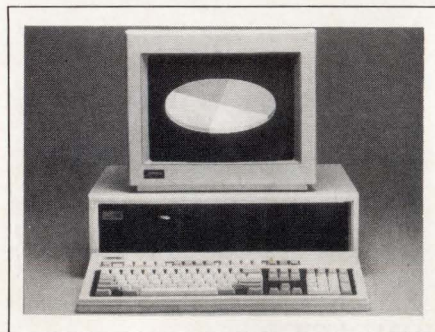

80386 COMPUTER

Featuring a 16-MHz 80386 μ P and a 32-bit architecture, a Deskpro 386 running Xenix System V/286 operates two to three times faster than an 8-MHz IBM PC/AT running 16-bit DOS code. However, MS-DOS 3.1 is available on the Deskpro 386 to run your PC-compatible software. You can add as much as 10M bytes of 32-bit RAM without using an expansion slot; the

Computers and Peripherals

computer can also accommodate as much as 14M bytes of RAM on the appropriate expansion boards and upgrade kits.

A 13-in. color monitor and an EGA-compatible graphics board are included. Standard storage devices include a 1.2M-byte floppy-disk drive and a hard-disk drive; you can order either a 28-msec, 40M-byte drive or a 19-msec, 130M-byte drive. You can also add a 40M-byte internal tape-cartridge drive. The 40M-byte version, \$6499; 130M-byte model, \$8799; tape-cartridge drive, \$799.

Compaq Computer Corp, 20555 FM 149, Houston, TX 77070. Phone (713) 370-0670.

Circle No 663

HANDHELD COMPUTER

According to the manufacturer, the PC-1600 is the first handheld computer to feature random-access floppy-disk storage capability.

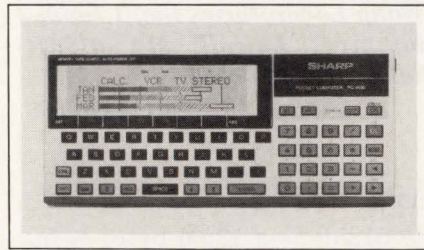

The PC-1600 has an optional 2½-in., 128k-byte microfloppy disk drive. Other features include a fiber-optic interface, a 16k-byte RAM (expandable to 80k bytes), an analog input, and an RS-232C serial port. An interface for a 4-color plotter, a printer, or a cassette is available as an option.

The PC-1600 is software compatible with the manufacturer's PC-1500A computer. Both units contain a ROM-resident Basic interpreter and a 60-pin I/O bus. The PC-1600's μ P is a proprietary design that's similar to the Z80A μ P. PC-1600, \$345; CE-1600F microfloppy drive,

\$210; CE-1600P plotter/printer/cassette interface, \$315.

Sharp Electronics Corp, Sharp Plaza, Mahwah, NJ 07430. Phone (201) 529-8965.

Circle No 664

VOICE TERMINAL

The KVT voice-driven terminal lets you use spoken words and phrases to control, enter data into, and retrieve data from mainframes and minicomputers. The KVT uses a 1000-word, IBM PC-compatible voice-recognition device to drive the terminal's software and hardware support system. The terminal can emulate an ASCII or IBM 3270 terminal for communication with DEC, IBM, HP, or other host systems.

The terminal automatically translates voice commands and data into user-defined keyboard inputs. You can also enter data via the keyboard. Each unit includes an IBM

VMEbus TO SCSI INTERFACE

TO: OPTICAL-MAGNETIC-DISC-TAPEDRIVES, LASERPRINTERS AND OTHER INTELLIGENT PERIPHERALS

Drivers available for OS-9[®] • Versados[®] • Unix V[®]

COMPCONTROL

COMPCONTROL INC.
15466 Los Gatos Blvd. Suite 109-365
LOS GATOS, CALIFORNIA 95030
Phone: 408-356-3817
Twx: 510-601-2895

Member of
the VMEbus International Trade Association



CIRCLE NO 16



Application of the NCR 5386 guarantees conformance to the SCSI specifications.

[®] OS-9 is a trade mark of Microware
[®] Versados is a trade mark of Motorola
[®] Unix V is a trade mark of AT & T

VMEbus

COMPCONTROL B.V. EUROPE
Stratumsedijk 31, P.O. Box 193
5600 AD Eindhoven, Holland
Telefoon (040) 12 49 55
Telex 51603 compcn nl

Computers and Peripherals

PC/XT-compatible computer with embedded voice-recognition capabilities, a Winchester disk drive, a floppy-disk drive, ASCII terminal-emulation software, and a 90-day warranty for \$9900. KVT with IBM 3270 emulaton, \$10,900.

Kurzweil Applied Intelligence, 411 Waverly Oaks Rd, Waltham, MA 02145. Phone (617) 893-5151.

Circle No 665

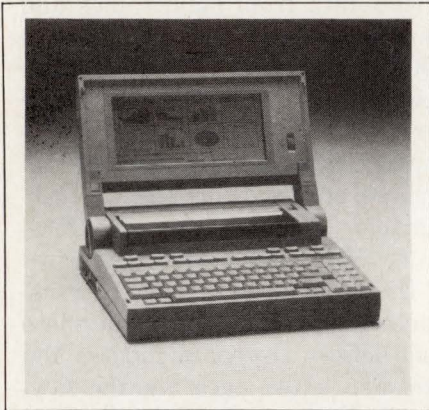

LAP-TOP COMPUTER

The WLTC-S1-US LapTop computer is built around an NEC 8-MHz V30 μ P. This CMOS μ P provides the low power advantages of CMOS circuitry as well as the speed advantage associated with the μ P's clock rate—nearly double that of the original IBM PC. The computer features an integral printer that's compatible with the Epson MX-80. The display is a 25-line \times 80-character supertwist LCD module, which boasts a 7:1 contrast ratio.

The computer has a built-in, 10M-byte hard-disk drive. It also furnishes a full-size, 92-key keyboard with 16 programmable function keys. You can choose between two internal, Hayes-compatible modems—one transmitting at 300/1200 baud, the other at 300/1200/2400 baud. The operating system is MS-DOS 3.2, which allows compatibility between IBM and Wang applications; conversion from one environment to the other is transparent to the user. Measuring 13.9 \times 11.9 \times 4 in., the basic LapTop weighs 14.25 lbs. \$3530.

Wang Laboratories Inc, 1 Industrial Ave, Lowell, MA 01851. Phone (617) 459-5000.

Circle No 666

TAPE DRIVE

The 5125E is a 125M-byte, 1/4-in. tape drive that fits into a half-height 5 1/4-in. package. With a controller board, it fits into a full-height space. The drive adheres to the QIC-120 spec, which specifies a 10,000-bpi data density and a 72-ips tape speed. The 5125E reads from both QIC-120 and older QIC-24 tapes but writes only to QIC-120 tapes.

The drive has an edge-sensing feature that provides for correct head alignment. During operation, the 5125E employs an off-track sensing scheme, which allows the drive to make small adjustments in the head position when read signals are weak. The 5125E comes with a QIC-36 basic interface. You can also choose a SCSI, QIC-02, or IBM PC interface board. The basic 5125E drive costs \$495 (1000).

Wangtek, 41 W Moreland Rd, Simi Valley, CA 93065. Phone (805) 583-5255.

Circle No 667

DISK DRIVES

The 6085E, 6128E, and 6170E full-height, ESDI Winchester disk drives have respective capacities of 85.3M, 128M, and 170.6M bytes (unformatted). All the drives in the 6000E Series feature run-length-limited 2/7 data encoding, automatic head retraction and locking during power down, sputtered media, and linear voice-coil actuators with a closed-loop, full-surface servo system. All models support a 10M-bps data-transfer rate, hard or soft sectoring, and serial ESDI operation with several optional commands. The drives dissipate 28W max during operation and 17W in standby mode.

Among the optional ESDI commands that the drives support are

spindle start and stop and vendor-code messages. The vendor-code messages provide a controller with access to a drive's model number, its storage capacity, the manufacturer's vendor code, and a vendor-unique extended drive status.

All drives support hard-sectored track formats with 162- to 4096-byte sectors. An ESDI command sets the hard-sector size before formatting. Variable-size counters read pulses from the servo track to determine sector size. The variable-size counters allow the drives to support track restructuring within the hard-sector format. The 6085E, 6128E, and 6170E cost \$1000, \$1150, and \$1300 (2500), respectively.

Miniscribe, 1861 Lefthand Circle, Longmont, CO 80501. Phone (303) 651-6000.

Circle No 668

CPU BOARD

The Mewa-286 CPU board duplicates the operations of an IBM PC/AT's mother board. The product contains Phoenix BIOS ROMs and sockets for as much as 1M byte of RAM. The 80286 CPU's speed is set at 6 or 8 MHz by a jumper on the board. Six PC/AT-compatible expansion slots let you add standard peripheral and memory cards. Two edge connectors accept only PC-compatible boards. An IC socket is available to accept an optional 80287 math coprocessor chip. The manufacturer has applied for FCC approval of the 4-layer mother board, but approval has not yet been granted. Without RAM, \$340.

R-D Electronic Enterprises Co Ltd, Box 11-02, Hsintien, Taipei Hsien, Taiwan, ROC. Phone (02) 912-4012. TLX 31547.

Circle No 592

No "boomerang effect" at Trend Circuits. Less than 1% of our prototype boards ever come back.

Fast turnarounds in prototype circuit boards are great — but not when the boards circle back again and again because of poor quality.

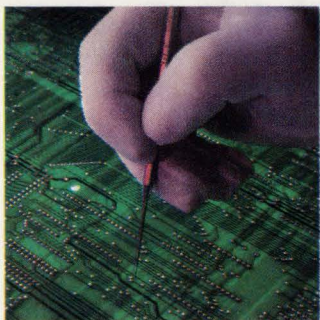

That "boomerang effect" costs precious time in proving your concepts and can end your chances to meet critical market windows.

**We deliver speed
and quality.**

Speedy turnarounds don't count for much if proto-

types don't work. At Trend Circuits, we're specialists in rapid production of prototype boards that work first time out. That's because we're people who understand your language, your objectives and your pressures.

Further, fully one-third of our people are involved in inspection. We begin with incoming artwork, where we can quickly identify common design errors. And we continue with double- and triple-checking right through to completion. As a result, less than a scant 1% ever come back. And that's good for both of us.



Now for speed. On a regular basis, we deliver *double-sided boards within 24 hours, and multi-layer boards within five days*. In fact, we're completing no less than 82% of all our work within five days.

Check our references.

You can verify our facts easily enough by talking to our customers. Simply phone and we'll put you in touch with people who've decided they won't accept compromise in quickly moving from design to finished prototype. They'll tell you why we're their logical choice for "no-boomerang" boards. And why we should be yours.

TREND CIRCUITS
PROTOTYPE SPECIALISTS

44358 Old Warm Springs Blvd.
Fremont, CA 94538-6148

415/651-1150
800/448-0550 (nationally)
800/448-0440 (in California)

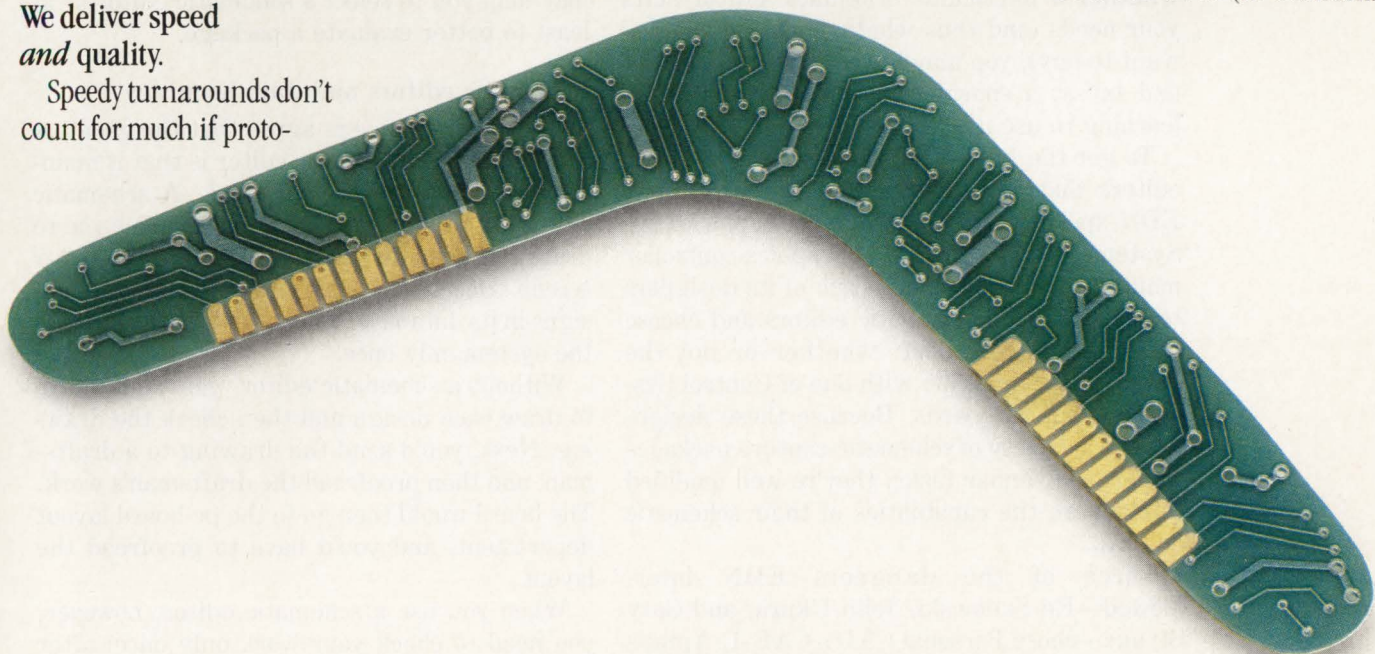

Expert designers evaluate PC-based schematic editors

Eva Freeman, *Associate Editor*

Because you can't run a benchmark on a schematic editor, you can distinguish among the packages only by using them. But to find out how well a particular package suits your needs, you must use it extensively; you often can't find the differences among the products merely by examining the demonstration software. It's a Catch-22 situation: Before you can discover whether a particular schematic editor suits your needs (and thus whether it's the one you want to buy), you may have to buy the product and invest a considerable amount of time in learning to use it.

To get the kind of information on schematic editors that only experienced users can give, EDN spoke with design engineers at Control Systems (St Paul, MN), a graphics-controller manufacturer that permits each of its designers to try PC-based schematic editors and choose the one he likes best, whether or not the package is compatible with one of Control Systems' graphics boards. Because these designers use a variety of schematic-capture packages to perform similar tasks, they're well qualified to compare the capabilities of their schematic editors.

Three of the designers EDN interviewed—Ed Sadowski, John Ukura, and Gary Strunc—chose Personal CAD's CAE-1, Aptos's

RGraph (formerly sold by Chancellor Computer as Symgraph), and FutureNet's Dash-4C, respectively. Working with their schematic editors every day has given these engineers ample opportunity to discover the packages' advantages and disadvantages. Besides giving specific information on the packages they use, the three designers offer general information that's relevant to other packages. Their experience may help you to select a schematic editor or at least to better evaluate a package.

Schematic editors maintain accuracy

The three engineers agree that the greatest advantage of a schematic editor is that it maintains the accuracy of your work. A schematic editor is a graphics package that enables you to draw a schematic diagram on your computer screen. Because a schematic editor stores designs in its database, you enter each design into the system only once.

Without a schematic editor, you would have to draw each design and then check the drawing. Next, you'd send the drawing to a draftsman, and then proofread the draftsman's work. The board would then go to the pc-board layout department, and you'd have to proofread the layout.

When you use a schematic editor, however, you need to check your work only once: after

Computer-Aided Engineering

To decide on the schematic editor that's right for your purposes, you might have to spend weeks learning to use a number of different packages. To make your task easier, EDN obtained information about three popular schematic editors from experienced users of the packages.

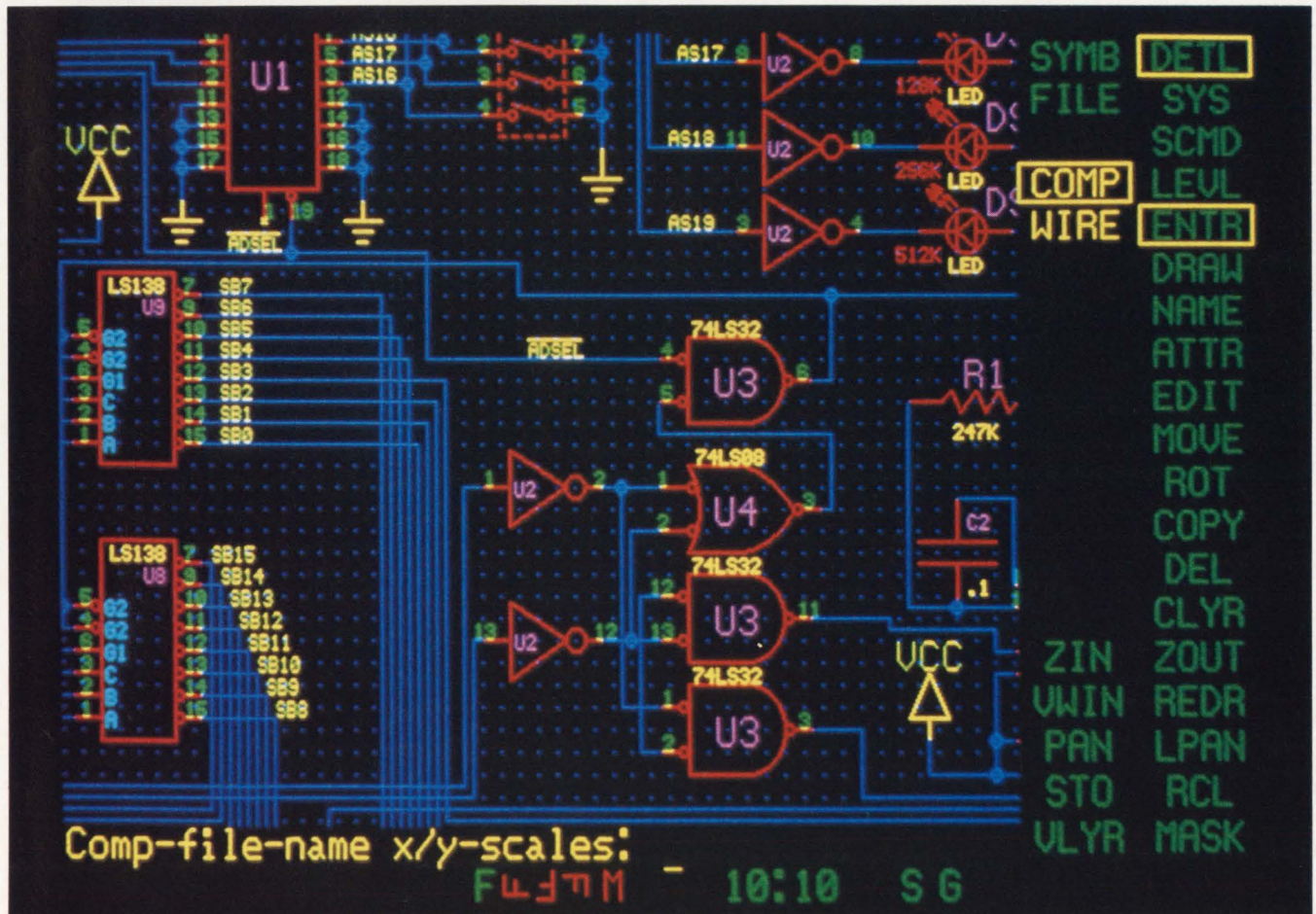

Fig 1—By using the extensive symbol library in Personal CAD's CAE-1 schematic editor, you can combine LSTTL, analog, and optoelectronic components in one diagram.

The greatest advantage of a schematic editor is that it maintains the accuracy of your work.

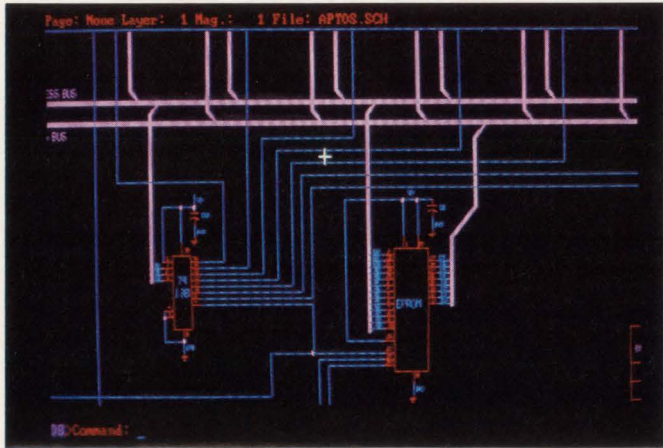

Fig 2—The 1024×768-pixel resolution of Aptos's RGraph schematic editor displays a greater portion of a schematic than a standard IBM graphics adapter can.

entering it into the system. After you've completed the schematic, the package translates the graphical symbols into a net list. You can enter the net list into a simulator and verify your design. You can also transfer your net list to an automatic pc-board layout system.

The engineers at Control Systems transfer their designs directly to the company's Calay (Irvine, CA) V03 pc-board layout system. Mark Zack, the company's pc-board-layout specialist, reports that he has never seen a discrepancy between a schematic and a layout created with this procedure, which represents a vast improvement over hand-drawn schematics.

Learning to use a CAE package takes time

When you use a schematic editor, the final step in designing a pc board (proofreading the layout) is easy. But the first step, learning how to use the schematic editor, isn't easy. Each of the three designers that EDN spoke to complained that the documentation in his CAE package's manual was inadequate. Ed Sadowski, the CAE-1 user, explained the problem.

"When I first started using this system," he said, "I was rushing to finish a design. I didn't have time to read complicated instructions; I wanted simple examples. Right now I've got a little more time and I'm learning more about the system. But I shouldn't have to spend so much time learning how to use it. I should be able to use it immediately."

John Ukura, the RGraph user, also had trouble learning how to use his system. His manual included a list of commands, but it lacked examples that would have explained the commands.

The Dash-4C user, Gary Strunc, was the sole CAE user who was pleased with the documentation accompanying his software package. Strunc remarked that the examples in the self-guided manual assisted him in mastering the system quickly. He also appreciated the package's on-line user manual and help display.

Inscrutable manuals seem to be the norm for schematic editors. For example, an EDN reader who requested anonymity (see Signals & Noise, pg 21) complained about the documentation that another company provides for its PC-based schematic editor. "The text lacked clarity and was weakly organized," he wrote. "Quite clearly, the documentation reflects a poor understanding of the needs of the engineer or designer. This is most unfortunate, because it's quite possible that the product itself is not nearly as weak as the documentation."

Users of less-expensive schematic editors (generally from small companies) can have even more trouble when learning how to capture schematics. Large CAE companies are able to staff telephone hotlines that can help new users; small companies may not be able to afford to devote an engineer to assisting customers.

Once the three Control Systems designers learned how to use their systems, their difficulties were far from over. Each system's library needed extensive modification.

For example, the \$5980 price of Dash-4C includes a library of TTL, ECL, CMOS, memory, discrete, Intel μ P, Motorola μ P, and IEEE parts. You can also purchase a \$200 library that conforms to MIL-D-1000 specifications. But the Dash-4C user found that he needed more parts than his package provided.

"The TTL library contained only standard TTL parts," he explained, "and I needed LSTTL. I had to insert an LS in the name of each of the parts in my TTL library. Standard TTL and LSTTL parts use the same pinouts, so I guess they figured that we could use the same symbols."

Unlike Dash-4C, the basic CAE-1 package doesn't include symbol libraries. However, CAE-1's base price is \$4950 and its symbol libraries cost \$150 to \$300, so you'd end up spending about as much for CAE-1 as you would for Dash-4C.

A notable problem with the CAE-1 package, as two users at Control Systems pointed out, is that the package lacks power and ground connections. In the symbol for an LS138 decoder, for instance, pins 8 (ground) and 16 (power supply) are missing (Fig 1). You need to add power and ground pins to each

Because a schematic editor stores designs in its database, you enter each design into the system only once and check your work only once.

symbol yourself: If a pc-board CAD system doesn't receive instructions to connect power and ground to a symbol, it won't route power and ground to the physical IC.

While adding power and ground pins to the symbols in his device libraries, Ed Sadowski encountered another problem with CAE-1. Although the package allowed him to correct errors while creating a graphical symbol, it didn't allow for any errors during the process of naming and assigning attributes to each pin. If he accidentally named a pin incorrectly, he had to start over.

Sadowski expressed considerable satisfaction, however, with the pin capacity that CAE-1 offers. The software can handle packages that include as many as 100 pins.

The RGraph user, John Ukura, reported that his package, like CAE-1, required him to start over if he made a mistake while numbering the pins. Unlike the components in the CAE-1 library, however, those in RGraph's symbol library include power and ground pins. The 74138, which CAE-1 represents with 14 pins, has 16 pins in RGraph's version of the symbol (Fig 2).

The design engineers liked Dash-4C's method of connecting power and ground best. In each component, only the logic pins appear on the symbol (Fig 3). The power-supply pins reside within a box that surrounds the symbol. You don't have to add connections to the power and ground pins; the package automatically links the pins when it generates a net list.

Although Control Systems' engineers liked Dash-4C's approach to power-supply interconnections best, they liked its hardware configuration least. Dash-4C accepts only an IBM (or equivalent) Enhanced Graphics Adapter (EGA); the Dash-4 version accepts only a FutureNet monochrome graphics display card.

The resolution of a display controlled by either the EGA card or FutureNet's monochrome card is 640×350 pixels. Either card controls a 13-in. monitor. Furthermore, Dash-4 and -4C provide only three levels of zoom—1:1, 1:2, and full-page displays. Because his schematics are large, Gary Strunc must pan across his display frequently.

In contrast, John Ukura cited RGraph's hardware pan and zoom as a particularly attractive feature. Because hardware controls these functions, RGraph pans and zooms faster than do CAE packages that use software to perform these tasks. Furthermore, RGraph offers eight zoom levels.

CAE-1 lets you choose your graphics controller from

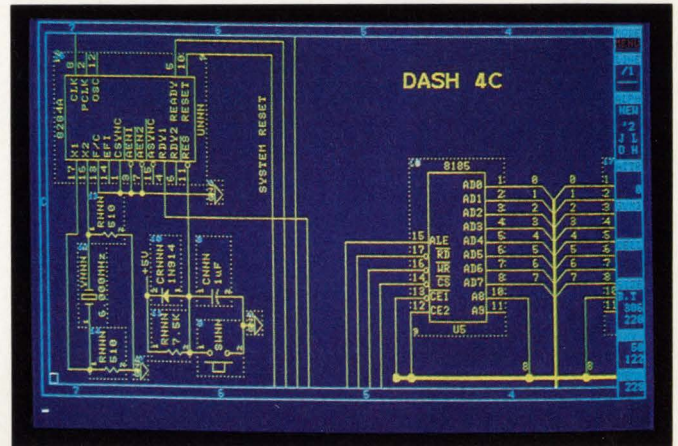

Fig 3—The power-supply connections to the 8185 in this schematic (produced by FutureNet's Dash-4C schematic editor) reside in the upper and lower left-hand corners of the symbol.

a wider range of cards than Dash-4C offers. CAE-1 accepts Hercules Computer Technology (Berkeley, CA) 720×348-pixel monochrome cards and IBM (or equivalent) 640×200-pixel Color Graphics Adapter (CGA) cards. However, CAE-1 doesn't restrict you to a low-resolution display. If you need a larger monitor and greater resolution than these graphics adapters can provide, you can add one of Control Systems' Artist cards. One such card, the \$2295 Artist 1 Plus, lets you use a 19-in. color monitor; the resolution of a noninterlaced display is 1024×768 pixels. If you use an interlaced display, you can select the \$1995 Artist 1, which provides the same resolution as the more expensive card. You could also choose P-CAD's own 1024×800-pixel graphics adapter and 19-in. monitor. The card-and-monitor combination costs \$6500.

Two monitors for one package

RGraph requires a 19-in. and a 13-in. monitor. The 13-in. monitor displays commands; the 19-in. monitor displays graphics. Besides a schematic editor, the \$9950 RGraph includes a 1024×768-pixel Artist 1 Plus card. The basic package also comes with pc-board layout software and a symbol (schematic and layout) library of TTL, ECL, CMOS, surface-mount, μ P, and analog devices.

If you can edit your schematics without a 19-in. monitor, you can save money by buying Aptos's Criterion I schematic editor. The \$1000 package runs on EGA-equipped PCs; it requires only one monitor. The program includes schematic symbol libraries but doesn't provide pc-board layout software.

This publication is available in microform.

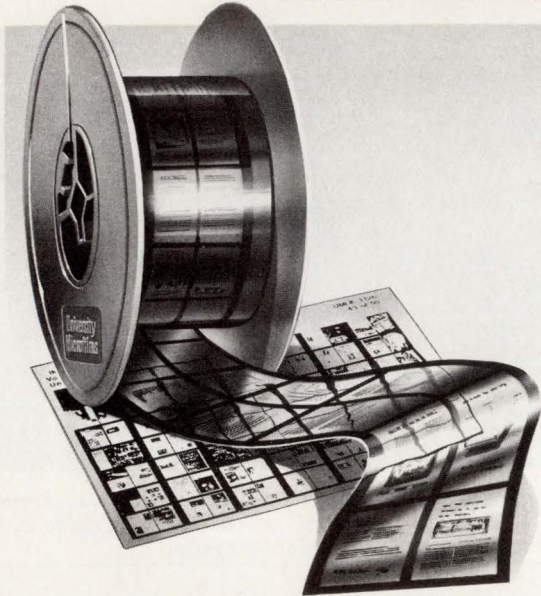

University Microfilms International reproduces this publication in microform: microfiche and 16mm or 35mm film. For information about this publication or any of the more than 13,000 titles we offer, complete and mail the coupon to: University Microfilms International, 300 N. Zeeb Road, Ann Arbor, MI 48106. Call us toll-free for an immediate response: 800-521-3044. Or call collect in Michigan, Alaska and Hawaii: 313-761-4700.

Please send information about these titles:

Name _____

Company/Institution _____

Address _____

City _____

State _____ Zip _____

Phone (_____) _____

EDN122586

**University
Microfilms
International**

For more information . . .

For more information on the schematic editors discussed in this article, circle the appropriate numbers on the Information Retrieval Service card or contact the following manufacturers directly.

Aptos Systems Corp
4113 Scotts Valley Dr
Scotts Valley, CA 95066
(408) 438-2199
Circle No 701

Personal CAD Systems Inc
1290 Parkmoor Ave
San Jose, CA 95126
(408) 971-1300
Circle No 703

FutureNet
9310 Topanga Canyon Blvd
Chatsworth, CA 91311
(818) 700-0691
Circle No 702

Graphics hardware (where, obviously, Control Systems has a vested interest) wasn't the only area in which the designers expressed concern about hardware. Both RGraph and CAE-1 let you choose a mouse from a vendor such as Logitech or Mouse Systems. FutureNet, on the other hand, requires that you use its proprietary mouse. The capabilities of FutureNet's mouse are more restricted than those of a general-purpose mouse.

"I wouldn't mind using FutureNet's mouse," Gary Strunc said, "but I wish FutureNet would let the mouse communicate with other MS-DOS packages. If I need to run another software package that uses a mouse, I have to add a second mouse."

Three approaches to software protection

FutureNet's method of protecting its software also drew criticism from Strunc. FutureNet requires that you insert a pc board inside your PC. This card controls the mouse and also protects the software. In contrast, P-CAD puts its software lock on an RS-232C port; Aptos protects its software with a key that resides on a floppy disk.

"If someone wants to look at one of the files," Strunc said, "he has to use my computer. I can't just hand him a software lock and a floppy disk. Also, if my PC needed repairs, I'd have to take it apart before I could ship it out."

Criticism notwithstanding, not one of the three designers at Control Systems would give up his schematic editor for another package. Each liked the appearance of his artwork, and each found that he could move his designs into layout much faster with a schematic editor than without one. But the most important advantage of the schematic editors was the elimination of errors that might have occurred during the manual transference of data. In sum, the schematic editors enable the designers to move accurate designs into production quickly. And that, after all, is the only reason for using a CAE package.

EDN

Article Interest Quotient (Circle One)
High 476 Medium 477 Low 478

THE BEST Schematic Capture

IS ONLY
\$495



GET THE FACTS STRAIGHT!

You get more with OrCAD/SDT than any other schematic capture program. So why settle for anything less?

- Runs on IBM PC/XT/AT or compatible, supporting most common graphic boards, printers and plotters
- Part Rotation & Mirroring
- Rubberbands wires & buses when objects are moved
- Supports TRUE A through E size sheets
- Unlimited Level Hierarchy
- Step & Repeat, Auto Panning, 5 Zoom Levels
- Color & Monochrome Graphics
- Complete Technical Sales & Support Staff
- Net/Wire List, BOM, Design Check & Library creation utilities

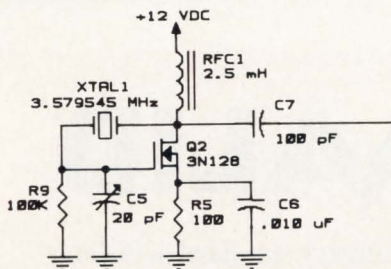

At OrCAD we don't think you should have to struggle to create libraries. That is why we have included over **2000 UNIQUE** parts including Discrete, TTL, CMOS, Micros, Analog, ECL, Memories, and Programmable Logic. With this many devices, parts are obviously very easy to create. Spend your valuable time creating designs instead of making new parts!

Why be forced to spend days reading through pages and pages of technical instructions just to figure out how to create a schematic? We don't believe you should. Creating schematics with OrCAD is quick and straightforward.

Make your own comparison, nothing comes close to the powerful ways OrCAD/SDT can increase your productivity. We even include utilities that convert OrCAD's EDIF Net List directly into other vendor formats!

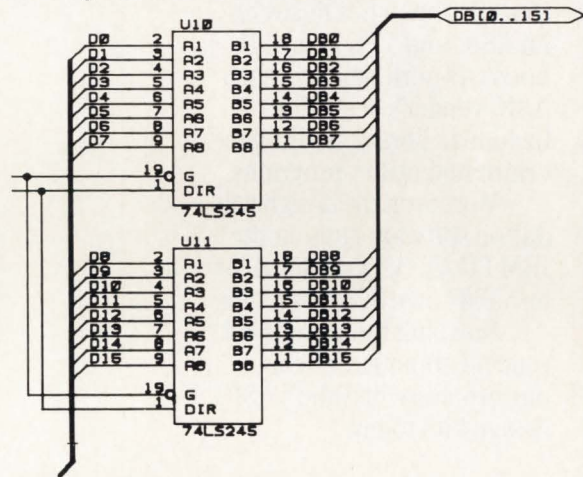

Now is the time to join the growing list of satisfied customers. Why wait to turn your PC into a quality design tool? For only \$495 you will discover that OrCAD/SDT is the most complete and cost effective schematic design tool available ... at any price!

Judge for yourself. Call today to receive your Free Demo Disk and brochure.

All orders are shipped from stock for immediate delivery!

CIRCLE NO 88

OrCAD 
Systems Corporation

1049 S.W. Baseline St. Suite 500
Hillsboro, OR 97123

(503) 640-5007

Psst! Valid's 78 ASIC design kits are the best-kept secret in CAE.

But the good word is getting around.

All the leading ASIC vendors support our design validation software. Now Valid users can design a gate array or standard cell as easily as a TTL board.

Choose your ASICs from AMCC, AMD, Fairchild, Ferranti, Fujitsu, Harris, Hitachi, Hughes, LSI Logic, Motorola, National, NCR, NEC, OKI, Phillips, RCA, Ricoh, TI and Toshiba. To name a few. And we're adding more all the time.

Our design validation software features ValidGED, a graphics editor, and ValidSIM, a logic simulator that distinguishes between an ASIC and a PC board. To boost its performance, each ASIC vendor's design kit includes a library, netlist generator and utility programs.

Moreover, the design validation software runs on the IBM PC AT™, VAXstation II™, or on Valid's own SCALDsystem.

Now that the word is out, read all about it. Call for our brochure on Valid's ASIC design kits today.

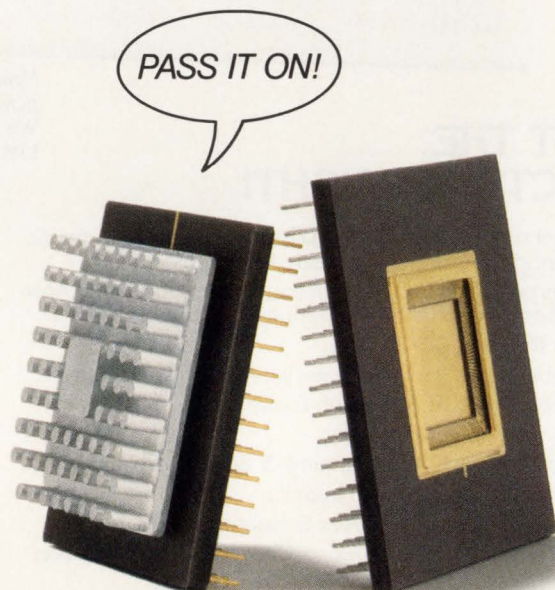

VALID

Industry standard solutions

For a brochure, call us at
1-800-821-9441. In California,
call 408/945-9400.

Trademarks: SCALDsystem, ValidGED, ValidSIM—Valid Logic Systems Incorporated; IBM PC AT—International Business Machines Corporation; VAXstation II—Digital Equipment Corporation.

Computer-Aided Engineering

Software lets you design and test PLDs as part of a complete system

PLD Master lets you design, test, and simulate programmable logic devices as part of an entire system. You can enter the logic using state-machine charts, schematic drawings showing ICs and gates, or a high-level-language description. The vendor also offers device libraries containing graphics symbols and modeling data for commonly used PLDs.

The program compiles your logic design into a JEDEC file with the aid of a compiler. Monolithic Memories' Palasm, Data I/O's Abel, and Signetics' Amaze compilers come as standard adjuncts to the program, but you can also use other compilers. The simulation portion of the program accepts any JEDEC file,

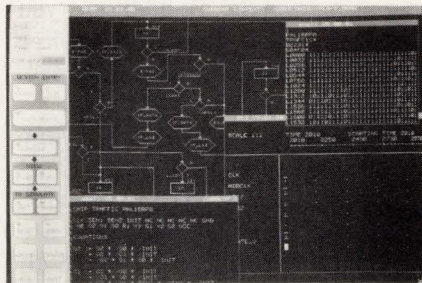

even those generated by different compilers on other systems; it performs logic simulation, timing verification, fault simulation, and testability analysis.

During simulation, you can change the definition of one of the PLDs in your system and then immediately continue the simulation. You don't have to recompile the entire design; the program automati-

cally incorporates your changes in the JEDEC file. When the simulation is complete, you can program the devices from the updated JEDEC file by issuing the appropriate commands from the same workstation on which you performed the data-entry and simulation phases. The program can capture, simulate, and program all current types of programmable devices. PLD Master runs on the vendor's Logician, Personal Logician, and MegaLogician workstations. \$6500, including the Palasm, Abel, and Amaze compilers.

Daisy Systems Corp, 700 Middlefield Rd, Mountain View, CA 94039. Phone (415) 960-6593.

Circle No 669

Verification system lets you test VLSI prototypes at 50-MHz clock rates

The Topaz system allows you to verify the design of VLSI devices having as many as 512 pins. The system consists of a test chassis that provides a high-speed parallel interface to an IBM PC/AT (for operator control), and RS-232C or IEEE-488 serial interfaces to a host computer or CAE workstation. The system comes in 25- and 50-MHz versions. It features 50-psec timing resolution and provides programmable drivers and receivers for each pin, automatic deskewing, an integrated logic analyzer, and software links to most CAE simulation programs.

In the basic configuration, the system can verify 18-pin VLSI devices; plug-in modules let you expand the number of testable pins in 18-pin increments (16 I/O pins and two independently controlled strobe pins). The modules also offer a



choice of 4k-, 16k-, and 64k-byte-deep vector memories. The pin drivers let you program both V_{OH} and V_{OL} from -10 to +10V with 10-mV resolution. The receivers, which can be programmed over the same voltage range, feature 1-M Ω input impedance and <35-pF loading on de-

vice output pins. You can use as many as four optically isolated power supplies, and you can program them for voltages from -7 to +7V and for currents from 0 to 5A.

Software supplied with the system includes a wide variety of IBM PC/AT operating utilities and three of the vendor's proprietary programs: Wave-Gen, which allows you to replicate waveforms drawn on the PC/AT graphics display at pins of the device under test; Meta-Shmoo, which lets you plot any two variable parameters; and EPL, a high-level language for automated testing applications. Prices start at \$34,000 for an 18-pin, 25-MHz system.

Hilevel Technology Inc, 18902 Bardeen, Irvine, CA 92715. Phone (714) 752-5215.

Circle No 670

Who says they don't make 'em like they used to?

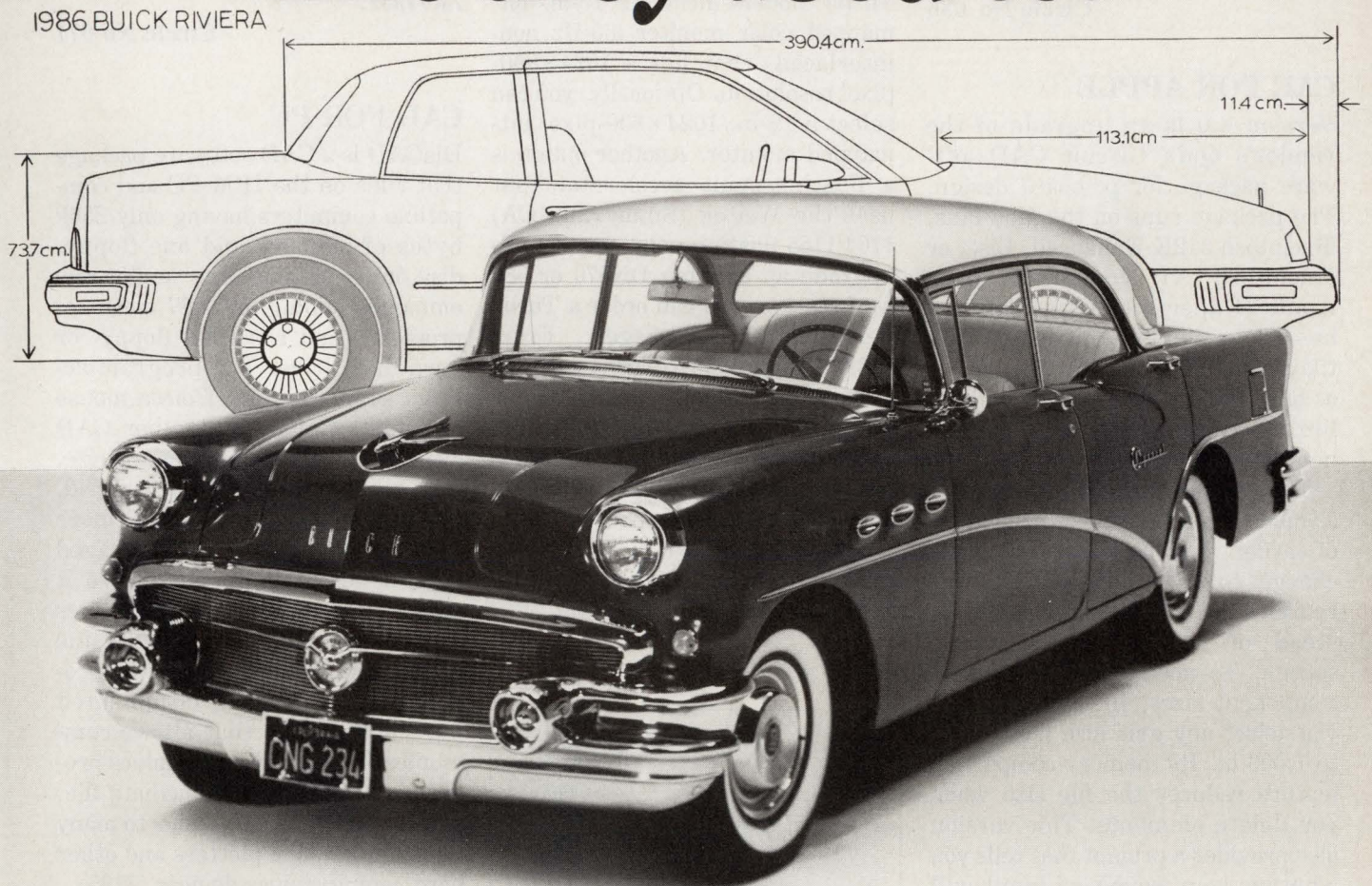

In one way at least, they make 'em exactly the way they used to—on Clearprint paper. The 1986 Riviera and the 1956 Buick both started out the same way—on a sheet of Clearprint 1000H drafting vellum.

Clearprint has been the first choice of engineers, architects and draftsmen since 1933. And we still make it exactly the way we used to—by the same proprietary process we perfected more than 50 years ago.

We've seen many changes in our industry through the years.

We are proud of the fact that Clearprint alone has remained unchanged, not only in product quality and integrity, but in customer satisfaction as well. And it's still the industry standard.

We make more than 1000 types and configurations of sheet and roll stock, both plain and printed, including papers for electrostatic copiers and CAD plotters.

CLEARPRINT®
Making paper work

CIRCLE NO 67

Try it yourself. Return the coupon below for a free kit containing all the tools you need to prove why they still make 'em the way they used to—on Clearprint paper.



Please send me my free kit.

Mail to: Clearprint Paper Co.,
P.O. Box 8703,
Emeryville, CA 94662

I use drafting paper for _____
Name _____ Phone _____
Title _____
Company _____
Address _____
City _____ State _____ Zip _____

EDN/CO/126

Software

are optional. 6085, \$7000 to \$12,000; pc-board-design software, \$32,000; schematic entry, \$6500; logic simulation and hardware-description language, \$14,000; PC-emulation board, \$750; MS-DOS, \$125.

Xerox Corp, EIS Unit, 2945 Oakmead Village Ct, Santa Clara, CA 95051. Phone (408) 988-2800.

Circle No 686

CAE FOR APPLE

Version 3.0 is an upgrade of the vendor's Quik Circuit CAD-software package for pc-board design. The package runs on the Mac Plus, Macintosh 512K Enhanced, Lisa, or Macintosh XL computers from Apple (Cupertino, CA). This enhanced version lets you design multilayer and surface-mount pc boards as large as 32×32 in. and provides a library of commonly used components and SMD pads.

This version's execution speed is as much as six times faster than that of earlier versions. When you make changes to your layout, the program redraws the changed areas only, instead of redrawing the whole screen. To accommodate unusual component sizes, the program lets you select any grid size from 0.001 to 1.000 in. Its memory-compaction feature reduces the file size when you delete elements. This version also provides a prompt that tells you whether your keyboard input will act as a command, will appear as text on the layout, or will be treated as the title of a pad or pattern. You can send your board files to a number of pc-board fabricators for manufacture. \$695.

Bishop Graphics, Box 5007, Westlake Village, CA 91359. Phone (818) 222-5808; in AK, CA, and HI, (818) 991-2600.

Circle No 673

GRAPHICS STATIONS

The Turbo models of the DN570/580 workstations run graphics applications as much as 2.2 times faster

than the standard DN570/580 versions. The new models feature a pipelined 32-bit VLSI CPU. The custom CPU combines a 68020 processor and a 68881 floating-point coprocessor. The CPU uses no wait states; it comes with 16k bytes of cache memory and 2G bytes of virtual address space per process. The Turbo models include a 15-in. bit-mapped color monitor (60-Hz non-interlaced) that has a 1024×800-pixel resolution. Optionally, you can select a 19-in. 1024×800-pixel bit-mapped monitor. Another option is a floating-point accelerator that uses the Weitek (Sunnyvale, CA) 1164/1165 floating-point chip set. To upgrade an existing DN570 or 580 workstation, you can order a Turbo Performance Package. From \$43,900 for a DN570 Turbo with 8M bytes of main memory to \$66,900 for a DN580 Turbo equipped with 16M bytes of main memory. Turbo performance package, \$12,500; floating-point chip set option, \$5900.

Apollo Computer Inc, 330 Billerica Rd, Chelmsford, MA 01824. Phone (617) 256-6600.

Circle No 678

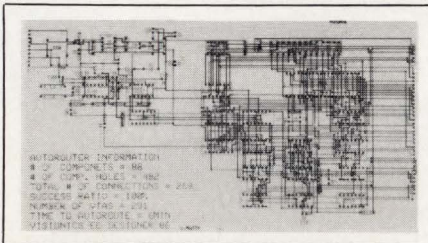

PC AUTOROUTER

The EE Designer Autorouter is a software module for use with the vendor's CAE/CAD package, which runs on an IBM PC or compatible computer having at least 640k bytes of memory. The autorouter operates in an interactive graphics mode. It provides fully automatic or semiautomatic routing strategies; when the program encounters an unroutable trace, automatic routing stops, so you can apply manual techniques. The module also lets you duplicate prerouted traces for repetitive tasks

such as routing memory buses. A post-routing option eliminates vias wherever it can do so without major rerouting. The program handles as many as 999 components and allows a maximum board size of 24×24 in. \$975.

Visionics Corp, 1284 Geneva Dr, Sunnyvale, CA 94089. Phone (408) 745-1551.

Circle No 674

CAD FOR PC

DiaCAD is a CAD software package that runs on the IBM PC and compatible computers having only 256k bytes of memory and one floppy-disk drive, although the vendor recommends adding an 8087 math coprocessor and a second floppy- or hard-disk drive. The program accepts graphics input from a mouse or tablet. Unlike most other CAD systems in the same price range, the program can handle polar grid, interactive cubic spline, and more than a dozen text fonts. The paged data structure is disk-based, so it allows you to create drawing files containing more than 100,000 line segments. The program can produce a standardized, documented intermediate file that allows communication with other graphics programs. Using the intermediate file, you can send your drawings to many different kinds of plotters and other hard-copy graphics devices. \$195.

Diacad Associates, Stinson Lake Rd, Rumney, NH 03266. Phone (603) 786-9561.

Circle No 676

LAYOUT VERIFIER

Remedi is an automatic and interactive schematic-to-layout debugging module that works in conjunction with the vendor's Chipgraph custom-VLSI layout editor and Dracula II layout verifier. The program compares the physical layout file for a custom VLSI circuit with the corresponding schematic-capture file; it displays discrepancies on the

NOW. 68000 Emulation!
Call for demo

Echo: What high level source code debugging should have been from the beginning.

Nobody does what our μ P development system does: lets you debug in high level while emulating at full speed; then a single keystroke gets you down to gut level to view C and assembly language.

It's what you should have been able to do from the beginning but couldn't until Arium Echo redefined microprocessor development systems in terms of performance and price. That's why, at \$9980, this 16-bit, true multitasking, UNIX-compatible system delivers more power, more speed and more menu-driven features than the HP 64000 system costing four times as much. Features like on-screen time stamping, super high speed C and Pascal compilers, and Arium's Proprietary Code Preview™ that lets you see where your code is going, as well as where it's been.

Echo is a multi-user system; but so affordable, every engineer could have his own. No sharing, no waiting, no lost man-hours. Just all the resources you need at your fingertips. One call now to the Arium Hot Line, (800) 862-7486, will give

you all the reasons why when it comes to performance and price, nobody echoes Echo. Not from the beginning. Not now. Not ever.

The image shows two computer monitors. The left monitor displays a list of instructions with addresses and mnemonics. The right monitor displays a C code snippet with a switch statement and variable assignments.

```

SIMULATION: Pod #1: 8085 727
STATE PC INSTRUCTION
-0093 030F  if(su1 == deboun
-0088 +0312  LHL  @PREG
-0087 +0313  XCHC
-0082 +0316  LHL  debou
-0077 0E00:  MOV  D,E
-0076 0130  MOV  E,00
-0074 0135  SUB  L
-0073 0136  JNZ  013F
-0071 0139  MOV  D,D
-0070 013A  SBB  H
-0069 013B  JNZ  013F
-0067 013E  JNR  E
-0066 013F  MOV  D,E
-0065 0140  ORA  D
-0064 0141  MOV  D,00
-0062 0143  RET
-0059 +0319  JZ   0344
-0057 031C  switch (olds
-0057 +031C  LHL  @%25
-0052 +031F  XCHC
    
```

```

EMULATION: Pod #1: 8085 Target: stopped Trac
STATE PC INSTRUCTION
-0057 031C  if(su1 == debounce)(
TRIG 0302  switch (oldstate)(
          case 0: return 1;
          case 1: return 0;
          case 2: return 1;
          )
        else(
          if (su2 == debounce)(
            switch (oldstate)(
              case 0: return 2;
              case 1: return 2;
            )
          )
        )
%21 su1 = 500
%23 su2 = 1
%20 debounce = 500
%5E starrag[1].c = 98
%5F starrag[1].i = 20
%511 starrag[1].str = "string 2"
Use cursor keys to edit variables
EVALUATE INCREMENT DECREMENT ENTER NEW RESTORE
ARGUMENTS ARGUMENTS
    
```



ARIUM
CORPORATION

1931 Wright Circle
Anaheim, CA 92806
(714) 978-9531

CIRCLE NO 68

Software

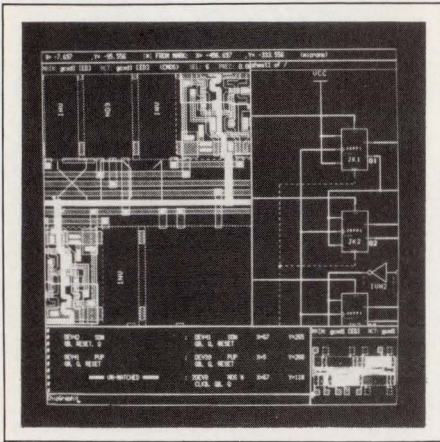

screen in windows that contain both the layout and a schematic representation. You can then edit the physical layout file to correct the error. The program runs on the vendor's CAE workstations. \$14,900.

Mentor Graphics, 8500 SW Creekside Pl, Beaverton, OR 97005. Phone (503) 626-7000.

Circle No 677

PC-BOARD CAD

The Board Series consists of three pc-board CAD packages: Board Designer, Board Editor Plus, and Board Expeditor. The Board Designer provides schematic capture, a library of board geometries, packaging- and pin-assignment routines, automatic placement and routing, and interactive editing. The design package has a local rip-up-and-retry router; the package generates output for photoplotters and N/C drills. Net-list import or export, back annotation, and component libraries are also included. The Designer can be a stand-alone system or a central resource for several Editor Plus nodes. The Editor Plus package provides the same design and layout capabilities as those of the Designer, except for routing and CAM. The Board Expeditor is an off-line automatic router node that provides background functions and CAM. By using the off-line router, you can free the other members of the Board Series for interactive work. You can integrate any of the pc-board layout

packages with the company's Logic Series CAE/CAT tools. All packages run on Apollo workstations. Board Designer, \$50,000; Board Editor Plus, \$40,000; Board Expeditor, \$75,000.

Calma Co, 501 Sycamore Dr, Milpitas, CA 95035. Phone (408) 434-4000. TWX 3720067.

Circle No 691

DEVICE LIBRARIES

Users of the PSpice circuit simulator can use the Parts option to create model libraries or bipolar transistors, diodes, op amps, and voltage comparators. To create these models, you must enter data-sheet information from your component manufacturer. You can generate best- and worst-case models (which take account of variations in device characteristics and in operating temperatures). The interactive option leads you through the input process and presents device curves of operating parameters. Hard copies are available from dot-matrix printers and pen plotters. The program runs on the IBM PC. \$450.

MicroSim Corp, 23175 La Cadena Dr, Laguna Hills, CA 92653. Phone (800) 826-8603; in CA, (714) 770-3022.

Circle No 680

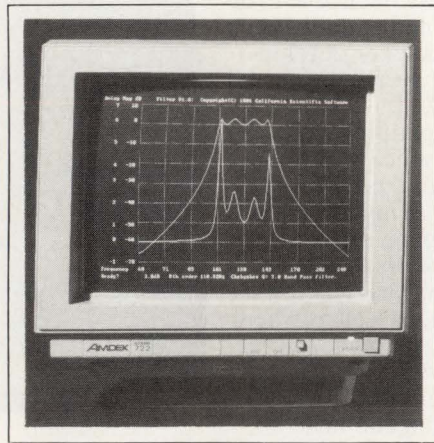

FILTER DESIGN

You can use the Filter software package to design active filters and digital filters having transfer char-

acteristics as high as the 30th order. The program lets you design all-pass, lowpass, highpass, bandpass, and bandstop filters of most types, including elliptic, Bessel, Butterworth, Chebyshev, and inverse Chebyshev types. The program selects resistor and capacitor values for multifeedback, voltage-follower, and biquad active filters and then lets you modify the values. After constructing a transfer function, the program produces Bode plots, plots of group delay, and impulse-, step-, or ramp-response plots of the resultant filter design. The program is written in Fortran and runs on an IBM PC or compatible computer having at least 384k bytes of memory, any graphics adapter, and PC-DOS version 2.0 or higher. The program can use (but does not require) an 8087 or 80287 math coprocessor. \$750.

California Scientific Software, 1159 N Catalina Ave, Pasadena, CA 91104. Phone (818) 798-1201.

Circle No 675

CAE WORKSTATIONS

The Scaldsystem ST Series is based on the 68020 μ P. The workstations feature 19-in. monochrome or color monitors, the Unix operating system, and Ethernet LANs. Each workstation can have one or two graphics terminals. All of the company's digital and analog CAE design and validation tools run on these machines. The basic system includes 4M bytes of RAM (expandable to 12M bytes) and a 170M-byte hard disk (expandable to 340M bytes). It's compatible with the company's hardware-modeling system, simulation accelerator, and system-level simulation system. Three configurations are available: The Logic Designer ST, the Validation Designer ST, and the Analog Designer ST. The Logic Designer ST provides schematic capture and net-list generation. In addition to these capabilities, the Validation Designer ST offers timing analysis

Software

and logic simulation. The Analog Designer ST includes analog-design software tools. Single-station Logic Designer ST with monochrome display, \$40,775; with color display, \$44,750; with two monochrome stations, \$49,775. Single-station Validation Designer ST with monochrome display, \$52,450; with color display, \$56,450. Analog Designer ST, \$64,725.

Valid Logic Systems Inc, 2820 Orchard Parkway, San Jose, CA 95134. Phone (408) 945-9400. TLX 3719004.

Circle No 688

DOCUMENT EDITOR

The CT2200 document editor combines text and CAE/CAD graphics. This package enables you to produce documentation from a CAE/CAD database that includes flowcharts, schematic drawings, simulation results, and pc-board layouts. Using the software, you can define character fonts and scale drawings to fit into your documents. Pan and zoom capabilities let you scan your document. Because the editor uses an ACSII file format, you can use a text editor to work with graphical and textual files. The program interfaces to laser printers; it provides 300x300-dot output resolution. The editor runs on IBM PCs and compatible computers (under PC- or MS-DOS), on DEC MicroVAX and VAX computers (under VMS), and on Sun workstations. IBM PC version, \$2500; MicroVAX version, \$5000; VAX version, \$7500.

Case Technology Inc, 633 Menlo Ave, Menlo Park, CA 94025. Phone (415) 322-4057. TLX 506513.

Circle No 682

GATE-ARRAY DESIGN

Using the Dash-Semicustom Development System, you can specify gate arrays with Boolean equations, truth tables, state diagrams, or schematics. Once you have entered your design, the system's library of

building tools, its logic synthesis, and its simulation capability provide a verified and functioning design. After logic verification, the system uses a logic-synthesis algorithm to minimize the number of gates required to implement the design. The software then factors the design to fit your target device. The package converts the reduced design to a Dash schematic (using

JEDEC-standard gate-array macro-cells). You can partition parts of the design into a set of PLDs, which you can program with JEDEC-format load files available from the system. Using these PLDs, you can supplement your logic simulation with a breadboard implementation of your design. The package runs on an IBM PC/AT; it also includes the Dash-4 schematic editor; the Dash-

AUTOROUTER
NOW AVAILABLE FOR ADDITIONAL \$975⁰⁰

\$975

EE DESIGNER™

CAE/CAD Integrated Software Package

At only \$975, no electrical engineer can afford to be without this end-to-end circuit design, simulation and PCB layout tool. EE Designer has all the benefits a design professional expects in a high performance CAE/CAD system, without the high cost.

Order your EE Designer package today. Visionics offers an unconditional money-back guarantee. If you're not satisfied, return the system in 30 days and we'll refund your money in full.

PRODUCT HIGHLIGHTS

- Schematic Capture
 - Interactive schematic drawing
 - Netlist generation
 - Parts packaging
 - Symbol libraries
- Circuit Simulation
 - Logic simulation
 - Waveform timing analysis
 - Interactive operation
 - Stability check

PCB Layout

- Multilayer capability
- Ratsnest function
- Rubber-banding
- Auto design rule check
- Comprehensive component library

Postprocessing

- Output for pen plotters, printers, photoplotters, NIC drill tape

SYSTEM REQUIREMENTS

- IBM PC, XT or AT with 512K memory
- IBM CGA, EGA or Techar color graphics
- Mouse System, MS or Logi mouse
- Houston Hi Pad digitizer or Hitachi Tiger Tablet
- Calcomp, Houston, HP or Hitachi plotters
- Gerber compatible photoplotter
- Epson compatible printer

To order, call 1-800-225-5669
...or write:

VISIONICS CORPORATION

1284 Geneva Drive
Sunnyvale, CA 94089

IBM PC, XT and AT are trademarks of International Business Machines Corp.

Software

Cadat-Plus logic and fault simulator; and design kits that provide foundry-specific symbol libraries, foundry-specific simulation libraries, foundry net-list translators, and worst-case-analysis software. \$24,995.

FutureNet Corp, 9310 Topanga Canyon Blvd, Chatsworth, CA 91311. Phone (818) 700-0691.

Circle No 687

4-MIPS WORKSTATION

The Sun-3/200 Series CPU features a 25-MHz 68020 μ P, a 20-MHz 68881 floating-point coprocessor, 64k bytes of virtual-address cache memory, and a 64-bit processor-to-memory bus. The workstation executes 4 MIPS and 125k flops. Optionally, you can select a floating-point accelerator board that increases calculation speeds to 865k flops. The workstation's standard main memory is 8M bytes; options can increase it to 32M bytes. You can use the computer as a diskless node on a network or you can add 280M to 1.1G bytes of hard-disk storage. As many as 48 terminals can share the computer. The 3/260HM version has a 19-in. monochrome monitor that features 115-dots/in. resolution and a 66-Hz noninterlaced refresh rate. Also available are a 3/360C color system and a 3/260G gray-scale system, both of which include 19-in., 1152 \times 900-pixel monitors. 3/260 HM, from \$33,900; 3/260C, from \$44,900; 3/260G, from \$40,900. Delivery, 60 to 90 days ARO.

Sun Microsystems Inc, 2250 Garcia Ave, Mountain View, CA 94043. Phone (415) 960-1300.

Circle No 679

GATE-ARRAY DESIGN

The Software Toolkit, which provides an interface to Mentor Graphics' Idea 1000 workstations, improves the simulation of this company's bipolar gate arrays. The package generates models of Series

HE2000, HM3500, and HE8000 gate arrays. The kit consists of two programs, Stats and Delay; a macrocell library; and a product-specific technology table. Stats detects technology-dependent design errors. It reports device loads, power dissipation, cell count, cell utilization, and preplacement and layout statistics. Delay uses load factors, junction temperatures, and wire capacitances to calculate propagation delays. You can run the program both before and after routing in order to compare the propagation delays calculated for estimated and actual wire lengths. Both programs use a technology table that contains product-specific propagation delays, loading parameters, and electrical characteristics. The kit includes a library of 150 macrocells. The program is available on floppy disks and on magnetic tape. \$25,000.

Honeywell Inc, Digital Product Center, 1150 E Cheyenne Mountain Blvd, Colorado Springs, CO 80906. Phone (800) 328-5111, ext 3422.

Circle No 681

BEHAVIORAL MODELS

Smartmodels are behavioral models for Motorola's 68000-family μ Ps. Each model contains the company's Symbolic Hardware Debugging program, which pinpoints design errors that occur in the course of a logic simulation. The debugger detects timing and usage errors; error messages identify the exact location (IC type, instance, sheet number, and pin name), time, and type of error. Both bus-functional and full-functional models are available. The bus-functional model executes all of a processor's bus cycles, with correct timing, under the control of a processor-control file. The bus-functional model doesn't execute a processor's internal instructions and register transfers, however, so it decreases simulation times. The complementary full-functional model can execute the system's soft-

ware, so it allows both software debugging and debugging of peripheral circuits. The software runs on Mentor and Daisy workstations. Bus-functional models, \$1500 to \$1800; full-functional versions, \$4900 to \$6900.

Logic Automation Inc, Box 310, Beaverton, OR 97006. Phone (506) 690-6900.

Circle No 683

IC LAYOUT

The GDSII IC-design package now features windows and an Ethernet interface between the optional Fast Mask Engine and the GDSII/32 workstation. The windows let you view portions of a physical design and the entire design concurrently. The Fast Mask Engine checks for electrical- and design-rule violations. The interface eliminates the need for a host processor. The IC-layout system's Customplus symbolic and hierarchical IC-design package now uses your schematic net list to produce electrically correct physical designs directly from logic.

This package also features a point-to-point router. Techplus, an application package for designing thick- and thin-film hybrids and analog pc boards, now provides features for designs that use through-hole, chip-and-wire, reflow-solder, tape-automated bonding, flexible, and microwave techniques. Including a Data General DS4200 workstation and Customplus, the GDSII/32 system costs approximately \$100,000; the Fast Mask Engine costs \$60,000. Delivery, 90 days ARO.

Calma Co, 501 Sycamore Dr, Milpitas, CA 95035. Phone (408) 434-4000.

Circle No 684

Until now, you expected to get what you paid for. Bruning's new ZETADRAF 900 E-size, single sheet plotter gives you *more*.

How? We've designed and engineered a totally new E-size plotter to the point where it outperforms every other plotter of its type.

And at the same time, we reduced the price!

The drawing quality is superb. And, when you consider 6 g's acceleration, 45 ips chart speed and 8-pen color capability, it's unmatched.

Of course our faster plot speed means your output is higher than ever. ZETADRAF 900 could cut the plot time for your most dense design in half.

ZETADRAF 900 supports all major CAD software packages and

is compatible with most computers. Interfaces include RS232, IEEE-488, GML and HPGL.

No prior plotter experience is required, even for liquid ink. ZETADRAF 900 has two levels of operation—novice and advanced. But *everyone* appreciates features such as the angled, LCD control panel and the ability of the plotter to store even complex user-designed configurations.

Sorry CalComp and HP. We just didn't realize when we started out that we could produce so much plotter for so little money. But we did. Get all the facts about ZETADRAF 900 or our other ZETA drafting plotters by calling (415) 372-PLOT or write:

Bruning Computer Graphics
777 Arnold Drive
Martinez, CA 94533
TWX 910-481-5951



CIRCLE NO 70

BRUNING

Introducing the
ZETADRAF 900
for \$7,950.

We just raised the
performance level
for single sheet,
E-size plotters.

We also lowered
the price!

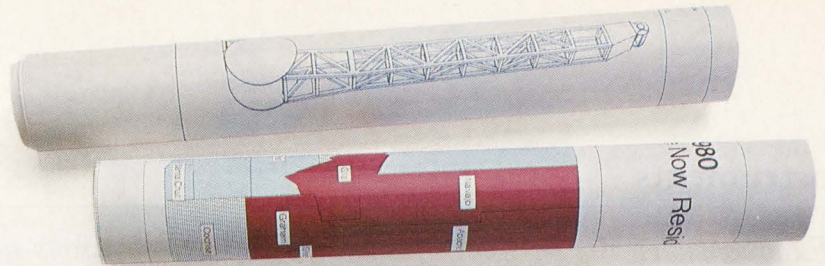

Instruments

Fiber-optic cables in short-haul data-communications networks are becoming increasingly popular, and as a result you may find yourself chasing photons as well as electrons while debugging your next system/network interface.

Fiber-optic testers determine faults in short-haul networks



OTDR with a 1m dead zone and 0.05m resolution (Photodyne)

Margery S Conner,
Regional Editor

With the use of an optical time-domain reflectometer (OTDR), you can test fiber-optic cabling for out-of tolerance attenuation and locate discontinuities and miswires. OTDRs can characterize a fiber-optic network's connectors, splices, and faults. If you only need to know overall attenuation, an optical-loss test set might suffice.

In the past, the majority of fiber-optic installations have been in long-haul telecommunications networks characterized by single-mode fibers and long wavelengths (1300 to 1800 nm). Nowadays, however, fiber-optic cabling for short-haul networks is becoming increasingly popular for both commercial and military LANs because of the space and weight savings it affords as compared with copper cabling. Test equipment for fiber-optic-based networks must

match fiber and light-source characteristics; test-equipment requirements for short-haul networks differ from those for long-haul networks.

The single-mode fibers characteristic of long-haul networks have disadvantages. Their extremely small diameters, roughly the same as a strand of human hair (but even more fragile), make attaching connections and splices difficult and expensive. In addition, laser diodes are relatively expensive and have environmental constraints. Short-haul networks are not affected by fiber loss because of their comparatively short cabling lengths, and consequently they can use multimode fibers, shorter wavelengths (in the 850-nm region), and LED sources.

A high-resolution, short-dead-zone OTDR is the single most useful tool for characterizing fiber-optic cabling in short-haul networks (see **box**, "Glossary of fiber-optics terminology"). An OTDR launches a very short laser light pulse down a fiber, measures the amplitude and timing of the returned light, and graphically displays the relative positions and losses of the fiber's features (**Fig 1**). Fresnel reflections and Rayleigh backscattering cause virtually all of the reflections. Fresnel reflections occur at cleaved fiber ends, such as connectors or splices, and appear as sharp drops in trace amplitude. Backscattering, caused by light bouncing off molecules in the fiber, appears as a gradually downward-sloping trace.

Unlike copper cabling, where breaks in the cable usually result in a complete loss of signal, fiber-optic cabling problems often appear as degradations in signal power. Any fault that causes a sharp reduction in optical power will show up on the display as an abnormally sharp drop in trace amplitude. An example of such a fault is a stressed curve in the fiber, called a microbend, which results in light being reflected out through the cladding, instead of continuing on down the fiber.

A break in the fiber causes a cleaved end that results in a Fresnel reflection, which in turn causes an OTDR dead zone (**Fig 2**). During a dead zone, the OTDR is virtually blind and will not display fiber features that occur within it. The length of the dead zone is important in short-haul networks with connections occurring close together. For example, a submarine may have bulkheads spaced every 2m; the cabling will have connectors at 2m

intervals. An OTDR with a dead zone of 2m or longer will not be able to see either these connections or faults in between.

The launched pulse width, the receiver amplifier bandwidth, and the detector tail determine the length of the dead zone. In low-resolution OTDRs, the dead zone is essentially the same as the launched pulse width because the tailing effect is negligible. In high-resolution OTDRs with much narrower pulse widths, you must factor in the recovery time of the detector and the receiver amplifier bandwidth.

You'll find great variation among OTDR dead zones (**Table 1**). For example, the Tektronix OF150's laser fires a pulse 15 nsec in width. During the time that the laser is on, the photodetector is blinded, causing a blind spot of 1.5m. (Light travels at approximately 10 nsec/m in an optical fiber.) The tail contributes another 7m, resulting in a total dead zone of 8.5m.

The Photodyne 5400XQ, on the other hand, uses a 5-nsec (0.5m) launched pulse width and has a 0.5m tailing, combining for a 1m dead zone. There are tradeoffs, however, for such a short dead zone. To achieve the fast amplifier/sensor recovery time, the 5400XQ sacrifices some receiver dynamic range: 10 dB vs the OF150's 21.5. In addition, the shorter pulse width launches less power into the fiber, resulting in a shorter distance range.

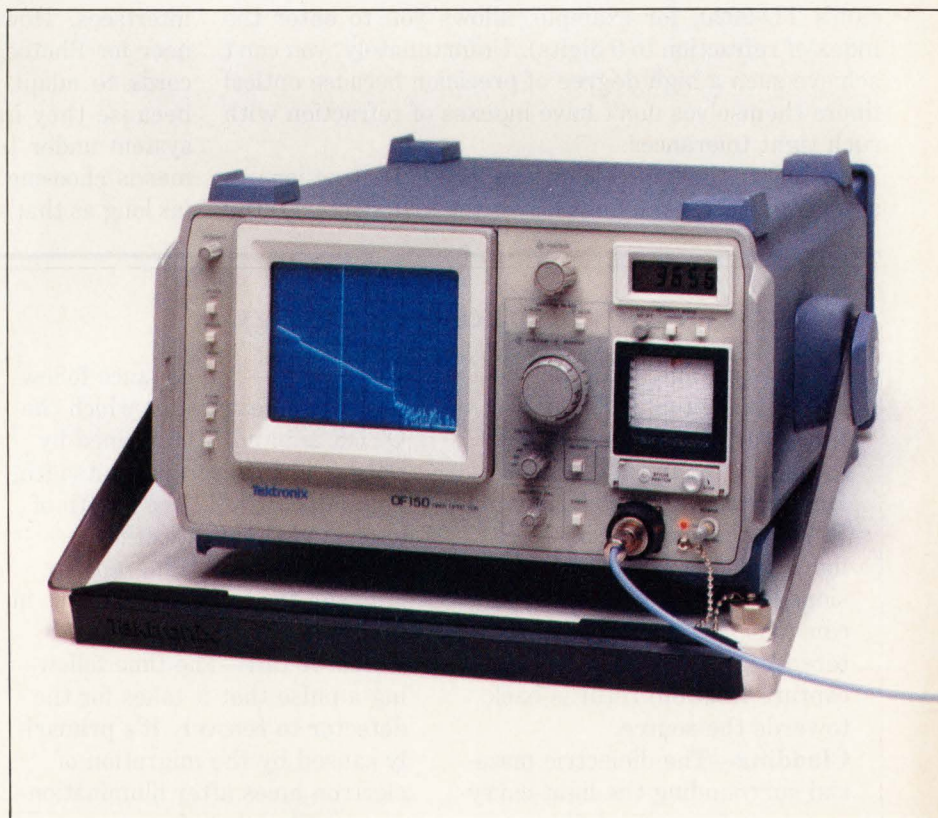

OTDR with short-range pulse width of 15 nsec (Tektronix)

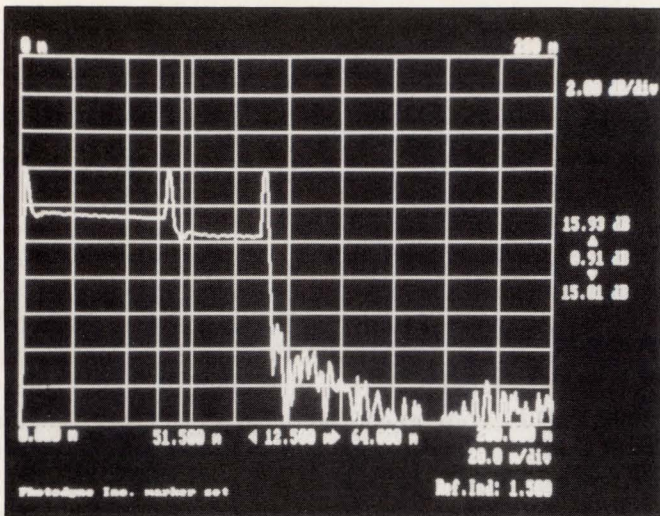

Fig 1—A display of an OTDR presents the relative positions and losses of the fiber under test's features. The sharp drops indicate connectors along the fiber, and the slight drops in trace amplitude between the connectors are a result of fiber attenuation. (Photo courtesy Photodyne)

An OTDR can only measure time. It translates the timing of the returned signal into distance by using the formula $D=ct/2n$, where D is the fiber length, c is the speed of light in a vacuum, t is the observed time between the launch signal and the reflection, and n is the average refractive index of the fiber core.

Although an OTDR can determine the value of t to 0.01% accuracy, the variable that actually limits overall accuracy is n . If it were possible to be certain of the fiber's index of refraction, you could enter it into the OTDR with a high degree of precision (Laser Precision's TD-9920, for example, allows you to enter the index of refraction to 5 digits). Unfortunately, you can't achieve such a high degree of precision because optical fibers themselves don't have indexes of refraction with such tight tolerances.

Adding to the imprecision, the index of refraction can also change after the fiber leaves the manufacturer; the

index for a loosely wound spool of fiber is different from a tightly wound one. Most OTDRs specify their accuracy as a function of the timing accuracy (0.01%, determined by the clock crystal) plus the refractive-index accuracy. In contrast, Photodyne quotes its 5400XQ's accuracy at ± 10 cm; however, this number only takes into account OTDR timing. Overall accuracy also depends on the index of refraction (which, as noted above, the manufacturer has no control over) and thus is greater.

It's important to keep in mind that an OTDR measures round-trip loss: The reflected light also undergoes loss before it returns to the detector. When you're measuring the insertion loss of connectors, you're not always justified in assuming that one-way loss is one-half the round-trip loss. Nonreciprocal losses may occur, depending on diameter variations and numerical-aperture variations. The measured loss will depend on what end of the fiber you measure from.

Clearly, you must have some means of connecting your OTDR to your short-haul network. Very little standardization of fiber sizes or connectors exists for short-haul networks. One option is to use patch cords as interfaces. However, Robert Rickenbach, chief engineer for Photodyne, cautions against relying on patch cords to adapt fiber connectors to tester connectors because they introduce another loss point into your system under test and degrade with use. He recommends choosing one connector type for your network (as long as that's feasible) and specifying it for all your

Glossary of fiber-optics terminology

Accuracy—The difference between the actual distance to a fiber feature and the distance measured by an OTDR.

Backscattering—Also known as Rayleigh backscattering. The light deflections caused by collisions with fiber molecules. A constant fraction of backscattered light (referred to as the capture fraction) returns back towards the source.

Cladding—The dielectric material surrounding the light-carrying core of an optical fiber.

Dead zone—The distance following a fiber feature for which the OTDR is blind. Determined by pulse width, receiver bandwidth, and detector tail. The length of a dead zone indicates the OTDR's ability to differentiate between two adjacent features in a fiber signature.

Detector tail—The time following a pulse that it takes for the detector to recover. It's primarily caused by the migration of electron holes after illumination ceases. The photodetector can

see sharp reflections during the tail but not losses caused by backscattering.

Distance resolution—The shortest distance for which the instrument can distinguish between two nearly similar faults or reflections.

Fresnel reflection—A reflection caused by light entering a medium that has a different index of refraction.

Long-haul network—A network that is 10 to 100 km in length. Typically, long-haul networks

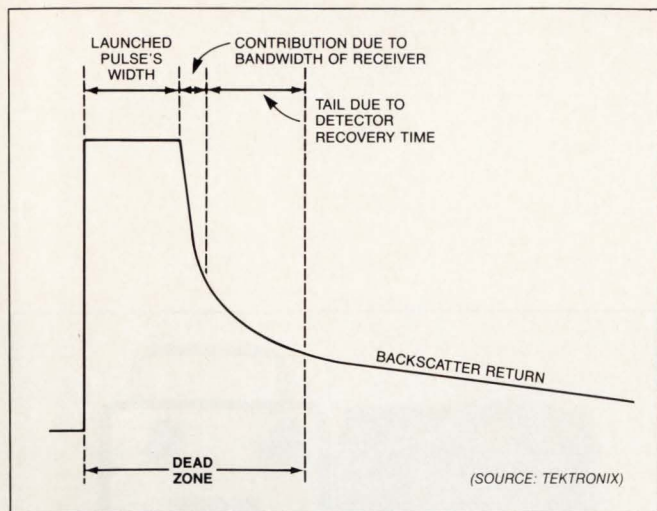

Fig 2—This amplitude vs time representation of a photodetector's output illustrates the factors that determine an OTDR's dead zone: the launched pulse's width, the receiver bandwidth, and the detector tail.

fiber-optic test equipment. Of course, if you're not fortunate enough to have network connectors compatible with the OTDR's connector, you'll have to use patch cords as interfaces.

Another option is to use pigtailed OTDRs with pigtailed connectors. OTDRs with pigtailed connectors are common, and pigtailed connectors are handy if you'll be using a variety of connectors, or if you don't know which connector you'll be using. John Gentile, chief engineer for Laser Precision, recommends the use of pigtailed connectors. According to him, the length of a dead zone of an OTDR using a pigtail may be less significant because the pigtail, when attached with a nonreflective fusion splice, can serve as a buffer for the initial dead zone. (Note that dead zones will still occur after subsequent reflecting features.) He adds, moreover, that paying the premium for a short-dead-zone OTDR isn't always warranted.

Although you might think that an OTDR, with its more advanced capabilities, is the better fiber-optic

testing device, you'll find this isn't always the case. In a short-haul network, your light source will most likely be an LED. An OTDR uses a laser and thus may not give an accurate picture of your network's attenuation. With test sets, you have a choice of sources: LEDs or lasers. In addition, fault location and characterization aren't always necessary; you may only need to know total fiber loss. An optical-loss test set measures fiber loss at a fraction of the price of an OTDR.

Unlike OTDRs, which measure fiber loss indirectly by analyzing the timing of reflected and backscattered light, test sets measure cable loss directly. A test set comprises a light source that you connect to one end of the fiber under test and a photodetector that you connect to the other fiber end. The manufacturer may

TABLE 1—REPRESENTATIVE SHORT-HAUL OTDRs (850-nm REGION)

COMPANY	MODEL	DEAD ZONE (m)	RESOLUTION (m)	SHORT-RANGE PULSE WIDTH* (nSEC)	PRICE
ANDO	AQ-7106	5	0.5	20	\$10,000
LASER PRECISION	TD9920	5	1	20	\$12,000
PHOTODYNE	5400XQ	1	0.5	5	\$22,500
TEKTRONIX	OF150	8.5	1	15	\$13,500

*EACH OTDR ALSO HAS A LONG-RANGE PULSE WIDTH, WHICH RESULTS IN INCREASED RESOLUTION AND A GREATER DEAD ZONE.

are telecommunications systems using single-mode fibers and laser light sources with long (1300 to 1800 nm) wavelengths.

Microbend—A small, sharp bend in a fiber that results in signal attenuation. The light traveling inside the fiber is reflected toward the side at an angle steeper than the numerical aperture.

Multimode fiber—A fiber with a relatively large diameter, which allows light to travel in multiple spatial paths.

Numerical aperture—A number that refers to the largest angle at which rays can enter or leave a fiber.

Patch cord—An extension fiber with connectors at both ends. A hybrid patch cord refers to a fiber with different connectors on both ends; it serves as an interface.

Pigtail—A fiber with a connector at one end and bare on the other. To use a pigtail, you have to cut off the connector on the system cable and splice the bare

ends together.

Short-haul network—A network that is less than 2 km in length. Typically, short-haul networks are systems for a plane, a submarine, or a building.

Single-mode fiber—A fiber with a diameter of a few microns, which constrains light to travel in only one spatial path.

Spectral attenuation—Fiber loss that varies with the wavelength of the light.

Backscattering, caused by light bouncing off molecules in the fiber, appears as a gradually downward-sloping trace.

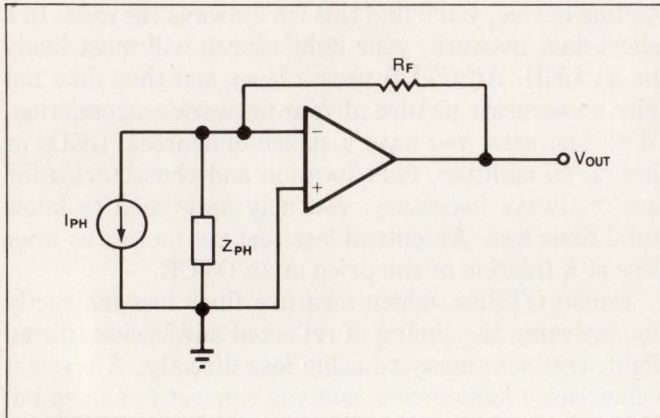
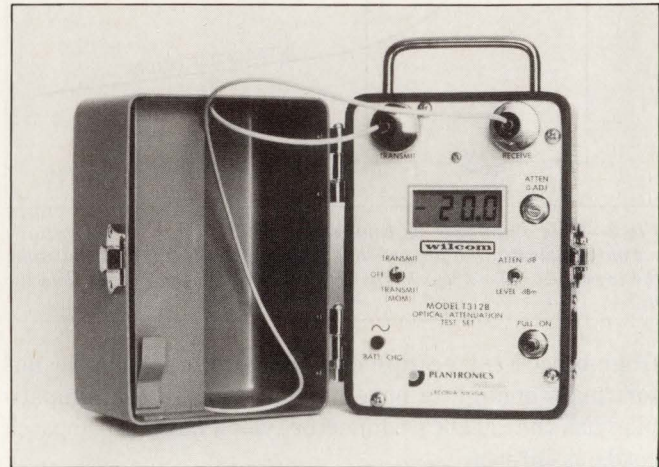

Fig 3—In this front-end amplifier for the power-measurement section of a test set, the photodiode impedance Z_{PH} must be high to guarantee receiver sensitivity.

integrate the source and detector into one housing, or it may sell the components separately. A test set fires its source and measures the power it receives at the other end; the difference in power is the attenuation caused by all the losses in the fiber.

Before testing the fiber, you must reference the test set's detector to its light source by connecting the source to the detector with a patch cord and adjusting the detector reading to some initial value. Adjustment methods vary. You adjust the Wilcom 312B by turning a potentiometer; you adjust the Photodyne 2250 XFA via a pushbutton. Once you've made the adjustment, the power out of the patch cord is the reference power. By connecting the patch cord to the system fiber and



Optical-loss test set (Wilcom/Plantronics)

connecting the other end of the system fiber to the test-set detector, the power reading for the fiber (in decibels), subtracted from the initial power reading at the patch cord, gives the attenuation of the cable system.

The single most critical component in a test set is the photodetector. Ideally, it should have a temperature-stable impedance, spectral response over the common range of fiber-optic frequencies (850 to 1800 nm), a large photosensitive area, a uniform surface, and a linear response. You have three types to choose from: germanium, silicon, and indium gallium arsenide.

Germanium's manufacturing process is well understood, and its spectral response covers the 850- to

TABLE 2—REPRESENTATIVE TEST SETS

COMPANY	MODEL	DETECTOR TYPE	RANGE (dBm)	RESOLUTION (dB)	PRICE	COMMENTS
FOTEC	T300	Si	-60 TO +3	0.1	\$1200	HANDHELD*
HEWLETT-PACKARD	8152A/81521B	COOLED Ge	-80 TO +3	0.01	\$4650	PRICE INCLUDES MAINFRAME WITH ONE OPTICAL HEAD
LASER PRECISION	AM-4000/AP-4200	Si	-90 TO +10	0.01	\$3920	PORTABLE.* ALSO AVAILABLE WITH TEMPERATURE-COMPENSATED Ge DETECTOR
PHOTODYNE	18XT/9XT 2200XFA	Si	-70 TO +3	0.01	\$2685	HANDHELD* FIELD RUGGEDIZED, AUTOPOWER SHUT-OFF
		Si	-80 TO +6	0.01	\$3445	
	2250XFA	COOLED Ge	-70 TO +6	0.01	\$5445	FIELD RUGGEDIZED, AUTOPOWER SHUT-OFF
WILCOM	T331-05	Si, InGaAs	-65 TO +3	0.1	\$4000	FIELD RUGGEDIZED
	T312B	Si	-65 TO +3	0.1	\$995	FIELD RUGGEDIZED
	T339/T363	Ge	-50 TO 0	0.1	\$1950	FIELD RUGGEDIZED

*LIGHT SOURCE AND POWER METER COME IN SEPARATE BOXES.

We proudly introduce our MetalCE™-80515, the industry's first cost-effective, PC-hosted in-circuit emulator for Siemens Components' new 80515 high-integration single-chip microcontroller.

The 80515 microcontroller is one of the first proliferation devices developed for the MCS™-51 microcomputer family. Naturally, MetaLink™ delivers you full hardware and software emulation support. And our MetalCE-80515 comes standard with all the MetaLink features and options that you've come to rely on with our emulators.

Adding the MetalCE-80515 to our line demonstrates our continuing commitment to the ever expanding MCS-51 microcomputer family. A commitment that began with the introduction of our emulators for the 8031, 8032, and 8344 devices

and grew with the addition of emulators for the 8051, 8052 and 8044 devices. A commitment that will continue to grow as the MCS-51 microcomputer family expands.

This commitment has seen MetaLink

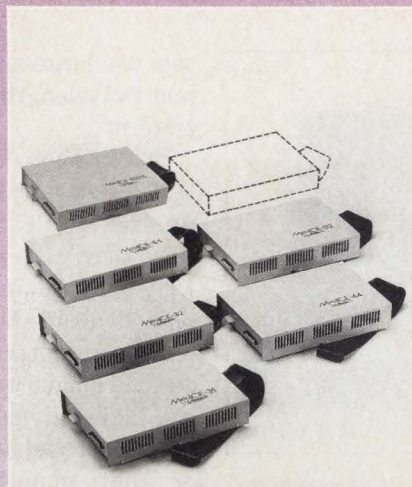

emerge as the technical leader in providing cost-effective, PC-hosted emulation support for the MCS-51 microcomputer family. Recognized as the leader in giving you the best software and hardware — and the easiest to use — for your money.

And as future cost-effective emulator tools are enhanced, you can be sure that MetaLink — the ICE-HOUSE — will be in the forefront.

MetaLink. Contact us today for a more productive tomorrow.



33 West Boxelder Place, Suite 110
Chandler, Arizona 85224
(602) 926-0797
(Toll free) 1-800-METAICE
TELEX: 499-8050-MTLNK

The newest ICE from the ICE-HOUSE™

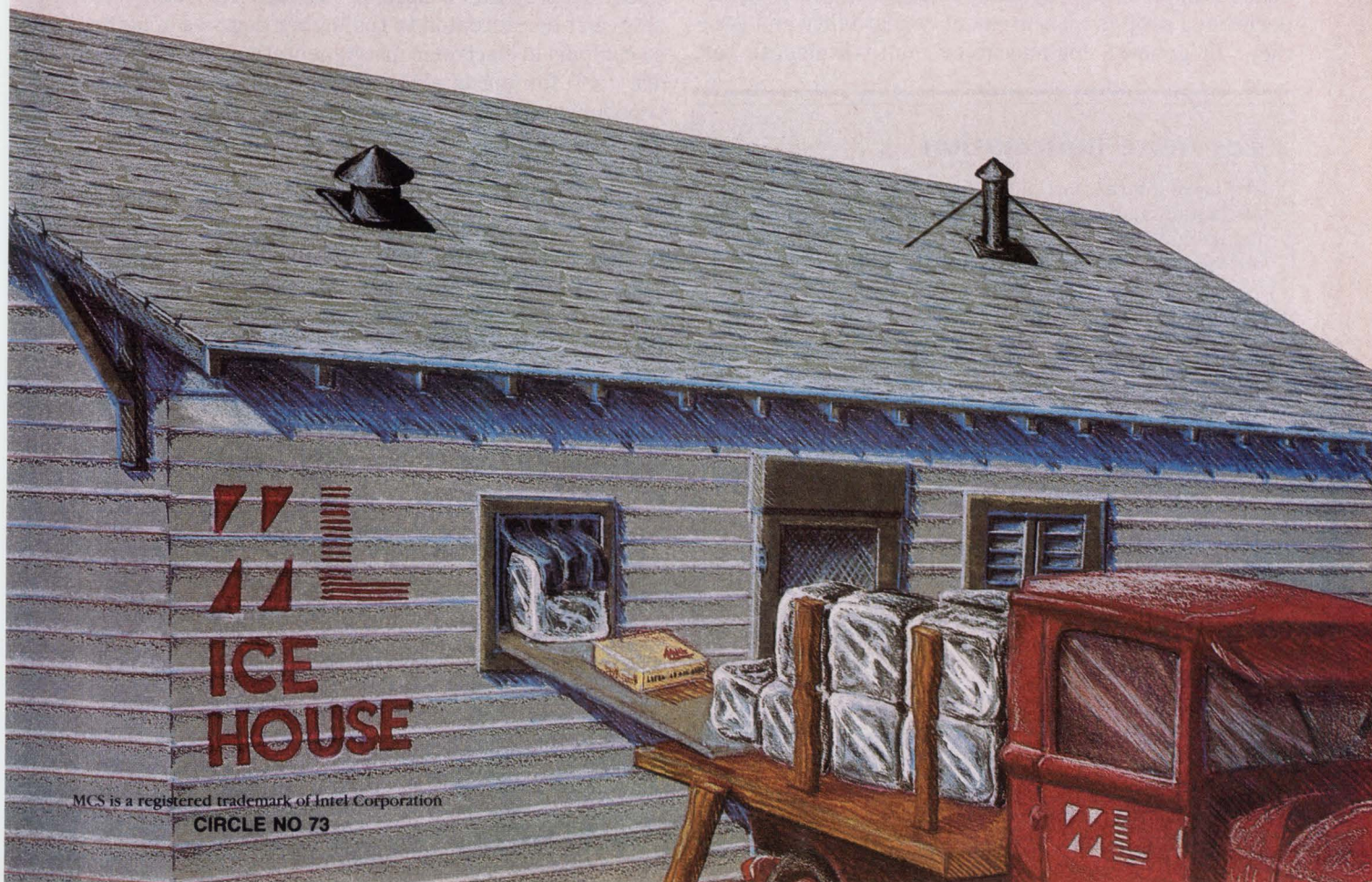

MCS is a registered trademark of Intel Corporation
CIRCLE NO 73

During a dead zone, the OTDR is virtually blind; the length of the dead zone is important in short-haul networks with connections occurring close together.



OTDR with a 5m dead zone (Laser Precision)

1800-nm range. However, the impedance of large-area Ge detectors drops rapidly as the temperature increases. Fig 3 shows a typical front-end amplifier for the power-measurement section of a test set. The photodiode impedance Z_{PH} should be high to ensure receiver sensitivity. To stabilize a large-area Ge detector's resistance, the test set must provide cooling.

Small-area (2- to 3-mm in diameter) detectors feature heat-insensitive high dynamic impedance, but they experience a drop in measurement repeatability and accuracy. In general, high-accuracy multiwavelength test

sets use large-area, cooled Ge detectors, and handheld multiwavelength power meters use small-area Ge detectors.

Silicon photodetectors are suitable for test sets that test at wavelengths in the 850-nm region, and they provide excellent response within that region. In addition, they have high Z_{PH} , which is not heat sensitive. Like germanium, the process of manufacturing silicon photodiodes is familiar and well understood.

InGaAs detectors are increasingly finding use for sensing longer wavelengths. They feature higher stability, higher dynamic impedance, and a wider dynamic range than Ge, and they do not require cooling. However, their manufacturing process is not as mature. Manufacturers have recently announced detectors as large as 3 mm in diameter, but at much higher prices than their Ge equivalents. In addition, InGaAs photodetectors' response is poor in the 850-nm region. Wilcom combines the advantages of silicon and InGaAs in its T3331-05 test set: The unit includes a silicon detector for the 850-nm region and an InGaAs detector for the 1300-nm region.

Because photodetectors have a relatively high uncertainty of precision caused by surface variations, test sets can't be calibrated to the higher degrees of accuracy common in electronic instrumentation. Typical specs are $\pm 4\%$ for uncertainty of the reference, $\pm 2\%$ for transfer uncertainty, and $\pm 3\%$ for the test set's precision uncertainty, yielding an overall uncertainty of precision of $\pm 5.4\%$.

In addition to their inexpensive cost (Table 2), test sets have the advantage of traceability to the National Bureau of Standards (NBS). Presently no independent calibration labs for fiber-optic test equipment exist, and so you must send your test set back to the manufacturer for calibration. To verify your readings of power measurements, you can arrange to use an NBS transfer-standard power meter; in return for use of the power meter, the NBS requests your test results to add to its databank.

EDN

For more information . . .

For more information on the fiber-optic OTDRs and test sets discussed in this article, contact the following manufacturers directly or circle the appropriate numbers on the Information Retrieval Service card.

Ando Electric Co
7617 Standish Pl
Rockville, MD 20855
(301) 294-3359
Circle No 718

Fotec Inc
Box 246
Boston, MA 02129
(617) 241-7810
Circle No 719

Hewlett-Packard
1900 Garden of the Gods Rd
Colorado Springs, CO 80901
(303) 590-2013
Circle No 720

Laser Precision Corp
1231 Hart St
Utica, NY 13502
(315) 797-4449
Circle No 721

Photodyne Inc
1175 Tourmaline Dr
Newbury Park, CA 91320
(818) 889-8770
Circle No 722

Tektronix
Box 4828
Portland, OR 97208
(800) 547-6711
Circle No 723

Wilcom/Plantronics
Box 508
Laconia, NH 03247
(603) 524-2622
Circle No 724

Article Interest Quotient (Circle One)
High 473 Medium 474 Low 475

Menu-Driven to Remember YOUR Needs!

With Philips' expanded new PM 3290/3280 Oscilloscope families, you get 350 or 175 MHz performance, plus advanced features like unique, menu-driven operation to help you perform...better, faster and easier.

■ **Programmable without a computer**, using 25 internal, user definable set-up menus to remember your specific test configuration (75 optional). Plus handheld IR remote control!

■ **Easy to use** with on-screen cursors, and with one-button AUTO-SET for immediate selection of optimal display parameters – amplitude, timebase, trigger functions, and screen positioning.

■ **Exceptional performance**, ultrafast writing speed of 4 div/ns and high intensity 24 kV (350 MHz) or 16 kV (175 MHz) CRT for display of even low repetition signals.

■ **At a glance status** and parameter read-out on screen, and now on backlit push-buttons and LCD's.



Test the difference

■ **Product Credibility** in technology, technique, quality and service is assured because Philips' PM 3290/3280 are backed by the corporate resources of one of the world's largest electronics companies.

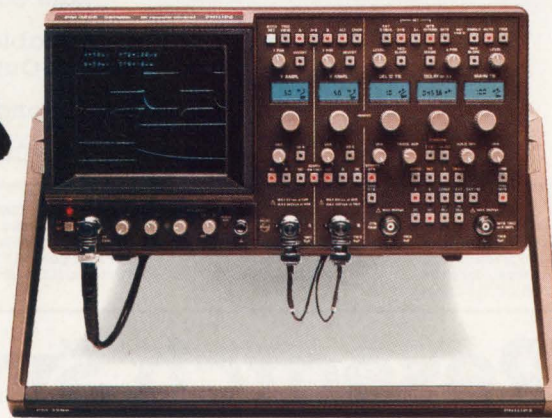

"Philips - the fastest growing force in oscilloscopes, logic analyzers, waveform analyzers, signal sources, counters/timers, digital multimeters and systems/IEEE instruments. Philips products are also available for lease through United States Instruments Rentals, Inc."

Write to: Philips Test & Measuring Instruments, Inc., 85 McKee Drive, Mahwah, New Jersey 07430 · (201) 529-3800, TWX: 710 988-5348. For the Philips Sales Office or Representative nearest you call Toll Free 800-631-7172.



**Test &
Measurement**

PHILIPS

New Precision Pulse Generator



Four Channels, 5 ps Resolution, and GPIB Interface...Price: \$2995

TIMING IS EVERYTHING

Your critical timing problems are over. No more worries about drift, jitter, or control. The DG535 Precision Pulse Generator has four delay channels (two pulse outputs), each with a 1000 second range and 5 ps resolution. The four independent delays specify two variable-width pulse outputs. With only 50 ps jitter and accuracy down to 1 ppm (option O3), the instrument can handle the most demanding applications. The internal trigger may be programmed from 0.001 Hz to 1.000 MHz, or operated in single-shot or burst modes. Output levels are continuously adjustable or may be set to TTL, NIM, or ECL levels. High impedance or 50 Ohm loads can be driven with a slew rate of 1 V/ns. Optional rear panel outputs generate pulses to 15 volts.

EASY TO USE

The delay and output levels for each channel may be entered numerically or modified by cursor keys on the backlit LCD display. Delays may be linked together so that as one moves, the other follows. Up to nine instrument settings may be stored in nonvolatile RAM for later recall, and, of course, all of the instrument's functions may be controlled via the GPIB interface.

A GENERATION AHEAD

The DG535's precision, accuracy, range, and versatility make it the solution to all your timing needs, at a price that will meet your budget. Call us today for more information.

FEATURES AND PERFORMANCE

- Four Delay Outputs
- Two Variable-Width Outputs
- Times from 0 to 1000 sec.
- 5 ps Resolution
- 50 ps rms Jitter
- 1 ppm Accuracy (Option O3)
- Internal or External Timebase
- Internal, External, Single-Shot, or Burst Mode Triggers
- Frequency Synthesized Rate Generator
- Variable, TTL, NIM, and ECL Outputs
- Optional 15-Volt Outputs
- GPIB Computer Interface

FRANCE

Optilas
c.e. 1422
9J019 Ferry Cedex
60774063, TLX 600019

GERMANY

Spectroscopy Instruments
Carl Benz Strasse 11
D-8031 Gilching
O 8105/5011, TLX 523862

JAPAN

Tokyo Instruments
Kojizumi Building
6-10-13-403 Nishikasai
Edogawa-ku, Tokyo 134
O3 (686) 4711, TLX J3264636

Seki and Company
1-2-6 Nihonbashi Ningyocho
Chuo-ku, Tokyo 103
O3 (669) 4121, TLX J24419

UNITED KINGDOM

Lambda Photometrics
Lambda House, Bedford Mill
Harpenden, Herts AL5 5BZ
O5827/64334, TLX 825889

Speirs Robertson
Moliver House,
Oakley Road,
Bromham, Bedford
O2302/3410, TLX 825633

Stanford Research Systems

460 California Avenue, Palo Alto, California 94306, (415) 324-3790, Telex 706891 SRS UD

Instruments

1G-sample/sec digitizing oscilloscope's CRT display shows waveforms in color

The HP 54111D digitizing oscilloscope digitizes at a 1G-sample/sec rate and stores samples in an 8k-byte-deep memory. It has a 250-MHz bandwidth for single-shot measurements and a 500-MHz bandwidth for equivalent-time measurements of repetitive signals, and it captures glitches as narrow as 1 nsec.

The instrument uses 6-bit digitizers. The manufacturer claims that, thanks to bandwidth-limiting digital filtering and low-noise circuitry the digitizers have virtually the same performance when running at high sampling rates in the presence of noise as their 7- and 8-bit counterparts. Maximum sweep speed is 500

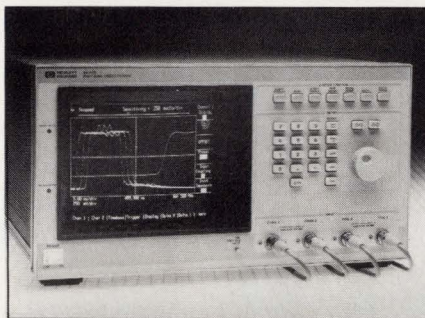

psec/div.

The scope has five custom parts: a GaAs track/hold circuit, a bipolar A/D converter, an NMOS timebase chip, an NMOS high-speed 2k×8-bit memory, and a 1-GHz SAW oscillator. It sports a 7-color CRT display and can print out hard copies on one of the company's printers or plotters

without the aid of a control computer. You can set the amount of time the scope will keep a trace on the screen. In its infinite-persistence mode, the scope never forgets any traces and will build up an envelope display of repetitive signals.

It can automatically measure frequency, period, pulse width, transition times, p-p amplitude, top- and base-voltage levels, preshoot, and overshoot. The scope automatically adjusts its sampling rate according to the sweep speed. \$23,900. Delivery, eight to 12 weeks ARO.

Hewlett-Packard Co, 1820 Embarcadero Rd, Palo Alto, CA 94303. Phone local office.

Circle No 404

Counter/timer incorporates integral CRT for softkey control, measurement analysis

The Model 2721 4-channel, 200-MHz counter/timer can automatically perform a variety of measurements, including frequency, period, time interval, pulse width, rise/fall time, frequency difference, and frequency ratio. In addition, a built-in CRT display allows you to view the input waveform so that you can perform time-interval measurements with the aid of two screen cursors.

The counter/timer's four input channels have a sensitivity as high as 15 mV rms, and you can select input hysteresis to eliminate false triggering on noisy inputs. You can manually adjust the two independent trigger levels or set them to 30% of the input waveform's peak-to-peak amplitude. In single-shot mode, you can measure time to a

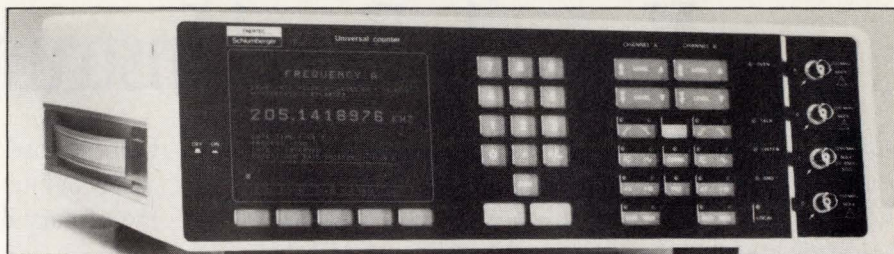

resolution of 10 nsec; an option allows you to increase single-shot resolution to 500 psec. In averaging mode, the time resolution is 10 psec. The counter/timer can also measure duty cycle, phase angle, positive and negative peak amplitude, and peak-to-peak values of the input waveform.

The unit includes math functions for postprocessing of measurement data. A recorder function allows you to display measured parameters as

function of time. An optional input channel extends the instrument's frequency capability to 1.25 GHz. Fr fr 32,500.

Enertec Instruments, 5 rue Daguerre, 42030 Saint-Etienne Cedex 2, France. Phone 77 25 22 64. TLX 300796.

Circle No 430

Solartron Instruments, 2 Westchester Plaza, Elmsford, NY 10523. Phone (914) 592-9168.

Circle No 431

Eye-Tech

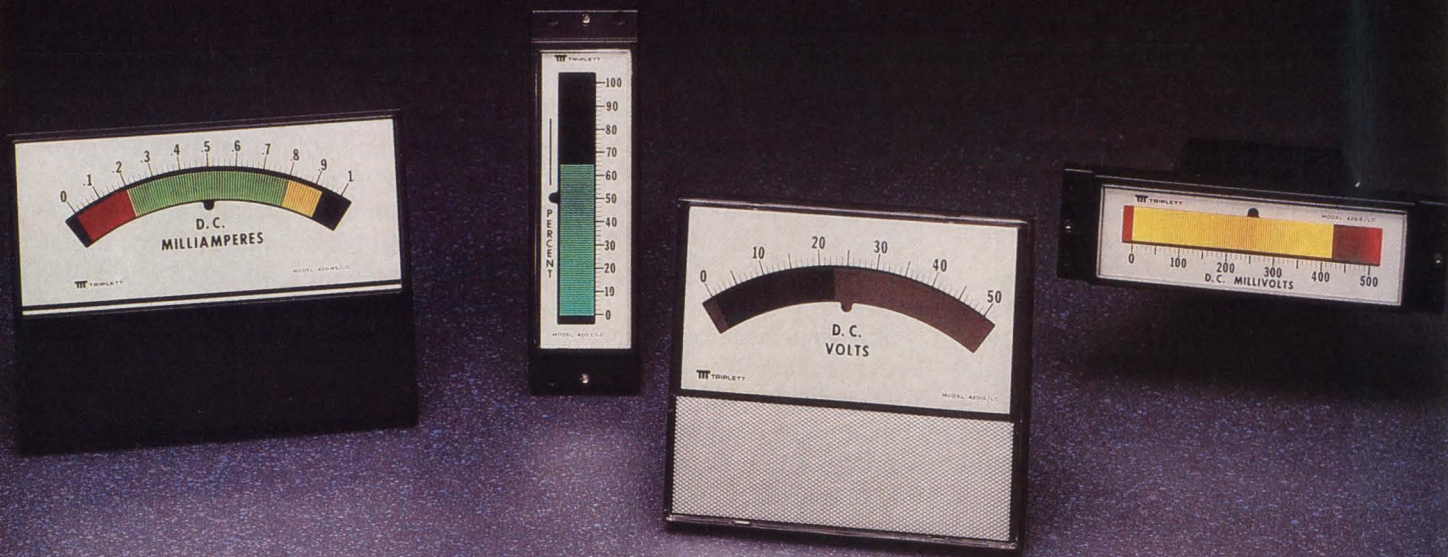

See Triplet Technology in a Different Light. Versatile Panel Instrumentation

Triplet announces a revolution in high-tech panel instrumentation: innovative, readable LCD bar graphs. These exciting panel meters further establish Triplet as the worldwide leader in the design and manufacture of panel instruments and test equipment.

Versatile. Computer-compatible panel meters come in 16 models and 13 modes. The 103-segment bar graphs are specifically designed as replacements for the popular 3.5 and 4.5 inch analog instruments, as well as for new installations.

Advanced. Triplet's technology offers you panel instrumentation that indicates data, high set point, low set point, both set points, peak, valley, both peak and valley and alternate between data and the six modes of display. The bar graphs are highly visible from a distance of 20 feet.

Colorful, back-lit displays are available in red, green, amber or blue. You may also choose any combination of these colors. Black on gray is standard.

Adaptable. Panel meters are available in the "G" Series curved display; the "WS" Series curved display and in the Edgewise Series, vertical or horizontal with a front or rear mount.

When you are looking for the finest in high-tech panel instrumentation, look to Triplet, the Company America has trusted for more than 80 years.

For more information, call 1-800-TRI-PLET ext. 51.



TRIPLET CORPORATION
A Perill Company

Instruments

Digital analysis system combines logic analyzer and word generator

The DAS 9200 digital analysis system—successor to the DAS 9100—can acquire 540 channels at 20M samples/sec from a 32k-sample memory when fully expanded. Alternatively, the modular instrument can capture 432 channels at 200M samples/sec from a 4k-sample memory or 160 channels at 2G samples/sec from an 8k-sample memory. Or, it can output 1008 stimulus channels at 50 MHz from an 8k-word memory. The instrument also handles as many as six μ Ps at one time.

The system's mainframe will hold eight pc-board modules; you can daisy-chain three additional expansion mainframes for a total of 28 slots. The modules in the slots can cross-trigger each other via a high-speed bus. Time correlation of data from separate modules allows the instrument to show real-time interaction

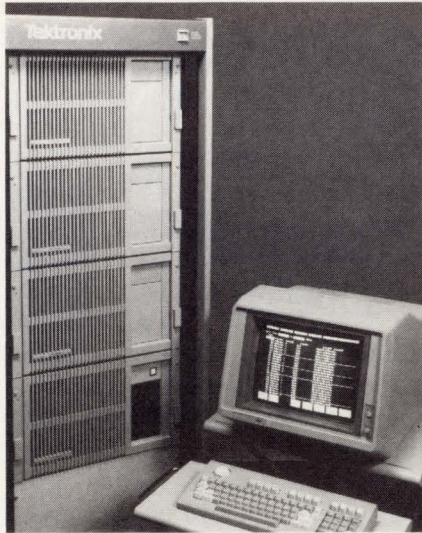

between independently clocked circuits.

Measurement modules include four timing- and state-analysis boards, two μ P-analysis boards, and a 2G-sample/sec timing-analysis

module. Stimulus modules consist of four pattern-generation boards: two sequential and two algorithmic units.

You can expand the system's software for data manipulation or analysis. In addition, the company offers application-software packages for μ P analysis, software-performance analysis, and ASIC-prototype functional verification. A basic system, with a terminal, costs \$11,425. An analyzer for general-purpose 8- and 16-bit μ Ps, with 200-MHz timing and 50-MHz pattern generation, is \$38,450. A system containing 256 stimulus and 256 acquisition channels is \$150,000. Delivery, four to 16 weeks ARO.

Tektronix Inc, Box 12132, Portland, OR 97212. Phone (800) 245-2036; in OR, (503) 231-1220.

Circle No 400

Analog oscilloscope features handheld remote control and choice of 75 settings

The PM 3296 350-MHz analog oscilloscope has a TV-style infrared remote-control unit that permits you to select from 25 front-panel-setting menus. As an option, you can expand the 25 settings to 75. To operate the remote-control unit, you first make a front-panel setting manually and then push a save button. Each setup specifies all display parameters: amplitude, timebase speeds, display positions, and trigger levels. You can alter one or all of the front-panel controls each time you store a setting. You can also control the scope via an optional IEEE-488 interface.

The scope features a 1-nsec rise



time and a 4-div/nsec writing speed. The unit's sensitivity is 1 mV, and its fastest sweep speed is 1 nsec/div. A dual-channel unit, it has a 24-kV CRT and a trigger-view feature. The trigger circuit's bandwidth is

400 MHz. You can capture and display an unknown or off-screen signal with the aid of an auto-setup button. The scope has cursors for measuring amplitude and time intervals.

The unit has switchable 1-M Ω /50 Ω inputs. Instead of reading switch settings from a graduated dial, you view each channel's settings and the timebase's settings on LCDs adjacent to the knobs. \$6400.

Philips Test & Measuring Instruments Inc, 85 McKee Dr, Mahwah, NJ 07430. Phone (201) 529-3800.

Circle No 405

Instruments

Waveform digitizer captures 1-GHz signals and specifies a resolution of 16 bits

Model 640, a plug-in for the company's Data 6000 mainframe, can capture repetitive signals at frequencies as high as 1 GHz at a resolution of 16 bits. The unit can resolve signals to 100 μ V with a bandwidth 1000 times greater than any other available 16-bit instrument. Its frequency range is dc to >1 GHz, and its noise level is better than -88 dB FS. The unit's rise time is less than 350 psec. In the equivalent-time, repetitive-sampling mode, the plug-in's minimum sampling interval is 10 psec/data point.

Each of the unit's four channels can handle as many as 16 inputs for



a total of 64. You can select either of two independent timebases and either of two trigger configurations. And you can select a data-record length of 32k samples (points). The unit comes with two input ranges: ± 2.5 and ± 25 V.

Because the digitizer plugs into the Data 6000 mainframe, you can perform a complement of analyses on a captured waveform. Time-domain functions include rms, p-p, mean, rise time, and pulse width. Frequency-domain measurements include FFTs, correlation, and convolution. Model 640 costs \$6895; the Data 6000 mainframe is \$5995 (8k-byte version); and a 32k-byte expansion memory for the mainframe sells for \$1550. Delivery, 12 weeks ARO.

Data Precision, 16 Electronics Ave, Danvers, MA 01923. Phone (617) 246-1600. TLX 6817144.

Circle No 406

400M-sample/sec digital oscilloscopes feature built-in color printers/plotters

The 4070 family of digital-storage oscilloscopes includes the 2-channel Model 4072 and the 4-channel Model 4074, each of which has an 8-bit, 400M-sample/sec CCD converter per channel. Each channel stores samples in a 1k-sample memory. An optional keyboard and firmware are available for data analysis.

The instruments have a bandwidth of 100 MHz for both transient and repetitive signals and can display captured samples using either linear or sine interpolation. The scopes capture signals with their digitizers and can also register 5-nsec glitches.

Their trigger circuits resemble the triggers of analog scopes, including highpass and lowpass filters, TV line or frame triggering, and dual delayed timebases. In addition,

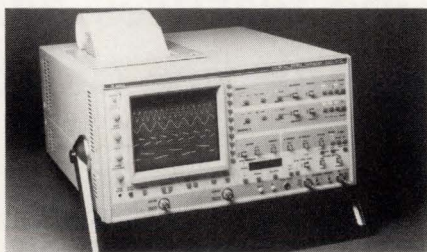

they can trigger when a signal is out of limits. The scopes have 10 \times 12-cm vector displays that show all setups plus 32 lines of data. They can duplicate their CRT displays on a built-in, 4-color plotter.

Four programmable reference setups are available for frequently used tests. The scopes also have an auto-setup feature that assesses an incoming signal and automatically determines instrument settings—input attenuation, timebase, etc—to provide quick acquisition and dis-

play of unknown signals.

The oscilloscopes are programmable via IEEE-488 and RS-423 interfaces. You can remotely control the instruments' front-panel settings and select from all menu items. In addition, signal processing, internal storage of setups, and a limits-test option help reduce interface overhead. Model 4072, \$8685; delivery, 45 days ARO. Model 4074, \$11,185; delivery, 90 days ARO.

Gould Inc, 10 Gould Ctr, Rolling Meadows, IL 60008. Phone (312) 640-4000.

Circle No 401

Gould Electronics Ltd, Instrument Systems Div, Roebuck Rd, Hainault, Essex IG6 3UE, UK. Phone 01-500 1000. TLX 263785.

Circle No 402

Low-cost microwave signal sources use GaAs FET oscillators with yig resonators

The 6150 Series, five electronically tunable signal sources, suit microwave testing. The units have sweep, AM, and FM capability; they cover the following microwave-spectrum ranges: 1.0 to 2.0 GHz, 2.0 to 8.0 GHz, 8.0 to 12.4 GHz, 10.0 to 15.0 GHz, and 12.0 to 18.0 GHz.

The sources use GaAs FET oscillators with yig resonators for stable, low-noise operation. Simple 10-turn controls allow adjustment of frequency and output level, and a 4-digit readout displays both values.

DC coupling allows full level control from an external input during sweep or cw testing. The dc-coupled

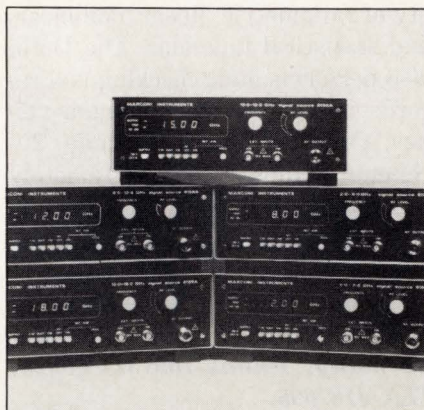

sweep input allows an externally driven, full sweep range. Normal FM allows ± 20 -MHz deviation at a maximum 100-kHz rate. You can

also use the FM input for phase-locking or for fine-tuning according to a given center frequency. The series' maximum output is 10 to 15 mW with low harmonic and spurious outputs.

Prices for the sources range from \$5540 to \$8265. When combined with a scalar analyzer, each source forms a scalar analysis system for swept-frequency testing applications of microwave components and subsystems.

Marconi Instruments, 3 Pearl Ct, Allendale, NJ 07401. Phone (201) 934-9050.

Circle No 403

Development systems work with IBM PCs, support 64180 μ P and 80515 μ C

Operating in conjunction with an IBM PC, PC/XT, or PC/AT or with a compatible computer, the CT64180 and CT80515 development systems provide program development, in-circuit emulation, and logic-state-analysis facilities for 64180 μ P and 80515 μ C designs. The symbolic debugger in each device uses both symbols defined in the assembly-language file and symbols defined during debugging.

The CT64180's assembler supports directives to manage the μ P's memory management unit, and it assembles as many as 3000 lines per minute on an IBM PC/AT. You can set as many as 64k real-time breakpoints, either singly or in ranges, throughout the 512k-byte addressing range of the 68140 μ P. You can also trigger breakpoints via two



32-bit event recognizers containing address, data, and control-line conditions. You can logically combine or sequence the two event recognizers, and you can specify the number of events to be recognized at each trigger level. A timer allows you to measure program-execution times, or to trigger a breakpoint after a defined period of time.

A 2048-word trace memory allows you to perform real-time traces of address, data, I/O ports, and control lines, plus eight external lines. The

development system comes with 16k bytes of emulation memory (expandable to 128k bytes), which you can map from the emulator to the target system in 4k-byte blocks.

The CT80515 development system has capabilities similar to those of the CT64180, and it supports all the 80515 μ C ports, including the A/D converter. Prices for the development systems are approximately Sw fr 20,000 for the CT64180 and Sw fr 17,900 for the CT80515.

Ashling Microsystems Ltd, Enterprise House, Plassey Technological Park, Limerick, Ireland. Phone (061) 338177. TLX 70182.

Circle No 428

Ashling Microsystems Inc, 542 Lakeside Dr, Suite 2, Sunnyvale, CA 94086. Phone (408) 720-9131.

Circle No 429

Instruments

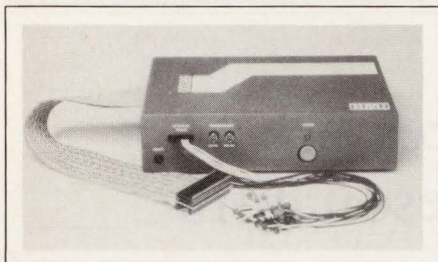

68000 EMULATOR

The first member of the HMI-200 Series of in-circuit emulators, the HMI-200-68000, works with 68000/08/10 μ P's and supports the virtual-memory features of the 68010. The instrument has a 256k-byte emulation memory (1M byte optional) and performs emulation at clock speeds to 12.5 MHz.

In addition, it has a pair of 4k \times 72-bit trace buffers. One trace buffer captures a trace history that ends at the emulation breakpoint; you can program the other buffer to capture selective records during emulation. The trace word records the state of the μ P's address, data, and status lines. The unit includes an interval timer, two RS-232C ports, and four event recognizers. HMI-200-68000, \$7500; IBM PC software, \$500.

Huntsville Microsystems Inc,
Box 12415, Huntsville, AL 35802.
Phone (205) 881-6005. TWX 510-600-8258.

Circle No 407

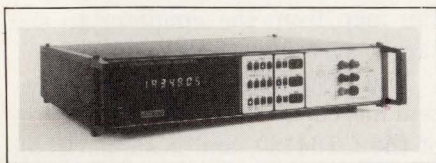

DMM

The Model 6031 DMM has an integration time of 20 msec to 20 sec, with corresponding increases in scale length from 4½ to 6½ digits. Basic 1-year dc-voltage and resistance accuracy is 0.003% (23°C, $\pm 5^\circ$ C), with corresponding resolutions of 100 nV and 100 $\mu\Omega$. DC-voltage zero-point stability is better than 5 μ V for 90 days, with a temperature coefficient of 0.3 μ V/ $^\circ$ C.

The ac-voltage function measures

dc- or ac-coupled true-rms values with a resolution of 10 μ V. The DMM also measures dc or ac current to 2A, and temperatures between -200 and $+850^\circ$ C.

Twenty chainable math functions include the application of an offset and multiplication factor and a variety of ratiometric, linear, nonlinear, and statistical functions. The DMM also performs limit checking and records maximum and minimum values. Options include a 4-pole, 20-channel scanner. You can remotely control the DMM and scanner via the DMM's IEEE-488 interface. Approximately DM 7000.

Prema GmbH, Robert-Koch-Strasse 10, 6500 Mainz 42, West Germany. Phone (06131) 50620. TLX 4187666.

Circle No 432

Prema Precision Electronics Inc, Sunset/Vine Tower, Suite 1126, 6290 Sunset Blvd, Los Angeles, CA 90028. Phone (213) 463-2294.

Circle No 433

FUNCTION GENERATOR

The PM5192 frequency synthesizer produces sine and square waves in the 0.1-mHz to 20-MHz frequency range and triangular and positive or negative ramp outputs to 200 kHz. You can set output amplitude as a peak-to-peak, root-mean-square, or decibel value, or you can step the output voltage. The maximum output amplitude is 20V p-p, and a dc offset control allows you to offset the output by as much as ± 10 V.

Modulation facilities include AM or FM modulation, with the AM depth programmable from 0% to 100%, and FM deviation programmable between 10 kHz and 200 kHz. The internal modulation frequency is fixed at 1 kHz, but you can use an external modulation source between 10 Hz and 200 kHz. You can also gate the output.

Sweep capabilities include single or repetitive phase-continuous sweeping of the synthesizer's entire

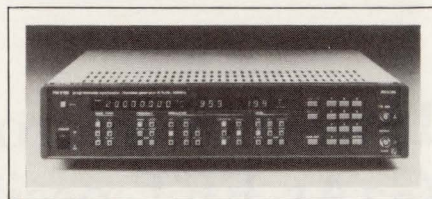

frequency range. You can perform linear or logarithmic sweeps with sweep times from 10 msec to 999 sec; a hold facility allows you to stop the sweep temporarily. Nonvolatile storage of as many as 10 front-panel settings and an IEEE-488 remote-control interface are standard features. \$3995.

Philips Industrial & Electro-acoustic Systems Div, Box 523, 5600 AM Eindhoven, The Netherlands. Phone (040) 757005. TLX 51573.

Circle No 434

Philips Test & Measuring Instruments Inc, 85 McKee Dr, Mahwah, NJ 07430. Phone (201) 529-3800.

Circle No 435

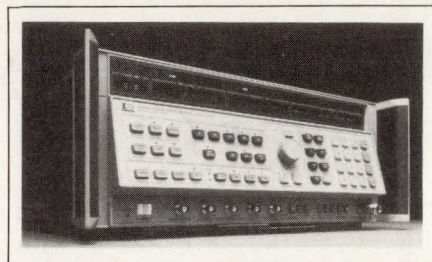

SWEeper

The HP 8341B synthesized sweeper features an analog-sweep input and delivers 10-dBm output power over the 10-MHz to 20-GHz range. Operating as a synthesized signal generator, it can perform AM, FM, and pulse modulation simultaneously. Frequency resolution varies between 1 and 4 Hz, depending on the frequency band. Phase noise is -80 dBc/Hz at 10-kHz offset from a 10-GHz carrier. For sweeps as wide as 5 MHz, the swept signal is phase continuous. A low-harmonics option keeps harmonics and subharmonics below -50 dBc from 1.4 to 20 GHz. Including the low-harmonic option, the IEEE-488-compatible instru-

Instruments

ment costs \$41,000. Delivery, six weeks ARO.

Hewlett-Packard Co, 1820 Embarcadero Rd, Palo Alto, CA 94303. Phone local office.

Circle No 408



SYNTHESIZED SOURCE

The 6061A synthesized signal generator specs 10-Hz resolution over the 10-kHz to 1.05-GHz frequency range. The amplitude range is -127 to +13 dBm, the resolution is 0.1 dB, and the absolute accuracy is ± 1 dB. The instrument accepts both external AM and FM and is reverse-power protected against 50W of RF. It has a nonvolatile memory capable of storing 50 instrument setups. Options include two reference oscillators, one with an aging rate of $< \pm 1.5 \times 10^{-8}$ /month (\$850), and one with an aging rate of ± 0.1 ppm/month over 0 to 50°C (\$300). \$5695.

John Fluke Mfg Co Inc, Box C9090, Everett, WA 98206. Phone (800) 426-0361; in WA, (206) 347-6100.

Circle No 412

AUDIO ANALYZER

The VP-7722A audio analyzer performs 11 types of signal-analysis tasks in the categories of distortion analysis and level measurement. Typical measurements include total distortion factor, total harmonic distortion (THD), signal-to-noise ratio, and intermodulation distortion. The instrument stores as many as 100 data points, which you retrieve by pressing keys on the unit's front panel. You can also control the instrument through an IEEE-488 interface, which is standard. A plotter-output interface lets you obtain a hard copy of 32 acquired values.

EDN December 25, 1986



Let Lab Boss™ turn your IBM PC into a powerful instrument controller.

You can spend thousands of dollars for a dedicated instrument controller. Or a few hundred for a controller that's dedicated to you and your IBM PC.

Lab Boss™ from National Instruments puts you and your IBM PC (or compatible) firmly in charge of GPIB instruments. From sophisticated laboratory equipment, like digitizing oscilloscopes and spectrometers, to standard printers, plotters, tape drives and more. At data transfer speeds

that are the highest in the industry.

And Lab Boss products offer a direct data link from your measuring equipment to a full range of analysis software, including RS/1, Lotus 1-2-3, and Symphony. So you can easily report your findings on the same system you used for instrument control, data acquisition and analysis. Try that on a dedicated controller! So — you want to be the boss? Call National Instruments. 800/531-4742.

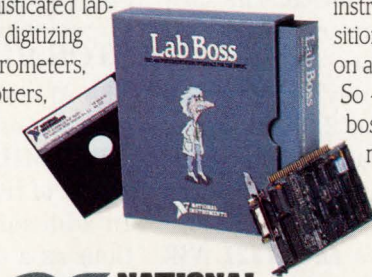

NATIONAL INSTRUMENTS

12109 Technology Blvd.
Austin, TX 78727 512/250-9119

CIRCLE NO 18

Instruments

The X- and Y-axis coordinates are preset. An internal signal generator provides an audio-range output signal with very low distortion (0.0001% THD) between 10 Hz and 110 kHz. The unit also measures a signal's frequency with 5-digit accuracy between 10 Hz and 110 kHz. \$10,130.

Matsushita Communication Industrial Co Ltd, 3-1, 4-Chome, Tsunashima-Higashi, Kohoku-ku, Yokohama, Japan. Phone (045) 531-1231. TLX 3822671.

Circle No 438

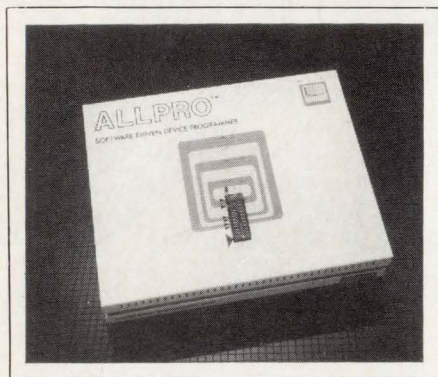

PLD SOFTWARE

Allpro version 2.0 facilitates software development for PLDs and single-chip μ Ps as well as standard ROMs. The software generates test vectors, performs functional tests and simulates devices, translates macrocells, and edits fuse maps. The test-vector generator supplements the test vectors normally included in a standard JEDEC file. The macrocell-translation feature allows you to convert a portion of a design in a large PLD into a program for a smaller device. The software package runs on any IBM-compatible computer that attaches to the company's device programmer. Allpro version 2.0 and device programmer, \$2900. You can purchase yearly updates of the device library.

Logical Devices Inc, 1321 NW 65th Pl, Fort Lauderdale, FL 33309. Phone (305) 974-0975. TLX 383142.

Circle No 409

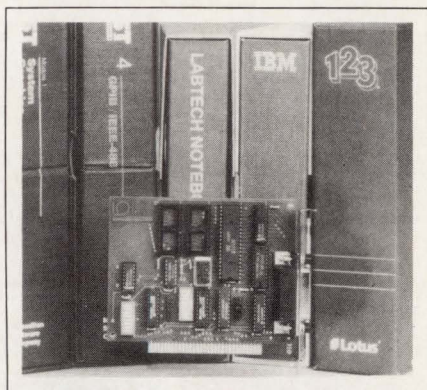

GPIB INTERFACES

The GP488 and the LPT488, two IEEE-488 interface boards for the IBM PC, allow access to IEEE-488 instruments and IEEE-488 printers or plotters, respectively. The GP488 links instruments to the PC and works with data-analysis software packages such as Labtech Notebook; it has high-speed DMA capability. The LPT488 requires no special software drivers to provide communications between a PC and IEEE-488 printers and plotters; the PC's operating system recognizes the board as a line printer, not as a special interface. The GP488 and LPT488 each cost \$295.

Iotech Inc, 23400 Aurora Rd, Cleveland, OH 44146. Phone (216) 439-4091.

Circle No 410

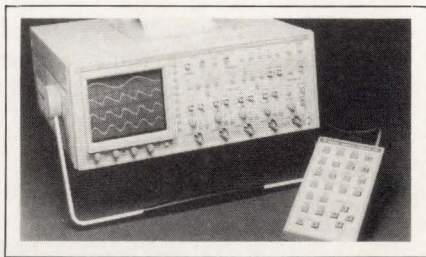

STORAGE SCOPE

The Model 1604 4-channel digital storage oscilloscope incorporates two 20-MHz, 8-bit digitizers and 10k words of trace memory per channel. In addition, the oscilloscope functions as a dc to 20-MHz nonstorage scope. An autoset function automatically selects suitable timebase, trigger, and vertical-deflection sensitivities for repetitive input

signals.

When the instrument is in storage mode, it can simultaneously record as many as four traces with durations from 30 minutes down to 20 μ sec, and it can capture glitches as short as 50 nsec. Screen cursors allow you to make measurements on captured waveforms. The oscilloscope's trigger facilities include pre- and post-trigger view, trigger windows, and HF trigger rejection. You can introduce a post-trigger time delay or an event delay.

A built-in 4-color plotter produces hard-copy traces. Options include nonvolatile memory modules for trace storage, IEEE-488 and RS-423 interfaces, and a plug-in waveform-processing keypad. From £3434.

Gould Electronics Ltd, Instrument Systems Div, Roebuck Rd, Hainault, Essex IG6 3UE, UK. Phone 01-500 1000. TLX 263785.

Circle No 436

Gould Inc, Recording Systems Div, 3631 Perkins Ave, Cleveland, OH 44114. Phone (216) 361-3315.

Circle No 437



VLSI TESTER

The STM5100 digital-VLSI tester has 256 test pins, each of which can be an input, an output, or a bidirectional pin. You can change a pin's assignment at any time during the 20-MHz test cycle. Pin assignments are software programmable with the aid of an IBM PC; the tester requires no hardwiring to configure its pins. Each pin has a 64k-bit test-vector memory. You can program pin levels in 20-mV increments, and you can program as many as 10

Instruments

pin-output formats (for instance, return to zero).

Edge placements and pulse widths are programmable to 1-nsec resolution. The unit automatically deskews its channels. It has a 32k-word automatic pattern generator. Prices start at \$60,000.

Cadic, 7874 SW Nimbus Ave, Beaverton, OR 97005. Phone (503) 626-7902.

Circle No 413



EEPROM PROGRAMMER

The Writer-1 comes with a 32k \times 8-bit RAM and programs most EEPROMs and EPROMs having 256k-bit capacity or less. The programmer sports a 6-character LED display and a 30-key, full-travel keyboard. It requires no personality modules or adapters, uses one 28-pin ZIF socket, and executes intelligent programming algorithms. The unit's RS-232C port accepts device-program files in 12 common formats. \$495.

Bytek Corp, Instrument Systems Div, 1021 S Rogers Circle, Boca Raton, FL 33431. Phone (800) 523-1565; in FL, (305) 994-3520.

Circle No 411

DIGITAL SCOPE

Besides operating as a dual-trace, 20-MHz oscilloscope, the MS-1660 scope lets you digitize and store 2048 bytes on each of its two input channels. The maximum writing speed is 1 μ sec/byte. Two independent sampling clocks let you record two events at different rates. Also, recording the same event at low and

high speed lets you expand or compress the information upon playback. A battery backs up the storage memory for as long as 200 hours.

You can select several operating modes that let you set the trigger point for data-storage operations at one of several points in the input-data stream. The scope provides outputs that drive an X-Y plotter, which generates a hard copy of recorded events. An IEEE-488 interface connector lets you control the scope from a computer or another instrument. \$3637.

Kenwood Corp, Test & Measuring Instrument Dept, 17-5, 2-Chome, Shibuya, Shibuya-ku, Tokyo 150, Japan. TLX 2423446.

Circle No 439

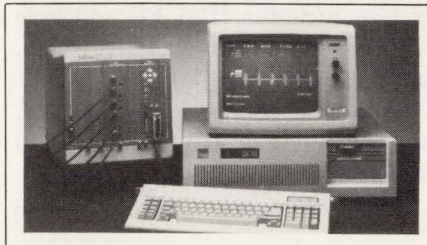

WAVEFORM RECORDER

Model 6810 is a 4-channel, 5M-sample/sec, 12-bit waveform digitizer. Each channel has its own track/hold circuit, which is multiplexed into a single D/A converter.

The instrument features a 512k-sample memory; you can expand this memory to 8M samples with add-in modules. Memory segmentation with 32-bit time stamping allows continuous sampling of repetitive signals at low-duty cycles. The instrument can also sample at two different sample rates during one test cycle. The input range is programmable from 0.4 to 100V FS. You can control the digitizer via RS-232C or IEEE-488 interfaces. \$5500; memory modules, \$1990. Delivery, 45 days ARO.

LeCroy, 700 S Main St, Spring Valley, NY 10977. Phone (914) 578-6084. TWX 710-577-2832.

Circle No 417



80386 EMULATOR

The Mice-32/80386 performs real-time emulation at clock rates to 16 MHz and has a 256k-byte emulation memory that introduces no wait states to 12.5 MHz. This emulator supports dynamic bus sizing in both target and emulation memory as well as pipelined and nonpipelined addressing. And it emulates both protected and real-address modes.

The unit has a 2k \times 104-bit trace memory, which includes the μ P's pins in addition to a 24-bit time stamp and eight external lines. With this emulator, you can also perform software analysis. The unit displays software-performance histograms on a CRT. \$14,000.

New Micro Inc, 16901 S Western Ave, Gardena, CA 90247. Phone (213) 538-5369. TLX 797880.

Circle No 414

GANG PROGRAMMER

The PP41, an 8-position gang programmer, handles NMOS and CMOS EPROMs and EEPROMs. The unit programs most 24- and 28-pin parts, including one-time-programmable devices, and executes intelligent programming algorithms for larger devices. A plug-in adapter handles leadless devices. The programmer comes with a 512k-bit memory, which is expandable to 1M bit. Two RS-232C ports enable you to place the unit in series

Instruments



with your CRT or personal computer. The programmer accepts common device-file formats and automatically checks each device before programming. \$1750; 1M-bit version, \$2100.

Stag Microsystems Inc, 528-5 Weddell Dr, Sunnyvale, CA 94089. Phone (800) 227-8836; in CA, (408) 745-1991.

Circle No 415

PROM PROGRAMMER

The LEP-1200A PROM programmer programs as many as 10 devices simultaneously. Programmable devices include the 27XXX family from models 2716 through 27256 as well as PROMs in the 25XXX family. The programmer also programs 68766 chips. A readily accessible DIP switch lets you manually select the type of PROM you will program. You also select a 12.5, 21 or 25V, programming voltage.

Two pushbuttons start internal test routines that check the PROMs for complete erasure or verify the PROMs against a master PROM. A third button starts a programming sequence that programs the PROMs from a master device. Before programming starts, the programmer performs the erasure test on each of the PROMs you want to program. After programming the PROMs, the unit automatically runs the verification test for each PROM. LEDs indicate the status of each PROM in the programmer. The programmer operates from 120 or 220V ac. \$675.

Leap Electronics Co Ltd, Box 91-249, Taipei, Taiwan, ROC. Phone (02) 253-3193. TLX 26976.

Circle No 440

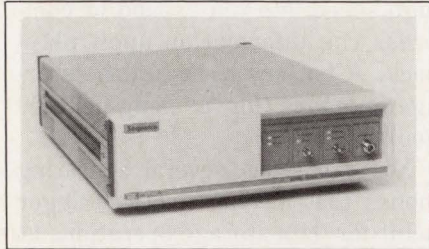

WAVEFORM DIGITIZER

The Model 3000 waveform digitizer has a sample rate of 1G samples/sec, an amplitude resolution of 10 bits, and a 1024-sample capture memory. At its full single-shot, analog bandwidth of 350 MHz, the digitizer exhibits an effective resolution of 7.0 bits. Its aperture jitter is <3 psec rms, and its differential nonlinearity is $<\pm 0.05\%$ FS ($\pm \frac{1}{2}$ LSB at 1 MHz). The maximum input voltage is 5V rms (dc coupled); the input sensitivity is 50 mV/div. The digitizer also includes IBM PC software for instrument control, data display, and data analysis. \$30,000.

Sequence Inc, 1650 Zanker Rd, San Jose, CA 95112. Phone (408) 436-6065.

Circle No 416



ISDN TESTER

The Chameleon 32 protocol analyzer can directly connect to a 1.544M- or 2.048M-bps ISDN primary-rate interface. In addition, the analyzer handles other common protocols such as X.25, SNA/SDLC, and Bisync/Async. It has a 144k-byte capture memory and a 20M-byte hard disk. You can program test routines in C or use libraries of tests from the manufacturer. Standard interfaces include four RS-232C ports, a Centronix port, a SCSI interface, and an IEEE-488 port.

The instrument has a color CRT. Prices start at \$21,900.

Tekelec, 26540 Agoura Rd, Calabasas, CA 91302. Phone (818) 880-5656.

Circle No 418



IMAGE MANIPULATOR

The Model 67114 image manipulator accepts a standard monochrome RS-170 video signal, enhances the signal's gray-scale information, and then presents a 3-D display in real time. The image manipulator utilizes the following capabilities during the enhancement process: rotations about 3 axes, zoom/compression, Z-axis deflection gain, translations, geometric perspective, shading, and cropping and slicing. The instrument is also available without the display monitor. \$13,000. Delivery, 90 days ARO.

Imaging Dimensions Inc, Box 22860, Tucson, AZ 85734. Phone (602) 624-8358.

Circle No 419

TEST SET

You can test and reconfigure RS-232C signals by using the T-008 Tri-States tester. The unit's 13 three-color LEDs indicate the states of 13 RS-232C signals. The LEDs monitor pins 2 through 6, 8, 15, 17, 20 through 22, and 25. One LED is unconnected and can be used to monitor any other signal. A 9V battery powers the LEDs, so no power is drawn from the RS-232C devices you monitor.

A row of 24 DIP switches lets you break the signal connection through the unit for any of the signal lines. Pin 1 is wired directly from connector to connector and you cannot disconnect it. Jumper connections for

Continued on pg 122

EDN December 25, 1986

Instruments

the remaining 24 pins on each RS-232C connector let you reconfigure the signals for special tests or special interface requirements. Extra DIP switches let you change the DTE, DCE, CTS, DSR, and DCD connections. A switch also lets you quickly swap lines 2 and 3 for modem tests. The unit includes two DB-25 connectors. \$71 (100).

Dual Enterprises Corp, Box 12369, Taipei, Taiwan, ROC. Phone (02) 752-7683. TLX 10927.

Circle No 441



50-nsec resolution. The unit includes 16-, 20-, and 24-bit data qualification along with 16 channels of 5-nsec glitch capture. The glitch-capture feature doesn't affect the unit's memory depth or width. The trigger circuit's state machine can perform three functions during each of its 15 levels of triggering. \$6950; 4k-sample-memory version, \$7650; Colt mainframe, \$9995; Atlas mainframe, \$11,500.

Dolch Logic Instruments, 2029 O'Toole Ave, San Jose, CA 95131. Phone (800) 538-7506; in CA, (800) 223-2077.

Circle No 421



PLD PROGRAMMER

The Promac P3 handles most 20-, 24-, and 28-pin PLDs. Further, you can program a 256k-bit EPROM with a given PLD's JEDEC file (pin assignments, equations, fuse pattern, and test vectors). Once you've programmed the EPROM, it allows you to program PLDs without downloading a device file from a computer. The programmer has a resident Palasm assembler. \$2695.

Promac Programming Instruments, 2999 Monterey/Salinas Hwy, Monterey, CA 93940. Phone (408) 373-3607. TLX 882141.

Circle No 420

ANALYZER PLUG-IN

The Model 9602-64 64-channel logic-analyzer plug-in works with the manufacturer's Colt and Atlas mainframes. Providing 64 channels of state and timing data at 20 MHz, it has a 1k-sample memory (expandable to 4k), and a time stamp having

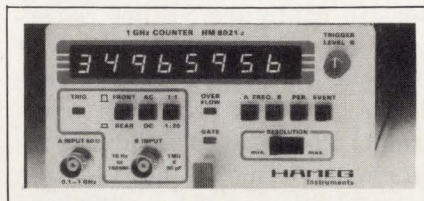

FREQUENCY COUNTER

The HM8021-2 is an 8-digit frequency counter that covers the range of 0.1 Hz to 1 GHz. It can also measure periods from 1 μ sec to 100 sec. The instrument has an LED display and specs 20-mV sensitivity. You can input a signal via the unit's front-panel BNC connector or via a rear-panel connector if the unit is operating with the manufacturer's other modular units. The counter's 10-MHz ovenized timebase exhibits $\pm 5 \times 10^{-7}$ TC (10 to 40°C) plus $\pm 1 \times 10^{-7}$ /month aging. \$324.

Hameg Inc, 88-90 Harbor Rd, Port Washington, NY 11050. Phone (516) 883-3837. TWX 510-223-0889.

Circle No 422

MODUTEC'S BIG-LITTLETM GETS BOLDER & BRITER



THE WORLD'S ONLY LCD DPM WITH SUPER-BRITE LED BACKLIGHTING.

A cost-saving breakthrough! By using LED's...with 100K hours of life...for backlighting, Modutec's new LCD Big-Little DPM's now provide high visibility in daylight, nightlight, any light. You have a choice of red or green economical backlighting plus plug-in compatibility with Modutec standard LCD Big-Little DPM's. Backlighting power is 5, 12, 24 VDC or 115 VAC. Displays are -20°C to +65°C operating and storage with 3½ digits, ½" high, full scale of 1999. Actual size: 2.36" L. x .95" H. x .51" D. Enjoy the benefits of low power consumption with Modutec's LCD DPM featuring an LED look.

Additional features:

- * ± 200 mV or ± 2 V input * 3 power options: 9V battery, ± 5 VDC or ± 5 VDC
- * Window or bezel mount
- * Accuracy: $\pm (0.1\% + 1 \text{ count})$

For a day/night demonstration, contact your local Modutec sales representative, distributor or MOD Center, nationwide.

MODUTEC



BORN
IN
AMERICA



MODUTEC, INCORPORATED
P.O. BOX 778, 18 MARSHALL ST.,
NORWALK, CT 06856-203/853-3636.
1-800/METERS-1 TWX 710-468-2039

Instruments

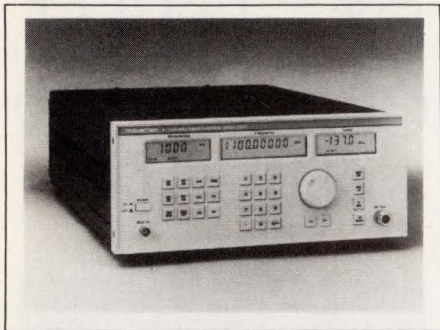

SIGNAL GENERATOR

Model 2500, a phase-locked, synthesized signal generator, covers the frequency range of 400 kHz to 1.1 GHz. Its standard timebase is accurate to 5×10^{-8} /month. The unit has built-in self-test and automatic-calibration capabilities and is reverse-power protected against 50W. It has internal AM and FM sources and will accept external modulation sources; the maximum FM deviation is 1 MHz. The signal generator is capable of storing 15 setups internally. An IEEE-488 interface is standard. \$5695. Delivery, 60 days ARO.

Wavetek Indiana Inc, Box 190, Beech Grove, IN 46107. Phone (317) 788-5980. TWX 810-341-3226.

Circle No 423

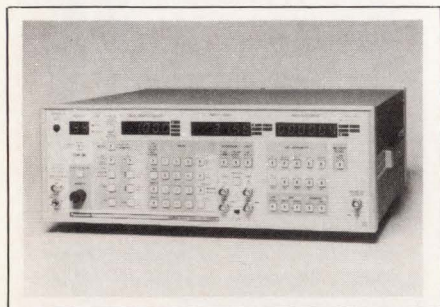

AUDIO ANALYZER

The Model VP-7722P dual-channel audio analyzer has a built-in programmable audio oscillator that specs 0.0001% distortion typ. The analyzer covers the 10-Hz to 110-kHz range. Its level meter provides 300- μ V sensitivity. The unit performs seven basic measurements: distortion, S/N ratio, ac level, L/R-R/L ratio, intermodulation distortion, frequency (5-digit resolu-

tion), and signal strength. In addition, it can also measure SINAD and THD.

Via its standard IEEE-488 port, the unit can generate plots on an IEEE-488 plotter without the aid of a controller. It can memorize a 100-step measurement sequence. \$6380. Delivery, stock to eight weeks ARO.

Panasonic Industrial Co, Box 1503, Secaucus, NJ 07094. Phone (201) 392-4050.

Circle No 425

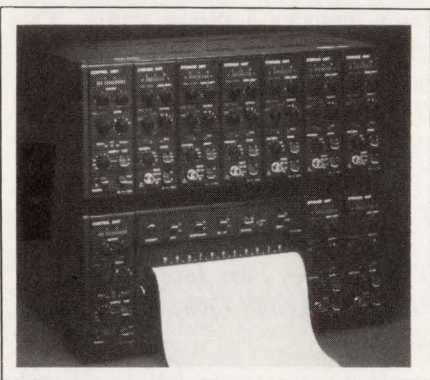

WAVEFORM RECORDER

You can configure SE 560 Series waveform recorders to have 1 to 30 channels. These recorders can handle signals to 250 kHz. Each input-channel module features floating inputs with 50 mV to 50V voltage ranges. Each module has a 16k-byte memory for captured 8-bit signals and independent level and slew-rate triggers. You can control most functions via an RS-232C or IEEE-488 interface. The starting price for a single-channel system is \$2840. Delivery, four to eight weeks ARO.

BBC-Metrawatt/Goerz, 2150 W 6th Ave, Broomfield, CO 80020. Phone (800) 821-6327; in CO, (303) 469-5231.

Circle No 424

SPECTRUM ANALYZER

The HP 8590A spectrum analyzer covers 10 kHz to 1.5 GHz with 4-digit resolution. It weighs 29.8 lbs—20 lbs less than other portable spectrum analyzers. The unit has a

-115- to +30-dBm amplitude range (70 dB displayed). It features single-function pushbuttons for performing common measurements and has menu-labeled soft keys for less-common ones. While you manipulate front-panel controls for frequency, span, and amplitude, the analyzer automatically adjusts internal parameters such as resolution bandwidth, sweep time, IF gain, and input attenuation. IEEE-488, HP-IL, and RS-232C interfaces are optional. \$9500.

Hewlett-Packard Co, 1820 Embarcadero Rd, Palo Alto, CA 94303. Phone local office.

Circle No 426

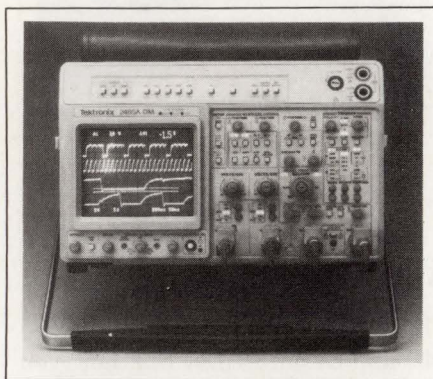

PORTABLE SCOPES

The 2445A/2465A family of 4-channel oscilloscopes has dual, delayed-sweep timebases and on-screen measurement cursors. The family includes the 150-MHz 2445A, the 250-MHz 2455A (export only), and the 350-MHz 2465A. The scopes operate at their full bandwidths with 2 mV/div sensitivity. You can store 20 complete front-panel setups. All the scopes have IEEE-488 interfaces and an auto-setup button; options include programmable DMM and counter/timers, video triggering, and word recognition for digital applications. Prices start at \$3590 for the 150-MHz 2445A and \$5350 for the 350-MHz 2465A.

Tektronix, Box 1700, Beaverton, OR 97075. Phone (800) 426-2200; in OR, (503) 627-9000.

Circle No 427

What? Who? You? Why?

ADEE is the only conference/exhibition on the west coast that focuses on the real, practical applications of Computer Aided Engineering (CAE) and Design (CAD) for the design of electronic circuitry.

The major vendors of CAE/CAD technology will be on hand—all of them presenting their latest innovations and all of them concentrating on real tools you can put to work right now.

Whether you design logic, IC, or printed circuitry or systems, you'll soon need to acquire or expand your use of this powerful technology. That is, if you want to stay competitive.

- Because you'll have a chance to meet with the leading suppliers of CAE/CAD technology and see their products in action.
- Because you'll have a chance to compare and evaluate hundreds of systems.
- And because of "CIRCUITPATH." It's a working, multi-company demonstration that addresses the challenge of integration. "CIRCUITPATH" will take you, step-by-step, through a typical design cycle showing how each element in this integrated CAE/CAD system contributes to the design of a single product. It proves the challenge can be met and conquered with existing technology.
- You can also take advantage of technical presentations—a user-oriented program tied closely to the exhibition to make the real technology as accessible and manageable as possible for you.



Sponsored by:
EDN

Endorsed by:
• Electronic Business
• Electronic Packaging and Production
• Design News
• Semiconductor International

Please send advance registration information on ADEE West '87, including details of the exposition and conference program.

Name _____ Title _____

Company _____

Address _____

City _____ State _____ Zip _____

Bring a team to ADEE! Photocopy this coupon for your colleagues. Return to ADEE West '87.

CEG Cahners Exposition Group
Cahners Plaza, 1350 E. Touhy Ave.
Des Plaines, IL 60017-5060
Telephone: (312) 299-9311
Telex: 256148 CEGCGO DSP (Domestic)
82882 CAGCHGO (International)

Display modules span existing technologies, suit diverse uses

Your choices in building a display subsystem are to buy displays by the character and then design the drive electronics yourself, or to save design time by purchasing a turnkey, intelligent display module. Products in both categories offer variety in power consumption, ruggedness, aesthetics, and price.

Tarlton Fleming, Associate Editor

Electronic systems are gaining greater ability to monitor complex phenomena, handle volumes of transactions, and report the resulting status information to human operators. The system designer can meet the need to convey this information in a clear, efficient manner by including a CRT—which remains the most effective display for handling large volumes of information—or by turning instead to smaller but less expensive modular displays. These products offer wider viewing angles, higher contrast, greater brightness, and more character positions than ever before. Some are intelligent, software-programmable devices that let you blink, blank, underline, edit, and scroll the display.

Manufacturers are building CRT-sized flat-panel displays that use the same technologies employed by the



Fig 1—This 40×64-in. gas-discharge display panel includes 48 modules from Displays Inc. Each module contains two 20-character rows of 1.0-in.-high characters.

smaller modules (**Ref 1**). Because these larger products display 25 lines of 80 characters each, they can substitute for bulkier, less rugged CRTs in applications that justify the higher cost. But the majority of display applications—most instruments, office and telecomm equipment, gas pumps, point-of-sale and industrial-control systems, and the control panels in ships, planes, and automobiles—call for less than a full CRT of information at one time.

The top-of-the-line display modules are the software-programmable, turnkey systems. You may save money, however, by designing your own electronics for a dis-

play that's part of a product to be manufactured in large volume. Starting with one or more single- or multiple-character displays, you add the display-driver and multiplexing circuits, the character-generator ROM, and the character-refresh RAM, and then you arrange to feed information to the display from an operator terminal or system memory.

Displays without drivers

Mature display products that lack the associated electronics use either the line-segment format or the more versatile dot-matrix format to produce characters, and they employ active or passive technologies. You'll need an active, light-emitting display technology for use in low ambient light. Displays that serve in such environments include light-emitting diodes (available from Hewlett-Packard, Siemens, and IEE, for example) and gas-discharge (GD) displays (available from Babcock, Dale Electronics, and Displays Inc, for example). Vacuum-fluorescent (VF) and electroluminescent (EL) displays also produce light, but the associated electronics are usually included.

Among the passive display types, liquid-crystal displays are well known for their dependence on ambient light in achieving acceptable contrast between the character and its background. This fact applies to the reflective types; transmissive LCDs make use of a light source on the side opposite the viewer. Although you can see a transmissive LCD in the dark, the additional power consumed by the light source may negate the LCD's primary advantage—low-power operation. A third type, the transreflective LCD, employs both transmitted and reflected light to achieve contrast.

All three types of LCD are available from Hamlin, which is by far the largest manufacturer in this country to offer a selection of "bare" LCD modules—that is, modules without drive electronics. These products include reflective, transmissive, and transreflective types that feature dot-matrix or segmented characters with 0.35- to 1.0-in. heights. The modules serve both direct-drive and multiplexed applications, in configurations ranging from a 2-character module (the \$1.75 Model 3935, 1000 qty) to one with four rows of 20 characters each (the \$24 Model 4297, 1000 qty). All are twisted-nematic (TN) LCDs.

In a conventional TN LCD, the liquid-crystal material imposes a 90° rotation (twist) on the plane of polarized light passing through it. Light consequently passes through a sandwich comprising the material and an external polarizer on either side, provided the pola-

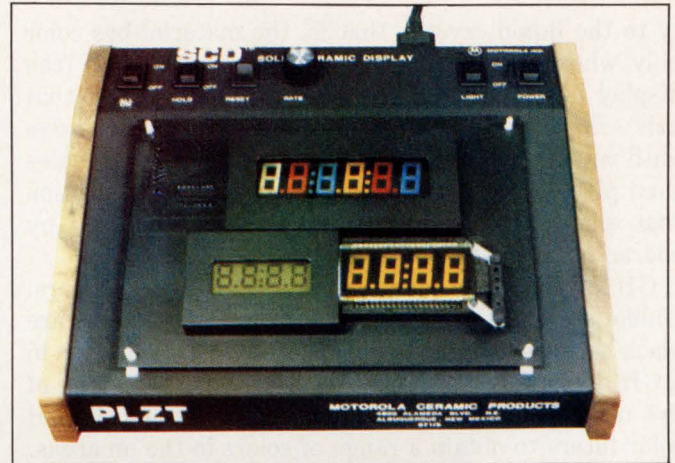

Solid-ceramic displays with evaluation system (Motorola Ceramic Products)

rizers are crossed (oriented at 90°) and properly aligned with the material. The polarizers block the passage of light when you eliminate the liquid-crystal material's twist. You do so by applying an electric field to the material via transparent electrodes. In response to the field, elongated molecules of the material rotate to an end-on position that does not affect the light's polarization. Crossed-polarizer displays produce dark areas; parallel-polarizer displays produce light areas in response to an applied field.

These familiar LCDs, however, offer limited performance in terms of contrast, response time, and optimum viewing angle. (A viewing angle that's perpendicular to these displays is generally not optimum; TN LCDs provide only a 2:1 contrast ratio when viewed head on.) Supertwist LCDs are a new development that promises improvements in all these areas. Stanley, Hitachi, and Sharp, for example, report that their prototype supertwist LCDs achieve 40° to 60° viewing angles and an 8:1 contrast when viewed head on.

Furthermore, the faster response of supertwist devices will allow you to multiplex more characters than you can manage with a standard TN display. The key to improved performance is a more sharply defined threshold for the activation voltage, which results from a greater amount of rotation within the material; supertwist liquid crystals rotate the plane of polarization by 160° to 270° instead of 90°.

Another LCD innovation is the double-layer construction employed in guest-host (GH) types. Available in a single-layer configuration for several years, the GH LCD combines a "host" liquid-crystal material with a "guest" organic dye. The dye imparts a dichroic proper-

You'll need an active, light-emitting display technology for use in low ambient light.

ty to the liquid crystal; that is, the material has color only when viewed along the correct crystal axis (the display is constructed so that you view it along that axis). Specifically, you see a color intrinsic to the dye until you apply an activation voltage; the dye molecules then pivot, along with the host material, to a position that eliminates the color in those areas occupied by characters.

GH LCDs offers versatility in the display of colors. Unlike a TN LCD, in which the display's off areas are black because no light can pass through, the off areas in a GH display have a color that depends on the type of dye used. What's more, you can add backlighting and color filters to obtain a range of colors in the on areas. Such a display can show multicolored characters on a colored background. GH displays offer a wide viewing angle, but the response time is too slow for most multiplexed applications. Also, GH LCDs operate from 12 to 15V, compared with 7V for the TN types.

Single-layer GH displays are transmissive devices that require a source of illumination and a single polarizer on the side opposite the viewer. Hamlin is concentrating on making this type of display, and it reports that devices achieve contrast ratios as high as 70:1. Currently, the devices serve custom applications in military and airborne systems.

Stanley offers double-layer GH displays, used for several years in Toyota and Honda automobiles and in other custom applications. This type of display achieves higher brightness for a given light source by replacing the light-attenuating polarizer with a second layer of polarizing GH material. The second layer enhances contrast as well.

Solid ceramic vs LCD

Motorola solid-ceramic displays look like LCDs and have a lot in common with LCDs, but they are based on a transparent ceramic material called PLZT (lead lanthanum zirconate titanate). Like liquid-crystal material, the ceramic material becomes birefringent in the presence of an electric field; that is, it rotates the plane of polarization for incident polarized light. Motorola combines a thin sheet (18 to 20 mil) of PLZT with polarizers, reflectors, and transparent electrodes, as in an LCD, to create a completely solid-state display. Products include transmissive, reflective, and transflective types, all with dual-in-line pinouts. The SCD504 instrument display, for example, has four 0.5-in.-high characters, plus a colon for clock applications. It costs \$17.50 (1000).

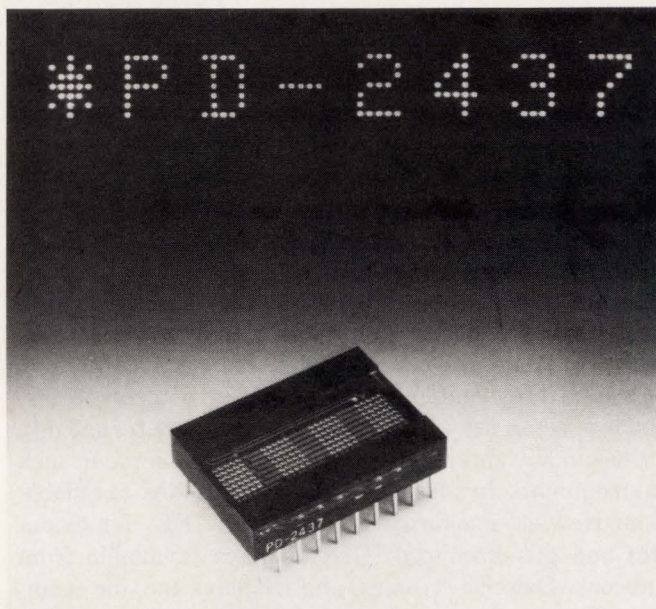

Programmable, 4-character display module (Siemens Components Inc, Optoelectronics Div)

The PLZT material provides rugged displays in hundreds of colors. The displays feature $\pm 80^\circ$ viewing angles, a -40 to $+85^\circ\text{C}$ operating temperature range, and a response time (0.5 msec) that renders the devices suitable for multiplexing. You can drive them with an electroluminescent (EL) driver such as TI's SN75551; the required operating voltage is about 190V. The company's SCD test system lets you evaluate and environmentally test the displays. The test system costs \$250 and includes three ceramic displays of your choice.

LED displays can't compete with LCDs for most portable or battery-powered applications, but they offer simplicity and ruggedness, and you can read them in the dark. Because LEDs turn off and on in a few tens of nanoseconds, you can easily multiplex a long row of characters. Dimming controls are easy to implement, because an LED's intensity is proportional to its forward drive current. General Instrument, Hewlett-Packard, and Siemens each offer an extensive selection of these LED products, including segmented and dot-matrix display modules.

Dot matrix beats segments

The dot-matrix format has advantages over the older segmented-character format in the design of most new LED displays. First, the dot matrix is more versatile; it can represent the complete alphabet, numbers, lower-



LED display module in NEMA-style enclosure (Valentine Research)

case letters with or without below-line extenders, and special-purpose and custom symbols. (For comparison, a 16-segment alphanumeric display represents 64 ASCII characters; a 5×7 dot matrix represents 94.) Second, dot-matrix characters are more attractive because the dot matrix more closely approximates curved lines. Third, dot-matrix LEDs cost less to manufacture. Segment LEDs are more expensive because they are larger, and the manufacturer must provide each segment with a separate lens to enhance its size.

Range of color is not the strong suit of LEDs. You can have the original 655-nm red, or a high-efficiency red (HER; 635 nm) that is obtained by doping gallium phosphide (GaP) with oxygen (O₂). HER is somewhat more orange than the standard red, and it offers more light output per unit of drive current. Orange, yellow, and green LEDs are available, and in the past year HP introduced a purer "emerald" green with an approximate peak wavelength of 555 nm. This color is useful in airborne displays because its shorter wavelength has less effect on the image intensifiers used in night-vision goggles. Finally, Siemens offers a blue lamp, the Model LDB5410, based on a 480-nm LED made of silicon carbide. The LDB5410 costs \$35 (5000).

CMOS chip controls smart module

Modules with the associated circuitry built in have been around for some time. Siemens pioneered the use of easily interfaced, user-friendly, multicharacter display modules with its Intelligent Display product family in 1977. The family comprises single-, 4-, and 8-character modules with character heights of 0.112 to 0.70 in. Each includes a custom-CMOS control chip. The chip contains multiplexer and driver circuits, an ASCII-addressable ROM for storage of character codes, a refresh RAM to store the ASCII addresses that are

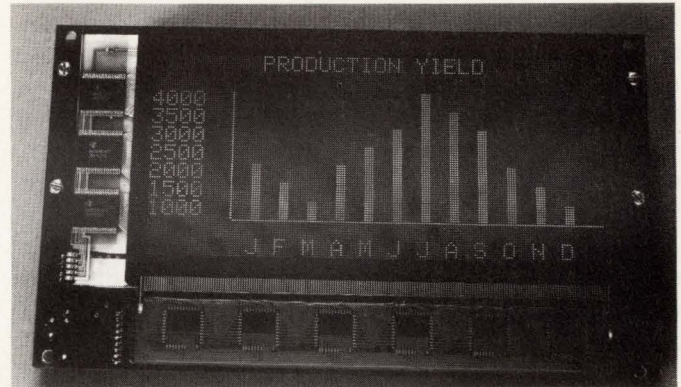

Gas-discharge display panel (Dale Electronics Inc)

currently producing characters, and logic to support various pin-driven functions such as chip enable, write, cursor access, and blanking and blinking. The modules operate from 5V, and they form a uniform row of characters when stacked end to end. Prices range from \$1.50 to \$8 per character in OEM quantity. HP and Three-Five Semiconductors are alternate sources for various members of this family.

In 1984, Siemens introduced a second generation of modules, in which not only are the characters software programmable, but all available display functions are implemented by a control word written to the on-chip RAM. Again, a custom CMOS chip contains the necessary RAM, ROM, multiplexer, and drivers, and a microcontroller as well. Onboard intelligence lets you interface these products as you would any μ P peripheral. Typical of these products is the 4-character, 5×7-dot PD-3435 (Ref 2), now available for \$45.65.

Valentine Research has extended the programmable LED-display idea by offering 7- and 16-segment alphanumeric, bar-graph, and block-of-light annunciator displays in NEMA-style enclosures. These modules contain a circuit board with an 8048 microcontroller and other chips, which allow you to control all functions via simple string operators, common to most high-level languages. A host computer controls the display through an asynchronous serial interface (RS-232C, -422, or -423). A typical device, the \$239 SPM-201, has six 7-segment numerals and decimal points, plus three individually controlled annunciator bars.

Displays for use in sunlight

GD and VF displays are unsurpassed in providing large, bright characters for a reasonable price. Often, the main issue in deciding between them is a subjective sense of which is more pleasing to the eye. Some say the

The faster response of supertwist devices allows you to multiplex more characters than you can manage with a standard TN display.

longer-wavelength GD emission is easier to look at, but there is little consensus on this subject. VF displays are brighter, and you can obtain other colors by filtering their broader emission spectrum. Consider also that GD displays are larger, dissipate more power, and are more expensive, because their higher operating voltage (180V typ, vs 50 to 90V for VF displays) requires more costly driver chips. On the other hand, the faster response and memory characteristics of GD displays gives them the edge in constructing large, multiplexed panels.

Dale Electronics' Model APD-192G088 GD display straddles the categories of modules and flat-panel CRT replacements. The GD panel offers a single dot matrix of 88×192 dots in a 3.5×7.66-in. viewing area. Overall dimensions are 6×10.35 in., with a thickness of less than 0.5 in., excluding connectors. Because the external drive-electronics system is compatible with CRT controllers, the panel can display graphics and text in the manner of a CRT. Using a raster scan similar to that of a television receiver, the onboard row and column drivers apply a serial stream of pixel data to the panel. The panel produces an 80-fL neon-orange color visible within a solid angle of 120°.

Elegant construction sets the APD-192G088 apart; the row- and column-driver chips are surface-mounted

directly to one of two panes of glass forming the display envelope. The result, says Dale representatives, is increased reliability and reduced cost (\$435 in 100 qty) compared with alternative methods of construction. The price includes a separate electronics board for interfacing to a CRT controller.

Little modules form big display

You can create a large GD panel by making an array of smaller modules, provided that the resulting character lines and columns are uniformly spaced (not all modules are amenable to such treatment). The Quantum display module from Displays Inc offers this large-scale capability. Each module contains two 20-character rows of 1-in.-high characters in 5×7-dot formats, easily readable at 60 ft.

You can, for example, arrange 48 of these modules to create a 1920-character display, which you feed with asynchronous 8-bit ASCII data through an RS-232C port. The resulting 40×64-in. panel is suitable for viewing by a large audience, as in the presentation of stock transactions (Fig 1). Each pair of rows includes one master module (\$995) and three slave modules; the 48-module system sells for \$35,000.

The nearest relatives of GD displays, the VF units, are all manufactured offshore. Only Futaba, NEC,

For more information . . .

For more information on the display modules mentioned in this article, contact the following manufacturers directly or circle the appropriate numbers on the Information Retrieval Service card.

Babcock Display Products Inc

1051 South East St
Anaheim, CA 92805
(714) 491-5100
Circle No 704

Dale Electronics Inc

Columbus Div
Box 609
Columbus, OH 68601
(402) 564-3131
Circle No 705

Densitron Corp

2540 West 237th St
Torrance, CA 90505
(213) 530-3530
Circle No 706

Displays Inc

RD 4, Box 6AAA
Lewistown, PA 17044
(717) 242-2541
Circle No 707

Futaba Corp of America

Electronic Components Div
711 E State Parkway
Schaumburg, IL 60195
(312) 884-1444
Circle No 708

General Instrument Corp

Optoelectronics Div
3400 Hillview Ave
Palo Alto, CA 94304
(415) 493-0400
Circle No 709

Hamlin Inc

Lake & Grove Sts
Lake Mills, WI 53551
(414) 648-2361
Circle No 710

Hewlett-Packard Co

Components Group
370 W Trimble Rd
San Jose, CA 95731
(408) 435-7400
Circle No 711

IEE Planar Products Div

7740 Lemona Ave
Van Nuys, CA 91409
(818) 787-0311
Circle No 712

Motorola Inc

4800 Alameda Blvd NE
Albuquerque, NM 87113
(505) 822-8801
Circle No 713

Siemens Components Inc

Optoelectronics Div
19000 Homestead Rd
Cupertino, CA 95014
(408) 725-3524
Circle No 714

Stanley Electric Co Ltd

17911 Sampson Lane
Huntington Beach, CA 92647
(714) 841-6090
Circle No 715

Three-Five Semiconductors Inc

4545 South Wendler Dr
Tempe, AZ 85282
(602) 431-0431
Circle No 716

Valentine Research

10280 Alliance Rd
Cincinnati, OH 45242
(513) 984-8900
Circle No 717

LED displays can't compete with LCDs for most portable or battery-powered applications, but they're simple and rugged, and you can read them in the dark.

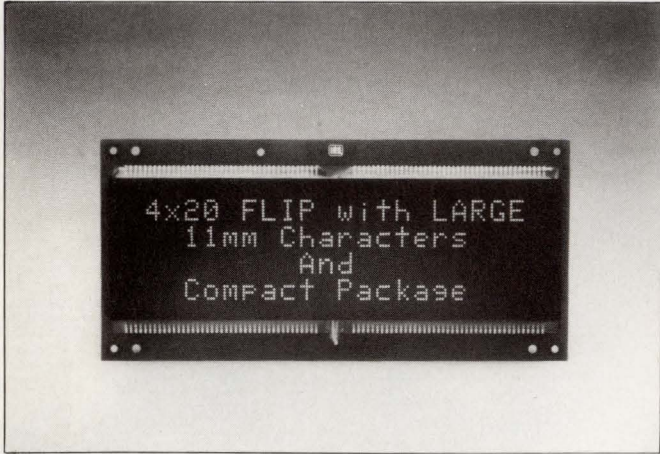

Vacuum-fluorescent display module (IEE Planar Products Division)

Noritake, and the smaller Chuo supply VF components to the US. Futaba also offers μ C-controlled VF-display subsystems, such as the M402SD04CA. This product consists of a VF envelope containing two rows of twenty 0.2-in.-high 5 \times 7-dot characters and is mounted on a pc board along with surface-mounted electronic components. The system operates from 5V and presents a standard peripheral interface to most host computers. The price is \$139.

Intelligent modules include μ C

Densitron Corp also builds intelligent modules, based on VF displays and on LCDs. Model VFS1C16DS73 is a VF module similar to the Futaba unit, but with 12-mm-high characters. It costs \$143.88. IEE, too, offers a variety of intelligent, 14-segment and 5 \times 7-dot VF modules (in addition to modules based on LCDs and GD displays). The Model 3601-24-080 VF module, for example, gives you four 20-character lines of 5 \times 7-dot characters that are 0.44-in. high. An onboard μ P controls all functions; the host interface is an 8-bit parallel bus or a 1200-baud RS-232C connection. Operating from a 5V supply, the blue-green display has a typical 160-fL brightness that you can dim to about 80 fL. The price is \$274 (100).

Babcock and IEE offer some similar VF modules. Babcock's VF-0640-01, for example, provides 0.2-in.-high dot-matrix characters in six lines of 40 characters each for \$990. (IEE's version of this display is the \$987 Model 3601-06-240.)

Like VF and GD displays, EL displays are readable in direct sunlight. EL technology yields lightweight, rugged displays that are the thinnest of all modules

made with active-emission technologies; an ac thin-film EL device has less depth than the glass substrate on which it is deposited. These qualities have led the US Army to commit increasing efforts to EL development (Ref 1).

Light-emitting capacitors

An EL display behaves like a light-emitting capacitor, with a typical value of 3 pF per pixel. In one type, a thin-film layer of phosphor is sandwiched between two insulating dielectric layers, and this construction in turn resides between an aluminum electrode and a transparent tin-oxide electrode. This type of display requires an ac drive of at least 150V p-p. No dc current is present, but transient currents in the 15 Ω /square transparent electrode cause significant power dissipation. A 3 \times 5-in. EL panel and the necessary electronics consume 20 to 30W.

EL technology has a mixed reputation, because the powdered-phosphor EL lamps used for backlighting LCDs have a relatively short lifetime; the relative brightness of these lamps decreases by half after 500 to 7500 hours of operation, depending on the conditions. Thin-film EL products have a reasonable lifetime, though. IEE's 3 \times 5-in. EL display, the Model M0305XXXXX, is rated for 30,000 hours.

This product requires 5 and 15V supplies and provides a yellow-orange display whose brightness ranges from 20 to 110 fL before filtering. The panel's 192 \times 320-pixel array can display high-contrast text and graphics. You can specify a serial or parallel data interface, or the company's standard interface, in which you supply a serial data stream, a video clock signal, and the vertical- and horizontal-sync signals. A ruggedized version with the standard interface costs \$3200; a standard MIL-qualified version with the standard interface costs \$6300.

EDN

References

1. Mosley, J D, "Advances in flat-panel-display technology improve display features and cut prices," *EDN*, September 4, 1986, pg 79.
2. Ormond, Tom, "Dot-matrix display modules," *EDN*, January 24, 1985, pg 138.

Article Interest Quotient (Circle One)
High 479 Medium 480 Low 481

TANTALUM CHIPS FOR HIGH SPEED INSERTION



The TAJ range of tantalum chip capacitors has been designed to provide high "on board" yields on even the very highest speed insertion machines.

The secret is in the ultra-flat molding with a complete absence of any ejection pin marks, resulting in smooth top and bottom surfaces ideally suited for pick and placement.

The precision terminations perform well with all solder systems and offer a guaranteed "fit to footprint" in a complete range of industry standard sizes, conforming to the recent EIA specification for standard size

tantalum chips on 8mm and 12mm tape.

Also available is the TAQ range of tantalum chips which provides a molded alternative to existing conformally coated chips and is fully IECQ qualified. As you'd expect from Europe's largest tantalum manufacturer, quality and reliability are engineered in.

Call Stantel for the data pack.

**STANTEL Components Inc.,
636, REMINGTON ROAD,
SCHAUMBURG, ILLINOIS 60173.
TELEPHONE: 312 490 7150.
TWX: 910 291 1280.
FAX: 312 490 9707.**

ADVANCED TECHNOLOGY IN TANTALUM

STANTEL
DEDICATED TO EXCELLENCE

“Did you say .025”sq. posts?”

Yes, Samtec offers 95%
of all the .025” sq. post
interconnects you’ll
ever need.



When it comes to
SUDDEN SERVICE
Samtec really is
a different breed
of cat!



WRITE TODAY

for our new 72-page full line
catalog. It has been revised
and enlarged to include
many new products. And it
contains complete speci-
fication data for fast, easy
ordering. Get yours today.

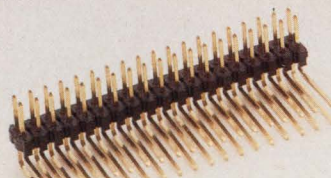

Right Angle Terminal Strips



Surface Mount Socket Strips



Right Angle
Socket Strips

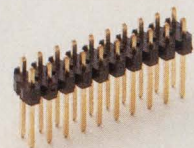

Dual Terminal Strips



IDC Cable
Socket Strips

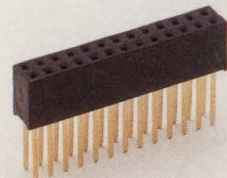

Socket Strips



Bottom
Mount Socket Strips

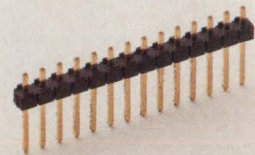

Terminal Strips

For use on board, board-to-board or cable-to-board, Samtec .025” sq. post interconnects provide reliable, gas-tight connections. A unique snap strip feature allows you to snap most strips to desired lengths. CONNECT TODAY with Samtec SUDDEN SERVICE for all of your .025” sq. post interconnect needs.

© Samtec, Inc. 1986
samtec

SUDDEN SERVICE

P.O. Box 1147 · 810 Progress Blvd., New Albany, IN 47150 U.S.A.
Phone: (812) 944-6733 · TWX 810-540-4095 · TELEX 333-918

Components

12-bit current- and voltage-output DACs guarantee monotonicity over temperature

Two 12-bit D/A converters, the HS9393 current-output model and the HS9394 voltage-output model, spec settling times of 50 nsec typ and 1 μ sec max, respectively. The HS9393 offers full-scale ranges of 0 to 4 mA and ± 2 mA, and the HS9394 has full-scale ranges of 0 to -5 ; 0 to -10 V; ± 2.5 ; ± 5 , or ± 10 V.

Of particular note is the HS9393's 4-mA output current. Most high-speed, current-output D/A converters have higher output currents, such as ± 10 or ± 20 mA. The op amp you use to make the current-to-voltage conversion must provide current equal to the DAC's output current plus the load current. The 4-mA value makes it easy to find a capable amplifier.

The HS9393 and HS9394 hybrids

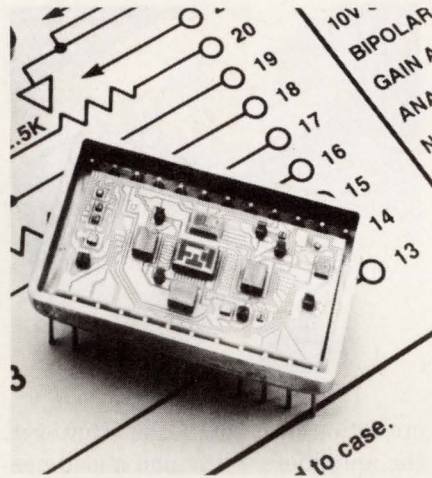

combine a dielectrically isolated current switch, a NiCr resistor network, a buffered reference circuit, and (in the HS9394) a high-speed op amp. Integral and differential non-linearities are $\pm \frac{1}{2}$ LSB max, and

the DACs are monotonic over the commercial or MIL temperature ranges. The devices spec typical glitch areas of 3 mA·nsec and 2.5V·nsec, $\pm 1\%$ max initial gain error, and initial offset errors between ± 1 and ± 4 LSB, depending on the selected output range.

You can adjust the gain and offset errors to zero by using external potentiometers. Housed in a 24-pin, metal double DIP, the HS9393 and HS9394 dissipate 800 and 1000 mW max, respectively. MIL-STD-883C (levels B or S) parts are also available. Prices range from \$120 to \$175 (100).

Hybrid Systems Corp, 22 Linnell Circle, Billerica, MA 01821. Phone (617) 667-8700. TWX 710-347-1575.

Circle No 630

Application-specific antialiasing filters provide prefiltering for A/D converters

Designed for use as input filters for 8-, 10-, 12-, and 14-bit A/D converters, the 650 and 670 Series antialiasing filters offer close unit-to-unit gain and phase matching. Requiring no external components, the 650 and 670 are Caue elliptic lowpass filters of the fifth and seventh orders, respectively.

The filters exhibit well-defined frequency characteristics. First, they pass signals from dc to the stopband frequency, defined as the highest frequency at which small, specified amounts of passband ripple occur. Next, they sharply attenuate signals whose frequencies lie between the stopband frequency f_R and a fractionally higher frequency f_S , the lowest frequency at which a

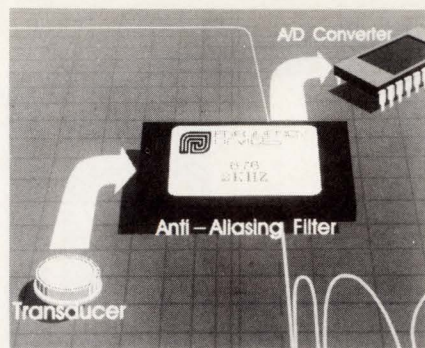

specified, minimum sustained attenuation level (the attenuation floor) first occurs.

Finally, the filters maintain the attenuation floor at a level sufficient to reduce the filters' output to less than $\frac{1}{2}$ LSB of an n-bit ADC. All 650 and 670 Series models attenuate stopband frequencies to an n-bit

ADC by a minimum of the product of 6 dB and n+1 at the attenuation floor.

Models 651 and 652 are 5-pole filters that are suitable for processing signals to an 8-bit ADC; their attenuation floor is 54 dB. Also 5-pole filters, Models 653 and 654 drive 10-bit ADCs and spec a 66-dB attenuation floor. Seven-pole Models 671 through 678 are designed for use with 8- through 14-bit ADCs and have attenuation-floor specs from 54 to 90 dB. \$25 to \$45 (100).

Frequency Devices Inc, 25 Locust St, Haverhill, MA 01830. Phone (617) 374-0761. TWX 710-347-0314.

Circle No 631

Components

UHF power-amplifier modules deliver 2.5W, serve in portable cellular-radio handsets

Targeted for use in cellular-radio handsets, the BGY95 and BGY96 are UHF amplifier modules capable of generating output power as high as 2.5W. The BGY95 operates from a 7.5V supply; the BGY96 operates from a 9.6V supply. Each device is available for operation in the 825- to 845-MHz ("A" suffix) or 860- to 915-MHz ("B" suffix) frequency bands.

The modules produce their full output power from a maximum RF drive input of 20 mW, but you can control the output power in the range 6 mW to 2.5W via a gain-control input that's driven by a dc voltage in the range 0.5 to 6V. The device's minimum efficiency at full output power is 35%.

The amplifiers have an input impedance of 50Ω and are rated for

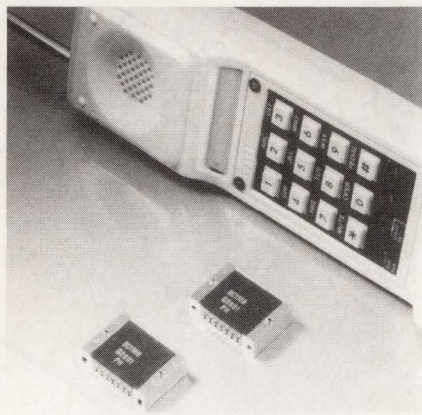

operation into 50Ω loads. However, the amplifiers withstand a load mismatch as great as 50:1, provided you don't exceed their absolute maximum ratings, and they produce no spurious signals with a load mismatch VSWR of as much as 3:1 under normal operating conditions.

Their harmonic rejection at full output power into a 50Ω load is 30 dB min.

The modules, both of which measure 30.5×20.75×7.5 mm, have an integral heat sink that you can operate to a maximum temperature of 90°C. Input, output, control-voltage, and power-supply connections are made through a row of seven in-line connection pins. Approximately \$60 to \$70 (100).

Philips Elcoma Div, Box 523, 5600 AM Eindhoven, The Netherlands. Phone (040) 757005. TLX 51573.

Circle No 633

Signetics Corp, 811 E Arques Ave, Sunnyvale, CA 94086. Phone (408) 991-2000.

Circle No 634

Solid-state electroluminescent display has 640×200-pixel screen resolution

Conceived for MS-DOS applications, Model MD640.200 thin-film electroluminescent display accommodates 25-line, 80-character text and 640×200-pixel graphics. The display has a 1:2 pixel-pitch aspect ratio; picture size is comparable to that of an 11-in. CRT.

Model MD640.200 comprises a solid-state, thin-film EL panel that's shock mounted with an elastic spacer to an electronic board containing the high-voltage driver and controller circuits needed to drive the EL panel. Flexible conductors connect the EL panel to the driver board. The controller contains timing logic and drive-voltage waveform generators.

The screen has 640 transparent



column electrodes that cross 200 row electrodes in an X-Y fashion. Light emission occurs when an ac voltage arrives at a row-column intersection. The driver-controller board processes the panel's input logic and generates the voltage pulses required for illumination.

Logic-input signals (5V TTL levels) required by the MD640.200 are video data, video clock, horizontal synchronization, and vertical synchronization. Video data that's valid during the last 640 video-clock pulses before the falling edge of the horizontal-sync signal will appear on a selected line.

Dimensions for the MD640.200 are 6.2×9×0.5 in. Its external power unit measures 1.9×9.3×0.9 in. The display draws 15W typ and operates over 0 to 55°C. The price for a sample panel, including power unit, is \$1250.

Finlux Inc, 20395 Pacifica Dr, Suite 109, Cupertino, CA 95014. Phone (408) 725-1972.

Circle No 632

TODAY'S BUSINESS ELECTRONICS HAVE CHOMERICS WRITTEN ALL OVER THEM.



Keyboard laminates provide excellent EMI shielding and ESD grounding.

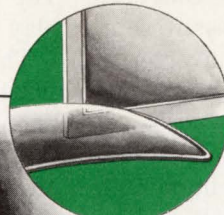
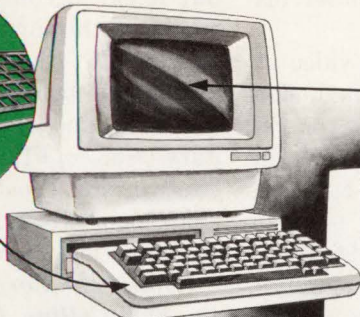

Chomerics CRT windows combine EMI shielding and glare reduction.



CHO-SEAL[®] conductive elastomers ground mating surfaces in critical applications. CHO-JAC[®] flat cable shielding brings cables into FCC compliance.

Chomerics shielding laminates provide low impedance ground planes, reducing EMI on discrete components and PC boards.

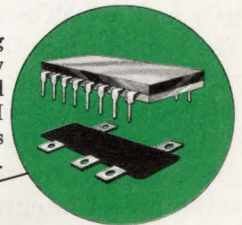

Slim-Line[®] cable raceway impedes entry and exit of EMI.

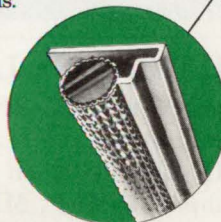
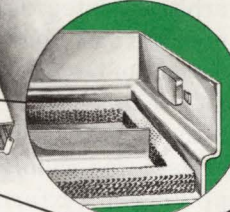

MESHKLIP[™] EMI gasketing with integral mounting clip eliminates riveting, punching, and additional mounting hardware.

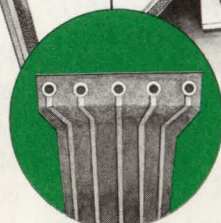

CHO-FLEX[™] conductive coatings provide EMI shielding for flexible circuit laminations.

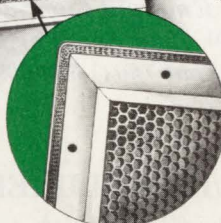

Shielded vents and filters attenuate EMI while maximizing air flow.

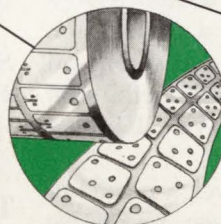

CHO-THERM[®] insulators reduce labor and eliminate messy thermal grease in power supplies.

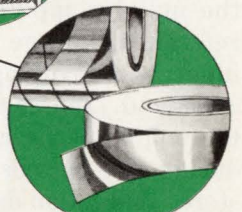

CHO-MASK[™] EMI foil tape with peel-off mask replaces chromate conversion coating, plating, and conductive paints.

The proliferation of high density digital devices has created a greater concern for EMI shielding and heat transfer.

At Chomerics, we've been helping design engineers guarantee the performance and integrity of their digital equipment designs to meet FCC, TEMPEST, and other EMI standards through advances in materials technology for over 25 years.

Our full line of materials and product forms have helped to

eliminate EMI and ESD problems in mainframes, minis, micros, personal computers, peripherals, data storage devices and CAD/CAM workstations.

Get down to business: For your next digital electronics design, make sure your EMI shielding, sealing, bonding, grounding, and heat transfer components have Chomerics written all over them.

Circle the number or call (617) 935-4850 for additional information.

CHOMERICS
a GRACE company

THE LEADER IN SHIELDING INNOVATION, DESIGN, AND TESTING TECHNOLOGY.

77 Dragon Court
Woburn, MA 01888
TEL: (617) 935-4850
TWX: 710-393-0173

Chomerics Europe, Inc.
First Avenue
Marlow, Bucks
SL7 1YA England
TEL: (06284) 6030

Components

INTEGRATING ADC

Model AD1170 integrating A/D converter has programmable integration time from 1 to 350 msec and usable resolution from 7 to 18 bits. It's a pc-board-based ADC that uses surface-mount ICs and passive components that allow the converter to fit into a 1.24×2.5×0.55-in., triple-width DIP.

The converter contains a charge-balancing converter, a single-chip μ C, and a CMOS controller chip. You can interface the AD1170—in a memory-mapped or I/O-mapped mode—to any μ C-based system.

You program the AD1170's integration time by selecting one of seven preset integration periods or by loading an arbitrary integration time over the interface bus. You can select the data format of the output: offset binary or 2s complement.

The AD1170 has digital calibration and autozeroing. You calibrate the unit by applying an external reference voltage to the ADC's input and invoking a calibration command. You can also command the unit to perform self calibration during idle periods. An EEPROM stores calibration data.

For integrations over a period of 1, 16.667, and 100 msec, respective conversion rates are 250, 50, and 9 conversions/sec. Differential nonlinearity (DNL) is an inverse function of conversion time. For conversion times from 1 to 300 msec, DNL varies from $\pm 0.001\%$ to $\pm 0.0003\%$ FSR. \$98 (100).

Analog Devices Inc, Box 280, Norwood, MA 02062. Phone (617) 329-4700.

Circle No 598

FLAT-PANEL TERMINAL

The FT-50 features an 8.5×11×2.5-in. 512×256-dot display and a 1.5×14×5-in. keyboard. Its total shipping weight is 3.5 lbs, and its display requires only 25.5 in² of desk space. You can order either an electroluminescent (EL) or a gas-plasma version. Both provide 80-charac-

ter×25-line, 4×8-in. display areas. A 5×7-dot matrix defines characters in a 6×10-dot cell. A double-height/double-width display option generates 40×12-dot characters. The life expectancy for either display is 30,000 hours.

The flat-panel display's video attributes include blink, blank, underline, reverse, and protect; you can combine these attributes for special effects. You can define the cursor as a blinking or nonblinking block or underline. The FT-50 uses 96 ASCII characters, 16 control-code symbols, and 16 graphics characters.

The keyboard attaches to the display via a coiled cable. Its 10 function keys are segregated from the 63-key alphanumeric layout. Cursor and edit keys are included, as are two asynchronous RS-232C ports.

The FT-50 meets ANSI standard 3.64, and it's compatible with IBM, DEC, Televideo, and Wyse terminal protocols. \$1295 (100). Delivery, six to eight weeks ARO.

Emerald Computers Inc, 16515 SW 72nd Ave, Portland, OR 97224. Phone (503) 620-6094.

Circle No 599

T/H AMPLIFIER

The CLC940 high-speed, hybrid-circuit track/hold amplifier can drive the fastest available flash A/D converters. Its hold-to-track acquisition time is 10 nsec to a 1% error band, 16 nsec to a 0.1% band. Track-to-hold settling time to within 1 mV of final value is 12 nsec. The aperture jitter is 1 psec. The hybrid's small-signal bandwidth and slew rate are 150 MHz and 470V/ μ sec, respectively.

Other specs include 0.02% gain nonlinearity, 20-ppm/ $^{\circ}$ C gain drift, 74-dB feedthrough rejection, and -65-dBc harmonic distortion. Pedestal offset is 2 mV, and the sensitivity of the pedestal to the input voltage, a specification important for linearity, is just 0.03 mV/V. The device's onboard hold capacitor provides a droop rate of 20 μ V/ μ sec.

Capable of accepting either ECL or TTL T/H control signals, the CLC940 operates from ± 15 V supplies and dissipates 1.6W. Its nominal input-voltage limits are ± 2.2 V, but it can accommodate a ± 2.5 V swing at the input. Packaged in a 24-pin DIP, the T/H amplifier is available in both a commercial (-25 to +85 $^{\circ}$ C) and a high-reliability military (-55 to +125 $^{\circ}$ C) version. The two versions cost \$196 and \$397 (100), respectively. A high-frequency evaluation board costs \$10.

Comlinear Corp, 4800 Wheaton Dr, Fort Collins, CO 80525. Phone (303) 226-0500.

Circle No 600

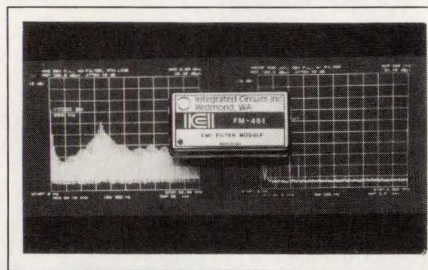

FILTER MODULE

The FM-461 EMI/RFI filter module complies with MIL-STD-461 and MIL-STD-704 when used with this company's MLP, MHE, and MTO series of dc/dc converters. The module features both differential and common-mode filtering. The data sheet includes I/O transfer functions for use with other types of converters that have input currents to 1.75A dc. The FM-461 comes in a metal solder-sealed package that measures 1×2×0.375 in.; environmental screening per MIL-STD-883 is optional. \$87 (100).

Integrated Circuits Inc, 10301 Willows Rd, Redmond, WA 98052. Phone (206) 882-3100. TWX 910-443-2302.

Circle No 602

DPMs

You can order the Model 516 digital panel meters with a 3½-digit LED in 11 different ranges: 50 mV, 200

TOKIN. A COMPANY WHO'S TIME HAS COME... AGAIN, AND AGAIN, AND AGAIN.

Some people assume Tokin's bold new presence means we're a recent newcomer to the scene. The truth is, we've produced a steady stream of breakthroughs in the electronics and communications industries over the past half century. In ferrite cores, piezoelectric ceramics, EMC components and services, magnetic card readers—and much more.*

In fact, we're one of the companies the industry was built on. With a presence that's bigger and bolder than ever. Do yourself a favor: Pick up the phone and check us out.

*The products shown here are but a sample of Tokin's lineup of electronic materials and devices. For a more complete picture, call us right now.



Tokin
Tokin Corporation

Head Office: Hazama Bldg., 5-8, Ni-chome,
Kita-Aoyama, Minato-ku, Tokyo 107, Japan
Tel.: Tokyo (03) 402-6166 Telex: 02422695 TOKIN J

Tokin America Inc.
2261 Fortune Drive, San Jose, California 95131
U.S.A. Tel.: 408-946-4887

You can reach our agents by phone:
London 01-837 2701; Paris 1-45 34 75 35;
Milan (0331) 678.058; Munich (089) 5164-0;
Seoul (02) 777-5767; Taipei (02) 7311425;
Hong Kong 3-315769; Singapore 747-8668

CIRCLE NO 59

Components



mV, 2V, 20V, 200V, 500V, 200 μ A, 2 mA, 20 mA, 200 mA, and 2V ratiometric. They feature programmable decimal points and single-ended and differential inputs. Accuracy and linearity are $\pm 0.05\%$ full scale. Maximum power input is 5V dc; input impedance is 1000 Ω . The meter has 100% overrange protection and operates at 4 samples/sec.

Three mounting styles are available: The Flat Pack measures $2 \times 3 \times 0.5$ in. and is mounted on the front of the panel through a $\frac{3}{8}$ -in. hole. This unit is supplied with a

plastic housing. The Naked Panel Mount is $1.9 \times 3.5 \times 0.5$ in. and is mounted behind the panel by using stand-offs; this unit has a ribbon connector. The Naked PC Mount measures $1.9 \times 2.9 \times 0.5$ in. and is mounted behind the panel on a pc board or a connector; it can also be terminated with wire wrap. \$52. Delivery, stock to six weeks ARO.

International Microtronics Corp, 4016 E Tennessee St, Tucson, AZ 85714. Phone (602) 748-7900. TWX 910-952-1170.

Circle No 603

DUAL LEDs

You can use the 21PCT200 line of high-intensity pc-board LEDs in piggyback configurations. The dual-LED package uses T1 $\frac{3}{4}$ high-efficiency LEDs. Each package is $\frac{1}{4}$ in. wide. Its mounting is designed to maintain alignment with the line center of the first (lower) LED at

0.125 in. from the pc board and the second (higher) LED mounted at 0.375 in. from the board. The four termination leads are spaced on 0.1-in. centers.

To facilitate flux and residue cleaning of the connections after assembly soldering, the black-nylon housing base of the LEDs has a relief area around the leads. You can order the packages with bright red (635 nm), yellow (585 nm), and green (565 nm) LEDs; the packages can combine two colors. Brightness levels reach 3 cd. \$0.75 (1000).

Ledtronics Inc, 4009 Pacific Coast Hwy, Torrance, CA 90505. Phone (213) 676-7996. TLX 4945454.

Circle No 601

DELAY LINES

The EP9748 Series active delay lines offer delays from 25 to 250 nsec $\pm 5\%$ or 2 nsec. Each delay line in

Where to find almost any test environment on Earth. Plus a few that aren't.

Lockheed's Environmental Test Laboratory provides complete environmental, electromagnetic interference/compatibility and stress screening services on a 24-hour-per-day basis. All at one location.

We have 26 years' experience testing all types of equipment under carefully controlled laboratory conditions. Whether your specifica-

tions are military or commercial, we're fully equipped to handle your climatic/atmospheric simulation, structural, enclosure or noise testing, and much more.

Call Jack Glavine at (201) 757-1600 Extension 2267 or 2227 with your equipment test specifications. However impossible they may seem.

 **Lockheed Electronics**

Innovation
Giving shape to Imagination.

The First Name in Fans announces the Last Word in Forced Convection Cooling:

Therma Pro-V™

FORCED CONVECTION
COOLING TECHNOLOGY

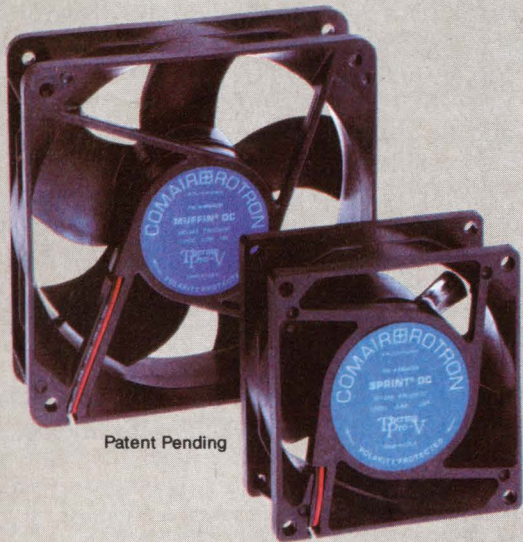

Patent Pending

Finally, you can design component cooling *into* a system, rather than adding it on. Comair Rotron's unique ThermaPro-V circuitry makes possible Voltage Regulated, Programmable and Thermally Speed Controlled brushless DC fans. A single ThermaPro-V fan can be specified to cover a broad range of air-flow needs. Efficient system design can be maintained across changing environmental conditions. Voltage fluctuations no longer need affect fan performance. ThermaPro-V . . . it's the engineered answer to today's electronic component cooling needs. Call (800) 367-2662 (in NY State, (914) 246-3615) for complete literature. Or write Comair Rotron, Sawyer Industrial Park, Saugerties, NY 12477.

COMAIR  ROTRON

CIRCLE NO 61

a KLI company

From the industry's first choice come the industry's first choices.



We designed the original TO-5 relay over 20 years ago. But that was just the beginning. Since those first days, we nudged it into fathering a family of adaptations and extensions along the way.

In the process we also pioneered many innovative techniques for production, for manufacturing, and for quality control to ensure a reliability level so consistently high it would be taken for granted.

Of course, for us it never was.

Soon, TO-5 relays were available in latching versions, in single,

double and 4-pole styles, and in hybrid versions with internal diode and transistor drive. All with excellent RF switching characteristics.

Today, there's a version for just about any application—general purpose and sensitive, commercial, and military (qualified to "L," "M" and "P" levels of MIL-R-39016).

Our family boasts the Centigrid®, possibly the most advanced hermetically sealed armature relay available today. The Maglatch, a relay with memory and low power requirements. And lots of brothers and sisters to handle applications like high temperature, high shock,

and high vibration designs for critical, hi-rel applications. We even have versions that can be driven directly from CMOS and TTL (qualified to "L" and "M" levels of MIL-R-28776).

If you'd like complete technical information on our TO-5 relay and all its offspring, or some applications help, or just a little history, drop a note or give us a call.

Like proud parents, we love to talk about the family.

TELEDYNE RELAYS
Innovations In Switching Technology

CIRCLE NO 62

12525 Daphne Ave., Hawthorne, California 90250 • (213) 777-0077
European Hqtrs: Abraham Lincoln Strasse 38-42, 6200 Wiesbaden, W. Germany • 06121-768
Belgium Sales Office: 181 Chaussee de la Hulpe, 1170 Brussels • (2) 673-99-88
U.K. Sales Office: Heathrow House, Bath Rd., Cranford, Hounslow, Middlesex, TW5 9QP • 1-897-2501
Japan Sales Office: Taikoh No. 3 Building, 2-10-7 Shibuya, Shibuya-Ku, Tokyo, 150 Japan • (3) 797-6956
France Sales Office: 85-87 Rue Anatole-France, 92300 Levallois-Perret • 1-7587160

Components

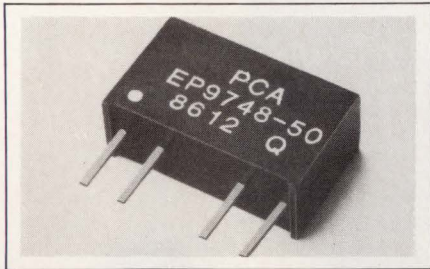

the series provides a single TTL-compatible output. Maximum size of the epoxy case SIPs is 0.47×0.29×0.185 in. They have four leads, arranged on a 100-mil grid, including V_{CC} , ground, input, and output. One 5V supply is needed; typical current is 20 mA. Operating range is 0 to 70°C. The devices have buffered inputs and outputs; standard output buffers drive 10 Schottky loads with a maximum rise time of 4 nsec. Other versions are available with low-power Schottky buffers. \$2 (1000). Delivery, stock to six weeks ARO.

PCA Electronics Inc, 16799 Schoenborn St, Sepulveda, CA 91343. Phone (818) 892-0761.

Circle No 604



SMT KITS

Two configurations of the SMT (surface-mount technology) Training Kit are available. The SMT2000, in addition to hardware, contains over 575 surface-mount components, including chip resistors, chip capacitors, diodes, and transistors. The SMT1000 is intended for those who already have a supply of component parts. Both configurations have prototyping boards, component attachment and interconnection materials, and a 50-pg manual.

Devices furnished with the SMT2000 include 270 surface-mount multilayer ceramic-chip capacitors

EDN December 25, 1986

Who makes LED Illuminators

POWERFUL



enough to replace incandescents?

Data Display Products has the newest answer to plug-compatible replacement of incandescents. Our multi-chip LED illuminators provide more than 4 times the light output of the previously best available single chip LEDs. What's more, they have an average lifetime in excess of 10 years.

Make the brilliant choice. Find out more about these powerful additions to our high-efficiency LED product line. Call Data Display. TOLL-FREE (800) 421-6815. Within California, call (213) 640-0442. Free catalog.



301 Coral Circle, El Segundo, CA 90245
(213) 640-0442 TELEX 664-690

INTERNATIONAL REPS: Argentina YEL SRL, PH: 541 46 2211, TLX: 390 18605 - Australia Ampec, PH: 02 7122466, TLX: 790 27136 AMPEC - Belgium/Holland Klasing Etc, PH: 01620 81600, TLX: 844 54598 KLBONL - Denmark Radio Parts, PH: 01 333311, TLX: 855 19613 RPARTDK - France A Jahnicchen, PH: 387 59 09, TLX: 842290714 - Israel R. C. M. Computers, PH: 03 485192, TLX: 922 342471 IL - Italy Microdata, PH: 0187 988182, TLX: 8432 71353 - South Africa Liberty Elec., PH: 52 7637 8/9, TLX: 960 429435 SA - Spain Betatron, PH: 6932421, TLX: 831 23911 PCOE - United Kingdom Marl Int'l, PH: 0229 52430, TLX: 851 65100 MARLG - West Germany/Austria Kuhn GmbH, PH: 06235 5662, TLX: 841 464766 KUHND

CIRCLE NO 21

IRKED?

THAT YOU CAN'T GET YOUR LOW-COST
KEYPAD CUSTOMIZED OFFSHORE?
THEN DO IT ONSHORE WITH DIGITRAN!

Digitran's KL Keypad gives you a boatload of custom features — like custom legends on keys and silk-screening on the frame — plus the quality of our positive tactile feedback and precious metal contacts. Come back home to Digitran! **Call Today: 818-791-5600.**

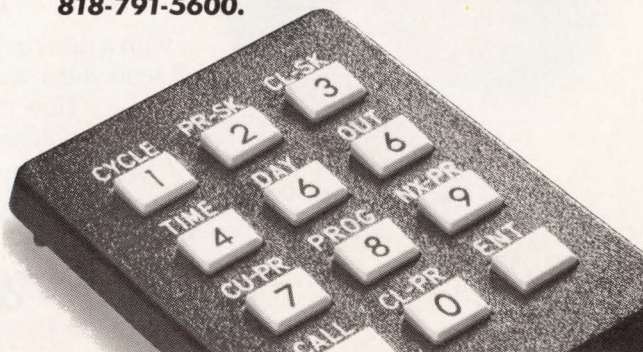

DIGITRAN

A DIVISION OF XCEL CORPORATION
3100 New York Drive, Pasadena, CA 91107

CIRCLE NO 46

If solid performance,
handsome design and
attractive price aren't
enough for you,
there's more.



Just ask us.



With our quality Lighted Pushbutton Switches, you can afford to be choosy. Unimax delivers the style, performance and price benefits you expect, and some benefits you probably don't.

Like the broadest range of options from a single source. Prewirable, slide-on models for rapid, low-cost assembly. Oil-tight versions. Multiple-matrix and mechanically interlocked assemblies. And switches that shift from

alternate to momentary at the flick of a lever.

And there's more. If you send us your specs with a description of your application on your letterhead, we'll send you a sample switch that matches your needs. Free.

How much more will we do to be your source for switches? Just ask us!

Call for the location of your nearest distributor or sales representative.

C&K / UnimaxTM

Ives Road, Wallingford, CT 06492. (203) 269-8701.

Components

of assorted values from 100 pF to 0.033 μ F; 300 resistors ($\frac{1}{8}$ W in assorted values from 22 Ω to 150 k Ω); 10 diodes in SOT-23 packages; and 10 transistors in SOT-23 packages. Both configurations include five different double-sided, epoxy-glass circuit boards with tinned footprint patterns for small-outline and PLCC ICs; the boards also have plated-through holes and ground buses (according to SMT device standards). Layout paper and planning sheets are furnished as well. Both versions have a sixth board configured with different PLCC patterns. SMT2000, \$348; SMT1000, \$215.50.

Vector Electronic Co, 12460 Gladstone Ave, Sylmar, CA 91342. Phone (818) 365-9661.

Circle No 605

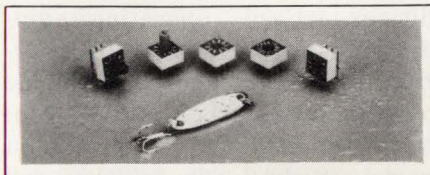

DIP SWITCH

The 3300 Series Micro-DIP switch allows code selection by rotating a shaft to the desired position. The board requires less space because of the switch's size and internal seal, and process-seal removal is not necessary once the pc board has gone through the flow-solder and wash cycles. An O-ring and epoxy-sealed terminals, which protect the switch from contamination during and after solder and cleaning, provide a permanent seal. The switch is available in top- and side-adjustable models with either a flush or extended actuator shaft. The 10- or 16-position switches have single-pole binary-coded-decimal or complementary codes that make the switches suitable for digital logic applications. 330002GS, \$3.05.

EECO Inc, Box 659, Santa Clara, CA 92702. Phone (714) 835-6000. TWX 910-595-1550.

Circle No 606



Who's LED sockets are
FIRST
with wire leads & built-in resistors?

Data Display Products is your best answer for heavy-duty LED sockets.

Our industry leading PS200W series allows a selection of operating voltages. Its flexible wire leads are a standard 6-inch length, 16 to 24 AWG gauges, or special orders available. They're a versatile design or replacement product that should rate first on your list.

Make the brilliant choice. Call Data Display, the world leader in high-efficiency LED panel lamps. TOLL-FREE (800) 421-6815. Within California, call (213) 640-0442.

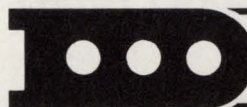

**DATA
DISPLAY
PRODUCTS**

301 Coral Circle, El Segundo, CA 90245
(213) 640-0442 TELEX 664-690

INTERNATIONAL REPS: Argentina YEL SRL, PH: 541 46 2211, TLX: 390 18605 • Australia Ampec, PH: 02 7122466, TLX: 790 27136 AMPEC • Belgium/Holland Klaasing Etc, PH: 01620 81600, TLX: 844 54598 KLBNDL • Denmark Radio Parts, PH: 01 333311, TLX: 855 19613 RPARTDK • France A Jahnnichen, PH: 387 59 09, TLX: 842290714 • Israel R. C. M. Computers, PH: 03 485192, TLX: 922 342471 IL • Italy Microdata, PH: 0187 988182, TLX: 8432 71353 • South Africa Liberty Elec., PH: 52 7637/8/9, TLX: 960 429435 SA • Spain Betatron, PH: 6932421, TLX: 831 23911 PCOE • United Kingdom Marl Int'l, PH: 0229 52430, TLX: 851 65100 MARLG • West Germany/Austria Kuhn GmbH, PH: 06235 5662, TLX: 841 464766 KUHD

CIRCLE NO 60

TICKED OFF?

THAT YOU CAN'T GET LOW-VOLUME, LOW-COST,
CUSTOM KEYBOARDS WITH NO TOOLING COSTS?

YOU CAN WITH DIGITRAN!

Introducing the Digitran KD 220, the only standard keyboard that lets you modify the 2 basic layouts to however many keys and keycap characters you want! PC/AT/XT, and ASCII codes. Off the shelf availability. On-time delivery. *Only \$71 per unit in 1000 quantities!*
Call today: 818-791-5600.



DIGITRAN

A DIVISION OF XCEL CORPORATION
3100 New York Drive, Pasadena, CA 91107

CIRCLE NO 85

Components

TRIMMER CAPACITORS

The small sapphire trimmer capacitors that make up the P Line spec a 0 ± 50 -ppm/ $^{\circ}$ C temperature coefficient. The line's 4.5-pF devices have a Q of over 3000 at 250 MHz and a 0.25-nH inductance at frequencies to 10 GHz. They feature an internal O-ring, are interchangeable with unsealed designs, and have a 500V

dc operating voltage. Operating within the military temperature range, these capacitors can withstand mechanical shock of 100g for 6 msec and vibrations of 60g at 10 to 2000 Hz.

They comply with all MIL-C-14409D specifications. No flux or cleaning fluid can get inside, according to the manufacturer. Three

models—2.5-, 4.5-, and 8-pF versions—are available in 0.125-in. diameters. A 1.2-pF max version has a 0.075-in. diameter. Sample kit, with a combination of 15 parts, \$75.

Voltronics Corp, Box 476, East Hanover, NJ 07936. Phone (201) 887-1517. TWX 710-986-8253.

Circle No 607

ON-BOARD RELIABILITY BEGINS WITH OUR

SURFACE MOUNTABLE COMPONENTS

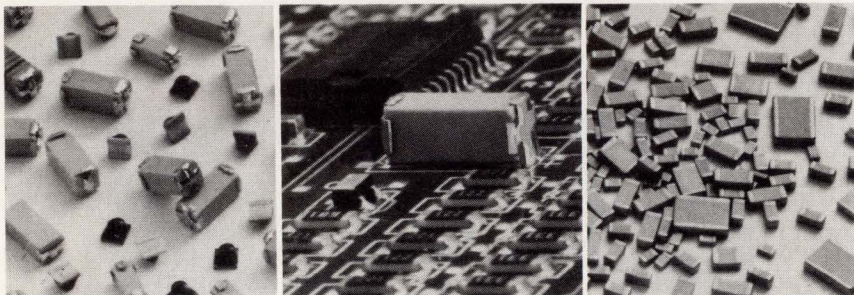

The ultimate performance of any board design is a direct reflection of the reliability of each individual component. Over the years, manufacturers of quality military and commercial electronic products have learned to insist upon Delevan inductive components to insure the ultimate in performance of their products. □ The ceramic capacitor products of our Delcap Division reflect the same concern for reliability which has established Delevan products as the standard of quality for the industry. □ When you specify any of our Electronic Components Group products, you build-in these same high standards of dependability and performance in your finished product.

DELEVAN DIVISION **COILS & CHIP
INDUCTORS**

DELCAP DIVISION **MULTILAYER CERAMIC
CHIP CAPACITORS**

On the East Coast Call (716) 652-3600
On the West Coast Call (714) 768-5522



AMERICAN PRECISION INDUSTRIES
Electronic Components Group

... MADE IN AMERICA BY AMERICAN CRAFTSMEN TO AMERICAN STANDARDS OF EXCELLENCE.

CIRCLE NO 22

SUPPRESSORS

The Series 587B ac-power transient suppressors are designed to protect 220/240V ac equipment; they meet the line-surge standards of IEEE-STD 587, Categories A and B. Intended to be hard-wired into the equipment between the power switch and the power supply, the models use solid-state Transzorb technology, which guarantees that differential mode voltages will not exceed 750V under worst-case conditions. Case operating-temperature range is -40 to $+85^{\circ}$ C; current leakage at the 220/240V ac operating voltage is 1 mA (differential mode) and 0.5 mA (common mode). 587B062, \$65; 587B162, \$73 (100). Delivery, stock to six weeks ARO.

General Semiconductor Industries Inc, Box 3078, Tempe, AZ 85281. Phone (602) 968-3101. TWX 910-950-1942.

Circle No 608



TWINAXIAL SWITCH

Designed for use with the twinaxial interface of IBM Systems 34, 36, 38, 5120, 5150, 5520, and others, the Model 8024-D twinaxial A/B switch eliminates cable swapping because

Components

you can switch any twinaxial port to either of two peripherals, or switch a terminal to either of two ports. The twin center conductors and the shields are switched while isolation of grounds is maintained. Unused connectors are terminated to 51Ω. You can connect all cables at the rear of the unit and select the output with a rotary switch. \$129.

Electro Standards Laboratory Inc, Box 9144, Providence, RI 02940. Phone (401) 943-1164. TLX 6972057.

Circle No 609

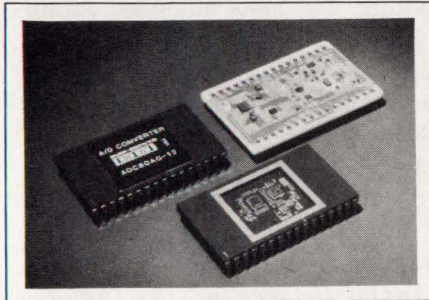

A/D CONVERTER

The ADC80AG dissipates 595 mW max. It uses six IC chips, in comparison with 29 in the company's older model, and it offers an MTBF at 25°C of 3.89×10^8 hours. The ADC comes in a side-brazed, hermetic, 32-pin DIP, with environmental screening as an option. The device features conversion speeds of 25 μsec max for 12-bit resolution and 22 μsec max for 10-bit resolution. These characteristics make the converter suitable for use in applications requiring throughput sampling rates in the 40- to 47-kHz range.

You can trim gain and offset errors to zero. Linearity error is $\pm 0.012\%$ full-scale resolution (FSR) max for 12-bit resolution and ± 0.048 FSR for 10 bits. The company guarantees no missing codes over the temperature range of 0 to 70°C. From \$44.50 (100).

Burr-Brown, Box 11400, Tucson, AZ 85734. Phone (602) 746-1111. TWX 910-952-1111.

Circle No 610

Which LED cluster illuminators are

BRIGHTER

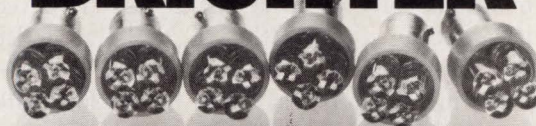

than incandescents?

Data Display Products provides the answer you've been looking for. The first LED illuminators actually brighter than equivalent incandescent lamps.

The MX400 series is totally plug compatible and allows operation at selectable voltages. Available with normal or wide angle configurations. In 4 colors (red, amber, yellow and green).

Make the brilliant choice. Call Data Display. TOLL-FREE (800) 421-6815. Within California, call (213) 640-0442. Free catalog.



301 Coral Circle, El Segundo, CA 90245
(213) 640-0442 Telex 664-690

INTERNATIONAL REPS: Argentina YEL SRL, PH: 541 46 2211, TLX: 390 18605 • Australia Ampec, PH: 02 7122466, TLX: 790 27136 AMPEC • Belgium/Holland Klaasing Eic, PH: 01620 81600, TLX: 644 54598 KLBONI • Denmark Radio Parts, PH: 01 333311, TLX: 855 19613 RPARTDK • France A. Jahnichen, PH: 367 59 09, TLX: 842290714 • Israel R.C.M. Computers, PH: 03 485192, TLX: 922 342471 IL • Italy Microdata, PH: 0187 988182, TLX: 8432 71353 • South Africa Liberty Elec., PH: 52 7637/8/9, TLX: 960 429435 SA • Spain Betatron, PH: 6932421, TLX: 831 23911 PCOE • United Kingdom Marl Int'l, PH: 0229 52430, TLX: 851 65100 MARLG • West Germany/Austria Kuhn GmbH, PH: 06235 5662, TLX: 841 464766 KUHND

CIRCLE NO 99

BURNED UP?

THAT YOU CAN'T GET LOW-COST BIDIRECTIONAL
DOUBLE PUSHBUTTON SWITCHES?
YOU CAN WITH DIGITRAN!

Digitran introduces Eurostyle double pushbutton and mini double pushbutton switches. A snap to assemble and easy to use, they're ideal where speed and convenience of settings count. **Call today: (818) 791-5600. You can do it with Digitran!**

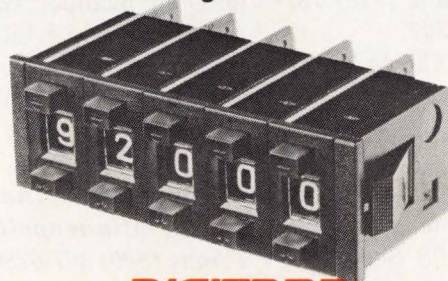

DIGITRAN

A DIVISION OF XCEL CORPORATION
3100 New York Drive, Pasadena, CA 91107 • (818) 791-5600

CIRCLE NO 124

Components

WIREWOUND RESISTORS

The GR102 high-precision wirewound resistors are mechanically interchangeable with leading film units, and they offer long-term stability. They're available in 44 standard resistance values from 10 Ω to 100 k Ω in tolerances of 0.1, 0.02, and 0.01%. Nonstandard resistance values and tolerances are available on special order. Performance characteristics include a stability of ± 35 ppm/year full load and a temperature coefficient of ± 3 ppm/ $^{\circ}$ C typ and ± 5 max. A 0.1%, 10-k Ω model, \$1.83 (500).

General Resistance Inc, Box 185, North Branford, CT 06471. Phone (203) 481-5721.

Circle No 611

VF DISPLAY

The Model 3601-40-040 is a 2-line \times 20-character display that measures 10.8 \times 2.75 \times 1.3 in. The 0.44-in. characters are formed from a 5 \times 7-dot matrix. You can read them easily from a distance of 10 ft. The display requires one 5V dc power supply for operation. An on-board μ P controls all of the display functions and interfaces to an 8-bit parallel TTL data bus. A 1200-baud serial interface is also standard for this unit, with jumper selection of either TTL or RS-232C input levels. The module displays the full 96-character ASCII font, as well as additional European characters and scientific symbols. Display characters are blue-green; a spectrum of color filters is available. \$210 (100). Delivery, four to six weeks ARO.

IEE Inc, 7740 Lemona Ave, Van Nuys, CA 91405. Phone (818) 787-0311. TWX 910-495-1707.

Circle No 612

DISPLAYS

You can use these serial-input, alphanumeric, single-line, 20-character displays, the 2000S Series, either as single stand-alone displays or as part of a network in which the

displays can be distant from one another. A 2-wire bus connects to the display via TTL, current-loop, RS-232C, RS-422, or RS-485 interfaces, allowing transfers at baud rates of 300, 1200, 2400, 4800, or 9600.

By using internal DIP switches, you can individually address as many as 98 displays on the 2-wire bus. Each display has a plug-in communications board that determines the type of serial input the unit accepts and the type of serial output the unit retransmits. A 5 \times 7-dot matrix forms the characters. Character height can be 0.2, 0.35, or 0.59 in.; respective enclosure sizes are 7.2 \times 2.8 \times 4.2, 10 \times 3.1 \times 4.8, and 13.6 \times 3.2 \times 4.8 in. From \$325.

Vorne Industries Inc, 5831 N Northwest Hwy, Chicago, IL 60631. Phone (312) 775-9440.

Circle No 613

FIBER-OPTIC MODEM

The HFM5300 fiber-optic modem improves the integrity of data transmission for the IBM 5251 and compatible cluster controllers. It plugs directly into the controller without modification. The unit measures 5.25 \times 2.63 \times 1.75 in. It can use fiber-optic cable with a core diameter of 50, 62.5, 85, or 100 μ m and handles communication links to distances of 5000 ft. (The IBM 5251 controller's round-trip propagation-delay restrictions limit the distance to that length.)

You can use the modem in any of eight positions designed for the 5251 protocol. The device consists of an 850-nm LED transmitter and a detector module. The error rate is less than one per billion bits of data transmitted or received. The modem has its own power supply, which plugs into standard ac sources. \$1010.

Honeywell Inc, Honeywell Plaza, Minneapolis, MN 55408. Phone (800) 367-6786; in MN, (214) 234-4271.

Circle No 614

SIGNAL MODULES

The 5B Series signal-conditioning modules use surface-mount and small-outline devices to achieve a 3:1 reduction in volume, as compared with the modules' older siblings. When encapsulated, the series' input/output modules measure 2.25 \times 2.25 \times 0.6 in. vs the manufacturer's earlier 3B Series, whose dimensions are 3.15 \times 3.395 \times 0.775 in. The series consists of a family of isolated (± 1500 V peak) input and output signal-conditioning modules and a family of backplanes, including a relay-rack-compatible backplane that can hold as many as 16 modules. The input modules contain complete signal-conditioning circuitry that's optimized for specific sensors or analog signals, and they provide high-level (± 5 V or 0 to 5V) analog outputs. All modules (input and output) meet IEEE-STD 472 for transient-voltage protection and cost \$105 (100).

Analog Devices Inc, Rte 1 Industrial Park, Norwood, MA 02062. Phone (617) 329-4700.

Circle No 615

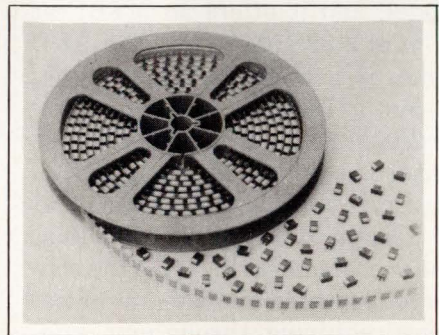

CHIP CAPACITORS

The Series 293D is a set of miniature, molded-case, solid-electrolyte tantalum chip capacitors designed for surface-mount applications. They conform to IEC QC300801/001, the new EIA industry specification for standard capacitance-range devices. These capacitors are available in four package sizes, voltage ratings from 4 to 50V dc, and capacitance values from 0.1 to 100 μ F. Operating-temperature range

Meet Flash-Track™...



**the track
and hold that
meets its specs
in your flash
A/D system.**

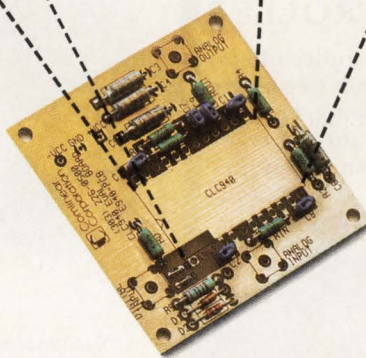

**Prove it
to yourself
with our FREE
evaluation board.**

The CLC940 Flash-Track™ track and hold amplifier lets you combine high speed with high accuracy in your flash A/D system.

This ultra-high-speed track and hold doesn't sacrifice total performance for one or two good switching specs. It faithfully delivers great specs across the board. Guaranteed.

You get hold-to-track acquisition times of 10ns (to 1.0%) and 16ns (to 0.1%). Track-to-hold settling time of 12ns (to 1mV). Bandwidth (-3dB) of 150MHz. And super supporting specs as well, such as feedthrough

rejection of 74dB (at 20MHz) and aperture jitter of 1ps (1.6ps max).

Yet for all this performance, you pay substantially less than you would for other high-speed track and holds. And get outstanding applications assistance as well. Choose from industrial and screened Hi-Rel versions. And for a limited time you'll receive a FREE evaluation board with your order.

Call today for details on the track and hold you can trust. Comlinear Corporation, 4800 Wheaton Drive, Fort Collins, Colorado 80525, (303) 226-0500.

 **Comlinear
Corporation**

Components

is -55 to $+85^{\circ}\text{C}$, and to $+125^{\circ}\text{C}$ with derating (to 67% rated voltage).

The capacitors are available taped on 8- or 12-mm reels per EIA 481A, for use with automatic-placement machinery. Dissipation factor is 8% max for units rated from 4 to 6.3V; 6% max for 10 to 25V devices; and 4% for 35 to 50V units. A $1\text{-}\mu\text{F} \pm 20\%$, 35V capacitor, \$0.21 (1000). Delivery, 8 to 12 weeks.

Sprague Electric Co, Box 9102, Mansfield, MA 02048. Phone local office.

Circle No 616

TRANSFORMERS

Designed for use in audio and CRT circuitry, these toroidal power transformers offer about the same power ratings as laminar units but cut size and weight by about 50%. The units are designed for 120V ac, 50- or 60-Hz operation and spec

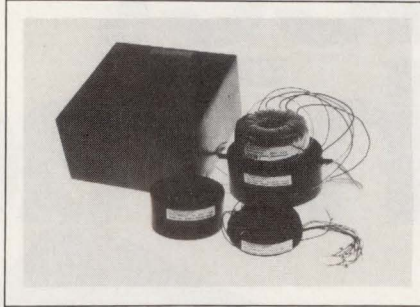

primary-to-secondary dielectric strength of 2500V rms. Maximum operating temperature is 220°F , and the units exhibit a maximum temperature rise of 150°F at rated power.

The manufacturer supplies the transformers with either a metal mounting disk and two insulating pads, or with a molded-in threaded insert. Power ratings for 60-Hz transformers range from 24 to 3000 VA. Standard winding configurations are single or dual primary windings and dual secondary windings rated at 6, 9, 12, 18, 24, 30, 36,

48, 60, and 120V. A dual-primary and -secondary, 1000-VA transformer costs \$65 (100).

Bicron Electronics Co, Barlow St, Canaan, CT 06018. Phone (203) 824-5125. TWX 510-101-3050.

Circle No 618

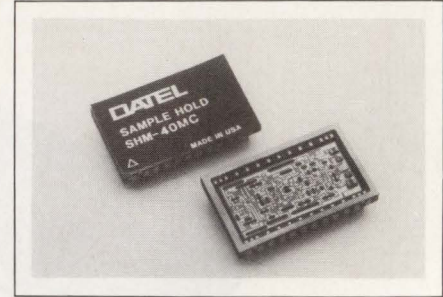

SAMPLE/HOLD AMP

Designed for video applications, Model SHM-40 is a 10-bit sample/hold amplifier that specs a 40-nsec max acquisition time to 0.1% for a 2V step. Sample-mode bandwidth is 40 MHz. This hybrid S/H contains

CY525 3rd generation STEPPER MOTOR CONTROLLER

most intelligent controller offers linear ramping, 10,000 steps/sec, unlimited stepping, change rate on the fly, read position on the fly, and much more.

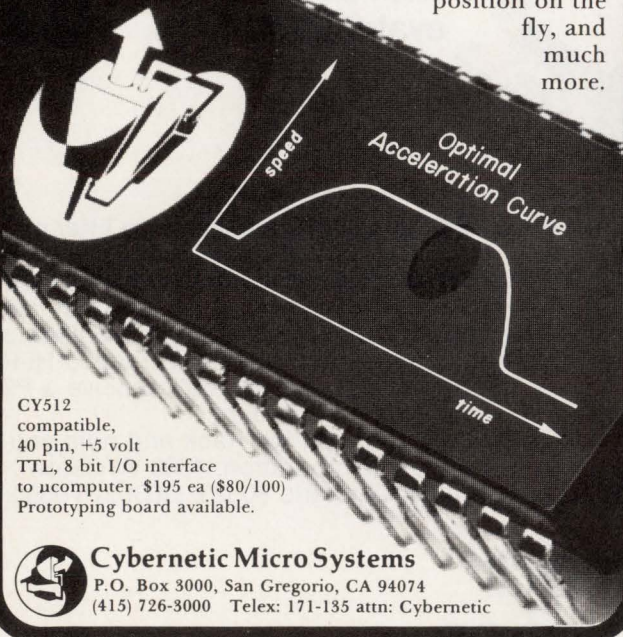

CY512 compatible, 40 pin, +5 volt TTL, 8 bit I/O interface to ucomputer. \$195 ea (\$80/100) Prototyping board available.

Cybernetic Micro Systems
P.O. Box 3000, San Gregorio, CA 94074
(415) 726-3000 Telex: 171-135 attn: Cybernetic

CIRCLE NO 23

IN MULTI-POLE, MULTI-THROW DIP SWITCHES, GRAYHILL OFFERS MULTI-CHOICES.

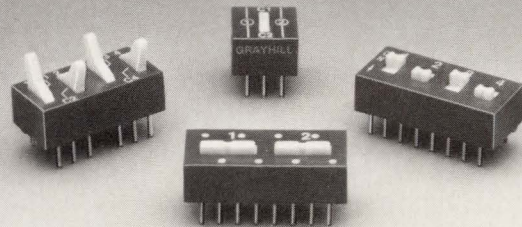

Even your most unusual DIP switch circuitry requirements can be met by Grayhill. Your choices include 2PST, 3PST, 4PST, SPDT and DPDT, in addition to our complete range of SPST models. And your choices don't stop with circuitry—Grayhill also provides a complete range of actuations and sizes for your special-circuitry DIPs: slide, raised or recessed rocker, or toggle; 1 through 5 stations, depending on circuitry and actuation.

GRAYHILL DIP SWITCH FEATURES

- Reliability-proven, spring-loaded, sliding-ball contact system tested to 15,000 operations
- 100% electrical inspection
- Epoxy-sealed base standard, optional top seal available (except toggles)
- 100% pin straightening

Available off-the-shelf from Grayhill or your local Grayhill distributor. For FREE literature, including specifications, prices and the location of your nearest distributor, contact:

Grayhill INC.

561 Hillgrove Avenue, P.O. Box 10373
LaGrange, Illinois 60525-0373 USA
Phone: (312) 354-1040 TLX: 6871375
TWX: 910-683-1850 FAX: (312) 354-2820

CIRCLE NO 24

Copies of articles from this publication are now available from the UMI Article Clearinghouse.

For more information about the Clearinghouse,
please fill out and mail back the coupon below.

Yes! I would like to know more about UMI Article Clearinghouse.
I am interested in electronic ordering through the following
system(s):

- DIALOG/Dialorder ITT Dialcom
 OnTyme OCLC ILL Subsystem
 Other (please specify) _____
 I am interested in sending my order by mail.
 Please send me your current catalog and user instructions for
the system(s) I checked above.

Name _____
Title _____
Institution/Company _____
Department _____
Address _____
City _____ State _____ Zip _____
Phone () _____

UMI Article
Clearinghouse

Mail to:
University Microfilms International
300 North Zeeb Road, Box 91
Ann Arbor, MI 48106

EDN122586

Components

an input buffer amplifier, an analog switch, a hold capacitor, and two output amplifiers that you can connect in parallel to reduce output impedance and double the available output current. Other specs include a hold-mode droop of $100 \mu\text{V}/\mu\text{sec}$ and -60-dB max feedthrough. Housed in a 24-pin, hermetically sealed ceramic package, the SHM-40 is available in three operating temperature ranges: 0 to 70°C , -25 to $+85^\circ\text{C}$, and -55 to $+125^\circ\text{C}$. Single-quantity prices for the three ranges are \$152, \$161, and \$171, respectively.

GE Datel, 11 Cabot Blvd, Mansfield, MA 02048. Phone (617) 339-9341. TWX 710-346-1953.

Circle No 617

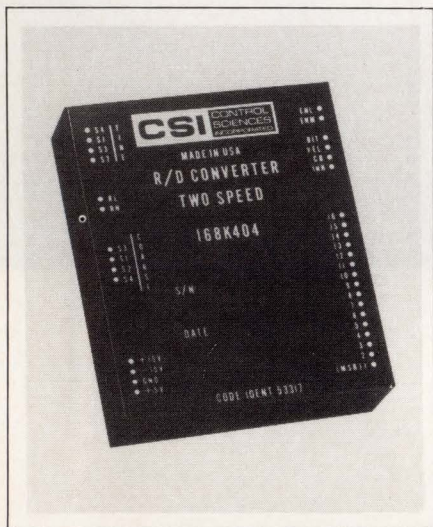

S/D CONVERTERS

Two single-module, 2-speed tracking synchro/resolver-to-digital converters, the Models 168K400 and 168K500, offer 16- or 20-bit resolution. They have automatic compensation for the large input phase shifts that are common to many precision, multipole synchros and resolvers. The converters incorporate 3-state output data latches to provide easy interface with microprocessors or computer systems. Full-temperature accuracy for the 20-bit 168K500 is ± 7 sec; ± 20 sec for the 16-bit 168K400. Standard speed ratios are 1:36, 1:32, and 1:16.

Input voltages cover the range 3 to 130V, 400 to 1200 Hz (16 bit), and 400 to 2600 Hz (20 bit). The converters are housed in $2.6 \times 3.1 \times 0.82$ -in. modular packages. Unit prices for the 16- and 20-bit devices are \$695 and \$995, respectively. Delivery, four to six weeks ARO.

Control Sciences Inc, 9509 Vas-sar Ave, Chatsworth, CA 91311. Phone (818) 709-5510.

Circle No 620

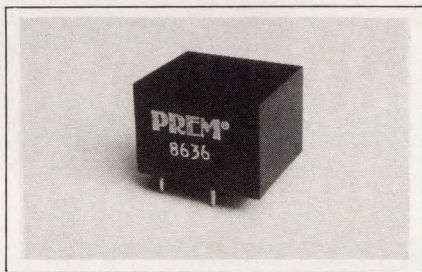

LINEARITY COIL

Suitable for use in data-display products that use CRTs, this linearity coil is a dual-winding device that uses permanent magnets. The configuration provides the correct inductance-vs-current curve in CRT deflection and correction circuitry. The coil also incorporates a control winding that allows for electronic adjustment. A positive or negative dc bias effects the adjustment, as opposed to other devices' physical adjustment, which requires access to an enclosure's internal area. The electronic-adjustment feature also allows for much easier adjustment when a system uses multiple operating frequencies. The control circuit consumes less than 1W. The coils are manufactured to custom specifications. Typical pricing is less than \$2 (OEM qty).

Prem Magnetics Inc, 3521 N Chapel Hill Rd, McHenry, IL 60050. Phone (815) 385-2700. TWX 910-642-3763.

Circle No 621

ENCODERS

These digital contacting encoders are designed for use in high-volume

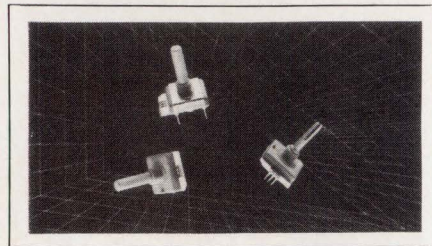

appliance, instrumentation, and other applications. One style features a 24-cycle quadrature output and 24 detent positions (normally open). A second style offers a 9-cycle quadrature output and 36 detent positions (one state change per detent position). An assortment of shaft styles is available. All the encoders operate over -25 to $+125^\circ\text{C}$ and spec an operating life of 200,000 revolutions (100,000 cycles).

The electrical output for both styles is a 2-bit Gray code; channel A leads channel B by 90° in clockwise rotation. Closed-circuit resistance is 5Ω max, and open-circuit resistance is $100\text{ k}\Omega$ min. The encoders' contact rating is 10 mA at 10V dc, or 0.1W max. Prices start at \$2.98 (500). Delivery, 10 to 12 weeks ARO.

Bourns Inc, 1200 Columbia Ave, Riverside, CA 92507. Phone (714) 781-5050.

Circle No 619

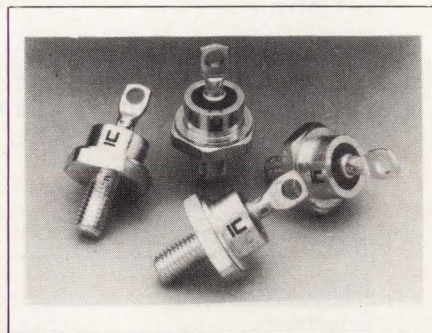

LOW- V_F SCHOTTKYS

These two Schottky rectifiers, Models USD7520 and USD7525, are optimized for use with low-voltage (for example, 2 or 3.3V) loads. They come in DO-5 packages and have 75A, 20 and 25V ratings, respectively. The devices spec $0.425\text{V } V_F$ at 60A and 125°C case temperature, as

AT&T. Because choosing wire shouldn't be an adventure.



How can you be sure you're getting the best wire—the right wire—for all your transmission needs? Specify AT&T wire.

Because nobody gives you AT&T's years of experience and understanding in designing wiring for transmission and computer systems. And, nobody can give you all of AT&T's product innovations, such as dual foam insulation for greater data transmission rates;

irradiated PVC for tougher wire protection; and low friction vinyl jackets for pulling wire through tight spaces. And, nobody gives you AT&T's experts, who will work with you to match the right insulation, shield and sheath to optimize the performance of your wire.

So why make choosing wire an adventure when you can be sure? Make "The right choice." Call 1800 372-2447 for more

CIRCLE NO 65

information about AT&T's full line of wire and cable products for premise distribution and peripheral connections. © 1985 AT&T Technologies, Inc.



AT&T
The right choice.

REACT...

LETS YOU RETRIEVE DETAILED PRODUCT INFORMATION IN AN INSTANT!

EDN and EDN News offer you the fastest system ever to retrieve additional product information from an advertiser.

It's called REACT, for Cahners Reader Action Service. And it allows you to receive in minutes what used to take weeks.

All you do is look for the toll-free REACT phone number appearing in ads in EDN and EDN News. Then call the number from your modem-equipped personal computer or terminal.

You'll be shown product descriptions, price lists, and technical specifications right on your computer screen. Plus you can access this data 24 hours a day, seven days a week for up to 15 minutes without charge.

REACT enables you to respond to an advertising message after reading it and to receive the additional information you want *immediately*.

The next time you see an ad that interests you, all you have to do is REACT.

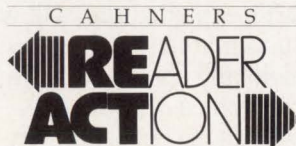

Components

opposed to the 0.6V for currently available 45V Schottky products. The manufacturer claims that this lowered V_F yields a 30% reduction in output-rectifier power losses. Both ECL and newer VLSI circuits can incorporate these low-drop rectifiers. The ECL systems require a 2V supply, and some new VLSI circuits operate from a 3.3V supply. USD7525, \$7.07 (100).

Unitrode Corp, 5 Forbes Rd, Lexington, MA 02173. Phone (617) 861-6540.

Circle No 622

POTENTIOMETER

The TFD1275 is an isolated, 12-bit, multiplying D/A converter configured to operate as a digital potentiometer. It features 350V pk isolation between the digital control inputs and the analog circuitry, thus providing a fully floating analog section that mimics the operation of a conventional potentiometer. An on-board isolated dc/dc converter eliminates the need for additional floating power supplies for the analog circuitry.

You define the output ratio by a 12-bit digital word clocked into an internal latch. The digital inputs are CMOS/TTL compatible and sink or source a maximum input current of 1 μ A. The analog section accepts a differential input voltage as high as ± 5 V pk in the frequency range dc to 500 Hz. By adding two external scaling resistors, you can operate the device with analog inputs as high as ± 51 V pk. A built-in test facility provides a digital output when there is no analog input signal, or when the analog output is midway between the analog inputs.

The TFD1275 is housed in a 40-pin package measuring 54.5 \times 29 \times 6.9 mm, and it operates over -55 to $+125^\circ\text{C}$. It requires 5 and 15V supplies. From approximately £220.

Marconi Microsystems Ltd, Hargreaves Rd, Groundwell Industrial Estate, Swindon, Wiltshire SN2

5BE, UK. Phone (0793) 727005. TLX 444460.

Circle No 623

Marconi Electronic Devices Inc, 80 Smith St, Farmingdale, NY 11735. Phone (516) 420-8378.

Circle No 624

PRESSURE SENSORS

PDCR810 Series solid-state pres-

sure transducers are available with operating pressure ranges between 70 mbar and 70 bar gauge. Their output voltages are 17, 25, and 50 mV for 70-, 175-, and 350-mbar sensors, respectively, and 100 mV for sensors handling pressures of 700 mbar or greater. All parts have a nominal output impedance of 2 k Ω . Zero offset for the sensors is ± 3 mV, and combined nonlinearity and

Bliley

first name in frequency control



Quartz Crystals - Crystal Oscillators

Catalog C/D_s

BLILEY WROTE THE BOOK ON HIGH REL CRYSTALS AND OSCILLATORS. AND YOU CAN HAVE A COPY. FREE!

New 1987 Catalog. Complete data for full line quartz crystals and crystal oscillators, including:

- Surface Mount and SC Cut crystals
- OCXO and TCVCXO oscillators

Phone or send for your copy now.

BLILEY ELECTRIC COMPANY

2545 West Grandview Blvd.
P.O. Box 3428, Erie, PA 16508
(814) 838-3571 TWX 510-696-6886



CIRCLE NO 25

Components

hysteresis is $\pm 0.1\%$ for the ranges to 60 bar, and $\pm 0.2\%$ for the 70-bar device. You can operate the sensors with fluid pressure media compatible with quartz and titanium. They are available in gauge, absolute, and differential versions for approximately \$350, \$515, and \$95, respectively.

Druck Ltd, Fir Tree Lane, Groby, Leicestershire LE6 0FH, UK. Phone (0533) 878551. TLX 341743.

Circle No 627

CAPACITORS

YD24 Series single-layer ceramic capacitors are tested to 1.8 kV ac, ensuring that they withstand successive transients well in excess of those for which normal Y-class capacitors are rated. They are available with capacitance values in the range 2.2 to 4.7 nF, with a tolerance of $\pm 20\%$. Their rated voltage is

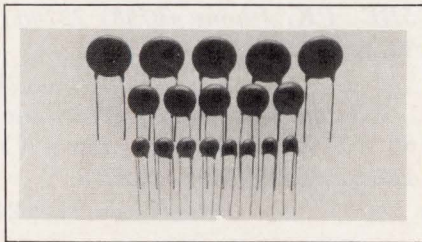

250V ac at 50 Hz. YD24 Series capacitors are approved to VDE 0565 Part 1, and they conform to the BS923 1.2/50 lightning standard to a minimum level of 8 kV. From £0.15 to £0.20 (10,000).

Beck Electronics Ltd, Main Cross Rd, South Denes, Great Yarmouth, Norfolk NR30 3PX. Phone (0493) 856282. TLX 975682.

Circle No 628

F/V CONVERTER

Converting pulse interval times to proportional voltage or current signals, the KAZ-721 F/V converter operates at frequencies as low as

0.005 Hz. For signals below 500 Hz, pulse widths must be at least 500 μsec . Above 500 Hz, the pulses may be as short as 50 μsec . Linearity for the output signal is 0.25% of full scale, and the unit's computational error is 0.3% of full scale. You can specify either a voltage- or a current-output model. The input and output signals are isolated from each other in both models. The voltage model supplies a 0 to 10V output into a 1-k Ω or higher resistance load. The current-output model furnishes a standard 4- to 20-mA output signal into loads of less than 500 Ω . Each unit incorporates its own power supply, which operates from 117V ac at 48 to 80 Hz. \$325.

Coco Research Inc, The First Maruzen Bldg, 16-12, Nishi-Shinjuku 6-Chome, Shinjuku-ku, Tokyo 160, Japan. Phone (03) 348-1021.

Circle No 629

POWER YOUR DISPLAYS FROM LOW DC VOLTAGE!

DC-DC Converters & Smart Force™ DC-AC Inverters to power:

- Electroluminescent Lamps,
- Plasma Gas Discharge,
- Vacuum Fluorescent,
- TFEL Displays, and More!

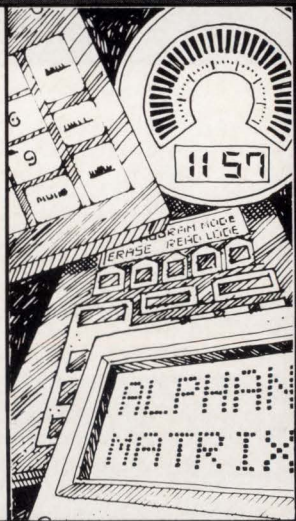

FREE Data Packet includes:

- **CROSS REFERENCE INDEX** — matches ERG converters to various plasma and VF displays.
- **EL SOURCE LIST** — helps source EL Lamps, LCDs, membrane switches, etc.

Call today for complete product information and pricing:



Endicott Research Group, Inc.

2601 Wayne Street P.O. Box 269 Endicott, NY 13760
607-754-9187 TWX 510-252-0155

The DC PowerHouse

© 1986 ERG, Inc.



YOU LIKE TO WRITE, RIGHT?

Then EDN wants you, providing you also have an EE degree and at least two years' circuit-design experience. We seek individuals who want to be Boston-based technical editors for this top electronics publication.

To qualified individuals, EDN offers an attractive salary, industry-wide recognition, high job satisfaction, and the ability to keep abreast of...

- Advanced Technology
- Exciting New Products
- State-of-the-art circuit and system-design techniques

If you thrive on meeting challenges head-on...

If you are an effective, technical communicator...then send your resume and salary requirements in strict confidence to: Roy Forsberg, Editorial Director, EDN, Cahners Building 275 Washington St., Newton, MA 02158-1630, 617/964-3030

An Equal Opportunity Employer

Components

FILM CAPACITORS

Metallized film SMD capacitors in the MKS-01-SMD family are available with capacitance values from 0.01 to 0.1 μF , in $\pm 20\%$ or $\pm 10\%$ tolerance versions. They have a voltage rating of 50V dc. All values fit into flame-retardant plastic cases with a length of 5.7 mm

At 20°C the capacitors have an insulation resistance of greater than 3.75 G Ω and dissipation factors (tan δ) of 8×10^{-3} , 20×10^{-3} , and 30×10^{-3} (or less in each case) at frequencies of 1, 10, and 100 kHz, respectively. They operate over -55 to $+100^\circ\text{C}$ and are suitable for application class FME in accordance with DIN-40040. Approximately \$0.17 (1000) for a 0.047- μF , 20%-tolerance capacitor.

Wilhelm Westermann-Wima, Box 2345, 6800 Mannheim 1, West Germany. Phone (0621) 408012. TLX 462237.

Circle No 625

CODED SWITCHES

The DRS and DRR series of 10×10 -mm, pc-board-mountable rotary switches include versions with BCD or hexadecimal coding and true or complemented outputs. You can also choose versions with a flush screwdriver-slot actuator, or with a 7-mm-long actuating shaft incorporating the screwdriver slot at its end. DRS Series switches mount with the actuator perpendicular to the pc board, and DRR Series switches mount with the actuator parallel to the pc board. All pinouts suit a 2.54-mm (0.1-in.) hole grid. The switch contacts are rated to switch 15V/30 mA dc and to carry 50V/100 mA dc. The contacts have a contact resistance of less than 100 m Ω max and are rated for more than 20,000 switching operations. DM 2.43 (1000) for a BCD version.

Knitter-switch, Knitter & Co KG, Postfach 100233, 8011 Baldham/Munich, West Germany. Phone (08106) 4041. TLX 528338.

Circle No 626

BUSINESS/CORPORATE STAFF

F Warren Dickson
Vice President/Publisher
Newton, MA 02158
(617) 964-3030
Telex 940573
Diann Siegel, Assistant

Peter D Coley
Associate Publisher/
Advertising Sales Director
Newton, MA 02158
(617) 964-3030
Stacey Vorias, Assistant

NEW ENGLAND
Bob Sommer, Regional Manager
275 Washington St
Newton, MA 02158
(617) 964-3030

STAMFORD 06904
George Isbell, Regional Manager
8 Stamford Forum, Box 10277
(203) 328-2580

ROSELAND, NJ 07068
Daniel J Rowland, Regional Manager
Chris Platt, Regional Manager
103 Eisenhower Parkway
(201) 228-8619
(201) 228-8620

PHILADELPHIA AREA
Steve Farkas, Regional Manager
999 Old Eagle School Rd
Wayne, PA 19087
(215) 293-1212

CHICAGO AREA
Clayton Ryder, Regional Manager
Randolph D King, Regional Manager
Cahners Plaza
1350 E Touhy Ave, Box 5080
Des Plaines, IL 60018
(312) 635-8800

DENVER 80206
John Huff, Regional Manager
270 St Paul St
(303) 388-4511

DALLAS 75234
Don Ward, Regional Manager
13740 Midway, Suite 515
(214) 980-0318

SAN JOSE 95128
Walt Patstone, Regional Manager
Bill Klank, Regional Manager
Philip J Branon, Regional Manager
Mark Holdreith, Regional Manager
3031 Tisch Way, Suite 100
(408) 243-8838

LOS ANGELES 90064
Charles J Stillman, Jr
Regional Manager
12233 W Olympic Blvd
(213) 826-5818

**ORANGE COUNTY/
SAN DIEGO 92715**
Jim McErean, Regional Manager
18818 Teller Ave, Suite 170
Irvine, CA
(714) 851-9422

PORTLAND, OREGON 97221
Pat Dakin, Regional Manager
Walt Patstone, Regional Manager
1750 SW Skyline Blvd, Box 6
(503) 297-3382

**UNITED KINGDOM,
THE NETHERLANDS,
SCANDINAVIA**
Jan Dawson, Regional Manager
39A Bowling Green Lane
London EC1R/0BJ UK
44-1-278-2152
Telex: 28339

BELGIUM/FRANCE
Robert Broekman
American Publishers Representatives
4 Rue Robert de Flers
75015 Paris, France
33-1-46099595
Telex: 270560

GERMANY/SWITZERLAND
Wolfgang Richter
Sudring 53
7240 Horb/Neckar
West Germany
49-7451-7828; TX: 765450

AUSTRIA
Igal Elan
Elan Marketing Group
Neutor g 2, Box 84
1013 Vienna, Austria
43222-663012, 638461

SOUTHERN EUROPE
Igal Elan
Elan Marketing Group
13 Haifa St, Box 33439
Tel-Aviv, Israel
Tel: 972-3-268020
TX: 341667

FAR EAST
Ed Schrader, General Manager
18818 Teller Ave, Suite 170
Irvine, CA 92715
(714) 851-9422; Telex: 183653

TOKYO 160
Kaoru Hara
Dynaco International Inc
Suite 1003, Sun-Palace Shinjuku
8-12-1 Nishishinjuku, Shinjuku-ku
Tokyo 160, Japan
Tel: (03) 366-8301
Telex: J2322609 DYNACO

TAIWAN
Owen Wang, Gen Mgr
Ace Marketing Inc
Box 26-578 Taipei, Taiwan
Republic of China
86-2-703-4272
Telex: 14142

KOREA
Korea Media Inc
Rm 110, A-11 Bldg 49-4,
Hoihyundong 2-Ka, Chung-Ku
CPO Box 2314, Seoul, Korea
Tel: 82-2-755-9880
Telex: K26249

SINGAPORE
Cheny Tan Associates
1 Goldhill Plaza
No 02-01
Newton Rd
Singapore 1130
Tel: 2549522
Telex: RS 35983 CTAL

PRODUCT MART
Joanne Dorian, Manager
475 Park Avenue South
New York, NY 10016
(212) 576-8015

**CAREER OPPORTUNITIES/
CAREER NEWS**
Roberta Renard
National Sales Manager
103 Eisenhower Parkway
Roseland, NJ 07068
(201) 228-8602

Janet O Penn
Eastern Sales Manager
103 Eisenhower Parkway
Roseland, NJ 07068
(201) 228-8610

Dan Brink
Western Sales Manager
2041 Business Center Dr
Suite 109
Irvine, CA 92715
(714) 851-9422

Diann Siegel
Boston Sales Representative
Newton, MA 02158
(617) 964-3030

Maria Cubas
Production Assistant
(201) 228-8608

Cahners Magazine Division
William Platt, President
Terry McDermott, Executive Vice President
Tom Dellamaria, VP/Production & Manufacturing

Circulation
Denver, CO: (303) 388-4511
Sherri Gronli, Group Manager
Eric Schmierer, Manager

Reprints of EDN articles are available on a custom printing basis at reasonable prices in quantities of 500 or more. For an exact quote, contact Joanne R Westphal, Cahners Reprint Service, Cahners Plaza, 1350 E Touhy Ave, Box 5080, Des Plaines, IL 60018. Phone (312) 635-8800.



2,000 sharper-than-ever characters all on a portable LCD display.

Toshiba's newest LCD modules give you 640×200 dot displays in a choice of two viewing sizes. One is approximately the size of a magazine, and the other about half that size.

Both sizes put an enormous amount of information on view... an array of 80 characters \times 25 lines. But still bulk and power consumption are at a minimum. Battery powered, these slim modules interface with various systems through LCD controller without renewing software.

Toshiba's advanced technology has also eliminated surface reflection and developed a sharper contrast which gives a brighter and easier to read viewing screen. And for low light or dark viewing an optional backlightable LCD is available.

These versatile LCDs are ideally suited for applications as displays for personal computers, POS terminals, portable word processors and other display terminals. You can also look to Toshiba with confidence for a wide range of sizes and display capacity to suit your LCD requirements.

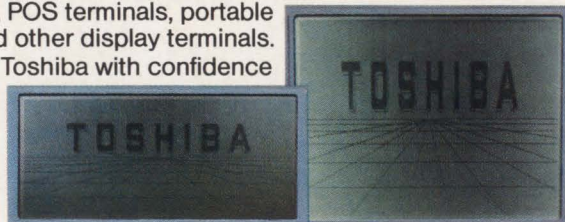

TLC-363

TLC-402

Specifications

	TLC-402	TLC-363B
Display		
Number of Characters	80 \times 25 (2,000 characters)	80 \times 25 (2,000 characters)
Dot Format	8 \times 8, alpha-numeric	8 \times 8, alpha-numeric
Overall Dimensions (W \times H \times D)	274.8 \times 240.6 \times 17.0 mm	275.0 \times 126.0 \times 15.0 mm
Maximum Ratings		
Storage Temperature	-20° ~ 70° C	-20° ~ 70° C
Operating Temperature	0° ~ 50° C	0° ~ 50° C
Supply Voltage	VDD 7 V	7 V
	VDD - VEE 20 V	20 V
Input Voltage	0 \leq VIN \leq VDD	VSS \leq VIN \leq VDD
Recommended Operating Conditions		
Supply Voltage	VDD 5 \pm 0.25V	5 \pm 0.25V
	VEE -11 \pm 3V Var.	-11 \pm 3V Var.
Input Voltage	High VDD - 0.5V min.	VDD - 0.5V min.
	Low 0.5V max.	0.5V max.
Typical Characteristics (25°C)		
Response Time	Turn ON 300 ms	300 ms
	Turn OFF 300 ms	300 ms
Contrast Ratio	3	3
Viewing Angle	15 - 35 degrees	15 - 35 degrees

Design and specifications are subject to change without notice.

TOSHIBA

Toshiba America, Inc.: Electronic Components Business Sector: Head Office: 2692 Dow Avenue, Tustin, CA 92680, U.S.A. Tel. (714) 832-6300
Chicago Office: 1101 A Lake Cook Road, Deerfield, IL 60015, U.S.A. Tel. (312) 945-1500

Toshiba Europa (I.E.) GmbH: Electronic Components Div.: Hammer Landstrasse 115, 4040 Neuss 1, F.R. Germany Tel. (02101) 1580

Toshiba (UK) Ltd.: Electronic Components Div.: Toshiba House, Frimley Road, Frimley, Camberley, Surrey GU 165JJ, England Tel. 0276 62222

Toshiba Electronics Scandinavia AB: Vasagatan 3, 5 TR S-111 20 Stockholm, Sweden Tel. 08-145600

EDN PRODUCT MART

This advertising is for new and current products.

Please circle Reader Service number
for additional information from manufacturers.

Intel SYSTEMS & BOARDS

- SYSTEM 310, 330, 380
from \$1500
• Options, upgrades, spares, parts, repairs in stock
- SERIES II, III, IV, MDS-800
PDS-IX from \$299
• ALL Options and Upgrades & Parts available
- ICE 49A, 51, 80, 85B, 86A
88A, 286 from \$349
- SBC and SBX boards
from \$49
- MULTI BUS™ products from:
Zendex, NSC, AMD, DTC, Callan, Interphase, ...

WE **BUY-SELL-TRADE**
INVENTORY EXCESS, PROJECT RESIDUALS

CPM 634 N. 8th Street Intel, zendex, spc.
San Jose, Ca. 95112 sbx, ice, are reg-
istered trademarks
408-993-9011 FAX: 993-1120

CIRCLE NO 198

NEW COMPLETE BASIC COMPUTER



ADVANCED MICRO SYSTEMS BAS-52 computer card, with a full featured basic instruction set, is at home on or off the STD bus. The dual RS-232 ports allow line editing for programming and storage of basic and assembly language routines in the system. The 59 ports include 24 filtered inputs and 24 outputs capable of driving up to 400ma.

AMS ADVANCED MICRO SYSTEMS, INC.
31 Flagstone Drive, Hudson, NH 03051
603-882-1447

CIRCLE NO 199

LCD MODULES with LED BACKLIGHTS

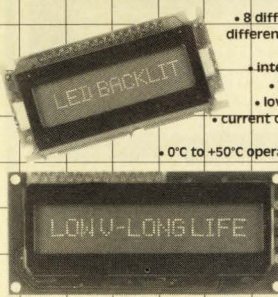

- 8 different modules in 4 different sizes (1x16, 2x16, 4x16 and 4x20)
- integral LED backlight
- yellow/green color
- low voltage; long life
- current consumption: 50 or 60mA typ.
- 0°C to +50°C operating temperature range
- built-in controller: 8-bit parallel input
- availability from stock

DC DENSTRON CORPORATION
Torrance, CA (213) 530-3530 Europe/UK (0959) 71011

CIRCLE NO 200



IMS 

CHIP RESISTORS

SURFACE MOUNTED DEVICES
SMD #1206 & 805
24 HOUR DELIVERY
16 Other Sizes in Stock
NO CHARGE FOR SAMPLES

401-683-9700
International Manufacturing Serv.
50 Schoolhouse Lane, Portsmouth, RI 02871

CIRCLE NO 201

BLAST



WANG IBM
Data General JAT&T HEWLETT PACKARD
PRIME MS-DOS
NCR CP/M
apple UNIX

PC to MINI to MAINFRAME COMMUNICATIONS SOFTWARE
The low cost solution for linking hundreds of PCs with central systems!

- An Asynchronous Connectivity Tool • No Boards - Uses standard RS-232 ports • Provides distributed data management • Sends binary or text data or commands • Sends spreadsheets, programs, etc • 100% error-free data transfer • Links different operating systems • Uses phone lines, LANs packet nets • Connects multiple sites, unattended • Uses any low-cost modems, any speed

• \$250 / Micros • \$495-895 / Minis • \$2995 up / Mainframes

COMMUNICATIONS RESEARCH GROUP
5615 Corporate Blvd. Baton Rouge, LA 70808 (504) 923-0888
(800)-24-BLAST

CIRCLE NO 202



Glide Through PCB Design With Tango-PCB. Just \$495.

Create the toughest board designs with powerful layout software that's a snap to use. Function-rich Tango-PCB supports eight layers, true power and ground planes, OrCAD™ or Schema™ netlist input, and more. For IBM PC/XT/AT. Compare features and you'll buy Tango-PCB. Just \$495. Or try full-function Demo Package, just \$10. Thirty-day money-back guarantee. Order toll-free: 800 433-7801 In CA: 800 433-7802 VISA/MC
ACCEL Technologies, Inc. **TangoPCB™**
7358 Trade St. San Diego, CA 92121

CIRCLE NO 203

To advertise in Product Mart, call Joanne Dorian, 212/576-8015

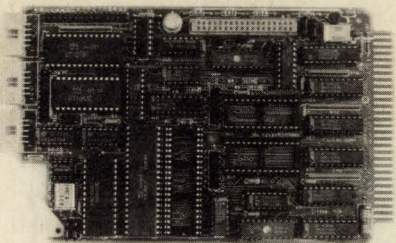

CMOS 80C88 SINGLE BOARD STD BUS COMPUTER

Features the 16-bit 8088 with 8087 coprocessor socket and 1 Mbyte addressing. On-board functions include 2 JEDEC 28-pin memory sockets for up to 128K bytes of RAM. EPROM, or EEPROM. Includes one RS-232/RS-422 serial port, 8259A interrupt controller, 3 16-bit counter/timers, SBX connector, and Watchdog timer. Available in NMOS/TTL or CMOS from

WinSystems, Inc.
PO Box 121361
Arlington, TX 76012
817/274-7553

CIRCLE NO 204

Protect Your Power

Surge Protectors

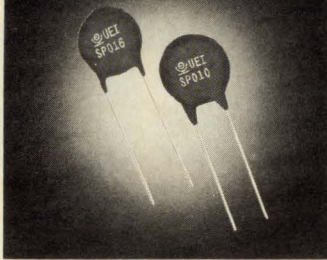

Inrush current suppressing devices specially designed for switching power supplies.



UPPERMOST
Electronic Industries Co., Ltd.
59, Wen Hua Road, Kaohsiung, Taiwan, R.O.C.
Tel: (07) 201-0175 Fax: (07) 282-0935
Telex: 71520 YUNLOON

CIRCLE NO 205

LOW-COST UNIVERSAL PROGRAMMER

From the World's Largest supplier of low-cost programming equipment



Get the FACTs about E/PROM/PLD/MICRO programming and UV ERASER products from the only company that has managed to supply low-cost quality equipment for years and maintained superb customer support. All products 100% made in U.S. 14 day money back guarantee.

LOGICAL DEVICES INC.

TOLL FREE 1321 NW 65TH PL.
1-800-331-7766 Ft. Lauderdale FL 33309
FL (305)974-0967 Telex 383142

CIRCLE NO 206

EPROM PROGRAMMER \$349

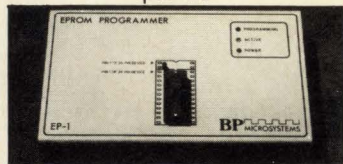

The EP-1 is a great value, here's why:

- IBM PC Software included or RS-232 to any computer
- ASCII Command driven operation. All intelligence in unit
- Reads, Programs, Copies over 150 types from 2716 to 27512
- Optional Intel microcontroller programming head
- Menu-driven Chip Selection; No Personality Modules
- Fast, Slow, Quick-Pulse Programming Algorithms
- Intel (8080 & 8086), Motorola, Tekhex, Straight Hex Files
- Splits Files by Base Address and Odd/Even (16 bit systems)
- Gold Textool ZIF IC socket
- Full One-Year Warranty
- Generate & Set Checksums
- 5, 12.5, 21, 25V Programming
- Over-Current Protection
- U.V. Erasers from \$34.95
- 8 Baud Rates 300 to 38,400
- Same Day Shipment



10681 Haddington, #190 / Houston, TX 77043
(713) 461-9430 (800) 225-2102

CIRCLE NO 207

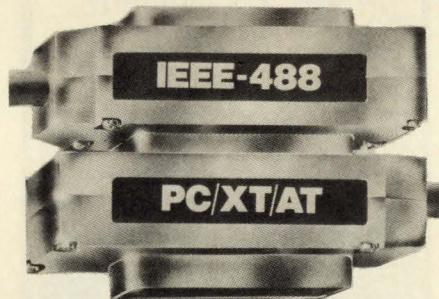

IEEE-488 CONTROL FROM YOUR PC.

- Emulate hp and Tektronix controllers.
- Fast and easy-to-use. Thousands sold.
- Program in BASIC, C, FORTRAN, or Pascal
- Hardware and software - \$395 complete.



Capital Equipment Corp.
99 South Bedford St.
Burlington, MA. 01803
Call today 617-273-1818

CIRCLE NO 208

GET BIG RESULTS WITH PRODUCT MART ADS

REACH OVER 137,000
READERS —
ALL SPECIFIERS
OF ELECTRONIC
COMPONENTS, SYSTEMS
AND EQUIPMENT!

CIRCLE NO 209

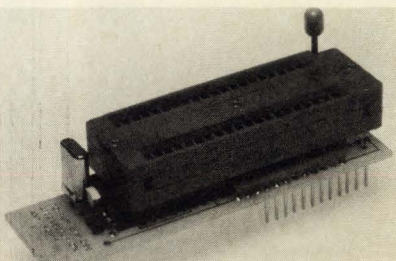

\$95 8751 PROGRAMMER

UPA8751 converts any programmer into an 8751 programmer. Production programming of 8751s is fast and cheap with your gang programmer and one or more UPA8751s. Use the UPA8751 to copy protect your code by programming the 8751 security bit. Price \$95 UPS Ground shipping included.

Logical Systems also provides development tools and services. We carry Simulators and Cross-Assemblers. For information call or write:

Logical Systems
6184 Teall Station
Syracuse, NY 13217 USA
(315) 478-0722 Telex: 6973150 EJB

CIRCLE NO 210

MULTIBUS: Your Time Has Come!

The mSBX-241™ Multimodule is a robust, precision Real-Time Clock/Calendar in SBX format with on-board battery backup.

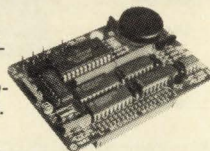

General Features:

- For high performance systems: no wait states or software overhead
- Attaches to all SBX and BLX compatible Multibus boards
- Programmable alarm clock and periodic interrupts
- 12 or 24 hour time modes, in both BCD and binary format
- Internal 100 year calendar with leap year compensation
- Selectable automatic Daylight Savings compensation
- Contains fifty bytes of general purpose non-volatile RAM
- RMX-86/286 drivers supplied on diskette

For more information contact:

Medinova Corporation
Intelligent Systems Group
244 West Court, Palatine, Illinois 60067
Telephone (312) 934-4700
Multibus, Multimodule TM Intel Corp.

CIRCLE NO 211

Power Control

110/220 AC by your IBM-PC

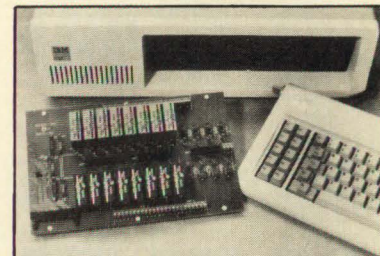

The boards allow you to Control/Monitor high voltage AC/DC power lines with your IBM-PC/XT/AT or compatible while providing optical isolation.

QUA TECH, INC.

478 E. Exchange St. Akron OH 44304
(216) 434-3154 TLX: 5101012726

CIRCLE NO 212

6800/6809 Micro Modules

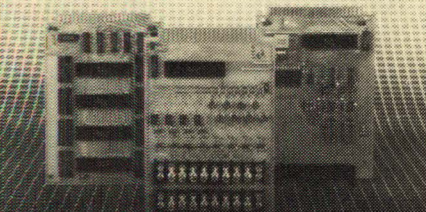

OEM 6800/6809 MICROCOMPUTER MODULES for dedicated control and monitoring. Interfaces for sensors, transducers, analog signals, solenoids, relays, lamps, pumps, motors, keyboards, displays, IEEE-488, serial I/O, floppy disks.



CIRCLE NO 213

NEW PRESSURE TRANSDUCER

FREE FOR O/E M TEST

- Stainless steel
- Strain gage

Call free
800-323-7115
In PA, 800-323-7114



Robinson-Halpern
COMPANY
A Subsidiary of Teleflex Incorporated (USA)

CIRCLE NO 214

ANNOUNCING PC-XIO

A unique low cost I/O board for industrial and scientific applications

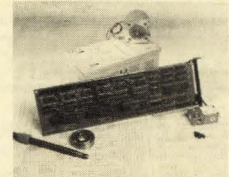

- IBM-PC or bus compatible parallel interface board
- 72 discrete inputs or outputs
- 8 latching interrupts
- Software and documentation in microsoft basic, turbo pascal, lattice C and 8088 assembly code
- (Ribbon cable included) \$445.00

STEP CONTROL LTD.

910 St. Vincent Ave., #4
Santa Barbara, CA 93101
(805) 966-9553

CIRCLE NO 215

CY232 NETWORK CONTROLLER AND PARALLEL-SERIAL INTERFACE

will connect any RS232 CRT or computer to any 8-bit parallel TTL I/O port and works with one port or up to 255 parallel ports in several network configurations.

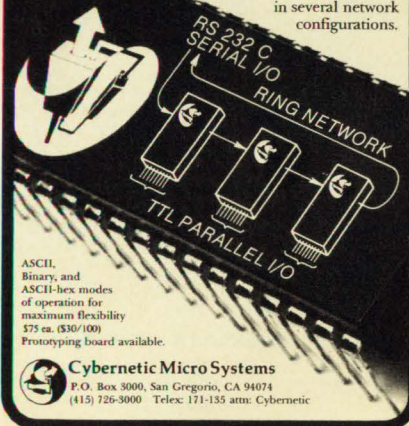

ASCII, binary, and ASCII-hex modes of operation for maximum flexibility \$75 ea. (\$30/100) Prototyping board available.

Cybernetic Micro Systems
P.O. Box 3000, San Gregorio, CA 94074
(415) 726-3000 Telex: 171-135 atm Cybernetic

CIRCLE NO 216

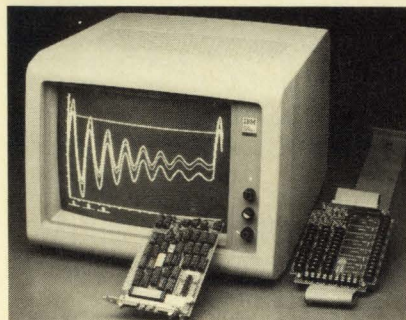

HIGH PERFORMANCE A/D CARD - \$595

- For IBM PC, XT, AT and compatibles
- 8 differential analog inputs, 12-bit
- 6 software selected ranges, self cal
- 12 digital I/O's
- Application software included
- Driver included - program in 6 languages
- Integrating converter, 10,000 Hz
- Compensates & linearizes thermocouples

STRAWBERRY TREE COMPUTERS
1010 W. Fremont Ave., Sunnyvale, CA 94087
408-736-3083

CIRCLE NO 217

DOT MATRIX LCD MODULES

- 1x8 to 4x40 sizes
- .15" to .5" character heights
- On-board controller • 8-bit parallel input • Reflective, transmissive; positive or negative images • -20°C to +70°C operating temperature
- EL backlighting available

SHELLY
associates

14281 Chambers Rd.
Tustin, CA 92680
(714) 669-9850
FAX: 714-669-1081
TLX: 85-2263

CIRCLE NO 218

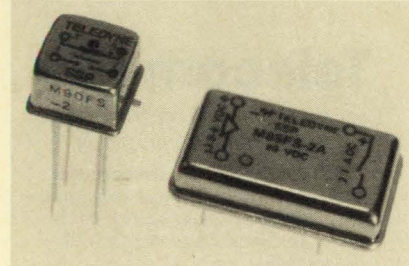

DC SWITCHING HYBRIDS (SHORT CIRCUIT PROTECTED)

- Integrated short-circuit protection
- Functions as a Remote Circuit Breaker
- Power FET output
- Fast switching speed
- Low on-resistance (0.15 ohms typ.)
- Virtually no offset voltage
- Opto isolation up to 1200 volts
- Hybrid microelectronic design
- Meets MIL-STD-704A surge and spike requirements
- Input TTL compatible
- 3.8 to 32.0 volt input range
- Constant current input
- Designed to MIL-R-28750
- Available to the screening requirements of MIL-STD-883
- Radiation hardening levels data available
- M85FS-2A 2.1 Amps at 60VDC
- M90FS-2 1 Amp at 60VDC

\$146/\$189 at 100 pieces
Teledyne Solid State
12525 Daphne Avenue, Hawthorne California 90250 (213) 777-0077

CIRCLE NO 219

VMEbus USERS!

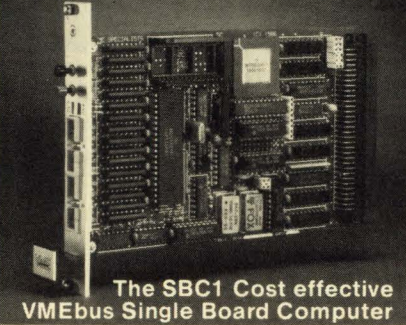

The SBC1 Cost effective VMEbus Single Board Computer

- Single/double high mounting styles available.
 - 10 Mhz 68000/68010
 - 512Kbyte zero-wait-state RAM
 - 128Kbyte capacity EPROM space
 - Two serial ports/program. baud rates
 - VMEbus system controller
- Perfect for your industrial control application

VME
specialists

558 Brewer Avenue Suite 1
Redwood City, CA 94063
(415) 364-3328
Telex 510-100-9936

CIRCLE NO 220

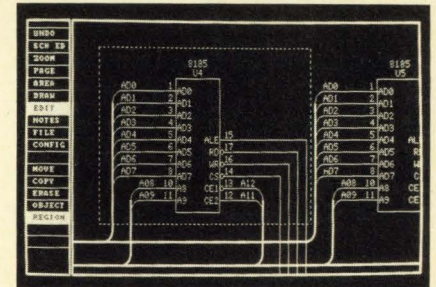

FREE DEMO DISK

SCHEMA is a complete, integrated schematic drawing software package for IBM Personal Computers. Use **SCHEMA** with your PC to draw schematics and automatically generate design documentation such as Wire and Net Lists, Bills of Materials, Design Rule Checks, etc. **SCHEMA** is \$495 and supports most common PC hardware configurations. Call or write today for a free demo disk and brochure.

OMATION INC.

1701 N. Greenville Ave., Suite 809
Richardson, TX 75081
(214) 231-5167

CIRCLE NO 221

ELECTRONIC
ENGINEERS TECHNICIANS
MANAGERS You Need BUYERS

PARTLISTER

For PC Compatibles
GENERATES ERROR FREE REPORTS
 Parts Listing Summary Bill of Materials
 Easy to Learn Easy to Use Well Documented

DATA FIELDS INCLUDE
 Reference Designator Mil Spec Number
 Part Type/Value Preferred Manufacturer
 Company Part Number Description (Comments)
 Cost

REGULAR \$59.95 NOW 'TIL FEB 1, 1987
\$39.50

LIVE WIRE SOFTWARE

Add \$3.00 Shipping and Handling
 (In California add 6.5% sales tax)
 Send check or money order to:
LIVEWIRE SOFTWARE
 P.O. Box 773
 Pacific Palisades, CA 90272
 (213) 454-4492

CIRCLE NO 222

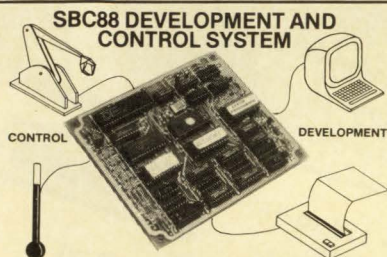

WRITE IT - RUN IT - ROM IT

An 8088 based single board computer that is so simple to use, you will be developing applications programs the first day!

- Choice of 8K BASIC or FORTH in ROM
- 8 channel, 8 bit A/D converter
- Two 8 bit input ports
- Two 8 bit output ports
- Time of day
- Floating point UNIFORTH available
- RS-232 terminal and parallel printer port
- 7 current sinking outputs rated at 500 mA, 50 VDC
- Up to 32K of user memory
- Onboard EPROM programmer

*INVENTORY REDUCTION SALE
 SBC88-2K \$129, while stock lasts
 *SBC88-8K \$199 (\$59/1000)

Vesta Technology, Inc., 7100 W. 44th Avenue, Suite 101, Wheatridge, CO 80033 (303)-422-8088.

CIRCLE NO 225



smARTWORK® Circuit-Board-Artwork Software. For only \$895, **smARTWORK®** lets the design engineer create and revise printed-circuit-board artwork on the IBM Personal Computer. Forget the tedium of taping it yourself or waiting for a technician, draftsman, or the CAD department to get to your projects. With **smARTWORK®** you keep complete control over your circuit-board artwork from start to finish. Call or write to **Wintek Corporation**, 1801 South Street, Lafayette, IN 47904-2993. (317) 742-8428, (800) 742-6809.

CIRCLE NO 228



NEW

The Pulse of Dependable Communications

Crystek Crystals offers their new 16 page free catalog of crystals and oscillators. Offering state of the art crystal components manufactured by the latest automated technology. Custom designed or "off the shelf." Crystek meets the need, worldwide. Write or call today!

CRYTEK CRYSTALS
 1000 Crystal Dr. • Ft. Myers, FL 33907
 P.O. Box 06135 • Ft. Myers, FL 33906-6135
TOLL FREE 1-800-237-3061

CIRCLE NO 223



EE DESIGNER

CAE/ICAD Integrated Software Package for IBM PC, XT or AT \$975
 At only \$975, no electrical engineer can afford to be without this end-to-end circuit design, simulation and PCB layout tool. You can pay up to 15 times more and still not get all the features offered by EE Designer—Schematic Capture... Circuit Simulation... PCB Layout. 30 day money back guarantee. Full purchase price refunded if not completely satisfied.

Call 1-800-225-5669 today to order your package. Bank cards welcome.
VISIONICS
 1284 Geneva Drive
 Sunnyvale, CA 94089

CIRCLE NO 226

NEED CIRCUIT PROTECTION?



and other worldwide approvals

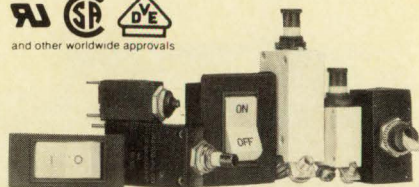

E-T-A has "THE RIGHT STUFF!"

- Commercial, Mil & Low Cost Types
- Magnetic or Thermal
- 0.05 to 400 A, 250V AC or 28V DC
- ON/OFF Switch/Breaker Combination
- PC Board & Snap-in Mounts

E-T-A® CIRCUIT BREAKERS

7400 North Croname Road, Chicago IL 60648 • 312/647-8303

CIRCLE NO 224

NEW PRODUCT

Highest Density Serial Comm. SBX* Module

- 4 RS 232/423, RS 422/485 Channels
- Replaces 2 ISBX 351/2/4's
- Fast: 1.5 Mb/sec
- Double Wide SBX* Module

CML™ Computer Modules, Inc.
 1190 Mira Loma Way, #Y
 Sunnyvale, CA 94086
 (408) 737-7727

CIRCLE NO 227

C CROSS-COMPILERS MACRO CROSS-ASSEMBLERS

VAX	PDP-11	IBM PC
6801/6301	68HC11	
6805	68000/10	
6809	68020	

VAX, PDP-11: TM of Digital Equip. Corp.
 IBM: TM of Int'l. Business Machines

INTROL CORPORATION

647 W. Virginia St.
 Milwaukee, WI 53204
 (414) 276-2937

CIRCLE NO 229

Telecom ICs

Covering the full spectrum of your telecommunications needs

- **Call Progress Detectors and Generator**
 CMOS detectors for telephone system tones (dial tone, ringback, busy, special information); CMOS generator for standard call progress tones.
- **DTMF Receivers**
 High-quality receivers for all applications.
- **MF Receivers and Generator**
 CCITT R1/R2 receivers; CMOS generator.
- **DC Signalling Products**
 Line sense relay; Dial pulse counter and hook status monitor; Binary input pulse dialer.

TELSTONE®

Telstone Corporation
 10801 - 120th Ave. N.E., Kirkland, WA 98033-9974
 Phone (206) 827-9626 TWX 910 449-2862

CIRCLE NO 230

To advertise in Product Mart, call Joanne Dorian, 212/576-8015

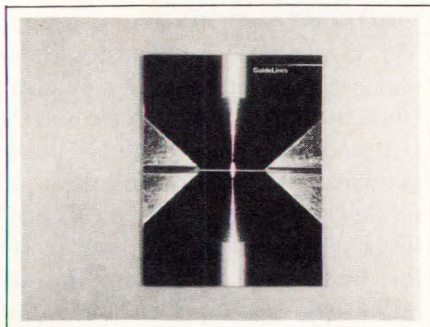

Guide to the business of fiber optics

GuideLines is published quarterly for customers, end users, media, and those interested in the fiber-optics industry. It provides information on fiber-optics-industry trends, applications engineering, fiber installations, business activities, recent fiber applications, and up-to-date literature abstracts. The July issue includes several case histories involving NASA and the Statue of Liberty, as well as a discussion of the implications for LEDs in the telephone company's subscriber loop.

Corning Glass Works, Telecommunications Products Div, Corning, NY 14831.

Circle No 351

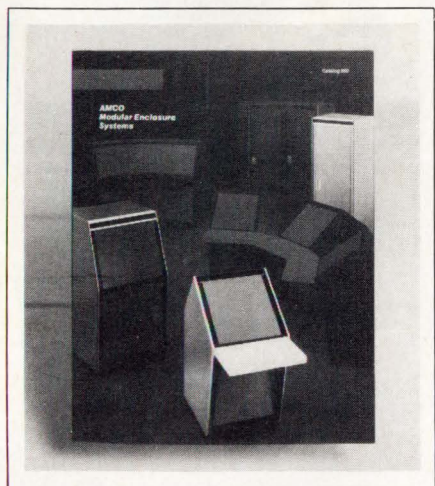

Catalog highlights enclosures, cabinets, and accessories

The Modular Enclosure Catalog 800 is a comprehensive pictorial and technical presentation of enclosures, cabinets, and accessories. This 118-pg document is divided into

three sections. The first section describes the company's styling system and the structural features of its modular consoles. The second section explains and illustrates how styling, structure, and component choices relate to the ordering process. The final section provides a 5-step ordering system that simplifies the sometimes complex process of designing and selecting enclosures. The catalog includes product photography, detailed illustrations, and pertinent technical data.

Amco Engineering Co, 3801 N Rose St, Schiller Park, IL 60176.

Circle No 352

Guide to LAN cable applications

This 8-pg LAN cable-application guide explains what a LAN is and how it's configured; it also gives details about IEEE standards 802.3, 802.4, and 802.5—computer communications standards adopted by the International Standards Organization (ISO). The 4-color brochure describes 28 different LAN cables, and it indicates whether the individual cables meet the requirements of the IEEE 802.3, the 802.4, or the 802.5 standard.

Belden Electronic Wire and Cable, Box 1980, Richmond, IN 47375.

Circle No 353

Flat-cable features

This 22-pg brochure describes the company's Tape Cable line of flat-flex cable. It includes specifications and performance ratings of cables used for signal or power in various applications: inside or outside cabinet; over or under carpet; and indoor or outdoor. The catalog has two major sections: a description section that covers the standard product line, and a technical reference section that contains a discussion of terminology, construction variations, and electrical parameters such as impedance and capaci-

tance. The tables provide descriptions of typical cable insulations, flat-wire sizes, and UL listings.

Brintec Corp, Brand-Rex Cable Systems Div, 1600 W Main St, Willimantic, CT 06226.

Circle No 354

Catalog of interconnection systems

Using photographs and illustrations, the 26-pg *Modular Components Catalog* highlights a line of connectors, adapters, telephone cables, data-switch boxes, baluns, and tools and accessories. It features a color-code chart, specifications, and one page of adapter applications.

Components Unlimited Inc, Interconnect Div, 11200 SW Allen Blvd, Suite A, Beaverton, OR 97005.

Circle No 355

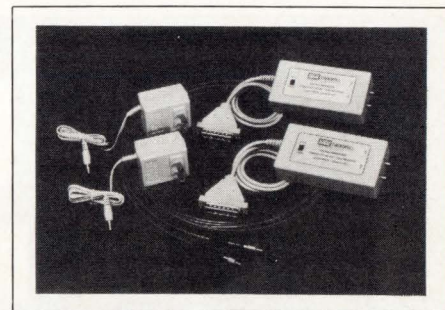

Brochure describes communications kit

This 4-pg full-color brochure describes a kit that contains complete fiber-optic RS-232C modem hardware (two modems, power sources, and 100 ft of twin fiber-optic cable with assembled connectors). Everything required for installation comes with the kit. The company claims that by following the clear, illustrated instructions in the brochure, you can install the hardware yourself. The brochure also provides component specifications and a parts list.

Augat Fiberoptics, 710 Narragansett Park Dr, Pawtucket, RI 02861.

Circle No 358

Power products guide

This 164-pg quick reference guide contains complete listings of ratings for all of the manufacturer's product lines, including isolated power modules, rectifiers, thyristors, transistors, triacs, and stack assemblies. Outline drawings provide dimensions for each product line. The guide makes it easier for you to order the right product for your application.

Powerex Inc, Hillis St, Youngwood, PA 15697.

Circle No 368

Brochure features dc/dc converters

A 12-page brochure describes the facilities and resources available from this manufacturer for custom dc/dc converters. It also provides general electrical parameters for custom open-card and rack-mount converters; six special and custom



products are showcased. Also included is a design form for specifying details of your electrical and mechanical requirements.

Computer Products Inc, Power Conversion Group, 2900 Gateway Dr, Pompano Beach, FL 33069.

Circle No 369

Guide details converters, supplies

This power-conversion design guide and catalog contains data on more than 90 dc/dc converters and 50 ac/dc encapsulated, modular power supplies. The 64-pg publication offers electrical and mechanical specifications, design curves, and prices for all products discussed; it devotes eight pages to application notes. The 3-hole-punched guide also contains pictures, dimensional drawings, and graphs.

Calex Mfg Co Inc, 3355 Vincent Rd, Pleasant Hill, CA 94523.

Circle No 370

Catalog details supplies, converters

This 34-pg catalog provides electrical and mechanical specifications and ordering information for the manufacturer's ac/dc switching supplies and dc/dc converters. The

Power in numbers.



power supplies range from 3 to 1000W, and the converters range from 1 to 150W. All products covered are available in 1-, 2-, and 3-output models and meet military specifications.

Computer Products Inc, Power Conversion Group, 2981 Gateway Dr, Pompano Beach, FL 33069.

Circle No 373

Stepper-motor brochure

This full-color, 6-pg brochure describes the Synchrostep's disk-rotor technology and how this technology compares with that used to manufacture conventional servo motors and hybrid step motors. The publication graphically illustrates the technology and explains how the step-to-step motion of the disk rotor works. The comparisons are highlighted by color charts that show acceleration, power loss, speed, and power-to-size and power-to-weight



ratios.

PMI Motion Technologies, 49 Mall Drive, Comack, NY 11725.

Circle No 371

Pamphlet introduces power-supply line

This 4-pg, 4-color brochure explains the power, safety, and flexibility

features of the remote-controllable DCR-T Series power supplies, which come in nine models from 0 to 8V dc to 0 to 600V dc at 16 to 900A. It details how these 3-phase 10-kW dc-regulated supplies are used for controlled test and burn-in applications.

Sorensen Co Inc, 5555 N Elston Ave, Chicago, IL 60630.

Circle No 372

Panasonic® Switching Power Supplies

And they're available now for immediate off-the-shelf delivery.

Just tell us what you need. Single or dual inputs. Up to four outputs. Outputs ranging from 5V to 24V. And 0.1 to 30.0 amps.

Of course, Panasonic switching power supplies meet the necessary safety approvals of UL, CSA and TUV plus noise specifications ratings from FCC Class A to VDE Class B.

So, now that you've got our number, get the rest of the story. Panasonic Industrial Company, Computer Components Division, One Panasonic Way, Secaucus, NJ 07094. (201) 392-4290.

Panasonic Industrial Company

CIRCLE NO 7

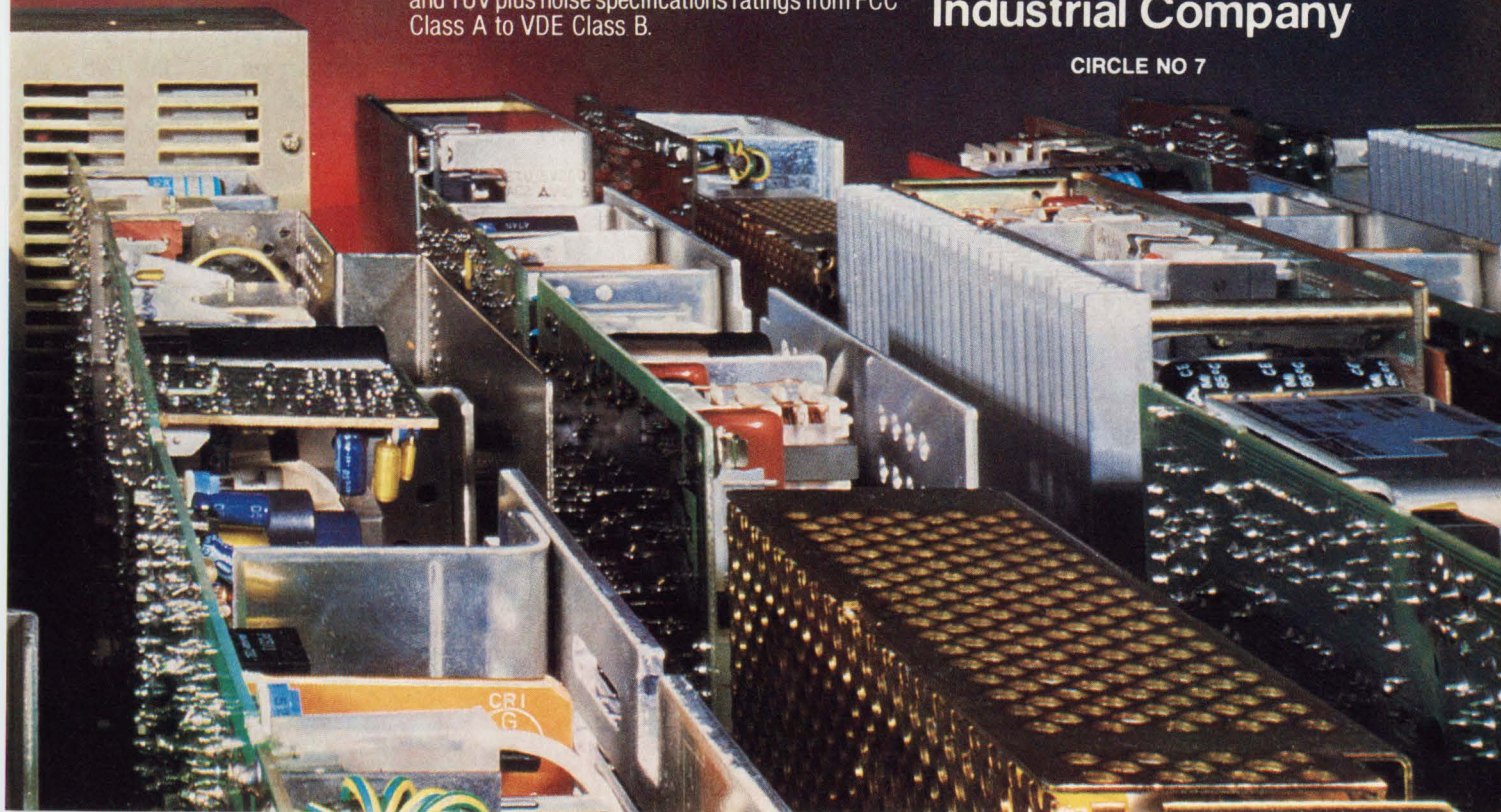

Expert systems directory

Knowledge Engineering Expert Systems Industry Source Book, a biannual publication, provides information (including the names and addresses of persons to contact) on suppliers of hardware (including general-purpose, Lisp, and Prolog machines) and suppliers of software (including operating systems, compilers/interpreters, expert-system shells, and development tools). It also lists suppliers of expert applications systems; university and government AI research programs; and AI training facilities, both academic and commercial. \$87.50.

Richmond Publishing Inc, Box 366, Village Station, New York, NY 10014.

INQUIRE DIRECT



Sourcebook features industrial PC software

The *Industrial PC Source Book 1987* offers an enlarged software supplement. The 96-pg book lists ruggedized IBM-compatible PCs and special-purpose plug-in expansion boards for process-control, data-acquisition, and CAE applications, and it also covers monitors, keyboards, and printers. The 32-pg software supplement provides a list of word processors; data-acquisition and analysis software, including the Labtech Notebook and its auxiliary

programs; statistical and mathematical programs; and bar-code reading and label-making programs. Other sections cover language compilers and interpreters, operating systems, and software-development tools and utilities. \$15.95; free to qualified users.

ICS Computer Products, Box 23058, Suite 208, San Diego, CA 92123.

INQUIRE DIRECT

Guide to Unix and C

A pocket reference for Unix and C, the *Text Processing Reference*, is a guide to all Unix word-processing tools and includes data on mm, macros and the tbl, eqn, nroff, and troff commands. The 32-pg booklet costs \$6. The company also offers several other pocket guides. Each *Unix Command Summary* (for System V, III, Xenix 5, and BSD 4.2) contains alphabetical condensations of the commands accessible by the Unix user. Each booklet includes editor and shell commands and costs \$6. The *VI Reference* summarizes Berkeley's visual editor and costs \$3. The *C Library Reference for Standard System V* details the library functions available to the C programmer using Unix; it costs \$6.

Specialized Systems Consultants Inc, Box 55549, Seattle, WA 98155.

INQUIRE DIRECT

Analog CAE brochure and videotape

Analog Design Tools is an 8-pg brochure that covers the Analog Workbench's use of simulated instruments such as oscilloscopes, spectrum and network analyzers, and the Spice Plus simulation software. (The Analog Workbench is a CAE system designed specifically for analog engineers.) The brochure also describes the 800-member general-device library, networking, and software options for power-supply design, statistical analysis and anal-

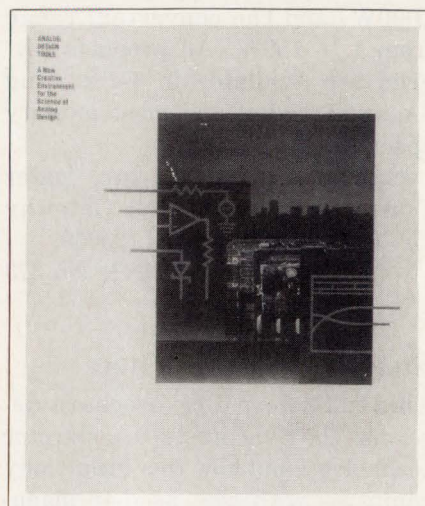

ysis of the safe operating areas of components, and parametric plotting. The vendor is also offering an 8-minute product demonstration tape in VHS format that covers the use of the CAE system. The brochure and the videotape are available directly from the vendor.

Analog Design Tools Inc, 66 Willow Place, Menlo Park, CA 94025.

INQUIRE DIRECT

Directory features software packages

Catalog 5953-9598 is a 208-pg directory of more than 1000 software packages, which are applicable to 20 market/application categories. All products discussed run on the HP 1000 and 9000 Series 80, 200, 300, and 500 computer families, as well as selected models of the HP Integral PC, the Portable PC, and the HP Vectra PC. Product listings fall into such categories as aerospace and aeronautical engineering, artificial intelligence, software engineering, languages/compilers, math/statistics, and computer-aided test/lab automation. Each entry includes supplier name, address, phone, and contact name; HP system environment (hardware series, model, and memory requirement); and price. The directory also includes company and product-name indexes.

Hewlett-Packard Co, 1820 Embarcadero Rd, Palo Alto, CA 94303.

Circle No 375

Book helps you implement DSP applications

This guidebook helps you implement digital-signal-processing applications when using the company's TMS320 product line, which supports high-speed and numeric-intensive DSP applications. The guide covers some of the common DSP routines, such as FFTs, and it discusses typical DSP applications in such areas as computers, peripherals, and telecommunications. Application-specific source codes are included. Request *Catalog SPRA012*.

Texas Instruments Inc, Semiconductor Group (SC-616), Box 809066, Dallas, TX 75380.

Circle No 359

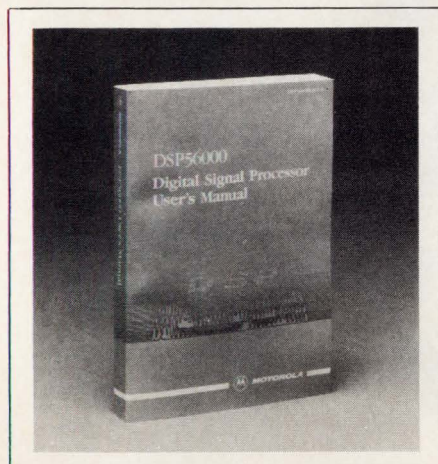

Manual for DSP

A DSP user's manual, *DSP56000-UM/AD*, and a condensed technical summary, *BR282*, help you understand the architecture of the DSP56000 DSP chip. The manual includes chapters on signal description, data organization and addressing modes, the instruction set, the I/O interface, exception processing, and chip operating modes. Appendices A and B cover instruction-set details and the chip's benchmarks, respectively. The manual costs \$8.65; the technical summary is free.

Motorola Inc, Literature Distribution Ctr, Box 20924, Phoenix, AZ 85036.

INQUIRE DIRECT

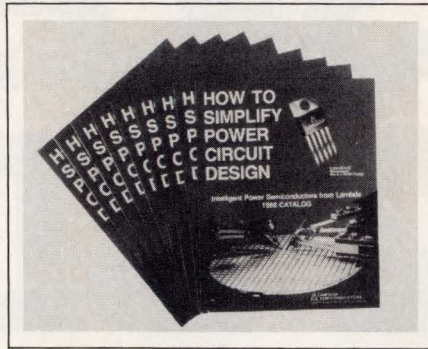

Catalog details semiconductors

How to Simplify Power Circuit Design is a 20-pg short-form directory to 160 of the company's standard power semiconductors, including PWM controllers, switching regulators, power drivers, power Darlingtons, half-bridge dual rectifiers, 0V protectors, and linear regulators. Ten other products listed include the LSH 6300 dc/dc microconverters and the LAS 8091P and 8071P 4-channel output drivers. It contains detailed specification charts, diagrams, and distribution pricing information on all semiconductors covered.

Lambda Semiconductors, 121 International Dr, Corpus Christi, TX 78410.

Circle No 360

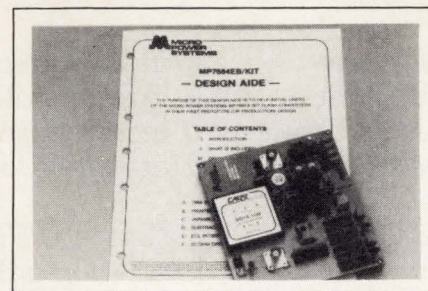

Guide aids in design of flash converter

MP768EB/Kit Design Aide assists engineers in the design, development, and test of a prototype 8-bit flash-converter system based on the MP7684. The kit contains the necessary data and pc-board layouts for building an evaluation board, including product description, schematic, assembly drawing, applica-

tions section, interfaces section, and parts list.

Micro Power Systems Inc, 3100 Alfred St, Santa Clara, CA 95054.

Circle No 361

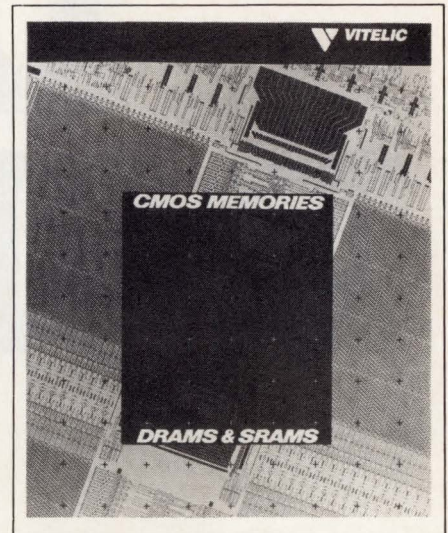

Catalog on static, dynamic RAMs

This catalog describes the specifications of the manufacturer's line of CMOS dynamic and static RAMs. The 98-pg document details 64k-, 256k-, and 1M-bit dynamic-RAM devices, as well as 8k-, 16k-, and 64k-bit static-RAM chips.

Vitellic Corp, 3910 N First St, San Jose, CA 95134.

Circle No 362

Data book details power transistors

The 990-pg *Power Transistors Data Book* contains selection guides and data-sheet information on a range of power transistors and Darlingtons, including devices with collector current ratings as high as 480A and devices with collector withstand voltages as high as 1200V. Additional sections provide cross-reference tables to industry-standard part numbers, information on the importance of various device parameters, and assistance with the selection of suitable devices for switch-mode power supplies, uninterruptible supplies, and motor drives. All in-

Continued on pg 168

33kHz 12-BIT DSP A/D's

MN6227/MN6228

12-Bit Sampling A/D's
Sampling Rate: 33kHz Minimum
Input Bandwidth: 16.5kHz Minimum
Testing: Frequency Domain (FFT)
Signal-to-Noise Ratio: 70dB Minimum
Harmonics: -80dB Minimum
Price: \$74/100's

You are looking at the *first* commercially-available, *FFT-tested*, high-speed, 12-bit, sampling A/D converters *specified* for digital-signal-processing applications. MN6227 and MN6228 are 33kHz A/D's with internal track-and-hold amplifiers. They are ideally suited for radar, sonar, spectrum and vibration analysis, voice and signature recognition, and other contemporary DSP applications. Unlike traditional successive-approximation A/D's without track-hold amplifiers,

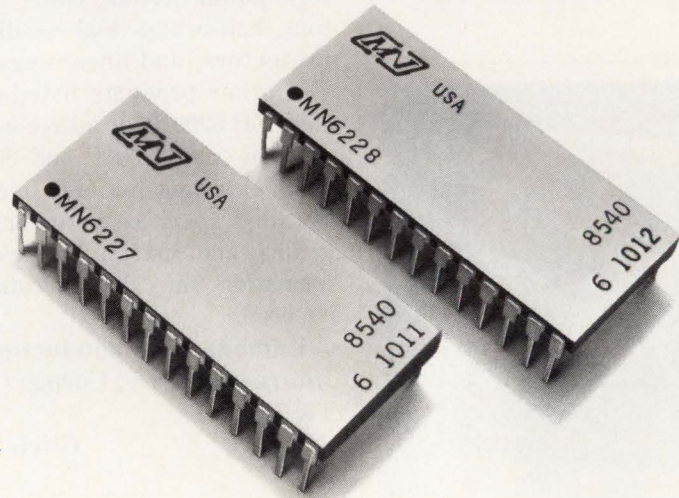

these true sampling A/D's maintain near-ideal signal-to-noise ratios independent of increasing analog input frequencies. They are *made* for the frequency domain.

Note the FFT spectra (right) and the data plot (top right). They clearly demonstrate the ability of these devices to maintain SNR with increasing input frequencies. In our frequency-domain testing, these devices operate in a manner that simulates a

digital spectrum analyzer with a known low-distortion input signal. The output spectra yield precise, practical measurements of signal level, noise level, signal-to-noise ratio, harmonic distortion, and input bandwidth... the keys to specifying for DSP applications.

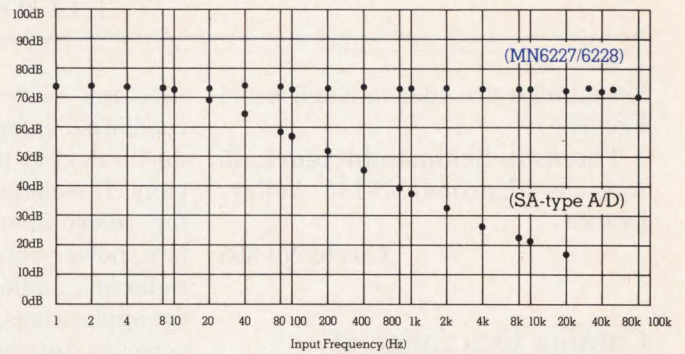
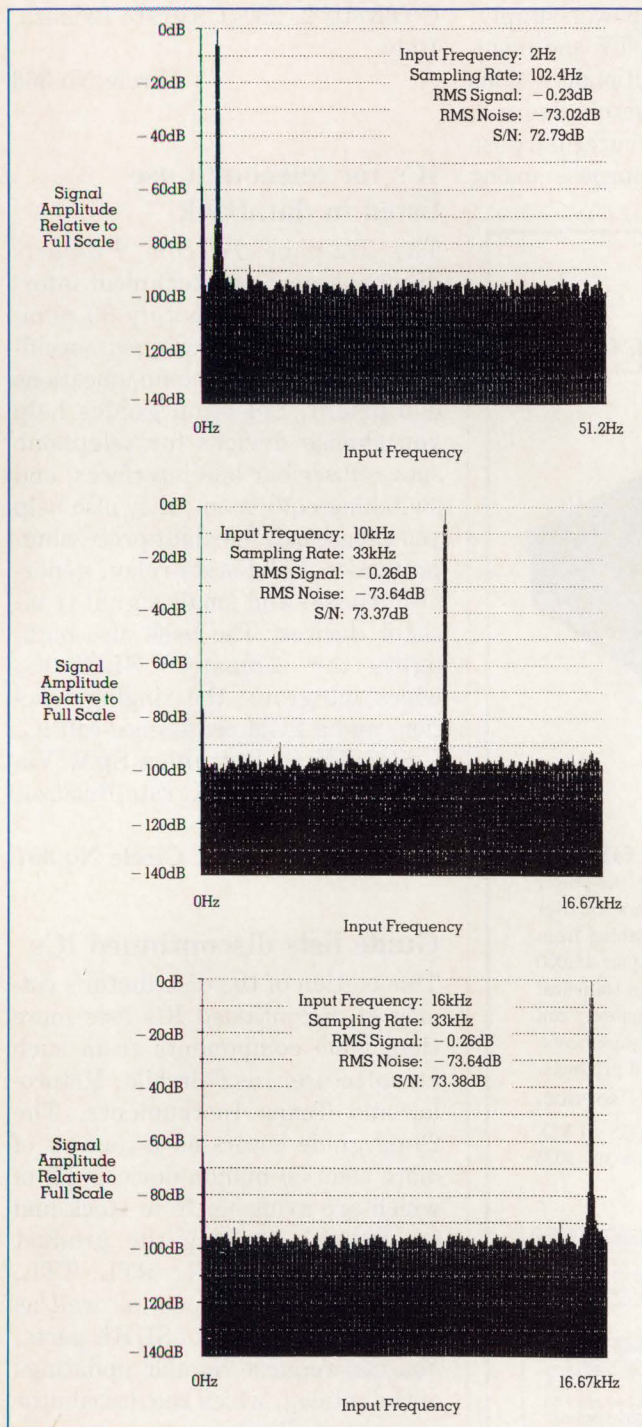

This plot of actual recorded data demonstrates MN6227/6228's ability to maintain near-ideal SNR with increasing input-signal frequency, while A/D's without companion track-holds show rapid (6dB/octave) SNR degradation.

MN6227/6228 are the first A/D's in our new MN6000 series. The 12 and 16-bit converters in this series all contain internal, user-transparent, track-hold amplifiers that enable each device to accurately sample and digitize dynamically changing input signals with frequency components up to the Nyquist frequency (one-half the sampling rate).

MN6227/6228 have a full 8 or 16-bit μ P interface and are packaged in small, low-profile, 28-pin ceramic DIP's, with the industry-standard MN574A pinout.

For detailed information on MN6227/6228, send for our comprehensive data sheet. For rapid response and a copy of our 384-page catalog of data conversion products, call Bob LeFort at (617) 852-5400, x297.

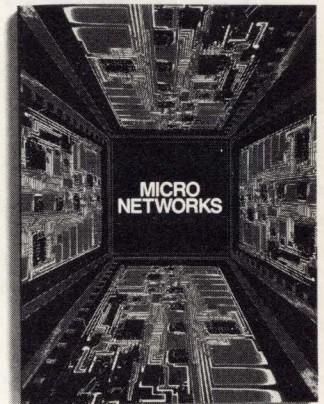

Micro Networks
324 Clark Street
Worcester, Massachusetts 01606
(617) 852-5400

Micro Networks
Advancing Data Conversion
Technology

Micro Networks
A DIVISION OF **UNITRODE** CORPORATION

formation is provided in English and French.

Thomson Semiconducteurs, 45 Ave de l'Europe, 78140 Velizy, France.

Circle No 365

Catalog lists range of semiconductor products

The 211-page *Semiconductor Prod-*

ucts and Systems catalog provides condensed information on semiconductor devices produced by the company. It includes sections on devices for telecommunications, automotive, power-control, power-supply, radio and audio, and TV and monitor applications. Additional sections cover custom/semicustom devices, VLSI devices, general-purpose transistors, general-purpose analog

and digital devices, 8- and 16-bit computer boards and systems, and military, hi-reliability, and surface-mount devices.

SGS Microelettronica SpA, Via C Olivetti 2, 20041 Agrate Brianza, Italy.

Circle No 366

ICs for telecomm use listed in databook

The 702-page *Telecom Products* databook contains technical information on approximately 90 semiconductor devices designed specifically for use in telecommunications equipment. Selection guides help you choose devices for telephone sets, subscriber line interfaces, and switching equipment; they also help you choose suitable data-processing, protection, solid-state-relay, general-purpose, and small-signal-transistor devices. The book also highlights the company's SLIC IC, which integrates the ringing function, and a PCM conference-call IC.

SGS Microelettronica SpA, Via C Olivetti 2, 20041 Agrate Brianza, Italy.

Circle No 367

Guide lists discontinued ICs

This edition of the distributor's catalog of discontinued ICs lists more than 3000 components from such manufacturers as Fairchild, Motorola, and Texas Instruments. The 20-pg guide covers an inventory of more than 50 million devices, all of which are available from stock and in quantity. Among the product types listed are DTL, RTL, TTL, 74H, and 54H devices, as well as Motorola's MECL and SUHL parts. You can request regular updatings of the catalog, which the distributor issues periodically.

Rochester Electronics, 10 Malcolm Hoyt Dr, Newburyport, MA 01950.

Circle No 363



SWITCHING POWER SUPPLIES

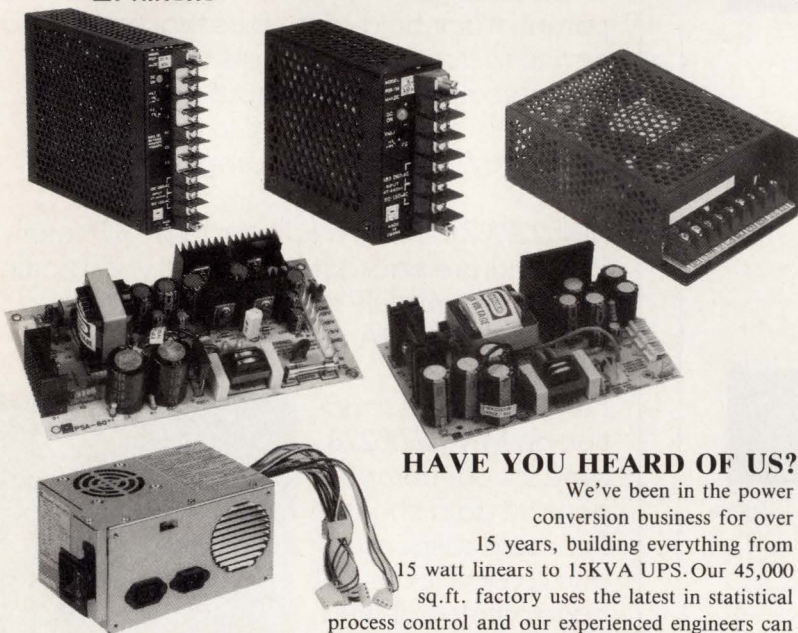

HAVE YOU HEARD OF US?

We've been in the power conversion business for over 15 years, building everything from 15 watt linears to 15KVA UPS. Our 45,000 sq.ft. factory uses the latest in statistical process control and our experienced engineers can provide you a design to meet your specific requirements. Here is a list of just a few of our standard products.

For factory direct sales + service.

Please contact **PHIHONG USA, INC.** 204 LOS GATOS BLVD. LOS GATOS, CA. 95030, TEL: (408) 395-9222, FAX: 408-395-3075

SINGLE OUTPUT

MODEL		+5V	+9V	+12V	+15V	+24V	MOUNTING	DIMENSION (INCH)
PSA-15 UL	15	3.0	1.7	1.3	1.0	0.7	L-BRACKET	3.87×3.81×1.37
PSA-25 UL	25	5.0	2.8	2.1	1.7	1.1	L-BRACKET	4.58×3.81×1.37
PSG-50 UL	50	10.0	5.6	4.2	3.4	2.1	L-BRACKET	6.37×4.03×2.00

TRIPLE OUTPUT

MODEL	O/P POWER	+5V	+12V	-12V	MOUNTING	DIMENSION (INCH)
PSA-513 UL/TUV	40	2.5	2.0	0.1	OPEN P.C.B.	6.30×3.94×1.77
PSA-523BU UL/CSA	50	5.0	2.5	0.5	BOXED	5.67×3.15×1.89
PSA-523TU UL/CSA	50	5.0	2.5	0.5	L-BRACKET	5.67×3.15×1.89
PSA-533 UL/CSA/TUV	60	5.0	2.5	0.5	OPEN P.C.B.	6.30×3.94×1.87

MULTIPLE OUTPUT

MODEL	O/P POWER	+5V	-5V	+12V	-12V	+12V	+24V	MOUNTING	DIMENSION IN
PSA-55-1 UL/CSA	60	6.0	0.7	3.0	0.7			OPEN P.C.B.	7.75×4.25×2.25
PSA-55-2 UL/CSA	60	6.0		0.7	0.7			OPEN P.C.B.	7.75×4.25×2.25
PSA-55-3 UL/CSA	60	6.0		3.0	0.7	1.5		OPEN P.C.B.	7.75×4.25×2.25
PSA-60-1 UL/CSA	70	6.0	0.7	3.5	0.7			OPEN P.C.B.	8.25×4.25×2.25
PSA-60-2 UL/CSA	70	6.0		0.7	0.7			OPEN P.C.B.	8.25×4.25×2.25
PSA-60-3 UL/CSA	70	6.0		3.0	0.6	1.5		OPEN P.C.B.	8.25×4.25×2.25
PSA-1354 UL/CSA	135	15	0.5	4.5	0.5			BOXED WITH FAN	7.35×4.70×3.90
PSA-1504 UL/CSA	150	15	0.5	5.7	0.5			BOXED WITH FAN	7.35×4.70×3.90
PSA-2004 UL/CSA	217	22.5	0.5	8.0	0.5			BOXED WITH FAN	8.34×5.90×5.90

Former engineers parlay technical expertise into new careers

Deborah Asbrand, *Staff Editor*

Little did Sidney Arnow know that when he accepted his first engineering job 24 years ago, he would embark on so divergent a career: He's worked at two electronics engineering companies, a consulting firm, two failed electronics businesses of his own, an unsuccessful partnership to sell auto-parts franchises, and, finally, as a sales-

man for and owner of US Technical Marketing (Kings Park, NY), a firm of manufacturers' sales representatives.

"The further away I got from engineering, the more I realized that it didn't suit me," says Arnow. "When I started in engineering . . . the last thing I ever wanted to do was go into sales. Like a lot of engineers, I thought salespeople were second-class citizens." Experience has changed Arnow's viewpoint dramatically. "I see no reason ever to retire," says the manufacturers' rep. "It's too good a business—and it's too much fun."

No figures are available on how many engineers leave the profession each year, but finding former engineers now engaged in other pursuits is relatively easy. Although individuals' reasons for leaving vary, most engineers base their decision on one of two factors: They decide that engineering itself is inappropriate for them, or they reach a point in their lives where they feel compelled to make a change. Their ties to electronic technology remain strong, however. Ex-engineers often continue to work with engineers in some capacity, or they work in areas like sales or marketing and, consequently, remain in touch with technological changes.

Arnow's job as a salesman representing five makers of microwave products gives him an opportunity to sell electronics products as well as work with engineers. Years of work within the Long Island, NY, engineering community has provided him with a vast network of friends and professional contacts there. "I used to work side by side with many of [my customers], so it's easy to work with them now. In five minutes, I understand exactly what their problems are."

But it took Arnow many years to discover that selling was a suitable—indeed an enjoyable—vocation for

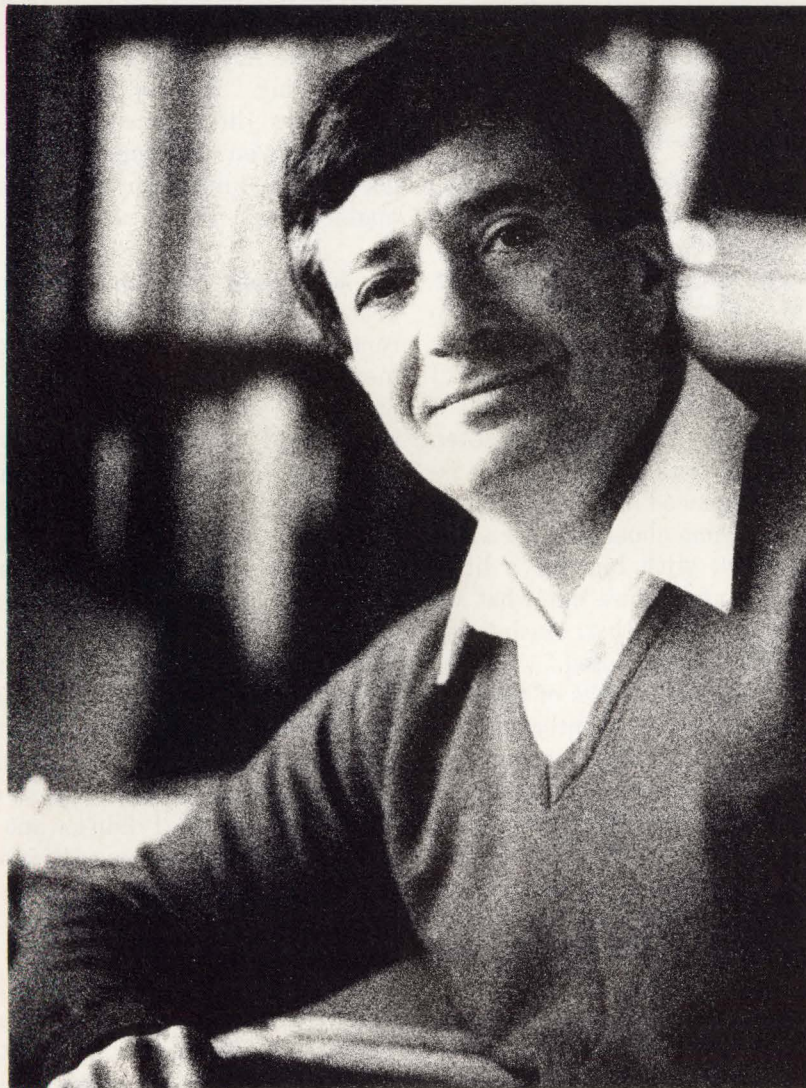

Joseph De Oliveira

Sidney Arnow, US Technical Marketing

"The further away I got from engineering, the more I realized it didn't suit me."

PROFESSIONAL ISSUES

him. His first move away from engineering came after nine years of work as a microwave and antenna engineer. In 1970, after working in industry jobs and then as a partner in an engineering consulting firm, he started his own business in space leased from a previous employer. The business, based on an idea for time-sharing the use of a mainframe that was accessed by telephone, was, Arnow concedes, a complete failure within six months. "We realized none of us knew what we were doing."

Soon after this failure, Arnow started a second business based on a colleague's idea for a device that could read a phonograph record with a beam of light. He and his associates submitted an unsolicited proposal to the Office of Naval Research and, to their surprise, received a \$14,000 grant to develop a prototype. Impressed by the prototype that the men later delivered, the naval office arranged publicity for it in more than 30 trade magazines; even *Business Week* magazine devoted a full page to the new company.

The publicity proved to be the fledgling business's undoing. Unknown to Arnow and the others, such companies as RCA, Zenith, and IBM had been working on similar projects. Alerted to the small company's efforts—developing what was actually a forerunner of today's compact disk stereos—representatives from the large companies flew to New York to talk with Arnow. "I shortly learned that you can't speak to specialists in even general terms without giving away your idea," he says.

The company began a decline because Arnow and his colleagues were unable to get additional government funding to continue the project, and, because, in Arnow's estimation, they lacked the business expertise required to negotiate a deal with the larger companies in order to finance the device's development. Finally, they ran out of

funds and were forced to fold the company.

Despite the uncertainty and failure of his first two businesses, Arnow was never tempted to return to the stable environment he had enjoyed when working for established engineering companies. "The fact that I was good technically actually had been an impediment to

"I get a lot of stimulation from interacting with people," says Ray Svenson. "An engineer has to get most of his stimulation from interacting with a product. There's nothing wrong with that, it's just not for me."

my progress because it kept me in engineering longer than I should have stayed."

Fed up with the electronics industry in general and work related to the military in particular, Arnow opted for a substantial change. "I always liked auto parts, and I looked up this man who owned seven retail auto-parts stores on Long Island. I convinced him that although I knew nothing about auto parts, if I could work with him for a little while, I could figure out what we could do for each other. Much to my amazement, he accepted."

After several months of working behind the stores' counters and in the warehouse, Arnow concluded that the owner could successfully franchise the business. But once Arnow wrote a sales contract and sold the first franchise for \$70,000, the stores' owner decided he no longer needed Arnow and ended their partnership.

"I went away not knowing what to do anymore," Arnow recalls. But shortly after, he answered a headhunter's ad for a regional sales manager for a microwave company. It

sued him perfectly: "It pulled together the technical knowledge and the sales, business, and people knowledge that I had accumulated." Three years later, in 1984, Arnow parlayed his sales experience into yet another venture: He founded the manufacturers' sales representative company that he still heads and that now sells products for a number of microwave companies in New York.

Retrospectively, Arnow reflects how different his career path might have been had his early years been more stimulating. He recalls one company he had worked at as a consultant where, he says, "the engineers had much fun—and autonomy—getting the job done." Had he been fortunate enough to work in a similar environment as a young engineer, he might have remained in engineering. "But my most formative years [in engineering] were spent in an environment that didn't show me the kind of fun there was in engineering."

Like Arnow, Ray Svenson's migration from engineering to his current job as a self-employed management consultant was a long, slow process away from work that never really held his interest. "I never made any radical changes; each time I changed jobs, I took one step away from what I had been doing," Svenson says. He began his career designing microwave radio relay systems for Bell Laboratories. It didn't take him long to discover that engineering was the wrong profession for him. "I made a fundamental decision early on that I didn't like working alone or in small groups on long-term projects. I didn't want to leave technology because it fascinated me, and it still does, but I didn't want to be involved with it at the design level."

Four years later, in 1966, he transferred to AT&T's headquarters, then located in New York City, and worked for the next few years providing technical support for field engineers. He then accepted a post

as manager of the company's Illinois training center. The center was responsible for training all of the Bell operating companies' engineers. "The whole area of training and development of the engineering work force became fascinating to me," says Svenson.

In 1978, he started his own business with little preparation: "I just quit and started making phone calls," he says. "The planning systems we had put into place at the training center were advanced compared with what I saw at other companies. I thought that there could be a market for me." The Bell operating companies became steady customers of his consulting service; in conjunction with AT&T, they remain 15 to 20% of his business today. Other customers include Shell, Amoco, and Exxon.

His company, RA Svenson and Associates, is located 25 miles outside of Chicago in Wheaton, IL, and employs eight people. Developing engineering training programs has allowed him to remain close to technology and use his experience as an engineer without working in a design job on long projects. "The work of the design engineer is inherently work that focuses on a 1- to 5-year project," Svenson says. "I get a lot of stimulation from interacting with people; a design engineer has to get most of his stimulation from interacting with a product. There's nothing wrong with that, it's just not for me."

Additional schooling is often an option and sometimes a necessity in changing careers. Former engineer Peter Giamalis is a partner in his own law firm, Sleizer and Giamalis, located in Palo Alto, CA, and specializes in legal help for small businesses. Giamalis says many of his clients are engineers who express relief when they find out his background. "When technical people see my engineering credentials, it helps break down a resistance they have to lawyers. They feel that it helps

me to better understand what they're trying to do."

Giamalis worked as a digital designer at RCA and Lockheed Missile and Space in the 1960s. As a computer-development engineer for IBM in 1970, he worked on what he calls "the best job of my life"—an advanced computer-system project led by Gene Amdahl, who after Amdahl Computers, later founded computer-maker Trilogy Ltd (Cupertino, CA). IBM eventually terminated the program, transferring Giamalis to its San Jose facility. Not long after that, the company offered him a management position. He declined the offer and began to consider other career options.

"There are a lot of reasons why I left, but I always sensed I wasn't an engineer's engineer," says Giamalis, who considers his undergraduate engineering degree a greater achievement than his law degree because the former was more difficult for him. "I had coworkers who were an engineer's dream, and I admired their natural ability." At a friend's suggestion, Giamalis took the law board exams. Having saved

\$15,000, enough to finance his tuition, he decided to enroll full-time in law school. "I was approaching 40 years of age," he says. "I'd seen other engineers trying to go to school nights, and once there was pressure on a project, they'd drop out of school. I knew this was my last hurrah."

The abrupt switch from engineering to law was difficult. "In my first year of law school, I kept trying to put things in flow charts," he recalls. "In engineering, you always know what variable is missing; in law, it's much more elusive." Since graduating in 1974, he has declined lucrative positions as a corporate staff attorney, preferring the autonomy of his own practice. "You can make a lot of money [as a staff attorney], but you give up a lot of integrity. I don't bill more than 11 hours per week; in a corporation you're supposed to bill 30 hours per week. I cherish my ability to be independent and take on cases where people might not have a lot of money to pay."

Despite his satisfaction with his practice and his decision to leave



Liane Enkelis

Ron Mercik, Gould Design and Test Systems Div

"If they asked me to go back to engineering now, I'd be very reluctant."

PROFESSIONAL ISSUES

engineering, Giamalis occasionally misses one aspect of his job at IBM: the ability to stay on top of technological changes. "I was involved in the forefront of computers at IBM. I feel badly that I don't know much about how the new personal computers work."

Much more concerned about leaving the technology with which he'd worked for 25 years was Ron Mercik, a 50-year-old engineer who recently accepted a marketing position with his employer, Gould Design and Test Systems Div in Cupertino, CA. After working on the design of Gould's new line of automatic test equipment, Mercik was asked to bring his technical expertise to the products' marketing phase.

"One of my major apprehensions was that I felt by working in marketing I'd get too far away from the technology," says Mercik, who made the switch last January. "I've found that not to be the case. I've stayed close to the technology. My basic skills haven't atrophied."

One reason Mercik is able to maintain his technical skills is that competition and sophistication in designs in the electronics industry have reached the point where a successful product introduction requires an increasingly high level of engineering expertise. Mercik's experience gives him a clear idea of what users' needs will be. "I look at what users are trying to do with our products, and by knowing what's going on technically, I can analyze their needs better. I can speak the engineers' language."

His presence in the marketing department has soothed the age-old conflict between engineers and marketers. "For a while, cooperation between engineering and marketing was not good," says Mercik. "That has changed radically since I moved into marketing. Engineers now feel comfortable talking with marketing people, and marketers use me as a conduit to engineering. They now

know when they're doing things that might not be accepted by engineering."

Mercik had disregarded coworkers' earlier suggestions that he

Ex-engineer Peter Giamalis recalls that in his first year in law school, he "kept trying to put things in flow charts. In engineering, you always know what variable is missing; in law, it's much more elusive."

might find marketing interesting. "I told them 'you're crazy, I'm basically an engineer,'" he recalls. To his surprise, however, learning marketing has been a challenge. "I've already made up my mind that I want to see this project through. If they asked me to go back to engineering now, I'd be very reluctant." He's also developed a better understanding of marketing's importance to a product's eventual success. "I've come to the conclusion that doing blind engineering is not the way to go. Unless it's a revolutionary change, marketing is absolutely necessary."

Engineers who have gone on to other professions are linked by their willingness to turn unfulfilling careers into jobs they find rewarding and their openness to the risks involved in trying something new. Arnow says that his early failures were discouraging, but a greater fear always compelled him to try again. "I was always more afraid of something else: I was afraid of coming to the end of my life and thinking what could've been if only I'd tried."

EDN

Article Interest Quotient
(Circle One)
High 518 Medium 519 Low 520

Be An Author!

When you write for EDN, you earn professional recognition. And you earn \$75 per published magazine page.

EDN publishes how-to design application information that is read by more than 137,000 electronics engineers and engineering managers worldwide. That's an audience that could belong to you.

If you have an appropriate article idea, please phone Eva Freeman, Associate Editor, at (617) 964-3030, or send a proposal and outline to her at 275 Washington Street, Newton, MA 02158 - 1630. For a FREE EDN Writer's Guide—which includes tips on how to write for EDN and other technical publications—please circle number 800 on the Information Retrieval Service Card.

EDN

First in Readership
among Design Engineers
and Engineering Managers
in Electronics

CAREER OPPORTUNITIES

YOUR INVOLVEMENT. YOUR PRODUCTS.

At MPC Products, engineers handle the full scope of projects for the military and commercial aircraft and aerospace industries. From start-up through customer delivery, our small teams of engineers are creating the premier products on which we stake our reputation. With sales now reaching an unprecedented high, we seek additional engineers for our expanding Motor Design area.

PRODUCT ENGINEER — A.C. MOTORS

Responsibilities will involve motor design, production support, and troubleshooting as challenges arise. We're looking for an individual with a BSEE and a background in A.C. circuits. Coursework in electromechanical devices would be beneficial.

D.C. MOTOR ENGINEER

Responsibilities involve design, material selection, assembly and test procedures, with special concentration on DC (Brush Type) motors, motor tachometers, and motor brakes. You will also provide follow-up support through manufacturing cycle as customer requirements are met. A BSME/EE or technical degree is required, along with knowledge of DC Motors and familiarity with brush materials, commutation techniques, winding/armature design, and magnetics. Knowledge of MIL-M-8609 is an asset.

For true engineering challenge in custom-designed precision components, it's MPC Products. Find out more by sending your resume to: **MPC Products Corp., Professional Staffing, Dept. CN, 7426 N. Linder Ave., Skokie, IL 60077.** Equal Opportunity Employer m/f/h/v.



1987 Editorial Calendar and Planning Guide

EDN

Issue Date	Recruitment Deadline	Editorial Emphasis	EDN News
Jan. 8	Dec. 16	Memory Technology; Test & Measurement; Top Ten Reader Vote Contest	
Jan. 22	Dec. 31	Military Electronics; ICs & Semiconductors; Communications Technology	Closing: Jan. 8 Mailing: Jan. 29
Feb. 5	Jan. 15	Test & Measurement; Communications Technology; Software	
Feb. 19	Jan. 29	Analog ICs; Artificial Intelligence; CAE	Closing: Feb. 4 Mailing: Feb. 20
Mar. 4	Feb. 12	Computer Graphics; Communications ICs; Test & Measurement	
Mar. 18	Feb. 26	CAE; ASICs; Electro '87; Show & Product Preview	Closing: Feb. 18 Mailing: Mar. 16
Mar. 31	Mar. 10	Electro '87 Show Issue; Design & Development Tools; ICs & Semiconductors	
Apr. 15	Mar. 26	Microprocessor Technology; Software Development; Digital ICs	Closing: Mar. 19 Mailing: Apr. 9
Apr. 30	Apr. 9	Communications Special Issue; ASICs; Test & Measurement	Closing: Apr. 2 Mailing: Apr. 23
May 14	Apr. 23	Analog Technology Special Issue; ICs; Test & Measurement	Closing: Apr. 16 Mailing: May 7

Call today for information.

East Coast Janet O. Penn (201) 228-8610
West Coast Dan Brink (714) 851-9422
National Roberta Renard (201) 228-8602

MICROWAVE DESIGN ENGINEER

Future technologies begin with the ingenuity of today's finest engineers. California Eastern Labs (CEL) has a strong commitment to that future *right now* through its MMIC program. Combine our commitment with your creative ingenuity and experience to form a winning combination.

We are currently looking for a Microwave Design Engineer to design GaAs MMICs for production by one of the world's largest semiconductor manufacturers. Requires 5 years minimum experience in the design of active microwave circuits. Direct experience in MMIC design and the ability to speak Japanese are preferred qualifications for this unique opportunity. Full company paid benefits. Salary commensurate with experience. Principals only.

Send resume to:
CALIFORNIA EASTERN LABS
3260 Jay Street
Santa Clara, CA 95054

EOE M/F

NATIONAL OPENINGS TECHNICAL WRITERS PUBLICATIONS ENGS

COMMERCIAL

Hardware: • 1+ yr exp writing maint and/or install manuals for digital computer systems to 34K
• exp. in design or electronic repair & a desire to work as a Tech. Writer to 38K
Software: • exp writing program & operating systems manuals to 43K
• exp writing manuals for financial or banking applications to 38K

GOVERNMENT SYSTEMS

Enging Writer: • exp writing manuals, test procedures or component documents for elec warfare or common systems to 38K
Avionics Writer: • respon for writing aircraft systems documentation to mil specs & standards to 37K
Software: • exp. writing SW development & production specs; FORTRAN, ADA, assembler to 40K
Supervisor: • supv group writing aircraft systems documents to 42K
Manager: • manage full pubs function from writing to production; Top Secret with TSSI & EBI clearance a plus to 50K

Please call Michael Dunn (collect) at 215-667-7700, or send resume:



Judge Inc.
Two Bala Plaza
Suite PL15
Bala Cynwyd, PA 19004

All positions direct career opportunities with all fees and interviewing expenses paid by client companies.

WINCHESTER DISK DEVELOPMENT AND TEST ENGINEERING

NEC Information Systems, Inc., one of the fastest growing computer companies in the U.S., is commencing disk hardware design capability and disk manufacturing/repair capability for 3.5-inch to 9-inch Winchester disk drives at its Boxborough, Massachusetts headquarters.

As a result, and for a limited time, we are offering career opportunities in a start-up environment that will include the opportunity to study Japanese design and manufacturing concepts firsthand. You will have the opportunity to create a superior disk product locally with the assurance of Japanese-proven product capability, production know-how, and technical support as resources. (All of these positions – with the exception of Senior Components Engineer – require international travel for training)

DISK ENGINEERING MANAGER

You will have primary responsibility for the transfer of disk technology for development, repair and subsequent production from NEC Tokyo to NECIS, and will direct the technical efforts of NECIS disk engineering and support personnel, including controller development engineers, test engineers, production and repair technicians.

Requirements include:

- MS degree with 8-10 years of technical experience, or BS degree with 11-13 years of technical experience
- Hands-on disk design experience required in both hardware and firmware
- 5-6 years of technical and management experience required; start-up experience helpful

SENIOR ELECTRONIC ENGINEERS (2)

You will specialize in the design of control processing necessary to adapt SMD and IPI-2 style interfaces to various host systems. Skills required include a thorough understanding of firmware control routines, and in-depth microprocessor design, utilizing the latest techniques in circuit design and creation. A full understanding of VLSI circuit and logic design is preferred.

Requirements include:

- BSEE with 5-8 years of electronic design experience or MSEE with 4-6 years of electronic design experience
- Knowledge of a variety of interfaces, including SCSI, SMD IPI-2 and ESDI
- Knowledge of microprocessors and peripheral controller chip sets

SENIOR TEST ENGINEERS (2)

You will be supporting the start-up of local repair and production and OEM customization of either 3 1/2" and 5 1/4", or 8" and 9" Winchester disk drives by providing manufacturing operations with the appropriate test and rework procedures, to include the selection of appropriate tests and their interpretation.

You should have:

- BS degree with 5-8 years of experience in electronic design or MS degree with 4-6 years of experience, or equivalent
- A broad understanding of digital and analog circuitry and firmware as they relate to disk systems
- Extensive experience in various testing procedures and equipment

SENIOR MANUFACTURING ENGINEER

You will be responsible for developing manufacturing procedures, in support of both the manufacture and repair of Winchester disk drives, including the development and design of process and workstation layouts. You will also provide ongoing mechanical floor support.

Requirements include:

- BS degree with 5-8 years' experience, or MS degree with 4-6 years' experience, or equivalent
- Previous experience in the development of start-up manufacturing processes; experience in disk drive environment a plus
- Experience in clean room processes and practices

SENIOR COMPONENTS ENGINEER

You will be responsible for developing component specifications as required for the local procurement of 9-inch Winchester Disk Drives. This will include the development of primary and secondary vendor sources, and ongoing vendor interface to ensure conformance to specifications.

To qualify, you should have:

- BSME degree with 5-8 years of experience or an MS degree with 4-6 years of experience, or equivalent
- Prior experience in both plastics and sheet metal
- Previous experience in vendor sourcing and converting vendor standards from international to ANSI Standards

If you are qualified and interested in any of the above positions, please stop by to fill out an application, or forward your resume immediately to: Joyce M. Gorgoglione, Employee Relations Representative, NEC Information Systems, Inc., 1414 Massachusetts Avenue, Boxborough, MA 01719.

NEC

NEC Information Systems, Inc.

A Committed Equal Opportunity Employer M/F/H/V.

SIEMENS

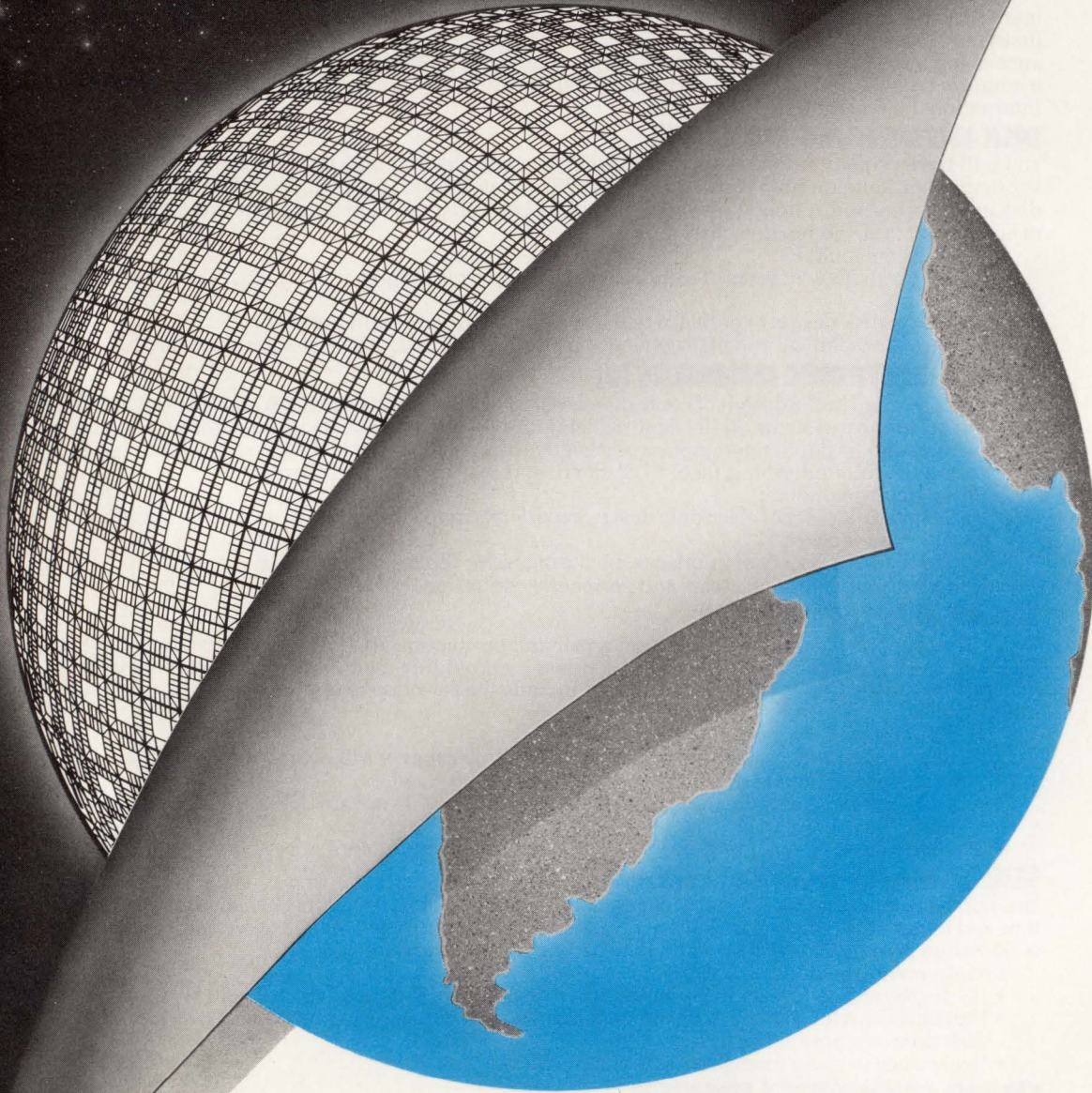

We're worldwide. We're long established. We're in Santa Clara.

We're Siemens. Pushing back barriers in the semiconductor industry to open up a new world of opportunity for progressive, risk-taking professionals.

An innovator known the world over for nearly 140 years, we're making a tremendous investment in the future as we move Siemens' Semiconductor Group to Santa Clara. The environment, the resources and the commitment are virtually unparalleled. And you can be a part of this dynamic environment in one of these select positions.

ASIC ECL CIRCUIT DESIGNERS

Requirements include a minimum of 3 years ECL circuit design experience; SPICE, gate array experience highly preferred. BS/MSEE or equivalent. Will perform core and I/O design of ECL master slices and macro libraries.

VLSI CHIP ARCHITECT

Requires 3+ years of experience involving the architecture, hardware and software design of digital networks or data communications products; DSP experience preferred. Will define and develop VLSI chip specifications, HW/FW/SW architecture, and top down logic designs for data communications ICs.

SMART POWER MOS IC DESIGNERS

These positions require a minimum of 2+ years experience involving transistor level MOS IC design and a working knowledge of CAE/CAD design tools. A BSEE/MSEE or equivalent and power MOS design experience required.

VLSI SYSTEMS/LOGIC ENGINEERS

Requires 3+ years' experience in VLSI architecture, logic and simulation for LAN products. Strong CAE/programming skills necessary.

TELECOM APPLICATION ENGINEER

In this position, you will recommend new products in the telecom area, develop and present technical seminars on ICs for telecom applications, and interface with the customers to determine acceptable technical specifications. The skilled communicator we seek will have a BSEE or equivalent and 5 years of experience that includes knowledge of A/D and D/A converter principles and all levels of communication protocols.

PRODUCT MARKETING ENGINEERS

TELECOM • MICROPROCESSOR/MICROCONTROLLER

Requirements for positions within these two product areas include a BSEE or the equivalent and 2 to 4 years of related component IC marketing experience. You will assume responsibility for maintaining present IC accounts and developing new customers. You will be involved in presentations and seminars for customers, reporting of competitive analysis, new product ideas, and interaction with engineering.

PRODUCT MARKETING DISTRIBUTION

INTEGRATED CIRCUITS

Requirements include a strong marketing/distribution background with at least 3 to 5 years' experience in the semiconductor industry. Bachelor's degree in Business or Marketing required; BSEE preferred. Responsibilities include: establishing and authorizing competitive distribution costs for franchised distributors; recommending, implementing and monitoring distributor inventories; interfacing with members of both the marketing and distribution team as well as customers.

SR. PRODUCT MARKETING ENGINEER

ECL and CMOS SEMI-CUSTOM

Requirements include 3 to 5 years of experience in an ECL or CMOS semi-custom environment with prior background in IC/logic/systems design. You will assume responsibility for maintaining present IC accounts and developing new customers. You will be involved in presentations and seminars for customers, reporting of competitive analysis, new product ideas, and interaction with engineering.

We offer responsive management, competitive compensation and performance incentives, extensive benefits and excellent potential for professional recognition and growth. For immediate consideration, send resume indicating position of interest to: Professional Staffing, Siemens Components, Inc., Semiconductor Group, Dept. EDN, 19000 Homestead Road, Cupertino, CA 95014. We are an equal opportunity employer. PRINCIPALS ONLY PLEASE.

Siemens. A world leader in semiconductor technology.

ADVERTISERS INDEX

ACCEL Technologies Inc	157	Panasonic Industrial Co*	162-163
Adaptec Inc	26-27	Personal CAD Systems Inc	C2
Advanced Microcomputer Systems Inc	158	Phihong Enterprise Co Ltd	168
Advanced Micro Systems Inc	158	Philips Elcoma Div**	8-9, 40
Applied Microsystems Corp	10-11	Philips Test & Measuring Instruments Inc	105
Arium Corp	93	Philips Test & Measuring Instruments Inc**	33
AT&T Technologies	151	Pittman	32
Bliley Electric Co	153	Pro-Log Corp	4
Bowmar/White Technology	71	Qua Tech Inc	158
BP Microsystems	158	Robinson-Halpern	159
Bruning Computer Graphics	97	Samtec Inc	132
Bubble-Tec	75	SBE Inc	54-55
Cahners Exposition Group	123	Shelly Associates	159
Capitol Equipment Corp	158	Siecor Corp	12-13
Cherry Electrical Products Inc	20	Softaid Inc	21
Chomerics Inc	135	Stanford Research Systems Inc	106
C&K/Unimax	142	Stantel Components Inc	131
Clearprint	91	Step Control Ltd	159
Comair Rotron Inc	139	Strawberry Tree Computers	159
Comlinear Corp	147	Sunrise Electronics Inc	22
Communications Research Group	157	Tadiran Electronic Industries Inc	C3
Comp Control Inc	79	TEAC Corp**	33
Computer Modules Inc	160	Tektronix Inc	24-25, 51-52, 53
Computer Parts Mart	157	Teledyne Relays	140
Crystek Microelectronics	160	Teledyne Solid State Products	159
Cybernetic Micro Systems	148, 159	Teltone Corp	160
Data Display Products	141	Tokin Corp	137
Data I/O Corp	C4	Toshiba Corp	156
Delevan Div, API	144	Trend Circuits	81
Densitron Corp	157	Triplett/Penril	108
Digitran/Div of XCEL Corp	141, 143, 145	TRWLSI Products Div	15
Du Pont Riston Products Div	36-37	Uppermost Electronics Industries Co Ltd	158
Electronic Solutions	39	Valid Logic Systems Inc	88
Emulex Corp	65	Vesta Technology Inc	160
Endicott Research Group Inc	154	Visionics Corp	95, 160
E-TA Circuit Breakers	160	VME Microsystems International Corp	56
Fujitsu America Inc/Storage Products	66-67	VME Specialists	159
GR Electronics	21	Wavetek San Diego Inc	3
Grayhill Inc	148	WinSystems Inc	158
Hewlett-Packard Co	58	Wintek Corp	159
Hitachi America Ltd*	8-9, 40		
Hitachi Metals Ltd	28-29		
ICI America Inc	31		
International Manufacturing Service	157		
International Microsystems	30		
Introl Corp	160		
John Fluke Manufacturing Co Inc	6		
Kepco Inc	117-120		
Live Wire Software	160		
Lockheed Electronics/Environmental Test Labs	138		
Logical Devices Inc	158		
Logical Systems Corp	158		
Matrox Electronic Systems Ltd	69		
Matsuo Electronics	32		
Maxim Integrated Products	23		
Measurement Systems Inc	30		
Medinova Corp	158		
MetaLink Corp	103		
Micro Networks	166-167		
Micro Switch*	129		
Mini-Circuits Laboratories	18-19, 180		
Modutec Inc	121		
National Instruments	113		
NEC Electronics Europe**	129		
Nicolet Test Instruments Division	17		
OKI Semiconductor	34		
Omaton Inc	159		
Omron Electronics Inc*	33		
OrCAD Systems Corp	87		

Recruitment Advertising

California Eastern Labs	174
Judge Inc	174
MPC	174
NEC Information Systems	175
Siemens	176-177

*Advertiser in US edition

**Advertiser in International edition

This index is provided as an additional service. The publisher does not assume any liability for errors or omissions.

REACT!!!

LETS YOU RETRIEVE DETAILED PRODUCT INFORMATION IN AN INSTANT!

EDN and EDN News offer you the fastest system ever to retrieve additional product information from an advertiser.

It's called REACT, for Cahners Reader Action Service. And it allows you to receive in minutes what used to take weeks.

All you do is look for the toll-free REACT phone number appearing in ads in EDN and EDN News. Then call the number from your modem-equipped personal computer or terminal.

You'll be shown product descriptions, price lists, and technical specifications right on your computer screen. Plus you can access this data 24 hours a day, seven days a week for up to 15 minutes without charge.

REACT enables you to respond to an advertising message after reading it and to receive the additional information you want *immediately*.

The next time you see an ad that interests you, all you have to do is REACT.

CAHNERS

READER ACTION

LOOKING AHEAD

EDITED BY GEORGE STUBBS

PROJECTED WORLDWIDE SHIPMENTS OF OPTICAL DISK DRIVES (THOUSANDS OF UNITS)

	1985	1986	1987	1988	1989	1990	1991
READ-ONLY	9.3	38.0	90.8	165.2	252.2	344.9	442.4
WRITE-ONCE	4.9	27.6	69.6	122.5	193.2	264.0	345.0
ERASABLE	—	—	0.3	10.0	51.0	135.2	260.7
TOTAL DRIVES	14.2	65.6	160.7	297.7	496.4	744.1	1048.1
GROWTH FROM PREVIOUS YEAR	1741%	363%	145%	85%	67%	50%	41%

(SOURCE: FREEMAN ASSOCIATES INC)

Optical-disk-drive market to reach \$2 billion by 1991

Between now and 1991, optical data storage will show unmistakable signs of coming into its own. According to Freeman Associates Inc, a management-consulting company based in Santa Barbara, CA, the worldwide market for optical disk drives will top \$2 billion in 1991, marking an 81% compounded growth rate from 1985's \$57 million market. In 1991, annual shipments of drives will exceed 1 million units for the first time.

The breakdown of projected 1991 unit shipments is as follows: 442,000 read-only drives (42% of total market), 345,000 write-once units (33%), and 260,000 erasable devices (25%). Revenues for the different market segments won't match the distribution of shipments. Read-only drives, dominated by drives for CD ROMs, will raise \$174 million, about 9% of the total revenue. Write-once drives will generate the most revenue—\$1.5 billion, or 74% of the market. The remaining 17% share goes to erasable drives at \$347 million.

Ninety-five percent of all read-only drives will be CD-ROM drives. Japanese companies and Philips of The Netherlands will continue to dominate in the production of

CD-ROM drives, thanks to their experience in manufacturing compact audio disk drives. According to Freeman Associates, no US manufacturer will enter the CD-ROM drive business. US commercial interests in CD ROMs will be extensive, but limited to involvement in electronic publishing, systems integration, and disk production.

The eagerly awaited erasable drives will make their appearance in 1987, says Freeman Associates, and that market segment will quickly grow in volume. Virtually all erasable drives during the period forecast will have capacities below 1G byte. Drives with large capacities will enter the market in 1990 as specialized mainframe devices. Erasable drives will overtake read-only drives in revenue in 1990 and will double the dollar volume of read-only drives in 1991.

Communications equipment to show increased use of ICs

The merging of computer power with communications functions will give rise to an increasing use of ICs in the manufacture of communications equipment, predicts Gnostic Concepts Inc, a San Mateo, CA-based research and consulting firm.

US manufacturers of communications equipment purchased \$2.4 billion worth of ICs in 1985, and they are expected to increase the rate of purchase at an annual rate of 19.8%, to \$6 billion in 1990. Gnostic Concepts projects that the IC content in communications equipment will rise from 11% in 1985 to 15% in 1990.

Several trends in the communications industry mark avenues of significant opportunity for IC makers. The public switched-telephone network and other wide-area networks are slowly but surely moving from analog to digital, with a consequent demand for new types of transmission equipment to replace the old systems. Traditional boundaries between types of communications equipment are blurring: Modem, multiplexer, and network-control functions are merging in single systems; digital PBXs are handling voice and data as they vie for local-area networking solutions; and even terminals are combining the capability to transmit voice, text, and data.

An additional spur to the development of communications ICs is development on the software side. Sophisticated packages, for switching large amounts of traffic and handling a wide array of protocols, are beginning to dominate communications-equipment design and will have a significant impact on future IC requirements, reports Ed Pullen, program manager of the Gnostic Concepts study.

As always, with opportunity comes uncertainty and peril. AT&T's divestiture and deregulation of the US telecomm industry have created a confusing array of distribution channels and competitive relationships. What's more, says Pullen, the communications industry is replete with equipment manufacturers and overlapping product lines; a shakeout is likely, leaving a few large, integrated manufacturers and a number of subsystem suppliers.

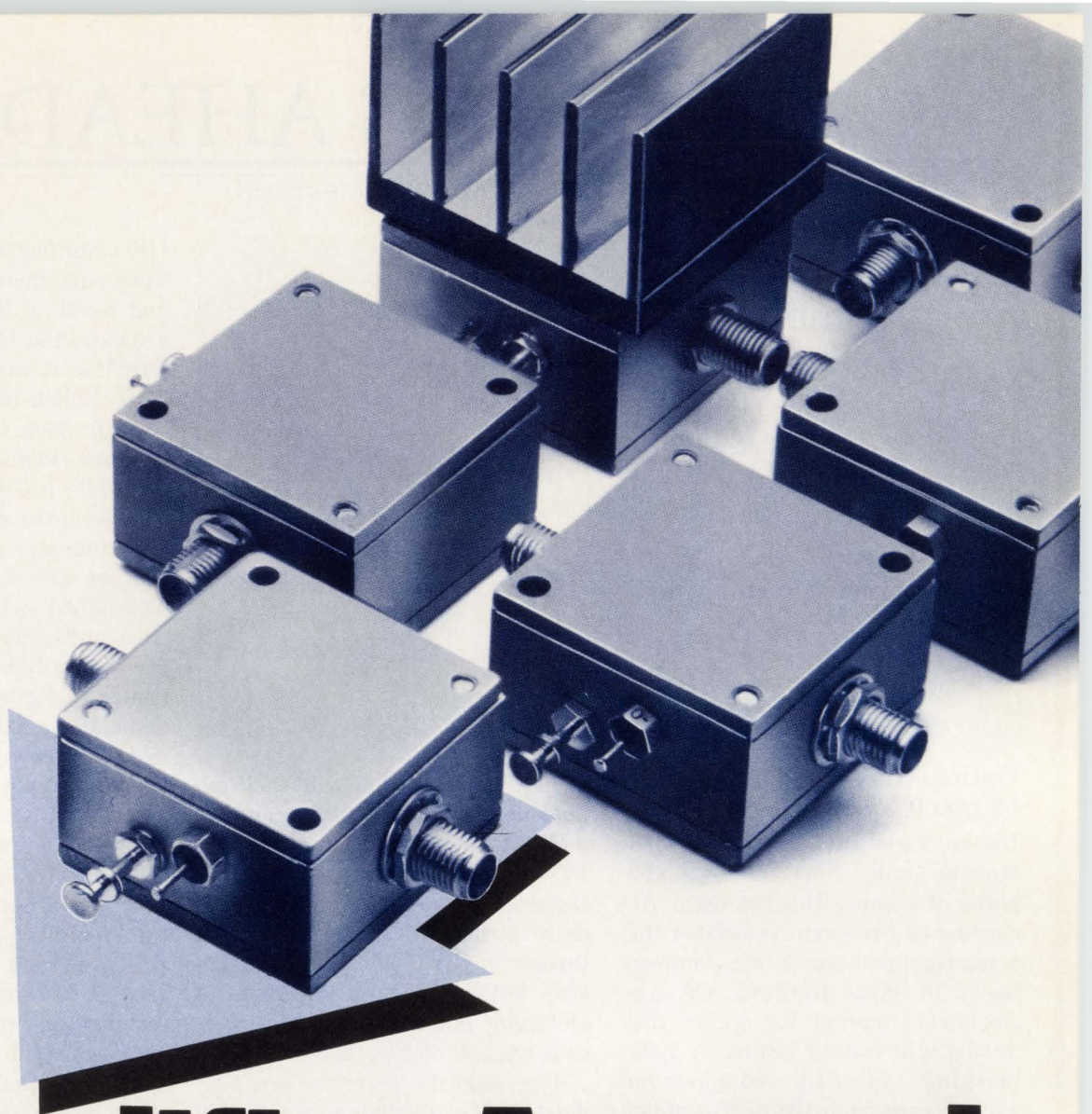

Amplifier Arsenal

50KHz to 2000MHz, 100mW output Gain Controlled From **\$69.95**

Our ZFL-2000 miniature wideband amplifier hit a bulls-eye when we introduced it last year. Now we've added more models to offer you a competitive edge in the continuing battle for systems improvement.

The ZFL-2000, flat from 10 to 2000MHz, delivers +17 dBm output and is still priced at only \$219.

Need more output? Our ZFL-1000H, flat from 10 to 1000MHz, delivers +20 dBm output.

Variable gain important? Our ZFL-1000G, flat from 10 to 1000MHz, delivers +3 dBm output with 30 dB gain control while maintaining constant input/output impedance.

Searching for a high-quality, low-cost amplifier? Our ZFL-500 flat from 50KHz to 500MHz, delivers 10 dBm output for the unbelievably low price of only \$69.

One week delivery... one year guarantee.

Gain the competitive edge... specify Mini-Circuits RF/IF signal-processing components.

SPECIFICATIONS

Model No.	ZFL-500	ZFL-1000G	ZFL-2000	ZFL-1000H
Freq (MHz)	0.05-500	10-1000	10-2000	10-1000
Gain (dB), Min.	20	17	20	28
Gain Flatness (dB) Max.	±1.0	±1.5	±1.5	±1.0
Max. Power (dBm) (1dB compression)	+10	+3	+17*	+20
NF (dB) typ.	5.3	12.0	7.0	5.0
3rd order Intercept pt (dBm)	+18	+13	+25	+33
Current at 15V dc	80mA	90mA	100mA	150mA
Price \$	69.95	199	219	219
qty.	1-24	1-9	1-9	1-9

For complete specs on these and our 1- and 2-W models refer to 1985-86 Gold Book or Microwaves directory.

*+15 dBm below 1000MHz

finding new ways ...
setting higher standards

Mini-Circuits

A Division of Scientific Components Corporation
P.O. Box 166, Brooklyn, New York 11235 (718) 934-4500
Domestic and International Telexes: 6852844 or 620156

C101 REV. B



**More than
meets the eye**

- In full production of standard and custom-made hybrids for telecommunications, military and industrial use.
 - Total in-house automated capability using a variety of technologies.
 - Bonding by chip and wire or reflow solder with quality assurance to meet customer's specification.
 - Turn-around is fast and furious with product reliability a matter of record.
- More than meets the eye...
Much more.**



TADIRAN
ELECTRONIC INDUSTRIES Inc.

40 Seaview Blvd., Port Washington, NY 11050, U.S.A. Tel. 516-621-4980, 800-367-6859

Lakeland Plaza, Suite 263 Lewisville, TX 75067, U.S.A. Telephone: 214-221-7523 800-367-9130

6312 Variel Ave., Suite 203, Woodland Hills, CA 91367, U.S.A. Telephone: 818-884-3884, 800-882-3882 TLX W.U. 705384

CIRCLE NO 86



WE SUPPORT OUR PRODUCTS FOR LIFE.

OUR SERVICE MAKES A WORLD OF DIFFERENCE. You come to Data I/O[®] Corporation for products of the highest quality and performance. We help you maintain that quality with complete customer support. Once you've seen the difference our service can make, you'll understand why we keep our customers for life.

From updates, to repairs, to training and technical assistance, we'll help you get the most from our products. Our Customer Support Services can extend the life of your Data I/O programmer or FutureNet[®] CAE workstation, and keep you on the leading edge of technology.

WORLDWIDE SUPPORT FOR MINIMAL DOWNTIME. For prompt, reliable service and repairs, we have service centers located throughout the world. You can expect fast turnaround from our team of skilled technicians — as fast as 24 hours. For added convenience, we also make repairs on-site.

TECHNICAL ASSISTANCE IS JUST A PHONE CALL AWAY. Training and technical assistance are tailored to meet your individual needs. For free assistance with your design and manufacturing applications, simply call our Customer Resource Centers. You can depend on each center's team of experts for immediate solutions.

STAY ABREAST OF TECHNOLOGY, AUTOMATICALLY. With an Update Agreement from Data I/O Corporation, you'll automatically receive programming support for new devices released by the major semiconductor manufacturers. And software updates ensure you'll always have the most powerful CAE tools.

PROTECT YOUR INVESTMENT IN QUALITY. From now until March 1, 1987, you can get a 25% discount on a two-year Data I/O Programmer Update Agreement or FutureNet

Software Agreement. Call **1-800-237-3798** or complete the coupon below for more information. Find out why we keep our customers for life.

25% OFF UPDATE SERVICES.

Yes! I am interested in saving 25% on update services.

Name _____
 Title _____
 Company _____
 Address _____
 Phone _____

EDN12/25

SEND TO:
 Data I/O Corporation
 Attn: N. Maul
 10525 Willows Rd. N.E.
 P.O. Box 97046
 Redmond, WA 98073-9746

DATA I/O
 Corporation

Data I/O Corporation 10525 Willows Road N.E., P.O. Box 97046, Redmond, WA 98073-9746, U.S.A. (206) 881-6444/Telex 15-2167
 FutureNet 9310 Topanga Canyon Boulevard, Chatsworth, CA 91311-7528 (818) 700-0691/Telex 910-494-2681
 Data I/O Canada 6725 Airport Road, Suite 302, Mississauga, Ontario L4V 1E5 (416) 678-0761/Telex 06968133
 Data I/O Europe World Trade Center, Strawinskylaan 633, 1077 XX Amsterdam, The Netherlands (20) 622866/Telex 16616 DATA NL
 Data I/O Germany Bahnhofstrasse 3, D-8453 Selgenstadt, Federal Republic of Germany (6182) 3088/Telex 4184962 DATA D
 Data I/O Japan Sumitomosemei Highashishinbashi Bldg., 8F, 2-1-7, Highashi-Shinbashi, Minato-ku, Tokyo 105, Japan
 (03) 432-6991/Telex 2522685 DATAIO J

CIRCLE NO 3