

DATA**85**MATION

OEM EDITION JANUARY 15 \$3.00 U.S.A.



WHEN LEMONS LOOM

Discover the SAS System... Your Information Center Solution

Do you want one software system to meet all of your Information Center needs? Look no further. The SAS® System can reduce the applications backlog and improve productivity throughout your organization.

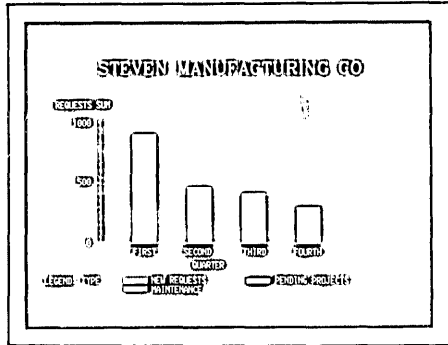

Discover... The SAS Solution for End Users

You can meet every computing need with the integrated SAS System. Use it for prospect files, sales reports, tracking systems, spreadsheets, mass mailings, project schedules, product mix models, forecasts, and presentations. All this and more with the SAS System.

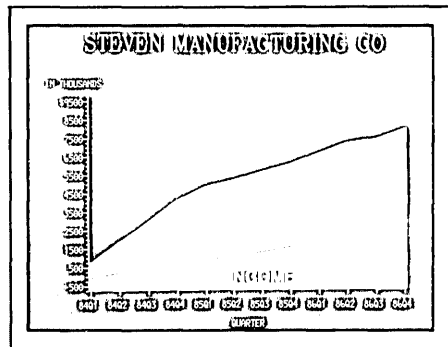

Discover... The SAS Solution for Programmers

The SAS System satisfies your programmers' needs too. With a few simple statements, you can read files from your production systems and DL/I data bases. You'll find the SAS System ideal for adhoc reporting, problem solving, and prototyping.

Discover... The SAS Solution for You

The SAS System helps you cope with all your end users' and programmers' needs. One system gives you the software tools for every application, on the hardware you've already installed. The SAS System runs on the IBM 370 family of machines under OS, TSO, VM/CMS, DOS/VSE, SSX, and ICCF, and under Digital Equipment Corporation's VMS™ and Data General Corp.'s AOS/VS operating systems.

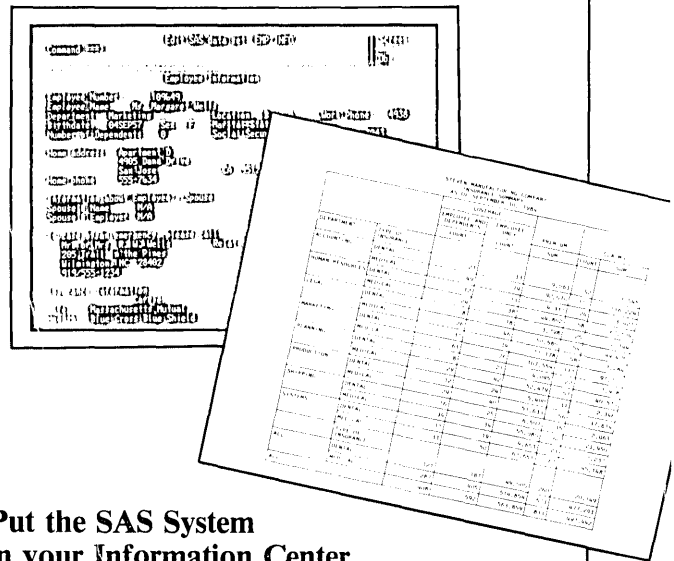

“Put the SAS System
in your Information Center.
It may be the best decision you
make all year.”

SAS Institute Inc., Software Sales Department,
SAS Circle, Box 8000, Cary, NC 27511-8000, USA.
Telephone (919) 467-8000. Telex 802505.

International customers, call the Institute's International Marketing Department for information on your local distributors.



OEM alert: The new Perkin-Elmer 3205 packs supermini performance into a micro price tag.

Introducing the Perkin-Elmer 3205. Now OEMs and system integrators can provide 32-bit supermini computing power at micro system economics, without making any compromises.

No micro system can approach the per-terminal cost advantages of the Perkin-Elmer 3205 supermini. Or the migration paths. Or offer access to a common database.

No supermini system can touch the Perkin-Elmer 3205 proven price/performance statistics.

Small investment. Big potential.

A basic 3205 costs just \$8,029* and includes one megabyte of memory, eight communications lines, floating point and a lot more. There's even a microprocessor handling just

communications support that has more power than you get in most complete microcomputers.

The 3205 can be expanded to 4 megabytes of memory, 16 communications lines and 1.2 gigabytes of disk storage. And every configuration in the broad 3205 range offers a choice of operating systems: our own Real Time OS/32 or one derived from the UNIX** operating system.

Fully configured value.

50 megabytes of fixed/removable Winchester disk memory, 8 communications ports and a full complement of related capabilities are included in a fully configured 3205 computer for only \$15,469*. That lets you supply powerful computer systems your customers can afford to buy.

The support you need.

Perkin-Elmer has been an OEM supplier for over 15 years. We know how to support you. We have a worldwide service network, powerful, quality software, reliable hardware and the terms and conditions you need.

Mini/Micro/Maximization.

The Perkin-Elmer 3205 gives you the small purchase price of micro systems, and the power, growth potential and common database advantages of supermini systems.

For the complete story, call or write the Perkin-Elmer Corporation, Two Crescent Place, Oceanport, N.J. 07757. **1-800-631-2154.** In N.J., 1-201-870-4712.

*OEM quantity 100, U.S. only.
**UNIX is a trademark of Bell Laboratories.

PERKIN-ELMER

The science and computer company.
Where solutions come first.

CIRCLE 2 ON READER CARD

Hydra's concept for network growth opens the world for you.

Get an idea of how network management is
put to rest by our finger tips.

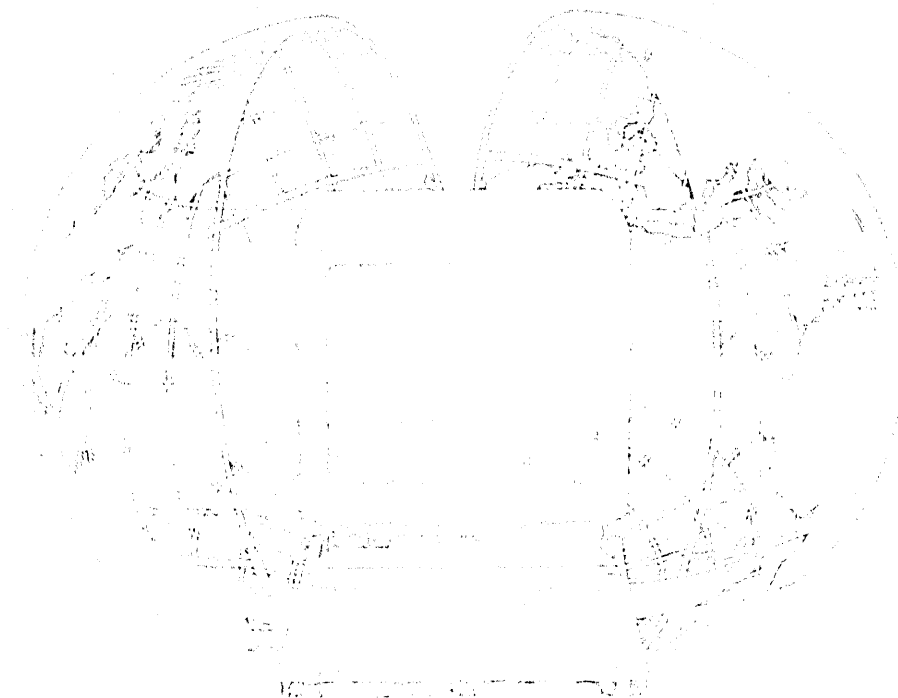

Hydra
Network
Management
System

Hydra is a network management system that provides a comprehensive view of your network. It allows you to monitor network performance, troubleshoot issues, and manage your network resources. Hydra is designed to be easy to use and integrate with your existing network infrastructure. It provides a central hub for all your network management tasks, making it the perfect solution for businesses of all sizes.

DATAMATION

JANUARY 15, 1985/\$3.00 U.S.A.
VOLUME 31 NUMBER 2
This issue, 183,590 copies

FEATURES

30 IN FOCUS

In this special report, "Probing Pcm Perils," DATAMATION examines the fragmenting pcm business: are its current woes merely a cyclical downturn or do they portend the demise of the pcm industry?

72 LEARNING FROM LEMONS Philip H. Dorn

A commercial computing industry reaching the ripe old age of 35 provides us with a good supply of follies, failures, and fiascos for our edification, enlightenment, and entertainment.



85 RAISING ORPHANS Nancy Welles

Many dp people maintain that caring for their high-tech waifs is no more of a problem than for equipment produced by a vendor who is alive and well.

93 ALAS POOR VISICORP Efrem Sigel

What's responsible for the crash of the micro software business? Failure to understand the faddish aspect of pcs? Or failure to grasp fundamental concepts of marketing? The answer is a little of each, and more.



101 THE COMPUTER EXPERT'S GUIDE TO LIFE Charles Bassine

Being a Computer Expert is not as rewarding as computer crime, but it is less risky and requires much less work. Your success varies inversely with your interest and competence in computing.

108 BLOOD FROM TURNIPS? Lawrence Bernstein and Christine M. Yuhas

The frontiers of productivity are due to be expanded with the next major breakthrough: organizationwide reusable code.

116 THE IMPORTANCE OF POWER Dan M. Bowers

The subsystem that provides electrical power is more than just an umbilical to the wall plug; it is one of the four basic elements without which the computer cannot operate.

127 A SWEDISH EXPERIMENT Joan Greenbaum

A company founded on the idea that dp is more than a job—that it is a way of life—may encourage creativity, but it can also breed problems in diversity.

NEWS IN PERSPECTIVE

- 44 **STRATEGIES**
The new Sperry: Unixvac?
- 48 **OFFICE AUTOMATION**
Clash of the techies.
- 54 **E-MAIL**
Looking for some customers.
- 59 **APPLICATIONS**
Of pcs and mortgages.
- 68 **BENCHMARKS**
- 69 **WORLD WATCH**

DEPARTMENTS

- 8 **LOOKING BACK**
- 13 **LOOK AHEAD**
- 16 **CALENDAR**
- 23 **LETTERS**
- 27 **HARDCOPY**

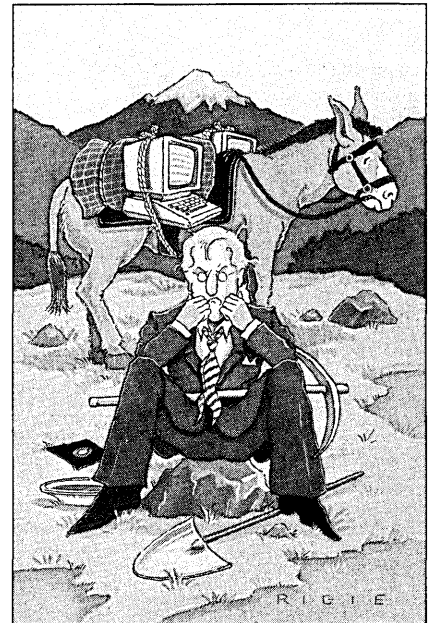

- 133 **HARDWARE**
- 141 **SOFTWARE**
- 145 **MARKETPLACE**
- 148 **ON THE JOB**
- 155 **READERS' FORUM**
- 159 **ADVERTISERS' INDEX**

OEM SUPPLEMENT 128-1

- 5 **THE WINCHESTER ILLUSION**
- 17 **BABY BELL'S BONANZA**
- 27 **DIGITAL DINING**

COVER PHOTOGRAPHS BY STEVE COOPER

If you haven't attended a Cullinet seminar, you haven't gotten the complete picture.

While other software companies offer at best a fragmented approach to information management, Cullinet's integrated software solution is rich, powerful and complete. Making it finally possible for organizations to implement a true information management strategy.

For information about the next Cullinet Seminar in your area, please phone us, toll-free, at 1-800-225-9930. (In MA, call 617-329-7700.) Or send in the coupon below.

DM0115

"Yes, I'd like to attend a Cullinet Seminar."
Please let me know about the next one being held in my area.

Name/Title _____
Company/Department _____
Address _____
City/State/Zip _____
Telephone _____
Computer _____

Cullinet
We understand business better than any software company in business.
Send to: Cullinet Software, 400 Blue Hill Drive, Westwood, MA 02090-2198

CIRCLE 4 ON READER CARD

DATAMATION

Editor Rebecca S. Barna
Managing Editor Parker Hodges
Assistant Managing Editor Florence Lazar
Assistant Managing Editor, News Larry Marion
Features Editor Kenneth Klee
International Editor Linda Runyan
Senior Writer John W. Verity
Assistant News Editor Michael Tyler
Assistant Features Editor Deborah Sojka
New Products Editor Robert J. Crutchfield
Copy Editor Theresa Barry
Assistant Copy Editor Eric Brand
Assistant Editor Mary Ann Hariton
Bureau Managers
Boston R. Emmett Carlyle
Chicago Karen Gullo
Los Angeles Edith D. Myers
San Francisco Charles L. Howe
Irene Fuerst
Tokyo Thomas Murtha
Washington Willie Schatz
European Managing Editor Paul Tate
Technology Editor, Europe Fred Lamond
Foreign Correspondents John Lamb, London;
James Etheridge, Paris; Peter Hidas, Oslo;
Norman Kemp, Sydney.

Art Director Kenneth Surabian
Assistant Art Director Susan M. Rasco
Art/Production Coordinator Catherine Kennedy

Art/Production Assistant Cheryl Storti

Contributing Editors Pamela Archbold,
Laton McCartney, Hesh Wiener

Advisory Board Lowell Amdahl, Philip H. Dorn,
Joseph Ferreira, Bruce W. Hasenyager, David
Hebditch, John Imlay, Louis Naugès, Irene Nesbit,
Angeline Pantages, Robert L. Patrick, Malcolm Peltu,
Russell Pipe, Carl Reynolds, F.G. Withington.

Publisher James M. Morris
Executive Editor John L. Kirkley
Research Director Laurie Schnepf
Operations Manager Patricia Adamo
Production Manager Anne Earley
Circulation Vice President Joseph J. Zaccaria
Circulation Manager Mary Agnes Glenister

EDITORIAL OFFICES

Headquarters: 875 Third Ave., New York, NY 10022.
Phone (212) 605-9400; telex 429073. **New England:** 1
Chaucer St. RFD 2, Sandwich, MA 02563, (617) 888-6312.
Washington, D.C.: 4451 Albermarle St. NW, Washington,
DC 20016, (202) 966-7100; **Midwestern:** 303 E. Wacker Dr.,
Chicago, IL 60601, (312) 938-2900. **Western:** 1801 S. La
Cienega Blvd., Los Angeles, CA 90035, (213) 559-5111;
2680 Bayshore Frontage Rd., Suite 401, Mountain View, CA
94043, (415) 965-8222. **International:** 130 Jermyn St., Lon-
don SW1Y 4UJ, England, (441) 839-1840, telex 914911; 13
Stanley Place, Budd Lake, NJ 07828, (201) 691-0592, telex
499-4308.

Technical Publishing

DB a company of
The Dun & Bradstreet Corporation

VBPA ABP

DATAMATION (ISSN 0011-6963) Magazine is issued twice monthly on the 1st and 15th of every month by Technical Publishing, a company of The Dun and Bradstreet Corp., John K. Abely, president. Executive, advertising, editorial offices, and subscription departments, 875 Third Ave., New York, NY 10022. Published at Lincoln, Nebr. Annual subscription rates: U.S. and possessions: \$50; Canada: \$75; Japan, Australia, New Zealand: \$140 air freight; Europe: \$120 air freight, \$225 air mail. All other countries: \$120 surface, \$225 air mail. Reduced rate for qualified U.S. students, public and school libraries: \$38. Single copy: \$3 in U.S. Sole agent for all subscriptions outside the U.S.A. and Canada is J.B. Tratsart, Ltd. 154 A Greenford Road, Harrow, Middlesex HA13QT, England, (01)422-8295 or 422-2456. No subscription agency is authorized by us to solicit or take orders for subscriptions. Second-class postage paid at New York, NY 10001 and at additional mailing office. ©Copyright 1985 by Technical Publishing Co., a Division of Dun-Donnelley Publishing Corp., a company of The Dun and Bradstreet Corp. All rights reserved. "Datamation" registered trademark of Technical Publishing Company. Microfilm copies of Datamation may be obtained from University Microfilms, A Xerox Company, 300 No. Zeeb Road, Ann Arbor, MI 48106. Printed by Foote & Davies/Mid-America. POSTMASTER: Send address changes to Datamation, 875 Third Ave., New York, NY 10022.

EVERYONE
WILL BE MAKING
HIGH SPEED
MODEMS LIKE
THIS.

IN THREE OR
FOUR YEARS.



How did Codex come up with the 2600 Series, a new generation of modems running at speeds from 4800 to 16,800 bps that's so much more advanced than the competition?

By designing a revolutionary VLSI-based signal processing architecture teamed with the powerful Motorola MC68000 microprocessor.

A design that incorporates a unique Adaptive Rate System, which continuously adjusts the transmission speed of the Codex 2660 to the maximum rate the line will support. Allowing you to optimize throughput all the way up to 16,800 bps, without having to lift a finger.

A design that ensures data reliability with Trellis Code Modulation (TCM)—a significant advancement over uncoded modulation techniques in common use today.

In multipoint applications, the Codex 2640 can even handle mixed 9600, 7200 and 4800 bps inbound rates. So each drop can operate independently at maximum speed and efficiency.

Of course, with the Codex 2600 Series, network control is standard. So you can monitor line and modem performance from the front panel or from a central Codex DNCS system. Plus there's an optional downline-loading feature that lets you conveniently modify or enhance the functionality of remote, unattended modems.

The Codex 2600 Series.

In three or four years, our competitors will probably have modems just like them.

If you'd rather not wait, contact Codex today. We'll send you detailed information about these 2600 features and more.

Much more.

Call 1-800-821-7700 Ext. 886. Or write: Codex Corporation, Dept. 707-86, 20 Cabot Boulevard, Mansfield, MA 02048.

codex

 **MOTOROLA INC.**
Information Systems Group

Figure 1: [Faint, illegible text]

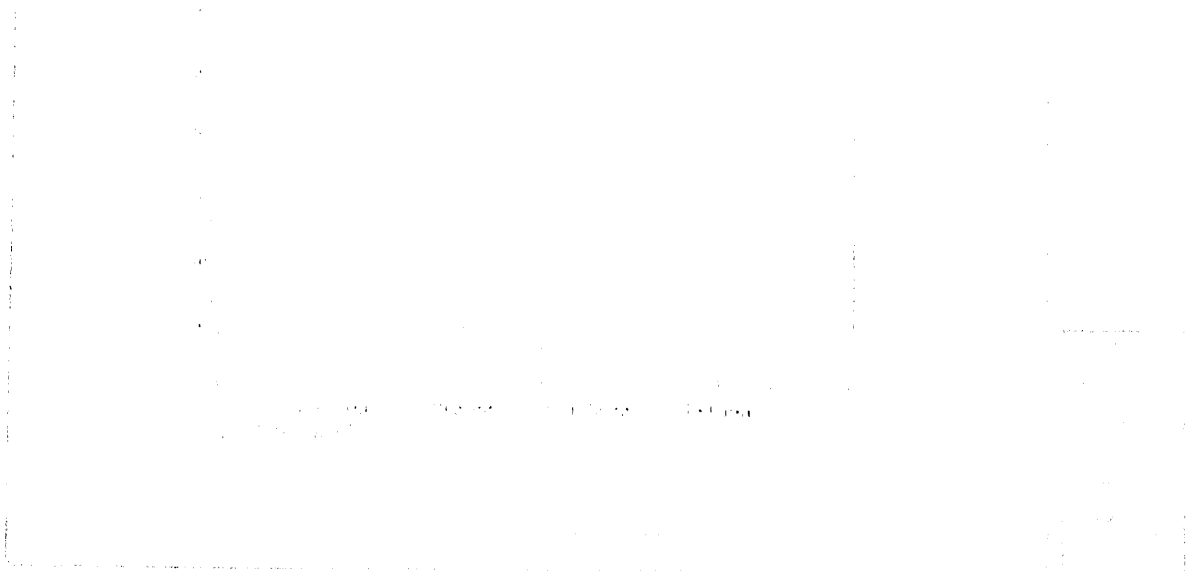

EXA107

[Faint, illegible text at the bottom of the page, possibly a list or index of items.]

YOUR TWO FAVORITE COMPUTERS NOW HAVE ONE THING IN COMMON. YOUR FAVORITE GRAPHICS TERMINAL.

Introducing the new CX4100 Series of Tektronix high performance, yet affordable color graphics terminals.

Now you can have the Tektronix PLOT 10 graphics command set you've always wanted while you use the host of your choice, IBM or DEC. Just by typing a single

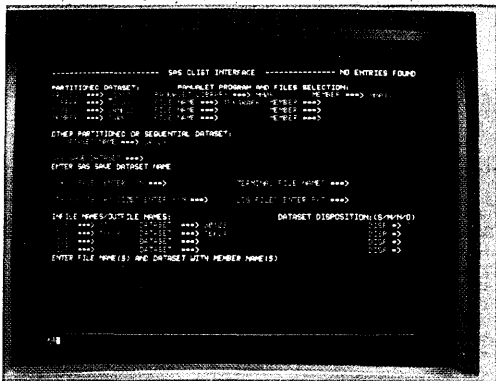

Familiar 3270 IBM-style alphanumeric output is fully emulated on all CX4100 terminals. Enhanced IBM-style keyboard is part of the package.

"switch-host" command.

Tek's CX4106, CX4107 and CX4109 are all directly plug compatible with both host environments. One coax to a standard IBM 3270 controller is all you need or one RS-232 connection to your DEC system.

To make your use of existing or new graphics data fast and friendly, the CX Series comes with an

IBM-style keyboard. Plus Tek enhancements: individual key programmability, user-selectable ten-key pad, and joydisk for quick cursor movement and graphics input.

Screen output will be just as familiar as keyboard layout. 32-line 3278/3279 alphanumeric emulation is built in. And so is full support for the 4957 Graphics Tablet, plus full hard copy and transparency output to a full range of Tektronix Color Graphics Copiers and the 4510 Color Graphics Rasterizer.

IBM flexibility is matched by DEC flexibility. In RS-232 mode, the terminals can run all VT100 applications through the extended ANSI X3.64 command set. In addition to the host interface port that transmits data at rates up to 38.4k baud, CX terminals are provided with two additional RS-232 ports and a Centronics-style parallel port for connecting a wide range of peripherals.

But best of all you'll have great graphics and full software compatibility. The CX Series will accept many existing programs written for 4010, 4100, and 4110 Series terminals. And they're fully compatible with PLOT 10 IGL, GKS, and TCS programs as well as with popular third-party software such as SAS/GRAPH® ISSCO's DISSPLA® and TELL-A-GRAF® and Precision Visuals' DI-3000®.

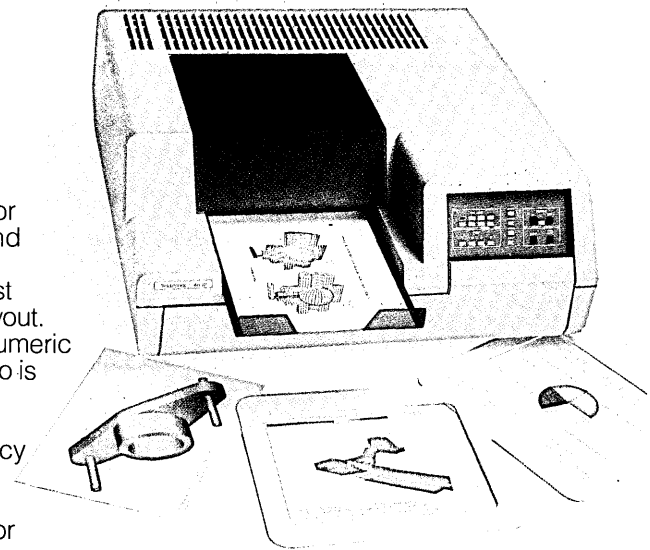

Tek's all new precision ink jet 4692 color copier produces very high quality full color transparencies or hard copy.

That's software investment protection—matched by technology protection. CX terminals feature a 60 Hz non-interlaced display with 4096 x 4096 addressability displayed in a 640 x 480 matrix.

16 colors, eight line styles, 11 marker types, rapid area fill, scalable/rotatable text, complete segment support, true zoom and pan, and separate dialog area. It's all there with the full PLOT 10 command set.

So don't wait. Set the best of three worlds on one desk: TEK, DEC, and IBM. Contact your local representative today for information on the CX4100 Series. Call 1-800-547-1512. In Oregon 1-800-452-1877.

Tektronix®
COMMITTED TO EXCELLENCE

No big headlines
 No catchy slogans
 No outlandish statements

**TECHNOLOGY
 TRANSFER
 INSTITUTE:**

**Just the best
 DP education you can get**

At Technology Transfer Institute, we feature seminar leaders who are the technology pioneers. We believe the key element for a successful seminar is the lecturer. Our lecturers include:

James Martin • Leonard Kleinrock • Amy Wohl • Tedd Codd • Alan Paller • Fouad Tobagi • Robert Holland • Jeff Buzen • Peter Denning • Tom DeMarco • Shaku Atre • Bill Stallings

Our 1985 Seminars include:
 Local Networks • Voice/Data PBX • X.25 • SNA • Office Automation • Computer Graphics • Data Base Management • Information Centers • Queueing Systems • Configuration Management • CADD/CAM • Software Projects • Network Protocols

SEMINARS OF EXCELLENCE

Computer Networks Seminars
 Computer Data Base Seminars
 Computer Applications Seminars

JAMES MARTIN SEMINAR

For a free catalogue, call or write to:

Technology Transfer Institute
 741 10th Street, Santa Monica, CA 90402
 (213) 394-8305

Please send me information on:

Seminars of Excellence James Martin Seminar

Name _____

Company Name _____

Address _____

City _____

State/Zip _____

Phone _____

DA 1/85

CIRCLE 6 ON READER CARD

LOOKING BACK

STANDARD REACTION

January 1965: RCA's Spectra 70 announcement brought all kinds of reactions from the industry, ranging from charges of me-tooism to a cry of "Greatest shot in the arm for the industry yet."

That latter quote came from an insider who felt that for the first time in 10 years, the industry had a standard. He admired RCA for accepting the 360 as such, and thought other manufacturers should follow suit. Another observer agreed, saying, "This makes the 360 the industry *de facto* standard."

Actually, the general reaction was that this was a price, rather than a technological, break, because it would force IBM to lower prices. It was noted that the breaks would probably come in the form of increased speeds at the same prices.

All was not yet quiet on the western front, however, and it seemed the compatibility of the 70 with the 360 raised more questions than it lifted hearts. One fellow noted that RCA was achieving compatibility at too low a level, and doubted whether there would be much machine-language coding for either the 360 or 70. He also noted the significance of RCA's copying only the underprivileged instructions, meaning that the two operating systems, which use privileged instructions, might be quite different. For true compatibility, the links between application programs and operating systems must be identical.

Others saw a weakness in the lower end of RCA's line (the 70/15 and 70/25), with their "rather limited" instruction sets. One user wanted to see RCA come out with something below the 45 in power and price as an option to the 360/40s he planned to install. The gap between the 15 and 45 suggested he might have his wish.

Generally, the industry was pretty much waiting to see if RCA could come up with the software, and just how well the 70 could gobble up 360 programs.

THE STUTTGART CONNECTION

January 1971: A West German firm reportedly responsible for the "reexportation" of IBM computers into the Soviet Union was the subject of a news story by W. David Gardner, DATAMATION's industry editor.

The pivotal figure in the story was Peter Lorenz, whose name adorned a few computer firms in the Stuttgart area.

Exactly how many computers had been smuggled into the Soviet Union was difficult to pinpoint. Lorenz, however, was known to have been involved in at least two big deals—smuggling a 360/40 and a 370/145 into the country.

The Department of Commerce claimed that sometime in early 1971, "The Lorenz firm reexported from West Germany to the U.S.S.R. a computer system valued at \$1.6 million, which was subject to U.S. export controls, although the firm knew this was a violation of U.S. Export Control Regulations."

The system they spoke of was the 360/40, and possibly the first of the 360 series to arrive in Russia. On top of that, DATAMATION learned that Lorenz was also involved in the shipment of a 370/145 to Russia—almost certainly the first model of that line of computers to arrive in Moscow.

Apparently, though, the Russians had a hard time getting the software to work. In addition to the ex-IBMers Lorenz had on his staff, there were unconfirmed reports of West German IBM employees vacationing in the Soviet Union to do a little moonlighting on the system.

Lorenz wouldn't discuss the matter with DATAMATION, but in a West German publication he offered the argument that since the model 40 was built in Europe, it was not of U.S. origin.

"We are a German firm," said Lorenz, "and I hope also that we are a sovereign state, so much so that the American influence cannot go this far."

—Lauren D'Attilo

Does your company need help in managing its telephone costs?



The telephone is the lifeline of your business. You're going to a great deal of trouble and expense to get a proper telephone system—don't you still have a monthly telephone bill that is astronomical?

You still don't know how to allocate this expense by division, department, cost center or individual? You don't know the extent of personal abuse calls? You don't know if you have the most cost-effective mix of facilities, WATS, or foreign exchanges? And finally, you don't know in which areas of your company the telephone system is being effectively utilized and in which areas it is not.

Maybe It's Time You Called Account-A-Call.

We can be a big help in managing your telephone costs by providing solutions to virtually every telephone usage situation. Our sophisticated scientific database prepares for you monthly reports that effectively analyze your telephone expenditures.

Costs are clearly and simply organized by any number of allocation criteria— from a single user to an entire department. You know *who* is making *what* calls, *where* the calls are being made and *how much* the calls are costing. And with Account-A-Call, you find out just how efficiently your entire phone system is working in this increasingly complex world of telecommunications.

Want to know more about what we can do for you? Ask for our free brochure describing ways in which we can help your company manage its telephone costs.

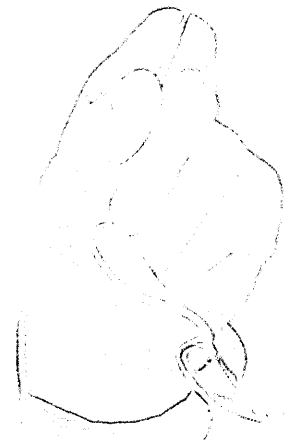

© 1982 Account-A-Call Corporation
4150 Lakeside Drive, Burbank, CA 91505 (818) 846-3340

Account-A-Call
CORPORATION
CIRCLE 7 ON READER CARD

FINALLY. HELP FOR THE DATA CRAZED.

Introducing Cypress[®], Cedar[™] and Juniper[™]. Three fast, friendly, infinitely applicable desktop ideas from ROLM.

It comes as no surprise that people react to technology differently. Dyed-in-the-chip techies thrive on it. True non-believers avoid it instinctively.

Now you can please all of the people all of the time. Honest.

Say goodbye to complicated log-on codes. Just push a button

and — whoosh! — travel all the way to a data base, talk to a mini or access your IBM mainframe.

Say hello to speakerphones, phone books, message takers and calculators. Built right in.

If you want to take snapshots of data in your mainframe, there's Cypress.

It's as easy as Point & Shoot. It's a smart little ASCII terminal integrated

with a fully-featured digital phone.

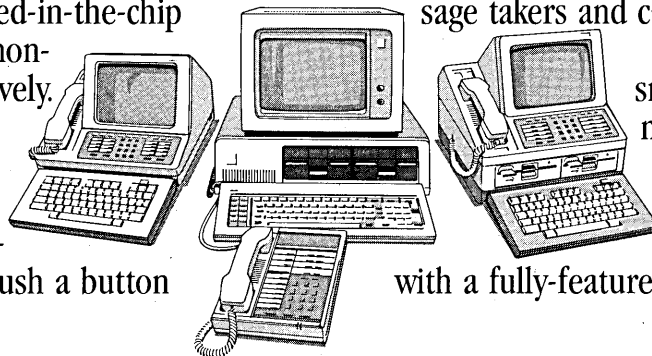

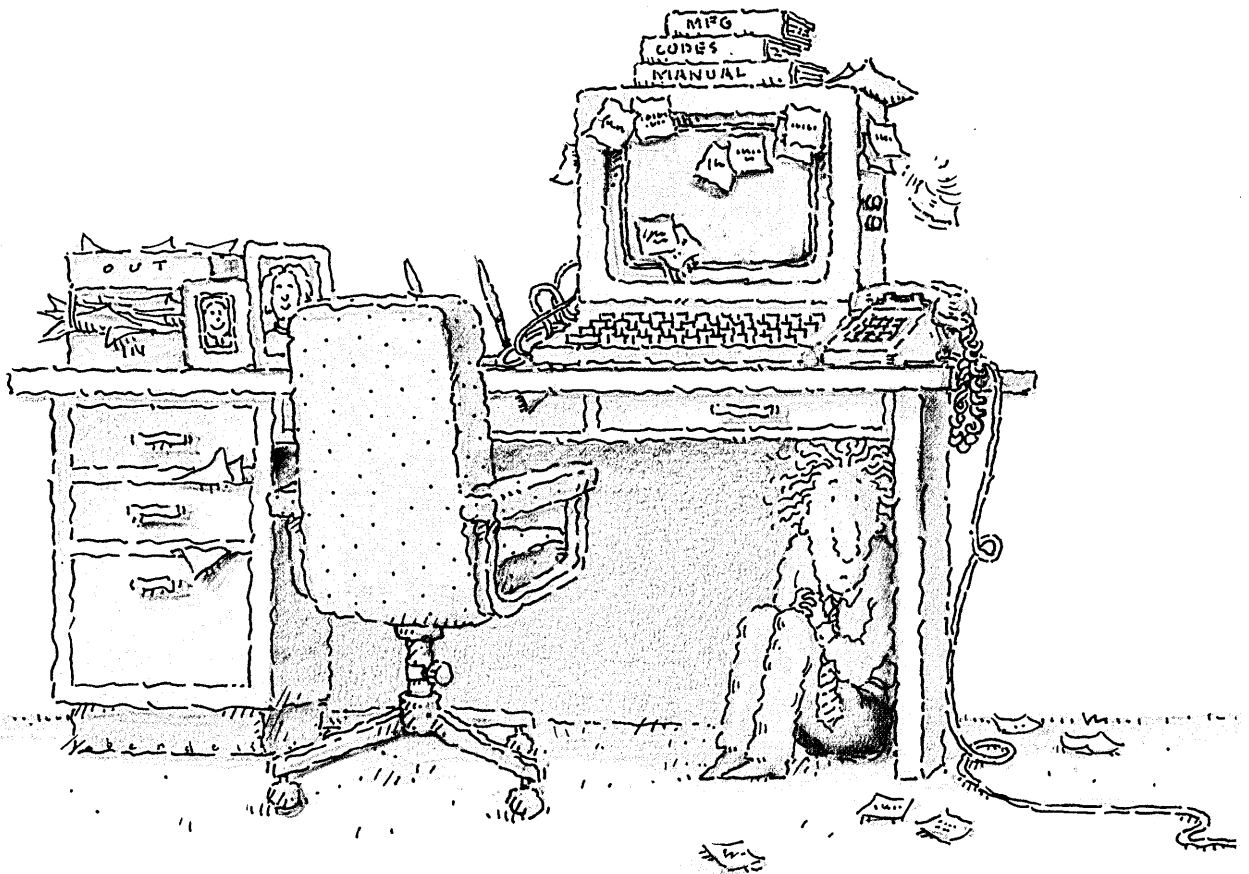

Need a 512 KB, fully IBM-compatible PC that runs programs like pfs:graph™, the IBM Assistant Series™ 1-2-3™, and lets you mini-network through your phone line? Cedar's the one.

Already in love with your IBM® PC or XT but crave the affections of Cypress? Ask for Juniper. Its one slot adaptor card lets your system keep growing. And growing.

Of course, only ROLM has Cypress, Cedar and Juniper. Because only ROLM has the sys-

tem to run them on. At its heart is the CBX II, a breakthrough communications controller that manages voice and data over standard telephone wire. Simply, brilliantly and cost effectively.

And ROLM has the technical edge, the operational track record and the worldwide service and support organization to please even the toughest customer.

So phone ROLM. High tech. Not high anxiety.

ROLM

4900 Old Ironsides Drive, M/S 626 Santa Clara, CA 95050 • 800-538-8154. (In Alaska, California and Hawaii, call 408-986-3025.)
Trademarks: pfs:graph—Software Publishing Co., IBM Assistant Series—International Business Machines Corp., 1-2-3—Lotus Development Corp.

CIRCLE 8 ON READER CARD

The nicest thing about IDMS/R on a 4300 is how easy it is to build with.

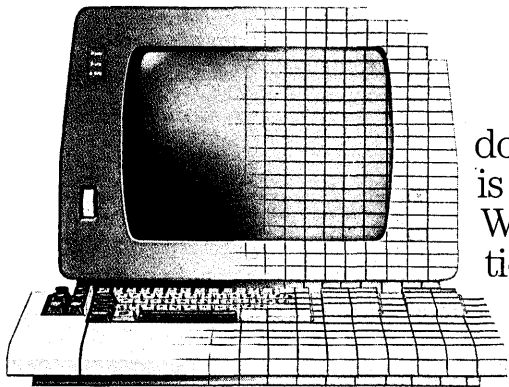

It's a rare data processing department that doesn't have a backlog of applications, and nowhere is the problem more acute than among 4300 users. With fewer people typically to develop applications, fewer applications typically have gotten developed.

Adding more applications developers might seem one way to combat the problem.

But we'd like to suggest a more sensible approach. A way to enable you to get more productivity out of your existing dp staff.

It's called IDMS/R.

Cullinet's powerful new relational database management system, IDMS/R greatly reduces the time it takes to develop applications. Its Automatic System Facility (ASF), a major advance over fourth generation languages, is so simple to use, end users can develop applications *themselves*.

IDMS/R is also extremely flexible. It anticipates change by providing for the dynamic definition and redefinition of your relational database.

Finally, a point of special interest to 4300 users: IDMS/R conserves finite data processing resources. With a feature called "Relational Fastpath," you can tune the database and thereby benefit from a dramatic boost in performance.

For more information about IDMS/R, as well as our complete approach

The Complete Software Solution

Decision Support
Applications
Database

to information management, attend a Cullinet Seminar. You can make arrangements by calling, toll-free, 1-800-225-9930. In MA, the number is 617-329-7700.

Cullinet: I'd like to learn more about IDMS/R.
Please arrange for me to attend a Cullinet Seminar.

Name _____

Title _____

Company/Department _____

Address _____

City/State/Zip _____

Telephone _____

Send to: Cullinet Software, 400 Blue Hill Drive, Westwood, MA 02090-2198

DM01155

Cullinet

We understand business better than any software company in business.

© 1984 Cullinet Software, Inc., Westwood, MA 02090-2198

CIRCLE 9 ON READER CARD

LOOK AHEAD

EIGHT-CHIP VAX
11/780 in 1986

A blockbuster new superminicomputer hardware design is coming from Digital Equipment Corp. Microvax III is rumored to be just eight very large scale integrated circuit chips, running the complete VAX 11/780 instruction set. Quite a design feat, squeezing 3,200 integrated circuit chips into eight; reducing board space to 18 square inches from 4,000 square inches; and cutting power consumption by a factor of 50, to 20 watts. Expect the first desktop models in 1986.

MV12000 WITH
4MIPS DUE

The high-end price/performance war among minicomputer makers will further heat up with the imminent announcement of the MV12000 from Data General. It will offer up to 4MIPS of power, and maintain DG's prominence in the MIPS per buck sweepstakes currently preoccupying New England mini makers. Shipments due this summer.

APPLE'S TEST
DRIVE CRASHED?

Early reports indicate that Apple Computer's admirable new promotion of Macintosh, offering prospective users a free overnight loan of its M68000-based personal computer, is not a screaming success. Informal surveys of Apple dealers by Future Computing, Dallas, indicate that many retailers are not overrun with interest....

... THOUGH
WANG AND XEROX
LOOKING

Every day brings another rumor about which establishment company will do a joint marketing agreement with the Silicon Valley longhairs. Apple's Macintosh is said to be tempting both Xerox and Wang Laboratories into thinking about a joint venture, since each has a personal computer line going nowhere. Wang seems to be the favorite, as the Apple folks are intimately aware of the fate of products initiated by and relationships with Xerox -- most of Mac's technology can be traced to pioneering work done at Xerox's Palo Alto Research Center.

UNIX FOR ALL
HP LINES?

The new Unix workstation from Hewlett-Packard is only the beginning of its 1985 shift to support Unix across its product line, from its top-of-the-line HP3000 minis on down. The new HP workstation, the \$4,999 Integral Personal Computer, contains a Motorola 68000 micro along with a 16-bit graphics processor, and includes the ThinkJet printer, Sony mini floppy disk drive, and a 9-inch electro-luminescent display in a package the size of a Compaq portable. Burning part of the Unix shell in a ROM cartridge is how the 800 kilobytes of main memory can boast Unix; an external hard disk drive

LOOK AHEAD

is required to utilize the full HP version of Unix System III. The four computer aided design programs ported over to HP's Unix indicate that the company is again trying to crack the hot market for low-cost CAD/CAM systems, as its HP9000 series of full 32-bit processors has not been a raging success.

ADAPSO SUING SW PIRATES

The Association of Data Processing Service Organizations thinks it has found a major corporate software pirate, and plans to make the company walk the plank. In the next few days expect a lawsuit against a Fortune 50 company, alleging widespread abuse of microcomputer software copyright. Supposedly the company buys small quantities of micro software, then runs off 50 to 100 copies and distributes them throughout the organization. ADAPSO will contend that the rampant duplication violates copyright laws, to make an example out of a large multinational and scare others into compliance.

TIMEPLEX INTO SYSTEMS SALES

Thanks to the booming demand for data communications gear such as time division multiplexors, Timeplex Inc. is on a roll. This year the company is expected to hit an annual revenue rate of \$130 million, and Wall Street analysts expect 20% per year growth through the end of the decade. Part of that increase is coming from a strategic shift in marketing and product strategy. Gregory P. Francfort of the brokerage firm First Boston, New York, predicts that Timeplex's new Data Systems Division supplying turnkey datacom systems to its customers may generate 40% of corporate revenues over the next few years; until recently, Timeplex was an oem. There's speculation the company will soon announce some joint ventures with vendors offering higher end switching gear.

RUMORS AND RAW RANDOM DATA

Voice recognition will soon be tested in a Boeing 747 -- 30% of pilot instructions to the on-board computer will be via voice command instead of control panel switches. . . .Cabbage Patch Computers are coming from Canada. Internal Computer Orphanage of Mississauga, Ontario, puts used computers up for adoption, matching the "orphan" with potential "parents" by using an international network and database. . . .A 10MB hard disk backup system priced at \$400 will soon be offered by Oakwood Publishing, Gardena, Calif. Twenty-seven specially formatted floppies allow recovery after loss by either complete mirror image restore or selective file restore.

Handwritten signature
Statistical Package

Statistics reports and plots happen magically with SPPS/PC - The Statistical Package for IBM PC/XTs.

SPPS/PC is the most comprehensive
statistical package for performing
simple or complex tasks, regardless of
data size. It maintains interactive and
language compatibility with mainframe
SPPS while specializing for the PC
environment.

Statistics range from simple
descriptive to complex multivariate
including multiple regression, ANOVA,
factor and cluster analysis. Logit models
and multiple correspondence analysis
are also included.

Simple facilities allow
transfer of files (externally).

SPPS/PC and programs like SPSS 2.0,
dBASE III and SYSS - Accounting Reports
written. Plotting facilities and a comprehensive
database program that transfer errors and
can be fully integrated (optional).

For more information, contact our
Marketing Department without further
cost. And see what a little statistical
can do for you.

SPPS Inc. 44400 W. Higgins Avenue
Chicago, IL 60630 (312) 231-2400
In Europe: SPPS, Barnet, UK
Phone: 081 873 4200. For information
write: SPPS/PC, P.O. Box 100, Woking, Surrey, UK
GU24 0BA

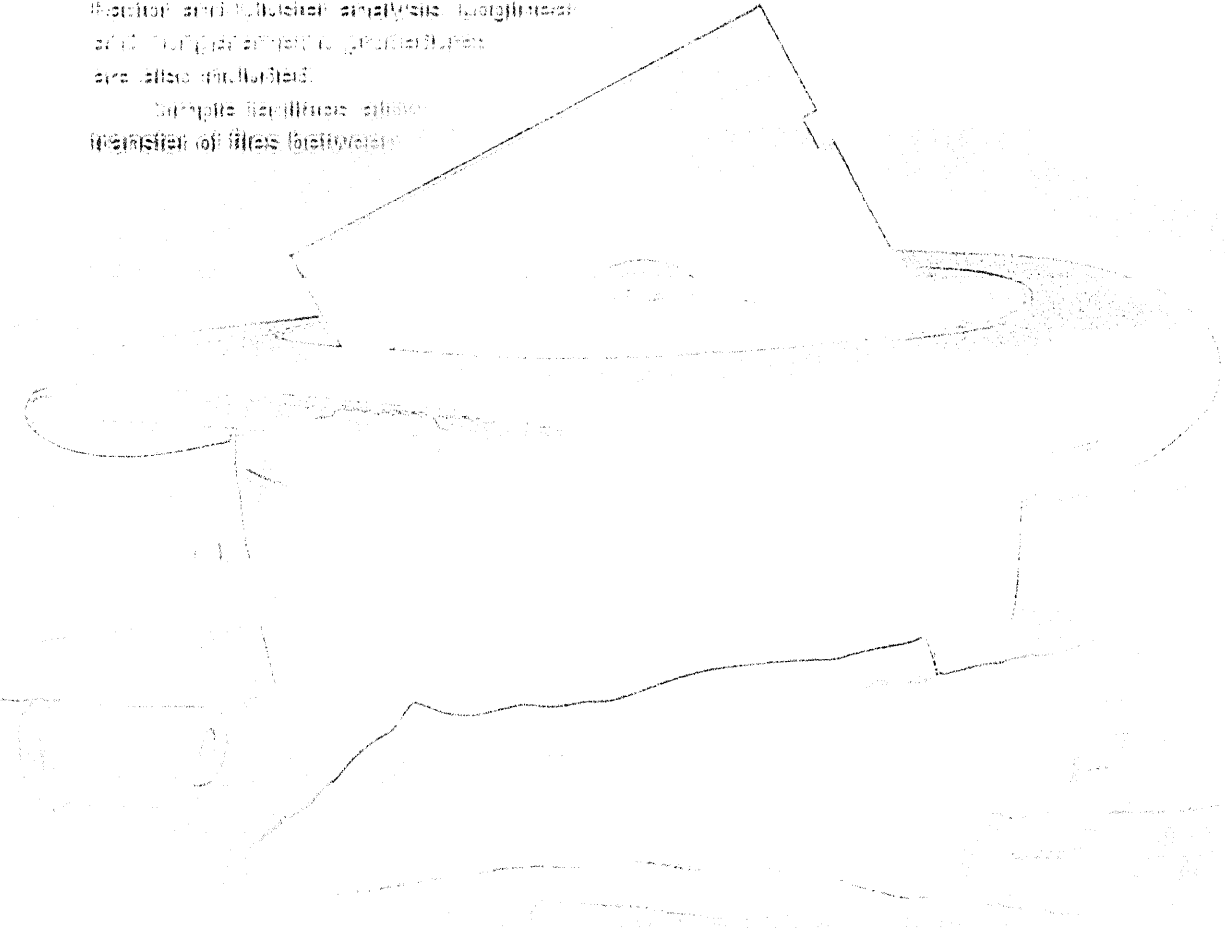



The NEW BUDS represent such advanced technologies as the smart card and its applications, and the non-impact print system.

The LEAVES and FLOWERS symbolize the growing facets of office automation, micro-computers, peripherals, bank systems...

The BRANCHES portray the connectability or independence of BULL DPS 6 mini-computers and BULL DPS 4 small business systems.

The SAP constitutes the communicability of BULL products, primarily through the Distributed Systems Architecture (DSA), and also through the SNA.

The TRUNK portrays the large and medium scale systems of BULL DPS 88, BULL DPS 8, and BULL DPS 7.

BULL COMPUTERS. THE TREE OF COMMUNICATION.



The tree of communication symbolizes BULL's total commitment to information systems.

As one of the leading international manufacturers of data processing and office automation systems, BULL offers competitive and innovative solutions to all your information management problems, whether special or general, always designed to meet the specific needs of your business.

Moreover, BULL has developed an unmatched know-how in designing communication systems in order to improve interaction at all levels and in any situation. The result: an enhanced competitive edge and a better return on your information and communication investment.

In terms of hardware, BULL offers a wide range, from micro-computers to large scale data processing systems, including distributed data processing and office automation. For BULL, high quality data processing necessarily includes the availability of a full range of constantly updated services, which are under continuous development. To this end, BULL cooperates closely at international levels with software houses, universities, research centers and other manufacturers.

Whether your organisation is large or small, simple or complex BULL Distributed Systems Architecture (DSA) adapts to you and to your needs. It conforms to international standards (ISO) and has the inherent property of accommodating change. DSA is adaptable, flexible, and easy to use.

Strongly present in 74 countries, BULL is wherever you are. So why not let us plant your tree of communication... or help it grow?

CIRCLE 11 ON READER CARD

Bull



CALENDAR

JANUARY

Asian Aerospace Expo & Conference.

Jan. 18-22, Singapore. Contact Gerlad Kallman, Kallman Associates, 5 Maple Court, Ridgewood, NJ 07450, (201) 652-7070.

Communication Networks Conference & Exposition.

Jan. 28-31, Washington, D.C. Contact William R. Leitch, General Manager, Communication Networks, P.O. Box 880, Framingham, MA 01701, (800) 225-4698 or (617) 879-0700.

Microcomputer '85.

Jan. 29-Feb. 3, Frankfurt, Germany. Contact Philippe Hans, German American Chamber of Commerce, 666 Fifth Ave., 21st fl., New York, NY 10103, (212) 974-8856.

FEBRUARY

1985 Office Automation Conference (OAC '85).

Feb. 4-6, Atlanta. Contact Marty Byrne, American Federation of Information Processing Societies Inc., 1899 Preston White Dr., Reston, VA 22091, (703) 620-8940.

Stride Faire.

Feb. 8-10, Reno. Contact Laura Smith, Stride Trade Show Manager, Burson-Marsteller, 2041 Mission College Blvd., Suite 245, Santa Clara, CA 95051, (702) 322-6868.

APAC '85.

Feb. 11-14, Riyadh, Saudi Arabia. Contact World Computer Graphics Association Inc., 2033 M St. NW, Suite 399, Washington, DC 20036, (202) 775-9556.

1985 IEEE International Solid-State Circuits Conference.

Feb. 13-14, New York. Contact Lewis Winner, 301 Almeria Ave., Coral Gables, FL 33134, (305) 446-8193.

AFIPS-ASIA '85.

Feb. 14-March 2, aboard the mv Worldwide Expo, to Japan, Taiwan, Hong Kong, Singapore. Contact AFIPS, 1899 Preston White Dr., Reston, VA 22091, (703) 620-8926.

International Computer Graphics Users Show and Conference (CGU '85).

Feb. 19-21, London. Contact World Computer Graphics Association Inc., 2033 M St. NW, Suite 399, Washington, DC 20036.

INFO/Central.

Feb. 20-22, Chicago. Contact Show Manager, INFO/Central, 999 Summer St., Stamford, CT 06905, (203) 964-8287.

Computer Business Graphics.

Feb. 20-23, Fort Lauderdale, Fla. Contact Carol Every, Industry Representative, Frost & Sullivan, 106 Fulton St., New York, NY 10038, (212) 233-1080.

MACWORLD Exposition.

Feb. 21-23, San Francisco. Contact World Expositions, Mitch Hall Associates, P.O. Box 860, Westwood, MA 02090, (617) 329-7466.

MICAD'85.

Feb. 25-March 1, Paris. Contact World Computer Graphics Association Inc., 2033 M St. NW, Suite 399, Washington, DC 20036, (202) 775-9556.

MARCH

FOSE (Federal Office Systems Expo).

March 4-7, Washington, D.C. Contact National Trade Productions, 2111 Eisenhower Ave., Suite 400, Alexandria, VA 22314, (800) 638-8510 or (703) 683-8500.

Seventh Annual National Office Exhibition & Conference.

March 12-14, Toronto. Contact Jim Mahon, Show Manager, National Office Exhibition and Conference, 20 Butterick Rd., Toronto, Ont., Canada M8W 3Z8, (416) 252-7791.

COMTEL '85 (The International Computer and Telecommunications Conference).

March 18-20, Dallas. Contact Comtel '85, Director of Communications, International Computer & Telecommunications Conference, 5080 Spectrum Dr., Suite 707E, Box 17, Dallas, TX 75248, (214) 631-6482.

Intelligent Buildings & Information Systems Spring Conference (IBIS).

March 18-19, Fort Lauderdale, Fla. Contact Tom Cross, Cross Information Co., 943 Pearl, Suite C, Boulder, CO 80302, (303) 444-7799.

AIRCON 2 (The Second Annual International Conference on Artificial Intelligence for Robotics).

March 21-22, Arlington, Va. Contact IIT Research Institute, 10 West 35th St., Chicago, IL 60616, (312) 567-4025.

The Second Annual Computer & Electronics Furniture Show.

March 24-26, San Mateo, Calif. Contact National Fairs, 1902 Van Ness Ave., San Francisco, CA 94109, (415) 474-2300.

INSPEX (Measurement and Inspection Technology Exhibition).

March 25-29, Birmingham, England. Contact British Information Services, 845 Third Ave., New York, NY 10022, (212) 752-8400.

Optical Storage of Documents and Images.

March 25-27, Washington, D.C. Contact Judy P. Hanson, TOC Coordinator, Technology Opportunity Conference, P.O. Box 14817, San Francisco, CA 94114-0817, (415) 626-1133.

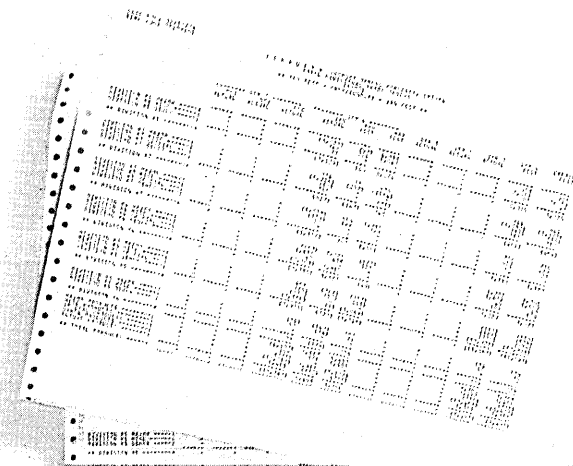

BP-2000 HIGH SPEED BAND PRINTER

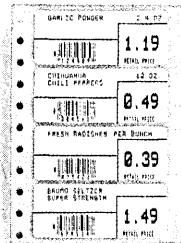

M-100L MATRIX PRINTER

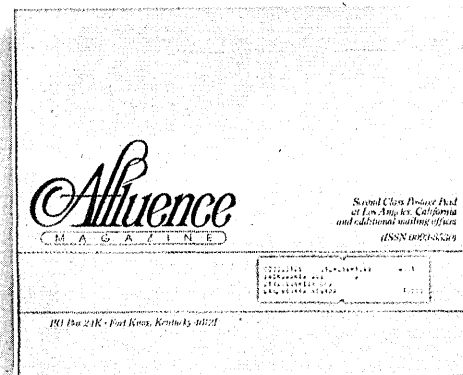

B-600 MEDIUM SPEED BAND PRINTER



8010 MATRIX PRINTER

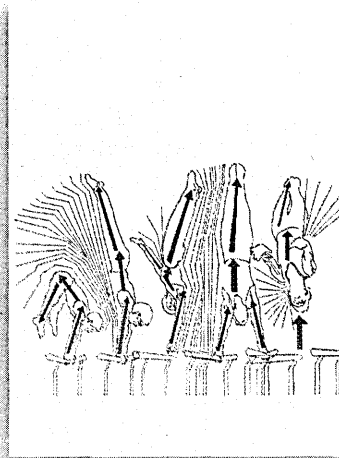

8020 MATRIX PRINTER

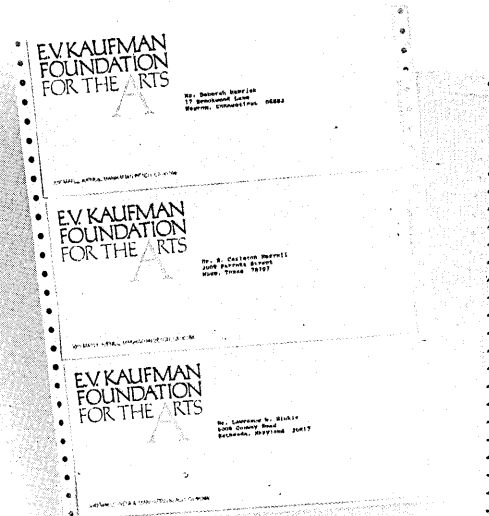

DP-55 DAISYWHEEL PRINTER

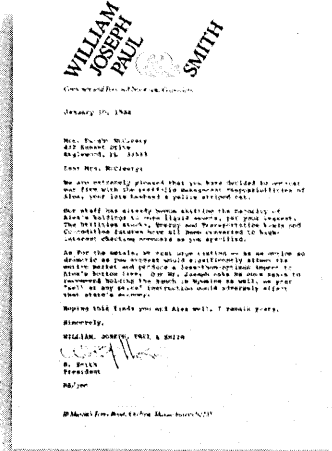

DP-35 DAISYWHEEL PRINTER



8050 MATRIX PRINTER

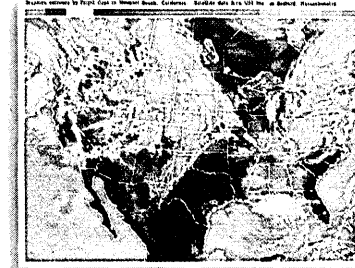

8070 MATRIX PRINTER

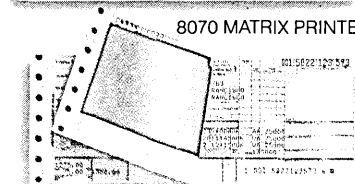

M-120 MATRIX PRINTER

...and so on.



Dataproducts printers.
 Nobody puts ideas on paper so many ways.

DATAPRODUCTS CORP., 6200 CANOGA AVE., WOODLAND HILLS, CA 91365. (818) 887-3924. IN EUROPE, 136-138 HIGH ST., EGHAM, SURREY, TW 20 9HL ENGLAND.

CIRCLE 12 ON READER CARD

COMPUTER FAT.

HOW TO AVOID IT, FROM THE LEADER
IN ON-LINE TRANSACTION PROCESSING.

WHAT COMPUTER FAT IS.

Computer fat is created when you buy more computer than you need. With conventional computer architecture, you have no other choice. You buy the closest fit available and "grow into it."

So there is always waste and inefficiency. And you pay dearly for it.

WHAT IT COSTS.

The performance cost. With conventional computer architecture, doubling your processors does not double your performance. With Tandem, each incremental increase in processing power provides matching performance.

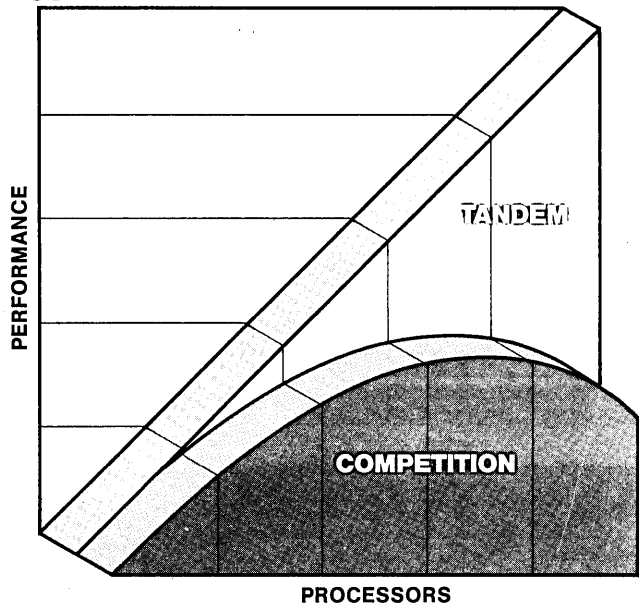

The dollar cost. With conventional computer architecture, growth is convulsive. You must continually over-invest to assure sufficient processing power. With Tandem, growth matches need. You never invest more than you have to.

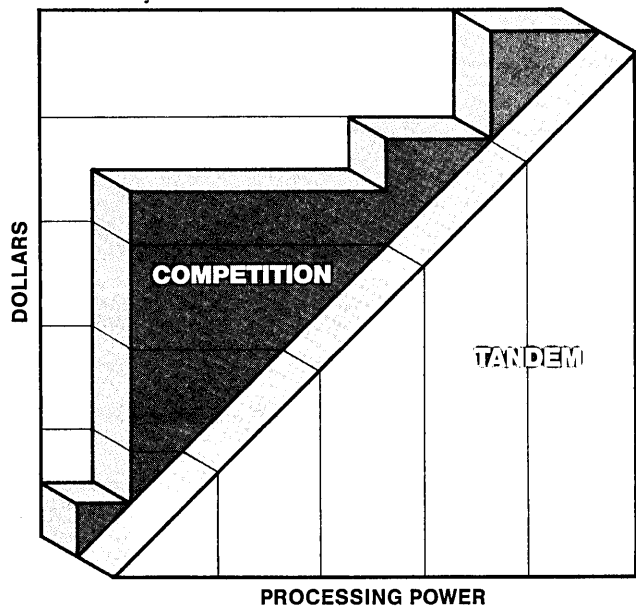

TANDEM'S NON-FAT ARCHITECTURE.

Tandem Computers has developed the ultimate system for on-line transaction processing. It is the fault-tolerant system that can grow as your needs grow, expanding at any increment you choose.

You can start with two processors and grow to 16 processors in a system. You can put in a fiber-optic link and grow to a local network of 14 systems. With a combination of land lines and a satellite link, you can expand to 255 systems (4,080 processors) worldwide.

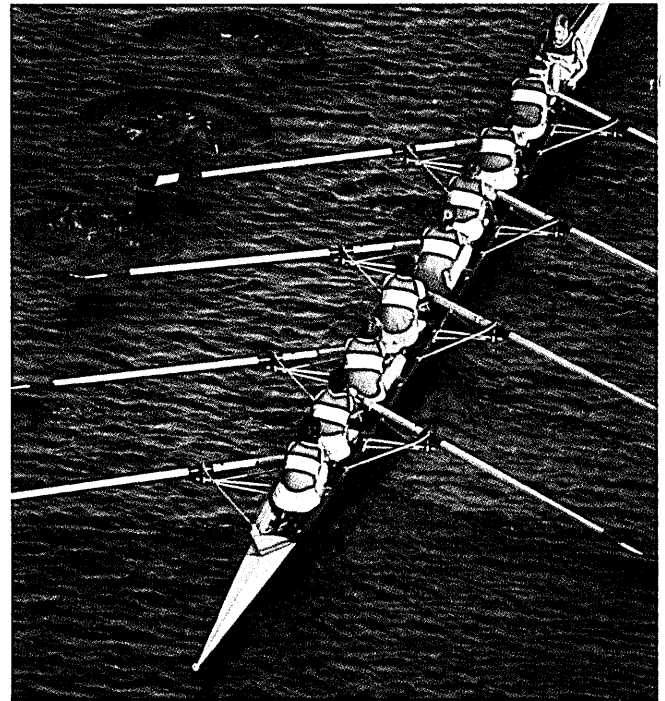

In a Tandem system, all components share the workload, and no single failure can shut you down.

With Tandem, your software expands, too. All systems work like one system, and you'll never have to rewrite a line of applications code.

The Tandem NonStop™ system is also enhanced by a high-performance, relational data base that can be geographically distributed to wherever it's needed. And no single component failure can shut you down.

LET'S CHEW THE FAT.

Tandem systems are already at work for Fortune 500 companies in banking, telecommunications, manufacturing, transportation, retailing and energy, as well as several branches of the U.S. Government.

To find out what we can do for you, call (800) 482-6336. Or write for our annual report. Corporate Headquarters: 19191 Vallco Parkway, Dept. 762, Cupertino, California 95014.

 **TANDEM COMPUTERS**

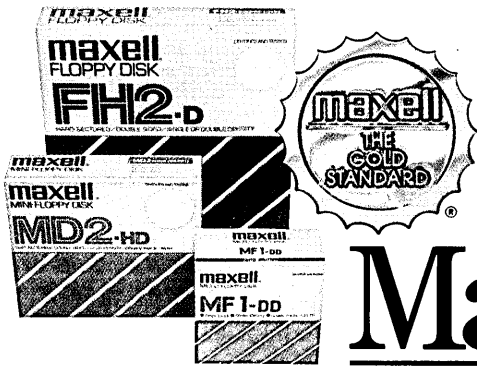

Maxell Gold.

The floppy disk
that turns Apple's
golden,
keeps AT&T on-line,
and makes every
Texas Instrument
a gusher.

Whether you're exploring for profits, reaching out for projections, or polishing your argument, there's a Maxell floppy disk perfect for your computer. Consider the unique way we pack and bind our oxide particles for quality over the long run. Or our lifetime warranty. Maxell. The Gold Standard in floppy disks. Precious metal for virtually every computer made.

maxell[®]
IT'S WORTH IT.

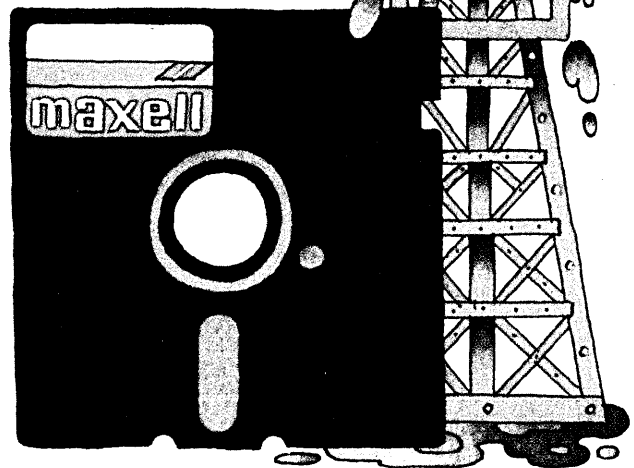

LETTERS

BLUE NOTE

In your Nov. 1 issue, you twice indicate that IBM may be on an "acquisition binge." This thought appeared in both Benchmarks and Look Ahead.

IBM has repeatedly stated that its merger agreement with Rolm represents a singular business decision that is not likely to be duplicated with other companies in the foreseeable future. Furthermore, you state in Look Ahead that Sytek sold a 6% stake to IBM. IBM does not own any of Sytek Inc. IBM purchased from Sytek \$6 million of convertible subordinated debentures. We will not speculate as to whether those debentures will be converted.

ROBERT J. SIEGEL
Director of Communications
IBM
Armonk, New York

After 20 years on the acquisitions wagon, \$2 billion recently spent for all or parts of Rolm, Intel, Satellite Business Systems, and an assortment of foreign ventures seems bingelike to us.—Ed.

GOTO DISAGREEMENT

I disagree with statements made in "Computerized Cops" by William Lewis and James Blodgett (Readers' Forum, Nov. 15). There may be some merit to the idea that GOTOS may not branch out of modules, but I doubt it. What is a module? That the quality of a program is inversely proportional to the number of GOTOS is believable to a certain extent, but GOTOS are a symptom of poor quality, not the cause.

And concurring their proposal that a certain percentage of coding must be comment lines, this standard stinks! If a programmer does not currently write good program code (self-documenting and well structured), his attempts at clarifying the muddle will only add to the confusion. Poor comments are worse than no

comments at all! If a programmer does a good job of coding a program, extra comment lines will only distract from the program logic.

WESLEY G. GEER,
Manager of Systems and Programming
Dodson Insurance Group
Kansas City, Missouri

EXPERT EXPERT

In the oversold computer world, it's nice to know that integrity can still rear its lovely head. Congratulations on your honest article, "The Overselling of Expert Systems," (Nov. 1, p. 76). I am an expert on the subject of honest applications of "artificial intelligence," although you haven't heard from me since April 1969. That month, DATAMATION published my article, "The Computer Art of Schedule Making" (p. 84), describing my promising new approach to that subject.

MURRAY SPITZER
Bethesda, Maryland

UNDERSOLD ON OVERSELLING

"The Overselling of Expert Systems," by Gary Martins, was annoying. It is hard to believe that someone who claims to understand the current gains of AI could fail to cite one of the major contributions of AI research: rules can change in a problem domain without forcing a rewrite of the program. Martins states that a knowledge engineer simply "gets information about problems and how to solve them from problem-domain experts, and embodies the information in a program."

This is *not* "precisely what us plain old programmers have always done." The point is that there is no reprogramming in an expert system; the knowledge is all outside the program.

I manage a traditional data processing operation and a staff that includes maintenance programmers. I welcome knowledge-based systems for selected nontrivial problems. Development of

these systems cannot be done with a traditional software engineering approach, as Martins would lead us to believe. Had he done his homework he would see that the "Blackboard Model of cooperating expert processes" is not just a longer name for the old COMMON storage facility in FORTRAN. He has failed to see the forest for the trees.

I am also alarmed at his reference to "university-based cognitive psychologists... implementing childish simple models of human cognition." Of course, "no one seriously claims that these models do justice to the subtlety and richness of human intellectual performance..." He should be reminded that since the beginning of the modern world the scientific method has allowed small, incremental gains to develop into in-depth understanding. The models of cognition are based on empirical data collected from human subjects. This is not to say the models are totally adequate at this stage of the research. The problems posed in human cognition are much more complex than those of the exact sciences. They are difficult to develop and must be kept at a high level of abstraction if we are to make progress. I personally prefer a "simple" model of human cognition to no model at all. I applaud the work of these scientists and look forward to tomorrow when the fruits of their labors will be of even greater benefit. On this count I could not agree with Martins more: "The lessons learned in the AI labs can become the building blocks of prodigious achievement."

TERRY L. JANSSEN
Ayer, Mass.

CORRECTION

In "Business Rules: The Missing Link" (Oct. 15, p. 145), Dan Appleton wanted to point out that "from 400 data we could create 10⁸⁶⁹ informations." We inadvertently rendered this as "10,869 informations."—Ed.

WANDA

THE UNIVERSITY OF MICHIGAN LIBRARY
ANN ARBOR, MICHIGAN 48106-1000
TEL: 734 763 1000 FAX: 734 763 1001
WWW: WWW.LIBRARY.MICHIGAN.EDU

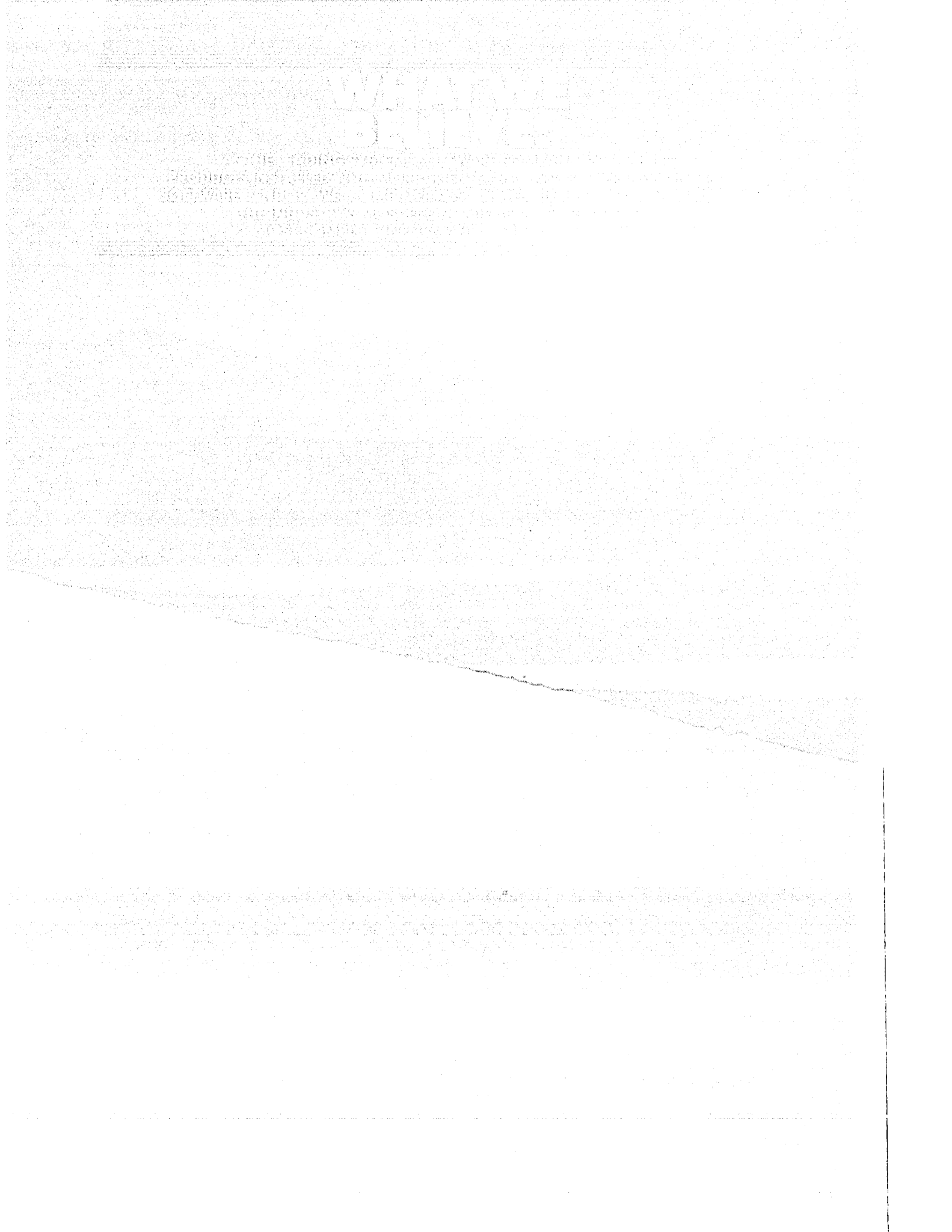

CONVERTING AND GAINING VALUE™

FROM MAINFRAME TO PC

FOR THE BUSINESS DEVELOPER

Computer Associates International, Inc. (CAI) has a proven track record of providing software solutions for business developers. Our software solutions are designed to help you manage your business more effectively. Our software solutions are designed to help you manage your business more effectively. Our software solutions are designed to help you manage your business more effectively.

Computer Associates International, Inc. (CAI) has a proven track record of providing software solutions for business developers. Our software solutions are designed to help you manage your business more effectively. Our software solutions are designed to help you manage your business more effectively. Our software solutions are designed to help you manage your business more effectively.

This is a proven total operation by far the most effective information center solution available from both the desktop domain with program-based "building block" type products. And it's better for you, for example, for program-based and desktop programs at both the PC and mainframe levels. And instead of a multitude of different products, parameters, data formats, and

formats common to both products. The entire system is portable across IBM/OS, MVS and VM environments. Leave the past behind. Start your Information Center by calling us at 800-645-8008, or (in NY) 516-833-6700 and ask for Denis Williams.

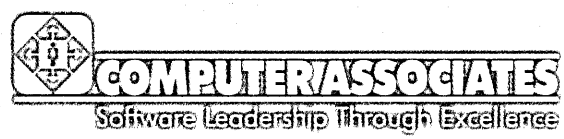

© 1985 Computer Associates International, Inc.
125 Jericho Turnpike, Jericho, NY 11753

CIRCLE 15 ON READER CARD

For Disk Subsystem Reliability There's Only One Clear Cut Choice

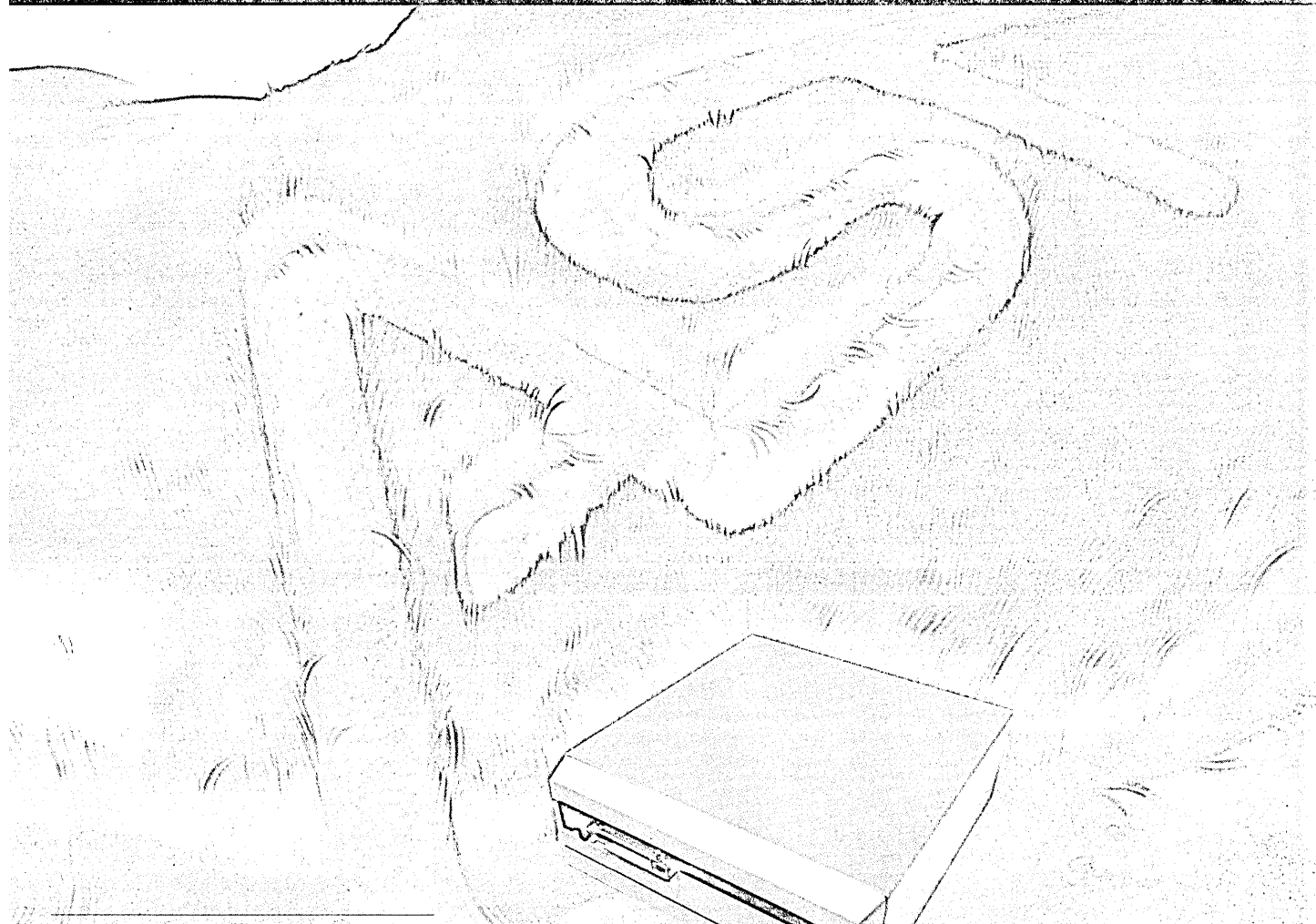

Introducing Colossus™

When it comes to reliability, we've cut our own path. The AST reputation is built on quality, and Colossus, our new disk subsystem for the IBM® PC, XT and AT, is no exception. Each and every Colossus feature from system architecture to backup capabilities, component integration and workmanship is designed to provide you with the product and data reliability you need.

And with an average access time of 30 milliseconds and direct disk to tape data transfer at 5Mb per minute, this 67Mb disk subsystem with 60Mb streaming tape cartridge backup is the choice for performance too. Easy to use, Colossus is perfect for your large data base, multi-user and local area network applications and will also backup the IBM internal drive when installed in an AT or XT.

Advanced Architecture. Colossus uses state-of-the-art SCSI (Small Computer Systems Interface) architecture. A high performance bus, Colossus' SCSI design provides extensive operational error identification and recovery,

automatic disk media defect management, intelligent peripheral controllers to off-load housekeeping from your PC's CPU and a self-test at power-on. So problems are diagnosed before faulty operation occurs, operational errors are recovered and data errors associated with bad disk track maintenance are eliminated.

The ideal long term solution to your storage requirements, Colossus is easily upgraded as your needs increase. Our SCSI expansion port lets you connect AST 70Mb or 140Mb expansion disk systems for up to 700Mb of additional storage as well as other SCSI peripheral devices. And Colossus is specially designed to be compatible with local area networks such as AST-PCnet II.™

Data Integrity. 32-bit error checking and correction (ECC) on disk data, and read-after-write and 16-bit cyclic redundancy checking (CRC) on tape data assures reliable data storage on both the disk and tape backup.

For ease of use, Colossus' tape

backup allows streaming image or file-by-file tape backup operations with a choice of menu or command driven software operations. Industry standard tape format means media is transportable for access on other systems too.

Modular Construction. Pop-in sub-assemblies make enhancement and maintenance with Colossus literally a snap. You save money on repairs, and your downtime is significantly reduced.

Built By AST. Our exceptional quality is a result of extensive testing and comprehensive burn-in procedures. And don't forget our service, customer support and six-month warranty. For more information call our Customer Information Center (714) 863-1333, Ext. 5249.

Or write, AST Research, Inc.,
2121 Alton Avenue,
Irvine, California 92714
TWX: 753699AST UR

CIRCLE 16 ON READER CARD

AST
RESEARCH INC.

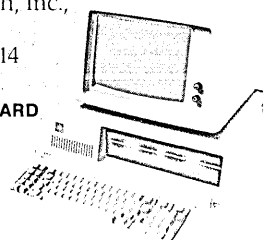



HARDCOPY

ALL THAT GLITTERS



ILLUSTRATION BY MITCHELL RIGIE

Deep in the rain forest of the Brazilian frontier, there's a gold rush going on. Thousands of men from all over the country are digging away in vast pits, hoping to stake a claim. Some don diving suits to vacuum precious gravel from fierce Amazonian tributaries. A few strike it rich; many find enough gold to live riotously well for a week; many more find nothing. Always there is the fevered atmosphere of the rush—the planes buzzing from site to site, the thrill of the quick strike, the bitterness of failure, the sprawling shantytowns with their motley populations and liquor and violence.

Does this sound like the computer business to you?

If it does, maybe that's because the computer business has a few things in common with a gold rush. An industry that goes from no dollars to \$130 billion in a little over 30 years is bound to generate some feverish expectations—and dash a few hopes—along the way.

Dashed hopes, and what they can teach us, are the theme of this issue. In "Learning from Lemons" (p. 72), longtime industry observer Philip Dorn examines nine of the more significant vendor failures of the last 20 years. In "Alas, Poor Visicorp" (p. 93), Efrem Sigel describes the meteoric history of the microcomputer software industry. And in our In Focus, "Probing PCM Perils" (p. 30), three authors examine the prospects for plug-compatible peripherals makers in the wake of StorageTek's entry into Chapter 11 proceedings last fall.

All in all, it's an impressive list of crashes and flops. Why did we put it together? While we admit to a normal human fascination with bad news, we also figure we've accomplished something constructive. The user community, after all, is not exactly uninvolved when vendors fail. When a major supplier reorganizes, shrinks, or goes out of business, users may experience all sorts of difficulties (see Nancy Welles' "Raising an Orphan," p. 85).

But the most important consequences are felt in the longer term. Whatever the mistakes that ultimately laid them low, a great many of the companies discussed in this issue made lasting contributions to the industry. Every sizable IBM customer is better off because of what StorageTek accomplished in peripherals, and without Visicorp, corporate microcomputing might not even exist. The old saw bears endless repetition: competition benefits the customer.

This is especially relevant right now, when the women and men who make information processing work are confronting some of the greatest challenges they've yet encountered. Office automation is finally becoming a serious pursuit. Networks that were barely thinkable ten years ago are coming to be seen as vital corporate tools. There are huge databases to be managed, complex new applications to be designed, and oceans of old software to be enhanced and maintained. These are tasks that cry out for new approaches, and without competition, the requisite innovations may never occur.

DATAMATION advisory board member Angeline Pantages points out that "dp people are conservative, as evidenced by IBM's market share." They have to be, because there's so much at stake. But she argues that "it behooves them to take some chances, because it's in their interest to have new, innovative firms succeed." She isn't talking about blind chances; she simply recommends that users make an informed assessment of what newcomers offer in the way of benefits—and risks. Users are best able to do this if they have some knowledge of why firms succeed, and why they fail. That's why we feel the lessons in this issue are important.

As long as there's gold on the frontier, pioneers will rush out there to try to claim it. Some of them, it's true, are doomed to disappointment, but even they are helping to build something. The forty-niners made a contribution 125 years ago in California, and the *garimpeiros* are making one right now in Brazil. The computer industry needs dreamers, too. ©

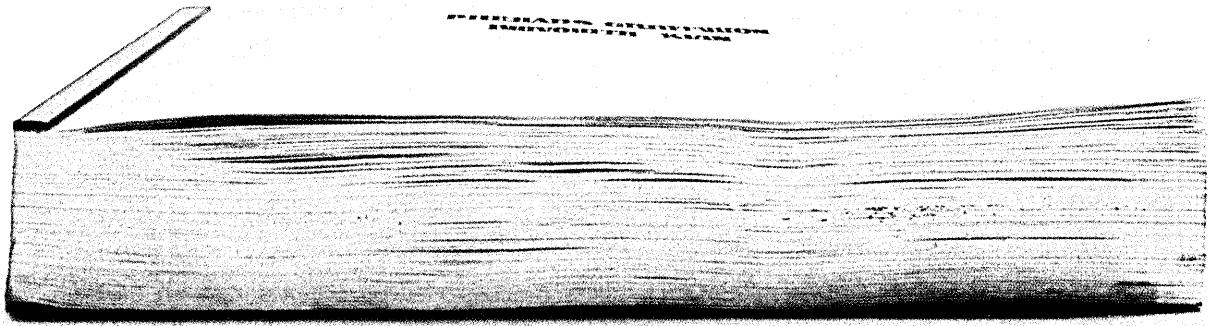

Compared with some financing documents

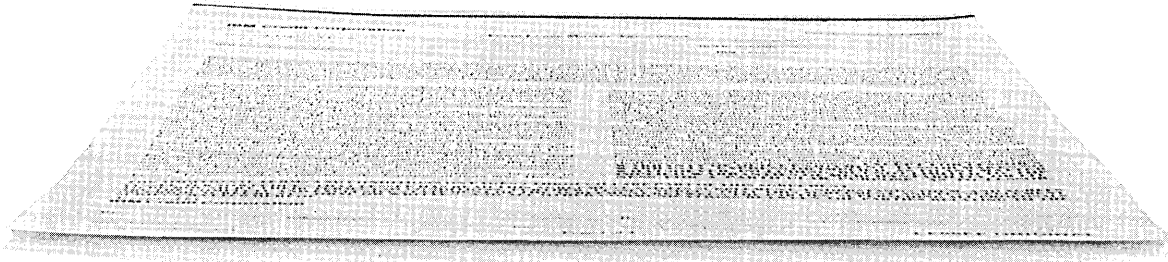

...ours is only a little boring.

An IBM Credit Corporation master agreement is a mere four pages long.
What's missing?

Mostly the same thing that's missing from our whole financing process:
unnecessary work.

To begin with, you don't need to deal with a lot of people to get the IBM
computer you want.

The same IBM marketing representative you see for your IBM equipment
can arrange financing for it, too.

But don't think that less work means less flexibility. You can choose the
financing that's best for your company from our wide range of lease or
installment purchase options.

You don't have to give up low rates either. We're competitive.

We've even made sure financing that starts simple, stays simple. A
supplement to your original contract is all it takes to add or upgrade equipment.

If a financing process that's less of a process interests you, call your
IBM marketing representative and ask about the IBM Credit Corporation.
Or call 1 800 IBM-2468 Ext. 82, code AL.

See how simple financing can be.



INFOCUS

PROBING PCM PERILS

A special report on the troubled plug-compatible marketplace examining the obstacles and rewards faced by survivors.

In the decade and a half since pioneers like Storage Technology Corp. and Amdahl Corp. created the plug-compatible manufacturer (pcm) business, vendors of computer and peripheral equipment designed to be plug compatible with IBM gear have frequently swung from the heights of success to the depths of disaster, and back.

To an unprecedented degree, the remaining pcms no longer can be discussed as an undifferentiated whole; firms like StorageTek and Control Data currently face bleak long-term prospects, while others, like Fujitsu and Hitachi, seem to be on the verge of major successes.

In this special report, DATAMATION examines the fragmenting pcm business: are its current woes merely a cyclical downturn or do they portend the demise of the pcm industry? Who can survive, and how can users cope?

In the first segment, Tokyo bureau manager Thomas Murtha looks at the high-flying Japanese pcms: can they expand their U.S. base, and if so, how? Then David Stamps probes the remaining American pcms: can they maintain profitable businesses or will they succumb to IBM and the Japanese? In the third segment, contributing editor Hesh Weiner examines StorageTek: can it pull itself together? How will its bankruptcy filing affect the other pcms—and the users? Finally, Los Angeles bureau chief Edith Myers surveys users of pcm equipment to assess how the fragmenting, disarrayed pcm market affects their dp installations.

JAPAN'S DYNAMIC PCM DUO

by Thomas Murtha

The demise of Storage Technology Corp. and the withdrawal of Control Data leave the global dp industry looking to Japan's two persistent pcms, Fujitsu Ltd. and Hi-

tachi Ltd., as the principal sources of IBM-compatible equipment.

"Fujitsu is not changing its strategy or tactics because of StorageTek's bankruptcy," states a top executive in Fujitsu's overseas marketing division. "Since the nature of Fujitsu's pcm business means following IBM, we must provide better price/performance and reliability. I am confident we can."

Such statements are hardly unexpected. But the evidence shows that either Fujitsu or its American partner, Amdahl, has been willing to cut profit margins to deliver price/performance. Following IBM's lead, Amdahl quickly responded with price reductions for cache memory and large-scale disk drive controller upgrades. Hitachi and other compatible drive competitors had yet to follow suit as of press time.

Hitachi Ltd.'s pcm partner, the National Advanced Systems (NAS) unit of

Both Hitachi and Fujitsu are rolling in yen thanks to surging sales in semiconductor, office automation equipment, and computers

National Semiconductor, should soon get a boost. Hitachi plans to put into production a 16-channel 32MB plug-compatible disk controller. A spokesman for the computer division of Hitachi's Overseas Operations Department professes its American partnership is healthier than ever. "I don't think there has been a substantial shakeout [in the American pcm business]. As far as Hitachi is concerned, our oem partner is growing steadily. Because competition is tough, Hitachi is reinforcing its ties with NAS."

But in Japanese business circles everyone knows the difference between *honno* (reality) and *tatemae* (appearance). In reality, analysts in Tokyo speculate that Hitachi and Fujitsu have plans to go beyond OEMing, eventually to sell in America under their own names. Still, it's unlikely they would dispense with their oem partnerships. If IBM accelerates price reductions, Hitachi and Fujitsu need greater economies of scale to follow suit. Both companies can produce more than their present oem channels can absorb. Present partnerships would play second fiddle if a better opportunity were to appear.

Industry sources report that Hitachi has looked into purchasing a chunk of Storage Technology in order to expand its sales base in the U.S. At press time, Hitachi's risk-averse window-shopping seems unlikely to result in any deals. "The question is how highly Hitachi evaluates Fujitsu's relationship with Amdahl," posits Peter G. Wolff, an analyst with Prudential-Bache Securities in Tokyo. "Hitachi

ILLUSTRATION BY DANIEL ADEL

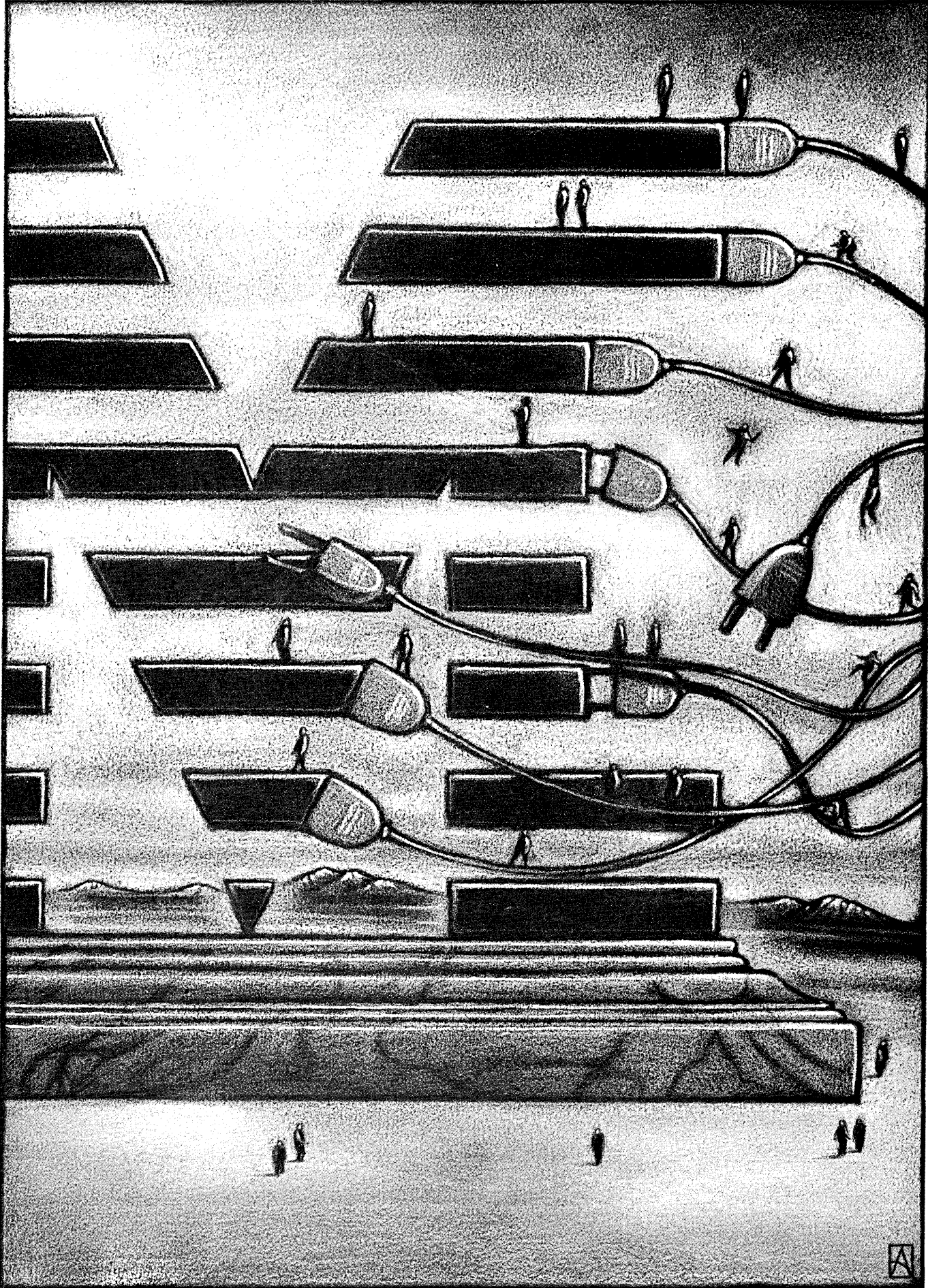

IN FOCUS

isn't looking to expand its U.S. sales base without a guarantee of increased profitability. Storage Technology only offers a liability."

Both Japanese firms are rolling in yen thanks to surging sales in semiconductors, office automation equipment, and computers. Fujitsu and Hitachi chalked up profit increases of 35% and 65%, respectively, for the first half of FY '84. Even after substantial payments to IBM for copying programs, each firm's computer division is still profitable. The cash is available for acquisitions but neither firm seems eager to make the move.

Fujitsu's 49.5% equity share in Amdahl provides considerable influence

IBM is after the Japanese magic. Peripherals made by IBM lack the sparkle and performance of compatible equipment made in Japan.

over the strategic planning for its main American oem customer. Three Fujitsu executives now sit on the Sunnyvale, Calif., firm's board of directors.

"If Fujitsu has too many problems with Amdahl, buying them out would get rid of the headache," speculates David Keller, a securities analyst at the Tokyo office of James Capel & Co. "The other alternative is very unlikely. Pulling out and developing their own sales and support channels for the pcm systems market in North America and Europe would be very risky and expensive. Fujitsu is too sensible and conservative to make any rash moves."

Fujitsu denies exercising any control over management at Amdahl. "We believe Amdahl is completely independent of Fujitsu's control," the Fujitsu executive asserts. "We have no intention of interfering with Amdahl's management. We simply provide Amdahl with highly reliable products that are conceived and designed by Amdahl. If you want to know Amdahl's plans, please ask them."

In Japan, Fujitsu supplies integrated systems ranging from supercomputers to microcomputers. The software and support required make it unlikely that Fujitsu will offer such systems independently in Europe and North America. "We have no plans for establishing companies where we already have partners," says the source at Fujitsu.

Where the market is less developed or when invited, Fujitsu and Hitachi go in bearing their own colors, ready to develop distribution and service networks. Last autumn, the Australian government gave Fujitsu a favored supplier designation. The firm now has subsidiaries in Australia, Brazil, the Philippines, Singapore, South Korea, and Spain.

China has 24 Fujitsu mainframes on order, and a software development project is under way between Fujitsu and China. Yet so far the Japanese makers have been reluctant to follow IBM's lead by transferring technology and setting up manufacturing facilities there. Hitachi exports under its own name to China, Southeast Asia, Hong Kong, Taiwan, and Korea.

But what do Asia, Australia, and South America have to do with the American pcm business? "It all boils down to economies of scale," explains Hiromichi Yui, president of the Tokyo consulting firm YDO K.K. "Japan's pcms always have tried to be ready for IBM's next round of aggressive pricing and new products. You have to consolidate a sales base before you can justify the production run that brings unit costs down. A pcm's value added can either come from sales and service or from manufacturing. Clearly, both are desirable."

Yui, who spent eight years following the industry for the Boston Consulting Group, continues, "Since Japanese manufacturers want to produce more to bring down unit costs, they want to sell as much as possible to everyone. But it's not easy to create marketing and service channels overseas, so they are glad to sell oem. After all, there's no magic contained in the hardware. For Japanese pcms, the magic that gives them an edge is their production know-how."

Exchange rates also help Japan's pcms to work a little magic. "Because Fujitsu and Hitachi have a strong domestic sales base, the weak yen gives them room to move on their pricing," Prudential-Bache's Wolff points out. "Profitably selling more than 70% of their IC production outside the firm doesn't hurt either. They can design in-house the ICs that give their compatible equipment outstanding performance characteristics and still make it profitable."

The quest for economies of scale is turning Japanese pcms into component suppliers, especially for overseas customers. Hard disk storage devices have become cash cows for manufacturers in Japan. Their next target is optomagnetic disks. "Hitachi appears the closest to mass production of optical storage equipment," Keller of James Capel forecasts. "They've perfected the technology on the workbench. The problem is now one of scale. If customers look like they want them right now, there could be volume shipments by the end of 1985."

Optical storage technology is another type of magic that Japanese pcms may want to keep at home, although StorageTek is marketing a similar system. Other key production technologies—spattering, vertically magnetized film,

and disk plating—aren't likely to show up in Fujitsu's new factory in Portland, Ore., until they lose their strategic importance.

IBM is after the Japanese magic. Peripherals made by IBM lack the sparkle and performance of compatible equipment made in Japan. One solution is for IBM to expand its manufacturing facilities in Japan. "If IBM wants to produce its hardware in-house, Japanese pcms are going to dig in for a tough fight," Yui of YDO K.K. claims. "My guess is that IBM will try to buy from Japanese pcms. It's quite possible IBM could even oem from Fujitsu and Hitachi."

IBM has reportedly already succumbed to the temptation. Hitachi is rumored to be doing some of the CMOS work for IBM's new transportable computer now being developed in Japan. Sharp is reported to be doing the display technology. IBM's Japanese workstation, the 5550, is manufactured by Matsushita, Oki, and Alps. Through buying from Japanese hardware makers, IBM can stay in the higher value-added software market. Japanese pcms can expand their sales base and bring down prices.

"It's much to our regret that IBM has not approached us to buy our products," the Fujitsu executive admits. "At the same time, we realize that IBM's monopoly will lead to a deterioration in customer service. Offering an alternative to IBM is the main reason we're in this crazy business."

Although IBM might actually consider developing some oem arrangements with Hitachi and Fujitsu, the scenario is far from finished. Even if a few oem deals materialize for the pcms with IBM as the customer, it doesn't mean they have conceded value-added sales and services to IBM. Unless IBM can surpass Japanese companies in production technology, the pcm market for storage peripherals is likely to remain a stronghold for Hitachi and Fujitsu.

HANGING BY A THREAD?

by David Stamps

It has become something of a recurrent ritual. Each time another plug-compatible equipment manufacturer—Magnuson or Itel, for instance—is knocked out, the question is raised, "Does the pcm business really have a future?"

Now that Storage Technology Corp. is a \$1 billion bankruptcy, the ques-

WHEN IT COMES TO LINKING PC'S TO MAINFRAMES, ONE COMPANY IS A MILLENNIUM AHEAD.

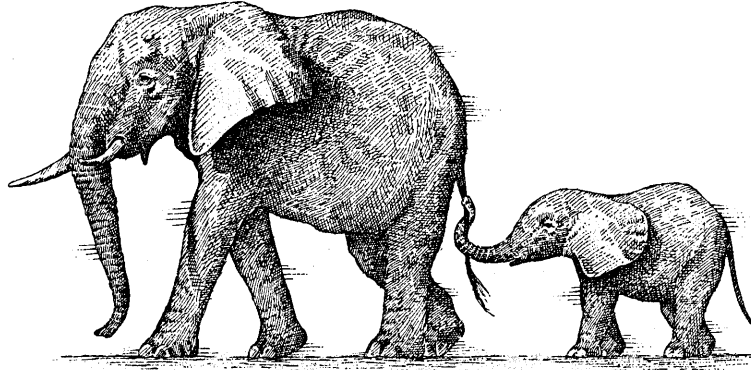

You don't have to look hard to see why McCormack & Dodge has linked more PC's to more mainframes than any other business software vendor.

It's a classic case of a superior product leading to superior sales. A product that lets your PC access all company business applications, no matter who designed them—not just applications designed by McCormack & Dodge. A selective system that lets you pinpoint and summon exactly the portion of data you need.

And when you've made your selection and massaged the numbers the way you want them, our link lets you upload the new material back to the mainframe (assuming you have the proper security clearance). You do it yourself on the spot—in real time. Without keyboard operators or programmers. So the entire company has the benefit of the latest information immediately. Not days later.

The M&D PC link is one of several products in our highly acclaimed Millennium family of borderless business software. One more reason why we're a Millennium ahead.

WHEN YOU THINK ABOUT TOMORROW, MILLENNIUM MAKES SENSE TODAY.

McCormack & Dodge

DB a company of
The Dun & Bradstreet Corporation

McCormack & Dodge Corporation, 1225 Worcester Road, Natick, MA 01760
Sales and support offices throughout North and South America, Europe, Asia, Australia and Africa. 800-343-0325. Telex: 710-325-0329

CIRCLE 18 ON READER CARD

IN FOCUS

tion of the American pcms' viability has again been raised. And once again the prognosis from securities analysts and industry observers is grim.

"Is there even a plug-compatible industry left?" asks Richard Hastings, vice president and analyst at Merrill Lynch. "The outlook for the plug-compatible peripheral business in particular has never been that great, given its ups and downs," he observes. "It's always been a parasitic business to some extent. Now, with IBM's new aggressiveness, and the prices so low, it really looks like IBM could have the business all to itself if it wanted." As it is, IBM has about a 95%

"Look at Trilogy. That is a reflection of the way the market has changed. Gene Amdahl could have pulled it off 10 years ago, but not today."

share of installed 3380-type systems, analysts say.

"Storage Technology is probably a dead duck and I can't see anyone stepping into the market to take their place," Hastings adds, "unless it would be the Japanese. They do some strange things."

Michael Geran, an analyst at E.F. Hutton, adds, "I don't know that IBM will get all the business, or just a higher share of all the profits." The pcm business will never be what it was, he adds, but that may not matter. "You don't need 10 different plug-compatible disk manufacturers; three may be adequate to supply all those who feel they need nonbrand name equipment."

Brian Jeffery, director of research at the International Technology Group, Palo Alto, agrees that the heyday of the pcm business is probably over. "Look at Trilogy," he says. "That is a reflection of the way the market has changed. Gene Amdahl could have pulled it off 10 years ago, but not today."

The existing pcms may stick around, Jeffery predicts. Amdahl and National Advanced Systems (NAS) in particular seem stable because they have major Japanese manufacturers backing them. "If they've stayed the course with IBM through the 308X series, they'll probably survive the Sierra," IBM's upcoming high-end mainframe series.

Memorex is likely to persevere in the disk area also, "so long as they don't get overly ambitious or make any of the mistakes StorageTek made," Jeffery says. "But I don't think you'll see much growth in this market. Don't look for any major new participants."

Not surprisingly, the pcms themselves take a much less pessimistic view; Memorex, the unit of Burroughs Corp. that stands to be the sole surviving Amer-

ican pcm disk manufacturer, is positively sanguine about its prospects.

"There is plenty of life left for the pcms," says Geoff Seabrook, vice president of planning and program management for storage equipment at Memorex Corp. Seabrook even thinks that new companies may enter the market to take the place of his company's two pcm competitors, StorageTek and Control Data.

"Even IBM's aggressiveness won't scare people away from a market with as many zeros behind it as this one," he says.

In the meantime, with StorageTek wounded and CDC gone, Memorex sees 1985 as a year of great opportunity. "I do not think the loss of those two is going to cast such a pall on the market that customers will be scared away from pcms," Seabrook says.

Memorex shipped only an estimated 1,000 3380-type disk units last year, compared to 35,000 for IBM, according to Seabrook. He says the company has never aimed for a major piece of the market. "Storage Technology wanted 35% of the market; we're happy with 10%," he says. "We are just now reaching the top of our manufacturing ramp. We haven't decided if we'll try to increase 1985 capacity to take up the slack left by CDC and StorageTek."

Even as it builds its 3380-compatible business, Memorex will have to consider the likelihood of IBM introducing a new increased-density version of its 3380 disk. Though most analysts are predicting that IBM will bring out a new 3380 product, Seabrook says he's not convinced.

"IBM is a rational company. They'll do only what they need to do. They can make more money by sticking to a single-density product. They could pass up the double-density 3380 altogether, just as they passed up a double-density 3350."

Memorex nonetheless has a 1.6 density version of its own 3380-type product running in the lab, Seabrook says. "A 1.7 density version would be a little more difficult, and a true double density would be tough, but neither would be impossible."

Another potential IBM move that may cause jitters at Memorex is an additional price cut. Some analysts now speculate that IBM has cut the profit margins so low—not only on disk units but on all hardware—that it will be virtually impossible for the low-volume pcms to make any money in the business.

Seabrook declines to reveal profit margins, or even to say whether Memorex pcm margins are, as some analysts estimate, much lower than those of Burroughs in general.

"You can still make respectable money at the pcm business," Seabrook

contends. "Don't believe anyone who says IBM has cut its margins so close to the bone that there is no room for profit. IBM is not making the obscene profits it used to, but the margins are not that low." Then again, because of its volume, IBM can turn a profit at a lower unit cost than a pcm.

Amdahl and NAS, which have the support and backing of Japanese giants Fujitsu and Hitachi respectively, can claim something of a cushion against IBM's margin-cutting tactics.

"Hitachi is a \$20 billion company—half as big as IBM and more than twice the size of StorageTek and Control Data put together. That makes us a little different," says Francis Ma, market analysis manager for NAS peripherals in Mountain View, Calif.

Another point of difference between the IBM and NAS products is that the Hitachi disk product uses older ferrite head technology, not thin-film technology. The older technology is more reliable, Ma says. (Indeed, according to the Reliability Plus software package from Uccel Corp., Dallas, NAS's reliability has surpassed IBM's in the 3380-class of machines, despite being only one-fourth as reliable in June. See "Hard Facts About Hardware Reliability?" Oct. 1, p. 82.)

What's more, Hitachi has assured NAS that it can squeeze enough additional performance out of the ferrite technology to match the expected increased density 3380 from IBM, according to Ma.

NAS, which shipped 3,000 3380-type disks last year, says it expects to ship somewhere between 4,000 and 5,000 in 1985. Whereas only about a third of the 1984 shipments went to non-NAS main-

"IBM is a rational company. They'll do only what they need to do."

frame customers, the mix will be about half-and-half this year, Ma says.

John Taffinder, NAS director of systems planning, cites the same factors—the critical mass and the close technical support of Hitachi—as reasons for sales of its 8000 and 9000 series mainframes being up about 35% in 1984 over the previous year. "Look to Amdahl more and more to lean to Fujitsu for the same kind of support we get from Hitachi," he predicts.

Richard Whitcomb, Amdahl's director of financial and public relations, acknowledges that Fujitsu's 49.5% share in the company "is very supportive in terms of our needs," but declines to comment on whether the status of the Amdahl-Fujitsu "interrelationship" could change any time soon.

Amdahl last year shipped less

To some, it's just a racquetball they're belting. To others, it's Driscoll in the MIS group.

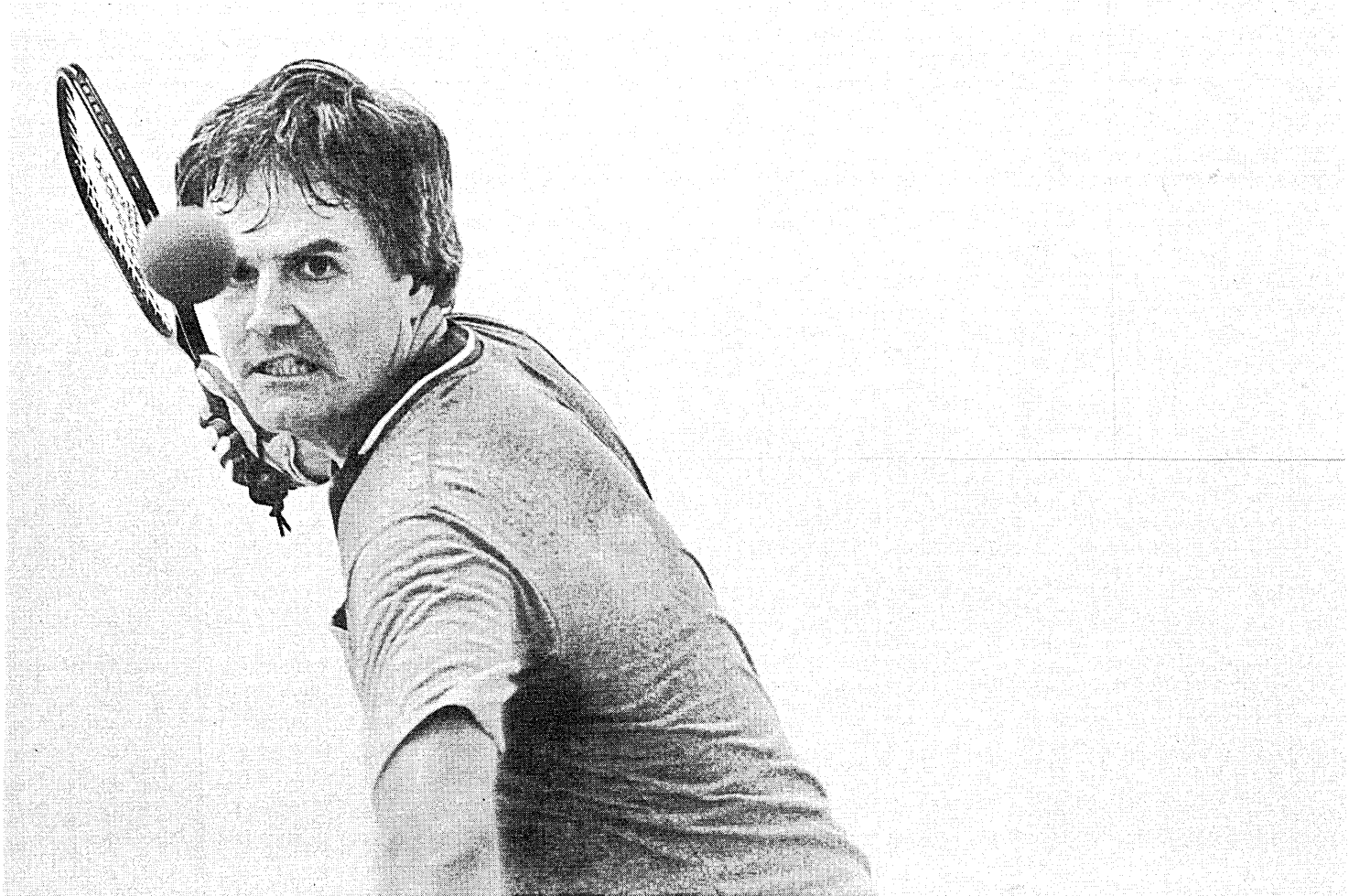

You know Driscoll. Every big organization has one. He's sitting on the second-largest computer system in the Free World; he's the only person in the place who can make it work; he's got an applications backlog stretching to 1988, and it's gaining on him.

By any chance, is your name Driscoll?

THAT'S ANOTHER REASON WE CREATED COMMAND CENTER.™

To leverage the investment you've already made in hardware and software.

To telescope the database and give the non-technical end-user direct access to precisely the information that he or she defines as critical to success: selected summaries; financial reports; sales tracking; variances from budgets, benchmarks or expectations; etc.

Without any wasted etc.

COMMAND CENTER: THE FIRST TRULY PRACTICAL MANAGEMENT INFORMATION CENTER.

It's a single, on-line, user-defined, distributed software system that resides on both the company mainframe and the manager's IBM® PC. It monitors 360° of internal and external data; then extracts, filters and compresses it to dramatically reduce workload.

It's the first executive-oriented system that's actually operational—without needing a Britannica's worth of documentation, or even a keyboard, to operate it.

It should interest anyone in management who feels that, while everyone else in the organization has a computer-aided career, he himself is somehow being cheated.

It should interest anyone in MIS who feels, as we do, that the future belongs to the heat-seekers.

We're in Boston, at (617) 350-7035.



Tracking and control for top management.

40 Broad Street, Boston, MA 02109.

IN FOCUS

than 3,000 of its 6280 and 6380 high-performance disk units. But, like NAS, it saw an increase in shipments of its 580-series mainframes (approximately 20% over 1983). Given the price pressure from IBM recently, however, analysts generally suspect that Amdahl must be taking some heat financially.

Indeed, Amdahl's revenues were down 10% and earnings were off 40% in the quarter ended last Sept. 30 from the same period in 1983. Moreover, Amdahl's net margins are hovering at only about 2.5% of revenue, compared to 6% in 1981. Whitcomb contends, "Against the ferocious price competition from IBM, 1984 was not a bad year." Still, he concedes that there is an ominous side to IBM's new aggressiveness.

"It's not the IBM of three years ago," Whitcomb says. "They are extremely aggressive and in ways that were unheard of. They are targeting countries, they are targeting industries, they are targeting specific customers. They've steadily increased their market share against the BUNCH companies and will continue to do so. Whether or not they increase it against the pcms is an open question, but it's going to be a rough job to compete against them."

Yet IBM probably does not target its specific victims, analyst Jeffery says. "IBM went after a volume sales strategy. It decided it needs high-volume sales to stoke the \$46 billion furnace. Almost incidentally, the competition got stomped."

But according to Jeffery, there is another aspect to IBM's new aggressiveness that could spell the end of the plug-compatible industry. "One thing that has specifically hurt the plug-compatible peri-

There is another aspect to IBM's new aggressiveness that could spell the end of the plug-compatible industry.

pherals industry," he suggests, "is that ever since the Justice Department dropped its antitrust suit three years ago, IBM has been much quicker to take legal action against startups. He points to Cybernex and Tridata, both of San Jose, as cases in point.

"That is a far more serious fact than many people appreciate," Jeffery says. "It has effectively and legally stopped the migration of thin-film technology out of IBM's San Jose disk facility. The plug-compatible industry has always depended on spin-offs out of IBM. Had IBM taken the same tough approach in the 1970s, there might never have been a plug-compatible industry."

And there is even more bad news for the pcms, according to analysts. Bob Djurdjevic, president of Annex Computer

Research, Phoenix, points out that IBM's conversion of its rental revenues into purchase revenues is nearly complete; by the end of 1984, the ratio was 81% purchase to 19% rental.

"The bad news for the competition," Djurdjevic says, "is that IBM is looking to replace its lost rental revenues through increased software revenues, such as the threefold price increase it charges for the conversion from MVS to MVS/XA."

If the high software costs mangle data processing budgets to the point that there is a resulting softness in the demand for new hardware, Djurdjevic says, "then look for IBM to drop the prices on hardware even more than it has up to now."

And yet not all pcms are feeling the big squeeze. Tulsa, Okla.-based Telex Corp. has recently been able to compete successfully with IBM at its own low-cost, volume hardware sales game. Yet that ability does not come cheaply. George Bragg, chairman and president of the Telex Computer Products subsidiary, estimates that the company has spent over \$100 million in the last four years to install new manufacturing equipment and to upgrade its own internal MIS systems.

"We believe that we are now the lowest-cost producer in the industry, next to IBM, that is," says Bragg. "Because of its volume, IBM still has about a 20% cost advantage over us." What Telex yields to IBM on the production line, however, it recovers in increments elsewhere: 4% less on R&D costs, 2% less for marketing, and so on.

That Telex spends only about 5% of its sales and service revenues on product R&D illustrates the company's focused product strategy, which Bragg defines as "box-to-box compatibility rather than systems compatibility." Telex and Memorex are alone among the major pcms in following that approach, he says. The strategy has been most successful in the terminals market, where firms like Lee Data, ITT Courier, and Raytheon have taken a systems approach and accordingly have had to spend money on internal protocol development.

"That can be dangerous unless you happen to be in a very specific vertical market," Bragg says. "A good example is the airline industry, which does not use SNA. That's why Raytheon did very well in that market, while its overall 3270 business was weak." Early last fall Raytheon sold its computer business to Telex.

Analysts expect that Telex's 1985 earnings will exceed 1984 figures by about 40%. It is only in the past year, however, that Telex has enjoyed such success, following its abandonment of its tape drive business. The decision to focus on terminals alone and to upgrade pro-

duction facilities has enabled Telex to grow dramatically, and with the acquisition of Raytheon the firm is looking ahead to 1985 revenues of \$600 million.

As for IBM's activities in this area, Bragg says, "for the past several years, IBM hasn't done anything in the market that hasn't been based on cost factors. They are very competitive, and they still have the historical view that 100% of a market is their fair share. But they aren't doing anything unfair, such as in the late 1960s when they were actually targeting the competition."

While Telex has been successful competing against IBM, other terminal

IBM is very competitive and they still have the historical view that 100% of a market is their fair share.

manufacturers have not escaped the industry leader's aggressive moves. Lee Data Corp., Minneapolis, one of the highest of fliers during the first four years that it competed against IBM, saw its earnings take a 150% tumble in the quarter ended last September. The drop, Lee Data's second consecutive loss, came six months after IBM announced its new 3178 terminal line, which effectively eliminated the feature advantages offered by Lee Data products. Throughout 1984, the higher sales volume that Lee Data had projected failed to materialize.

"Yes, we've felt the impact of IBM's new aggressive actions," says Fred Sweeny, Lee Data's senior vice president of marketing. "We've had to make some changes so we don't catch pneumonia every time IBM sneezes." Lee Data has tried to adjust by bringing out its own new products, such as a windowing package that lets a terminal run four sessions and a voice/data workstation concurrently.

"By going back to selling products with features not offered by IBM, we can keep our margins higher," Sweeny says. "We don't have to compete exclusively by selling below IBM's price."

The company has also tried to diversify away from its terminal product line. Last year it purchased Visual Technology, a Tewksbury, Mass., maker of asynchronous terminals for the non-IBM market. "We'll look at other companies too," Sweeny says.

Analysts are quick to point out that diversification is not necessarily a shield against IBM. It was, after all, when StorageTek tried to diversify into other areas that it lost control of its tape business, the one area in which it had been successful.

"Today, the problem for the pcms is compounded by the fact that IBM has left the margins for error very small,"

WHY WAIT A YEAR FOR THE VAX 8600?

	ELXSI SYSTEM 6400 NOW.	VAX 8600 LATER.
Availability	Now	9 to 12 months ARO
CPUs Delivered	80	None
Price	From approximately \$369,000	From approxi- mately \$450,000
Performance	6 to 60 MIPS	4 MIPS estimated
Expansion	10 CPUs	Single CPU
Interconnectability	Tightly coupled	Loosely clustered
CPU Cycle	50ns	80ns
Word Size	64 bits	32 bits
Bus Speed	320 Mbytes/sec	26.8 Mbytes/sec
Memory Expansion	Up to 192 Mbytes	Up to 32 Mbytes
Floorspace	Up to 5 CPUs per 59x32x70" cabinet	1 CPU per 60x30x74" cabinet
Operating System	EMBOS/ELXSI UNIX	VMS only

ELXSI DELIVERS BETTER PERFORMANCE. NOW.

Compare. Not even the VAX 8600 can match the ELXSI System 6400 performance and expandability.
And the ELXSI System 6400 is deliverable now.
Call ELXSI today - sales offices in most major cities.



ELXSI

ELXSI, 2334 Lundy Place, San Jose, California 95131
408/942-1111, Telex 172-320.

UNIX is a trademark of Bell Laboratories.
VAX and VMS are trademarks of Digital Equipment Corporation. EMBOS is a trademark of ELXSI.

CIRCLE 20 ON READER CARD

IN FOCUS

Bob Djurdjevic says. "Any mistake, whether with product or with strategy, is going to be costly."

PICKING UP THE PIECES

by Hesh Weiner

While the remaining American pcms hang on, it seems only fitting that Storage Technology Corp., the Louisville, Colo., firm that was among the first and flashiest, should be the most prominent of its breed to crash into bankruptcy. The firm's brash, audacious, and daring style had enabled it to reach \$1 billion in revenues 13 years after its founding, but it also led the firm to its Chapter 11 filing on Halloween last year. Can a smaller, more sober company rise from the ashes?

It is possible, though unlikely, that StorageTek will emerge from bankruptcy within several months. The firm's management filed voluntarily; this is a good sign, since it indicates the company hopes to return to solvency at some future date and to retain control of the company during the bankruptcy process. The history of StorageTek shows, however, that the hopes of management have not always been realized.

Even sympathetic observers have grown to question the accuracy of predictions by StorageTek about the future state of its business. The company has shut down its IBM-compatible mainframe ef-

As recently as August 1984, company executives asserted that the second half of 1984 would be profitable for their company.

fort, has fallen behind its initial plans to deploy optical disks, and has revised downward estimates of its projected income from magnetic disks more than once in the past two years. As recently as August 1984, company executives asserted that the second half of 1984 would be profitable for their company, despite losses in 1983 and the first half of 1984. By October, however, StorageTek admitted it would lose money in the third quarter, and a month later it announced a quarterly loss of nearly \$65 million.

Despite its initial intentions, StorageTek may find itself unable to continue doing business as facts about the company's condition emerge and circumstances change. In that event, the company could

be dissolved and its assets liquidated. Along the way, the creditors and the courts could force the company's remaining management to abdicate in favor of a court-appointed trustee experienced in such liquidations. Already, the firm's chief executive officer, Jesse I. Aweida, and president, Naim Aweida, have been forced out of their posts, replaced in the interim by director Thomas F. Wands.

Between the extremes of recovery and complete dissolution lie other, more likely possibilities. Among these is the acquisition of the company by another business entity. No acquisition of Storage Technology can occur, however, until the firm's financial condition is detailed and scrutinized by the bankruptcy court, the creditors, and possible suitors.

Yet the potential sale of the company could create other risks as well. For example, a Japanese buyer might be viewed as an intolerable menace by IBM. If IBM felt it had to fight an all-out war, it could make the disk business untenable for competitors. Still, rumors regarding a possible acquisition have been rampant in the computer business and among financial experts virtually since StorageTek filed for protection.

Another possibility is that the company may be pared down through the liquidation or disposal of some divisions; the Documation printer company might be sold off, for example. Yet should StorageTek be stripped of the divisions that show future promise, such as the optical disk development group, the company might survive in the short run at the possible expense of its health in the years to come.

Alternatively, it is also possible that the courts will seek to preserve StorageTek as an independent company, but under new management. At press time, it was not clear how the bankruptcy court and StorageTek's creditors were planning to act.

Storage Technology's bankruptcy has been costly to the company; observers speculate that its losses could exceed \$125 million for 1984, and that the company's net worth could decline to only \$300 million over the next year, from a paper value of \$1.2 billion in 1984.

While its assets exceed its liabilities on paper, the peripherals maker is not liquid: cash flow problems have dogged the company for months. Had StorageTek not filed for bankruptcy, it would have been unable to pay its bills. A large portion of its assets, including production machinery, has been mortgaged. Much of the equipment it leases to users is owned by others. Interests in the company's future projects have been sold to investors and kept at arm's length. Thus the financial reports issued by Storage Technology

prior to the third quarter of 1984 did not—and probably could not—reflect the worsening predicament in which the firm found itself.

In addition to its own financial problems, Storage Technology's bankruptcy will produce losses in the tens of millions for others. An estimated \$1 billion in equipment made by StorageTek is owned by banks and leasing companies. About \$400 million of this was at risk when third parties held their first meeting in mid-November. These organizations used StorageTek as a marketing and collections agent. When the company went bankrupt, it had in its possession \$23 million in rent from users to be passed on to the owners of the leased equipment.

Since StorageTek does not inform

In addition to its own financial problems, StorageTek's bankruptcy will produce losses in the tens of millions for others.

users when their leased equipment is actually owned by a third party, several industry consultants have recommended that users of leased machines place their monthly checks in escrow rather than sending them to StorageTek; otherwise, these consultants say, StorageTek might accept payment and not pass it on to the third party, resulting in potential legal actions.

Users may find other difficulties in dealing with StorageTek. Certain promises made by the company regarding disk upgrades may remain unfulfilled, at least in the near term. In some cases, users signed leases on Storage Technology's 3350-type disks, typically double-density models, while awaiting StorageTek's 3380-type machines. StorageTek sometimes promised trade-ins as the larger machines became available, but these swaps may now be blocked. If that occurs, users will find themselves stuck with 3350-type disks that they never wanted.

Before these customers will ever see their promised disks, the company needs to right itself. One immediate benefit to StorageTek of the bankruptcy filing is an improved ability to raise cash. StorageTek may now sell assets to others while protected by the bankruptcy court from the claims of unsecured creditors that predate the bankruptcy. Since most of the firm's debt is unsecured, the potential amount of cash that could be raised is significant.

Yet the company has had little luck in arranging for additional loans to help with its cash-flow problems. The company leaked to the press its initial attempt at getting cash, a \$150 million loan from Chemical Bank arranged by Touche Ross in November. The leak backfired

We've taken the UNIX* operating system, which is rapidly becoming an industry standard for multi-user systems, and applied it across the broadest range of computer products in the world. Now we stretch from PC to mainframe. From one user to thousands.

A complete line, which now includes new high-performance microcomputers, as well as a performance leader in the mini-computer class.

The commitment we've made is unprecedented.

**The software is as rich
as the hardware is stable.**

UNIX operating systems aren't new. So right now there's already a vast library of powerful software. And, as you probably know, the UNIX O/S is a superb workbench for creating new applications. Hundreds of development programs for design, programming and documentation are already available.

Our commitment to UNIX operating systems makes us a seller of solutions you can apply throughout your company, from our four new microcomputers, handling 2-64 users, to our minicomputer's 64-128 user capability, to our much respected Series 1100 mainframes.

1-800-547-8362

Call toll-free for more information or a demonstration at the Sperry Productivity Center nearest you. Or write. Sperry

Corporation,
Box 500,
Blue Bell, PA
19424-0024.

From PC to mainframe. From Sperry. The first full line based on the UNIX operating system.



 SPERRY

*UNIX is a trademark of AT&T Bell Laboratories.

CIRCLE 21 ON READER CARD

IN FOCUS

since Chemical had only gotten as far as a letter of intent before some of its officers apparently determined that the deal was too risky.

Chemical's uncertainty, as exposed by StorageTek's hasty disclosure, may have discouraged other banks from lending the firm money, but StorageTek was able to call upon one of its subsidiaries, Storage Technology Finance, for an \$80 million unsecured loan. Concurrently, the firm pulled in a large order from a most unlikely customer. IBM, which had been experiencing difficulties maintaining a sufficient supply of a controller, bought \$10 million of StorageTek gear for internal use, enabling it to divert its own machines to customers.

StorageTek attributed its losses in part to competitive pressures from IBM. The Colorado firm had to cut its disk prices in the wake of IBM's late summer price reductions. In addition, StorageTek may have had to make other price concessions in order to book business, since IBM's volume purchase agreements with customers undercut StorageTek's prices. Also, IBM has kept a brisk pace in advancing disk technology, forcing StorageTek and other contenders to invest heavily in research, engineering, and production facilities.

According to industry observers, even as the pcms began to ship their answers to IBM's top-end 3380, IBM began to move toward announcing this year disks with greater capacity and, possibly, more rapid data transfer rates. A new generation of disks from IBM could shorten the production life of current pcm 3380-type

StorageTek attributed its losses in part to competitive pressures from IBM.

products, reducing the overall revenue and profits of these companies.

Ironically, however, if IBM announces disks that are within the reach of the pcms, disks which are only extensions of the 3380s the pcms have already developed, the result may be an opportunity for StorageTek and its ilk to achieve significant profits from their disk manufacturing. If, on the other hand, IBM's announcement is technologically a major step forward, the pcms may not be able to develop the catch-up technology in time to compete effectively.

In the tape area, for example, IBM's new 3480 tape transport is sufficiently advanced to render StorageTek's mainstay tape drive business uncompetitive. Even though the initial shipments of IBM's transports are to be spread over the next three years, the impact of the new transports will be felt this year. StorageTek has long said that it has a competitive

product, but no announcement has yet been made, and promises are not profits.

In the past two years, Storage Technology has proffered many promises on many scores. At the same time, it has shown nary a cent in profit. Now, in the hands of the bankruptcy court, it's unlikely that either promises or profits will come out of the foothills of the Rockies for some time. Indeed, the best one can say about Storage Technology is that an atmosphere of uncertainty will surround the firm for quite some time.

USERS: A TIME FOR CAUTION

by Edith Myers

Users have been watching the struggles of pcms with mixed emotions and wary eyes. Some of their thoughts bode ill for the future reception of non-IBM products in the marketplace.

"The first thing I did [when Storage Technology Corp. filed for bankruptcy] was take a look at our inventory," says William Campbell, vice president of the information services group at Chemical Bank's Operations Division in New York.

"Happily, what we had of the StorageTek gear was minuscule—just some tape drives. I don't think I'd rush into buying any more of their tape drives."

Wendell Meyer, general manager of the Data Services Bureau for the City of Los Angeles, says he has been shopping for new equipment and considering StorageTek. "Fortunately, we don't have to move on it right away, so we'll continue to look. The viability of a company is always a concern, and the more they shake out, the more of a concern it becomes."

An Atlanta MIS director is "very happy" that he does not now have any StorageTek gear, adding, "this [bankruptcy filing] doesn't make me want to go out and buy anything from them." He says he had tape drives made by StorageTek about a half dozen years ago and had problems with them. "We went out and got a better deal from Memorex."

While these users have not formally changed policies regarding pcm peripherals, others have. Richard Vandergriff, head of operations of California's Health & Welfare Data Center in Sacramento, says he has taken immediate action. "We're going out for bids for some new DASD equipment and we've excluded

StorageTek and Control Data from phase one."

Were all current pcm users as unlikely to continue buying from the pcms, the picture for StorageTek might seem bleak even if the company emerges vigorously from Chapter 11 protection. Some users, however, retain a measure of optimism when discussing the Colorado firm. Says John Hufnagel of Philadelphia's Mellon Bank, "StorageTek has had a wide reputation for more reliable tape drives than IBM. I may still be interested." Does he have any Storage Technology gear now? "Thank God, no."

Robert H. Schneider, manager of dp planning and operations for Tektronix Inc. of Beaverton, Ore., is also hopeful. "Their problems give us some cause for concern, but we think they're basically sound and will work them out."

Bob Riggs, staff vice president for information systems planning at Dresser Industries Inc. in Dallas, says, "It depends on what evolves in the Chapter 11 proceedings. If they continue to offer quality products, we will continue to do business with them."

Bill Sumner, MIS director for Bullcock's in Los Angeles, calls himself "just a

"If StorageTek continues to offer quality products, we will continue to do business with them."

neutral bystander. We don't have any Storage Technology disks, but we do have some of their tape drives. I'm not sure what Chapter 11 means any more. Look at Braniff and Continental. It doesn't mean face down in the gutter like it used to."

Even users who profess unwillingness to buy new pcm storage devices say they have so far experienced no major impact on their installed equipment from the pcms' woes. Indeed, users say the pcms have hardly missed a beat in maintaining installed gear. "We've had no problems and I think they will continue to maintain our tape drives," says Campbell of Chemical Bank.

Vandergriff distinguishes his bid exclusions from his current devices. "Yes, we're concerned, but not about what's already installed. They're owned and paid for and anybody can maintain them."

Riggs of Dresser Industries says he feels secure with the drives he has now. "We also have CDC disks, and that hasn't been a problem either."

Vandergriff, too, has Control Data disks, and even though he has excluded both Control Data and StorageTek from his latest bid request, he still feels he will buy American. "There's Am-dahl and others. We'll buy American. We're American."

The Atlanta MIS director is less restrictive when asked about who he'll buy from. "We've looked at Hitachi and the tape drives we have from Memorex are made by Fujitsu. We've had no serious problem with them."

Nor do the recent pcm problems affect the status quo of these users vis-à-vis IBM. Only Meyer of the City of Los Angeles sees a potential effect of the pcm problems on his negotiating strength with IBM.

"It's a long-range possibility," he says, that IBM will have a stronger hand with less American competition. Storage-

"If they continue to offer quality products, we will continue to do business with them. . . . Chapter 11 doesn't mean face down in the gutter like it used to."

Tek is the only pcm storage vendor Meyer uses now, although he has a variety of pcm terminals.

Other users see the pcm market as a viable alternative to IBM, StorageTek and CDC notwithstanding. Hufnagel's Mellon Bank data center has a large number of non-IBM terminals, made by ITT's Courier unit, but in other areas IBM dominates. "The fact that we're largely IBM bothers me. I'll always be interested in pcms."

And the Atlanta MIS director notes, "We have a mixed shop and always will. Performance is the thing. While I wouldn't jump in and get StorageTek in light of their financial problems, I will continue to deal with other pcms if the deal is right."

Yet with StorageTek and Control Data out of the running, that leaves only Memorex and the Japanese as viable pcms. The Atlanta executive says he has also been nervous about Memorex, however, since it was acquired by Burroughs Corp.

"I'm trying to effect a graceful separation between them and us," he says. "They're a lot of hard-nosed people."

Consequently, he is migrating his most essential data from Memorex to IBM drives. "The noncritical applications, those easily recovered, will stay on Memorex, but we're not replacing any Memorex drives. Eventually, because of high maintenance costs on Memorex drives relative to IBM 3380s, it will become economically feasible to replace those drives with IBM's."

Riggs of Dresser Industries says he still prefers the security of a shop with a pcm presence. "I'm interested in buying computer products at the lowest possible cost," he says. Would he ever seek the security of a pure IBM shop? "Hell, no." ©

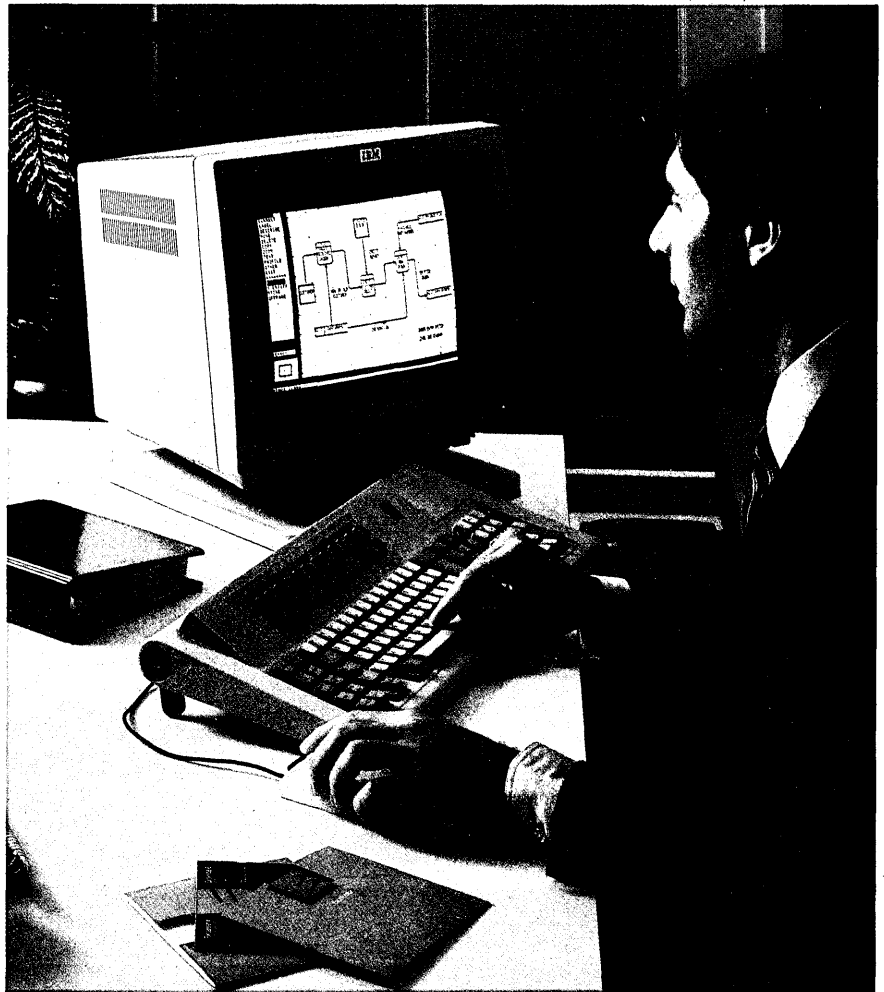

The future of systems analysis.

Computer Aided Design Now! Now, you can cross-check all aspects of the system specification for completeness and accuracy. An integrated report writer and document preparation facility allow analysts to generate mini-specs for project reviews or the complete specification ready to deliver to clients.

With *Excelerator*, you can improve the effectiveness of your systems analysts and software designers by providing a tool that automates the job of developing systems specifications. *Excelerator* provides facilities for creating and validating data flow diagrams, data model diagrams, structure charts, report mockups, and screen mockups. The extended data dictionary stores all the information about your specification, including record and file layouts, data elements, and relationships.

Your specification is more complete and consistent than using manual methods—and finished in a fraction of the time.

Excelerator is the most complete workbench for the systems analyst available on the IBM PC-XT, 3270-PC, and PC-AT.

Call or write for more information.



Excelerator™

Index Technology Corporation Five Cambridge Center Cambridge, MA 02142 617 491-7380

West 18662 MacArthur Boulevard Suite 200 Irvine, CA 92715 714 955-1160

Southeast 7927 Jones Branch Drive Suite 400 McLean, VA 22102 703 442-8202

Midwest Citicorp Plaza 8410 West Bryn Mawr Avenue Suite 400 Chicago, IL 60631 312 380-1226

Southwest 12750 Merit Drive Suite 300, LB-20 Dallas, TX 75251 214 392-9930

Now available through your local IBM branch office

CIRCLE 22 ON READER CARD

Intech

JANUARY 15, 1985 41

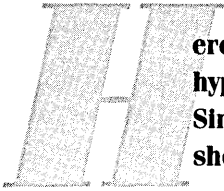

ere are the facts. Not vendor
hype. Not empty promises.
Simply the facts. And that
should be refreshing.

**Users name SOFTWARE
company with top DBMS**

AG as and 4GL team!

The word is out--and we're not surprised!

When Data Decisions decided to rate systems software packages, they went right to the people who really count. The users. Their 1984 Systems Software Users' Survey reveals ADABAS—for the third year in a row—to be the highest ranked data base management system for the IBM mainframe. And NATURAL was a top contender for best fourth-generation language.

Taken together, ADABAS and NATURAL make an absolutely unbeatable team! When we talk about product integration . . . it's not just

talk. Every product in our system is fully integrated.

At Software AG, we don't believe in surprises. We believe in providing our users with the most powerful software tools available anywhere. And that's the proper plan for the world leader in advanced systems software.

So if you want the facts about systems software, just ask our users. For starters, send us the coupon below and we'll rush you a reprint of the survey results. Or call us at 1-800-336-3761. (In Virginia and Canada, call 1-703-860-5050.)

Where the future
comes as no surprise.

Send me the facts.

Name _____

Title _____

Company _____

Address _____

City _____

State _____

Zip _____

Complete and mail to: Software AG, 11800
Sunrise Valley Drive, Reston, VA 22091.
(Or call 1-800-336-3761. In Virginia and
Canada, call 1-703-860-5050.)

© 1985 Software AG of North America, Inc.
ADABAS and NATURAL are trademarks of
Software AG of North America, Inc.

DM0115

NEWS IN PERSPECTIVE

STRATEGIES

THE NEW SPERRY: UNIXVAC?

Can a revamped product line and management philosophy revitalize the BUNCH charter member?

by Robert J. Crutchfield

They aren't changing the name to Unixvac, but in every other way executives at Sperry Corp. are striving to integrate its old Univac-era mainframes with its new thrust into the Unix marketplace. Based in Blue Bell, Pa., Sperry's Computer Systems division hopes to use its 30-year heritage in the computer business to couple the Univac legacy with more outside technology and a Unix-based product line that now extends from personal computers through the 1100 series mainframes.

The decisions to support AT&T's Unix System V on its mainframes and to actively seek products from outside sources are more than indications of a general commitment to opening up Sperry's proprietary systems: they represent a major shift in the fundamental management philosophy at the company, one that it hopes can bring Sperry back to prominence in the industry. It took the company only seven months to make the decision to support Unix under OS/1100, but more than a decade to come to the realization that exclusive continued support of a closed architecture would limit the firm's growth.

"Sperry has joined the twentieth century," says Michael Geran, an analyst with New York investment firm E.F. Hutton. The primary thrust in Sperry's new philosophy is one toward marketing and away from engineering, Geran says. "They killed the not-invented-here attitude and set up a distribution channel in a manufacturing-based company."

Sperry's critics have long said that the company is seriously deficient in the area of marketing, and apparently the company has listened. Over the last four years, as Sperry's older generation of executives has retired or switched firms, the entire upper management of the computer systems division has changed from a group of engineers to a group of marketers, a process Geran labels a cultural revolution. In fact, the president of the computer systems division, Joseph J. Kroger, is the first nonengineer to head that group. Kroger started with Sperry as

a salesman more than 20 years ago, and has been a marketer ever since.

The company's past concentration on technology has caused it to miss big opportunities. "We got lulled into a state of building bigger and bigger mainframes," says James Aldrich, Sperry vice president of product strategy and market development. "We missed the opportunity to sell minis, and with the advent of the micro, companies like Sperry lost the ability to compete across the board." Because of the time it takes to develop a product internally, Aldrich says, Sperry will increasingly turn to oems so it can bring products to market in a more timely fashion.

"We can't build everything," Kroger says. Indeed, the executive believes that Sperry's very nature is changing from that of a manufacturing concern to that of a systems integrator.

But while the company is entering into numerous oem agreements, it still plans to spend in excess of \$2.7 billion internally on research and development over the next five years. In 1984, the company spent \$340 million on R&D, which translated to approximately 12% of its \$2.8 billion in computer revenues. From these efforts, expect to see a cpu currently code-named Mercury rolled out soon after IBM announces Sierra. The mainframe series will run 27MIPS to 90MIPS and support both OS/1100 and Unix. In the meantime, the company also has a "Super 1100/90" that will support Unix and run in the 11MIPS to 35MIPS range. A desktop version of the 1100 is also in the works.

Kroger believes that Sperry's very nature is changing from that of a manufacturing concern to that of a systems integrator.

"No one else can build an 1100 for me," Kroger says.

At this point, however, the 1100 series is unique among Sperry hardware products: it is the only one still being designed and manufactured in-house. The beginnings of this shift toward third-party development began last year, but will not reach full flower until later this year, as new additions to Sperry's product line are introduced.

"The not-invented-here mentality is dead at Sperry. Where we don't have the ability to manufacture we will go outside and get whatever we need," says Dewaine Osman, head of Sperry's Americas Division. Sperry's oem deal with Mitsubishi Electronics for the Sperry PC is a case in point. Sperry's internal development people couldn't come up with a comparable machine in a shorter period of time, he says. "It was a contest between Mitsubishi and us, and Mitsubishi won."

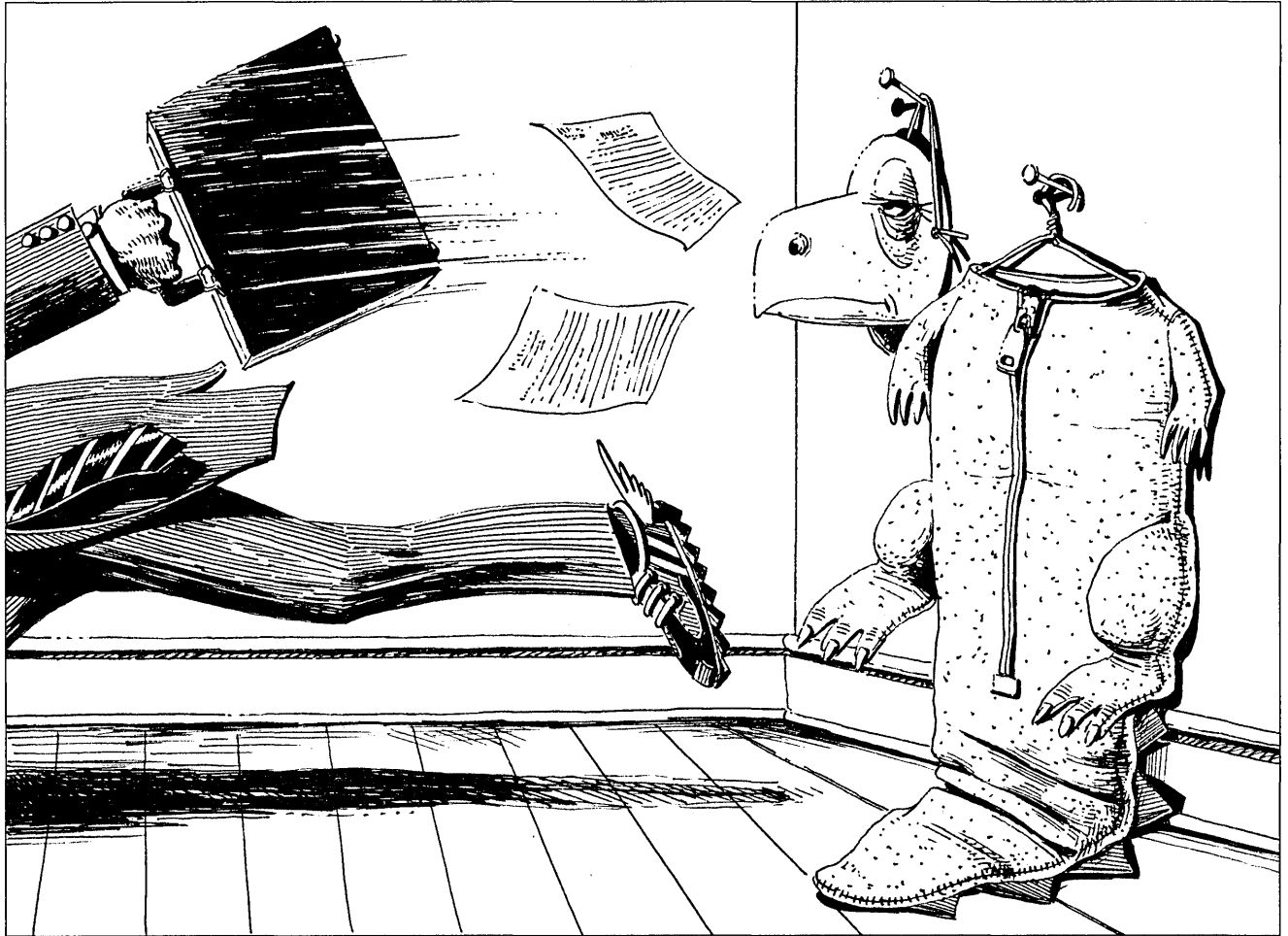

Although the company officially is very supportive of the Mitsubishi box, other microcomputers are also being evaluated by the company.

Similarly, Sperry is currently offering an office automation system called Q-Office for its recently introduced line of supermicros. Sperry licensed Q-Office from Quadratron Systems Inc., Encino, Calif., Aldrich says, because it could not port its mainframe Sperrylink OA system to the Unix environment in time for the product announcement.

"At any time we are looking at as many as 40 products from oems," says Myrddin Jones, vp for market development. "In the past, we had a mainframe mentality." From those evaluations, users can expect Sperry to offer a host of non-mainframe products, including a clone of IBM's PC AT during the first half of 1985—probably not from Mitsubishi. Among other oem deals soon to be finalized is one with Encore Computer Corp., Wellesley, Mass., for a fault tolerant Unix-based mini. Sperry has already made a \$3.5 million investment in Encore, representing 775,000 shares of convertible preferred stock. Under the agreement, Sperry says it will "be exploring a variety of product and technology possibilities."

All of them will use the Unix operating system in one form or another, and no wonder. Sperry's proprietary operating system, OS/1100, has not been a smashing success with independent software developers. "Prior to this year, only 10 third-party software vendors were writing for OS/1100 and hundreds were writing for Unix," Aldrich says.

Sperry will continue to support OS/1100 with internally developed applications software, Aldrich says. Yet con-

"Prior to this year, only 10 third-party software vendors were writing for OS/1100 and hundreds were writing for Unix."

currently the company is actively acquiring a diverse range of third-party software to run under SX/1100, as Sperry calls its version of Unix. As the software is moved to the 1100 hardware, Sperry expects users to migrate extensively to SX/1100. The company estimates that by the end of the year as much as half of its 1100 installed base, which numbers about 3,000 sites worldwide, could be using the Unix product.

What's more, Kroger says, the company forecasts it will ship 602

1100/70s and 188 1100/90s in 1985, and double those figures the following year. Geran of E.F. Hutton finds that estimate plausible if only because Sperry was two years late in delivering the high-end 1100/90, resulting in a significant pent-up demand for upgrades among the 1100/90 user base. The 1100/90 is also a faster computer than competitive machines, he says.

Geran notes that he has also seen a turnaround in orders for the 1100/70 line, adding, "There is more life in the base than might be expected."

Indeed, in 1985, for the first time in a decade, Sperry will have shipment gains in the 30% range, Geran says. In its 1984 fiscal year ended last March, Sperry registered computer system revenues of \$2.8 billion, a modest gain from 1983 and 1982. Subtract out military and space systems, however, and it turns out that commercial computer revenues have declined more than \$200 million a year from 1982 to 1984.

Sperry currently does approximately half its business in the United States between commercial and government accounts and the other half overseas, but, the analyst says, revenues from abroad are expected to jump 14% this

NEWS IN PERSPECTIVE

year, compared with 4% in the U.S.

Sperry chose the recent Comdex trade show to put its marketing cards on the table, and given that show's rich history of promoting Unix products, the company could not have chosen a better place to announce its Unix gamble. Sperry announced both its commitment to support Unix throughout its broad product line and its initial oem deals for three lines of minicomputers. Sperry is reselling two NCR Tower supermicros as its own model 5000/20 and 5000/40 units, an odd cooperative agreement between two historical adversaries. It is also reselling two Areté Systems Corp. minis as its model 5000/60 and 5000/80 systems, and a Computer Consoles Inc. supermini as its model 7000/40.

The Sperry contracts mean big business to Areté, based in San Jose, and CCI, based in Rochester, N.Y. The Sperry order boosted Areté's revenue from \$1

This year, for the first time in a decade, Sperry will have shipment gains in the 30% range.

million to \$50 million in 1984. According to Glenn Patterson, Areté's vice president of marketing, over the next year Sperry will account for 40% of that company's business (see box). Unlike the deal with Encore, Sperry does not have any equity investments in Areté or CCI.

Sperry contends it can offer many things to customers that most of the oems with which it cooperates cannot, but in essence the Sperry advantage seems to be its worldwide sales and support staff and its long experience in the computer business. Basically, the company is offering its name to oems much in the same way McDonald's lends its name to fast-food franchises: it is selling its established position in the computer industry as a value-added part of the oem products it sells.

That heritage is clearly attractive to oems, but it is also largely irrelevant to Sperry in competing for business with firms like IBM or Burroughs. That means the key to Sperry's success will rest almost entirely on its marketing prowess, as it attempts to convince customers that what's good for AT&T and Sperry is good for the country: Unix. "Unix is a major opportunity for us, especially if AT&T gets its act together," Kroger says. "Unix is becoming a standard and will be part of our product line. It makes us more competitive."

The Sperry version of Unix, SX/1100, runs as a task under a new release of OS/1100, giving the venerable operating system many features of an open system. For the first time, Sperry mainframe users will have Unix end-user facilities, the Unix kernel, and compilers for

OH, TO HAVE THESE PROBLEMS

Until Sperry Corp. tapped Areté Systems Corp. for two models in its 5000 series of supermicros, the small Silicon Valley startup was relatively unknown. The Sperry contract, however, boosted the firm's 1984 revenues by \$30 million almost overnight. Says president John R. Vrolyk, "We shipped \$800,000 of product in all of 1983. As a result of the Sperry deal, we ship more than that per month now. The firm has grown by 35% in two weeks."

In what has to be one of the grandest understatements of the year, Glenn Patterson, vice president of marketing for the San Jose-based company, says, "No doubt Sperry will account for a substantial part of our overall business." Indeed, the Pennsylvania mainframer will account for 40% of the startup's revenues from 1985 through 1987, while a substantial fraction of the remainder will come indirectly from Sperry as other firms follow its lead.

Areté will be manufacturing Sperry's model 5000/60 and 5000/80 Unix-based minicomputers, which are based on the Motorola 68000 microprocessor. The other two models of the 5000 series, the 5000/20 and 5000/40, are versions of NCR's Tower series of supermicros. Sperry executives recognize the apparent illogic in contracting with a fellow BUNCH member and supposed arch-adversary, and they privately say that Sperry is unlikely to be dealing with any of its current oem suppliers in five years. Instead, they say, they will be looking to new startups with new technology.

That attitude does not faze Areté. Company executives and venture backers argue that if they are capable of meeting Sperry's demands with good products, Sperry would be ill-advised to look elsewhere for products. "It took them a long time to make up their mind, and it would take even longer for them to change it," Vrolyk says. What's more, "the cost of porting a new vendor's product to their environment isn't worth the extra performance it might give."

Areté's three-year contract with

languages such as C and RM COBOL. Because Unix operates as a task, users can continue working with proprietary Sperry software, such as the Mapper program development and Sperrylink office automation systems, on the same hardware as the Unix applications.

A beta test version of OS/1100 with Unix was evaluated at the University of Wisconsin at Milwaukee. According to Neil A. Trilling, director of academic computer services, the operating system has its advantages and disadvantages. Trilling's department needed only a

Sperry differs substantially from oem deals struck by its direct competitor, Convergent Technologies Inc. of Santa Clara, according to Chuck Hazel of Bay Partners, the Mountain View, Calif., venture firm. Hazel has been directly involved with backing both Convergent and Areté. Whereas Convergent has become known for selling huge volumes of workstations to firms like AT&T, Burroughs, and NCR, often at slim profit margins, he says, Areté prefers to deal in smaller volumes with Sperry and other systems integrators.

The firm already has "deep pockets" of \$7.8 million in venture capital, collected over three rounds, according to vice president of finance James Hunt, and so it can afford to ship smaller quantities at higher unit profits. Patterson notes that Areté is "satisfied with the margins" Sperry is offering. In addition to money, Sperry is also giving Areté some VLSI and CMOS technology in exchange for the hardware, on an informal basis.

Despite the huge burdens of managing rapid growth placed on Areté by the Sperry order, Patterson says the company will continue to pursue business aggressively with other systems integrators. The Sperry contract does not restrict Areté in any way from selling to anyone it chooses, he says. But, he adds, oem deals with other mainframers—particularly other BUNCH members—may not be in Areté's best interest.

As has been the case when other large Eastern corporations have signed major agreements with Silicon Valley firms, the two partners encountered some clash of corporate styles. Says Patterson, "I'm impressed with the level of commitment that Sperry has for our product." The most significant difference between the firms, he says, seems to be that Sperry brings eight people to every meeting while Areté can often spare only three or four.

As for controlling the rapid growth of the firm and melding the two corporate cultures, Patterson says, "it's a good problem to have."

—R.J.C. & M.T.

weekend to bring up the operating system, but it took longer to debug it. One of the difficulties with the system, he says, is security.

"The security implemented is not very good. There are no built-in safeguards designed for hostile intervention," Trilling notes. In fairness, he adds, security is a problem on most Unix operating systems, and his department is working with Sperry to resolve the problem.

The Milwaukee campus has been running SX/1100 since last summer. Prior to that, the university had been running

**YOUR DAYS OF
BUYING TERMINALS
ARE OVER!**

Now there's SmarTerm terminal emulation software for your IBM* PC, XT, AT or compatible system. All SmarTerm products offer comprehensive and exact terminal emulation, powerful file transfer facilities, and include TTY mode to link you to The Source, CompuServe, Dow Jones or other popular time-sharing services. We've included features such as ASCII and binary file transfer,

multiple setup configurations, XMODEM and PDIP* protocol

support, "smart" softkeys, plus European DOS support.

SmarTerm 100 is your choice for DEC* VT100, VT102 and VT52 emulation.

SmarTerm 125 has all the features of SmarTerm 100, plus VT125 ReGIS graphics support. For Data General Dasher* D100, D200 or D400 emulation, you need **SmarTerm 400**.

More than 15,000 users are already "hooked" on SmarTerm. Try it for 30 days, with full refund privileges, and you will be too.

Persoft, Inc. - 2740 Ski Lane
Madison, WI 53713
(608) 273-6000 - TELEX 759491

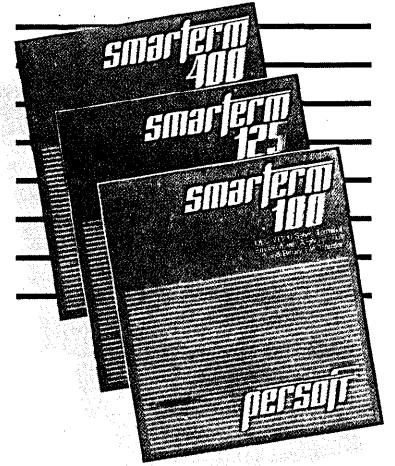

AFTER SMARTER™, WHAT DO YOU DO WITH YOUR OBSOLETE TERMINAL?



See your name in print! Send us your ideas for uses of obsolete terminals replaced by SmarTerm. The best ideas will be used in future ads. Write Persoft, Dept. FISH., 2740 Ski Lane, Madison, WI 53713.

*SMARTER and PDIP are trademarks of Persoft, Inc. * IBM is a registered trademark of International Business Machines Corp. * DEC, VT and ReGIS are trademarks of Digital Equipment Corp. * DASHER is a registered trademark of Data General Corp.

© Persoft, Inc., 1984. All rights reserved.

CIRCLE 24 ON READER CARD

NEWS IN PERSPECTIVE

Unix System III on its 1100/81, which is used for academic computing. The System V implementation of Unix is much better than its predecessor, Trilling says, because it includes the implementation of a full-screen editor for the university's asynchronous environment. On the negative side, he says, the exec calls are not "exactly the way I would like to have them."

Another early user also says SX/1100 generally lives up to expectations. Joe Carfagno, technical support supervisor for Bell Communications Research Inc., the Piscataway, N.J., research arm of the Bell operating companies, says that the operating system enables users to execute code 20% faster than on previous Sperry systems, largely because of the new C compiler.

While the emphasis on Unix, third-party development, and oem contracts may pan out for Sperry with its current generation of products, the strategy has already seen failure. Sperry's investment in Trilogy, for example, cost the firm \$32 million in write-offs with no technological return. "We were captivated" by Dr. Gene Amdahl's startup, Kroger says. "Amdahl's wafer-scale integration was an exciting concept."

"Expect Sperry to look outside

and expect us to take a risk. Trilogy was a risk," Kroger says. "We weren't looking for an investment, we were looking for technology." Now that it has technology—if not from Trilogy then from other oems—Sperry is about to learn how well it will fare in its gamble: will users save the company and buy Unix? Or will Sperry wither away and disappear? ©

OFFICE AUTOMATION

CLASH OF THE TECHIES

Digital Equipment is battling tooth and nail with Data General to establish its All-in-One software in commercial accounts.

by R. Emmett Carlyle

Despite its status as the world's number two computer company, Digital Equipment Corp. has never quite managed to shed its engineering orientation or image.

Even the company's name smacks of its technical heritage and seems like an anachronism in the dawning age of friendly computers. Though the mini-computer giant is unlikely to change its name, it has been working hard to change its image and approach.

Particularly in the key application areas of personal computers and office systems—both vital to DEC's growth in the years ahead—the company has displayed a lackluster approach, often curiously out of touch with real market needs. A coherent strategy for the personal computer industry remains elusive, but DEC is beginning to move strongly to repair its tarnished image in the boom area of office systems.

The firm's stirrings are coming none too soon. DEC has consistently been losing sales in the office arena not to IBM but, worse, to archrival Data General. The two firms were among the first to offer "integrated" software solutions to the office; yet DEC's three-year-old All-in-One, in stark contrast to DG's CEO offering, has turned out to be neither integrated nor all in one piece. "All-in-Ten would have been a better name," one early customer wryly comments.

"The product turned out to be just a patchwork of assorted packages, three

Qualified Assistance is Now Available to Users of

CICS-IMS IDMS

Applications

- Functional Design
- Detailed Design
- Programming
- Implementation

Systems

- Operating Systems
- Networking
- System Software Trouble-shooting
- Performance Evaluations and Tuning

Systems and Application Reviews

Standards & Guidelines Developed for CICS and CICS/DL1

For more information call Sonny Fusco:

**ON-LINE
SOFTWARE
INTERNATIONAL, INC.**

Two Executive Drive
Fort Lee, N.J. 07024
(800) 526-0272
In N.J. (201) 592-0009

FIRE... DESTROYS COMPUTERS



Worse, it can cause costly business interruptions. But take heart! Ansul, the world's leading manufacturer of fire protection systems, has developed ingenious, new, cost-effective solutions that you should know about.

Write for our new, useful (and free) booklet "Facts About Protecting Electronic Equipment Against Fire."

Ansul, Dept. 1D, Marinette, WI 54143.
or call (715) 735-7411.

ANSUL

NOMAD2 + SQL/DS:

Made For Each Other

NOMAD2, the premier 4-GL/DBMS, and SQL/DS, IBM's wave-of-the-future database system, have been combined to form the single most powerful information management resource available. And those who have seen this dynamic combination in action agree that the two systems were made for each other.

The NOMAD2-SQL/DS combination is much more than just an interface. It is the blending of the best 4-GL with the best DBMS available that comprises an entity greater than the sum of its parts. More specifically, the broad spectrum of capabilities that comprises SQL/DS can be accessed and controlled by dealing solely with NOMAD2.

NOMAD2's single-command environment, unmatched report writer, statistical and interactive decision support capabilities and, most importantly, its richness of language have made it the hallmark 4-GL against which all others are measured. And it is through these attributes that the sheer power of SQL/DS can be fully realized.

The NOMAD2-SQL/DS interface represents the latest innovation from D&B Computing Services. In making NOMAD2 available for use on in-house mainframes, we have continued the evolutionary process we began in 1975 when NOMAD was first introduced. And it is this evolutionary process that has catapulted NOMAD2 to the leadership position it holds in the marketplace.

If you are currently using SQL/DS in your VM environment, or even if you're just considering it, take a look at NOMAD2 now. Most people who try NOMAD2 buy it. You owe it to yourself to find out why.

**NOMAD2:
An Innovation In
End-User Computing
From Dun & Bradstreet**

**D&B Computing
Services**

DB a company of
The Dun & Bradstreet Corporation

For more information call Roger Cox at (203) 762-2511. Or drop your business card into an envelope and mail it to Roger at D&B Computing Services, 187 Danbury Road, Wilton, CT 06897.

NOMAD is a registered trademark of D&B Computing Services, Inc. IBM is a registered trademark of International Business Machines, Inc. SQL/DS is a trademark of International Business Machines, Inc.

NEWS IN PERSPECTIVE

different user menus and no single user interface," he adds ruefully. Other potential customers have clearly noticed. While neither DEC nor Data General have learned to communicate fluently with office people, the superior integration of DG's CEO has enabled it to win a string of lucrative contracts in head-to-head contests with DEC, beginning with the E.F. Hutton and U.S. Forest Service contracts early last year.

In recent weeks, Data General has commenced another streak, this time

among the Bell regional holding companies. Both Pacific Telesis and NYNEX have signed big oem contracts for CEO under which they will be able to resell the software in connection with communications systems. Nynex's \$65 million, three-year deal, for example, allows New York Telephone and New England Telephone to compete directly against AT&T, their former parent, in selling turnkey office systems.

Data General now threatens a sweep of all seven multibillion-dollar

phone companies, a prospect that would be devastating to DEC's chances of establishing All-in-One as a significant product. "In fact, I know of no major new account that Digital has secured solely on the basis of All-in-One, despite the fact that IBM, Wang, and Hewlett-Packard are all late with their office software," says Peter Lowber, an analyst and DEC watcher with the Yankee Group, a Boston research firm.

Sources believe, however, that DEC will stop the rout by securing a big oem deal with Southern Bell, a long-time DEC customer, and go on to secure other large accounts. "The CEO phenomenon may be peaking," says George Colony, president of Forrester Research in Cambridge, Mass.

If so, All-in-One may be poised for a market breakthrough. Yet many of those customers who have already taken the plunge with All-in-One—and DEC claims over 1,000 licenses for its product—talk of three years of promise turning to frustration. "We were promised a completely new version of All-in-One for August 1983, but the rewrite was so bad that it didn't even reach beta test," one customer says.

Now a second major rewrite of All-in-One, the so-called version two, has

"We were promised a completely new version of All-in-One, but the rewrite was so bad that it didn't even reach beta test."

been promised for this spring, and with it DEC may finally turn the corner.

"Clearly, Digital has made great strides with this version," says one banking customer who tested it late last year. "This is a complete rewrite at the source level, offering greater speed, integration, and one consistent user interface."

DEC is now the first company in the industry to integrate voice technology into its office software. A new voice message system allows users to retrieve both messages and interoffice mail from a push-button phone—thus turning a phone into a workstation. (Such technology is also expected from AT&T, Wang, IBM, and others.)

Now, rather than lapsing into its recent posture of following the industry, DEC finds itself leading the office automation race. Experts do not expect anything close to integrated office software from IBM for at least another nine months. Hewlett-Packard's Desk Manager is late, and the Wang Office suite is not slated to emerge from beta testing for another couple of months.

But while DEC's technology has improved dramatically, customers are still concerned that its marketing has not,

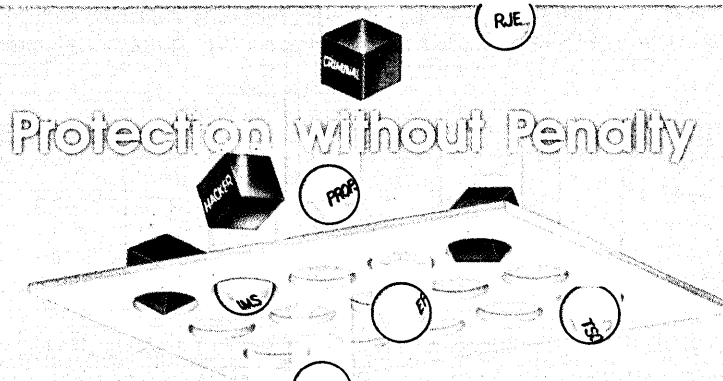

MultiSentry — the only system that blocks computer fraud by telephone without denying authorized callers quick access to your multiport computer.

MultiSentry gives you today's most sophisticated, effective defense against computer crime by telephone — and more.

Other systems offer protection that considerably restricts the convenience of authorized callers. MultiSentry's technology actually enhances that convenience.

These are some of MultiSentry's many exclusive features:

- MultiSentry can be accessed by all telephones: by Touchtone, or by rotary phones using TACT's patented voice-activated method — a remarkable ability.

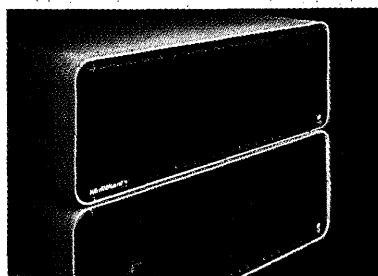

128 calls can be accommodated at the same time by the MultiSentry system.

- Up to 128 authorized callers can get a line simultaneously. Each call is responded to in less than a second. No waiting in a queue.

- MultiSentry is the only security system that activates an alarm mode.

- MultiSentry operates on the analog side of your modem. No callers hear a modem tone until they have been cleared for system access.

- MultiSentry offers three access choices: one direct connect and two call back modes.

Don't let another defenseless day go by. And when you buy protection, don't buy a system that imposes a penalty of restricted convenience and ease of use. Look into MultiSentry.

Call for full details or a demonstration: 1-800-523-0103, Ext. 510. Your call will get through.



Protection without Penalty

TACT TECHNOLOGY, 100 N. 20th Street, Philadelphia, PA 19103 • 215-569-1300

CIRCLE 28 ON READER CARD

In 1985 More Businesses Will Be Capitalizing On Softcon.

Sunday, March 31—Wednesday, April 3, 1985 **Georgia World Conference Center, Atlanta**

If you buy, select, or specify your company's software systems, you can't afford to miss Softcon, the International Conference and Trade Fair for Corporate and Institutional software users.

In only two years, Softcon has become the 15th largest trade show in America. Proof that software is the fastest growing product in the world. And that Softcon is the premier industry event.

Softcon has 850 exhibiting companies. That's 600 more software companies than the largest hardware and electronics shows. Softcon's 3000 booths will showcase more than 20,000 software products for professional, home, educational, entertainment, office, business, industrial and vertical market applications. Softcon features software for micros, minis and main frames.

Nearly 250 of the world's most respected software authorities will participate in this year's conference program. There will be three separate conferences—one for merchandisers and distributors, one for corporate and institutional users, and one for software industry technical personnel. Each conference will comprise 75 seminars, panel discussions, forums and workshops.

Softcon is a registered trademark of Northeast Expositions, Inc.

To register, just send your check for \$195 for four days of conferences and exhibits, or \$35 for exhibits-only to the address below. Please include your name and address and make checks payable to Softcon.

For a free Softcon brochure, call or write Softcon, c/o Northeast Expositions, 822 Boylston Street, Chestnut Hill, MA 02167. 617-739-2000. Please specify whether you are interested in attending or exhibiting.



The International Conference
and Trade Fair for Software
Publishers, Merchandisers,
and Business Users

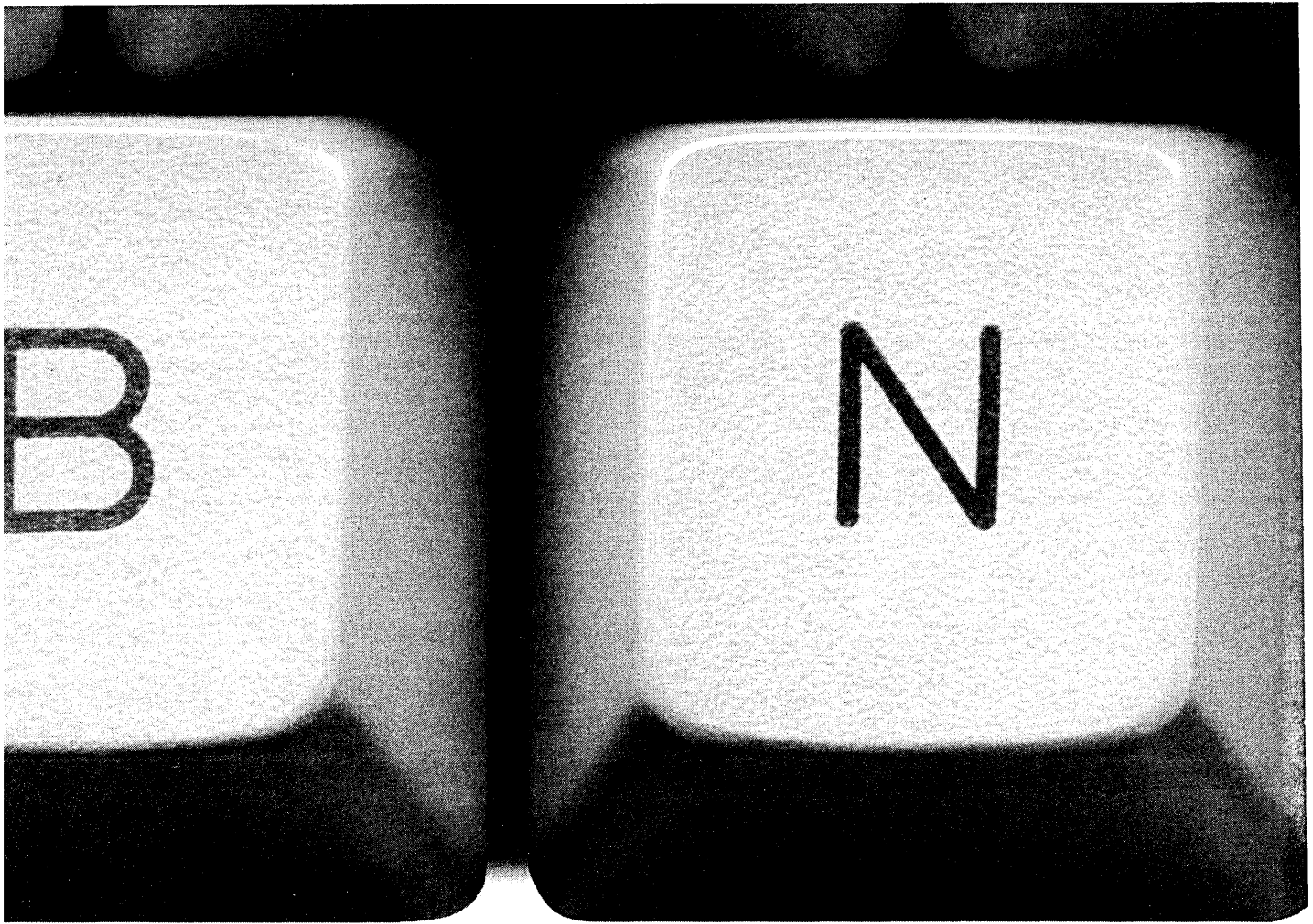

FOR INFORMATION-HUNGRY BU AN EXERCISE IN WAIT-LOSS.

Introducing OASys Mail. You need information *now*. From other floors. From other departments. From colleagues.

Problem is, you won't get it *now*. You'll waste hours—even days—waiting for couriers. Waiting for return phone calls. Waiting for someone to weed through an "in" basket.

Introducing electronic mail from NBI.

It's one of the easiest, most user-friendly mail systems you can buy. At the touch of a button you can send memos and messages to co-workers. And get responses just as fast. All through an electronic mailbox that's right at your desk.

OASys Mail automatically organizes and processes your mail. And lets you know when mail arrives, so you can act on it immediately.



SINISS PEOPLE, NBI INTRODUCES

Best of all, it runs on the NBI OASys 64—the only multi-terminal system that made the Honor Roll in the October 1984 Datapro User Ratings of Word Processing Systems.

All of NBI's powerful word processing functions are available within OASys Mail. And it's available to all word processors and personal computers on the system (IBM PCs included),

even while they're working in MS-DOS.

OASys Mail...another high-performance office solution designed to let businesses run more efficiently, more effectively, more economically.

Talk to your NBI Representative today. Or call 1-800-328-5727, ext. 115. Or write the NBI Response Center, 701 Decatur Avenue N., Minneapolis, MN 55427.

NBI

HIGH PERFORMANCE OFFICE SOLUTIONS

CIRCLE 30 ON READER CARD

NEWS IN PERSPECTIVE

that the company is not yet grappling with the "real world issues," as the banking user puts it.

"The most important ingredient in today's office, the IBM PC, has not even been addressed by the upcoming version of All-in-One," this user says. "Though the voice technology is neat and a headline grabber, it's still a case of a solution looking for a problem. They should face reality first.

Henry Ancona, product group manager of DEC's Office Systems Group, sidesteps the question of whether his company would support IBM's PC family on VAX/VMS and All-in-One systems; for though DEC has embarked on a policy of synergy with IBM at the mainframe level, it is clearly loathe to do so at the PC level, even though Data General has already done so.

Sources say that All-in-One communications with DEC's own Rainbow pc will be forthcoming in the months ahead, yet even that will be hamstrung by an inability to offer a DECnet-Ethernet connection, they say. "Not being able to hang the Rainbow off a local network makes PC/DOS support even more vital for DEC users of the IBM machine," one user comments.

Still, IBM support apart, most complaints with the new All-in-One are quibbles and seem to be giving way to a muted admiration for DEC's progress in the office environment. To some extent, the company can still be charged with blindly throwing new technology at its customers and hoping for the best, but sources say that at the very least, DEC has now learned enough to counter Data General's winning ways, as the prospective Southern Bell sale indicates.

Now that DEC's technology tap is gushing over the industry, even the company's sternest critics have begun to revise their opinions of its marketing prowess. "Fourteen months ago, DEC looked strictly second tier," says Sonny Monosson, publisher of the influential (and sometimes acerbic) newsletter, *Monosson on DEC*, "but today it has the most complete and formidable product line in the business."

Just before Christmas, DEC showcased its full product line at DECworld, the company's biggest push yet to counter its abiding weakness in marketing and image. This formerly staid and shy company mounted a multimillion-dollar extravaganza in Boston that would have done credit to Cecil B. deMille, commandeering an exhibition hall and half the hotel rooms in Boston for five days. DEC flew in thousands of the nation's top executives for a private show-and-tell of its products.

DEC made it clear that this costly seduction exercise was designed to do more

than grab the attention of top corporate decision-makers. The company's real intent was to associate indelibly the words "Digital" and "business" in corporate minds. But this achievement could continue to elude DEC.

The name International Business Machines has reflected its mission since its incorporation decades ago. "Digital Equipment," on the other hand, sounds to many ears like something from the Boston Computer Museum, with which the company is so closely affiliated, rather than something associated with the pulsing, vibrant world of commerce.

What's in a name? Well, in Digital's case, maybe an abiding echo of its past, a past it must now shed. ©

E-MAIL

E-MAIL SHOOTOUT

More than 30 companies are trying to attract users of pcs, but the market may not be there until the 1990s.

by Lamont Wood

The combatants fire salvos on an almost hourly basis in the latest high-tech war. Fighting over the patronage of business personal computer users who need to send messages to others has cost hundreds of millions of dollars over the past few months, with no signs of a cease-fire. Western Union and MCI, the two major electronic mail vendors (of EasyLink and MCI Mail, respectively), are announcing product enhancements and revised pricing at nearly the same time, and the market now has about 30 vendors.

Meanwhile, the e-mail market as a whole is in bed: companies are reporting disappointing revenues and no profits, and the Postal Service's electronic mail venture, E-COM, has a for-sale sign on it.

So what gives? Are the vendors charging lemming-like over a cliff, or do they know something we don't?

Perhaps it all just involves faith in the future. "Right now I think we're on the early 'knee' of the growth curve in the electronic mail market, and that growth will really start to accelerate in 1985 and 1986," notes Randall Sherman of Creative Strategies International, a consulting firm in Cupertino, Calif.

"For some time, people were giving optimistic forecasts for the electronic mail market, and these hopes have been disappointed," he says. "But that has changed because of the way the pc popu-

lation is going up, the availability of carriers, and the increased awareness of electronic mail as an application."

"Electronic mail services do have a future," agrees Steven Weissman, assistant publisher of *EMMS*, a newsletter put out by International Resource Development Inc., Norwalk, Conn., which covers the electronic mail industry. While most integrated office automation systems worthy of the name include some form of electronic mail, "a lot of small companies may want to avail themselves of electronic mail, but not to the point of getting their own systems," he explains. Thus, they find the public services attractive, especially for interstate communication between offices or plants.

That attraction may be short-lived, though. "Users try it and then they go in-house," notes Stephen Caswell, editor of *EMMS* and a principal with Trigon Systems Group Inc., a consulting firm in Toronto. "We see a trend among smart users—they have a trial with a public electronic mail service, expanding it application by application, until ultimately it becomes cost-effective for them to buy their own system, or get an integrated office automation system."

Weissman estimates that the size of the public electronic mail market, excluding Telex, TWX, and anything that involves printing on paper, is \$180 million a year. He expects that to grow to \$5 billion in 10 years, thanks largely to the anticipated growth of the pc population.

In terms of traffic, Caswell estimates that there are now roughly 600,000 to 700,000 users; in terms of user IDs, some 7 million messages are sent each month. He compares the electronic mail market to the telephone industry, which grew slowly until a "critical mass" of users was reached, after which there was explosive growth to the point of saturation. Telephones took off about 1950 after capturing 30% of the potential user base, he notes. Today, only 15% of users have electronic mail, equivalent to the state of

The size of the public e-mail market is \$180 million a year.

the telephone industry in 1900. Caswell expects the takeoff for electronic mail won't come until the late 1980s or early 1990s, based on pc population growth and the development of a software standard for document transmission.

But there is no guarantee that the electronic mail services will benefit from all this expected market growth. A lot of the growth might take the form of internal office automation systems. Not every owner of a personal computer buys a modem, and most business users want direct access to the corporate mainframe, not a

DIGITAL
BRIDGEWAY
TO LARGE
SCALE
COMPUTING



INTRODUCING THE VAX 8600 SYSTEM.

Your applications can do exactly what you want them to on Digital's new VAX™ 8600 computer system. They can expand.

User population can increase. Scientific problems can become more complex. Transaction volume can intensify. And data storage requirements can grow exponentially.

The VAX 8600 system gives you unprecedented capacity for applications growth. It's the first of a new generation of large scale VAX processors, with memory expansion to 32 million bytes and online storage up to 160 billion bytes. Yet the VAX 8600 system maintains complete architectural compatibility with every other VAX processor – including the new desktop-size

MicroVAX I™ system. Every system in the family gives you the same VMS™ operating system software, with the same set of proven development tools, communications options and data management facilities. Quite simply, there's not another computer family in the world that can match the growth path you get with Digital's VAX systems.

YOU GET UP TO 4.2 TIMES THE PERFORMANCE.

We've engineered the VAX 8600 system to deliver more than four times the processing speed and performance that the industry-standard VAX-11/780 system is known for. We've achieved this performance increase

through the use of ECL gate array technology and several advanced engineering techniques.

Specifically, the VAX 8600 system incorporates four-stage pipelined processing that increases throughput by allowing the system to execute one instruction while it simultaneously decodes a second, generates an address for a third and

fetches a fourth. There's also a floating point accelerator that speeds floating point operations.

Even with all its power, the VAX 8600 system conserves floor space. The CPU fits into the same size cabinet as the VAX-11/780 CPU. Power consumption and air conditioning requirements are similar, too.

VAX 8600 SYSTEM HIGHLIGHTS

- MAXIMUM MAIN MEMORY SIZE** 32 Million Bytes
 - MAXIMUM STORAGE CAPACITY** 160 Billion Bytes
 - MAXIMUM COMMUNICATION LINES** 512 plus Local and Wide Area Networks
 - PROGRAM ADDRESS CAPACITY** 4 Billion Bytes
 - BUS SUPPORT** Availability includes 6 UNIBUS,™ 2 SBI, 4 DR 780, 3 CI and 4 MASSBUS™
 - PHYSICAL DIMENSIONS** 60½" x 73½" x 30"
 - POWER CONSUMPTION** 6.5 KW (10 KVA)
 - AIR CONDITIONING REQUIREMENTS** 22,200 BTU/hr
 - ACOUSTIC LEVEL** 60 dBA
-



**VAXCLUSTERS
LET YOU SHARE
THE WEALTH
OF VAX RESOURCES.**

The large-scale storage and multi-user support you get with Digital's VAX 8600 system can be increased many times over with VAXcluster™ systems. This

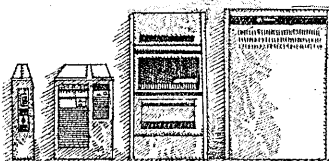

multiprocessing capability, which is unique in the industry, lets you combine the resources of several VAX processors and manage them as a single system. VAXcluster systems enhance data integrity and increase system availability, with complete user transparency.

VAXcluster systems can be configured with up to 16 processors and storage servers in a variety of combinations. You can boost computing power in an existing VAXcluster configuration by adding a VAX 8600 system. Or you can build a new VAXclus-

ter using a VAX 8600 system as a compute server.

The wealth of resources available to all VAX systems includes VAX Information Architecture, which offers a CODASYL-

compliant database - VAX DBMS; and a relational database - Rdb/VMS. This software, together with the RMS hierarchical file manager which is part of the VMS operating system, can all use the DATATRIEVE™ user-friendly query language. And they all benefit from a Common Data Dictionary that eliminates data redundancy and permits record-, field- and user-specific security controls. What's more, you can automate your office with Digital's ALL-IN-1™ software.

All VAX systems give you a complete set of program debuggers, editors, and screen man-

agement utilities to work with. You have a choice of 15 programming languages. And you can combine different languages in a single application through the common calling standard.

the SNA™ gateway.

The VAX 8600 system is engineered for the reliability your large-scale applications require. Self-diagnostic intelligence simplifies maintenance.

The expanding VAX family.

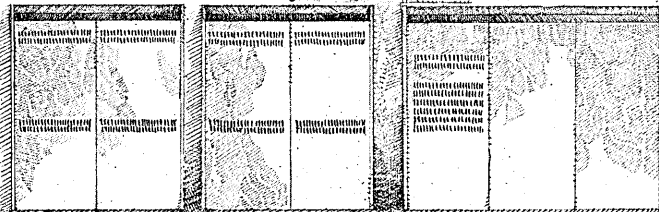

**BEST ENGINEERED
MEANS ENGINEERED
TO A PLAN.**

The VAX 8600 system, like all Digital hardware and software products, is engineered to conform to an overall computing strategy. This means our systems are engineered to work together easily and expand economically. Only Digital provides you with a single, integrated computing strategy direct from desktop to data center.

For a brochure on the VAX 8600 system, contact your local Digital sales office. Or call 1-800-DIGITAL, ext. 280.

**ENGINEERED
FOR COMPATIBILITY
AND RELIABILITY.**

Digital's VAX 8600 system is compatible with every other VAX processor. It can also work with many other systems you may already own. Digital's DECnet™ networking software links Digital systems, users, files and applications over a variety of communication devices, such as Ethernet, leased lines, standard telephone lines, and public wide area networks. We offer protocols for communication with non-Digital environments, such as

**THE BEST ENGINEERED
COMPUTERS
IN THE WORLD.**



Unleash The True Potential Of The 68000/Unix Environment

PHILON FAST/Compilers are so fast, your concept of speed will never be the same. Compilers that unleash the ultimate power of the 68000 and drive UNIX* to its fullest potential. PHILON FAST/Compilers redefine performance in benchmarks — UP TO 47 TIMES FASTER (see benchmark chart).

FLEXIBILITY — it's built in. PHILON FAST/Compilers are specifically designed to free programmers from artificial constraints (such as 64K program size or data file limitations) and allow efficient development of highly-optimized application systems. You can even link program modules in the same or different languages.

DEBUGGING — it's a snap. The Phi-Analyzer high-powered debugger vastly increases programming productivity.

THOROUGH TESTING — RESPONSIVE SUPPORT

You demand reliable compilers; Philon's quality assurance commitment delivers.

ACCURATE, EASY-TO-UNDERSTAND DOCUMENTATION — it's part of The Philon Approach.™ Plus, you can become part of a comprehensive customer support program designed to keep productivity at its maximum. This is what you will come to expect from Philon.

*UNIX is a trademark of AT&T Bell Labs
**RM/COBOL is a trademark of Ryan-McFarland Corp.
†CBASIC is a trademark of Digital Research, Inc.
††MBASIC is a trademark of Microsoft, Inc.

RECOMPILE EXISTING APPLICATIONS FOR DRAMATIC RESULTS

Dramatic speed improvements can be achieved by simply recompiling with one of these corresponding PHILON FAST/Compilers.

RM/COBOL** PHILON FAST/COBOL
CBASIC† PHILON FAST/BASIC-C
MBASIC†† PHILON FAST/BASIC-M
Any full implementation of K & R - "C" PHILON FAST/C

BYTE Magazine Sieve Benchmark

MINUTES	SECONDS	
15	00	RYAN-McFARLAND COBOL
07	38	MICRO FOCUS HIGH PERFORMANCE LEVEL II COBOL
00	19	PHILON FAST/COBOL

In a comparison of Ryan-McFarland COBOL 1.6A, Micro Focus COBOL 2.0 and PHILON FAST/COBOL 1.0 using the *BYTE* Magazine sieve benchmark the results are conclusive: PHILON FAST/COBOL executes the benchmark 24 times faster than Micro Focus and 47 times faster than RM/COBOL. (System configurations; 68000/UNIX/8mHz/1wait state.)

Unleash the true potential of your 68000/UNIX system, call Bob Gildeberg at (212) 807-0303 or write to Philon, Inc., 641 Avenue of the Americas, New York, NY 10011

PHILON™

CIRCLE 31 ON READER CARD

NEWS IN PERSPECTIVE

simple message service.

"Most use of electronic mail is internal—44% interoffice and 31% inter-company," cautions Louis Verchot of the Eastern Management Group, a consulting firm in Parsippany, N.J. "So with the 23% left over, and a slice out of the other two markets, at best less than half the traffic would be available to the public vendors, and maybe as low as 20%. And that traffic will be split among the competition. People have been led astray because they have not looked beyond the initial numbers."

A random sample of users repeated these sentiments. "We see some use for outside services—we have a need to talk to people outside the firm, such as suppliers and law firms, where the cost won't justify putting them on the internal sys-

"We see some use for outside services," says a user, "but most communication takes place between people inside the company."

tem," says Gerald Peterson, manager of worldwide systems planning at Ford Motor Co. in Dearborn, Mich. "But most communication takes place between people inside the company."

"I don't see that what they [the vendors] are offering is really an electronic mail system," says Duane Sheets, manager of office automation at Electronic Data Systems Corp. in Dallas. "A low-speed message service is what I'd call it. To call it electronic mail you've got to have a complete administrative system you can time into your databases. If I had to communicate with an outside corporation I might consider such a service, but if executives are going to be using it I would want to examine the security question."

Nor has the bottom line given cause for optimism about the market's future. "Few if any of the public services are making money at the moment," Caswell notes. "But that's because the carriers are in expansion mode. They're trying to build up their customer base. After the base stabilizes it can become a cash cow. It may cost \$500 to hook up a new customer, and then he pays \$300 per year. Also, a new concept like electronic mail can be expensive to advertise."

Currently, dozens offer some kind of public electronic mail service. These services generally amount to an electronic mailbox—you access them through local calls or toll-free numbers, download the messages in your own mailbox, and transmit messages to other people's mailboxes.

The granddaddy of all electronic mail suppliers is the 133-year-old Western Union Corp. It has been offering telex—the mechanical descendant of the

telegraph—for decades, and has annual revenues of more than \$1 billion. Western Union introduced EasyLink in 1982. Users can send messages between EasyLink connections and telex machines; the latest enhancements allow Easylink subscribers to communicate with each other in real-time "conversational" mode as if they were using high-speed telex machines.

Western Union counts 108,000 EasyLink subscribers sending 2.5 million messages a month. Billing is based on access time, with a \$25 per month minimum and no initiation fee.

All those customers came at a heavy price. The company admits it is losing money on the new service, after pouring over \$150 million into its startup. The losses are expected to continue, because the company recently admitted it had to triple its revenues to break even. In fact, a few weeks ago the company had to suspend paying dividends to stockholders, a sign that it will fight MCI, the Source, CompuServe, and the other public vendors to the death.

MCI Mail stands out by offering all the major delivery methods—electronic mailbox, courier, and U.S. mail. "Instant" delivery means your message will be sent to the recipient's mailbox within the MCI Mail network. If he doesn't have one, you can use the four-hour courier service, which will deliver a printout of the message via courier within four hours, assuming the recipient is in any of 15 major cities. Otherwise you can use overnight courier delivery, and it should get there by noon. And then there is the MCI Letter, where the message is sent to the MCI postal center nearest the recipient and then dropped in the mail.

MCI's recent price cut and switch to an upfront fee indicates that the communications upstart is angling for bulk revenues from corporations rather than the nickel-and-dime use by pc users at home. Initially, there was no registration fee. Now there's an \$18 annual fee; there is no charge to read your own mailbox. Cost is based on the "MCI ounce," which equals 7,500 characters: an "instant delivery" costs \$1 per ounce, though a new Instant Letter could cost 45 cents if it's less than 500 characters; four-hour service costs \$30; and overnight is \$8 for the first ounce and \$1 per ounce thereafter.

MCI claims about 150,000 subscribers and a traffic of more than a million messages a month. The service can be accessed through 50 local phone numbers, or through an 800 number.

Standing on the sidelines, out of the range of fire from WU and MCI are some larger companies. GE Information Services Co. of Rockville, Md., offers the Quik-Comm System, billed as a global electronic mail network that services 750

cities and 25 foreign countries. A spokesman explains that Quik-Comm is intended for those who need a multinational mailbox service. It has more than 600 corporate subscribers, but the number of mailboxes and traffic volume wasn't available. General Electric is said to be the biggest user, however, moving 2 million messages a month. The spokesman said that pricing is complex, based on "transactions" rather than on-line time or character counts.

Not to be confused with GE is GTE Telenet of Vienna, Va., with its Telemail service. It can be accessed through the Telenet data network (in 350 cities and 50 countries) by typing MAIL and then the ID and password. Charges are based on access time (\$14 per hour from 7 a.m. to 6 p.m., \$7 from 6 p.m. to 9 p.m., and \$4 for the night) plus five cents for each 1,000 characters transmitted. Telemail claims 45,000 users, with about 150 corporate subscribers. A spokesman said traffic figures weren't available, but that traffic has been increasing 100% a year.

And, of course, there are a few dozen other services. Tymnet has OnTym to compete with Telemail. The Source and CompuServe have services geared to the home user, although businesses use them also. And Caswell notes that a lot of small timesharing companies offer electronic mail to their subscribers as a sideline.

Once again, too many vendors chasing too few customers. ●

APPLICATIONS

OF PCS AND REALTY

Bankers use pcs to revolutionize the mortgage business.

by Edith Myers

The use of computers as an offensive weapon, by companies deploying microchips to expand their existing business, is gaining allies daily, as the declining cost of hardware make a computer-based new product introduction ever more appealing. Financial institutions are among the most aggressive warriors, and technology is quickly rewriting the rules for one of the most traditional and sacred acts in American life—buying a house.

Computerized loan organizations (CLOs) are emerging and growing in var-

For fast relief

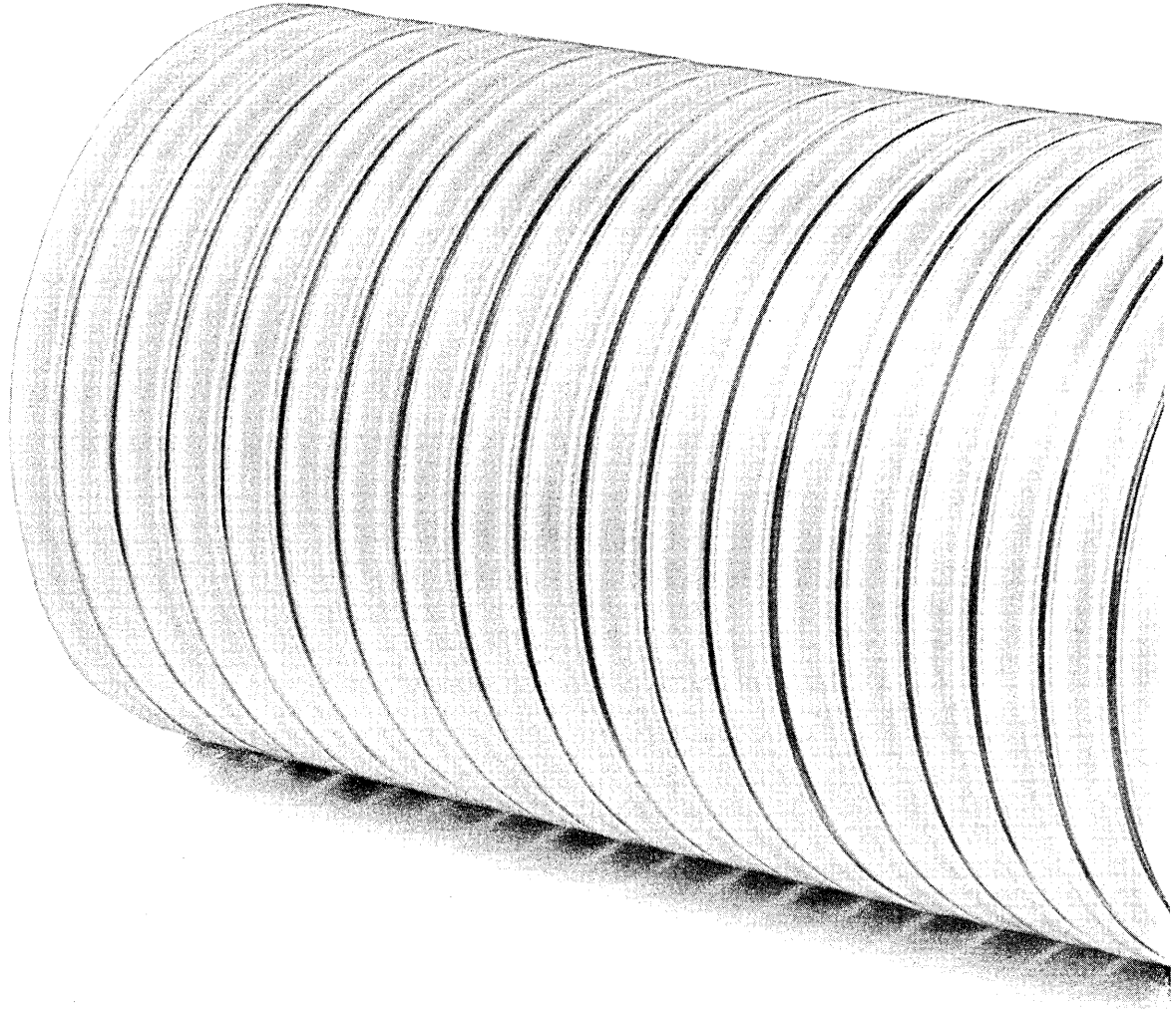

Most computer tapes are a pain.

Because they're abrasive. They're rough on tape drive read/write heads. Pass after pass, they wear them down.

And tough on you because of the problems that result from worn heads. Like erratic signal levels. Dropouts. And, worst of all, data loss.

How do you relieve these headaches? By making sure they don't happen in the first place.

By asking for the edge. The Memorex edge.

Memorex has the edge on the competition because our computer tape is the least abrasive available. We take the pains to make it right. Our proprietary "thin coating" oxide formulation is so carefully pre-mixed, dispersed and surfaced that it's uniform to ten-millionths of an inch. So there's little to bump your head.

That coating edge also makes possible the highest output at high recording densities. So your data is safe, even in extreme situations.

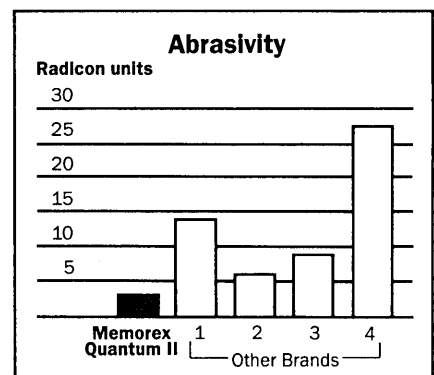

Radicon Test measurements above are obtained by running different computer tapes over an irradiated tape drive head. The higher the count of irradiated particles rubbed onto the tape, the more abrasive the tape.

of head aches.

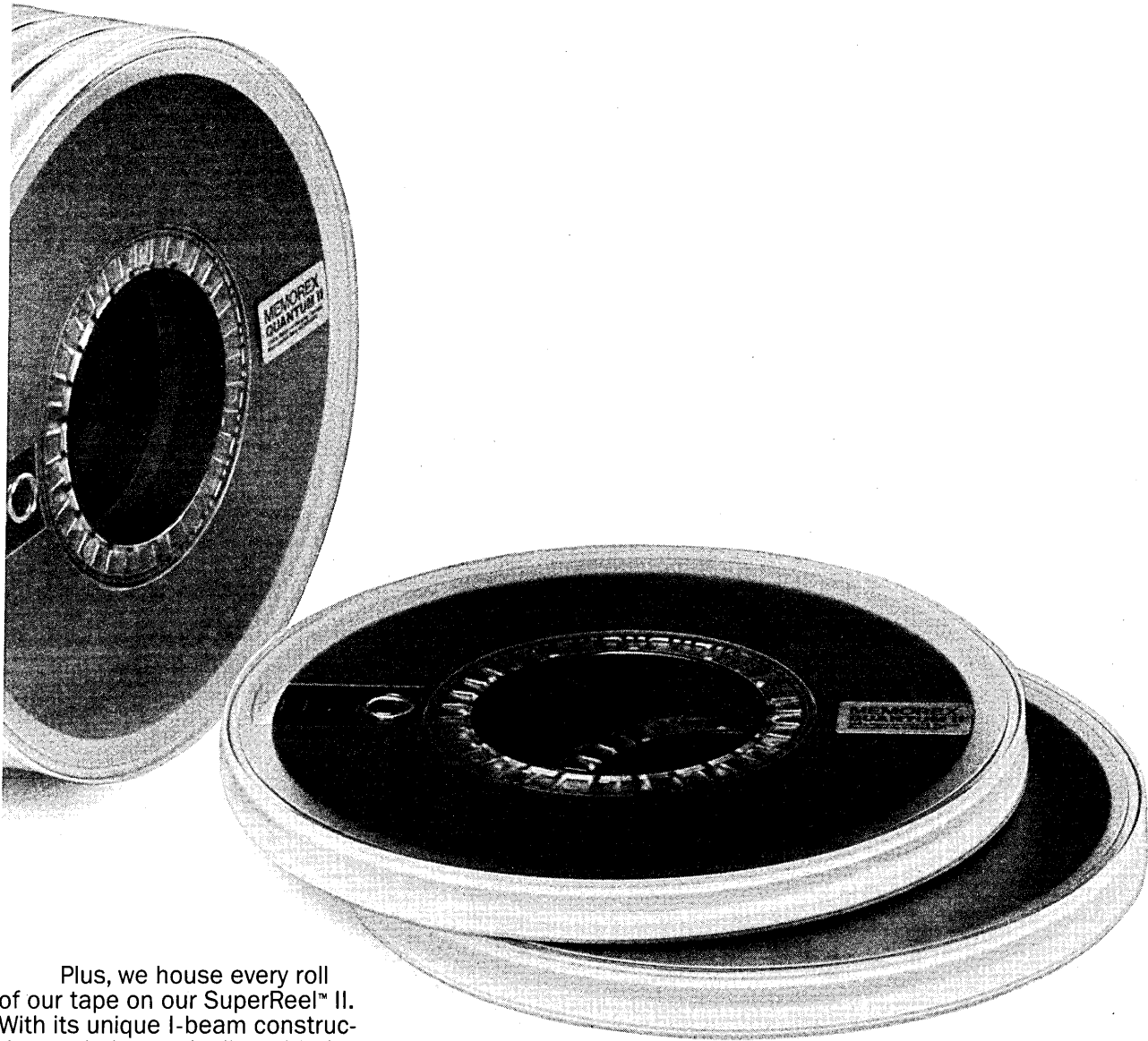

Plus, we house every roll of our tape on our SuperReel™ II. With its unique I-beam construction and ultrasonically welded flanges, SuperReel II is 90% stronger than conventional reels. So your tape—and your data—has an extra edge of safety during handling and operation.

A lot of work. But well worth it for a tape that's tested end to end, track by track. And warranted for 25 years. All of which will come as a great relief to you. And your heads.

For more information

on the full line of Memorex quality computer media products, including flexible discs, call toll-free: 800-222-1150. In Alaska and Hawaii call collect: 408-987-2961.

MEMOREX



Memorex is a registered trademark of Memorex Corporation.
Memorex has the edge is a trademark of Memorex Corporation.
© 1984 Memorex Corporation

NEWS IN PERSPECTIVE

ious parts of the country. These generally permit on-line generation of home mortgages.

"It's a two-sided sword," says Thomas Shealy, president of Trust Company Mortgage, Atlanta, who headed up a task force for the Mortgage Banker's Association (MBA) that studied CLOS and their potential impact. "On one side, they could provide some very good opportunities for mortgage bankers to take advantage of the systems to produce business in markets where they don't have branches. On the negative side, they could be used as vehicles to circumvent or bypass mortgage bankers. I wouldn't be surprised to see some of these organizations—whose business now is processing—getting into the mortgage banking business."

Indeed, one CLO already is. Compufund National Mortgage Network, Dublin, Calif., has a sister division, the

Not only are outsiders using computers to get into the mortgage business, but big city bankers can use pcs to crush local lenders.

Compufund Mortgage Banking Division, which does fund mortgages. "Our franchises don't have to opt to use it [the division's offerings]," says David Pava, president of the Mortgage Network portion of the company, "although it is on our network along with offerings of 40 to 45 other lenders."

Compufund is two years old and its franchise operation, which Pava describes as "like Century 21," has been going for six months. It has 14 franchises that can call themselves Compufund Mortgage Centers. The majority are in the San Francisco and Los Angeles areas and a couple are in Dallas. Most are mortgages brokers but "we have two banks and two realtor mortgage centers," Pava says.

The company has HP 3000-based computer centers in Dublin, Los Angeles, and Dallas and plans more, but Pava wouldn't say where. "I don't want my competitors to know what I'm doing."

Franchisees pay Compufund a one-time charge of \$15,000 and a per loan cost of 6% of the spread between wholesale and retail loan value. They, in turn "sponsor" realtors who pay \$75 per month per office. This is paid directly to Compufund, which returns \$25 to the sponsoring franchise and sets aside another \$25 in an advertising fund.

Realtors can access the Compufund network via portable terminals and Tymnet. "A realtor sitting on an open house on a Sunday can lock in a loan commitment from a phone in a kitchen," says Pava. Currently, there are about 100

realtors on the system. Most, he noted, already had terminals for access to Multiple Listing Services.

Compufund is planning to move from terminals and printers on its franchise premises to IBM PCs, "so they can download from the centers and do some local processing."

A CLO that already offers local processing is Shelternet, an offering of First Boston Capital Group of New York. Shealy of the MBA task force sees this as the most viable offering right now. "It is the only one that is really national."

"It's a truly distributed system," says Gaye Torrance, Shelternet's director of marketing communications. "It's a technology-based mortgage system that delivers mortgage products to sites across the country. We've retrofitted and customized IBM PCs."

The hub of Shelternet is an IBM 4381 in Tarrytown, N.Y. More than 150 loan originators signed up, in effect buying turnkey systems from Shelternet—a modified PC and software—for \$17,500. Training at Shelternet's Tarrytown training center can cost up to \$600 depending on the user's expertise. Once his system is linked to the network, an originator pays Shelternet between \$200 and \$300 per loan application.

"Our system takes a consumer from loan application through to closing," says Torrance. Things like tax tables and underlying guidelines are stored in the PCs, which can analyze from eight to 10 different loan plans for a prospective home buyer.

Shelternet has been operating since April 1983. Most of its originators are mortgage company subsidiaries of real estate firms. "However," says Torrance, "we do have some mortgage bankers, savings & loans, and commercial banks on the system." She explains that Shelternet, "on the average," processes some \$100 million in mortgage financing per month or about 800 applications.

Two other CLOS studied by the MBA task force are still in pilot operation. One is Rennie Mae (Realtor's National Mortgage Access Network), an offering of the National Association of Realtors (NAR), and the other is PRC Loan Express, a subsidiary of Planning Research Corp., McLean, Va.

Rennie Mae, says Jack Good, the NAR's director of network services, was conceived two years ago. At year-end it had completed phase one of product testing in the San Diego area with phase two about to get under way. In the first phase, lenders transmitted mortgage information to realtors using dumb terminals. A variety of PCs will be used in phase two. "Our software is written in C," says Good, "which allows running on lots of

machines. PCs will be used at both ends [lenders and realtors], tied together via GEISCO." Pricing for Rennie Mae will be determined at the conclusion of this phase. It should prove competitive since NAR is a nonprofit organization.

Good says Rennie Mae is "not a loan originator in the technical sense of the word. It's a kind of sales tool for lenders that gets their mortgage products in front of the buyers. For the realtors, it helps qualify a buyer and analyze a particular mortgage for a particular buyer."

The MBA's task force report viewed Rennie Mae as the least threatening of the CLOS and even went so far as to recommend MBA explore the possibility of entering into a joint venture with the NAR in utilizing its network.

PRC Loan Express is in pilot operation in metropolitan Washington, D.C., where it has about 30 lenders participating, 40% of which, interestingly, are mortgage bankers. Fees are \$450 per month to be listed on the system and to lease a terminal. A 1% fee is charged for each loan processed by PRC and funded by the lender.

MBA's Shealy, while concerned about the possibilities of CLOS getting into the mortgage lending business, is quick to admit that the reverse is possible, that mortgage bankers could get into computerized lending. "We'll see some of that, particularly among the big companies. In my company, we have in-house computer processing of loans for our own efficiency. We could add terminals and screens and provide that [computer-based lending via realtors] ourselves, but I'd have to see a lot of business out there before I'd consider it." ©

BENCHMARKS

BUYS INTEL DBMS: Branching out of the statistical analysis niche in which it has successfully competed since its inception, the SAS Institute Inc. purchased Intel's sagging System 2000 DBMS. The Cary, N.C., firm has assumed all support activities for the product's 600 licensed users on IBM, Control Data, and Sperry mainframes. SAS Institute said it would also develop interfaces between the DBMS and its proprietary Statistical Analysis System. Included in the deal, which was for an undisclosed sum, were Intel's related products, such as the QX query language, the Flex database language, and a report writer. The Santa Clara company's Idis and Fast 38 products were not included in the transaction. As part of the deal, SAS will most likely take over Intel's Austin, Texas, operations. Intel's End-User Systems Operation, which had marketed System 2000, is being moved to Phoenix.



Sterling Stands Out In Systems Software

Whether your immediate data center concerns are in the area of operations, communications, or quality assurance, Sterling Software Marketing has a system that will give you more control, more productive work time, and more operating economy.

In **Operations Software**, we offer DMS/OS — for DASD management with unbeatable reporting, data compression and archival to disk or tape features. Plus, modular enhancements able to meet any DP center need.

For **Data Center Production Control**, take a look at ESP to give you comprehensive job submission and scheduling — no matter how complex the job.

We can expand your **Communications** capability from mainframe-to-mainframe and mainframe-to-mini, with software like TRACS, that

gives you teleprocessing remote access control for batch data transfer, and our new SUPERTRACS — an on-line batch teleprocessing monitor. For batch transfer from PC-to-mainframe/mini/micro we offer an economical networking solution with PC-TRACS.

SSM meets the challenge of the growing concern for **Quality Assurance Software** systems with COMPAREX, an accuracy assurance utility for data and text file comparisons.

For detailed information on any SSM product, or a free, no-obligation 30-day evaluation, call us TOLL FREE 800-824-8512. In California, Hawaii, Alaska, and Canada, call collect 916-635-5535.



**STERLING SOFTWARE
MARKETING**

11050 White Rock Road, Suite 100
Rancho Cordova, CA 95670-6095

International Offices: Duesseldorf, London, Paris.

CIRCLE 32 ON READER CARD

**IT'S 3 A.M. DO
ACCESSING YOUR**

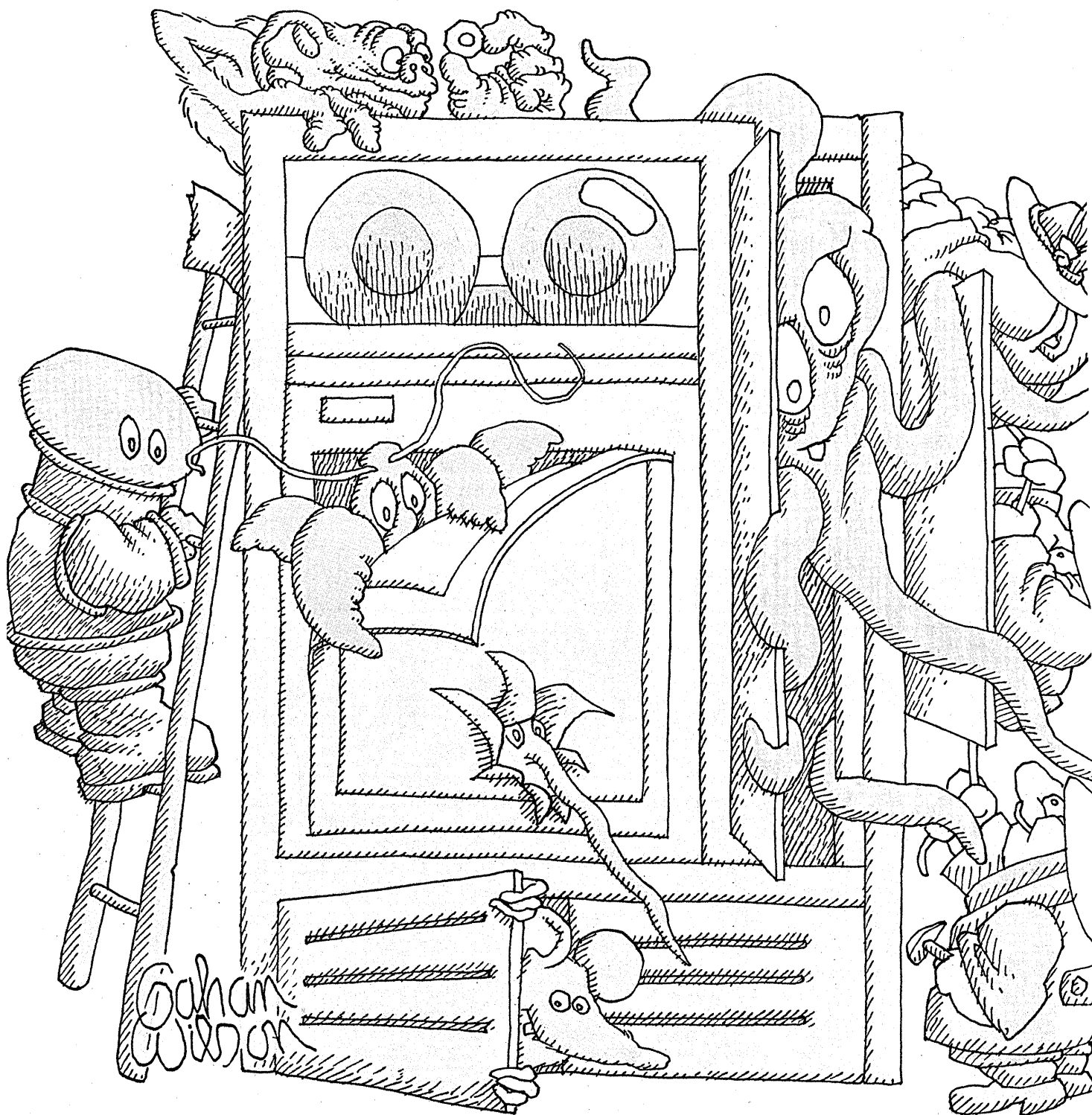

PROTOCOL. THE END OF THE

YOU KNOW WHO'S MAINFRAME?

This real life nightmare can make any DP manager lose sleep.

You want to give more people access to your corporate mainframe, so they can get the information they need.

Which is nice.

Except that when you start adding terminals in different locations, how do you control access?

How do you restrict who can upload—and who can download? How do you keep hackers, intruders and other undesirables from invading your mainframe?

DATA COMMUNICATIONS PRODUCTS FROM PROTOCOL COMPUTERS. TECHNOLOGY THAT HELPS DP MANAGERS STAY IN CONTROL.

Rest easy. PCI can show you how to connect virtually any ASCII device to an IBM mainframe. And control mainframe access with positive security.

For example, our PCI protocol converter boxes and PCI-Link add-on communications board both require users to identify themselves with a special password before they can access your host.

That gives you an extra measure of protection.

What's more, PCI protocol converter boxes also offer automatic log-off. So even if your user forgets, your PCI protocol converter will automatically disconnect from the mainframe. Which means unauthorized inquiries are automatically locked out.

FOR MICRO TO MAINFRAME COMMUNICATIONS, NO ONE TALKS TO IBM LIKE PROTOCOL.

There's another reason you know you're secure

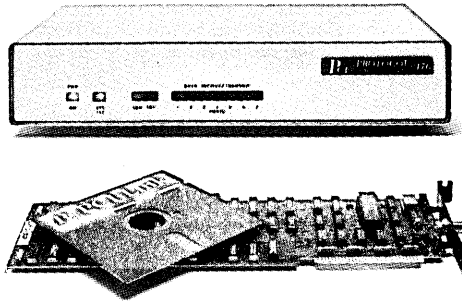

Only Protocol Computers offers both protocol converter boxes and add-on communications boards with positive security features to help you control who gets access to your mainframe. And who doesn't.

with PCI. We're the leader in protocol conversion technology.

In 1980, we introduced the first successful protocol converter. And today, more than 9000 PCI boxes are installed worldwide, handling data communications for leading companies in diverse industries. Including aerospace. Oil. Packaged goods. Manufacturing. Banking. And retail.

The fact is, PCI connects more ASCII devices to more IBM mainframes than any other protocol converter manufacturer.

And PCI is the only single source that offers a complete range of data communications products.

Advanced protocol converter boxes. Communications boards. And powerful support software.

So we can show you how to connect virtually any ASCII device to an IBM mainframe—in Bisync and SNA/SDLC.

With greater performance. Less cost. And the positive security you need.

For complete technical information on the full range of PCI data communications products, call 1 (800) 423-5904. In California, 1 (818) 716-5500. Or just send the coupon.

Your DP nightmares are over.



I want to wake up from the DP nightmare. Please send me my free "The End of the DP Nightmare" kit today.

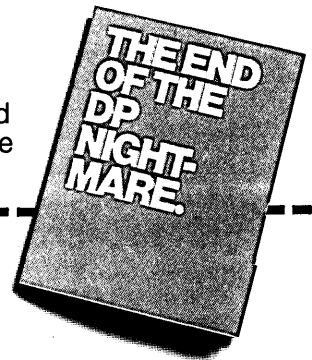

Protocol Computers, Inc.
6150 Canoga Avenue
Woodland Hills, CA 91367

Name _____ Title _____

Company _____

Address _____

City _____ State _____ Zip _____

Telephone _____

© Copyright 1984 Protocol Computers, Inc.
IBM is a registered trademark of International Business Machines Corporation.

DP NIGHTMARE.

CIRCLE 33 ON READER CARD

DAT 1/15/85

NEWS IN PERSPECTIVE

DUAL OPERATING SYSTEM:

Amdahl Corp., continuing its efforts to provide operating system alternatives to IBM, introduced a hardware option that enables users to run multiple dissimilar operating systems within a single cpu. The product, 580/MDF (for Multiple Domain Feature), is available for any of the five mainframes in the 580 line, the Sunnysvale, Calif., company said. The set of microcoded logic boards fits inside the mainframe's chassis, replacing existing hardware, and can be installed in the field in about eight hours, the company said. No program changes or software additions are required. The boards contain no additional system resources, but they allow single engines to support concurrently dual copies of MVS/370, MVS/XA, or VM/SP. The coexisting operating systems are partitioned so that neither can interact with the other. The 580/MDF product cannot be purchased, but it will be available in the second quarter for a \$20,000 installation charge and a \$6,000 monthly fee.

REORGANIZES: As part of its continuing digestion of Rolm Corp., IBM reorganized some of its manufacturing and development organizations, creating a new Telecommunication Products Organization (TPO) in the process. The TPO, headed by former Satellite Business Systems (SBS) president Stephen B. Schwartz, is responsible for coordinating operations with Rolm and for joint marketing with SBS, which is part owned by IBM. The organization, which derives some of its responsibilities from IBM's National Accounts Division, is charged with developing IBM's direction for voice and data PBX and telecommunications products. It does not provide strategic direction to Rolm, however, as the Santa Clara subsidiary will continue to report directly to IBM vice chairman Paul Rizzo. TPO joins the Communication Products Division, the Entry Systems Division, and the Industrial System Organization as part of the Information Systems and Communications Group. The Information Products Division and System Products Division, once parts of that group, now form the new Information Systems and Products Group.

NSA'S SUPERCOMPUTER: It was as much who said it as what was said. Most people knew the \$12 million Supercomputer Research Center (SRC) was coming, but few expected the top secret National Security Agency to appear in public and confess that it is the executive agent for the project. "In the past, NSA got a machine or a lab and you never knew about it," says Prof. Kenneth Wilson, a Cornell University Nobel laureate.

Not this time. The facility, to be located at the University of Maryland Science and Technology Center outside Washington, is slated to apply its supercomputer research to NSA and selected Department of Defense problems. The employees—expected to number around 100 of the top engineers and scientists in the country—along with 70 technicians, will work for the Institute of Defense Analysis, the DOD's national security think tank.

If all goes according to plan, this could be the most super supercomputer in existence, one that would produce an extraordinary generation gap. Air Force Lt. Gen. Lincoln Faurer, director of NSA, said the center's research will be directed at building a new generation 10,000 times faster than the present generation. The SRC says it will support industry supercomputing research projects and have industry members on its scientific advisory board. There will also be significant interaction with universities, and the Defense Advanced Research Projects Agency—engaged in some supercomputing experiments itself—will share information with the SRC. The SRC even promises to make "unclassified research results available to industry and universities." What's unclassified? According to government sources, that's a secret.

EOSC ANYONE? Twelve years after it first entered the office automation market, Exxon Corp. is ready to pull out, if only someone would buy its troubled Exxon Office Systems Co. subsidiary. Trouble is, no one seems interested in buying the subsidiary of the New York oil giant, despite some printer products that were highly praised when they were first introduced a year ago. Formed by merging Vydec, Qyx, and Qwip, three Exxon Enterprises units, EOSC is currently worth about \$100 million, analysts said. The three groups within EOSC sell word processing, electronic typewriter, and facsimile equipment. Based in Stamford, Conn., EOSC employs 2,400 people, and may have lost as much as \$500 million in the last dozen years.

BUYS INTO DELPHAX: Supplementing its strong 9700 series of laser printers, Xerox Corp. purchased 50% of Delphax Corp., a Westwood, Mass., vendor of nonimpact printers. The firm uses a unique ion deposition technology for its printing systems, which produce up to 60 pages per minute. Xerox bought the share from Canadian Development Group, a holding company 47% owned by the Canadian government, for about \$20 million (U.S.). The other 50% share in Delphax, owned by Dennison Manufacturing Co., Waltham, Mass., is unaffected by the sale. Separately, Xerox announced that it is

shifting its Memorywriter electronic typewriter line from its Dallas Information Products Division to its Diablo Systems facility in Fremont, Calif. The remaining three product lines made by the IPD, all of which have been losing money, will be discontinued, Xerox said. About 1,600 workers are employed at the Dallas plant.

CLOSES SYNERTEK: A weakening semiconductor market spelled gloom for two vendors, as Honeywell was forced to close its Synertek subsidiary and Texas Instruments laid off 2,000 employees. Honeywell, which bought Synertek in 1978 as the low-end chip maker was riding the crest of the video game wave, fired 1,500 employees as part of the closure. While Honeywell did not disclose the amount of money lost by the subsidiary over the last few years, its displeasure was apparent in the succession of five chief executives that paraded through Synertek since 1982. Honeywell will take a one-time charge in the quarter ended Dec. 31 to write down the assets and costs of closing the subsidiary, which may reach \$70 million to \$100 million. The subsidiary was based in Santa Clara and Santa Cruz, Calif., and had an additional facility in Singapore. Texas Instruments, meanwhile, cut 2,000 employees and reduced work schedules for other workers. While the firm would not indicate which facilities were affected, it did say the layoffs were due to slackening order rates, which in the three months ended Sept. 30 dipped below the pace set early in 1984.

SHARED-TENANT VENTURES: Honeywell and AT&T both broadened their entries into the so-called "smart building" market through agreements with other firms (see "One for All, All for One?" Oct. 15, p. 56). Honeywell purchased 50% of Sharecom-Houston, which provides shared-tenant communications services to a 500,000-square-foot office complex in Houston. Honeywell's stake in the firm, now called Honeywell-Sharecom, was purchased for an undisclosed amount of cash from Tel Management Corp. of Dallas and the Office Communications partnership of Houston. The office complex uses a Rolm CBX II PBX as the basis for its services, under which multiple tenants in the office complex share a single data and voice communications complex. Separately, AT&T Information Systems and United Technologies Building Systems Co. completed a partnership to sell similar services. The two firms each own half of ShareTech, which provides six office buildings with shared-tenant facilities. ShareTech employs 170 people, contributed by the subsidiaries of both AT&T and United Technologies. ©

YOU WANT A LOCAL COMMUNICATION NETWORK WITH FEATURES THAT MEET YOUR NEEDS.

SHOULDN'T YOU BE COMFORTABLE WITH THE COST, TOO?

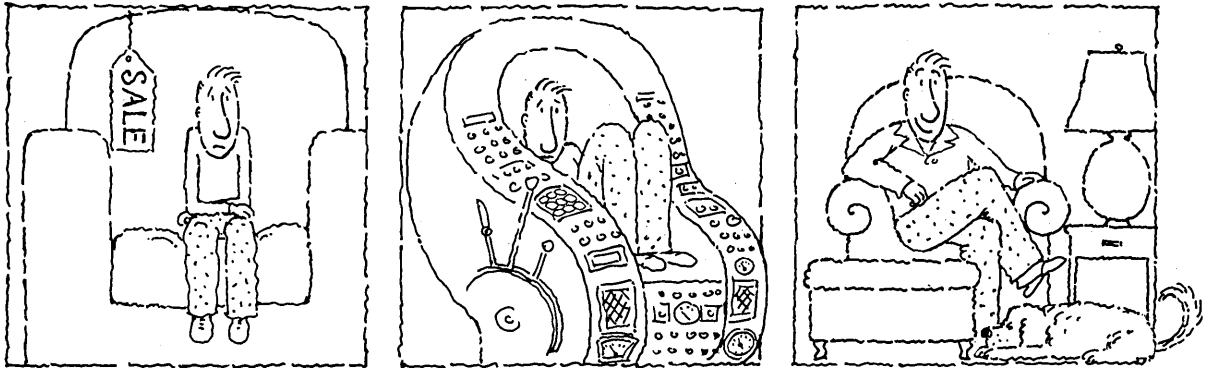

Your local communication network will be around a long time, so it has to be comfortable functionally—and financially.

Reduce costs at every stage

With the IDX3000® digital data switch, you can size your local communication network to meet your budget and capacity needs of today. Start with a small system—a Network Exchange and enough multiplexers to support a few hundred lines. As you grow, just add Network Exchange circuit boards and multiplexers.

Total acquisition costs are lower than traditional switches because the distributed architecture of the IDX3000 allows a 24 to one line concentration, giving you substantial savings on wiring costs. (Often, you can use extra wires that already exist in your facility.) In addition, you don't have to buy short-haul modems for users as far away as one mile. To save you space, the entire 3072-line Network Exchange is housed in a single six-foot rack.

Fault diagnosis and repairs are fast and inexpensive as a result of automatic, continuous self-testing and failure isolation and identification. Automatic switch-over to optional backup boards when a failure is detected means your users have uninterrupted access to network resources. And,

you can replace failed boards without shutting down your system.

For the office of now

Expandability to more than 3000 lines means the system can grow with your needs. Optional redundancy features protect you from costly down time. The IDX3000 isn't one of those products of the future. It's here now—proven, in use, and backed by M/A-COM, one of the nation's largest communication companies.

If you have or need more than 200 terminals, contact us. We have comforting financial news about local communication networking. M/A-COM LINKABIT, INC., 3033 Science Park Road, San Diego, CA 92121. Outside California, call toll free (800) 626-6640.

Representatives: San Diego, Judy Wheatley, (619) 457-2340; Boston, Mike Murray, (617) 863-8420; Washington, DC, Harry George, (301) 428-5500.

IDX3000 is a registered trademark of M/A-COM LINKABIT, INC.

© 1984 M/A-COM LINKABIT, INC.

THE NO-RISK NETWORK



CIRCLE 34 ON READER CARD

THE COMPUTER AGE
 THE COMPUTER AGE
 THE COMPUTER AGE



The computer age is here, and it's here to stay. It's not just a passing fad, but a permanent fixture in our lives. From the way we work to the way we play, the computer is changing everything. It's making our lives easier, more efficient, and more fun. So get ready to embrace the computer age, because it's here to stay.

It's not just a passing fad, but a permanent fixture in our lives. From the way we work to the way we play, the computer is changing everything. It's making our lives easier, more efficient, and more fun. So get ready to embrace the computer age, because it's here to stay.

The computer age is here, and it's here to stay. It's not just a passing fad, but a permanent fixture in our lives. From the way we work to the way we play, the computer is changing everything. It's making our lives easier, more efficient, and more fun. So get ready to embrace the computer age, because it's here to stay.

The computer age is here, and it's here to stay. It's not just a passing fad, but a permanent fixture in our lives. From the way we work to the way we play, the computer is changing everything. It's making our lives easier, more efficient, and more fun. So get ready to embrace the computer age, because it's here to stay.

WORLD WATCH

TOKYO--Old friends IBM Japan and Nippon Telegraph & Telephone Public Corp. are working together to make sure there's harmony between Big Blue's SNA and NTT's Data Communications Network Architecture (DCNA). By signing the same compatibility sone, the partners hope to get a head start in the local VAN race that's set to start April 1 when Japan loosens its tightly controlled telecom market a notch or two. If the IBM-NTT combo becomes the VANGUARD, then AT&T and its friend MITI will be under the gun to bring the NET 1000 offering up to speed.

ROME--The PTTs took a few punches from Kap Cassani, president of IBM World Trade, who criticized the European telecom titans for not spelling out their views on VANS. "Legislation," said Cassani, "is fundamental to the prospects for value-added networks." While the IBM Europe chairman admitted the company was disappointed by the VAN block in Britain, "at least the situation in the U.K. is now clear," he said.

BRUSSELS--Word has it that there's some creative accounting going on with Esprit, the \$1.3 billion pan european R&D program sponsored by the European Commission. Some of the companies in on the prestigious project are claiming inflated consultancy fees and using the leftover money as their contribution of the jointly funded EEC effort. As a result, the EEC pays for the bulk, it not all, of the project--hardly the community spirit Esprit was supposed to foster.

MUNICH--German giant Siemens is throwing its weight behind a new European consortium of dp companies that are getting ready to announce coordinated development of Unix System V for the European market. The idea is to avoid what one Siemens executive called "the emergence of too many subversions" of the operating system.

RIO DE JANEIRO-- Ahston-Tate has packed its bags and headed south, not for some fun in the sun, but for fights in the courtroom. The Yankee vendor has slapped 21 companies in Brazil with software products. The defendant list reads like a Who's Who in corporate Brazil and includes such mighty multinationals as Citibank.

TOKYO--Hot on the heels of the phantom fifth comes word of Japanese efforts to go after Josephson Junction Lisp machines. and biological chips that could fuel the sixth generation. Following the familiar form without substance format are recommendations in a confidential report from Japan's Science & Technology Agency that plant seeds for biocomputer research.

MOSCOW--The U.S.S.R. has begun production of a 20-Mflops supercomputer called the PS 2000 that Russian developers claim outperforms CDC's Cyber 73. In fact CDC, the Soviets say, had originally agreed to help design the machine--a move that was subsequently quashed by the high-tech trade embargoes.

THE FUTURE OF 2400 BPS MODEMS IS LOOKING UP.

And so is yours.

Because compared to 1200 bps modems, our 2400 bps modems can effectively double your productivity.

Without doubling your costs.

How?

Simple. 2400 bps modems do everything twice as fast.

You can fill a screen in 8 seconds instead of 16. Transfer a full floppy in 24 minutes instead of 48. And cut your line costs in half by staying on the line half as long.

But more important, all this productivity is now

worth the price. Because the prices of Racal-Vadic 2400 bps modems have just come down.

Now it doesn't cost twice as much to go twice as fast.

In fact, you'll find very attractive prices on all five of our 2400 bps modems.

Including our high-density rack-mount. An international modem. Two desktop types. One of which is our top-of-

the-line model. It can down-line load and store dialing directories, log-on sequences and security passwords. And

offers switch-selectable synchronous/asynchronous communications.

There's even a new internal modem for the IBM® PC that's so uncompl-

cated even the person who wrote this ad can use it.

They all offer standard

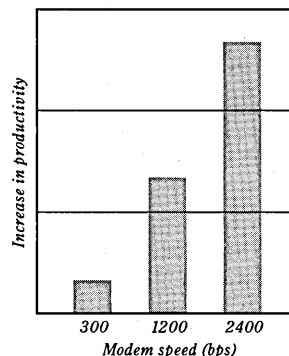

RACAL

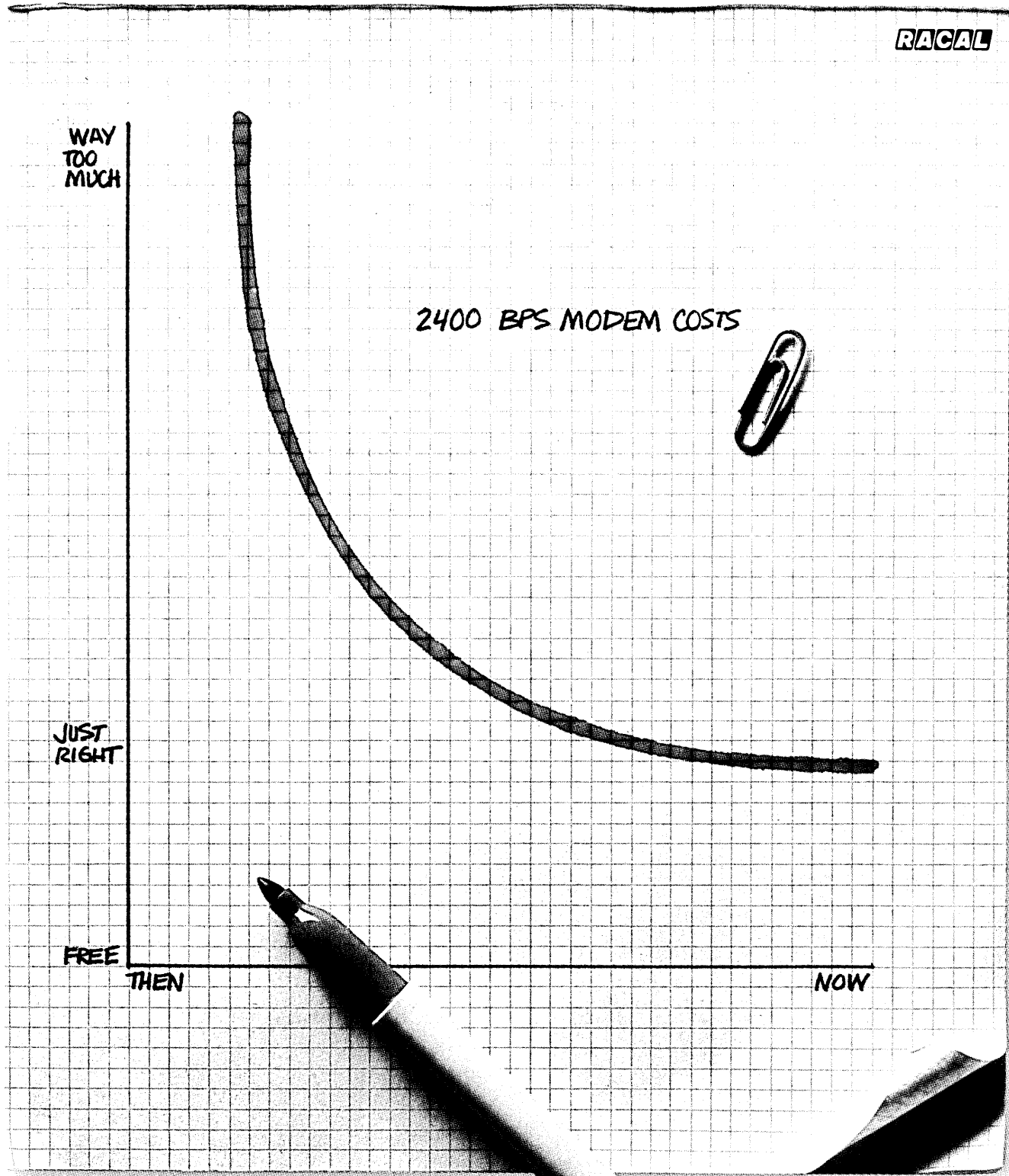

features like remote diagnostics, automatic dialing directories and complete unattended operation.

But unlike other 2400 bps modems, all ours switch automatically between 2400, 1200 and 300 bps. So you can

keep in touch with those less far-sighted than yourself.

Now that you've had a look at the future, here's how to get there.

Call 800-543-3000, Operator 507. In California, 408-946-2227.

Or write if you have the time. Racal-Vadic, 1525 McCarthy Blvd., Milpitas, CA 95035.

Racal-Vadic

Makers of The Maxwell Modem.™

CIRCLE 36 ON READER CARD

© 1984, Racal-Vadic. IBM is a registered trademark of International Business Machines Corp. The Maxwell Modem is a trademark of Racal-Vadic.

The dp industry has produced more than its share of megaflops, and each of them can teach us something.

LEARNING FROM LEMONS

by Philip H. Dorn

Oft on a bleak winter's night, memories swirl through dark corners of the mind. Recollections are triggered by odd thoughts. A swatch of carpet in an odd orange-brown color recalls Viatron. The nightly ski report, snow in the Rockies, reminds us of Storage Technology nestled in the Colorado hills. The Phoenix Suns are in town, and we remember first visiting General Electric on Black Canyon Highway some 20 years ago. A note in the paper about the federal prison population, and we can't help but think about OPM.

The philosophers tell us to study the past, learn its lessons. Other-



wise, the same mistakes will be made again and again. With the commercial computing industry reaching the ripe old age of 35, we now have a bit of a past to study. We also have a good supply of follies, failures, and fiascos. Why not consider what a few of them can teach us?

What follows is an arbitrary list of lemons, based totally on personal choice and interest. How do I define failure? Dollars and jobs lost are important, but the criterion to which I've paid the most attention is impact on the consciousness of the industry. I'll start in the distant past, when that consciousness was different from today's.

Once upon a time, Snow White

and her faithful seven, a term invented by then-DATAMATION editor Bob Forest, coexisted on reasonable terms. IBM made money, the others picked up crumbs that fell off the table. The septet was comprised of Burroughs, Univac, NCR, Control Data, Honeywell, General Electric, and RCA. Today, from the dwarfs of the '60s, only Burroughs and Sperry really remain. NCR has gone off into smaller systems. CDC went toward peripherals and large-scale scientific systems. Honeywell threw in the towel and became a marketing wing for its onetime dependency, Nippon Electric Corp. A couple of new players have emerged—Amdahl Corp., now a Japanese mandate 49%



PHOTOGRAPHS BY STEVE

There have been so many microcomputer companies that a computer should be put to work tracking them.

owned by Fujitsu, and NAS, a sales wing for Hitachi. Things have changed.

So what happened to General Electric and RCA, two of the largest companies in the world, then and now oriented to technology? Why did they fail to cut it in the computer business?

General Electric. Many of the old-timers remember GE with fondness. Most Prime users don't know it, but they are really running a direct descendent of GE's pioneering timesharing operating system, Multics, when they fire up Primos. Long before IBM's TSO and VM, you could buy a packaged timesharing system from GE, the 430, built around a GE 400-series mainframe front-ended by a Datanet 30. Yet another major GE innovation appeared in the early '60s, the first true database management system. Charlie Bachman's IDS, first written for the GE-225, is the forerunner of today's DBMS.

So, how did a company with so much technology go wrong? Why the eventual sellout to Honeywell when so many loyal GE users were around? If a company has technology and an installed base, it ought to survive.

GE had a major problem with the top management of its computer operation. In those days, GE corporate doctrine was that any competent manager could run anything. Management of the computer division turned over so fast that the engineers and designers could do anything they pleased. Before the top brass grasped binary arithmetic, they were back in upstate New York building turbines and jet engines. The only high-tech, IBM-trained executive who ever reached Phoenix was the gifted John Haanstra. But his sudden death left the division leaderless just at a time the full power of IBM's System/360 was beginning to be felt.

BETTER TO SPEND ON JETS

GE's corporate brass looked at computing, tried to balance future revenues and profits against capital needs, and came to the conclusion GE would be better off spending its money on jet engine and nuclear power plant development. An objective decision? Probably. A sound decision? Probably not, especially with hindsight. A good buy for Honeywell? Absolutely. Some of the customers remain in the Honeywell family to this day, and for years, key Honeywell decision-makers were former GE employees.

The lesson: if you don't have the willpower and financial resources to stick it out, perhaps it is better to cut your losses and get out having lost only millions, and not billions.

RCA. Way back in the '40s and '50s, RCA was a world leader in memory technology. Nobody was certain if vacuum tubes, mercury delay lines, or Williams's cathode ray tubes would be the basis for computer memories, but most researchers felt sure RCA would be involved. With top managers strongly interested in high technology and accustomed to backing their judgment with hard cash, how could RCA fail?

In the early years, RCA built a medium-sized base of installed systems with names like 301, 501, and 3301. The machines worked but were more famous for having the gaudiest console lights in the industry. Later on, after the IBM 360 changed the game, RCA came up with its Spectra/70 line. Each individual processor was positioned in a gap between IBM units. Finally, just before the end came the single-digit machines, 2, 3, 6, and 7. Hardly anybody cared anymore.

RCA's users will attest to the company's peculiar habit of always being just a little short of IBM in speed and reliability. Years later, it was discovered that as a cost-saving maneuver RCA had been less than generous on internal parity checking. There were constant peripheral problems. RCA never liked disk files and kept trying to push a massive electromechanical device, the RACE file, on its unwilling customers. Printers were another trouble spot. There were several Spectra mainframes wedded to IBM 1403 and 1404 (billfold) printers.

In software, RCA's operating systems were aimed to be somewhere above DOS but below OS/360. In essence, the systems were "almost compatible." That wasn't good enough.

After several years of losses, and in a period of changing RCA corporate management, the computer division came under fire. It never was really clear how much money was being lost. Old DATAMATION files indicate a great deal of confusion between corporate and divisional accounting, a panic decision to sell out, and a hasty search for a buyer. Sperry, then called Univac, won. For peanuts, Blue Bell received a field sales and support force, an installed base of convertible customers, and the potential for a good deal of revenue.

The lessons: if you are going to go against IBM up and down the line, you had best be prepared to lose a lot of money without whimpering. And if you are going to sell compatibility, you had better be completely, 100% compatible.

In the computer world of the late '50s, racing around the country, their offices under their hats (men wore them in those days), were such unique individuals as Harvey Goodman and Saul Steinberg.

They were selling a simple idea: buy your computer from us. We'll take care of the financing. IBM will handle the maintenance. IBM doesn't like this because it wants you to rent everything. But IBM must sell it to us because of the 1956 consent decree.

A lot of people will remember DPF&G, Leasco, Levin-Townsend, Randolph Computer, Booth, Republic Leasing, or half a hundred others. Many of them still exist in one form or another. Then of course there are the never-to-be-forgotten OPM and Itel, each worth a volume in itself

A CLASSIC CASE OF FRAUD

OPM. Variouslly dubbed Other People's Money and the Mork and Mindy Show, this was a classic case of fraud. The founders, Weissman and Goodman, today are long-term guests of Uncle Sam. The court-appointed trustee in bankruptcy, Jim Hassett, produced an encyclopedic volume explaining the ins and outs of the scam. Getting it down to bare bones, it seems OPM took paper alleged to be signed leasing contracts from customers to the banks, borrowed against the paper, bought the machines and delivered them to the users. The only hitch was that the original contracts either did not exist or had been falsified. OPM got its cash illegally. Some of the loot went to pay back earlier illegally obtained loans. The remainder went into the principals' pockets. Not a nice story.

The lesson: you can cheat some of the people some of the time, but if you cheat the banks, you can win almost all the time. Sooner or later Uncle Sam will catch up with you, but along the way you can have a lot of fun.

Itel. Ah Itel! How can one forget the plush oriental carpets, the top-quality artwork, the glorious views of San Francisco, and the speed with which the whole enterprise collapsed?

Itel was a successful leasing company, and as it prospered, a crackerjack field marketing force developed. It branched out into manufacturing IBM-compatible computers and began to import machines from Hitachi. Things were going along swingingly until IBM changed the basic rules of the game. No longer could a leasing company plan for a system to be marketable for six or eight or 10 years. In the new world, machines would replace their predecessors in four years. Prices were dropped, performance improved.

Where did this leave Itel? Staring out at the bay with unsellable machines. In the leasing business, profits come at the end of the cycle. Up front, you are paying off the machine's manufacturer. Soon enough,

SCIENCE / SCOPE

Satellite images have led to the discovery of a large Mayan city hidden for centuries by the jungles of Mexico's Yucatan peninsula. Scientists uncovered over 100 possible ancient sites by studying false-color images provided by Landsat earth resources satellites. Jungles typically are made to appear bright red in these pictures. The ruins appeared pink or light red, because foliage had not grown as densely over the sites as it had in the neighboring jungle. The Landsat images also revealed the existence of vast farmed fields that may prompt new theories of how the ancient civilization was able to feed itself. The imaging instruments aboard the Landsat satellites, called multispectral scanners, were built by the Santa Barbara Research Center, a Hughes Aircraft Company subsidiary.

A U.S. Army laser device has been made less costly and more reliable by manufacturing its housing assembly in a new way. The improvements were made to the Ground/Vehicular Laser Locator Designator, which determines the distances to targets and pinpoints them for laser-homing weapons. The original housing assembly was made from a number of aluminum sections bonded together. The Value-Engineered housing is a one-piece fiberglass-nylon structure cast under high pressure. The changes stem from technology that was not available at the time the original contract was signed. Under the Department of Defense Value Engineering program, Hughes will share in the savings. The Value Engineering program is designed to encourage employees to look at the functions of a product and develop alternatives that cost less, perform better, and improve reliability.

A new vector network analyzer for millimeter-wave devices lets microwave designers make broad-band measurements at frequencies up to 110 GHz. The Hughes system uses a downconverter technique to convert a millimeter-wave signal into a frequency suitable for measurement on the Hewlett-Packard 8410 microwave vector network analyzer. The system permits analysis of all four S-parameters after a single insertion of the device under test, either in real time or, for enhanced accuracy, by computer-control using error-correcting software.

Development times for semicustom very large-scale integrated (VLSI) circuits have been cut from greater than one year to 20 weeks at an ultramodern computer-aided training and design center at the Hughes facility in Newport Beach, California. Utilizing advanced design automation software, a comprehensive library of predesigned logic functions (called Macros), and preprocessed wafers, the new facility is helping engineers design chips with 2,000 to 8,000 gates and with as many as 180 pins. New 3-micron dual-layer metal HCMOS processes are applied to both standard cell products and state-of-the-art gate arrays. Skilled design engineers and education specialists at the Newport Design Center provide training and technical support for IC designers throughout the company.

The Hughes Tucson facility, located in picturesque Southern Arizona, is a large, modern manufacturing complex with capabilities for producing advanced missile systems developed by Hughes. We have openings for experienced and graduating engineers to work on such advanced systems as the electro-optical Maverick, radar-guided Phoenix, TOW, and AMRAAM, the Advanced Medium-Range Air-to-Air Missile. Please send your resume to Professional Employment, Dept. S3, Hughes Aircraft Company, P.O. Box 11337, Tucson, AZ 85734. Equal opportunity employer. U.S. citizenship required.

For more information write to: P.O. Box 11205, Dept. 65-9, Marina del Rey, CA 90295



If you are going to sell compatibility, you had better be completely, 100% compatible.

gone were the profits, followed shortly by Intel's founders, their artwork, and their company.

National Semiconductor created NAS out of the debris of Intel, acquiring the field sales and support forces in the process. The rest of the company spent years in Chapter 11 and only recently reemerged as a railroad car leasing company (which is where it all began, years ago).

The lesson: don't build a business counting on IBM not to change the rules, because as sure as night follows day, IBM will trap you.

Contrary to popular myth, the microcomputer industry did not spring full-grown from the brow of Steve Jobs. The very first viable microcomputers didn't even come from California, but appeared in kits shipped out of Albuquerque, N.Mex., in January 1975. The MITS Altair, based on the Intel 8080, drew 4,000 orders sight unseen after a cover article in *Popular Electronics*. One fervently wishes somebody would find the box containing the original, serial number 0000, Altair. It disappeared in transit and has never been seen to this day.

In the 10 years since the Altair sparked the entire microcomputer revolution, companies have come and gone at a mind-boggling rate. There have been so many under so many names that a computer should be put to work tracking them and keeping the names sorted out. Ah, where are Imsai, Ohio Scientific, Southwest Technical Products, Technical Design Labs, Processor Technology, Parasitic Engineering, Kentucky Fried Computers, Scelbi, Martin Research, Polymorphic Systems, and MITS itself? Gone, not forgotten. In one of the more curious transformations, the caterpillar of Imsai reappeared years later as the Computerland butterfly.

Why did all these companies fail? There are many reasons, but at the head of the list is the ongoing maturation of the microcomputer world. Ever since August 1981, when IBM jumped in, companies run by part-timers, engineers, hobbyists, or amateurs have been doomed. What was a business built on technology has shifted to one based on commodity; price, distribution, and delivery count for far more than technical features.

We'll leave the PC clones aside, and look at two other well-known flops.

TWO MORE FAMOUS FLOPS

Osborne. Adam Osborne, as talented an individual as any who ever entered this business, was a chemical engineer. His unmatched gift for words led him to leave the oil company that

had yanked him out of the U.K. He wrote some good columns and this in turn spawned books and a publishing company. In early 1980, wealthy after selling the publishing company, Osborne came to the conclusion there was room for a portable personal computer. The heart of the idea was to make it simple—no confusing options. The Z80-based machine came with bundled software, 64K of memory, a tiny display screen, and a heavy case. The whole thing was priced at an astonishing \$1,795, and by late 1981 Osborne was selling 10,000 units per month.

Two years later, the Osborne company was in Chapter 11 bankruptcy. What happened along the way? First, competition, especially the Kaypro, came along to split the market. Second, a new generation—portable, lighter, and functionally superior—appeared. Third, the buyers started to move away from CP/M 8-bit systems toward MS/DOS 16-bit requirements. Fourth, the internal operations of the company were almost totally out of control. Osborne had little more than manual systems to control orders, inventory, and cash flow. Finally, in a last attempt to survive, Osborne announced the next machine before it could be delivered. Sales of the older units dried up and cash input stopped dead. Ergo, bankruptcy.

The lessons: 1. there are entrepreneurs and managers, idea people and organizers. These are not necessarily the same folks. 2. Never, never announce a successor machine before it is deliverable.

Gavilan. In 1982, it seemed about time for a truly portable computer. (At 10-plus kilos, the Osborne and Kaypro systems are movable, not portable.) The technology had skipped forward a generation or so. It was now possible to pack 256K RAM where 64K had formerly resided, and substitute 3½-inch diskettes for 5¼-inch or 8-inch units.

GRID systems was enjoying some success and press attention with a briefcase-sized machine based on Sharp's LCD display and priced in the \$10,000 range. The smart money decided there was clearly a market for a lap-sized system, preferably one compatible with IBM's PC, and including a built-in disk drive and connections for printers and communications.

A number of people are playing with this idea in one form or another. Early to market was Tandy, whose Model 100 was nearly the standard for the band of traveling journalists on the presidential campaign trail. Also, the Japanese, notably Espon and Sharp, saw the idea as the basis for a consumer electronics thrust and jumped aboard. Hewlett-Packard built the

110, a portable model of its 150 personal computer. And most recently, Data General came aboard with a single-disk, 80-column by 25-line display unit weighing under five kilos.

Left out in the cold looking in was Gavilan, a startup trying to carve a niche in the portable world. This company struggled and struggled and never could get the machine to market. The advertising looked good. Prototypes shown at various shows were attractive. Everything was in the specifications. But it never appeared. Accusations leaked out during the initial bankruptcy proceedings suggesting many things went wrong. Top management overrode engineering decisions. There was a sharp divergence of opinion among the founding management, and too much self-induced pressure to get to market before IBM announced a similar unit.

The lesson: keep your eyes on the real target. Stop worrying about systems that don't exist. And (yet again) don't announce until you can deliver.

A POTFUL OF PCMS POPS UP

This isn't the place to discuss the whole history of the IBM plug-compatible peripherals business. There are fat court transcripts that provide fascinating reading, and this issue's In Focus gives a good account of the current state of things—including StorageTek's prospects. Suffice it to say that, in the late '60s, IBM peripherals were overpriced and underpowered. There was a definite business opportunity, and some smart companies popped up. With IBM constrained to keep its interface reasonably unchanging lest it knock itself out, the whole peripherals world became a production game. If a vendor could deliver peripherals 10% faster and 10% cheaper, there was business to be had.

An abundance of companies was involved. In tape drives, Potter, Ampex, Telrex, and StorageTek were major players. In disk drives, StorageTek, Memorex, CalComp, and Marshall. Printers occasionally attracted attention, notably those from Documentation and Siemens. Memory manufacturers unable to resist the lure included Intel, Cambridge Memories, Fabritek, and Ferroxcube. And terminals seemed an easy target, since IBM filled only 50% of the demand. Raytheon, Beehive, Televideo, Adds, Memorex, and a good many others rose to this bait.

In the '70s, the easy targets began to disappear. IBM moved to highly automated production lines providing low-cost manufacturing. New products appeared, each performing better than its predecessors.

When it comes to the demand for human resource management software, data processing has a problem...

A problem of balancing everyone's needs and getting the over-all job done within budget

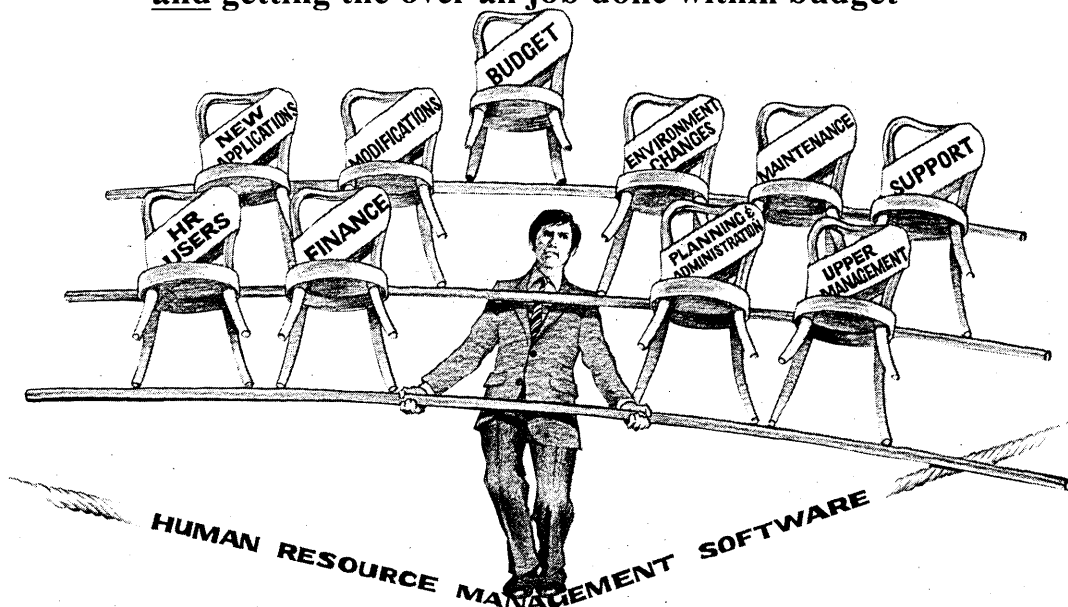

Now what if...

- There were 4 software packages that fully integrated to meet all your human resource management needs in payroll, personnel, benefit plan, and claims processing programs.
- And these packages were completely on-line, realtime, and adaptable to meet your ever-changing business requirements
- And this adaptation, including small and major modifications, was done by the user by modifying entries in the tables that define program logic, data structures, etc.
- And these packages operated with all major DBMS' and TP systems common to IBM and IBM compatible mainframe environments
- And these packages could quickly adapt to new environmental offerings such as IBM's DB2

- And the company who authored these packages provided thorough maintenance, training, and user support to assure user independence
- And the cost of all this was much less than in-house development, support, and maintenance...

Now what if you had all of this?

Then you'd have Tesseract's complete line of Human Resource Management software.

You'd have systems that are being used by almost half of North America's largest companies.

And you'd finally have the solution to the never ending problem of balancing HR user needs with the needs of the rest of your organization.

STOP WALKING THE HUMAN RESOURCE MANAGEMENT TIGHT-ROPE. Call us today or send in the card. (Call 415-543-9320 and ask for Robin Curle, VP Sales)

Mail to: Tesseract, 101 Howard Street
San Francisco, CA 94105

Name/Title _____

Company Name _____

Company Address _____

City _____ State _____ ZIP _____

Phone () _____

Type of Business _____

Number of Employees _____

Computer in Use _____

Send info on:

Personnel Management System Payroll System

Benefit Plan Administration System

Claims Processing System

85 NAT 1 DM



Software that creates solutions,
not problems.

The lesson: don't announce until you can deliver.

The hand-assembled memories gave way to automated semiconductor lines. Newer terminals became a commodity sale, price was everything. IBM, freed from antitrust constraints, began to recognize volume purchase discounts and in-house credit arrangements.

It didn't take long for the pcm flower to wilt. Almost all the contenders have abandoned the business. Let's look at one in particular.

Beehive. The Utah-based terminal manufacturer enjoyed a long and reasonably successful run. Sticking pretty closely to fundamental 3270-type terminals, they were able to take advantage of a solid work force and a clean, low-key operation. Unlike some of their feistier competitors, they never made the expensive mistake of trying to beat IBM in the courtroom. They were seemingly content with a small, profitable piece of the pie.

Unfortunately, in the past five years, Beehive began to run afoul of constantly falling terminal prices that left little room for profit. Margins shrank to almost nothing. IBM automated. TeleVideo went to assembling in the Far East. Beehive was unable to cut costs.

Borrowing money for sustaining operations, as opposed to expansion, can be the first step toward disaster. When your lead bank is in deep trouble, the handwriting is on the wall. Beehive needed cash and Continental Illinois, with its bad loans forcing it to the edge of bankruptcy, simply wouldn't provide it.

The lessons: when times and conditions change, you can't go on the same old way merely to keep up employment. Also: choose your bank carefully.

The data processing business has tempted all kinds of established companies.

Goodyear, the tire company, and Exxon and Shell, the oil companies, have all gotten involved. There have been aerospace players such as Grumman, McDonnell Douglas, and Boeing. Ford still builds computers, and General Motors is in services in a big way with the EDS acquisition. Citibank has tried to sell technology numerous times. McGraw-Hill, Dun & Bradstreet, Martin Marietta, Allied Corp., Westinghouse, Volkswagen, French Cable & Radio, Equitable Life Assurance, GTE—all have tried one or more times to succeed in data processing. Some have fallen away, others are still playing and trying to figure out if they have a future in information technology.

TEMPTED BY A GOOD PROPOSAL

How do these people get into the business? They may buy in, or stumble in. Some think their excess capacity in people or hardware will find an instant market. Some get sold a good story by a restless in-house manager. Some are tempted by one of the many propositions always dangled in front of large corporations.

Two of the most interesting cases, Xerox and Exxon, are worthy of a more detailed look. Both are among the largest, best-known companies in the world, and both have occasionally ventured into data processing and gotten their wrists slapped very hard. Both have been wealthy enough to survive the punishment and continue to prosper in other fields.

Xerox. The copier company was rolling along in the late '60s, making money and looking for an interesting place to make an investment. Scientific Data Systems, a manufacturer of small- to medium-sized systems for scientific and timesharing

use, was a \$100 million company with a brief, spectacular record. Xerox looked, thought, and bought—for almost a billion 1970 dollars. SDS's Max Palevsky became the largest Xerox stockholder. SDS became XDS, but it had already peaked, and in a few years it disappeared. Strike one.

Some years later, Xerox decided office automation was the future. At the time, it was having lots of problems with Japanese competition in low-end copiers, and a slight shift of direction looked interesting. Within a few years, Xerox had a full line of office level products—word processors, facsimile units, memory typewriters, personal computers, a local area network, and the wondrous STAR workstation. Most of the products proved a tad short. STAR, the first icon-based system, didn't seem to fit in anywhere. Ethernet didn't set any records except for publicity. Strike two.

Within Xerox, most of the office products came from the Palo Alto Research Center, as talented an organization as the industry has assembled. Xerox corporate management remained slow to adopt PARC ideas, however. People began to drift away, tired of fighting the copier-oriented bureaucracy. Strike three?

Obviously, Xerox Corporation is still in business. Information Technology losses are severe but not crippling. The new copiers are extremely competitive. But office systems are a bust. With IBM selling up-to-date electronic typewriters, even this small triumph may disappear. Ironically, the grandson of STAR, Apple's Macintosh, a product Xerox ought to have produced, may keep the team's flag flying.

The lesson: if you do not have managerial will power and are not willing to stay the course and make the investments, get out and stay out.

Exxon. With the increased oil prices of the mid-'70s, the tiger was getting fat with cash. Always a strong in-house user of advanced data processing (and employer of first-rate people), Exxon thought it a good idea to make a few strategic bets on information technology. An acquisition operation in New York began to scour the nation for small, high-technology, research-oriented companies, usually in the preproduction stage. In short order, Exxon had some or all of over 25 companies, including Peripherals, QYX, QWIP, Vydec, and Zilog. The products included PABXs, memories, word processors, typewriters, facsimile transceivers, semiconductors, and voice systems.

The pattern was always the same. The acquisition was made. In moved the oil company whiz kids with their spreadsheets and calculators. Corporate accounting followed, demanding five-year plans. The



CARTOON BY J.P. RINI

No. It's not a computer.

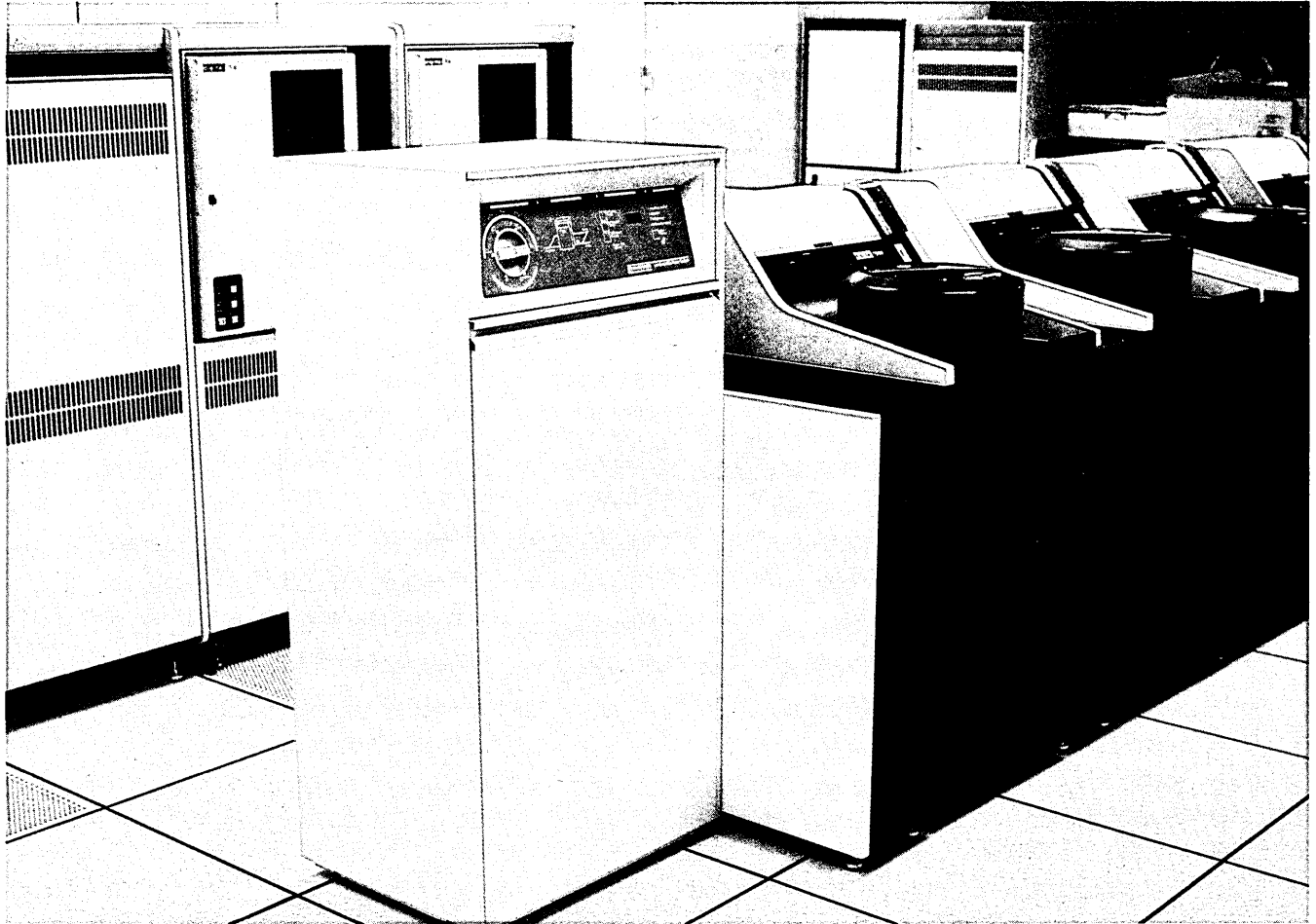

But Emerson's New **UPS** for minicomputers is right at home in the computer room.

Until now, if you wanted a true, uninterruptible power system for your minicomputer, you'd have to hide it in the basement or equipment room.

They were big. They were noisy. And they were expensive.

Emerson has put an end to all that. Our new AP100 series UPS in power ratings of 3, 5, and 10 KVA are small, quiet (less than 60db) and very affordable.

They have internal sealed batteries that continue to give perfect power even when the lights go out.

And because it is a true UPS, it gives you complete isolation from the hazards of raw utility power.

Every AP100 UPS has a built-in microprocessor that monitors your computer's total power requirements, displays real time status, and performs hundreds of system checks every second.

With its single rotary control switch, anyone can learn to operate it in 5 minutes.

And that's not all we could tell you about the new, revolutionary Emerson AP100.

So call us.

Find out more about the first true UPS that's designed for the computer room.

1-800-556-0100

 **EMERSON**
Computer Power

Emerson Electric Co.
Industrial Controls Division
3300 S. Standard St. (P.O. Box 1679)
Santa Ana, California 92702 USA
(714) 545-5581

© 1984 Emerson Electric Co.

Apple's Macintosh, the grandson of STAR and a product Xerox ought to have produced, may keep the team's flag flying.

original entrepreneurs, annoyed by bureaucracy, walked out. Exxon was left with beautiful plans, tidy spreadsheets, detailed analytic studies, and not much else. The world moved on, the Exxon people rotated at a rapid rate. Finally, in November of last year, the company put Exxon Office Systems (though not Zilog) up for sale.

BOYS AT THE ROCK IN A FOG

The Rockefeller Center boys never did seem to understand why a product developer in a new market can't wait six months for a basic decision, or predict cash flow and return on investment for a business that doesn't exist yet.

The lesson: if you don't have the gut instinct, don't get involved. MBA methods aren't the way to create a new business in high technology. Sit on the board, look wise, and keep your mouth shut. What you have bought is people; lose them, and you're lost.

So here we are in 1985. This year there will be more comets streaking across the sky and disappearing in a welter of pub-

lic relations releases, lawsuits, and legal fees. The business is getting tough, especially at the micro end.

What is changing the pattern at the high end is acquisitions, joint ventures, and working deals. Honeywell has hooked up with NEC; Amdahl is 49% owned by Fujitsu, with their large cache of yen. Interdata has disappeared into Perkin-Elmer, and Modcomp into Gould. In the U.K., long-troubled ICL became part of the IIT subsidiary, Standard Telecommunications & Cables.

The micro world, explosive between 1981 and 1984, should supply many of this year's nosedives into bankruptcy. There are perhaps 1,200 retail stores too many; some of these franchised operations will fade back into the shopping centers from which they came.

Other prospects for failure are about half the distributors (who have been getting by on ever-thinning margins), a good percentage of the micro software companies whose products are iffy at best, and a few of the remaining manufacturers. The world doesn't really need 70 word pro-

cessing packages for the IBM PC, or 50 PC clones. Sooner or later, the markets will stabilize and the weaker companies will disappear.

Looking back over this bleak, black record, a couple of points really stand out, including the following:

- Companies without managerial will power—the guts to take risks and the willingness to make larger bets—don't survive.
- Great public relations, slick marketing, and classy offices are nice, but sooner or later, you have to produce the product.
- Most of the victories come from stand-alone, startup companies.
- Keep away from Wall Street just as long as possible; they understand spreadsheets and calculators but not high technology, or how to manage it.
- Don't mess with Big Blue.

To the winners go the rewards. The losers get legal bills and usually a second—or a third, or a fourth—try. ©

Philip H. Dorn is a New York-based consultant and a member of the DATAMATION advisory board.

SPREADSHEET GOES "BEYOND 1-2-3" ON MICROS, MINIS & MAINFRAMES?

CRITICS RANK 20/20™ AGAINST 1-2-3™ FOR: IBM, DEC, DG, PRIME, WANG, UNIX™ & OTHERS*

The first critical reviews are in. The critics liked 20/20's advanced spreadsheet modeling which neatly integrates graphics, data management and project modeling. They liked 20/20's windowing and it's powerful three dimensional consolidation capabilities. And, they liked 20/20's portability. Although 20/20 is carefully tuned for each host computer, complete 20/20 models can easily be moved from system to system. 20/20 exchanges data with other software on your system with ease and even includes a model translator for Lotus 1-2-3™. Call or write today for 20/20 critical reviews and free trial offer.

800-228-2028 ext. 21

Access Technology, Inc.
6 Pleasant St., S. Natick, MA 01760
(617) 655-9191

20/20™

CIRCLE 39 ON READER CARD

* 20/20 available for: IBM VM/CMS™ & PC™; DEC VAX™, Professional™ (2/85) & Rainbow™; DG AOS/VS™; PRIME; WANG VS™ (2/85); AT&T 3B2™ & 3B5™.

Announcing Support for
IBM 5080
 Graphics Workstation
 Call for details.

Choose Precision Visuals graphics software and you're in the best company.



"DI-3000 has saved our company a lot of time and money."

David Millard
 Advanced Software Analyst
 Marathon Oil Company

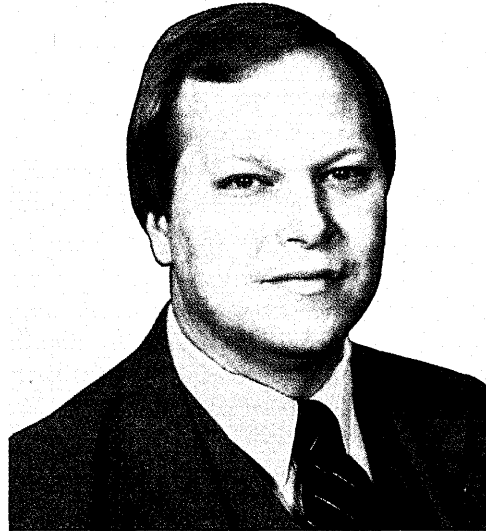

"Superior documentation makes our customers successful."

Rick Maule
 Director of Product Marketing
 Harris Corporation, Computer Systems



"Support from both corporate and the local office is outstanding."

Leland Freeman
 Manager of Decision Support Software
 Management Decision Systems, Inc.

Over 1,000 customers depend on the safety and reliability of our software.

Demanding end users and systems integrators worldwide—including many Fortune 500 companies—choose Precision Visuals graphics software as their corporate standard. They choose safety in machine independence, from mainframes to the leading supermicros. They choose reliability in products that offer device-intelligent support for every major graphics hardware vendor. And they choose peace of mind by investing in graphics software that commands 92% repeat business from our customers.

A complete graphics toolbox means one-source problem-solving. Graphics champions in diverse industries, including aerospace, petroleum, electronics, and scientific research, choose Precision Visuals' integrated family of standards-based packages. Our device-independent subroutine libraries, DI-3000® and GK-2000,™ are used in applications ranging from interactive 3D modeling to VLSI design. Our Contouring System is used widely in cartographic and geophysical applications. GRAFMAKER™ is our powerful chartbuilding system, and PicSure™ is our new, easy-to-use data presentation graphics package.

Responsive support and industry-acclaimed documentation make our users more productive. A HelpLine offers quick answers to keep them on schedule. National training programs help get their applications operating on time and within budget. User's groups exchange creative and timesaving ideas. And example-intensive documentation adds value to their investment.

Choose Precision Visuals graphics software and you're in the *right* company. Call Rob Look today at 303/530-9000.

Precision Visuals®

Precision Visuals, Inc.
 6260 Lookout Road
 Boulder, Colorado 80301 USA
 303/530-9000
 TELEX (RCA) 296428

CIRCLE 40 ON READER CARD



Interactive 3D Modeling
 using DI-3000®

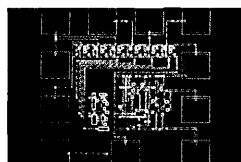

2D Circuit Design
 using GK-2000™

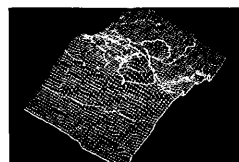

3D Surface Display
 using the Contouring System

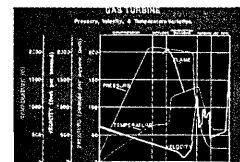

Powerful Chartbuilding
 using GRAFMAKER™

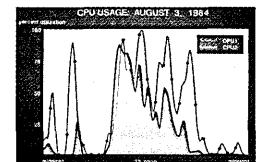

Technical Data Presentation
 using PicSure™

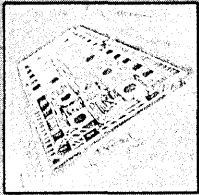

1970

Four-Phase announces the industry's first all-LSI Central Processing Unit to give you increased performance in a smaller computer system.

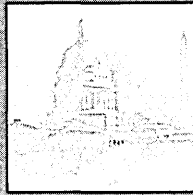

1973

Four-Phase wins the largest-ever contract with the Federal Government for a data entry system.

Motorola/Four-Phase introduces The 6000 Series—a new milestone.

A milestone for new standards in office information systems from the company that started it all.

From the moment Four-Phase introduced the world's first all-LSI computer in 1970, we have consistently presented the industry with innovative hardware and software products to help make business more profitable and productive.

Today, as a member of the Motorola Information Systems Group, Four-Phase once again unveils another milestone in information processing—the new 6000 family of office information systems. Compact, powerful

processing units and flexible, capable software have been fused together into a family of systems that deliver maximum results today, with substantial expansion capabilities for tomorrow.

Technology for the real world.

Motorola/Four-Phase systems are tough enough and smart enough to deal with the real world—where speed, power, and reliability in a multi-user environment are prime considerations. The new 6000 systems feature the high-performance 32-bit Motorola 68010 CPU and an operating system derived from UNIX* System V under license from AT&T. We created



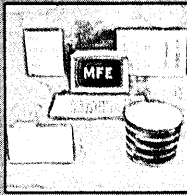

1978
 Four-Phase announces The **MULTIFUNCTION EXECUTIVE®** (MFE), the first DDP operating system to allow multiple applications to run concurrently and independently.

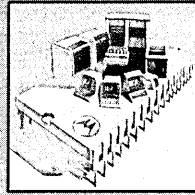

1982
 Four-Phase is acquired by Motorola Inc., combining our information processing expertise with one of the world's leading manufacturers of semiconductors and electronic equipment.

integrated system software that combines these two industry standards into a powerful, multi-user, multi-tasking environment that can stand up to practically any application.

There are two systems in the 6000 family. The 6300 supports 1-8 users, making it perfect for the smaller user or a remote office. The 6600 is a high-performance system designed to support up to 128 users. Both systems offer complete and integrated solutions—whether they're working in an operations-oriented environment where efficiency and precision are needed, or a results-oriented environment where flexibility and quality are key.

Service and support to match our technology.

At Motorola/Four-Phase, our commitment to you goes beyond providing quality, high-performance hardware and software. Support is just as important. Our award-winning Customer Support Operation is staffed with over 1,400 customer support specialists in over 175 cities across the nation. One phone call to our

Operations Center will ensure prompt response from the nearest available specialist. And you can call the Center 24 hours a day, 365 days a year.

If you're a DP/MIS manager or OEM, find out what the latest milestone in office systems can mean to you. Contact Motorola/Four-Phase today at 1-800-528-6050, ext. 1599. In Arizona, call 1-800-352-0458, ext. 1599. Or write us at 10700 North De Anza Blvd., M/S 52-3B1, Dept. S., Cupertino, CA 95014.



MOTOROLA
Four-Phase Systems

Motorola and  are registered trademarks of Motorola Inc. Four-Phase is a registered trademark of Four-Phase Systems, Inc. *UNIX is a trademark of AT&T Bell Telephone Laboratories, Inc.

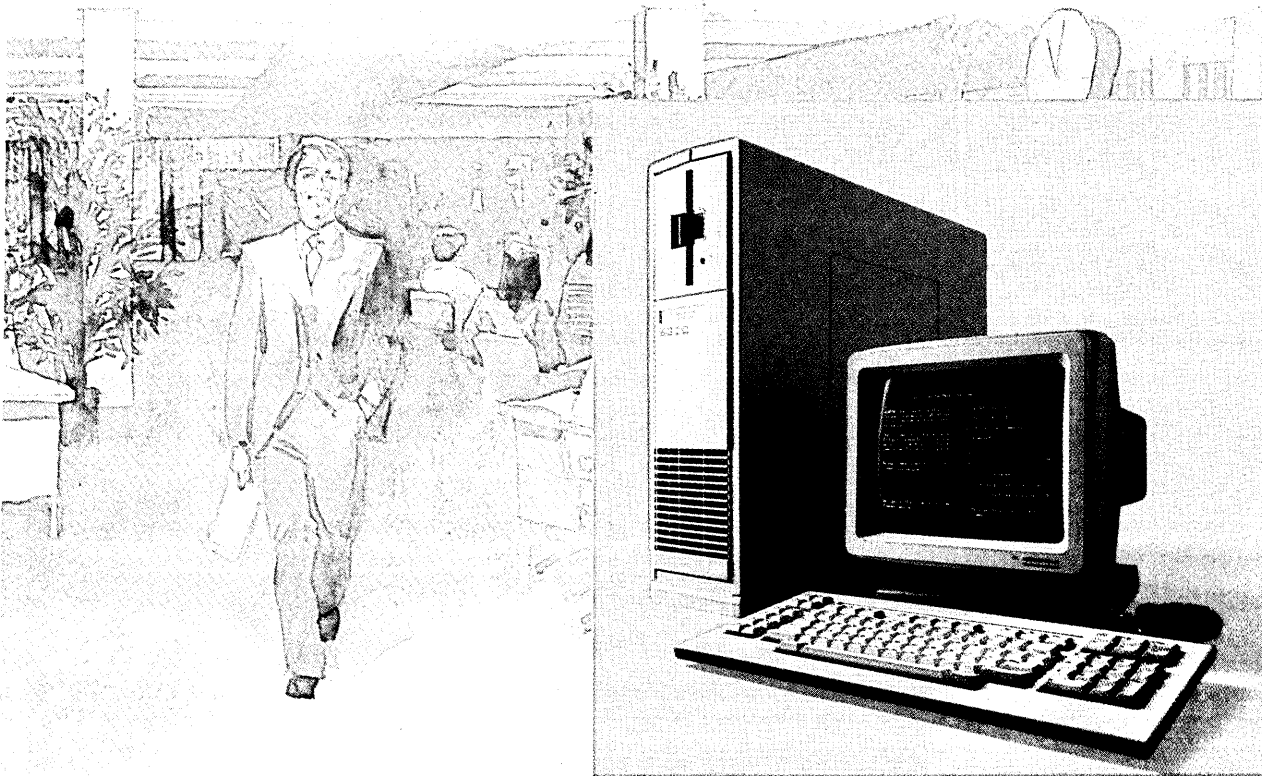

1984
 Motorola/Four-Phase announces The 6000 Series—a milestone in productivity that delivers information processing performance today, and expansion capabilities for tomorrow.

THE LEADER IN LASERS
PRESENTS THE
28-PAGE-PER MINUTE HOLOSCAN PRINTER.

It's the fastest, low-cost laser printer — with true letter quality — in the industry. By incorporating the most sophisticated diode laser with holographic scanning capabilities, General Optronics created the versatile HoloScan 28™ Laser Printer. Just look at what it offers!

• high resolution — 300 by 300 dots per inch • compatible with all computers • ideal for multi-user applications • nationwide service available • prints on ordinary paper — 16 lb. to 26 lb. • accepts mixed paper sizes — 8½" × 11" to 11" × 17" • prints portrait or landscape • merge forms and text • prints multiple fonts on same page • 1250 sheets input capacity • compact and virtually silent • single quantity price \$14,500 including video interface • Centronics, Data Products and RS-232C interfaces available • supports the Diablo 630 escape codes

For information, call or write Charles Kaplan, National Sales Manager, General Optronics Corp., Optical Information Products Division, Two Olsen Avenue, Edison, NJ 08820, 201-549-9000. TWX 710-997-9556. Distributor and OEM inquiries welcomed.

HOLOSCAN 28 LASER PRINTER

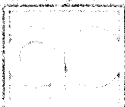
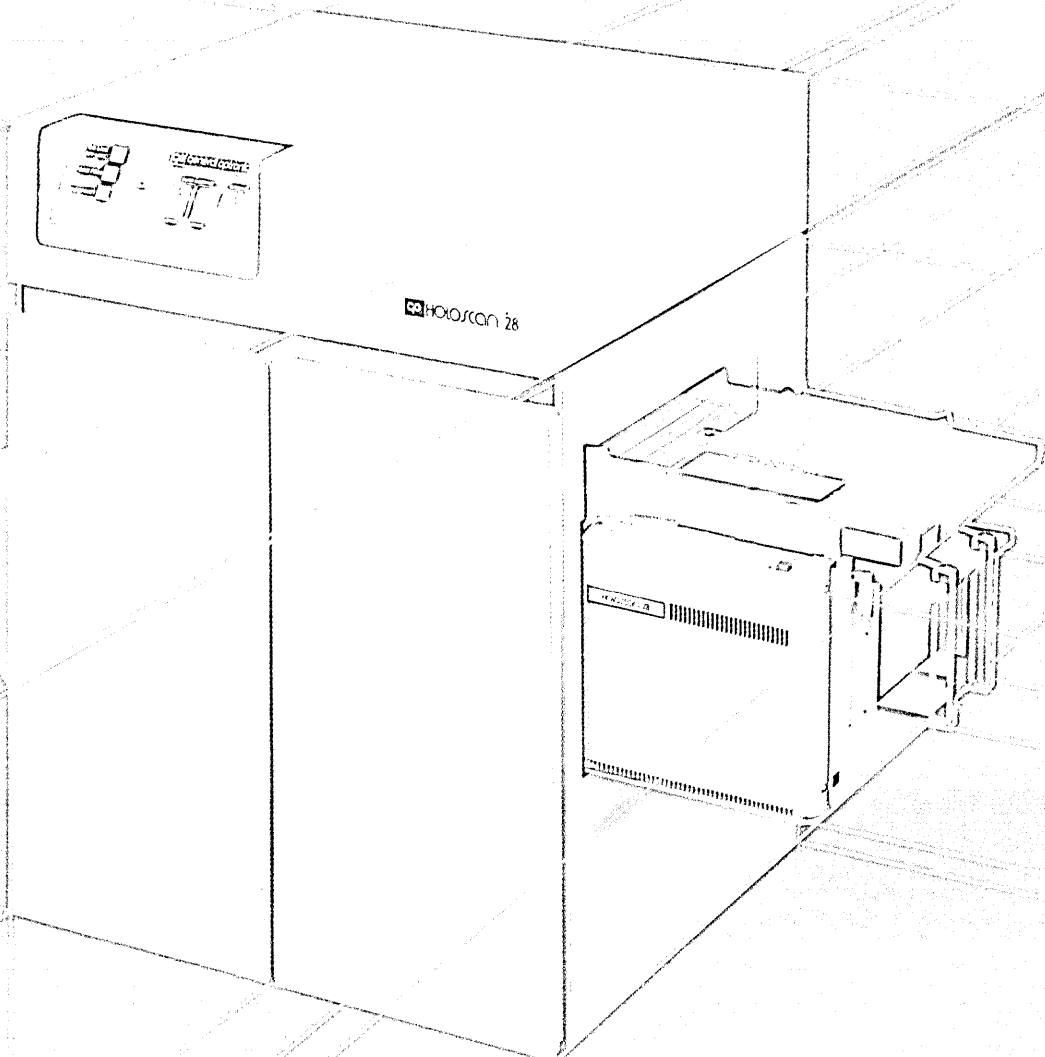

What changes when your vendor bows out of the business? Surprisingly little.

RAISING ORPHANS

by Nancy Welles

In 1981, Joseph Daniero, dp chief at Delaware Investment Advisers, an investment firm in Philadelphia that manages \$8 billion in assets, bought an M80/32 mainframe produced by Magnuson Computer Systems. It worked so well that six months later he bought another.

Subsequently, as many dp people know, Magnuson developed severe financial problems. It filed for bankruptcy in 1983 and last summer most of Magnuson's assets were acquired by Global Ultimacc, a subsidiary of Storage Technology Corp., the troubled disk maker that just went bankrupt last fall.

Daniero read about all this in the newspaper. And he's still not worried. He says his Magnuson equipment rarely needs servicing. When it does, he calls up the people who originally installed it because they're the same people who still service it today. Says he: "They usually show up about 30 minutes after we call them." Not only were Magnuson's troubles "invisible to us," he expects StorageTek's will be too.

When a computer company goes under, investors and lenders lose sleep. Large corporate customers apparently do not. Even though some dp people now have a nervous eye on StorageTek, many others steadfastly maintain that living with "orphaned" equipment is no more of a problem than staying with equipment produced by a vendor who is alive and well.

The main reason not to worry, points out Bruce Hasenyager, vice president of information systems at Kidder, Peabody Inc., an investment banking firm in New York, is that "there's money to be made in continuing support. As a result, *somebody's* going to be interested in doing it." Sometimes, as in the case of Magnuson, the service arm of a company keeps on going even when the manufacturing arm has been shut down, a trickle of black ink to counteract the tide of red.

A large customer base is a valuable asset in its own right, of course. That's why

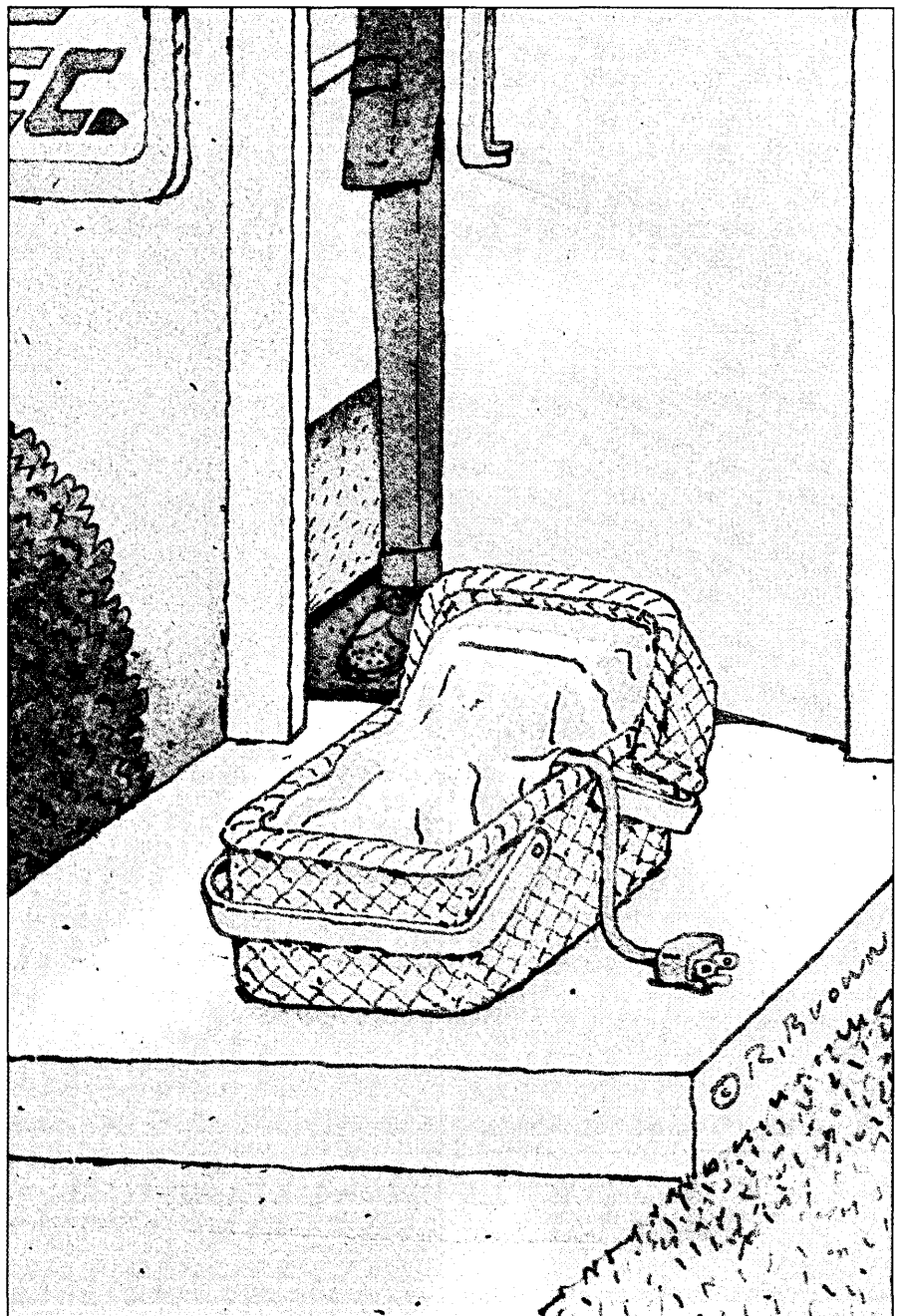

ILLUSTRATION BY RICHARD BROWN

No one denies that a vendor's financial woes can compound already existing technical problems.

Sperry Corp. paid RCA \$135 million in 1972 after RCA decided to shut down its computer business. For its money, Sperry took on a staff of 2,500, many of whom supported the 500 corporate customers who were using 1,000 RCA computers.

Some of that old hardware is still being maintained, according to Mike Maynard, press relations manager at Sperry's information systems group in Blue Bell, Pa. More important, as of 1982, says Maynard, about 75% of those RCA customers had upgraded to newer Sperry equipment and are now Sperry customers in their own right.

When all else fails, third-party service companies often pick up the slack. Typically, these companies have a maintenance contract with the end user and another agreement with the hardware vendor to supply the needed parts. TRW has the largest equipment servicing company in its customer service division, which last count had roughly \$160 million in yearly revenues. Ironically, TRW got into this business by acquiring the service arm of Singer Business Machines in the mid-1970s.

The second largest player in this field is Sorbus Service, the Management Assistance Inc. subsidiary scheduled to be sold to Bell Atlantic for \$175 million. Neither company specializes in caring for orphaned equipment but both do it. "A few" troubled computer companies have sold Sorbus their maintenance business, reports George Hatzfeld, manager of communications at Sorbus in Frazer, Pa. He declines to specify which ones because they've gone on to solve their problems, he says, and are now quite healthy.

The fact that support continues was brought home to the dp people at Hughes Aircraft, Los Angeles, who have 300 Lexitron word processors to worry about. In 1978, according to Bob Nagle, Raytheon's public relations manager in Lexington, Mass., Raytheon Data Systems bought Lexitron, a small company in Chatsworth, Calif., for \$15 million, because RDS wanted to add an office automation product to its line of IBM 3270-compatible terminals.

As the years went by, however, the market changed. The personal computer emerged as a versatile substitute for word processors and IBM's increasingly aggressive pricing adversely affected all kinds of companies producing IBM-compatible equipment. In 1983, RDS lost \$25 million on \$307 million in revenues, says Nagle.

Last May, RDS announced it was going to shut down for good. But it followed this up a month later with the announcement that Telex Corp., Tulsa, Okla., had agreed to buy the whole operation, including the RDS service obligations, for \$200

million. At Hughes, there's been no change in the service on Lexitron equipment. It's just that Telex now signs the paychecks. Through it all, "we got very good support," says Susan Roper, manager of advanced office systems at Hughes.

FINDING FOSTER PARENTS

When the business is large enough, it's not hard to find foster parents for orphaned hardware. That's the role Pat McCaffrey-Green wanted when, as manager for Victor Technologies' Dearborn, Mich., branch, she saw Victor's problems steadily mount. She had helped negotiate the Scotts Valley, Calif., firm's purchase agreement with the Ford Motor Co. in December 1982 and expected to sell Ford thousands of Victor 9000 microcomputers in the next few years.

But after 4.5 million Victor shares were sold to the public in March 1983, all the news from Victor seemed to be bad. That spring, Ford took over the maintenance of micros in southeastern Michigan. McCaffrey-Green had the task of servicing the Victors everywhere else and the ongoing job of filling Ford's orders, installing

the equipment, and teaching Ford's people how to use it.

When Victor went into Chapter 11 last February, McCaffrey-Green wanted to stay in business on her own. "Having run the operation I knew it was profitable," she says. In less than a month, she had gotten the financing she needed—"the Ford contract certainly helped"—and had set up Techno-Logic Concepts Inc., an employee-owned company. She was initially concerned about the issue of product availability, but that was one problem that never arose.

Now Ford has more than 1,300 Victors in place throughout the company, and McCaffrey-Green, president of Techno-Logic Concepts, is still servicing the account. She has set up a dealer network to service the 300 Victors in Ford plants outside of southeastern Michigan, and has established relationships with third-party vendors of software and peripherals that go with Ford's micros. She's also expanded the training end of her business and is now teaching General Motors and Michigan state employees how to use the micro.

Ford was sufficiently satisfied with the arrangement to renew recently its purchase agreement with Techno-Logic Concepts and Victor for another year. Overall, says Dave Sanger of Ford's office productivity center, "everyone's happy with their Victor machines and the support that's been provided."

VENDORS' \$ WOES A DRAWBACK

Despite the equanimity with which dp managers seem to face the notion of keeping company with technological orphans, no one denies that a vendor's financial woes can compound already existing technical problems. At Macmillan Inc., for example, Roger Jambor, vice president of information systems in Delran, N.J., has been having a rough time with his STC 8650 disk drives, which sometimes experience head crashes that destroy data. (Last January, STC reported it had spent more than \$18 million in 1982 trying to fix this kind of problem.)

Jambor doesn't have any complaints about the service he's been getting from STC. In fact, he says that the attention he's gotten has increased as STC field engineers intensified their efforts to improve the reliability of his 8650s.

Now, however, with 18 months remaining on his STC leases, he's trying to decide what to do—stay with his 8650s, upgrade to the subsequent generation of 8380s, or wash his hands of the whole thing by switching to IBM. He's ultimately planning to change vendors anyway, but in the

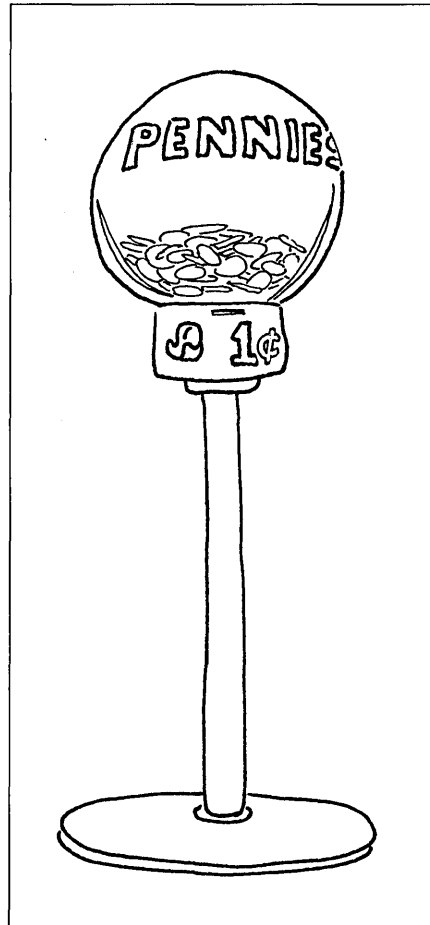

CARTOON BY J.P. RINI

A REVOLUTIONARY PROFESSIONAL

The strongest color graphics available, a broad range of professional standard software, and powerful networking capabilities are only some of what sets the revolutionary professional color workstation apart from DATAPOINT's VISTA/PC.

A system of this size normally offers many PC/VIS™ family advantages and software for the corporate office. The VISTA/PC gives you financial modeling, spreadsheet, and personal database applications supported by high-quality business graphics. And, with networking, enables the easiest

possible access to word-processing, graphics, and the VISTA/PC appears as a standard workstation. It's just like the workstation listed in a department store. And, it's part of an ARC™ (Advanced Resources Corporation) network environment.

The VISTA/PC can be either a first step toward an automated office or a replacement of an existing single PC/VIS family. It is compatible with existing DATAPOINT equipment and communicates with systems made by other manufacturers. When attached to an ARC host, it can

work through the host's system and drive as fast as your host's best graphics.

DATAPOINT is a specialist in color graphics. Since the introduction of color, we've led the office systems. We specialize in revolutionary business color capabilities with ARC. We have the most thoroughly proven color graphics technology available, and today we continue to lead the revolution. If you're ready to join the DATAPOINT revolution, call us on worldwide sales and service lines about the VISTA/PC professional color workstation.

INTRODUCING THE DATAPOINT VISTA-PC COLOR COMPUTER

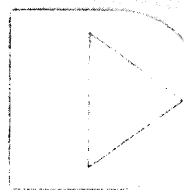
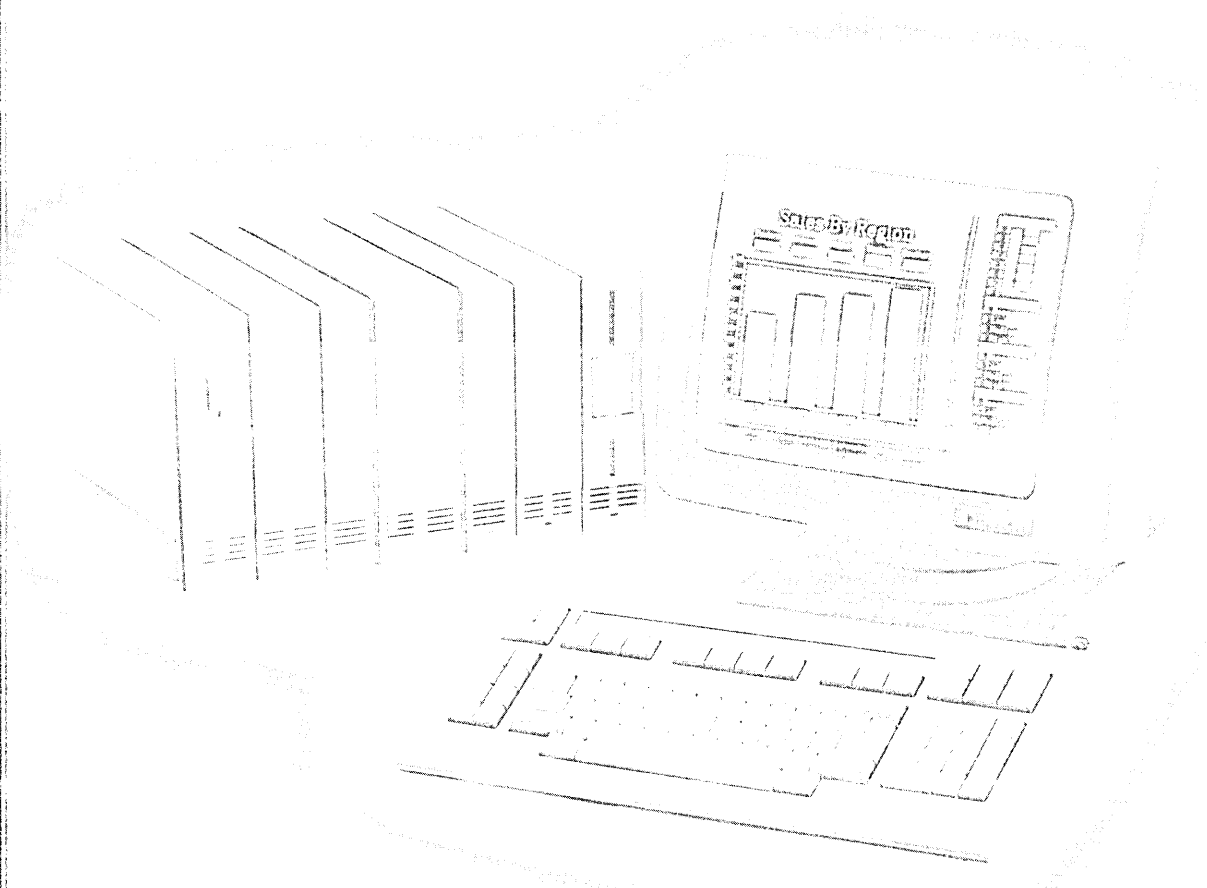

DATAPOINT
We sparked the revolution.

"We can afford to have a software vendor go out of business," says the head of dp at a large company.

meantime, he's trying to see what kind of deal he can cut with STC.

Some dp people are a little more leery about being left with orphaned software. That's because software contractors rarely give their customers the source code for the programs they buy. And since a program can't be changed without the source code, dp people remain dependent on the person who has it. Not surprisingly, dp executives don't want to deal with software vendors who can't assuage their fear of being left in the lurch.

A software firm could do a respectable business servicing its programs in the field—and many do. But, right or wrong, programmers have gained a reputation for being less than reliable. "They're flaky," as one dp executive puts it, "if those people decide to pick up and go fight with the Contras, you could be in trouble." Even if they're not flaky, he adds, "they're still vulnerable to being run over by a truck." In either case, dp managers have their hands tied if they want to change a program and can't get to the source code.

Some managers believe this problem

can be solved if the software vendor agrees to place the source code in escrow. That way, they'll be able to get it if they have to.

But that's not always true, says Bruce Brickman, a New York lawyer who specializes in computer law. "An escrow provision is an executory provision—something to happen in the future—which can be voided by a bankruptcy court." A bankruptcy judge, he suggests, could decide to sell a piece of source code to pay off the bankrupt company's debts.

Brickman has another solution. He maintains that the only way to avoid being stood up by an errant software writer is to make the terms of the contract as specific as possible. That way, both parties will have to think through potential problems before they arise, and agree on how to solve them ahead of time.

A lot of dp executives are all too aware of this, of course. "There are a lot of spooks in this business," says Charlie Cianci, second in command of dp at Delaware Investment Advisers, and "there are some things one should do beforehand" for protection.

Others just aren't worried. "We can afford to have a software vendor go out of business," says the head of data processing at a large company in New York. "If it's a software product, you use it anyway. If you can't fix the bug in it, you work around the bugs."

It might seem that data processing people have taken Voltaire's *Candide* too much to heart ("In this best of possible worlds . . . all is for the best"), but this is not so. Some of them began to worry about StorageTek during the fall. They weren't fretting about support. They were thinking of supplies.

"If STC collapses, I expect you'll have some tough problems out there," observes Carl Reynolds, vice president of communications and data processing at Hughes. "Almost everybody is in constant need of disks. You have to wait three months to get one from IBM. Without STC, you could be in a real bind. Everyone else has gotten out of the business." ©

Nancy Welles is a New York-based writer on technology and business subjects.

TERMINALS FROM TRANSNET

PURCHASE PLAN • 12-24 MONTH FULL OWNERSHIP PLAN • 36 MONTH LEASE PLAN

Authorized Distributors — Carry the COMPLETE lines of:			MONTHLY RATES			
			Purchase	FULL Ownership		Lease
				12 mo.	24 mo.	36 mo.
DEC	LA50	Personal Printer	\$ 650.	\$ 65.	\$ 35.	\$ 25.
	LA120KSR	DECwriter III	2295.	220.	125.	85.
	VT101	CRT Terminal	1195.	115.	65.	45.
	VT102	CRT Terminal	1425.	140.	75.	50.
	VT220	CRT Terminal	1150.	110.	65.	45.
	VT240	CRT Terminal	1950.	185.	105.	70.
digital	VT241	CRT Terminal	2850.	270.	155.	100.
	TI1707	Portable Terminal	595.	60.	35.	20.
	TI820KSR	Terminal Pkg.	1995.	190.	105.	75.
	TI850	Printer w/Tractor	575.	55.	30.	20.
TI	TI855	Dual Mode Printer	895.	85.	50.	30.
	TV914	TIU/Swivel CRT	615.	60.	35.	20.
	TV950	CRT Terminal	1075.	105.	60.	40.
TELE-VIDEO	TV970	TIU CRT Terminal	1195.	115.	65.	45.
	NT6K90	Displayphone plus	1395.	135.	75.	50.
	NT6K00	Displayphone	1095.	105.	60.	40.
NORTHERN TELECOM	NT6K55	Modem 212/A	525.	50.	30.	20.
	CIT101	Video Terminal	1095.	105.	60.	40.
	CIT414A	Graphics Terminal	1395.	135.	75.	50.
C ITOH	CIT500	W/P Terminal	1995.	190.	105.	70.
	CIT600	Line Printer	5595.	540.	300.	200.

ON SITE TECHNICAL SUPPORT & SERVICE

PERSONAL COMPUTER SYSTEMS

Visit our computer stores in Union and Ocean, NJ

AUTHORIZED RETAIL DEALER

APPLE® IIe, IIc, MAC, III and LISA — DEC RAINBOW — TI PROFESSIONAL

SUPPLIES — FREE CATALOG — CALL

DEC is a registered trademark of the Digital Equipment Corporation

APPLE is a registered trademark of Apple Computer, Inc.



TRANSNET CORPORATION

1945 ROUTE 22 — UNION, NJ 07083

In NJ (201) 688-7800 • (800) 526-4965 • TWX 710-985-5485

CIRCLE 45 ON READER CARD

Payroll Savings, America's favorite way to save ...and that's no CROCK!



© Field Enterprises, Inc. 1983



U.S. SAVINGS BONDS DIVISION
DEPARTMENT OF THE TREASURY



DECISION DATA ANNOUNCES A SECOND DECISION

Decision Data Computer Corporation has made its service division a fully-owned subsidiary: Decision Data Service Inc.

It's a Decision that makes us proud.

That's because DDCC Service is such a remarkable success. It's gained a national reputation as a flexible, expert service organization that gets computer systems running, then shows how to operate them more productively — from networks of computers and peripherals to clusters of personal computers.

With 100 branch locations in North America, and a variety of service plans to accommodate different needs, Decision Data Service is simply the best single source for a company's computer service needs.

Remember Decision Data Service. Because if any other company is servicing your computer system, it's wise to seek a second decision.

**DECISION DATA SERVICE: PROFESSIONAL
SERVICE FOR
PROFESSIONALS**

400 Horsham Road
Horsham, PA 19044-0996

Tel.: (215) 674-3300

CIRCLE 46 ON READER CARD

 **Decision
Data**
Computer
Corporation

 **Decision
Data**
Service
Inc.

The reasons 3270 us can be summed

More.

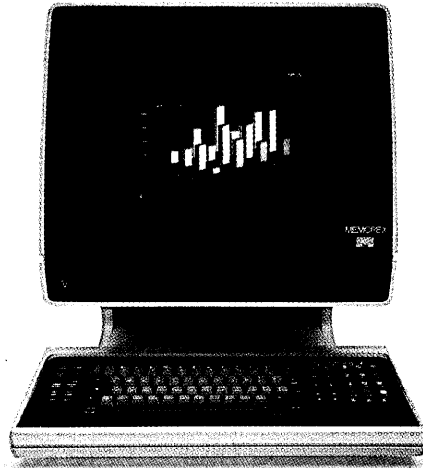

2079

More than meets the eye: seven crisp, vivid colors for more effective presentations.

More optional features such as APL/Text, cursor choices, graphics.

More features and benefits in the 3270 world.

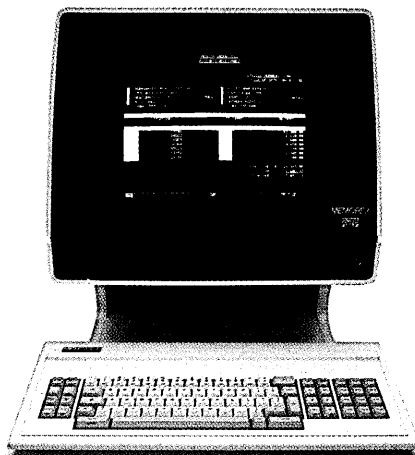

2078

More sight for sore eyes: your choice of high-resolution amber or green phosphor CRTs.

More productivity from ergonomic keyboards and tiltable screens.

More efficient use of energy.

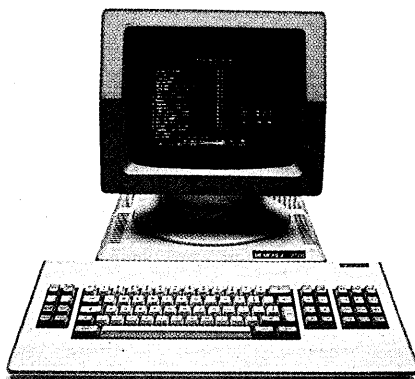

2178

More flexibility with a modular design, plus tilt and swivel.

More for your money: 3270 functionality at a lower price.

More support and service from a worldwide organization that's as good as its word.

ers choose Memorex up in two words: And less.

Less time finding key points—color attracts attention.

Less reason to look anywhere else.

Less to worry about when you need full 3270 compatibility.

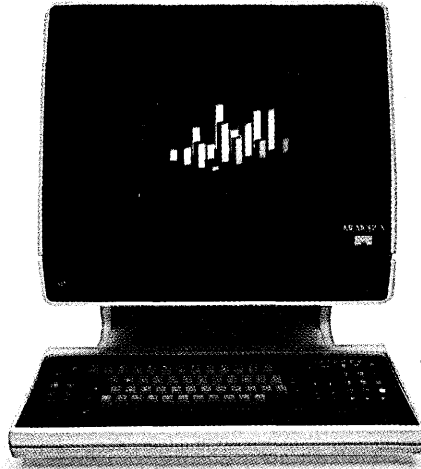

2079

Less glare, less eye fatigue.

Less for fingers to trip over and shoulders to hunch over.

Less to pay for power bills—up to 58% less.

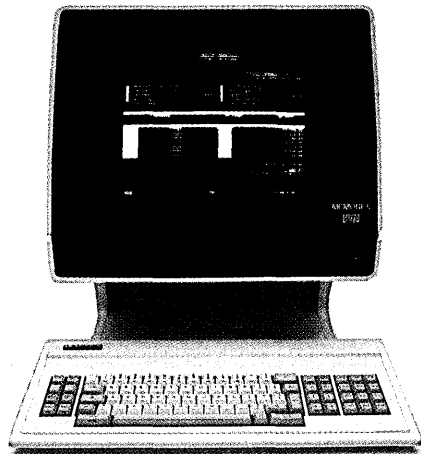

2078

Less desk or work space needed.

Less trouble stretching your budget.

Less for you to worry about. Period.



2178

So plug compatibility, competitive prices and uncompromising quality make Memorex the alternative in the 3270 world?

Definitely. More and less.

Call 800-854-5484 today. Or write: Memorex Communications Group, MS 14-39, San Tomas at Central Expressway, Santa Clara, CA 95052. And find out for yourself.

Compatibility.

When it matters, make it Memorex.™

MEMOREX
A Burroughs Company

©1984 Memorex Corporation. Memorex is a registered trademark of Memorex Corporation.

CIRCLE 47 ON READER CARD

Meeting all your information needs requires total systems integration knowledge and experience.

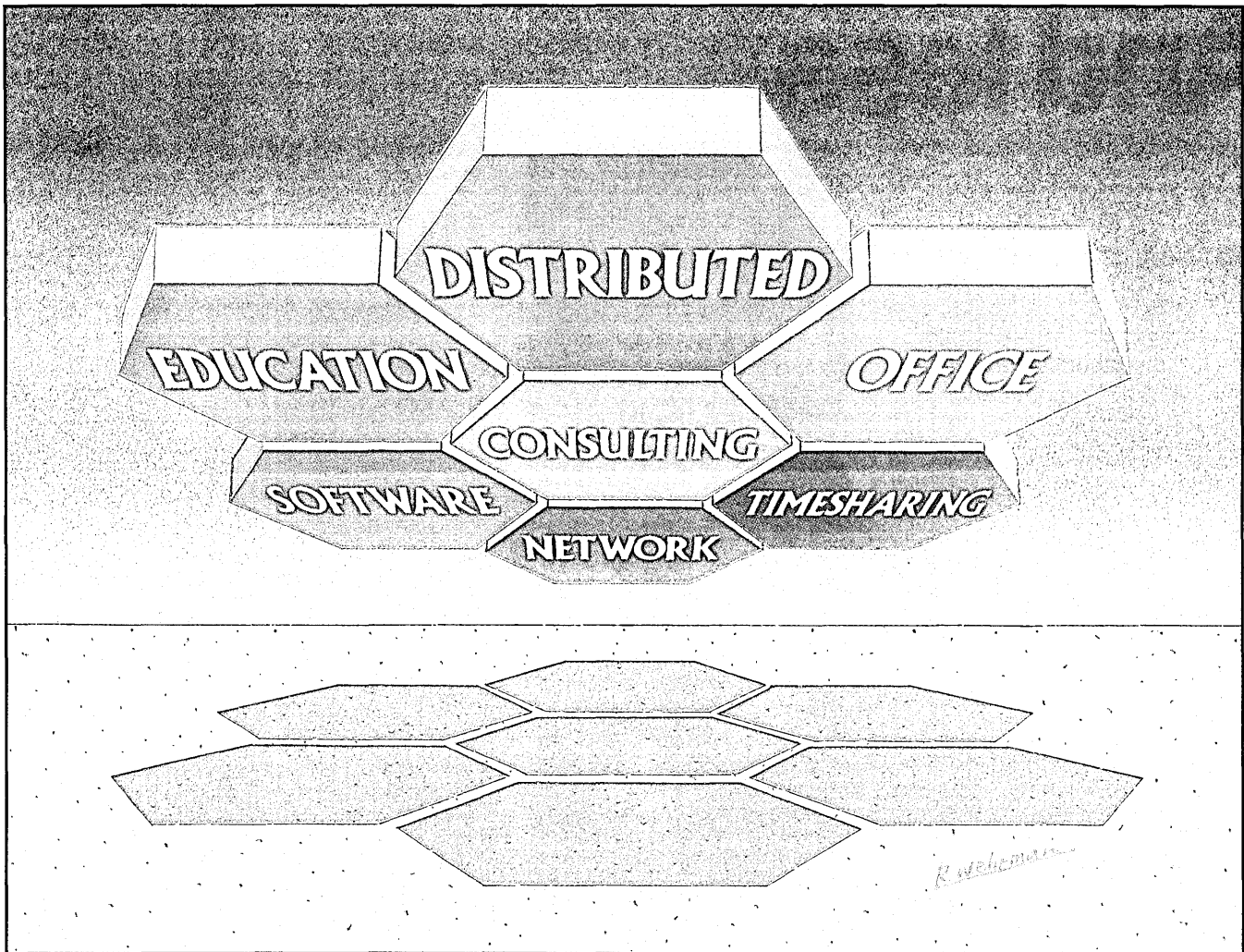

Meeting information needs has become a major international concern. One in which maintaining compatibility and unity is a difficult task. That's why Boeing Computer Services offers a unique combination of integrated information services to government and industry. To help you obtain precisely the systems, services, and software you need.

For example, we design, implement and maintain large-scale communications networks — integrating the best technology without hardware bias. Our Office Information Services

can help you at any stage in the office automation process. With all-new or existing equipment.

We've also enhanced our MAINSTREAM® teleprocessing network to offer you today's leading operating systems and programming languages. No other remote computing firm gives you as many valuable options.

And we're linking microcomputers to our MAINSTREAM service in exciting new ways: workstations involving the IBM® PC/PC XT and XT/370, combined with our EIS® business management software. And

our Micro/8410 Workstation for structural engineers.

Finally, we provide a full range of Software Solutions. Complete Education & Training. And a variety of Professional Support Services.

In each area, Boeing offers you integrated solutions, designed to harmonize with your overall operation. For more information or the location of the sales office nearest you, call toll-free 1-800-447-4700. Or write BOEING COMPUTER SERVICES, M.S. CV-26-20C, 7980 Gallows Court, Vienna, VA 22180.

BOEING COMPUTER SERVICES

A Division of
The
Boeing Company

MAINSTREAM and EIS are registered service marks of The Boeing Company • IBM is a registered trademark of International Business Machines.

CIRCLE 48 ON READER CARD

Almost overnight, the microcomputer software business has gone from boom to bust. How come?

ALAS POOR VISICORP

by Efreem Sigel

The last straw came in November and anyone who missed the previous signs—though you'd have had to have been blind to have done so—could hardly overlook the symbolism of this one. VisiCorp of San Jose, the company that had started the great software boom in 1979, was calling it quits. It did so in the form of a face-saving merger with Paladin Software, Santa Clara, that would mean the end of the VisiCorp name. The announcement capped a process set in motion nearly two years before when VisiCalc began taking its lumps in the market from an upstart, Lotus Development's 1-2-3 package.

If you haven't heard of Paladin, there's no need to fret. It is another in a long line of micro software firms with bright, experienced founders, a couple of million in capital, a full-time PR man on staff—and no product on the market yet. But the fact that VisiCorp would sell out to this unknown is the best indication yet that the first round of the Software Boom has about run its course.

What Dan Fylstra, VisiCorp's chairman, achieved by this merger was the avoidance of the ignominy of Chapter 11 bankruptcy, or a return to the days of a few guys in a basement trying to get out a product. Still, it had to be galling to have taken a company from zero sales in 1978 to \$40 million in 1983, and back down to something in 1984 that was probably closer to zero than to \$40 million.

Even so, there is satisfaction, a melancholy satisfaction, in this rise and fall. Fylstra and his sometime collaborator and later antagonist, Dan Bricklin of Software Arts, created a product, VisiCalc, that changed the nature and velocity of the personal computer industry. Not only did they create it, but they sold it by the hundreds of thousands—more than 700,000, in fact—an achievement so far matched by only one other micro software product, MicroPro's Wordstar.

It is lamentable and a great business

failing that VisiCorp and Software Arts could not work together on an improved product that would meet the competitive threat of 1-2-3, but no one can deny the achievements of VisiCalc. It was a startling conceptual breakthrough that made life easier for thousands of customers and inspired countless would-be entrepreneurs.

VISICALC SUCCESS UNMATCHED

Few of this year's software bankruptcies can point to anything remotely similar. There is Knoware, the Cambridge, Mass., firm funded with the assistance of ex-IBM, ex-AT&T executive Archie McGill. It raised \$2 million in late 1983, put a middling training product called Knoware on the market, ran a slew of cutesy four-color ads in business magazines, and had vanished into Chapter 7 by October.

Or Ovation Technologies, which raised \$5.5 million from such blue-chip venture capital firms as Oak Investment Partners, J.F. Shea, and Glenwood Management, in addition to \$1.3 million in earlier seed capital. The money came pouring in on the basis of an idea for an integrated software package that would provide word processing, spreadsheet, database management, and communications functions.

Not only did Ovation cofounder Thomas Gregory raise the money, but he built a staff of 46, including a full-time PR director, spent hundreds of thousands on ads and exhibits at Comdex and Softcon, saw his company's name written up in the *Wall Street Journal* as a software leader, and negotiated a contract with Tandy, which gave the new company instant visibility. All these things would normally rank as business achievements, except that Ovation failed to do the one thing that would have made it meaningful—it never got the product to work. Ovation the product was never shipped, and the company ceased operations in October, having run through \$6.8 million in hard cash and an untold fortune in wrecked reputations.

Then there are the software compa-

nies that did produce a product. Human Engineered Software (HES) of Brisbane, Calif., produced more than three dozen packages. Some, like HesWriter 64 and Gridrunner, sold in the tens of thousands, or so the company claimed. HES bet on the Commodore 64 when other software developers were skeptical and it rode that bet to what it claimed was \$13 million in sales in its FY '84. But, like so many other companies, HES believed and spent as if it were the accepted order of things for sales to increase fivefold every year. In 1984, it wasn't and they didn't. Backers like Microsoft, Action Industries, and Technology Venture Investors refused to put up any more money and HES filed for protection under Chapter 11 in October.

Peachtree Software also produced products and sold more than 160,000 of its accounting titles and Peachtext 5000. Management Science America, Atlanta, which bought the company in June 1981, looked like a shrewd judge of industry trends: Peachtree sales nearly tripled in 1982, from \$3.3 million to \$9.4 million, and grew another one and a half times in 1983, to \$21.7 million.

In 1984 the roof fell in. MSA had budgeted for a 50% sales increase at Peachtree, released more than 20 new products, and allocated \$3 million for advertising and promotion. But in the second and third quarters of '84, MSA lost a total of \$3.5 million as Peachtree revenues fell woefully short of budget. The nine-month loss at the microcomputer division came to more than \$10 million, and MSA decided it had had enough. The division went up for sale (see "Vendor Outlook Bleak," Dec. 1, p. 36).

Even having a better product is, unfortunately, no guarantee against disaster. SofTech Microsystems, the San Diego subsidiary of SofTech Inc., Waltham, Mass., is an ardent proponent of the p-System, one of the operating systems for the IBM PC and other microcomputers. (The p-System was adopted by a variety of knowledgeable applications software developers, like Context Management Systems, Torrance, Calif.,

These tales of woe are not isolated: they are repeated in dozens of publicized and unpublicized cases.

and Beaman Porter, Harrison, N.Y. Despite some rave reviews, however, their main products, Context MBA and Power-Base, respectively, haven't been wildly successful in the market.)

By selling its system to manufacturers like Digital Equipment, Hewlett-Packard, NEC, and Wang, SofTech Microsystems was able to increase sales from \$4.4 million in FY '82 to \$7.6 million in FY '83. But as the IBM PC became the dominant desktop in the market, so did IBM's chosen operating system, Microsoft's MS-DOS, become the dominant operating system. In late 1983 and 1984, SofTech Microsystems' sales began to fade at an alarming rate. Sales in FY '84 were up a scant 10%; sales in FY '85 will be lower than in the previous year. Losses have run into the millions.

These tales of woe would be unpleasant enough to hear if they were isolated. But isolated is what they are not—they are repeated in dozens of publicized and unpublicized cases. Moreover, they affect every manner of software company, from established firms to those just starting, from companies in home software to business software, from those that produce languages and operating systems to those turning out applications programs, from those that began with a few hundred dollars and an Apple II on the kitchen table to those that raised \$5 million and started in fancy offices.

Thus, in surveying the wreckage of micro software companies at the end of 1984, one can hardly avoid the dismal suspicion that one is witnessing not so much the rise and fall of software companies as the rise and fall of the entire software industry.

REASONS COMPANIES FAILED

To see whether or not this proposition is true—and I'll argue that it overstates the case—it's necessary to try to find common reasons for the abundant software company failures. No single reason will explain all the failures, but I believe most can be traced to one of the following hypotheses.

Failure to understand the faddish aspect of personal computers. When a firm is riding high, shipping products out the door faster than they can be made, there is a natural temptation for its managers to conclude they're in the midst of a social or business revolution—even that they are helping to lead the revolution. Many software company managers have been guilty of this error. It is harder to accept that much of the surge in personal computer sales, both home and business, has been a fad.

The fad is easiest to see in the consumer market where millions of consumers rushed to buy low-priced home computers out of guilt ("your children deserve no less"), or social pressure ("everyone I know has one"), or intellectual challenge ("you too can learn to program in BASIC"), but not because they needed a computer. Consumers may shell out \$200 on a piece of hardware for this reason, but they are not about to spend \$35 a crack to buy new software each month for a computer whose utility they do not understand.

No convincing reason for owning a home computer can yet be made, not word processing (most consumers don't write a letter from one year to the next), not Christmas card list maintenance (the dog-eared address book does this much better), not money management (which requires a lot more than a personal computer program, namely time, discipline, and the ability to set objectives and stick by them). It is ironic that the best reasons for buying a home computer are the ones most often derided by the computer cognoscenti: to play games and to have the kids learn a little bit about how computers work.

Of course the business computer market is different, but not *that* different. When companies buy personal computers by the thousands for middle managers, should we assume that every one of those managers needs to use a PC to get his or her work done? If hundreds of thousands of individuals put in long hours to learn 1-2-3 or dBase, does this mean that spreadsheets or database programs are vital to modern business life?

Maybe. But it's just possible that many of those laboring to master the new software are doing so out of peer pressure, not genuine need. People have jobs that consist of making sales, dealing with customers, keeping books, checking the quality of products on the assembly line. Manipulating 1-2-3 or dBase II is not a job in itself, but a means to accomplishing something. Undeniably, these programs have brought about striking improvements in business productivity for thousands of users. Just as undeniably, thousands of others are wasting their time and their employers' money struggling with computers, when instead they should be doing the jobs they were hired to do and letting specialists run the information machines.

None of these propositions can be proved. But one reason for the disappointing slump in software sales could be that more computers are winding up in the hands of less committed customers—customers who use the machines less, buy less software, and who will readily give up their

new toys as soon as the novelty wears off.

Failure to understand that software is a tool, not a disposable. Hand in hand with a misapprehension about what is driving the personal computer industry is a woeful lack of perception about what gives software its peculiar appeal. Over and over, software promoters compare their products to razor blades, 45-inch records, paperback books, or consumer packaged goods—products to be bought in huge quantities, used up, and then repurchased or discarded for the new and improved version.

But good software resembles the razor handle much more than the blade. In fact, a good piece of software is like a fine hand or power tool. It is a durable good, not a consumable, a piece of equipment to be learned, not a toy to fling away when something new comes on the market. How else can we explain the fierce loyalty of software customers to their very own programs and their manifest unwillingness to switch, even to something acknowledged as an improvement? The big gains in productivity come when users have mastered their programs and then built a personal or organizational routine around their use. We are talking about new behavior that has been painstakingly learned; once learned, it is difficult to alter.

USERS MAKE DO WITH LESS

The tool analogy works in another way. Most of us require very few implements. The screwdriver, hammer, pliers, and saw serve for 99% of our everyday fix-it jobs; only the hobbyist or craftsman buys a new tool every month. So it is with software. For most, the word processor, spreadsheet, and database manager are the maximum that are needed; many of us can do with less. Anything more esoteric—e.g., an idea processor, an outliner, decision aid, or project manager—is likely to have as narrow a market among software customers as the router and turning lathe among home handymen.

Failure to understand the importance of good management. Good software ideas and good advertising slogans are no substitute for good management. Poor management is the biggest reason for the failure of software companies, just as with any other companies. The amazing thing is how many entrepreneurs—and investors—fooled themselves into believing otherwise.

The management failures of software companies in 1984 have been legion. One of the most common blunders is mutton publishing—as, for example, in putting out the 74th word processing or the 38th database program for the IBM PC. To try to muscle one's way into the market when so

How to tell when an on-line application development system is exactly right for you.

If you're like most DP managers, you have a tremendous on-line application development backlog. And too few Command Level COBOL programmers. Which means you need an on-line application development system. The question is, which one?

Now there's a quick, simple, graphic way for you to find out.

Define your parameters with The Resource Management Grid.

Based on experience with over 2,000 CICS users, Oxford Software has developed The Resource Management Grid. By plotting all the projects on your work list on this grid, you can define which on-line system best meets your own unique parameters.

Upper-left-hand cluster: Optimum UFO performance.

When your on-line projects cluster in the upper-left-hand corner of the grid, delivery time is your main concern. So the system for you is UFO,[®] a fourth-generation solution to on-line application development in the CICS/VS and IMS/DC environments.

UFO dramatically reduces the time required to develop and maintain new programs. What might take months to put up and get running with Command Level COBOL can now be accomplished in as short a time as one day. Because UFO is so easy to use, your entire programming staff can develop applications with it. And even end users can participate in the development of programs and access data for one-time inquiries.

Lower-right-hand cluster: Optimum UFO/COBOL performance.

When your on-line projects cluster in the lower-right-hand corner, your primary concern is machine-resource availability. Thus, UFO/COBOL[®] is appropriate for you, utilizing machine resources equal to Command Level with significant gains in the speed of developing new applications.

In UFO/COBOL, the CICS coding skills normally required of the programmer are inherent in the UFO/COBOL language. So complete, portable CICS programs can be written in standard ANSI COBOL in a familiar and natural way. While you're maintaining established shop standards.

The Application Development Resource Management Grid:

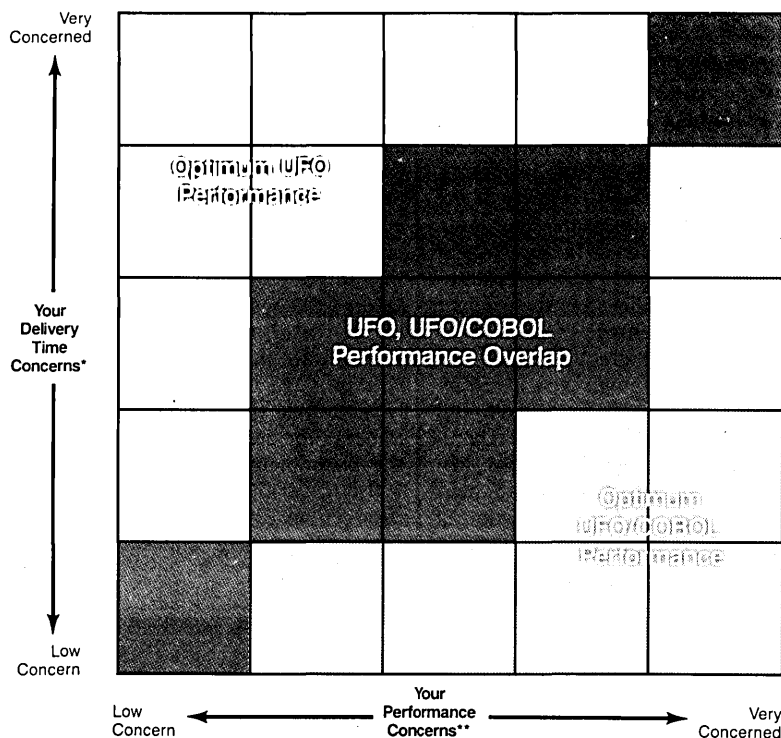

* A Function of—Number of programmers, Number of applications, Skills available, Due dates.
** A Function of—Machine resource availability, Application complexity, Transaction volume.

No cluster pattern: UFO plus UFO/COBOL.

You may well find, however, that many of your projects cluster right in the middle of the grid. Or that there is no pattern. In that case, installing both UFO and UFO/COBOL is the most cost-efficient solution.

For example, you use UFO to get a program put up and running quickly, with the potential to convert it to UFO/COBOL for maximum running efficiency.

Call or write for your Grid Kit.

Only you can decide, of course, which on-line application development system meets your needs best. Or which vendor can provide you with the most complete solution. But The Resource Management Grid Kit can be of immeasurable assistance in helping you make these assessments.

Call OXFORD today
(800) 631-1615

OXFORD SOFTWARE CORPORATION
174 BOULEVARD/HASBROUCK HEIGHTS, NJ 07604/201 288-1515

Please send me your Grid Kit.
 I'd like to schedule a UFO and/or UFO/COBOL demo. Please call to set a date.

DM-1
Name _____
Title _____
Company _____
Address _____
City _____
State/Prov _____ Zip/Code _____
Phone () _____

OXFORD SOFTWARE CORPORATION
174 BOULEVARD/HASBROUCK HEIGHTS, NJ 07604/201 288-1515

W.S.A. Outside North America, contact one of the following WSA companies: Europe—Austria 0222-31351840; Benelux (NL) 03402-61066; France (Paris) 1-294-2184; (Lyons) 7-233-7473; Greece 01-9590-631; Italy 011-517618; United Kingdom 01-950-3576; West Germany 02161-67604; Scandinavia (Sweden) 08-761-7380; Spain 01-279-6100; Middle East/North Africa—Greece 01-9590-631; South Africa—11-337-3040; Israel—4-256195; Asia—Hong Kong 05-666511-3; Japan (Nagoya) 052-211-5021; (Osaka) 06-445-7561; (Tokyo) 03-437-0921; Singapore 65-2253755; Australia—New South Wales 02-436-2477; South America—Brazil (Rio de Janeiro) 021-224-4379; (Sao Paulo) 011-258-1983.

Good software ideas and good advertising slogans are no substitute for good management.

many products already exist requires either arrogance or myopia. Every once in a while, of course, the arrogance is justified. Lotus Development was seemingly arrogant in bringing 1-2-3 to market when Visi-Calc was dominant and a dozen other spreadsheets were battling for the second spot. Confounding the skeptics, 1-2-3 became a huge success in its first 100 days. Software Publishing Corp. took a similar risk in releasing PFS:Write in the face of scores of other word processing programs. In the case of Lotus, the superiority of the program and the novelty of the marketing approach carried the day. In the case of SPC, having a huge existing base of customers and dealers who believed in the product proved a decisive advantage.

Much more common are the failures of me-too publishing, even at established companies. For all its success with MS/DOS and Multiplan, Microsoft has barely made a dent with Microsoft Word. MicroPro's database and spreadsheet programs show an insignificant portion of revenues. VisiCorp, Sorcim, Software Arts,

Ashton-Tate, and Microrim are among other companies whose success with one product has failed to carry over to additional offerings.

CHILDISH THEORY OF MARKETING

Failure to grasp fundamental concepts of marketing. Software managers and their investors have been guilty of accepting and acting on a childish theory of marketing that has two propositions. One is that it is enough to get products onto retailers' shelves ("All that matters in this business is shelf space," says one software company head.) Two, that the way to get onto shelves is to bombard retailers and consumers with advertising. Belief in these simple-minded doctrines has led software publishers to load up dealers with products that don't move—what really matters in this business is whether customers, not dealers, buy—not to mention the phenomenon of ad budgets that are 100% to 1,000% of sales, instead of the desired 5% to 10%.

(In passing, one should note that

some of the most successful micro software companies have little or no retail distribution and practically invisible advertising—like Micro Focus and Ryan McFarland, with their strong oem and corporate end-user sales. And even those leaders spending heavily on advertising, like Microsoft, built up to present levels over years, instead of trying to force their way into the market by exploding a single \$5 million promotion bomb.)

Failure to treat money matters seriously. This is the biggest management failure of all. How is it that an HES goes bust despite \$13 million in annual sales? Or that MSA spent nearly twice as much on Peachtree in the first nine months as that division achieved in sales? Or that VisiCorp sank \$10 million into the VisiOn windowing system—a sum that represented more than double its annual after-tax profits—when it had never before conducted any significant internal product development?

All these companies came to grief because they treated software dollars like play money. For some, the initial growth was so rapid that they believed it would never slow down. For others, the money didn't count because it came from outsiders—from venture capitalists, now ruefully dubbed vulture capitalists by entrepreneurs whose companies have been dismantled. Whatever the case, too many software managers never learned the most elementary management lesson of all: you can't spend it if you don't have it.

The software business is not like the hula hoop or coonskin cap or even like the video game cartridge business. Those were fads that had their bright burst of commercial glory followed by oblivion. Software and software companies are at the early stages of what will be many years, perhaps even decades, of growth. Personal computers and the software to make them work will get better, faster, cheaper, and easier to use. Moreover, the fortunes yet to be amassed in software will make some of the early successes seem insignificant. What has become apparent during the most recent rise and fall, however, is that many of today's software promoters won't be around to participate in these future glories. Whether because of naïveté, overenthusiasm, greed, or incompetence, they are doomed to sit on the sidelines as the next chapter in our drama unfolds. ©

Efrem Sigel is president of Communications Trends Inc., Larchmont, N.Y., a research firm that specializes in software, electronic publishing, and computer services. It publishes *Software Industry Profile Service*.

CARTOON BY HENRY MARTIN

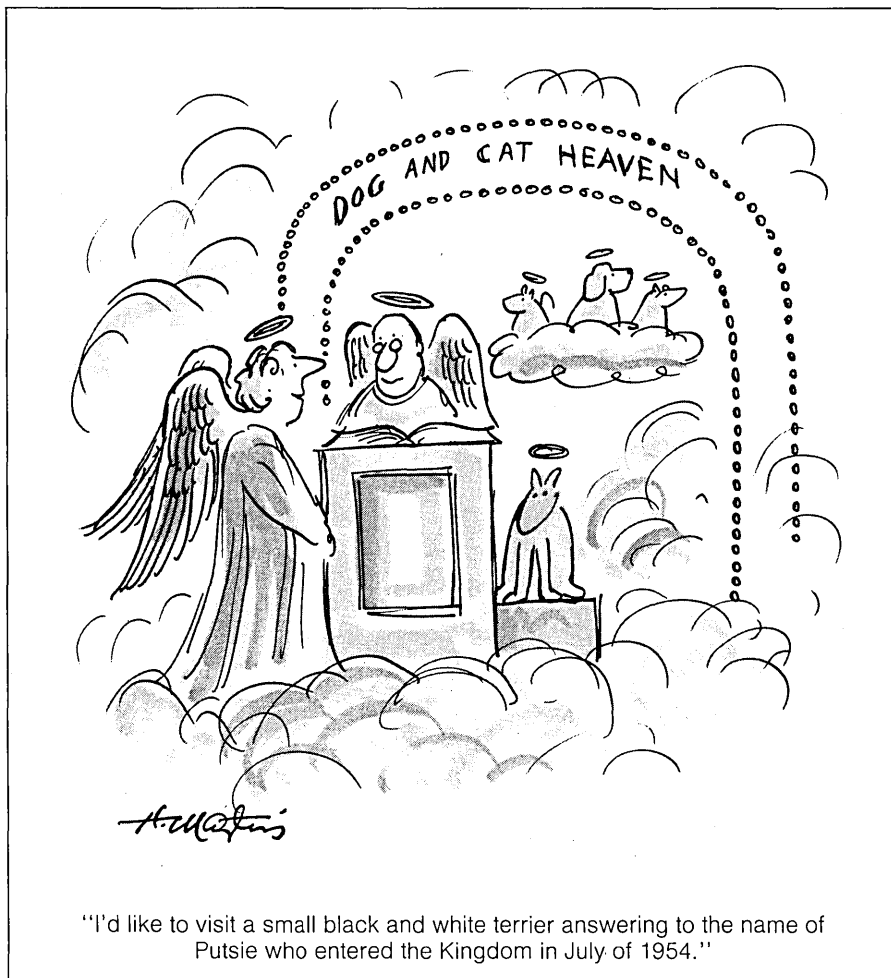

"I'd like to visit a small black and white terrier answering to the name of Putsie who entered the Kingdom in July of 1954."

Test drive our Strategy.



Network Systems Corporation, the HYPERchannel® Company, invites you to check out our strategy.

THE RIGHT NETWORK. At Network Systems Corporation, our products are designed for a total networking strategy. With the right network, you can interconnect computer hardware from different manufacturers: super computers, mini and personal computers, workstations and terminals.

You've probably been told that a local area network lets you hook-up all types of computers and terminals, and everybody can then talk to each other. In the real world, it just isn't that simple. We offer what it really takes; hardware, software and system integration.

HYPERbus®, our 10 megabit network, will serve your user areas, providing the interconnection of mini-computers, PCs, workstations and terminals. Next, the user area should be linked to your larger mainframes to give users direct access to your integrated data bases. This is where HYPERchannel, our 50 megabit network, comes in. HYPERchannel gives you the power to move vast amounts of data between mainframes. The result is a truly responsive access path to the user area, which is the key to increased employee productivity. Finally, the different computers and terminals must be

able to talk to each other. NETEX® is our software product that lets them communicate in a common language.

With HYPERchannel, HYPERbus and NETEX applied to your **total** networking strategy, users can access and manipulate data like never before. Your data processing systems will work harder, faster and in unison.

THE RIGHT COMPANY WITH THE RIGHT STRATEGY. Networking is our only business and we want to be your networking company. We have the products, the experience and a field service organization that's there when you need them.

There are over 400 customers using our systems. If you are planning a network, call or write Network Systems Corporation. You'll see how our strategy can help you with your strategy.

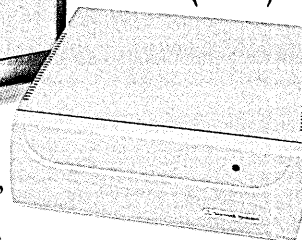
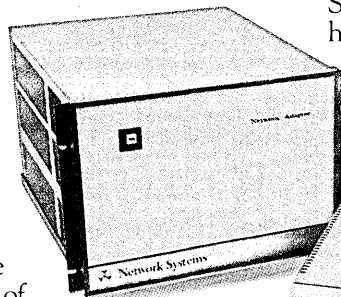

Network Systems Corporation

7600 Boone Avenue North
Minneapolis, Minnesota 55428

612/425-2202

Accept no limitations.™

Offices in most major cities.

© 1984 Network Systems Corporation

CIRCLE 50 ON READER CARD

Until not so long ago, the mainframe was the hub of the information universe.

Big. Powerful. Intelligent. It was a master of all it surveyed.

But then something happened. Something very alien to the mainframe's way of thinking.

The personal computer was created. And the war of the information worlds was on.

Introducing the Exchange Series from Intelligent Technologies.

From the very beginning, we recognized the benefits of getting micros and mainframes together.

And backed by Logica, a world leader in communications and information systems, we developed a whole series of products that do just that.

Cost-effective and fully-supported, our Exchange Series™ lets IBM® PCs, XTs, PC-compatibles and mainframes work together in harmony.

And lets you solve virtually any micro-to-mainframe requirement you have. In virtually any environment you run.

And it all fits into the system you already own.

Exchange Series products consist of software on diskettes and printed circuit boards. They communicate over voice-grade or leased lines, as well as via coax cable.

So now, PC users company-wide can share, transfer and file the latest on-line corporate information in SNA, async or bisync environments on PCs running under PC-DOS. Or Concurrent™ PC-DOS, which allows windowing and multi-tasking.

In short, they can work a lot faster and a lot smarter than ever before.

What's more, the Exchange Series is easy to upgrade. Additional software lets you add other protocols as you need them. To help keep micros and mainframes—and the people who use them—aligned for years to come.

SNA Exchange™ SNA/SDLC communications; 3274 cluster controller, 3278/9 terminal with multi-sessioning, 3287 printer and 3777-1 RJE workstation emulation. Provides toggling between DOS and 3270 functions, plus the ability to process

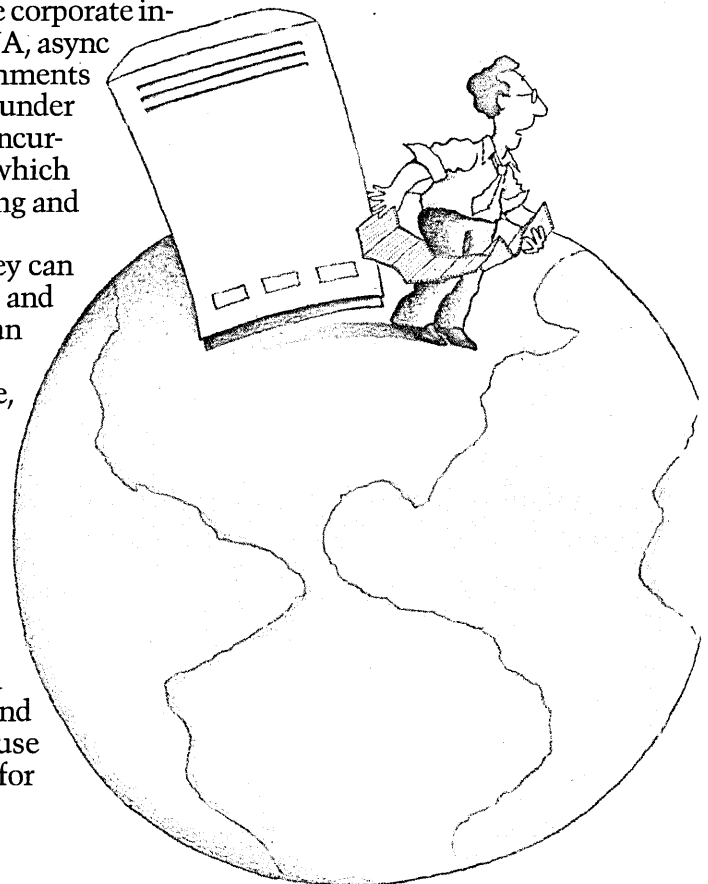

We bring you without a

records received from or destined for the mainframe.

File Exchange™ A file transfer software package that supports bi-directional transfer of data over coax or modem connections between PCs and mainframes running CICS,

TSO and CMS applications.

Coax Exchange™ Lets a PC emulate a 3278/9 display terminal via coaxial connection.

Bisync Exchange™ 3270 Allows bisynchronous PC-to-mainframe communications; 3274 cluster controller, 3278/9 terminal and 3287 printer emulation.

Bisync Exchange™ 3780 Allows a PC to emulate a 3780 or 2780 Remote Job Entry workstation. Also provides PC-to-PC 4800-baud communication, with data transparency.

Async Exchange™ An add-on software package for asynchronous communication including DEC™ VT100/52 emulation between PCs and DEC as well as other asynchronous mainframes.

ClusterNet™ 3270 and ClusterNet™ 3278 Allows a master PC to emulate a 3274 cluster controller, and up to 3

additional PCs to emulate 3278/9 terminals via a multi-drop twisted-pair cable.

PC Exchange™ Asynchronous communication between IBM PCs, and between PCs and asynchronous mainframes; DEC VT100/52 emulation; fully integrated telephone management system including electronic mail.

PC Exchange™ with SNA Combines the functions of SNA Exchange and PC Exchange in one complete package.

The intelligent solution is just a phone call away.

If you want to avoid a head-on collision with your information system, call us, toll-free 800-523-8396 outside CA, 800-223-1744 inside CA. Or contact one of our reps listed below.

Either way, we'll show you how the Exchange Series can help launch you into a whole new realm of communications possibilities.

For an extremely down-to-earth price.

 **Exchange Series from Intelligent Technologies™**
a logica company

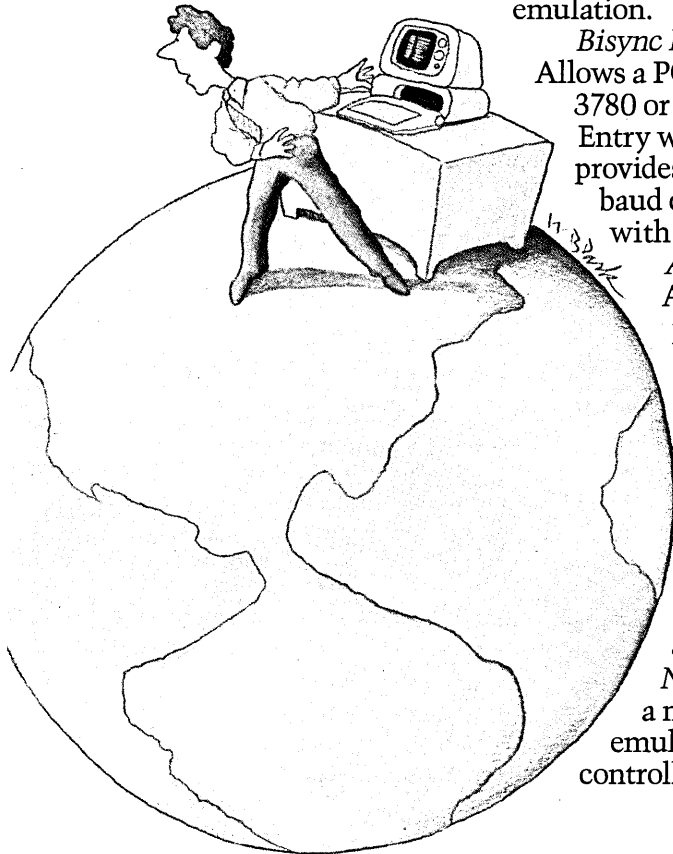

Worl ds together collision.

Intelligent Technologies, Exchange Series, SNA Exchange, PC Exchange, File Exchange, Coax Exchange, Async Exchange, Bisync Exchange and ClusterNet are trademarks of Intelligent Technologies International Corporation. IBM is a trademark of International Business Machines Corporation. DEC is a trademark of Digital Equipment Corporation. Concurrent PC-DOS is a trademark of Digital Research, Inc. Some of the software products contain Access/SNA™ Communications Solutions, Inc., San Jose, CA.
© 1984 Intelligent Technologies International Corporation.

CIRCLE 51 ON READER CARD

Attention IBM Users

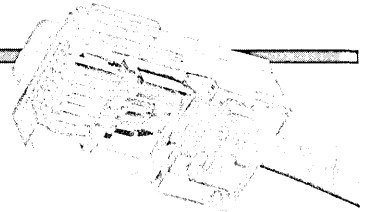

**“Paradyne
Makes Your
Remote Devices
Behave...
Like Locals.”**

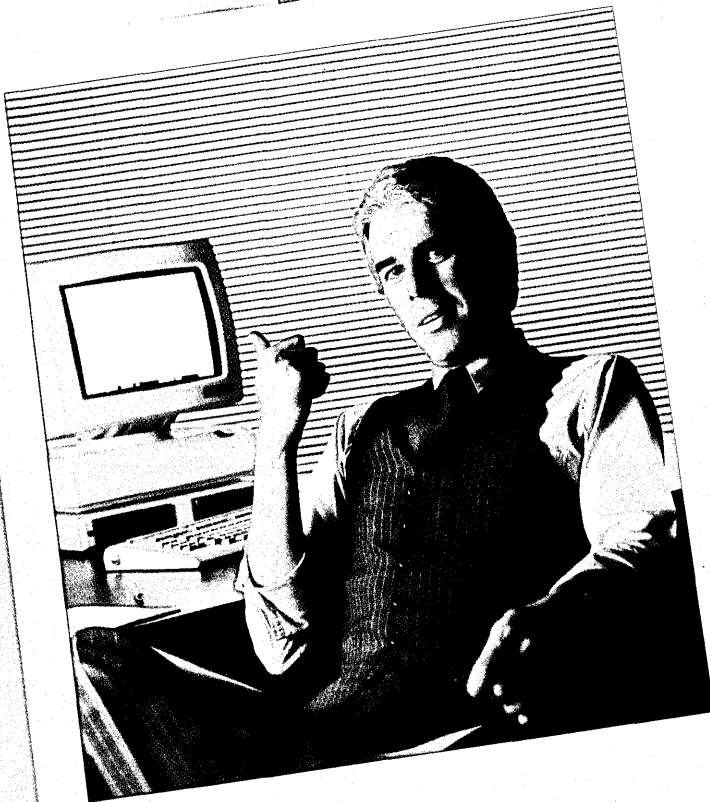

**Plug Them Into
Paradyne's PIXNET.**

With PIXNET, terminals and high-speed peripherals can be placed in any location. In another building or another town.

They'll be gone but not forgotten. Because they'll still behave like local devices, under the control of your same CPU over your same communication lines.

The “Spooler Fooler.”

With Paradyne's PIXNET, remote = local. The host CPU will think your remotes are right in the same room. So remote devices can be run from their own locations.

Access any program or application, in any computer on the network, from the remote location.

Low-Cost Network Expansion.

Widen your data operation with this cost-effective networking innovation.

Move a device, a CPU, or a department over the weekend and be up and running Monday morning.

With no extra front-end processors. No extra software, for host or application. No extra burden on the host.

Improved Remote Performance.

Run high-volume IBM 3890 check processors from your home office mainframe. With PIXNET you can process 100,000 documents an hour at your remote site with no additional CPU power.

Print up to 60 pages a minute remotely with Paradyne's Remote High Speed Page Printer. Paradyne's PIXNET also improves the performance of remote high speed printers and IBM 3270s.

Call today and find out how we can put your remote devices on their best behavior.

1-800-482-3333

Paradyne Corporation
P.O. Box 1347 8550 Ulmerton Road
Largo, FL 33540

paradyne

CIRCLE 52 ON READER CARD

How to profit from the information revolution while avoiding hard work.

THE COMPUTER EXPERT'S GUIDE TO LIFE

by Charles Bassine

Computers are not necessarily a good thing. Although computer games offer diversion, there is little practical opportunity in computers unless you are serious about computer crime.

Computer crime, however, requires insight, dedication, and careful planning, and so is not for everyone. An easier way to make money with computers is to become a Computer Expert. This is not as rewarding as computer crime, but it is less risky and requires much less work.

What is it really like to be a Computer Expert? It is like this:

1. Your boss will not understand what you do. His eyes will glaze if you try to explain it to him.

2. No one will ever know where you are, and if you aren't in the office, every one will suppose you are in Poughkeepsie.

3. You will not be required to produce anything, ever.

Best of all, computers will be largely excluded from your life. This is important in a world where everyone from typists to lawyers is expected to be using, or thinking about using, computers in his job.

This article provides essential guidance to Right Thinking in planning a computer career. The guidance is sound and useful because it is based on a simple principle: your success as a Computer Expert varies inversely with your interest and competence in computing.

Where to look for employment. A good rule is to avoid any company that uses a great many computers to run its business. The problems companies try to solve with computers are even less interesting than computers themselves. Also, there is the possibility, admittedly slim, that after enormous expense in acquiring computers, people will notice that nothing is happening,

and ask why.

If you have to work for a computer user, here are some guidelines for selecting an appropriate employer:

- The company should have the most obsolete computing equipment in the industry. This shows a proper view of the value of computing.

- The funds spent on computing should be controlled by a Financial Officer at least 73 years old. He will not fret about why you are not suggesting computer solutions.

- The computer activity should be part of an enormous bureaucracy that has a reputation for being completely unresponsive to the needs of the operational departments of the company.

Never accept a job in a department that has its own computer and is trying to solve its own problems. The department you wish to work for is called, variously, MIS (Management Information Systems) or DPD (Data Processing Department). Its identifying characteristic is that it runs all of the computers for its own convenience, and tries to discourage others from using them.

The best employment for a Computer Expert is working for a manufacturer of computers. There are several reasons why this is so. For one thing, computer manufacturers make minimal use of computers in their own businesses. For another, knowing nothing about computers will



ILLUSTRATION BY DAVID FISHER

The new Computer Expert must start by picking a computing specialty.

help you get promoted to management in this environment. And finally, large computer manufacturers have a list of odd people who know and love computers and keep the company in business. If you can keep off this list, no one will notice you are around.

There are a few disadvantages, however. If you like city life you will have trouble. Perhaps for reasons of security—computers make people angry—computer manufacturers prefer more rural environments. Another factor may be a secondary interest in agricultural products. In the environs of one of the largest computer manufacturers, there are apple orchards, orange groves, and cattle. This manufacturer is not yet convinced that the computer business is here to stay, and is hedging its bet. It may also mean that the manufacturer feels that Computer Experts would pick fruit at low rates.

The working environment. A Computer Expert, like anyone else, must pay attention to external appearances. There are fundamental rules for going about this:

1. Keep your desk constantly cluttered with papers and articles. This suggests you are into things, learning, and doing.
2. Write memos. About anything. Choose subject headings judiciously, and don't worry about the body being relevant to the subject.
3. Always express concern and anxiety to your colleagues. Never be pleased

with any technical decision your company has made.

4. Promise anything. Management forgets.

BECOME A KNOW-NOTHING

Not choosing a specialty. The Expert must decide whether to be a generalist or a specialist. In general, one cannot start off by being a generalist. It takes time (but happily, very little effort). One must spend time in buildings with a variety of different kinds of projects. One need not be otherwise associated with them. Being a generalist is a long-term goal. What is a generalist like? First, he knows almost nothing about almost every aspect of computing, and can use jargon words in apparently correct sentences. To wit: "I think we generated the macros in the same way in 1959 on COMPSAC/465L SACCs on the old FSQ/38. Trouble was, we found the subroutine linkages very expensive."

In generalism, one claims to have done everything and to now know better. A generalist can also imply that any aspect of computing not known to him is not worth knowing, or dangerous. He does this with remarks like, "Well, of course, you can write articles about stuff like that, but I don't see it ever being practical." Equally useful is the opposite tack: "These people don't have the theoretical background they need. It's all seat-of-the-pants and ad hoc. Goin' to get in real trouble."

Generalism is a good way to avoid the accusations of technological obsolescence. Computer Experts are always using to discredit each other. A good generalist can take the offensive with cracks like, "He thinks a high-level language is one where you write programs on a tall stool." And, in the U.K., "The last manager to take him seriously about database design was William I."

Generalists are like designated hitters because they command high salaries and go on forever. As they go on, they discourage young computer science graduates with the feeling that it has all been done or that it is too hard to do. After speaking with a Senior Consultant, one young PhD from MIT (they deserve all they get, too) wrote to his mother that things were "so complex it sometimes seems nothing is worth doing."

This young man has had a serious insight: nothing *is* worth doing. It is the ability to move young people in this direction that makes an older generalist so valuable to a company.

Choosing a specialty. Since the status of generalist comes only with time, the new Computer Expert must start by picking a computing specialty. Do not be discouraged by the dreary list of possible specialties. A specialist need know only enough about his area to make nine simple declarative sentences in a meeting. It is important to know which verbs take direct objects and which nouns are inherently plural. For example:

Wrong: lock management are a very important part of distributed databases.

Right: lock management is a very important part of distributed databases.

Some specialties are better than others. Physics and electrical engineering are bad because they require formal education and have a high possibility of getting you work with a measurable result. These bad specialties have to do with hardware, the essential electronic componentry of computers. Because it is associated with bad specialties, there is getting to be less and less hardware in computers and more and more firmware and software.

CHOOSING THE BEST SPECIALTY

Software is a good specialty, and the best software specialties have to do with programs that no one really believes are necessary. Top candidates include:

- Operating system design. There is no known way to be successful at this and consequently no known way to fail at it. It is the creation of programs that make computers easy to use and efficient. It's best to



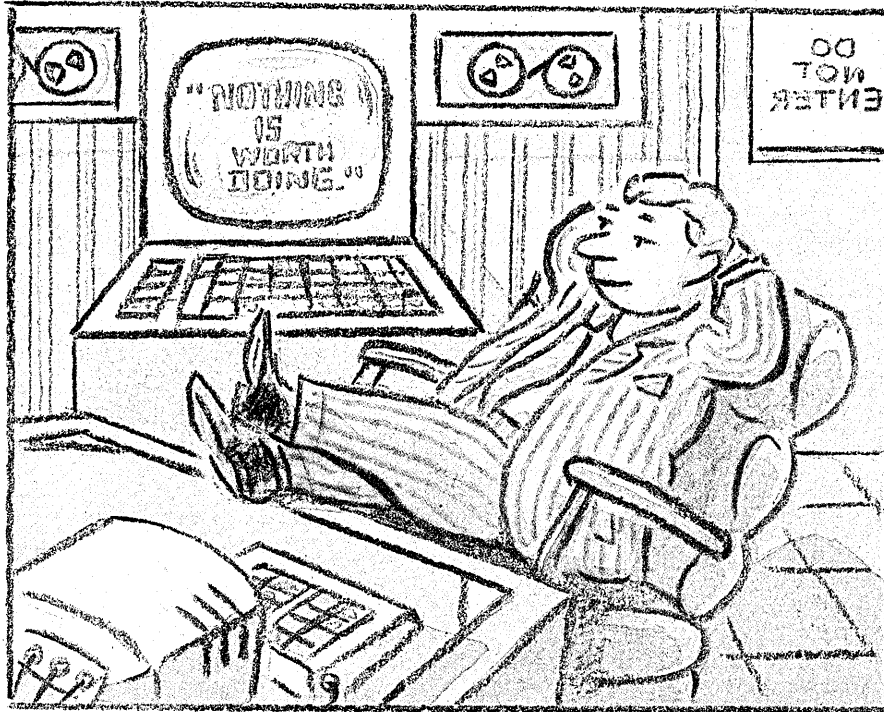

design very large operating systems because such systems are never actually completed, no one knows what they do, and no one likes them anyway.

- **Product requirements.** This means predicting what people will want computers to be like in the future. No one will believe your predictions. No one will know what to do about them if they believe them because there is no known way of translating product requirements into actual computer products. This is a very good thing since no one really wants the computers they say they want anyway.

Most product requirements indicate that people want computers that are easy to use, reliable, easy to install, and easy to extend. This is just not true. People's jobs depend upon computers being hard to use, unreliable, difficult to install, and almost impossible to enhance. This is why people who actually make new computer products do what they damn please, and then announce that the machine has "good human factors."

Probably the best current specialty is computer education. This is an area with a number of subspecialties:

1. Educating people who know nothing but would like to use computers. Avoid this.
2. Educating people who know nothing but someone is insisting they find out. This is not bad. You will be talking to people much like yourself.
3. Educating computer experts who

are trying to keep up with changing technology and advanced topics. Make it up as you go along; you are with friends.

Basic career tactics. We are in a men's room of the headquarters of a top computer company. An Industrial Democratization Program mistranslated from the Japanese forces Top Executives to share this facility with diverse Computer Experts. (The democratization does not, oddly, include the elevator. No corporate executive is willing to use elevators that are used by Computer Experts.) As a Top Executive turns from the urinal he sees a Computer Expert. The Expert is at a neighboring urinal and remains there during much of the conversation. This is thought by many to be a masterful touch.

Exec: "Well, Siggy, are you excited about our announcement of Model 549 III?"

Expert: "Actually, I'm concerned."

Exec (still smiling): "Oh? concerned? Why?"

Expert: "I wonder if we have the security design right yet. You know Gilstrap and Fungio published a very good paper. It seems to me we designed . . ."

Exec (smile slipping): "Of course, I left the design to the team, I mean I have every confidence in Tom . . ."

Expert: "Well, I think there are some security problems in the addressing scheme. I think it is still possible to generate an address to protected data. Gilstrap shows that . . ."

Exec: "The machine is all right. Isn't it? We can sell it without going to the slammer? What will it cost to fix this? Can we meet delivery schedules? Good Lord. Half a billion bucks. And the damn thing doesn't work. I knew we should have stayed in the toaster business. Look, if it doesn't work, can you head up a task force?"

Expert: "Oh, it basically works. But it is not elegant. What Gilstrap and Fungio point out is . . ."

Exec: "Well, good night, Siggy. Don't stay too long."

Now, do we have here a scene in which an Expert sincerely interested in good computing is talking to a barbarian businessman who cares only about the bottom line? This is not likely because *everyone* is in it for the money. What we have seen, in fact, is an uncommonly elegant use of the Flake Play.

TRULY ADVANCED WORK

The Flake Play suggests that the Expert is an important thinker who really cares about good computing even at very private moments, but is too unstable to be relied upon for actual work. Staying at the urinal is very effective. It is truly advanced work.

An important aspect of Expert-Executive relations is never to be positive. An Expert must never say to an Exec anything like "Looks great, chief," or "Looks great, Fred."

Top Managements do not respect Experts who are polite and agreeable. They begin to think they are staff, or that they have something to hide. Be careful, though; it is equally true that Top Execs do not tolerate even the most trivial kind of dissent. The essence of Top, Exec interaction is informed but ineffective opposition. Make waves if you must, but don't make trouble.

Notice the Expert made no comment about market acceptance of the new computer. He spoke only of an obscure problem in machine organization. This is good work. A frank and critical comment about market impact would reveal that the Expert has no clue about what computers are used for, who would want them, and why they would want them.

Another important point is that a competent Expert would not do this scene unless Gilstrap and Fungio are real people who have written an article on computer design. It is not necessary, however, that:

1. Expert has read or understood the article.
2. Expert has any idea why the article is relevant to his company's new computer.

Master the advertising "game"...

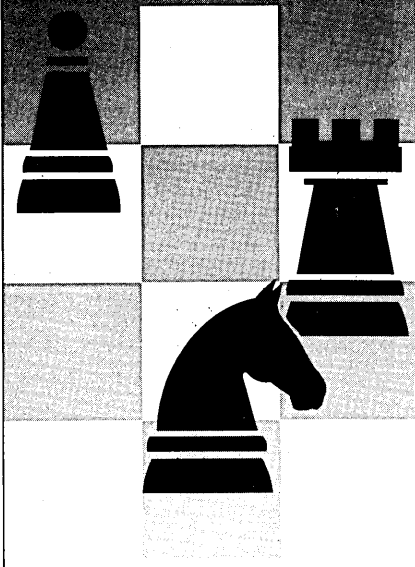

Supplement your full page advertising with an ad in the DATAMATION Marketplace. Or use it exclusively to reach 173,000 buyers/specifiers for only \$640 per 1/9 page.

It's the cost-effective way to contact qualified, BPA-audited information processing professionals with direct influence on hardware/software purchases.

For more details, call Kathy Monaghan or Shirley Stirling at (800) 223-0743. In New York, call (212) 605-9732/33.

(Marketplace location listed in Table of Contents)



DATAMATION

Serving the needs of
information processing professionals
... worldwide.

It is the lack of good character that makes computer knowledge acceptable.

THE COMPUTER EXPERT'S GLOSSARY

ADA: something you need only know the name of to be an Expert in Computing. Useful in sentences like, "We had better develop an ADA awareness."

Bug: an elusive creature living in a program that makes it incorrect. The activity of "debugging," or removing bugs from a program, ends when people get tired of doing it, not when the bugs are removed.

Cache: a very expensive part of the memory system of a computer that no one is supposed to know is there.

Design: what you regret not doing later on.

Documentation: instructions translated from Swedish by Japanese for English-speaking persons.

Economies of scale: the notion that bigger is better. In particular, that if you want a certain amount of computer power, it is much cheaper to buy one biggie than a bunch of smallies. Accepted as an article of faith by people who love big machines and all that complexity. Rejected as an article of faith by those who love small machines and all those limitations.

Hardware: the parts of a computer system that can be kicked.

Information center: a room staffed by professional computer people whose job it is to tell you why you cannot have the information you require.

Information processing: what you call data processing when people are so disgusted with it they won't let it be discussed in their presence.

Machine-independent program: a program that will not run on any machine.

Meeting: an assembly of computer experts coming together to decide what person or department not represented in the room

must solve a problem.

Minicomputer: a computer that can be afforded on the budget of a middle-level manager.

Office automation: the use of computers to improve efficiency in the office by removing anyone you would want to talk with over coffee.

On-line: the idea that a human being should always be accessible to a computer.

Pascal: a programming language named after a man who would turn over in his grave if he knew about it.

Performance: a statement of the speed at which a computer system works. Or rather, might work under certain circumstances. Or was rumored to be working over in Jersey about a month ago.

Priority: a statement of the importance of a user or a program. Often expressed as a relative priority, indicating that the user doesn't care when the work is completed so long as he is treated less badly than someone else.

Quality control: assuring that the quality of a product does not get out of hand and add to the cost of its manufacture or design.

Regression analysis: Mathematical techniques for trying to understand why things are getting worse.

Strategy: a long-range plan whose merit cannot be evaluated until sometime after those creating it have left the organization.

Systems programmer: a person in sandals who has been in the elevator with a senior vice president and is ultimately responsible for a phone call you are to receive from your boss.

3. Expert really needs to stay at the urinal for so long.

Properly executed, the Flake Play is one of the truly elegant career plays, computing's equivalent to scoring from first on a long single. It is not to be used without great finesse, however. Its major risk is that it seems to demonstrate knowledge about computers to an executive of a company that designs computers.

The desired result of the Flake Play is for the Top Executive to draw certain conclusions about the Computer Expert: that he is not steady, that his judgments are not balanced, that he may have a bladder

problem. It is the lack of good character that makes the computer knowledge acceptable and makes the Flake a valuable resource person—never fired and never thought of as a source of productive labor. This is the status that one searches for while in the full flower of a career in computing. ©

Charles Bassine is a top Computer Expert and an internationally recognized authority. He recently received the Baud Institute's Rita Hayworth Award for Un-completed Projects in Information Processing.

Introducing Quadnet.™

The family of four LAN systems that can grow with you.

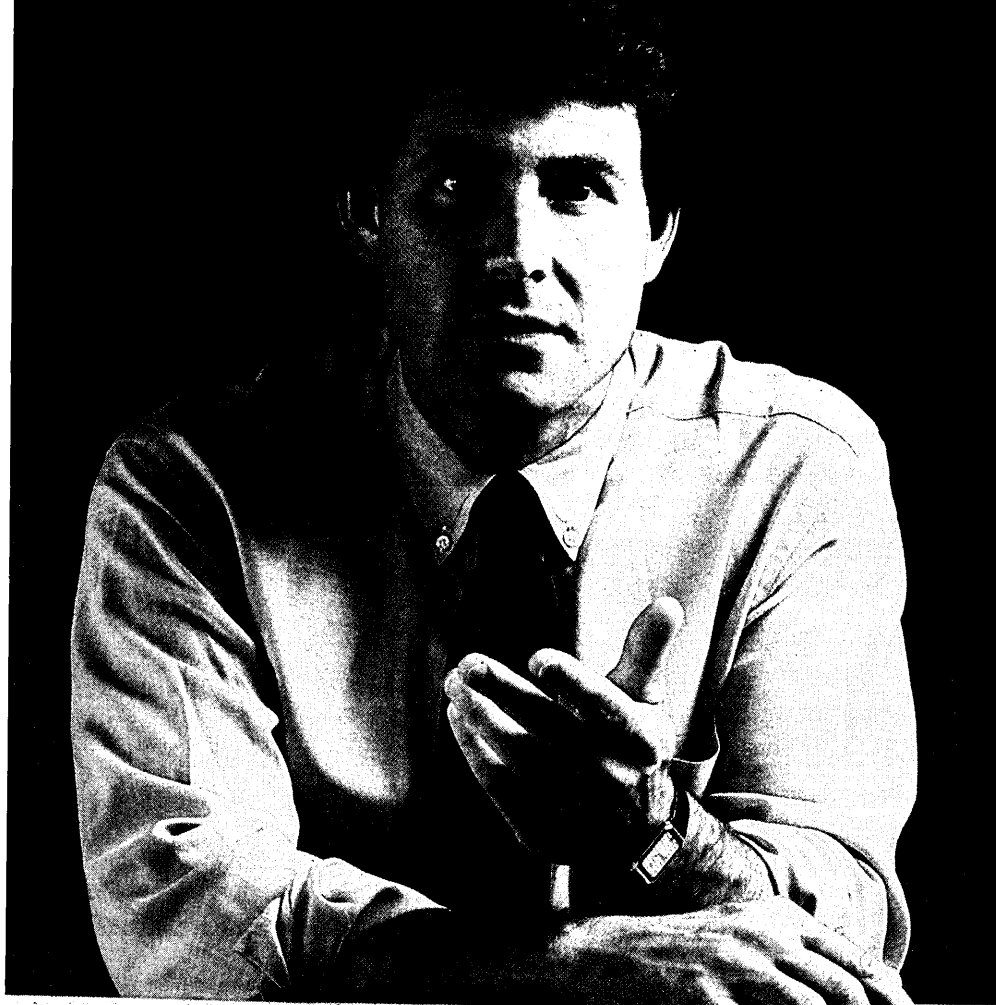

The family tie.

Each member of the Quadnet family of local area network systems has its own unique characteristics. Yet all four share one family trait. The same network software.

That means you can start with the LAN system that suits your needs today. And upgrade tomorrow without having to learn a whole new set of commands. It's the only LAN system for IBM PCs, XT's and compatibles that you won't outgrow.

Making the right match.

If you're not sure which Quadnet LAN system is right for you, your Quadram dealer and our SelectNet™ software can help. This easy-to-use software will ask you a variety of questions about your planned applications, number of users, operating system, and more. Then SelectNet will recommend the ideal Quadnet match.

Quadnet comes with its own powerful multi-user operating system. Perfectly compatible with PC-DOS, Quadnet software lets you keep your current software and add on exciting multi-user packages. And while some systems limit each user to about 360K worth of data (just enough for one floppy disk), Quadnet lets you segment your hard disk any way you like.

When you're ready to order, all the accessories are pre-packaged so you're sure to get everything you need to get your Quadnet system up and running. The master package includes hardware, software and documentation. A workstation kit contains hardware for one workstation. And the cabling kit comes complete in three workstation increments.

Quadram Quality.

Insist on the Quadram name. It's your assurance that you're getting a quality product from an established and reliable company. Ask your dealer about Quadram. We don't make personal computers, we make them better.



4355 International Blvd./Norcross, Ga. 30093
(404) 923-6666/TWX 810-766-4915 (QUADRAM NCRS)

INTERNATIONAL OFFICES
Interquadram Ltd. 442 Bath Road, Slough, England SL166B
Tel: 6286-63865 Tlx: 847155 Aurema G Interquadram GmbH
Fasanenweg 7, 6092 Keisterbach, West Germany Tel: 6107-3089
Tlx: 417770 Seva G Interquadram s.a.r.l. 41, Rue Ybry, 92522 Neuilly
Tel: 758-1240 Tlx: 630842 Iso Bur Checco Computing 6581 Kitimat
Road, Mississauga, Ontario, Canada L5N-2X5 Tel: 416-821-7600

IBM® PC, XT are registered trademarks of International Business Machines Corporation. Wordstar is a registered trademark of Micropro International Corporation.

© Copyright 1984 Quadram Corporation. All Rights Reserved.

CIRCLE 53 ON READER CARD





School-Financial Management
Scientific Subroutine Package
Sort/Merge
Strategic Profit Model
Structured Query Language/Edit
Subscription Fulfillment Trade Association
Supermarket System-Host Support
Surgery Reporting (Patient Care System)

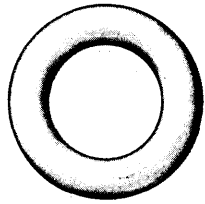

Office Management System
OFFICE/38 Text Management
Online Membership System
Operator Communication Control Facility
Order Entry and Invoicing

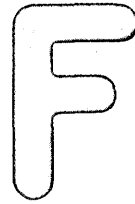

Fastdraft System
File Transfer Program (FTP)
Fixed Asset Accounting and Control
Forecasting and Time Series Analysis
FORTRAN

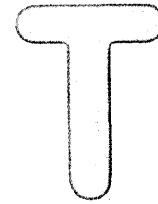

Tape Library Control System
Telephone Toll Data Collection-Central
Teleprocessing Network Simulator
The Information Facility (TIF)
Thesaurus Retrieval (STAIRS/VS)
Time Sharing Option Extensions (TSO/E)

If none of these meets your needs

Whether your company is an industrial giant or a cottage industry, if you have a need for software, chances are IBM has a software solution.

After all, we've been writing computer software for more than 30 years.

Software for almost every industry and almost every kind of application. From manufacturers and banks to lawyers and doctors. For our largest computers and our smallest.

Some IBM software helps you to take

care of basic business needs, such as accounts receivable, inventory control or sales analysis.

Other more specialized systems focus on a particular industry. Do you manage a motel? Run a construction company? Or schedule a fleet of trucks? Ask us.

Most data professionals know IBM for our sophisticated system-level software. And high-productivity packages such as DB2, a full-function relational data base. And Information Center products that

W

Wideband Communication Program
Workstation Search Facility (WSF/38)

A

Advanced Communication Facility/VTAM (ACF/VTAM)
Adventures in Math
Apparel System-Order Allocation
Application Development Facility (ADF)
A Programming Language-2 (APL2)
Audio Distribution System
Auto Dealer Accounting
Automated Information Management Development

R

Railcar Location and Reporting System
Realtime Programming System
Remote Job Entry Facility
Remote Spooling Communication Subsystem (RSCS/SNA)
Resource Access Control Facility
Restaurant Management-Financial Management
Retrieval/36

E

Education Information System-Grading
Electronic Spread Sheet
Energy Management System
Engineering/Scientific Support System (E/S³)
Executive Data Link to IBM Personal Computer

exactly, we have 2,876* more.

help computer users help themselves.

But what's more to the point is that we know the real meaning of software quality. And how to make our programs easy to learn and easy to use.

So when you need a software solution, look first at software available from IBM. It may save you the trouble of looking in 2,876 other places.

Start with the IBM Software Directory. For your free copy, please call 1 800 IBM-2468, Ext. 82. Or return

the coupon. Or call your IBM marketing representative.



IBM	1-15
DRM, Dept 3I/82	
400 Parson's Pond Drive, Franklin Lakes, NJ 07417	
Please send me a free copy of the IBM Software Directory.	
Name _____	
Title _____	Phone _____
Company _____	
Address _____	
City _____	State _____ Zip _____

*Programs available as of 9/12/84.

Contrary to popular opinion, there are a few things you can do to improve programmer productivity.

BLOOD FROM TURNIPS?

by Lawrence Bernstein and Christine M. Yuhas

Productivity is a loaded word in the computer industry and, like unemployment and inflation, it all depends on how the numbers are toted up. Specifications are difficult enough to arrive at when we are dealing with customers who aren't quite sure what they need, but they'll know it when they see it.

After specifications are made, it's even trickier to tell whether we were efficient at delivering the product. A combination of sound engineering principles and common sense yields three critical elements in producing something useful: make every line count, prototype the product, and test and refuse. A look at the current state of each of these elements points to the next major breakthrough in productivity in the software industry—reusable code. Reusable code has been around for years, but the breakthrough lies in the fact that it will soon be used organizationwide rather than just departmentwide.

Programming productivity is usually measured by some variation on the theme of the ratio of delivered source lines of code to the total effort expended in terms of people's time. Glorious mathematical acrobatics take place here: some count reused code and others don't; some count comments and others won't. The search for the optimal cutoff point in determining how much of a module must change before the whole module is counted is as intense as the search for the Holy Grail. Once the cutoff point is determined, some scheme is proposed for improving the ratio, ignoring the point that human beings have a finite capacity for producing code.

Measuring the number of lines of source code a programmer can write in a given period of time is similar to measuring the ability of a person to carry a 50-pound sack of grain. Not everyone can carry that sack of grain, but since we can measure the physical condition of people, we can find those who can carry it easily. We might even find some who might be able to carry two 50-pound sacks of grain and therefore

could be twice as productive. To get an order of magnitude increase in grain-carrying productivity, however, we need to use carts. One person could carry 10 sacks using a cart. Thus, productivity in the grain-moving industry goes up by capital investment. Of course, the workers should be able to carry the 50-pound sacks, just in case the carts aren't usable on a given day. Likewise, an individual programmer must meet a set standard, but his daily quota of lines is not a measure of the software industry's productivity.

There are three broad types of software. For operating system software, where the details of the hardware are critical to making the software work, a reasonable expectation is 50 lines per staff-month. For on-line or real-time application software, where performance is critical, 200 lines per staff-month is average. For off-line batch or utility software, a respectable programming staff can produce 500 lines per month. These numbers are averages; some practicing programmers can produce 10 times as much code as their peers. No matter what we do in the way of improving the tools to develop software, we are not going to dramatically increase the numbers of source lines produced because they measure what people can comprehend, not what machines can produce.

The situation is analogous to the public speaker's familiar mnemonic trick: when your memory is limited, make each mental note represent a much larger mass of information. And just as some speakers inspire and others anesthetize, the quality of programs varies widely. A programmer who can produce the coded equivalent of a filibuster is not necessarily a gem, and productivity schemes aimed at increasing the number of source code lines may give subtle license to this tendency. Productivity measures for the software industry should therefore be sensitive not only to the ability of the programmers to produce code, but also to the tools used to produce the software.

In his article, "Measuring the Productivity of Computer Systems Development Activities with Function Points"

(*IEEE Transactions on Software Engineering*, vol. SE-9, no. 6, 1983), Charles A. Behrens published an interesting analysis of several projects in which he used a function point method developed by IBM's A.J. Albrecht to track the cost-benefit impact of his company's productivity improvement plan. Albrecht had already shown that projects with higher than expected productivity had these characteristics, among others: disciplined application development process, use of PL/1 and DMS/VS rather than COBOL, and use of on-line development.

SMALL PROJECTS BETTER

Behrens applied Albrecht's formulas and showed that small projects were more productive than large ones. (Although he offered no speculation as to why this should be, we will do so.) He also stated that projects developed on-line cost about half as much as those developed in a batch mode. Behrens concluded that "project size, development environment, and language are determinants of system development productivity."

Before lamenting the future of all large projects, it would be wise to realize that the current formulas for productivity are the same for any size project, which is what confounds the results. Centuries ago, in *The Art of War*, the Chinese philosopher-general Sun Tzu said, "The control of a large force is the same in principle as the control of a few men. It is merely a question of dividing up their numbers. Fighting with a large army under any command is nowise different from fighting with a small one. It is merely a question of instituting signs and signals."

Large projects can be successfully approached in the same fashion, but notice must be taken of the number of people whose job it is to keep the signs and signals flowing freely. Adding these people—who are vital to a large project—into a formula suited to a small project, where their functions are performed by the programmers, makes productivity appear to drop severely. The yardstick is simply too short.

Having the computer produce the

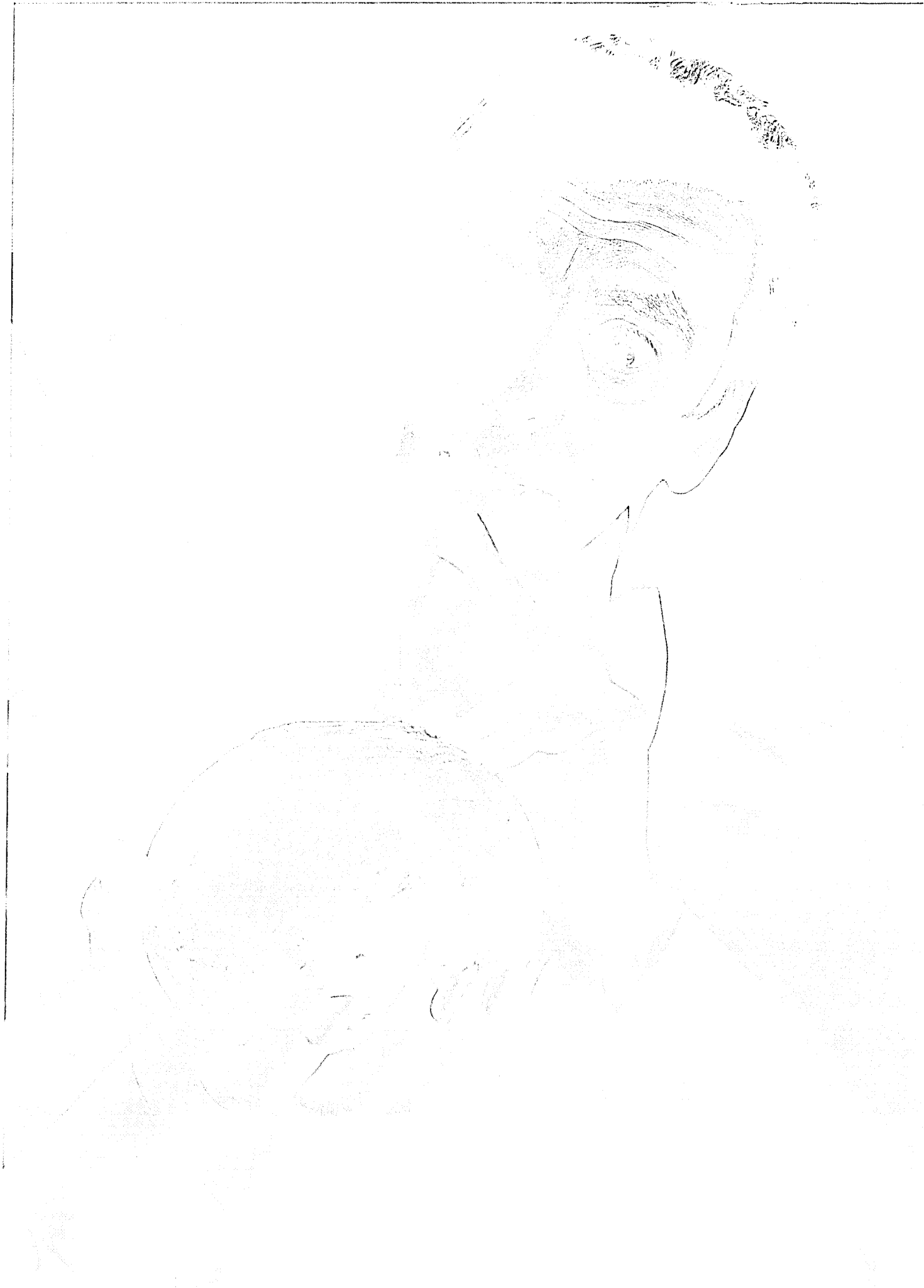

Having the computer produce the most work with the least human direction is desirable.

most work with the least human direction is desirable, but that makes source code lines and the resulting machine instructions both necessary. It takes skill and brains to write a program that uses the least amount of machine space, process time, and memory space. Where machine performance is an important parameter, the master coder may appear unproductive by some measures. High-level languages reduce the number of source code lines necessary, but can increase the number of actual machine instructions. This makes each source code line very productive. There is no uniform equivalency, however, of machine instruction lines to source code lines across machines and applications. Albrecht's function point method is promising to some degree in that it discourages inefficient programming, but there ultimately appears to be no panacea. Once having provided the language, debugging, and development tools in a supportive environment like the Unix/Programmers' Workbench, the best measures of productivity are probably relative ones. Our own studies at Bell Research, Piscataway, N.J., show that structured programming and code inspections for novice programmers as well as the use of higher-level languages are fundamental to quality. Productivity measures are valid only against similar applications on similar machines using similar languages.

Prototyping is the next useful notion we'll consider. It would appear evident that the better understood the requirements are, the more efficiently the final product may be achieved. But the computer industry is replete with legends of systems that do something other than what the customer wanted. This is not due to capricious or malevolent customers, nor to designers who are deaf and blind to requirements. It reflects the difficulty of working in a relatively new medium where variations undreamed of during requirements writing appear during the detailed work of development, and difficulties of abortive costs arise from an easily inserted afterthought in the specifications.

C.E. Walston and C.P. Felix performed a study, titled "A Method of Programming Measurement and Estimation," (*IBM Systems Journal*, vol. 16, no. 1, 1977), in which 29 variables were shown to have significant correlation with productivity as measured by the ratio of delivered source lines of code to the total effort in staff-months. Allowing for the flawed nature of this measure, it is still interesting to note that the most significant of the 29 variables concerned human interactions that allowed some degree of trial and error and a feeling for the spirit rather than the letter of the

specification. These variables were customer interface complexity (the easier the better), user participation in defining requirements (the more the better), overall personnel experience and qualifications, and the percentage of development programmers who also did functional specifications. Closely following these were experience with the programming language and experience with systems of similar size and complexity.

CUSTOMER IS ALWAYS RIGHT

It is intuitively obvious that as management energy is sapped by complaint meetings, escalated problems, and defensive reports, attention cannot be given to planning and controlling the day-to-day software development. Prototypes are something tangible to discuss with the customer and help dispel the panic of "buying a pig in a poke." The customer is always right; the professional's job is to broaden his perspective.

Barry W. Boehm, Terence E. Gray, and Thomas Seewaldt demonstrate in "Prototyping Versus Specifying: A Multi-project Experiment" (*IEEE Transactions on Software Engineering*, vol. SE-10, no. 3, 1984) that prototyping yielded products with performances roughly equivalent to those developed following specifications only, but with about 40% less code and 45% less effort. Their data also show that the standard productivity measure did not vary between prototyping and specifying groups, which further supports our experience. There seems to be a general resistance to prototyping because it appears that the system is being built twice, quite needlessly. Boehm et al note, "The prototyping groups mostly indicated that specifying would have increased the performance of their product and would have resulted in a faster development process. It is interesting that the data... did not confirm this expectation."

The comment of C. Elmendorf, a major figure in Bell System engineering, regarding hardware systems is equally applicable here. "Before committing the design of a complex system, be sure solutions are available for the basic technical problems that limit the system." For large systems, this means starting with a broad objective and only 10% of the ultimate staff, and building not one but several prototypes. Like the five blind men describing the elephant, each prototype examines a different aspect of the problem. There might be one for the human interface, one or more for complex algorithms like tracking a missile or an economic predictor, one for performance, and so on. Now both customer and

professional have something tangible to evaluate. The experience lends a note of realism to the requirements.

Prototyping alone is insufficient and should not eliminate formal requirements, but rather develop and validate them. Typically, requirements are a synthesis of what we think we want the computer to do in a given situation. Often there is no analysis of those requirements to ensure their accuracy. In fact, imagining what form that analysis might take other than prototyping is difficult. Prototyping is a way to communicate with the customer about requirements and it allows software professionals to gain understanding about the problems they're trying to solve.

One glaring indictment of our industry is the frequency with which testing takes as much as half the total development time. We have known about independent test groups for years and persist in hamstringing them. Test groups can do effective intermodule testing only if they have the right of refusal, which means that software in sad shape gets turned back to the developer. It takes the test group three times longer to find problems than it takes the original developer. It takes 10 times as long to find problems in the field as in the test group, and there is a 30 to 1 increase in cost.

TESTING TEAM SUPPORT

As long ago as 1972, in the Safeguard system (the antimissile missile system), Bell designated specific individuals in the design group whose primary responsibility was to test team support. The test team would indicate failure in the sanity tests and the designers would provide fixes. We recently introduced very formal regression and stress-testing techniques coupled with the right of refusal by the test groups. This reduced the test intervals to 10% to 15% of the total development time. Furthermore, using incremental testing—bringing up pieces of the system a bit at a time—has allowed the test period to overlap the software development period. The prototype pays for itself again in the test arena because the same test can be run in both the prototype and the product. With luck, the results will be the same. If not, valid data for analysis do exist.

The testers and system integrators need to understand that they are responsible for the quality of the system and they have the authority to ensure its quality. This gets sticky when they refuse the code with the schedule looming overhead. At this point, it's time for the resourceful manager to enter the picture.

One must choose among the options

To get the world's most advanced 50 CPS daisywheel printer, you'll have to pay less.

The TeleVideo® 750 delivers 50 CPS performance using an incredible 40% fewer parts than any comparable printer. So it's no mere coincidence that the 750 sells for up to 40% less. With quality so good, you can produce camera ready copy directly.

Cost of ownership gets even better with time. Fewer parts equal more reliability: an average of 65,000 pages between failures. And with the works in a drawer, repairs—when necessary—are quick and easy.

Fewer parts also equal a low profile, small footprint, and light weight. The TeleVideo 750 printer is plug compatible with almost every computer system. And TeleVideo provides a complete selection of supplies and paper handling accessories.

You won't find a printer better suited than the TeleVideo 750 to an office environment. So if you're responsible for printer purchase decisions, the TeleVideo 750 should make your job significantly easier. Now there is a daisywheel printer that gives you high performance, low cost and excellent quality.

For information about TeleVideo Printer dealers in your area or a free demonstration, call 800-521-4897. In California 800-821-3774.

Regional Sales Offices: Schaumburg, IL (312) 397-5400, Norcross, GA (404) 447-1231, Waltham, MA (617) 890-3282, Syosset, NY (516) 496-4777, Irving, TX (214) 258-6776, Irvine, CA (714) 476-0244, San Jose, CA (408) 971-0255.

CIRCLE 54 ON READER CARD



Printers
TeleVideo Systems, Inc.

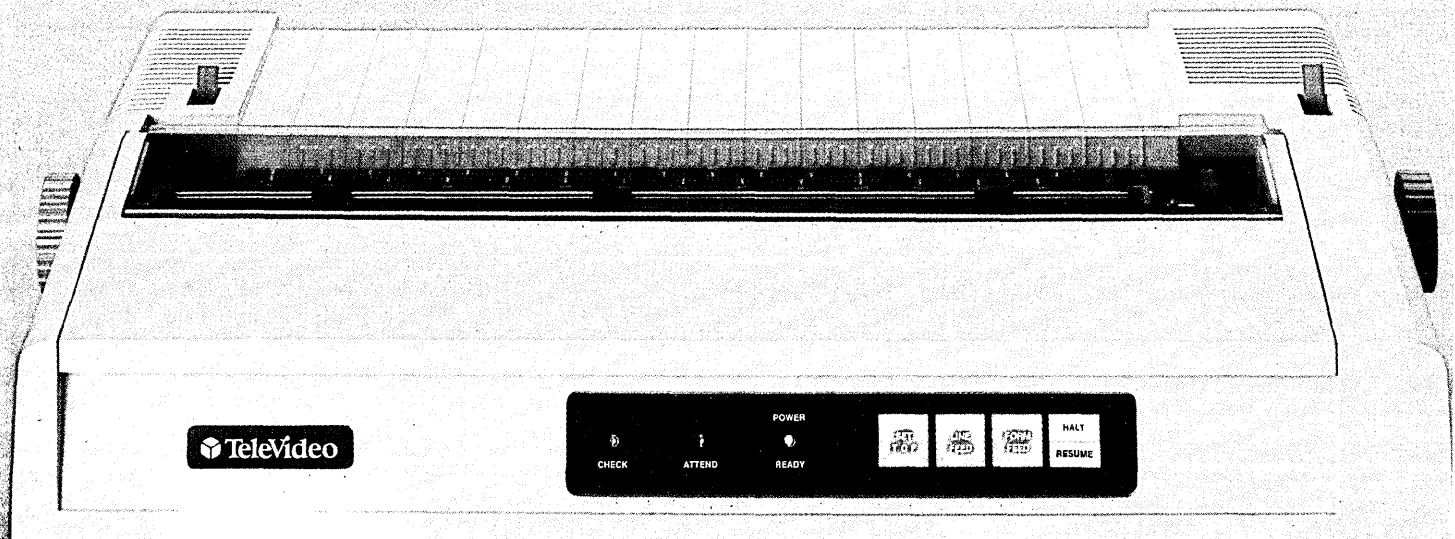

Heart attack or stroke could make the best years of your life the worst.



You have loved ones, a future, good health. It could all be lost with a heart attack or stroke. And that happens. Last year, nearly one million Americans died of heart disease and stroke. And 200,000 of them died before retirement age.

The American Heart Association is fighting to reduce early death and disability from heart disease and stroke with research, professional and public education, and community service programs.

But more needs to be done.

You can help us support research and education by sending your dollars today to your local Heart Association, listed in your telephone directory.

Put your money where your Heart is.

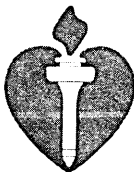

**American
Heart
Association**

WE'RE FIGHTING FOR YOUR LIFE

of adding resources, permitting overtime, reducing the scope of the features, and renegotiating deliverable dates with the customer. It is important to keep the testers and system integrators in touch with the real world by having them estimate delivery dates throughout the development process. This way, if you get into a critical scheduling problem, there's still time for changing the sequence of activities or shifting resources. A simple scheduling chart has been effective at Bell Research. We include scheduled dates that management owns, current estimates of those dates that the developers and testers own, and actual dates. Critical-path or PERT-type scheduling is less useful because it causes people to report on minutia and lose the larger picture.

The Roman legions carried their shields, which bore the letter symbol of Rome, SPQR, to the corners of the known world, imposing order, communication, and at least temporary tranquillity. The software industry could use this same symbol, with the modern interpretation being schedule, productivity, quality, and resources. A banner in every conference room where battles rage might remind people of what is really important. While schedules and resources set practical limits, our professional integrity demands a high level of productivity and quality. We hope the preceding discussion has demonstrated that attempts to squeeze more code from the programmer are futile and that a major step must be taken in our technology.

We believe that step must be a shift in focus from project orientation to function orientation. By the end of the decade, software logic design rules will make firmware possible, produced by specialists in screen handling, pointer manipulation, search algorithms, and the like. Isolating software companies from undesired interactions is not yet practical for everyone, but Unix, a successful system of reusable software components, shows one way.

We are on the brink of no longer having to reinvent, debug, and test the same logic over and over. The forms that reusable code may take vary in complexity from the modest adaptation of an existing prototype, to function blocks used as a base and modified for a specific application, to the ultimate sophistication of a library of discrete functions that can be dropped whole into a complex design. We have reached the point where software professionals can deal with the overriding design, understanding function, but free of the laborious, repetitive detail. We have the chance to be truly productive. ©

Lawrence Bernstein is assistant vice president, responsible for software development at Bell Communications Research, Piscataway, N.J.

Christine M. Yuhas is a former Bell Laboratories technical supervisor.

The BTI 8000 outperforms the HP 3000 3 to 1

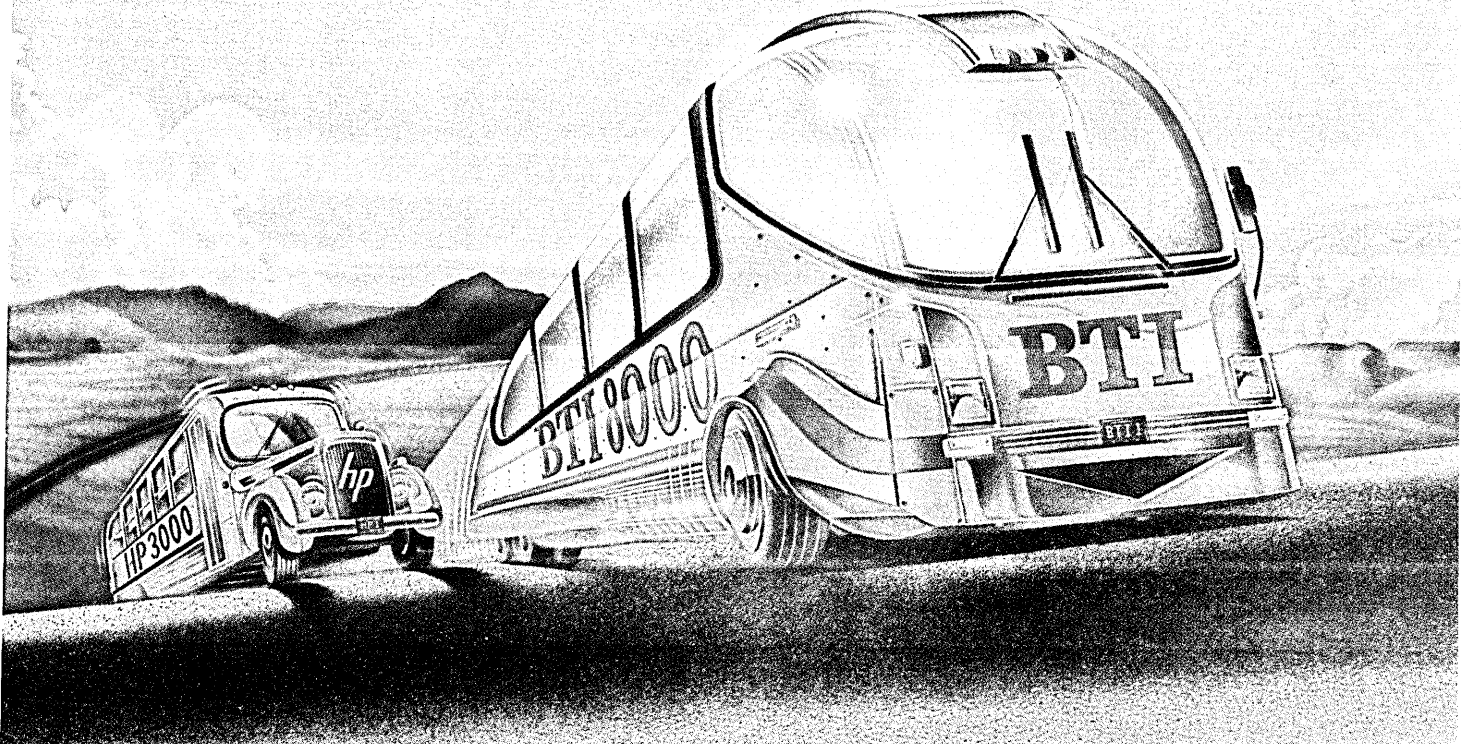

That's right! Benchmark tests prove that the latest version of the BTI 8000 can support more than three times as many online interactive COBOL users as HP's top-of-the-line Model 3000/68.

We programmed a "driver" computer system to simulate from 10 to 240 individual users performing representative data processing tasks. This provided us with a controlled and repeatable test of each benchmarked system, operating in a real world multi-user environment. Overall, we timed more than one million responses.

Under the conditions specified for the benchmark tests and simulating 200 busy interactive users (6 data base accesses per minute per user) the BTI 8000's average response time was *one second*.

The benchmark test design, procedures, programs, and results are described in a comprehensive report. It's yours for the asking.

The BTI 8000 system is a modular supermini multiprocessor system that can be sized to fit your needs. The system can use up to eight 32-bit CPUs and 24 megabytes of main memory, but you can start with a single CPU system and build up to larger configurations when your needs grow.

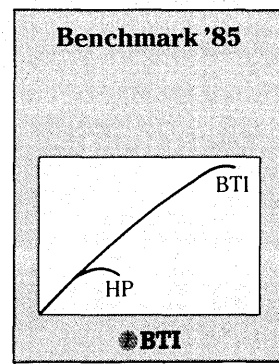

As for reliability and service, they're an established BTI tradition. Over 3,000 BTI systems are currently supported by BTI in the U.S., Canada, and Europe.

Contact us for more information about the BTI 8000 32-bit supermini and your copy of "Benchmark '85."

BTI8000 32-bit Multiprocessor System

BTI Computer Systems, 870 West Maude Ave., Sunnyvale, California 94086 (408) 733-1122
In Europe: BTI Computer Systems, (UK) LTD., Birmingham B13 8NG, England (021) 449-8000

BTI & BTI are registered trademarks of BTI Computer Systems.

 is a registered trademark of Hewlett-Packard Co.

CIRCLE 55 ON READER CARD

Getting a group of five or six personal computers networked isn't that big a deal. But it gets complicated when the group gets bigger. And in case you hadn't noticed, the groups are getting bigger. Fast.

Experience may have already taught you that low-end PC networks run out of steam in a hurry once you have more than five or six stations connected. If your plans include several PCs or several hundred, high performance isn't a luxury. It's critical.

WHY YOU SHOULD BUY YOUR PC NETWORK FROM A COMPANY THAT UNDERSTANDS HIGH PERFORMANCE. If you want the PCs in your company working in concert with the rest of the information processing equipment in your company, it makes sense to talk to people who have a track record networking more than just PCs.

Like us. The expertise we've gained from developing the widest range of interfaces and protocols in the data communications industry has allowed us to build PC networking products with the muscle necessary for quick responses even in heavy traffic.

The Net/One Personal Connection™ is a high performance, high speed network system that can take your PCs as far, and as fast as you want in the corporate network. With the Personal Connection's SNA server software, a PC can emulate a 3278 and get a direct SNA route to the top. With Diskshare™ and Printshare™, PCs can share information and expensive peripheral resources, and Mailshare™ gives you complete electronic mail service.

It's a far-sighted solution, even if all you want to do now is hook up a few PCs economically. And it's the *only* solution when PCs need to be mixed cost effectively into a high-speed corporate network with devices from different manufacturers.

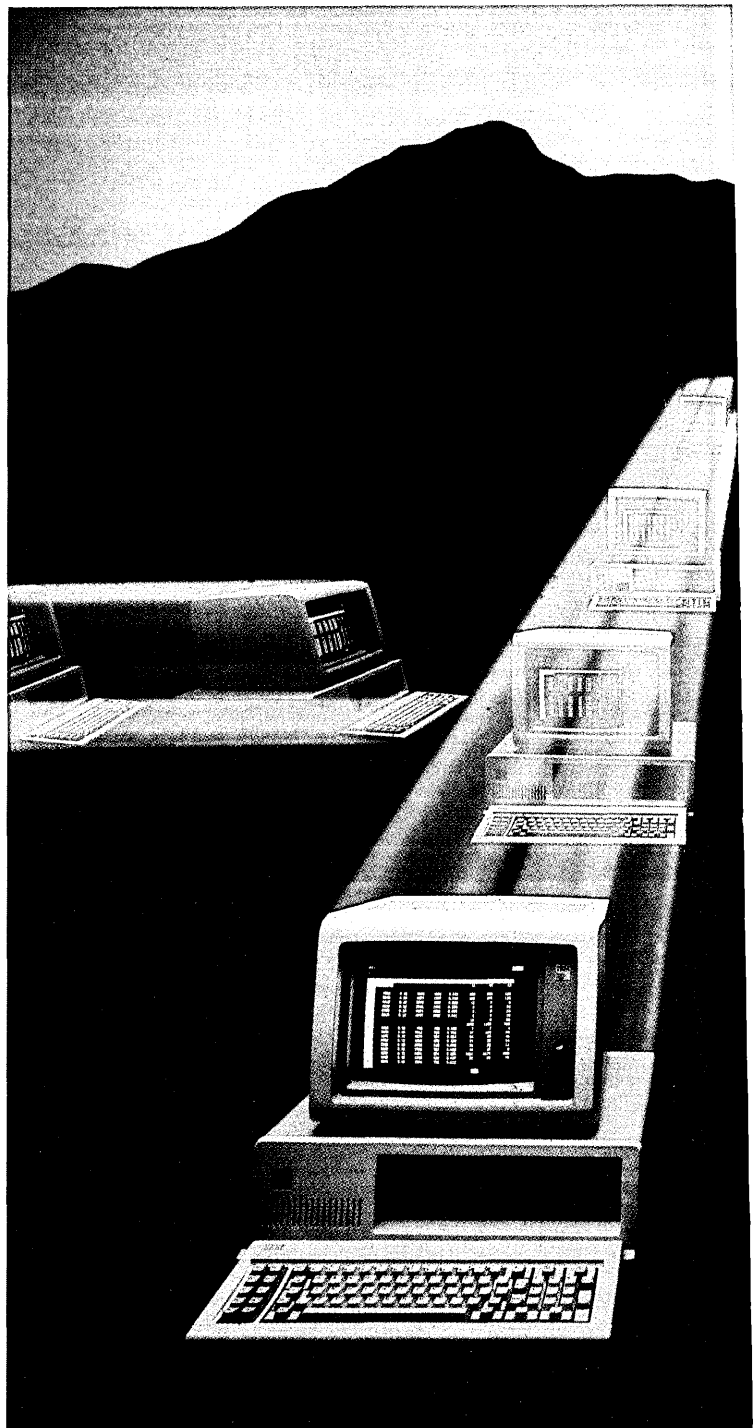

In heavy ne high performan

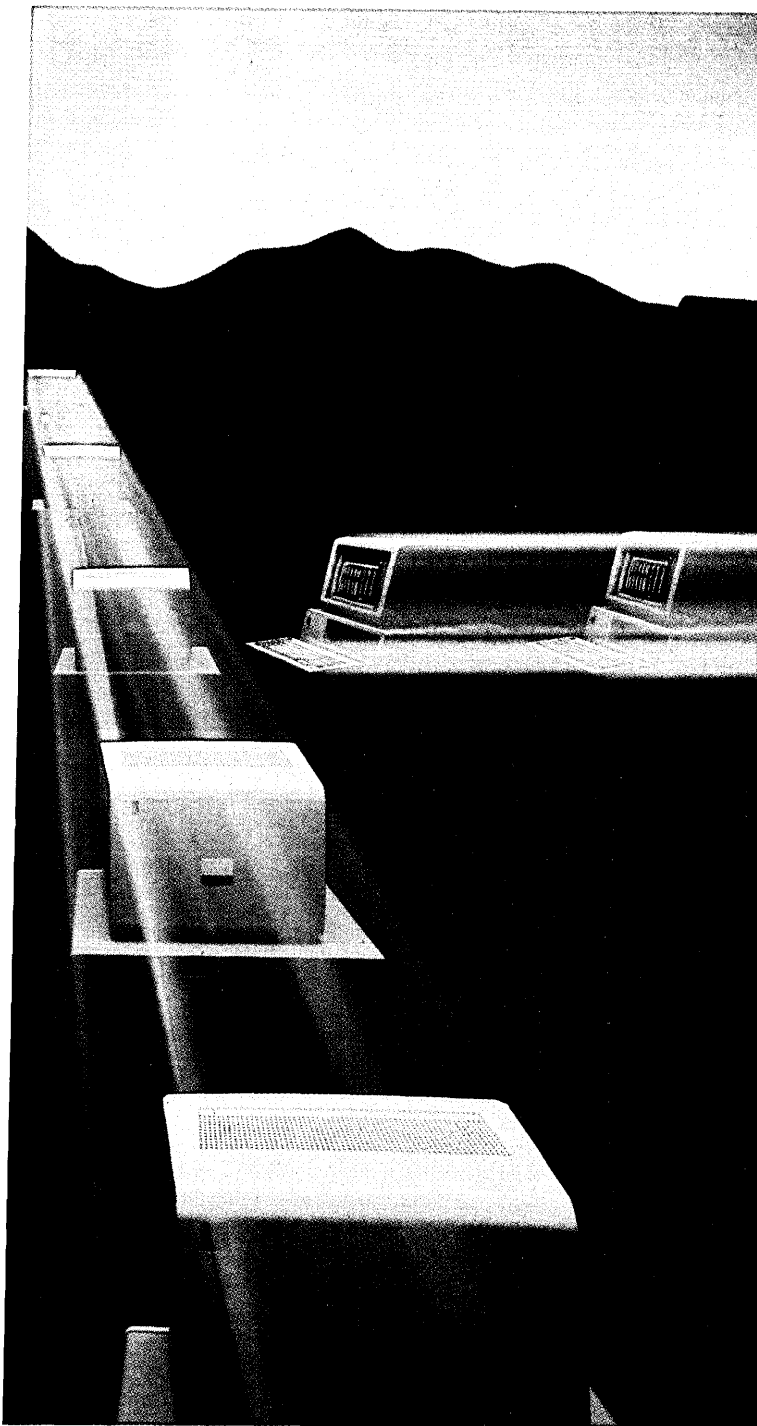

HERE'S A CASE WHERE
A BIGGER ENGINE IS ACTUALLY
MORE ECONOMICAL.

The Net/One Personal Connection system packs the microprocessing power to offload all networking functions, so it doesn't eat up the host CPU's resources. That frees up a work station that other systems require simply to do their network's work.

WITH TWO BOARDS TO CHOOSE FROM,
THE COST GOES WAY DOWN.

We now have two Personal Connection interface boards, with two levels of intelligence and two prices. At stations on the net where this additional offloading intelligence isn't required, plug our newest, most economical Personal Connection board into the PC, and bring your cost-per-connection down to where it would be tough to justify buying anything less. The full network functionality is all there with either of the two interface boards; they can be used interchangeably on the network and it makes no difference to network users. But now, with the option to pay for only as much intelligence as you need at each station, we've made it possible to have a real network at PC network prices.

IT'S POSSIBLE BECAUSE THESE ARE
NET/ONE® PRODUCTS.

They are the newest extension of Net/One, the general purpose local area network system that can turn *all* the equipment you have now, no matter who makes it, into a fully functional, high performance network. Broadband, baseband, fiber optics. Main-frame to mini to micro. Local to remote.

Give us a call. Ungermann-Bass, Inc.,
2560 Mission College Boulevard, Santa Clara,
California 95050. Telephone (408)496-0111.

Net/One from Ungermann-Bass 

Network traffic,
isn't a luxury.

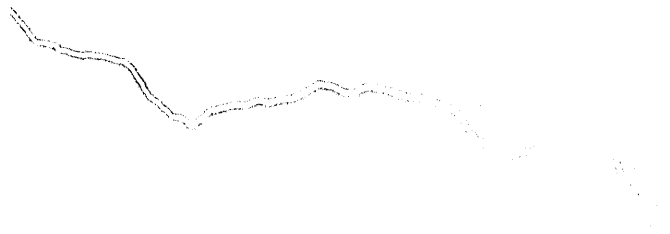

Small, faint handwritten text or markings located in the lower right quadrant of the page.

Computers can't run without it, and dp managers shouldn't run computer centers without knowing the basics.

THE IMPORTANCE OF POWER

by Dan M. Bowers

Electrical power in a computing system is usually taken for granted, like the cabinetry, the instruction manual, and the dog wagging its tail when we get home. Compared with MIPS, CMOS, POKES, mice, and voice synthesis, the provision of electrical power seems mundane and routine; one visualizes a technology unchanged since Edison and Steinmetz.

But the subsystem that provides electrical power is more than just an umbilical to the wall plug; it is one of the four basic elements without which the computer cannot operate—try playing Ms. Pac-Man on your expensive pc in the absence of the processor, memory, I/O, or power. And power technology has advanced through the years along with computer technology, although it is still based on the work of Thomas A. Edison and Charles P. Steinmetz, just as ours still depends on the insights of Claude E. Shannon and John Von Neumann.

In this age of digital circuitry that practically never fails, and peripherals that are orders of magnitude more reliable than only a decade ago, the major adverse influences upon our computer systems come from outside the system: the operators, the physical environment, the communications lines, and perhaps the greatest of all these, the power source. Moreover, the very advances in semiconductor technology that have made the modern computer age possible have increased our susceptibility to the age-old vagaries in the power source. A 1950s-era vacuum tube circuit might require a 40-volt logic signal, and thus would

not even notice the five-volt spike that sends today's micros off the wall. The importance of a particular mote depends upon the size of the eye of the beholder.

Thus, it is important to remember the fact that power is supplied to a computer by a power subsystem, a vital one of many subsystems that make up the total computer system. We shall analyze the constituents of this subsystem and study its potential problems in terms of their sources and effects. We will also consider the practical remedies that exist in system design, paying particular attention to the ultimate protection, an uninterruptible power system (UPS).

Fig. 1 illustrates the total scope of the power subsystem. Power problems can and do originate in any portion of this network. Since most of its components are external to the computer system they are also beyond the control of the computer system designer. What the designer must concern himself with are those problems involving system constituents that he can control. The user could, of course, take control of the entire power subsystem by installing his own generator and having his own oil well, waterfall, or windmill, but few find it economical or convenient to do so.

Primary energy source. Electrical energy does not occur in nature in any convenient form, and therefore an available primary source must be used. Except for nuclear fission and tidal flow, all primary sources use solar energy, either direct (including wind) or stored (coal, oil, natural gas, hydroelectric). Arranging for the primary source is the power company's problem, but if it runs out, the user inherits the

Frequency variations in AC power are a rarity: how often does your electric clock show the wrong time?

FIG. 1
THE POWER SUBSYSTEM

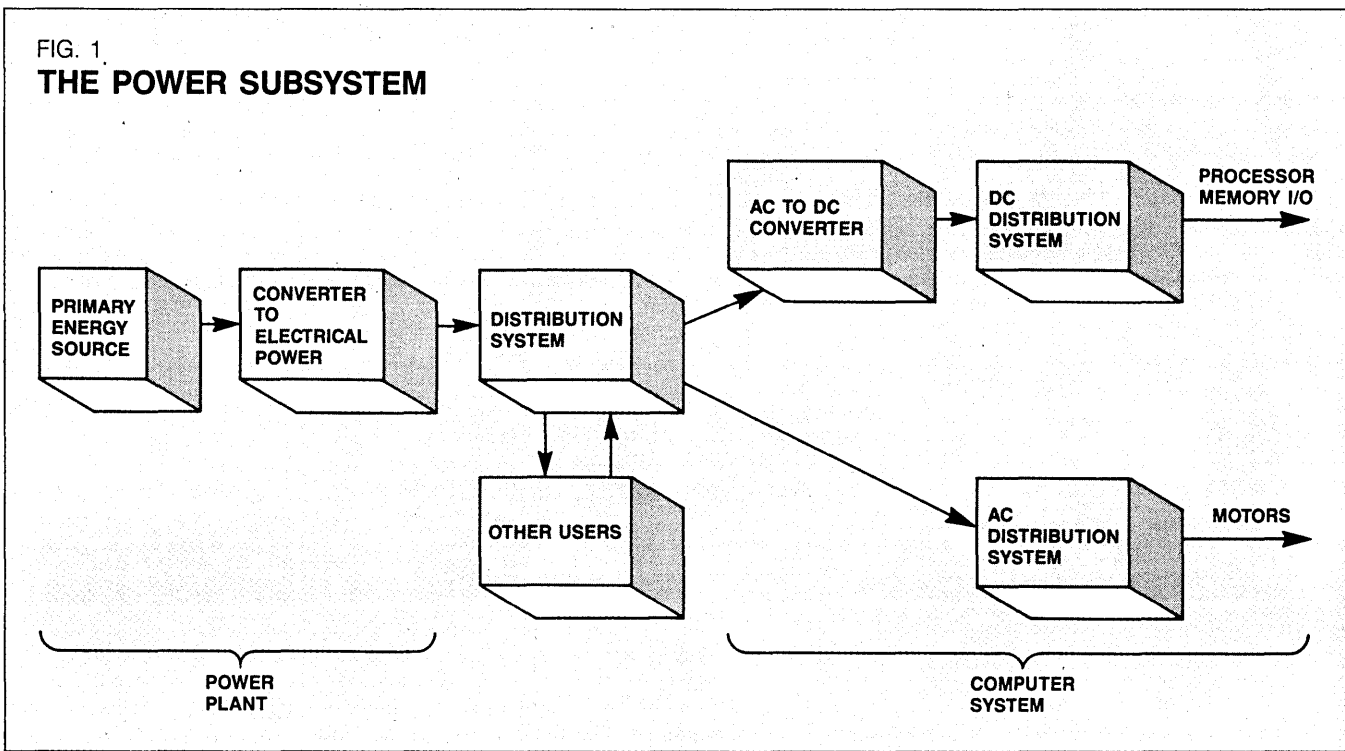

problem. And if the sun goes out, we're all in big trouble.

Converter to electrical power. Usually called a generator, this component is always a rotating machine that Edison and Steinmetz would still find quite familiar, except in the case of solar cells, where the conversion is done directly. In most power generation, there is a triple conversion of the energy: from the prime source to heat (steam), which is then used to force rotary mechanical motion of the generator, and then to electrical power.

Distribution system. Alternating current (which would be new to Edison but not to Steinmetz) is distributed over a system of wires to all users of the power company's product, and even to other power companies and their users. Our computers can thus be viewed as being connected by wires to virtually everyone else on the continent, and thus can be affected by them. As a practical matter, we are at the mercy of only our nearest neighbors, but even they can number in the tens of thousands.

CONTROL OVER OUR DESTINY

AC to DC converter (commonly called our system power supply). At last we can begin to control our own destiny, and here is our first line of defense against the problems sent to us by the world without. The designer must ensure the power supply chosen solves problems rather than creates new ones.

DC distribution system. Power distribution in a digital system is a science of its own. All of the benefits of a proper power supply, line regulators and filters, and even a UPS, can be negated by an inadequately designed and implemented distribution system.

AC distribution system. AC, rather than DC, is usually used to run motors and some relays and lamps in a computer system. These components are inherently less susceptible to the usual vagaries of the power line, but nonetheless require design attention. They can also be local sources of the same kinds of disruptions that come in over the line.

In the power subsystem there are many generators of noise and disruption, and constantly varying loads, most of which are separated from the power plant by the electrical bulk of the distribution system. Therefore, no matter how pure the output of the generating station, the power delivered to the user can have all kinds of anomalies (see Fig. 2). These influences appear on the power line in the following ways, with the effects described, and require the remedies indicated.

Noise, spikes, and transients. These are high-frequency phenomena, and thus are of relatively local origin since high frequencies, like delicate wine, do not travel well over long distances. Among the sources are sparking brushes on DC motors and power tools, the chopping effect of the

switching power supply in the next room, X-ray equipment, capacitor charge-ups, poor grounding of electronic equipment, relay and controller closures, and atmospherics. At the very least, these enemies can couple unwanted signals into the computer system and cause errors, interruptions to processing, and loss of data. At the worst, they can destroy computer circuitry since they can have amplitudes in the kilovolt range. Radio frequency interference (RFI) filters and isolation transformers are the principal weapons against these enemies, along with careful design of the system layout and wiring.

Surges and sags. The voltage on the power line can vary up or down by 25% or so, due to other large loads being removed from or being put on the system, power company problems with generating equipment, or direct lightning hits. Their duration can be from milliseconds to minutes; a long-term sag is known as a brownout, and can last for hours. Both overvoltages and undervoltages can cause processing errors and loss of data, and damage to motors and power amplifiers can also occur. A voltage autoregulator and a power supply with good regulation specifications are the best defenses.

Frequency variation. Serious damage could result if there were even a 10% error in the frequency of the AC power, but as a practical matter it never happens in this country—how often does your electric

Seeing is believing.

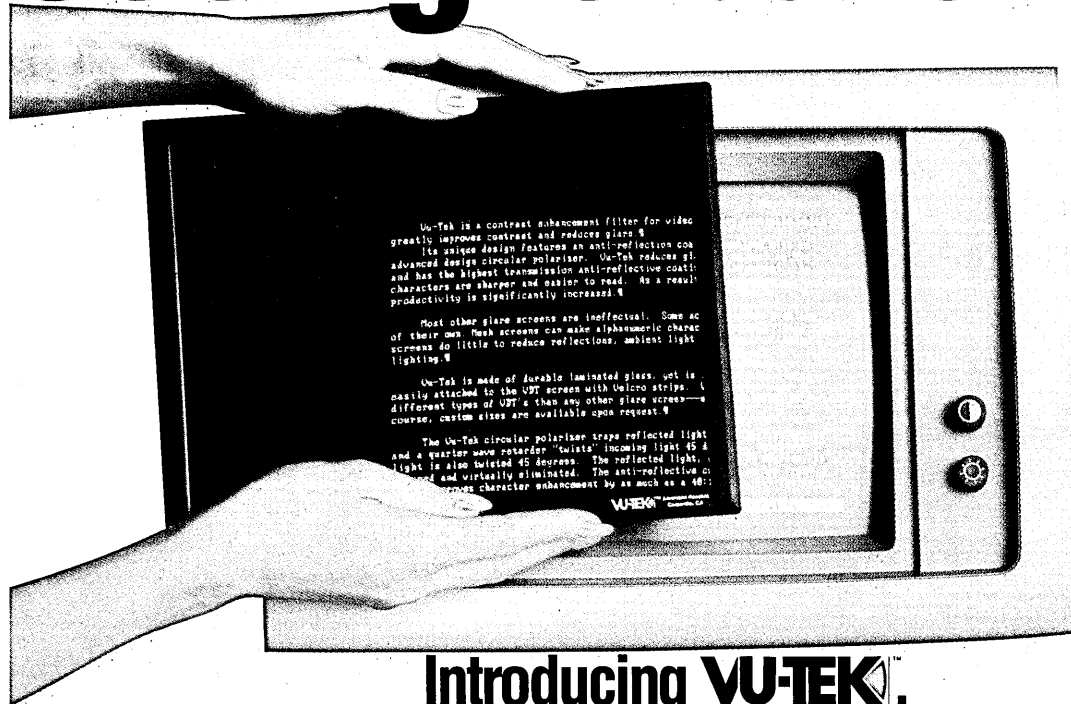

Introducing VU-TEK™

No other glare screen does more to increase productivity.

A glaring problem VDT operators face.

More than 90% of all employees who regularly use VDT's may suffer from eyestrain.* And that can make your business suffer, too.

The cause of eyestrain? Glare. Reflection from office lights. And hard to read characters.

The result. Impaired vision. Headaches. Fatigue. More work breaks and absenteeism.

And reduced office productivity.

VU-TEK™ reduces glare up to 99%.

VU-TEK contrast enhancement filters help increase operator productivity by eliminating up to 99% of reflected VDT glare while also improving character clarity. VDT operators can now work more efficiently and comfortably.

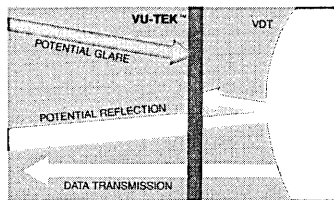

VU-TEK's dramatic effectiveness is due to an advanced circular polarizer that traps glare preventing it from reaching the VDT operator's eyes.

No other glare screen is more effective than VU-TEK.

VU-TEK increases character legibility.

VU-TEK uses a special distortion-free anti-reflective coating on the front glass surface to improve character contrast and clarity.

The result... bright, clear, easy to read VDT's.

Fits leading VDT's. Easy to install.

VU-TEK fits more than 800 different VDT types. Custom sizes are also available.

VU-TEK is lightweight, durable and attaches in seconds.

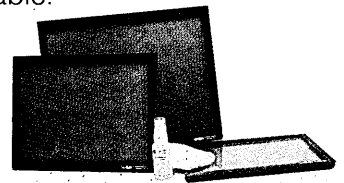

"See for yourself" free trial.

End the glaring problem with computer automation — with VU-TEK.

To order your VU-TEK or arrange a 30 day free trial, call collect 1-805-987-5026. Or mail the attached coupon for more information.

VU-TEK is the result of research by American Hoechst, a member of the Hoechst Group of companies, with worldwide sales of \$14.5 billion, and annual research expenditures of over \$630 million.

*National Institute For Occupational Safety and Health Study, August 1981.

American Hoechst Corporation 
Specialty Film Products

VU-TEK™ The difference is clear.

© American Hoechst Corporation, 1984.

CIRCLE 57 ON READER CARD

For additional information on VU-TEK™ contrast enhancement filters mail to:
American Hoechst Corporation
 Dept., 805 Via Alondra, Camarillo, CA 93010

Name _____
 Company _____
 Street _____
 City, State _____
 Zip _____
 Phone () _____

The user should become educated enough to critique engineering decisions as part of the UPS vendor evaluation and selection process.

FIG. 2
THE POWER SUBSYSTEM AS A CIRCUIT

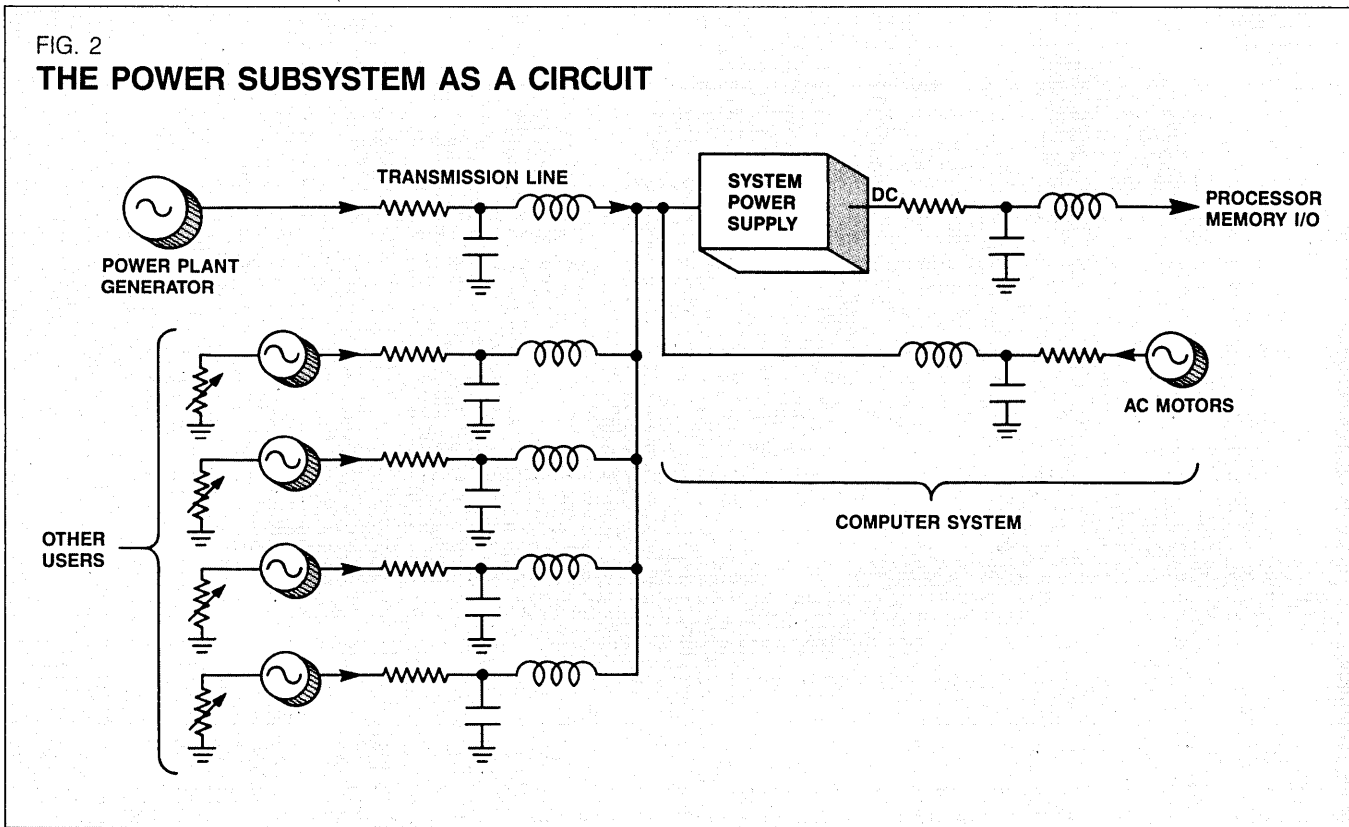

clock show the wrong time? In foreign countries, or in mobile and portable applications and self-operated power systems, the possibility of frequency variation must be allowed for in special power system design. Special power supplies can be obtained, and some types of UPS can be made impervious to line frequency.

Interruptions. The power line can go dead for a period ranging from milliseconds to days. Temporary local shorts can cause brief interruptions, but the longer outages are always due to power company generating or distribution problems, such as a blown transformer, a downed line, or a burned out generator. The electrical inertia of a good power supply will see the user through the millisecond-type interruptions, but the longer ones require a UPS.

CONCERN DICTATED BY USE

The application for which a computer system is intended should dictate the amount of concern and cost that is justified in power protection equipment. No system should be left susceptible to random errors or physical damage, so every system should be protected against noise, spikes, transients, surges and sags; a first-class power supply, an RFI filter, and an isolation transformer should be routinely provided.

Thus, the major design decision is how to deal with interruptions, and the design thinking in this area has not changed substantially in 20 years. Any of four modes of operation can be incorporated.

1. *Relax and enjoy it.* If the functions being performed are not critical, if the data being processed can conveniently be recreated, if the system is satellite to a host that provides the primary intelligence, there may be no need to provide any means to continue processing during power interruption, nor justification for the cost of doing so. Nearly all personal computers, remote terminals on large systems, and data entry stations are in this category.

2. *Orderly shutdown.* If the system need not continue operation, but the data being processed at the moment of power failure are critical, then power must be maintained long enough to complete current processing, save data, close files, place external machinery into a safe condition, and so forth. Examples are real-time data collection, machine tool control, and most accounting and business applications.

3. *Graceful degradation.* This pretty sounding term, AKA fail-soft, means the orderly shutdown of the high-power consumption portions of the system, but with sufficient power provided so that basic functions can continue. For example, in a

facility management system, the disk memory will contain sophisticated programs for boiler and chiller sequencing, enthalpy management, and multilevel personal access; under a gracefully degraded mode, the disk would be shut down and the building would operate from ROM-based programs providing standard heating and cooling settings, single-level (or no) access, and so forth. One perfectly acceptable form of graceful degradation is to shut down into a mode that allows operations to be performed manually.

THE MOST EXPENSIVE SYSTEM

4. *Damn the torpedoes, full speed ahead.* The ultimate, and most expensive, power system is one that continues to provide full power without interruption, heedless of any hiatus on the power company's supply line: a UPS. The designer's challenge in this instance is to provide adequate protection without squandering money. For example, for how long a period of time will power be needed? A day? A week? An eon? Should you provide a second UPS to take over if the first UPS fails?

Readers interested in the details of power protection and filtering, UPS operation and selection, and so on can choose from a staggeringly extensive volume of ar-

3270 Access

NEW! Now Supporting
Bisync & SDLC

Expanding 3270 access to
any terminal you have

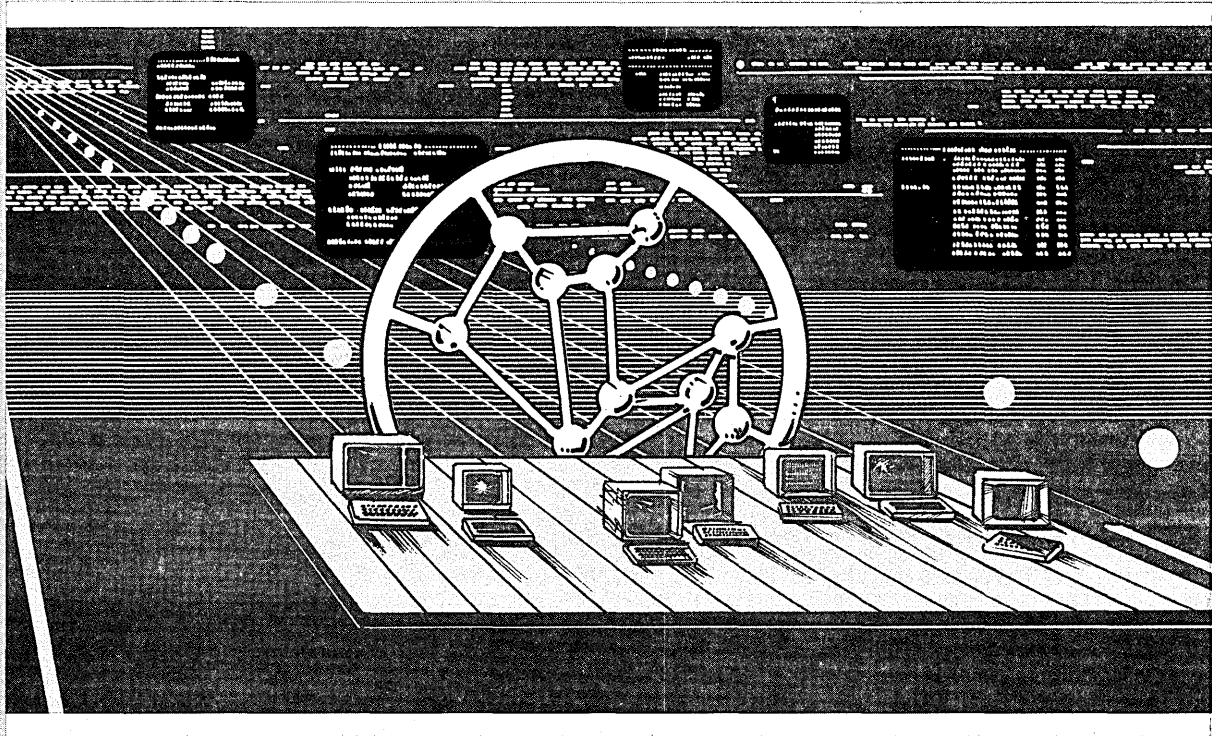

TYMNET simplifies 3270 access.

All it takes is a terminal and a local call to the Tymnet public data network.

We let you use the async terminals and personal computers you already have—at speeds up to 2400 bps.

We give 3270 terminals the versatility they need to access async services and independently access 3270 applications on one or more hosts.

There's no hardware or host hardware to buy. And Tymnet delivers price performance other data networks can't.

What could be simpler?

For more information
call or write for
Tymnet's 3270
Access brochure
and associated
data sheets.

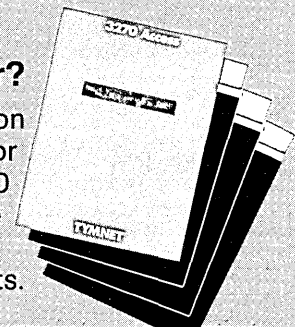

TYMNET, Inc.
2710 Orchard Parkway
San Jose, CA 95134
(408) 946-4900



Public & Private Data Networks

TYMNET[®]

A McDonnell Douglas Company

CIRCLE 58 ON READER CARD

System design should incorporate graceful degradation of operation to reduce cost of UPSs.

ticles. Rather than add unnecessarily to that volume, let's continue to view the UPS as a problem in effective system design.

There really are only three parameters of importance in selecting a UPS.

1. *Failover.* By definition, there cannot be any interval of time, however small, during which power is absent due to switchover from the power line to a backup source. This means that the backup source must be active and on-stream (and therefore itself subject to failure) at all times. There are three ways to accomplish this, but only the first two are commonly used.

- Entire computer runs from a battery kept continuously charged by the line. This is known as continuous service or direct (and some kinds of reverse transfer) UPS.

- Battery backup is provided at a slightly lower voltage than the DC from the power supply, and provides uninterrupted power when the normal source fails. This leaves the AC motors without power after their inertia has dissipated, and thus provides only graceful degradation or orderly shutdown.

- Rotating motor-generator continuously operates in readiness to take over supply of power. This is a heroic measure for very critical applications.

2. *Amount of power.* Should the UPS supply sufficient power (typically 300 watts to 400 watts for a microcomputer system, up to tens of kilowatts for a large system) to operate the entire system as though primary power had not failed, or should some form of graceful degradation be instituted?

3. *Time duration.* For what period of time should the UPS provide full power? Should there be a degraded operation on reduced power if the outage persists for days? Typical UPSs provide backup for a period of minutes to hours, although theoretically there is no time limit if the user continues to provide enough batteries. There are also nonautomatic remedies for the long term, such as a dual set of batteries and a means to charge the off-line set. Multistage solutions also exist, like a motor generator that can be brought on-line after a few minutes, with only the batteries having to serve during that interval.

Since the available UPSs almost universally rely upon batteries as the power source, it is important that the user and system designer develop some familiarity with the various kinds of batteries and their areas of usefulness.

Beginning at the bottom, the relatively new lithium-based batteries (lithium-iodide, lithium-carbon-monofluoride, lithium-manganese-dioxide, et al) can supply power in the range of microwatts to half a watt, for a time ranging up to two years or so. They are used for computer

memory backup, LCD clocks and watches, and pacemakers. They are very small in size and are not rechargeable.

Also very small and not rechargeable are the silver oxide (microwatts for a few months) and mercury (up to half watts for a few days) cells. They are useful for the same kinds of low-power applications.

The familiar carbon-zinc dry-cell flashlight battery is also not rechargeable, notwithstanding the come-on advertisements for rejuvenators in *Popular Science* and *Road and Track* magazines. They can deliver a few watts for several hours, and can be ganged to provide backup for a substantial portion of a microcomputer system for a few days, at nominal cost. Alkaline cells come in both rechargeable and nonrechargeable versions, and have similar capacities and applications, and a roughly equivalent cost-per-watt.

Nickel-cadmium batteries are the current favorite for rechargeable backup of low-power portions of systems. They can provide up to a watt or so for several hours, can conveniently be ganged for more power or longer supply time, and require relatively simple charging circuitry.

For bulk power, the only realistic source is the lead-acid automobile-type battery, which now comes in sealed versions and with gelled electrolyte instead of splashy acid. It has the most attractive cost-per-watt in high-power applications, and is rechargeable, although a relatively sophisticated charging circuit must be used to avoid both overcharging and undercharging, which can greatly shorten the battery life. (On the other hand, if those creative people in Detroit who design spare tire and jack stowage—which, like road maps, can never be put back the way they came—can design a charger for this battery, this problem would be solved. How difficult can it be?) Single units can deliver on the order of 20 watts for a day, and these batteries have been ganged by the roomful for many years to provide power in the kilowatt range for large systems.

CRITIQUE DESIGNER DECISIONS

A thorough treatise on the selection and design of battery backup systems is interesting and useful, but beyond the scope of this article. Most users will purchase an entire packaged UPS, including the battery provisions, and the necessary engineering decisions will have been made by the UPS designer. But users should become educated enough to critique those decisions when selecting and evaluating UPS vendors.

Growth of the power conditioning equipment business, including everything

from filters to UPSs, is currently at a 15% to 18% per year rate, and will probably increase somewhat as a higher percentage of new computing equipment is so equipped. The newly opened market for UPSs of under 1kW to service microcomputer systems is giving the industry a boost.

Batteries have come a long way, but have gone about as far as they can go with respect to major breakthroughs. They will continue to form the backbone of most UPSs and degraded operation and orderly shutdown systems, since there currently is not a realistic alternative. Batteries, however, are not a good solution for the long-term (beyond a day) UPS, and there will likely be increasing attention paid to combination units, with batteries as the short-term (minutes to hours) solution, and a rotating generator to take over for the long haul. This will also provide desirable redundancy in the UPS. One cannot discount the use of alternative energy devices (fuel cells, nuclear, solar) for eventual UPS use, but right now there is no serious prospect.

Power required from the UPS will continue to be reduced, as the more-circuitry-on-a-chip syndrome continues, and CMOS circuitry maintains its growth in popularity. The eventual replacement of the rotating memory by bulk solid-state memory (which has been widely predicted for a decade by many in the industry) will be a notable milestone in power reduction.

System design to incorporate graceful degradation of operation is an important step that can be taken today to reduce the size and cost of UPSs, but it is seldom done because it's easier to throw money at the problem and acquire a full-system UPS: this is commonly known as the government-at-Washington approach. Computer system designers and UPS vendors should both be in the forefront of this effort.

Lastly, like everything else, UPSs will become more intelligent. Built-in diagnostics to test the failover mechanism, the readiness of the battery bank and each of its cells to perform its function, are already becoming available. Some big-system UPSs incorporate sensors that monitor the state of the computer system and the power line, and anticipate the need for backup power. The microcomputer-controlled UPS will give us these functions and more over the next few years. ©

Dan M. Bowers is president of Bowers Engineering Co., Southport, Conn., which has been designing new computer systems and doing recovery and remedial work on existing systems since 1966. Bowers has been active in dp since the 1950s.

When you need
to find and file
computer
media faster

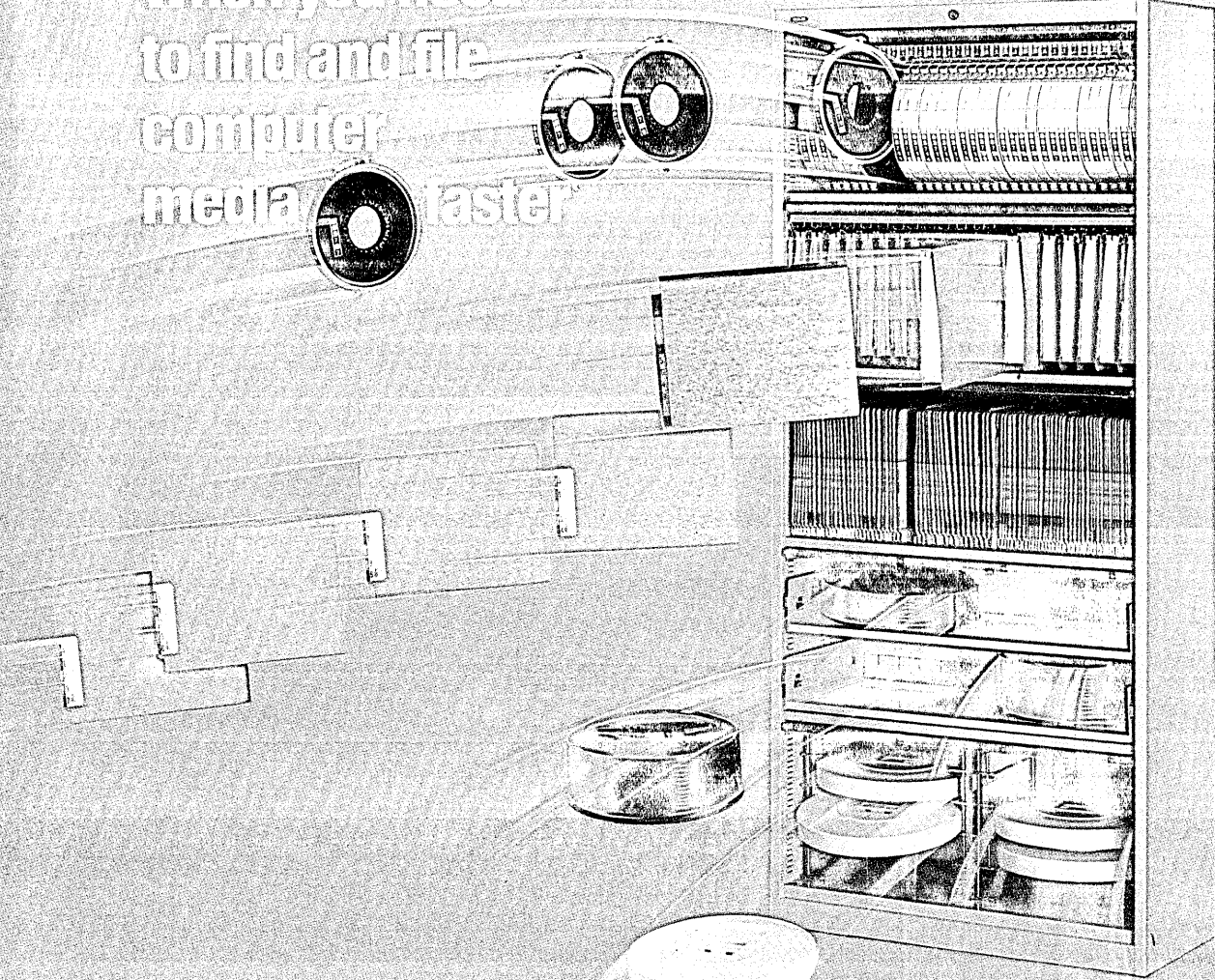

The TAB Advantage is a Data Media System

Where to put all that computer input and output is a daily problem. And keeping it organized can be a real dilemma.

TAB has the ideal solution. TAB Data Media® Cabinets are designed to adapt to any data processing application. And they are solid, with welded steel construction... the way TAB has been building cabinets for over 30 years.

TAB Data Media Cabinets are available in four heights, fourteen decorator color choices, three locking methods and with a selection of snap-in filing components for any size of magnetic media, microforms, printout, documentation, etc. You can easily change or update these cabinets to meet current needs.

For more details call: (800) 672-3109 Ext. 4101. In California (800) 742-0099 Ext. 4101. Or write us at 1400 Page Mill Road, Palo Alto, CA 94304. In Canada, 550 McNicoll Avenue, Willowdale, Ontario M2H 2E1.

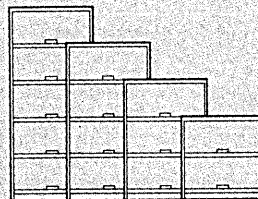

TAB
TECHNOLOGY AND BUSINESS
EQUIPMENT CO.

TECHNOLOGY
AND
BUSINESS

TERMINALS ■ COLOR-CODED FILING SYSTEMS ■ MOBILE SYSTEMS
FILING EQUIPMENT & SUPPLIES ■ FORMS PROCESSING EQUIPMENT
COMPUTER ACCESSORIES & SUPPORT FURNITURE ■ WORKCENTERS

CIRCLE 59 ON READER CARD



The HP 3000 compu

However much you change, you're going to need both office automation *and* distributed data processing. Fortunately, one company gives you both in a single system.

Hewlett-Packard's HP 3000 is a fully compatible family of computers, ranging from a new system that handles as few as two users to a distributed mainframe that connects up to 400. You can run the same software right up the line.

And our systems can change and grow as you do. When you're ready for upgrades and additions, you simply plug your existing programs into the new systems. No recompiling. No time and money wasted

on conversion.

A small, but mighty, addition.

The new HP 3000 Series 37 Office Computer, the latest member of the family, puts the power of the HP 3000 within the reach of smaller budgets.

So now you can afford to give your branch offices and departments their own systems. And they'll still remain part of your overall DP picture with links to other systems.

In the office, the HP 3000 is the heart of our Personal Productivity Center. This integrates the information people need to get their jobs done more productively.

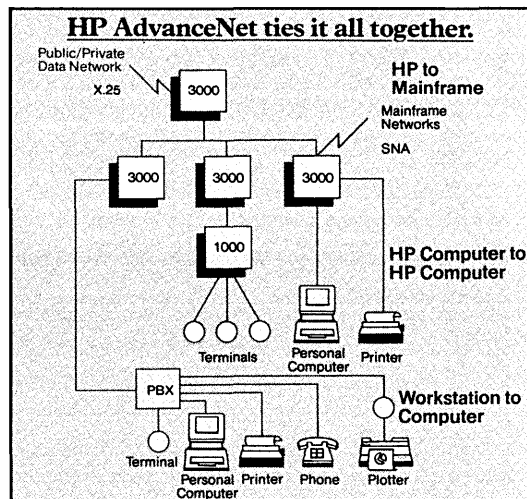

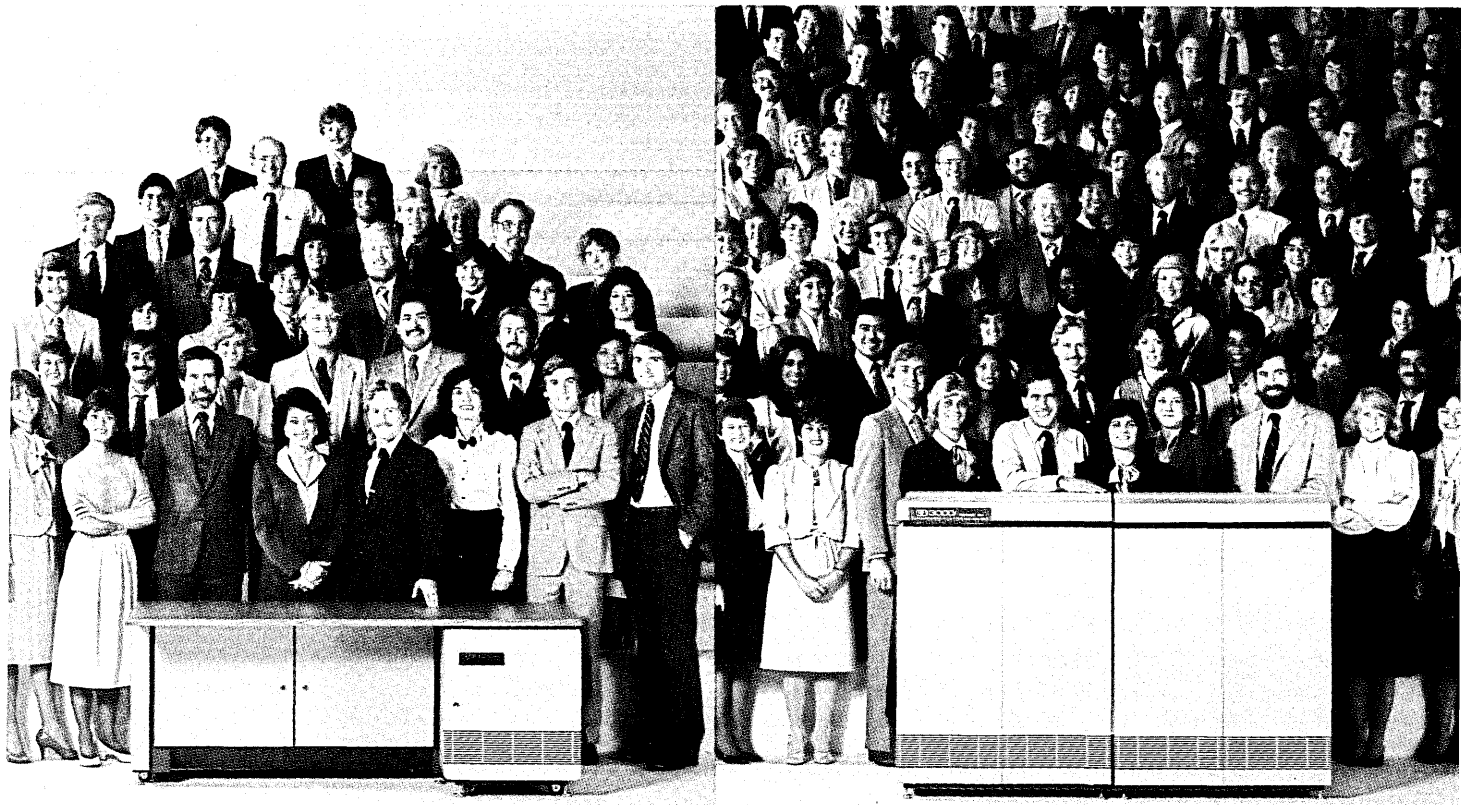

ter. One family fits all.

It provides an interface for a wide range of workstations, peripherals and personal computers, including our Touchscreen Personal Computer and The Portable, as well as IBM PCs. And it allows them to interact directly with the HP 3000. So your people won't have to learn DP commands.

You'll communicate better with HP AdvanceNet.

Our communications go well beyond this office network. With HP Advance Net, they extend to links with other HP 3000s, in the same building or on the other side of the world. And to your mainframe computers, ours or IBM's.

Currently, more than 10,000 HP 3000 systems are working in networks so effectively that our communications were voted #1 in a national survey.

A Datapro poll also rated our service

#1. So you get more than office automation and data processing in a single system. You get all the support you need from a single company.

For a demonstration of the single solution for both sides of your company, contact your local HP office listed in the white pages. Or write for complete information to Susan Curtis, Hewlett-Packard, Dept. 004203, 19055 Pruneridge Ave., Bldg. 46T, Cupertino, CA 95014.

In Europe, write Michael Zandwijken, Hewlett-Packard, Dept. 004203, P.O. 529, 1180 AM Amstelveen, The Netherlands.

We'll fit you no matter how much you change over the years.



HEWLETT PACKARD

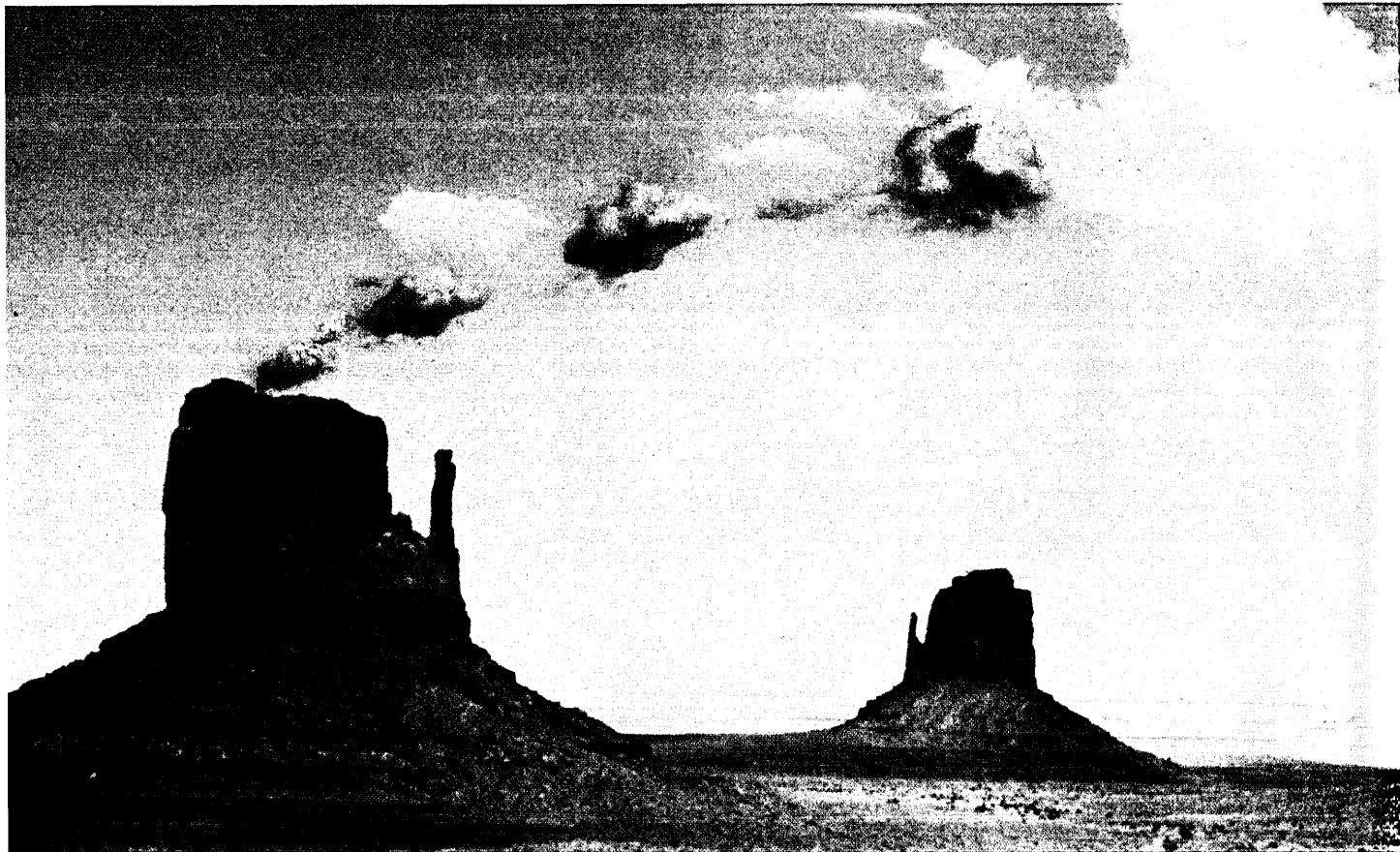

RENEX BELIEVES

THERE'S ALWAYS A BETTER WAY

For years smoke signals worked fine. Data moved successfully from one tribal center to another.

But times change. Smoke signals gave way to the Pony Express, telegraph, rotary dial, RS232 and protocol converters. With improved technologies, communications advanced.

The same is true with your data center. Data may be moving successfully because you made good decisions, but the world has changed. There are greater efficiencies to be gained by freeing your company from restrictive IBM communications technologies. And great cost savings as well.

Build on your past investments by tying them to today's advanced communications techniques from RENEX. A line of protocol converters that allow **any** ASCII dial-up device to talk to your IBM host . . . plus 8-bit error free transmission to remote personal computers using Renex Asynchronous Protocol (RAP).

Cut through IBM's smoke screen. Call RENEX today. We're the better way to communicate.



Renex Corporation
6901 Old Keene Mill Road • Springfield, VA 22150
(703) 451-2200 • TWX: 710-831-0237

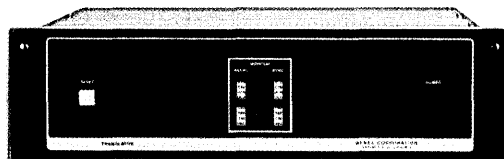

CIRCLE 61 ON READER CARD

This Stockholm software house aims to create the Peaceable Kingdom, but too much togetherness can interfere with real work.

A SWEDISH EXPERIMENT

by Joan Greenbaum

The founding members of Datakultur, a small but active software house in Stockholm, are veterans of some of Europe's largest programming projects. When they started the company four years ago, they wanted to have more say about the way they worked, more control over the type of work they did. Now they have planning meetings on sailboats and windswept islands, and can split their time between personal projects and business concerns. How did it happen, this small-scale programmers' utopia?

As the firm's name implies, Datakultur is founded on the idea that processing information is more than a job—it is a way of life, a culture. Bjorn Egerth, a 38-year-old cofounder of the firm, puts it this way, "Each of us comes from different interests and we bring these interests to our work. But that doesn't mean that our involvement stops there." Egerth believes the company has something to offer programmers from "Silicon Valley to Stockholm." He says, "We are a self-styled cooperative, and we can stand strong together in whatever we do." Indeed, the Datakultur founders were accustomed to cooperative ventures: each had worked an average of six years in compiler design and large-scale project development.

The five original members of Datakultur still do much together. During the past year they have designed a major database system for the Swedish military, helped refine a compiler for the Simula language (a Scandinavian favorite), and consulted with labor unions to help them deal with technical change. They have also arranged national and international seminars on issues ranging from artificial intelligence to management styles in data processing.

Technical togetherness is just a part of Datakultur's plan. The staff rents a cottage on a small island in the Stockholm archipelago that they use for meetings and seminars. Some of them also sail together on the Baltic Sea. And if the company that cooks together stays together, then the regular biweekly dinners at members' homes

are also means of getting down to business. Obviously, however, members of the Datakultur firm don't spend all their time together: last year, their consulting contracts were quite diversified, and during working hours staffers usually worked separately on their own consulting projects.

PROFIT ON BASIC WORK

"The firm makes a profit on its basic technical work," says Egerth, "so we use this profit to our individual and collective advantage. Claus Wihlborg, for example, is fascinated by psychology and he's using his proceeds from the firm to return part-time to school to get an advanced degree. Kalle Malila, who enjoys geography, offers some of his time to a group of geographers who could not otherwise afford his consulting services. And I like to help trade unions learn more about computers. So you see, we make a profit and then we are busy building a culture of things that we think need to be done."

The five founders of the Datakultur collective bring to the firm diverse backgrounds and differing expectations. Mats Ohlin, for example, was working for the Swedish Defense Research Institute when he became interested in how systems are used. One of his aims is "to give users toolboxes rather than turnkey systems." Ohlin feels that turnkey systems "humiliate users, forcing them to act like computer illiterate subordinates to the system." He sees the need for "designing systems that act like toolboxes to encourage users to think and act for themselves. People could use the tools as they need to and learn as they use the system." The toolbox approach is not uncommon in Scandinavia, where designing user-friendly systems means more than simply being friendly to user management. Toolbox systems range from application packages—microcomputer database and spreadsheet programs—to flexible, user-manipulated languages like Simula for designing custom systems.

Bjorn Egerth's emphasis within the firm is on developing trade union computer literacy projects that enable workers from

all levels to participate in system design. Since unions are an integral part of the Swedish landscape, this is a less complicated task than it would be in the United States. Virtually all Swedish workers (including IBM employees) belong to unions, which for Egerth reinforces the importance of union-management "coexistence." Union-sponsored courses that help workers understand technology set the stage for the design of systems in which software functions like toolboxes usable by all the people using the systems.

For Kalle Makila, a former academic and at 44 the oldest member of the Datakultur community, the firm is "a bridge between the academic world and commercial reality." Makila feels that too often the academic community cuts itself off from the real problems of software design. "Datakultur," he says, "is a place where researchers, professors, and system designers can meet." Last year, Makila taught a course at a technical institute on the impact of computers on society. While his academic orientation is somewhat different from that of Ohlin, who focuses on technical challenges, and Egerth, who is intrigued by the idea of empowering users, Makila joins the others in the common theme of creating tool-based systems.

Claes Wihlborg, who is known in software circles both for his elegant technical designs and for walking into meetings in sandals and cut-off jeans, originally came to the firm to use his programming skills for political and social purposes. His interest was in finding "good" work or contracts that "would be useful for society and politically acceptable." His definition of useful has raised the question of the firm's involvement in the design of a planning system for the military.

While most Swedes see a strong military as essential to maintaining their independent national status, the issue of military strength raises questions in Sweden as it does in other countries. Some feel that while the military may be a necessity, improving it is not necessarily a socially useful software task. The discussion within Datakultur is not unlike that in the U.S. In

Some question the firm's involvement in the design of a planning system for the military.

the 1960s and '70s, groups such as Computer People for Peace raised the issue of programmer involvement in the war in Vietnam, and more recently, Computer People United (CPU) has examined the link between computer software and the military buildup.

Liselott Falk, the youngest member of the Datakultur staff and the only woman, feels strongly that her skills as an economist should be used only for peaceful purposes. Her interests lie with the environmental movement in Sweden and she is anxious to see Datakultur "provide a place for seminars and forums around the issues of how computers are used and for what purposes."

Datakultur's offices—two floors of bright, open, and well-designed space—are near Old Town in central Stockholm in a restored building that formerly housed an architectural firm.

The kitchen is a frequent meeting place; it is often hard to tell clients from visitors and friends. An obvious drawback to the pleasant surroundings is the fact that they are too often filled with interesting people. Bjorn Egerth admits to spending many midnight hours trying to catch up on work he couldn't get done during the day. Apparently, the balance between a comfortable work environment and a productive one is not easy to achieve on either side of the Atlantic.

Datakultur is an incorporated, stock-ownership company that operates as a cooperative. Salaries are the same for all staffers, but depend on the amount of time each puts in. Kalle Makila, for example, draws a part-time wage because he has been at home with his new son. Kalle's net salary, low by American standards—about \$600 a month!—"is more than adequate" he says. Since child care expenses are subsidi-

dized by the government (they come to about \$100 a month for his two children) and rentals are comparably low (his is around \$200 a month for a two bedroom garden apartment), Kalle and his wife Karin, an economist, are also able to afford a small house in the country. "The house," says Kalle, "is a place to go and reflect on nature, which is an important part of our life-style." The house is only an hour's bus ride from downtown Stockholm, and since the firm provides each staffer with a monthly bus and subway pass (a common practice in Stockholm), Kalle and Karin see little reason to own a car. Like many parents of young children they say that "time is more of a constraint than money."

OVERHEAD COSTS KEPT LOW

Though most income is plowed back into the company, the firm subsidizes some employee living expenses, not unusual for Sweden. In addition to monthly transportation passes, Datakultur members give themselves "free lunch" passes that can be used at restaurants in the area.

The standard Swedish five-week vacation is stretched at Datakultur to six weeks plus holidays: there is plenty of time to sail in the summer and ski the rest of the year. Claes Wihlberg and Liselott Falk, who are now a couple, spent two weeks this past summer sailing off the Danish coast and two weeks traveling by train around Norway. Last winter, Claes took extended skiing holidays. While he has chosen to work three-quarter time as he finishes his degree in psychology, he still makes time for his hobby—acting in street theater.

The name Datakultur brings together two possibly clashing worlds. The

first represents the serious commercial world; in Sweden the word data refers specifically to computerized information. The kultur appendage points to a way of living, which for some people conflicts with the commercial nature of the firm. Parts of both worlds exist within the company and while commercial success is the cornerstone of the firm, problems of culture, politics, and life-style sometimes cause concern.

Liselott Falk is pleased that planning meetings work as well as they do, and she sees the annual autumn budget session at the island cottage as "a good example of how we allocate our time." Bjorn Egerth is satisfied that the "one person, one vote" rule within the firm gives each staffer equal say in making decisions. Kalle Makila is delighted that the company is flexible about helping members adapt convenient work and family schedules.

Of course, harmony is not consistent. Datakultur's emphasis on collective decision-making is as unusual in Sweden as it is in the United States. Consequently, members think they need more practice to iron out the bugs. Joint decision-making can sometimes lead to long-drawn-out meetings.

For Kalle Makila, "controlling the conditions of work is as important as the work that is done." He believes that the processes that the firm uses to make decisions influence the decisions that are made. So working out the kinks in the collective work process takes pride of place in the priorities of the company.

Makila's feelings are echoed by the others: they are anxious not to re-create the hierarchical structure of the places they previously worked for. This is no easy task, for the big issue now facing the firm is how to expand without tampering with success. As one staffer says, "It's easy to get more work, but difficult to get more people." New people would have to be hired on the basis of their common interest in the firm as well as their technical skills.

Egerth feels that "Datakultur is like a musical group that encourages creativity by bringing people together to make music that they couldn't do alone." But, he adds, "creativity breeds problems in diversity, and this we just have to live with." ©

Joan Greenbaum, author of *In the Name of Efficiency* (Temple University Press, 1979), frequently lectures and writes about computers and work. She has given a number of seminars in Scandinavia this past year. She teaches dp and economics at LaGuardia Community College (CUNY) in New York City.

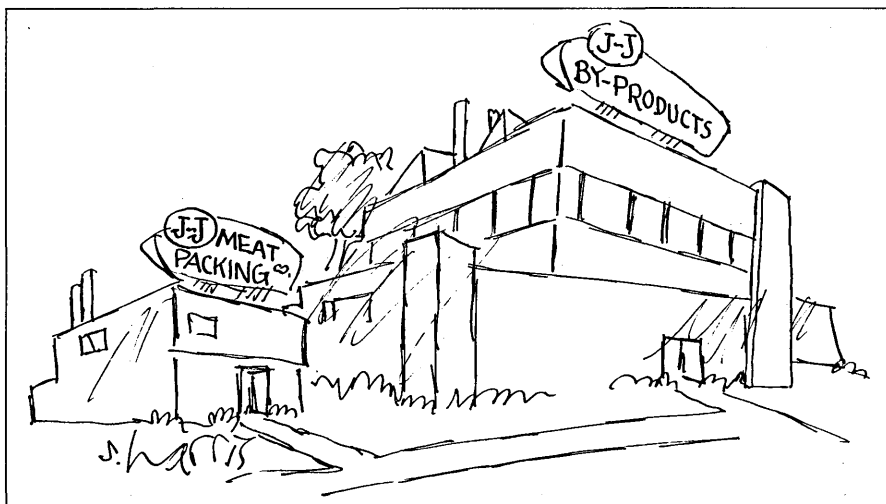

CARTOON BY SIDNEY HARRIS

OEM EDITION

DATA MATIATION

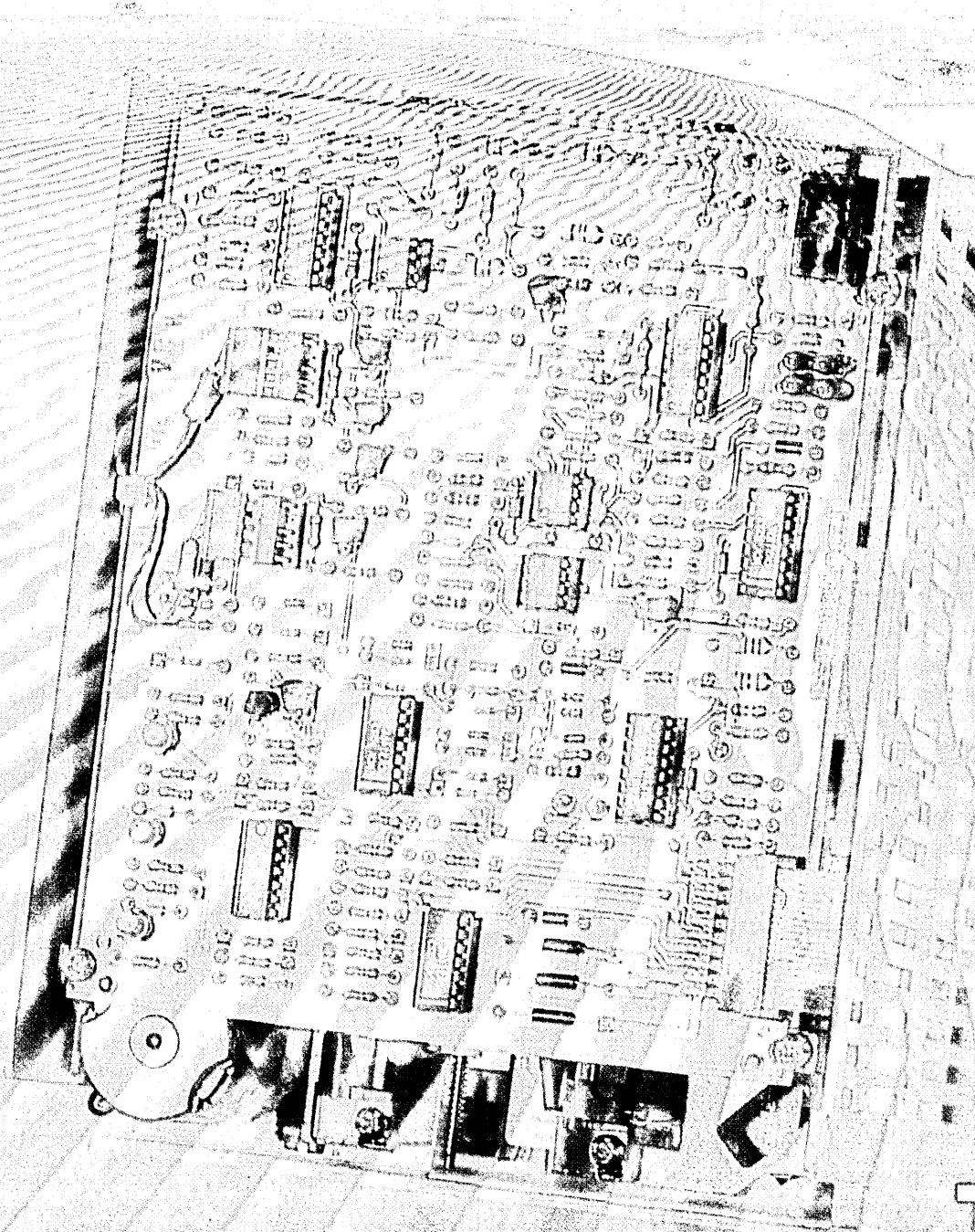

PC BOARD BY PHILIP A. HARRINGTON/PHOTO OF DESERT BY WALTER NELSON

THE WINCHESTER ILLUSION

The facts behind Hitachi's superior drive.

A landmark in Hitachi's powerful drive to simplicity are these new half-height minifloppy disk drives. Using proprietary technology, Hitachi makes reliability not just an advertising adjective but a demonstrable fact with specific benefits.

One PC board that does the work of three

An outstanding example of how Hitachi's drive to simplicity increases reliability is the PC board problem.

A minifloppy drive normally has 2 or more PC boards. But the more boards and chips and parts, the greater the manufacturing costs, the greater the power consumption, and the greater the possibilities of problems.

Hitachi's engineers and research team decided to do something about those boards. First, Hitachi used its bipolar MOS expertise to create a new custom LSI which processes the I/O signals, controls the stepping motor, generates timing pulses and includes the write circuit. Second, hybrid IC's were designed

for the read amplifier, waveform shaper and peripheral circuits. By developing such a new custom LSI and hybrid IC chips, Hitachi created one single PC board that more than does the work of the previous three.

This automatically reduces power consumption, manufacturing costs and, even more important, increases reliability and working life. Compared with our previous drives, total parts have been reduced by more than half.

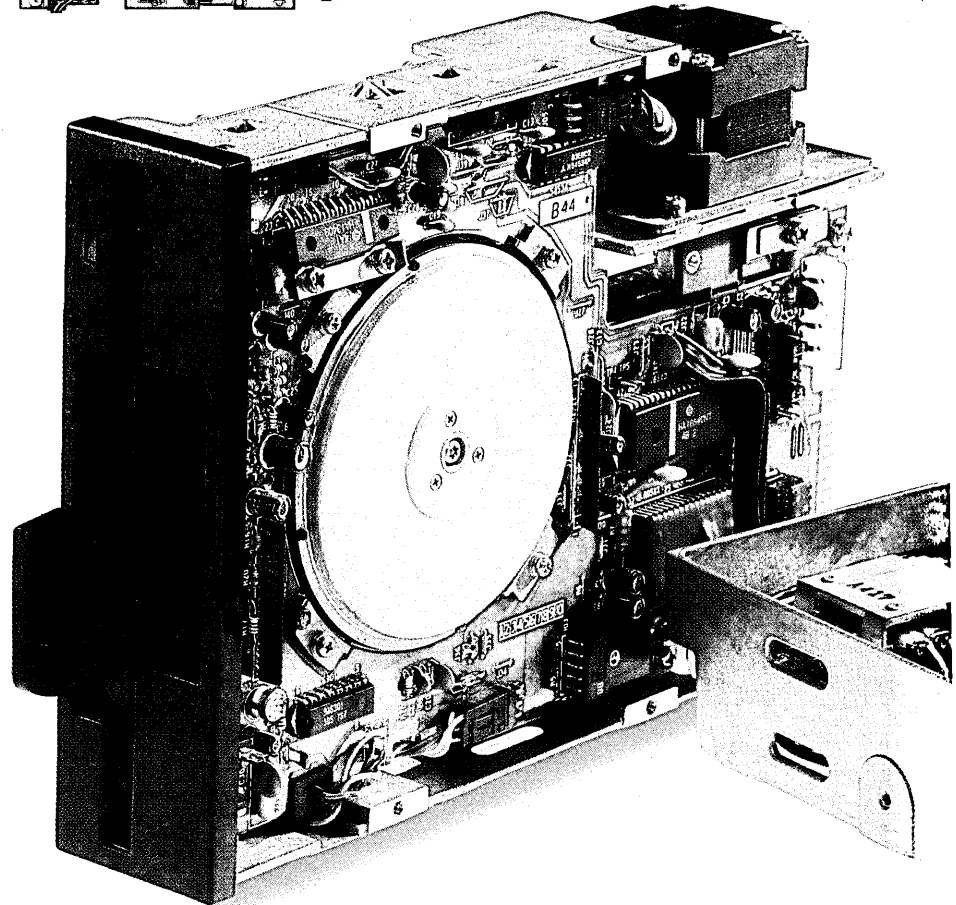
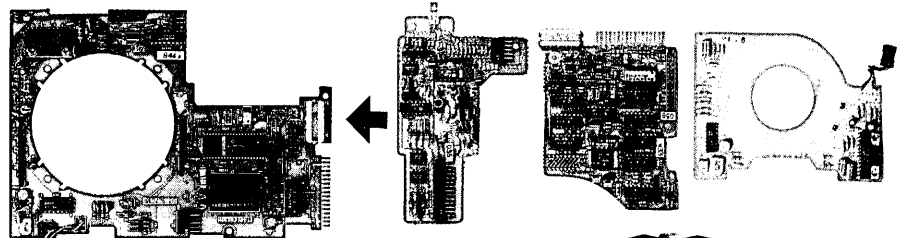

HFD516C

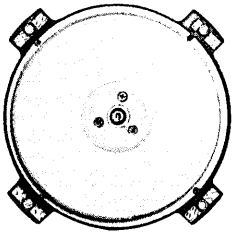

Closing the distance

A normal motor requires a specific distance between the rotor and stator. That distance naturally diminishes efficient use of energy and can cause problems in high power consumption. By using a new design and a flexible printed board (FPC), Hitachi radically reduced that distance. So the drive is thinner and the torque is higher. Since energy efficiency is increased, power consumption is reduced. The brushless DD motor offers virtually noiseless operation, the highest rotational accuracy, and a longer working life.



Clamping during disk rotation

Clamping occurs the moment the motor starts rotating after the drive lever is locked. Since the disk is turning during clamping, centering is exceptionally precise.

8" floppy data compatibility

Hitachi now offers a minifloppy diskdrive, HFD516C, that has the same capacity as 8" floppies — 1.6 Mbytes. This is clearly a powerful convenience for transferring data and increases applications and the versatility of your drives. Your entire system's size can be reduced.

High access speed

Access speed depends upon the head positioning device because head positioning is crucial for all read/write operations. With a steel belt and hybrid step motor, Hitachi's track access time of 3ms (96 tpi model) is unsurpassed by any minifloppy drive on the market today. And head positioning is extremely accurate.

The critical trio: value, reliability, quality

When it comes to value, these drives are far ahead of the rest because Hitachi's ultra-modern production techniques set industry standards for efficiency. If you choose the 0.5 Mbyte, 1 Mbyte or 1.6 Mbyte model, capacity differs but reliability is identical. That's because Hitachi reliability goes beyond impressive specs. It's grounded on reliability proven not just for 5 years but for over 5 decades. The bottom line is that Hitachi's drives and other OA products offer the very best investment in quality today.

Hitachi's new half-height minifloppy drives — HFD505C/510C/516C. Driving toward simple superiority.

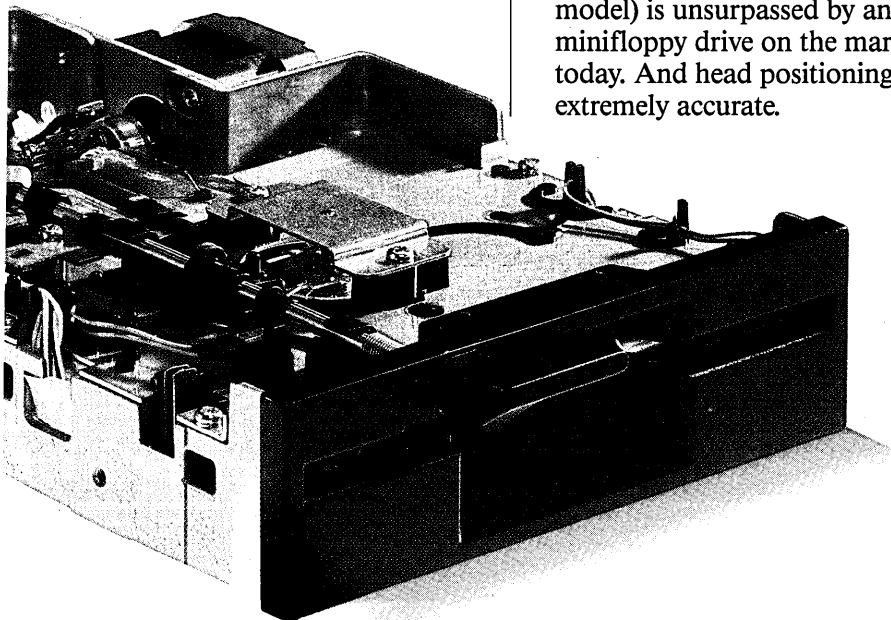

Hitachi America, Ltd.
Industrial Components Sales & Service Division
50 Prospect Avenue, Tarrytown, N.Y. 10591-4698,
Tel: (914) 332-5800

CIRCLE 73 ON READER CARD

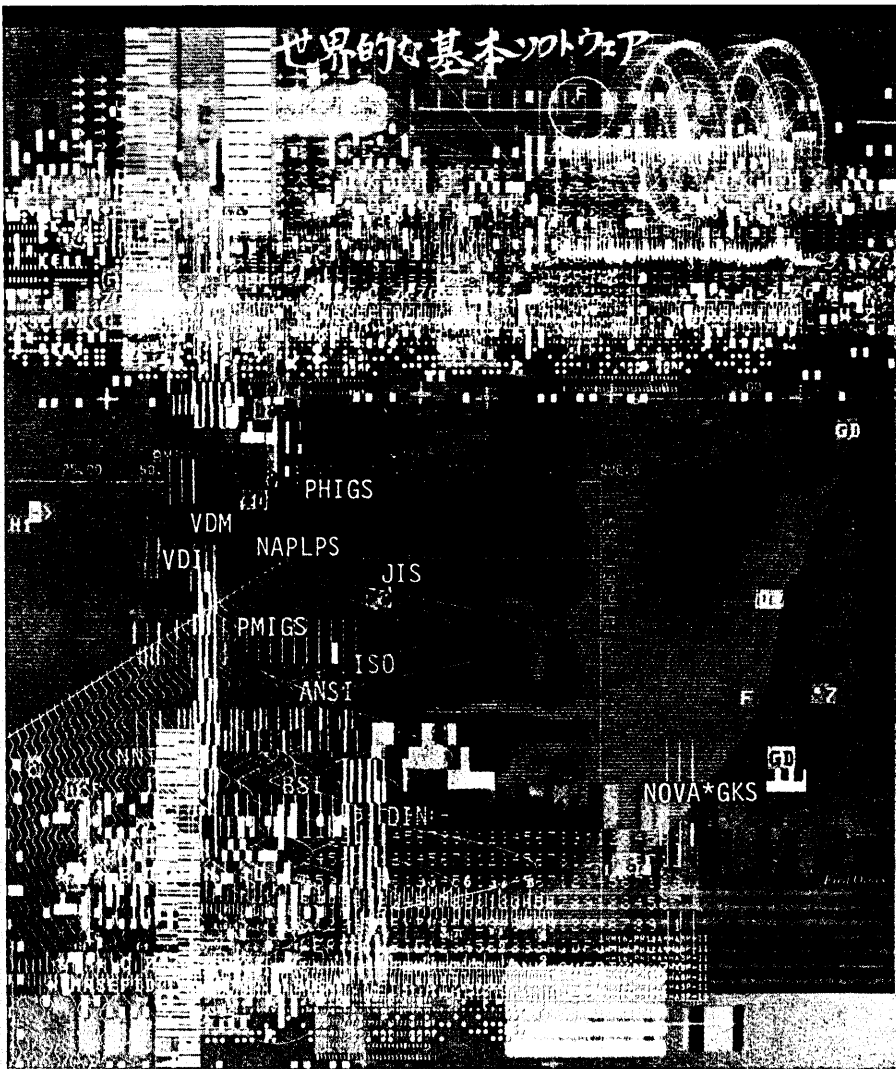

**When the world
of computer graphics
required standards,
the world of standards
acquired NOVA*GKS.**

Computer graphics takes an unprecedented step into reality with NOVA*GKS™ software from Nova Graphics International.

Years of innovative research make NOVA*GKS today's most advanced, full implementation of the Graphical Kernel System (GKS), the international graphics standard. Because of its unique, distributed architecture, NOVA*GKS allows multiple hardware configurations in host, workstation, and microcomputer environments.

A graphics development tool, NOVA*GKS makes it easier to design and construct graphics applications. In a fraction of the traditional time. In addition, applications using NOVA*GKS are totally device independent. Even portable.

To learn more about NOVA*GKS and its bottom-line competitive advantages, contact us today. We'll show you how NOVA*GKS and the Nova Graphics International support team can put your products on the leading edge of an escalating, worldwide market.

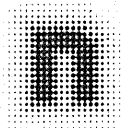

NOVA GRAPHICS INTERNATIONAL
CORPORATION

"World Standard Software"

1015 Bee Cave Woods Austin, Texas 78746 USA (512) 327-9300, Telex 767109

CIRCLE 74 ON READER CARD

Spotlight on the confusion existing in the marketplace for hard disk interfaces and controllers

THE WINCHESTER ILLUSION

by David Morris

A standard interface for Winchester disk drives is an illusion of a nonexistent reality. And when a sufficient number of computer industry customers and competitors put their faith in this illusion, it actually takes on a life of its own.

The process goes something like this. A given disk manufacturer, in order to eliminate the suffering among its customer base and put itself in a more competitive position, devises a disk with a new interface. It seeks converts by telling the hearth that its interface is superior to that of its competitors. If it can afford to keep singing this marketing psalm, and thereby convince customer and competitor that it is true, then a new disk drive interface will be born. Indeed, there are many who say that this is how the ST506/412 from Seagate Technology, Scotts Valley, Calif., became the ubiquitous industry standard that it is today.

In the contemporary marketplace, the interfaces commanding sufficient support to be an established industry standard, or a strong contender thereof, include extended versions of the storage module drive (SMD) interface; the extended small disk drive interface (ESDI); ST412HP, which is a performance-improved version of the existing industry standard ST506/412 interface found on 5¼-inch disk drives; the small computer system interface (SCSI); and the intelligent peripheral interface, or IPI.

In the beginning, there was only one interface that commanded any kind of backing outside of IBM: Control Data Corp.'s storage module drive (SMD). "For 14-inch disk drive products," says John Clemens, an independent disk drive industry consultant with Winchester Storage Inc. in Campbell, Calif., "the SMD interface was probably the single most accepted method of attachment in the oem marketplace."

Despite a concerted effort by zealots of other interface standards, the SMD interface will continue to enjoy a long life. "SMD will probably have another five or more

years of life," reckons Don Peterson, Multibus product line manager at Qualogy Inc., San Jose, a manufacturer of Multibus-compatible disk and tape controllers for Intel Corp., Santa Clara, and Digital Equipment Corp. One reason for its longevity is its enormous installed base. CDC marketing literature says that since the interface was introduced in 1973, more than 200,000 SMD drives have been installed worldwide.

That figure excludes the large growing base of product from other SMD drive vendors. Other prominent suppliers include Japanese disk drive makers like Fujitsu America Ltd., Santa Clara. In addition, all the 8-inch disk drive manufacturers like Micropolis Corp. in Chatsworth, Calif., Megavault Inc. in Woodland Hills, Calif., and Amcodyne in Longmont, Colo., have been shipping product with the SMD interface.

Michael E. Cope, president of Interphase Corp. in Dallas, a disk controller and subsystem manufacturer, says that his company chose to implement the SMD interface because of the large variety of disk drives available to use the interface. "We can pick from drives offering capacities from 16MB to 820MB," he notes. Interphase chose to use the Fujitsu Eagle in one of its subsystem offerings because of the drive's capacity and performance. The Fujitsu product implements the extended version of the SMD called the HMD. It calls for a 14.872MHz data transfer rate instead of the 9.67MHz, and 842 cylinders instead of the 820 cylinders of the original SMD. Another company with a controller built to the HMD interface is Dataram Corp., Cranbury, N.J. Its UDA50 is a controller capable of handling the additional cylinders of the Fujitsu Eagle as well as a data transfer rate of up to 20MHz.

Says Cope, "The extended version addresses two limitations of the original, an arbitrary limitation of the data transfer rate and total number of cylinders." The term cylinder defines all the tracks of the same number on all disks inside a drive. Thus, in a drive with four disks, there are eight sur-

faces, each with a track 0, 1 . . . N. Track 1 on each data surface forms a vertical cylinder. Data is typically stored on a disk beginning at the topmost data surface and continuing downward in the cylinder. Thus, large amounts of data can be stored without moving the read/write head.

CUSTOMER DEMANDS BEING MET

"The increasing data transfer rate is occurring in response to a demand from the customer base for higher throughput," says Qualogy's Don Peterson. Workstations that offer high-resolution graphics features are typical of such end-use applications for higher data transfer. The faster data comes from the disk, the quicker complex graphics images can be painted on screen. The demand for higher throughput coincidentally solves a problem faced by disk drive manufacturers. To increase storage capacity they could add more disks, write more tracks per surface, or increase the density at which bits are stored in a track. The first option adds cost, while the second requires some mechanical redesign. The simplest and less costly method is to up bit density.

Transfer rate is directly related to the bit density of data stored on the disk and the rotational speed at which the disk turns (most turn at 3,600RPM). Increasing either factor ups the transfer rate. Data transfer rate increases can be accommodated fairly easily. James Patton, manager of market requirements for magnetic disks at CDC, says that "adding capacity by increased use of surface area [the first two options mentioned above] has already been done to the cost-effective limit. Adding capacity by increasing bit density has not been done to its cost-effective limits due to limitations in the interface—for example, limitations in the driver/receivers integrated circuits on the drive and controller."

These ICs are the transmitters and receivers at either end of the communications line that carries data between disk drive and controller. "Current low-cost, readily available driver/receivers are available to handle transfer rates up to 16MHz,"

In the beginning, there was only one interface that commanded any kind of backing outside of IBM.

says Patton. "Beyond this, newer ICs will have to be used."

The problem with the HMD interface implementations, however, comes in how each HMD version accommodates additional numbers of cylinders. Because HMD is not an American National Standards Institute standard, each drive maker has come up with its own variation. The differences exist because each company has chosen to specify different spare physical pins on the interface as additional cylinder address lines. To eliminate this problem, the H3T9.3 SMD I/O ad hoc committee met last October to discuss revising the SMD specification document.

The meeting was attended by representatives of all major suppliers of SMD drives and controllers. "The committee met to address how to modify the SMD interface to accommodate a faster data transfer rate and increased cylinder addressing," says Gene Milligan of CDC, the committee chairman. "The ad hoc committee made recommendations to the full ANSI H3T9.3 committee, which were accepted during a regular meeting held in Boston the last week of October." Now it remains for the standards document to be revised and presented to the committee for final review and acceptance.

In a similar ad hoc gathering of people with common enlightened self-interest, the ESDI (extended small device interface) acquired something of a religious following in late 1982. Maxtor Corp., San Jose, convinced a number of disk drive and controller manufacturers to meet for the purpose of producing a new standard interface. It would be smaller and cost less than the standard SMD interface. These features are particularly desirable on 5¼-inch disk drives and controllers being sold to manufacturers of supermicrocomputers. The final product would be aimed competitively against minicomputers, particularly DEC's VA series.

Attractions of ESDI, in contrast with the SMD interface used on most minicomputer mass storage subsystems, includes both cost and packaging. "The SMD interface requires two very bulky and expensive cables. In large products, these drawbacks are minor, but in medium and small products they become progressively more difficult to handle," explains John Clemens.

ESDI IS SMALLER, CHEAPER

According to Don Peterson of Quality, "The ESDI is smaller and cheaper to implement than the SMD interface." He reckons the former costs \$300 to \$500 less to implement than the latter, and adds, "ESDI can

accommodate data transfer rates comparable to SMD." Peterson refers to the ability of one ESDI controller to handle both disk and tape drives, a feature not available on the SMD interface. In addition, the mechanical ESDI interface is identical to the ST506/412, hence much smaller and cheaper than the bulky, expensive cables described by Clemens for the SMD interface.

Phil Devin, director of marketing at Hebec, Sunnyvale, Calif., says that his company is currently shipping a starter kit that contains a controller, host adapter for the PC, software to exercise the interface, and a CDC WREN II disk drive. The typical configuration of the product is ESDI on the drive side, SCSI on the computer bus side, and a host adapter to the particular computer bus in question. He sees the 5Mbps transfer rate being the one supported by both drive and controller manufacturers until at least mid-1985.

Why would anyone want to use the ESDI with a 5Mbps transfer rate when the lower-cost, industry standard ST506/412 is already available? Devin sees the principal market being the high-performance Winchester going into a multi-user system. Here, the serial command/response capability—ESDI allows the controller to converse with the disk drive's microprocessor while the ST412HP does not—of the interface provides faster average access time than the ST506/412. In addition, the added error correction ability of the interface makes it attractive for applications that demand higher data integrity than a personal computer application.

While the lower transfer rate might be acceptable for the microcomputer manufacturer moving up from low-end systems built around 8-bit microprocessors, the rationale of a 5Mbps ESDI interface does not hold true for oems building superminicomputers. "Most of these customers view the faster throughput, up to 25MHz, of the ESDI as the most attractive feature," says Peterson.

Nevertheless, there seems to be support for Devin's position among suppliers of disk drives and controllers, according to Peripherals Concepts Inc., Irvine, Calif., a research firm following the disk controller industry. In the August issue of their monthly newsletter, the firm predicted that the trend for ESDI controllers was for 5Mbps versions in 1984 and 10Mbps versions in 1985.

Among companies currently offering 5Mbps ESDI controllers are Distributed Logic (Dilog) Corp., Garden Grove, Calif.; Hylogics Inc., Burlington, Mass.; and Interphase Corp. Among drive vendors offering ESDI, count Hitachi American Ltd. in

San Bruno, Calif., and Micropolis Corp. In addition, early ESDI apostles Vertex Peripherals Inc. in San Jose and Maxtor Corp. both should now have ESDI products.

Apart from the congregation of SMD devotees, another interface sect competing with ESDI for followers is the ST412HP first proposed by Seagate Technology Inc. Seagate, which did not join the ESDI effort, saw that the religious fervor for its popular ST506/412 was beginning to wane in late 1983. It decided to propose yet another interface, the ST412HP, to regain its straying flock, which had begun showing concern with producing high-capacity, high-performance disk drive subsystems.

THE CASE FOR THE ST412HP

Mike Kennedy, Seagate vice president of marketing, makes the case for the ST412HP. "The new interface provides a data transfer rate of up to 15Mbps and adds additional error detection and correction capability. However, it is not significantly different electrically or mechanically, from the industry standard ST506/412 interface. Finally, it requires minimal changes to software drivers already used for the ST506/412."

Another supporter is Bob Abrahams, director of marketing at Tandon Corp, Calif. "The ST412HP allows building an economical subsystem that the manufacturer can get to market quickly," he states. "This is possible because the interface makes use of so much existing controller technology. As a result, the oem gets an optimum solution for subsystems in the capacity range below 100MB."

Aiming at providing disk drive products with storage capacity below 100MB is a sound strategy, considering that James N. Porter, president of Disk/Trend Inc., Los Altos, Calif., and author of the annual *Disk/Trend Report*, shows that the market for drives with less than 30MB of capacity is the industry growth leader. In 1983, 1,157,500 units were shipped worldwide, compared with 239,700 units in 1982.

Porter also sees disk drives in the 30 to 100MB range enjoying significant growth, too, from \$1.14 billion in 1981 to \$2.5 billion in 1985. In 1981, 99% of the shipments were 8-inch drives or larger. By 1985, 34% of the total shipment will be 5¼-inch drives.

The bone of contention in the struggle over the ST412HP is the location of the data separator, which is the electronic circuit that extracts binary 1s and 0s from the analog signal stored in the disk magnetic medium. The circuit affects data transfer rate as well as soft error rate, which is the frequency of intermittent randomly occur-

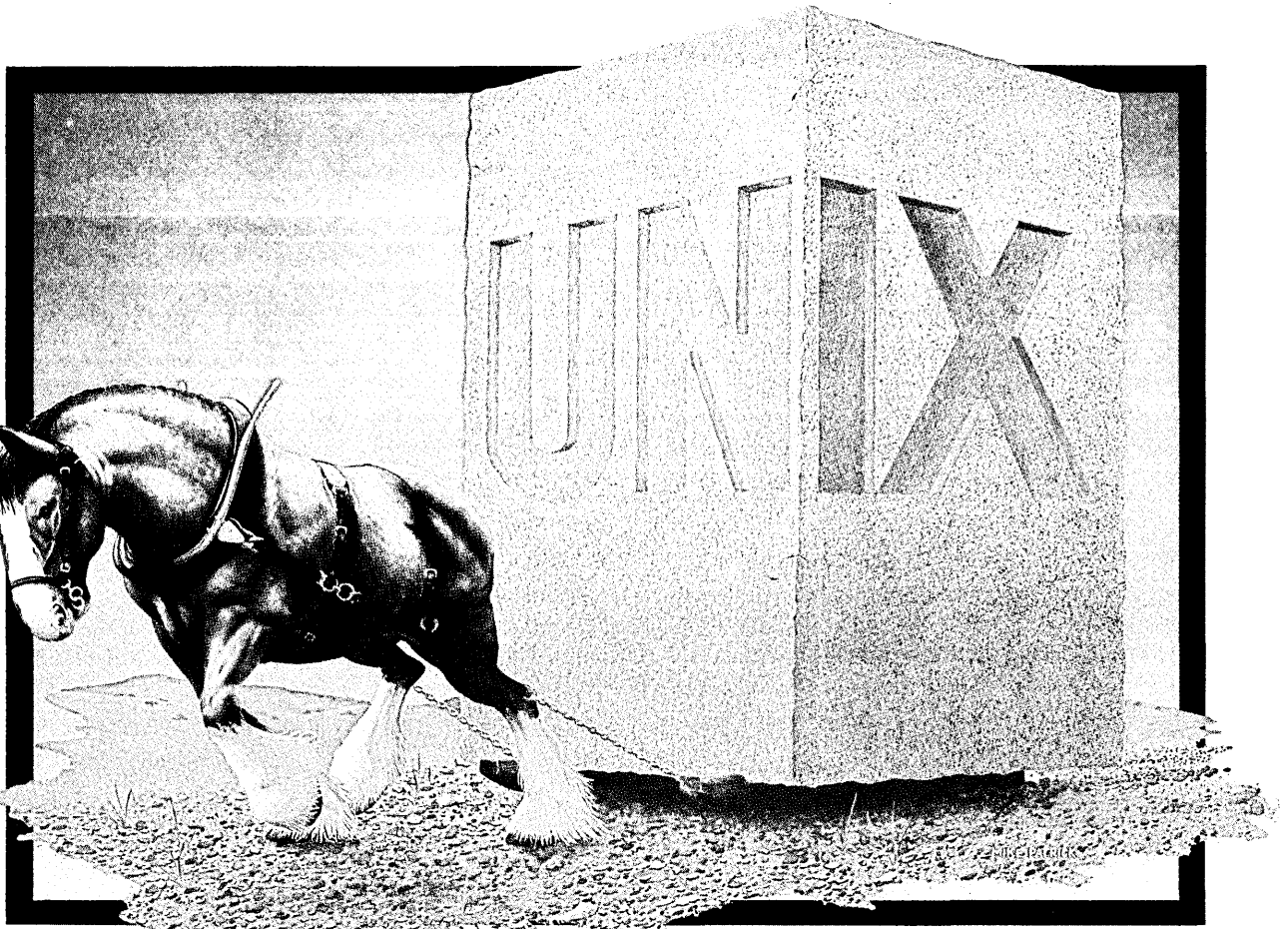

UNIX™ HORSEPOWER!

There are a lot of UNIX based systems on the market today claiming to be "SUPERMICROS". But do they really have what it takes to run multi-user UNIX well? The IBC ENSIGN™ does and here's why:

FAST MEMORY: No computer running at **any** clock speed can run faster than it's overall memory design. The ENSIGN has up to 8MB of 120nsec memory with dual bit error correction. With IBC's proprietary memory management, **all** of this memory runs with no wait states as fast as the 68000 CPU will go. Compare this to other systems running only small cache memories at full speed. Other multiple user systems cannot load all their programs into a small cache memory. Their systems slow down considerably under a heavy multi-user load.

INTELLIGENT SERIAL I/O CONTROLLER: Even the fastest CPU will slow down when it's trying to handle interruptions from multiple on-line users. The ENSIGN provides slave serial I/O CPU's **and** FIFO buffering for both input and output. The result is the ENSIGN's ability to support up to 32 users, with heavy serial I/O demand, while leaving the main 68000 CPU free to run with little serial I/O overhead.

INTELLIGENT DISK CONTROLLER AND HIGH PERFORMANCE DISK DRIVES: The ENSIGN has a slave CPU to handle all disk operations, **plus** 16K of disk buffering. IBC's proprietary disk DMA allows high speed data transfer to main memory without slowing down the main CPU. Further, the ENSIGN

supports SMD type 8" hard disks with much faster seek times and transfer rates than 5¼" hard disks usually found in personal desk top computers.

THE RESULTS: The IBC ENSIGN runs multi-user UNIX at performance levels not attainable by other supermicros.

Call IBC and get a copy of IBC's multi-user benchmarks—benchmarks that test 8 users running large CPU programs, with heavy disk I/O **and** heavy serial I/O simultaneously. You'll find that nothing can compare to the ENSIGN.

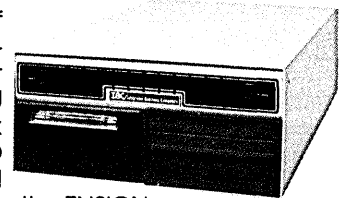

If you want to run multi-user UNIX on a high performance system with up to 32 users, 8MB memory, and over 1,000MB disk storage, see the IBC ENSIGN.

Outside The USA

IBC Integrated Business Computers

21621 Nordhoff Street
Chatsworth, CA 91311
(818) 882-9007
Telex No. 215349

UNIX is a trademark of Bell Laboratories

END USERS, CIRCLE 75 ON READER CARD
DEALERS, CIRCLE 76 ON READER CARD

The problem comes in how each version accommodates additional numbers of cylinders.

ring errors while reading from the disk. On standard ST506/412 disk drive and controllers the data separator is currently on the controller. ST412HP backers say that it should remain there. That way, in microcomputers with multiple disk drives, the circuit is not duplicated on each drive.

Opponents argue that this critical circuit should be located on the disk drive itself, especially when the drive is operating at a fast 10Mbps transfer rate. Here, the circuit can be optimized for each drive's individual operating characteristics. It would also enable drive manufacturers to achieve higher yields. Many disk failures in the field result from a drive simply being unable to work with just any controller's data separator. Says James Toreson, president of Hebec, "Current generation computer systems need better visibility of errors, higher data transfer rates, and more intelligence in the disk drive than is possible with the ST506/412 interface."

Critics of the ST412HP interface also point to its lack of support as evidence that the market wants more in an interface. The August 1984 issue of *Peripheral Concepts* made the following observation: "The controversial intelligent interface issue [ESDI vs. ST412HP] was solved at the show [National Computer Conference]: we saw no 412HP drives or controllers on the floor." Phil Devin of Hebec says, "With no large number of controller manufacturers beginning to supply product to drive this interface, this interface is dead."

A more impartial view of the interface controversy, however, is provided by Vertex Peripherals president Jim Adkisson, who is a supporter of both ESDI and the ST412HP. He believes the latter has a good chance of succeeding. "By the end of 1985 you'll begin to see ST412HP disk and controller products. In the final analysis, the ST506/412 and ST412HP will represent around 60% of the interfaces found on 5¼-inch drives. The remaining 40% will be evenly split between drives offering the ESDI and SCSI interface," he says.

ANSI INTERFACE SPEC

Yet another interface sect competing with both ESDI and ST412HP is the ANSI small computer system interface specification (SCSI). Rolf Brauchler, director of marketing at Quantum Corp., Milpitas, Calif., reveals his firm's intentions when confronted with the various persuasions from which to choose. "We studied what would be needed to produce a new generation Winchester drive in the 50MB to 100MB capacity range. If we were to continue using the ST506/412 interface, we would have had to increase the

number of platters inside the 5¼-inch form factor, or write more tracks on each disk surface, as many manufacturers have already done. Neither of these alternatives was attractive to us. We found a better option was to increase the bit density inside each track."

Once that decision was made, the company had to decide whether to go with a higher performance device level interface like ESDI and SMD, or to go with a more intelligent interface like SCSI and IPI. Brauchler says Quantum found the intelligent interface concept the more practical solution to its problem. In effect, implementing an intelligent interface like SCSI on a drive is the equivalent of putting a disk controller on the disk drive. The benefits are immediately obvious. "The question of data transfer rate is no longer an issue," Brauchler says. "In addition, the drive manufacturer has complete control over error detection and correction."

Another plus with the SCSI interface is that the computer system manufacturer is no longer troubled with changing its software drivers each time a disk drive characteristic changes. In addition, other peripheral components like tape drives, printers, and optical disks can be controlled with the same software drivers, thus greatly simplifying software support for a wide variety of peripheral devices.

One of the biggest pluses for the SCSI interface on board the disk, however, is a significant reduction in integration costs. "When a microcomputer manufacturer buys a disk drive and SCSI controller from outside vendors and integrates the two into a final product," says Tandon's Bob Abrahams, "it makes economic sense to buy a drive with the SCSI controller already on board."

Tandon is currently working with semiconductor manufacturer Western Digital of Irvine, Calif., to produce the LSI (large-scale integrated) circuits for the on-board controller. These LSI devices will allow Tandon to squeeze the SCSI controller on board the same printed circuit board that now holds the disk drive control electronics. Hebec is currently offering the capability in its Owl product. Phil Devin of Hebec says that the embedded controller will add \$100 or less to the price of the drive purchased in oem quantity. Contrast this to the \$180 price tag of a separate SCSI controller, and the savings become obvious.

Another trend with the SCSI interface is to offer a host adapter separate from the SCSI controller. By contrast, controller makers have been offering a combined controller and host adapter for a specific computer bus like the IBM PC bus or Intel

Multibus. If a host-specific controller is used, each peripheral added to the system must have its own host adapter. By comparison with every peripheral on the system having a controller offering the SCSI interface, one host adapter can service each.

"With the trend toward systems with disk, tapes, and printers, the use of SCSI interfaces on each makes sense," Devin says. In addition, many computer manufacturers are providing product with an SCSI port on their systems. Thus, the system integrator need not provide a host adapter at all. It's already on the computer.

"All that is needed now is for the system software vendors like Microsoft and Digital Research to begin providing drivers inside their operating systems for the SCSI interface," says Devin. "Thus, the integrators would not have to provide drivers themselves. Moreover, even when drives with higher capacity and operating features come available, these systems will be able to use the drive without having to rewrite software."

SCSI NOT TOTALLY PERFECT

All is not totally perfect with the SCSI interface, however. Some computer manufacturers claim the interface slows down the throughput of these systems. "From the time a command is initiated to the time it is carried out, there is a noticeable time delay, which is unacceptable among oems building an intelligent workstation, especially one used in graphics applications," says Peterson of Qualogy. A dedicated controller has little delay by comparison.

"However, what the oem must give up in using a dedicated controller is the ability to incorporate new drives as they become available," continues Peterson. "Instead, the oem is forced to write a new software driver for the new disk drive. The process takes several months considering all the debug time required by the process. By contrast, an SCSI controller would require only a few weeks of software development at most to adapt a software driver to a new disk drive product. But for the performance, many oems are willing to take the time.

What the oem Peterson speaks of really wants is an interface like the ANSI intelligent peripheral interface. IPI started out with a mainframe interface from ISS Sperry Univac Division of Sperry Corp., in Santa Clara. ISS, by the way, has since become Magnetic Peripherals Corp., Santa Clara, a subsidiary of Control Data Corp. Now much changed, the intelligent peripheral interface (IPI) has options that make it suitable for small computers and for small and

UNIX™
Update

Building New UNIX Networks

Mainframes to Micros

INTERACTIVE Systems Corporation and its OEMs are introducing a series of new products that allow users to distribute their computing tasks among central computers, departmental computers, and personal computers running UNIX and/or PC DOS.

Announced To Date

First, INTERACTIVE introduced the Workbench (IS/WB) and IS/3 systems for distribution by its own sales force to DEC users. IS/WB is a set of key UNIX tools running as extensions to DEC's VMS operating system. IS/3 is an enhanced version of the standard AT&T UNIX operating system for PDP and VAX computers. Both support INed, a proprietary full-screen editor that is the primary user interface on all INTERACTIVE operating systems. Both systems also support INmail, an electronic mail system, and INnet, a networking package that links computers so that they share resources and exchange mail.

At the 1983 Fall COMDEX, SCI Systems demonstrated a new family of multi-user microcomputers (SCI 1000) running IN/ix, which is a version of IS/3 with INed. SCI offers INmail and INnet as applications.

At the UNIFORM show in early 1984, IBM demonstrated PC/IX, a version of IS/3 with INed, on the IBM PC XT, IBM PC XT/370, and the IBM PC with Fixed Disk Expansion. At the same show, INTERACTIVE demonstrated software that allows personal computers running PC DOS to act as intelligent terminals to any system running INed.

In June, IBM announced that INmail, INnet,

and INfort, INTERACTIVE's Fortran 77 compiler, were available as applications for PC/IX. In July, IBM announced VM/IX, a version of IS/3 with INed, which runs as a guest operating system on their Virtual Machine/System Product (VM/SP). And at the fall Expo '84 in LA and UNIX Expo in NYC, IBM announced and demonstrated PC/IX on the new IBM Personal Computer AT.

The Net Effect

INTERACTIVE is the only company to offer a complete network of UNIX-based operating systems, utilities, and applications for building corporate communications systems. Our products provide compatibility across a wide range of processors, making virtually any configuration of PC's, minis, multi-user micros, and mainframes possible. We are also unique in offering full-service support and maintenance, as well as extensive training programs to assist our customers in implementing UNIX networks.

Watch for more on our latest developments in the next INTERACTIVE UNIX Update.

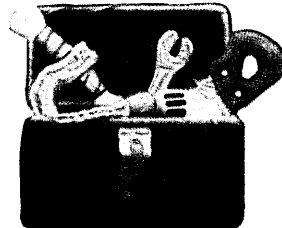

Software Tools for System Builders.

For more information, contact:

INTERACTIVE
SYSTEMS CORPORATION

2401 Colorado Ave., 3rd Floor

Santa Monica, CA 90404

Telephone (213) 453-UNIX

TWX 910-343-6255; Telex 18-2030

See us in Booth 1541 at UNIFORM in Dallas,
Jan. 21-25.

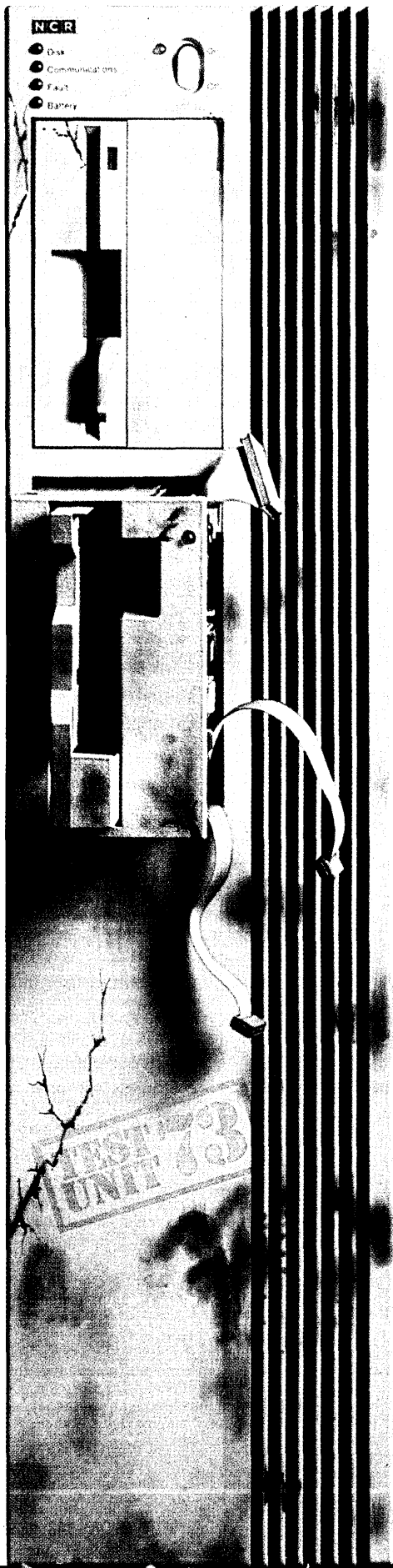

INTRODUCING TOWER XP. NOW THAT WE'RE THROUGH WITH IT, YOU CAN HAVE IT.

Reliability has been the hallmark of NCR products for over 100 years. But what began as a virtue has, quite frankly, become somewhat of an obsession.

Pick. Pick. Pick.

Before our reliability engineers allow our new Tower systems out the door, they do a little testing.



A little testing.

They burn in 100% of memories, processors and complex VLSI assemblies upon arrival. They burn in the assembled boards. Then, they give the finished unit an extensive burn-in over a wide range of temperatures.

They test the unit against NCR's rigid standards for electromagnetic interference (EMI), radio frequency interference (RFI) and electrostatic discharge (ESD).

And when they're finished performing more QA than any other manufacturer would dream of (an average of over 200 hours per unit), they start

testing features that other manufacturers *only* dream of:

Consistent error-logging.

Extensive in-service and remote diagnostics.

Automatic Power Failure Recovery.

A UNIX[™] operating system that virtually never PANICs.

And more.

Tower XP gives your customers the power of a 68010-enhanced CPU, up to 260MB of mass storage, 45MB of 1/4" cartridge tape built into the CPU cabinet, industry-standard interfaces and a UNIX of truly commercial reliability.

Tower XP. Now that we're through with it, your customers will never have to settle for anything less.

**TOWER XP.
BUILT FOR SYSTEMS BUILDERS
BY NIT-PICKING FANATICS.**



OEM Systems Division

CIRCLE 78 ON READER CARD

"With no large numbers of vendors beginning to supply product . . . this interface is dead."

slow peripherals. Yet it still offers compatibility with U.S. government mainframe interface standards derived from the input/output channel architecture of IBM's System 360/370 mainframe computers, and with the large computer's giant storage systems.

IPI has been around for some time without garnering as much widespread support as the SCSI or de facto standards that have come into being since IPI was first proposed. What bodes well, however, for the final canonization of IPI is the growing interest of IBM, among others, in the establishment of the interface as a standard. Joseph D. Joworski, president of Peripherals Concepts, says, "It seems that the IPI is finally on its way to stardom. The IPI level-2 implementation offers the needed functionality to be a natural extension of the overworked SMD interface. The interface is getting silicon support from Emulex Corp. in Costa Mesa, Calif.; tape drive support from Cipher Data Products Inc. in San Diego; and disk drive support from Priam Corp. in San Jose. The big question is whether IBM will use the interface on their oem disk offering when it comes out. The latest rumors we hear are favorable."

The only impediments to rapid,

widespread acceptance of IPI are the recent enhancements made to the SMD (HMD) interface. Harvey Wallace, vice president of operations at Spectra Logic Corp. in Mountain View, Calif., says, "The recent extensions to the SMD interface could forestall near-term acceptance of the IPI interface, or the SMD updates might simply serve as a stopgap solution while the IPI is more fully developed." He agrees that IBM's adopting the IPI for its use will also spur its acceptance as a standard.

Perhaps the closest thing to an established religious movement for canonizing interface standards in the computer industry in general is ANSI. ANSI's better known successes so far have been the SCSI, and more recently the IPI. Both, however, were initiated outside of ANSI. SCSI came from Shugart Corp. in Sunnyvale, Calif., where it was known as the Shugart Associates System Interface. It became a de facto standard thanks to the efforts of both Shugart and NCR Corp. ANSI's panjandrum, however, are notoriously inept at formulating interface dogma. Rather, they tend to sanctify what the industry has already declared a standard.

ANSI's one great effort at establishing a disk interface standard turned out to be

one of the greater failures in the computer industry. It was officially known as the ANSI H3T9.3 1226 specification. There was a brief and abortive effort in July 1983 by Priam Corp. and Hebec to use the standard for the high-performance, high-capacity 5¼-inch interface in lieu of ESDI. The effort never got off the ground. The interface has been relegated to obscurity as early supporters like BASF Systems Corp., Bedford, Mass., and International Memories Inc., Cupertino, Calif., leave the hard disk business or, like Micropolis Corp., switch their allegiance to ESDI.

Hebec president James Toreson, and Priam president William Schroeder argued unsuccessfully for the interface as follows. "First, ANSI is already in existence. It is a proven, reliable, flexible interface. It has the support [at that time] of numerous 8-inch Winchester makers and disk drive controller companies, as well as major semiconductor firms, who are already shipping integrated circuits that are ANSI-compatible.

"Second, it is directly applicable for use with today's 5¼-inch drives. Disk drive manufacturers will be able to implement the ANSI standard for essentially the same low cost as the proposed ESDI standard, and users will get a more flexible, longer-lived interface that will be less expensive and cumbersome to implement.

"Third, it will support the higher data storage capacities and faster transfer rates planned for future drives, which means manufacturers will be able to get these new drives into the market in much less time and for significantly lower development costs."

As time has shown, their arguments fell on deaf ears. So much for logic. So much, too, for the power of ANSI to establish standards.

What speaks so eloquently about the religious nature of interfaces is that despite its superior economic and technical merits, the ANSI 1226 interface lost the battle for acceptance to the ESDI and ST412HP, both of which had considerable private sector backing. The former is being pushed by Maxtor, Vertex, Control Data Corp., and Memorex in Santa Clara, to name only a few. The latter is being pushed by Seagate and Tandon, the two who previously made the ST506/ST412 an industry standard.

Thus we see that like a religion, faith in disk drive interfaces need not be founded on efficacy or facts, but more on perceived self-interest, which is often belief in the reality of illusion. ©

David Morris is a New York-based freelance writer.



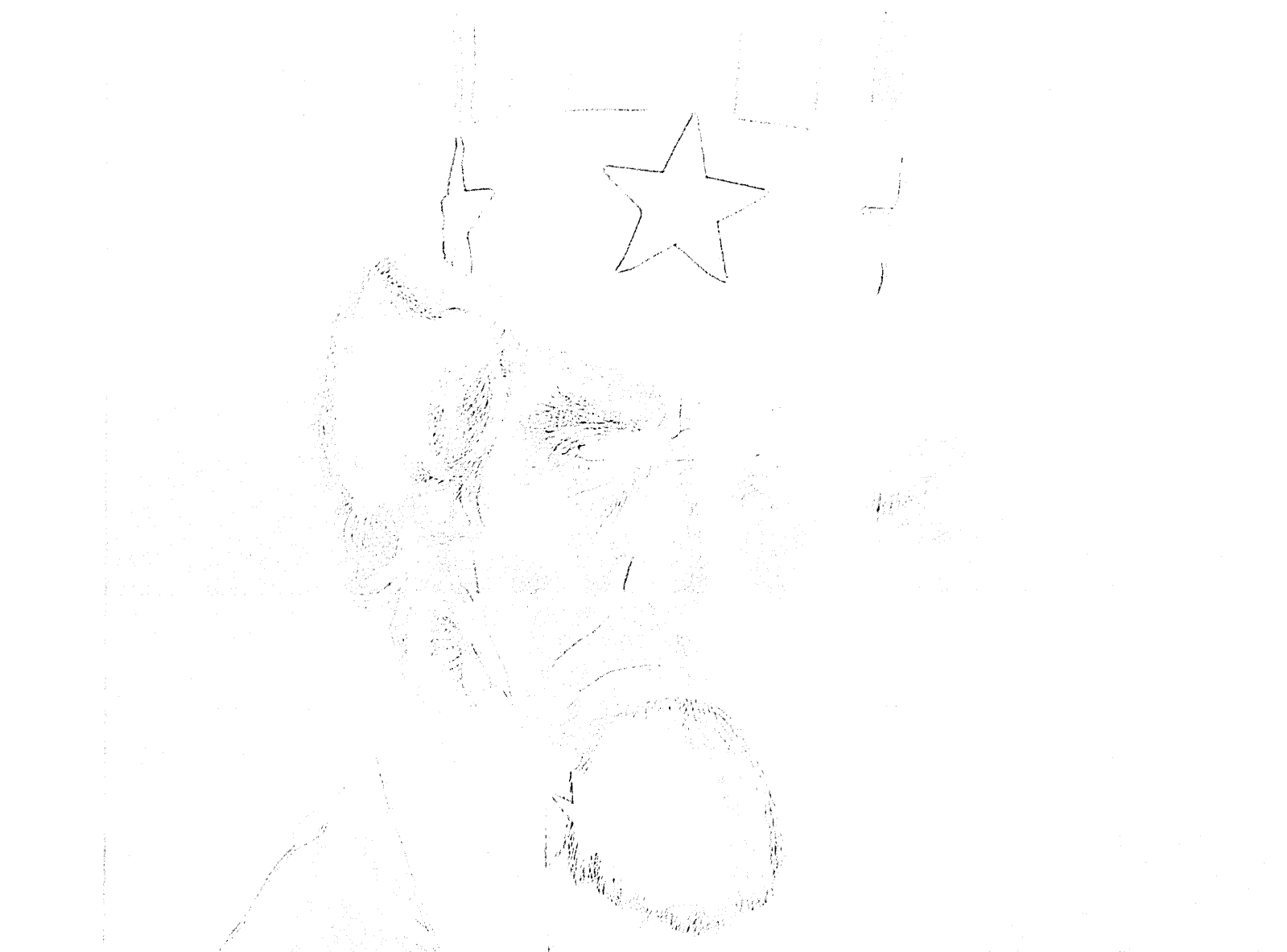

The UPS manufacturer that caters to the toughest customers.

Some UPS manufacturers have two standards of quality—the ultra-exacting quality specifications for their government contracts, and the “other” quality they give their commercial customers. But not at GPS.

At General Power Systems, we know that only one customer is tougher than Uncle Sam—you, the OEM. That's why *all* GPS uninterruptible power supplies, both on-line and standby, are designed, produced, tested and inspected with the same stringent standards applied to our defense products. Components are traceable, reporting is exact, testing is multi-level and burn-in complete.

The result is the highest quality standards in the industry's most complete line of UPSs—the only UPS products directed specifically to OEM requirements. GPS on-line models span the range from 500VA to 50KVA, while standby units from 100VA to 2KVA are available. Inquire about our full line of options plus OEM customization.

All GPS uninterruptible power supplies have the high reliability, transistor technology pioneered by GPS, plus state-of-the-art operating features. Unusually fast transient response, low output impedance and excellent efficiency characterize the on-line models. Standby units have set the standard with 2ms transition time.

Don't settle for second rate quality. Buy the UPSs that meet the toughest quality standards in the world by General Power Systems.

Call or write today for complete information. General Power Systems, 1400 N. Baxter St., Anaheim, CA 92806-1201, (714) 956-9321. (800) 576-1166. TELEX 182283.

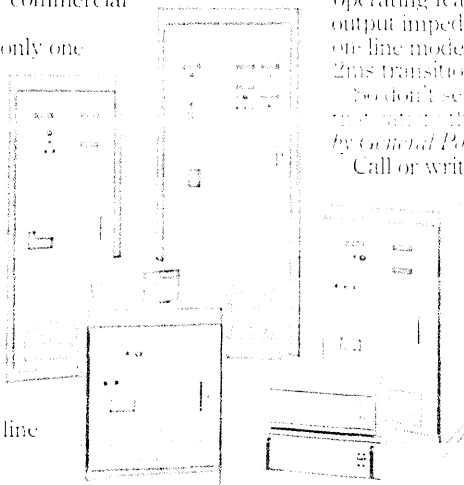

General Power Systems
1400 N. Baxter St.
Anaheim, CA 92806-1201
(714) 956-9321
(800) 576-1166
TELEX 182283

A Division of ALS Corporation

CIRCLE 79 ON READER CARD

THE
ASIAN
COMPUTER
MARKET
IS
EXPLODING



ANNOUNCING
COMDEX™
IN *JAPAN '85*

March 26-28, 1985
Harumi Exhibition Center
Tokyo, Japan

COMDEX in JAPAN '85 is the only
computer exhibition organized exclusively
for Asian Independent Sales Organizations (ISOs) and
the producers of computer and related products from around the world.

Do business with professionals who can recognize the profit potential of what you offer.
Do business with professionals who can best present your products to their end-user customers.
Do business with professionals who know and understand local, regional, and national differences.

Exhibiting at COMDEX in JAPAN '85 is the cost-effective way to build, expand, or upgrade
the distribution and sales network that you need to capture your share of this dynamic growth market.

For more information call toll free (800) 325-3330. (In Massachusetts, call (617) 449-6600.)
Or write Exhibit Sales, COMDEX in JAPAN, 300 First Avenue, Needham, MA 02194.

Presented by



THE
INTERFACE
GROUP, Inc.

World's leading producer of computer conferences and expositions including: COMDEX/Winter, COMDEX/Spring, COMDEX/Fall, COMDEX/Europe, COMDEX in JAPAN, FEDERAL DP EXPO & CONFERENCE, INTERFACE, The Nationwide COMPUTER SHOWCASE EXPOS, BYTE COMPUTER SHOWS
300 First Avenue, Needham, Massachusetts, USA 02194 • (617) 449-6600 • Outside Massachusetts (800) 325-3330 • TELEX-951176 • TWX-710-325-1888
In Europe: Rivierstaete, Amsteldijk 166, P.O. Box 7000, 1007 MA, Amsterdam, The Netherlands • Telephone 31-20-460201 • TELEX - 12358NL
In Japan: Kashiwabara Bldg. 2F 1-3-3, Kyobashi, Chuo-Ku, Tokyo 104 • Tel. 03-271-0246 • FAX 03-271-0248 • TELEX 25845 SIMPLE

Wang gives ISO's a powerful combination.

Most big computer companies can only hit you with data processing, data processing, and more data processing.

But at Wang, we take a different approach.

Wang doesn't just give you data processing capabilities. We also give you world leadership in office automation. And that gives you a big advantage over your competitors—as well as an opportunity to sell where you've never sold before.

With Wang, you get the total business solution: data processing, word processing, communications, plus a complete line of computers (our VS series) that are compatible with each other, with IBM, and with all your customers' information processing needs.

You also get the impact of Wang's national advertising, the support of our field service network, and the full cooperation of our marketing staff.

So send in the coupon below today or call (617) 967-5993.

We'll show you how Wang can help you score a technical knockout.

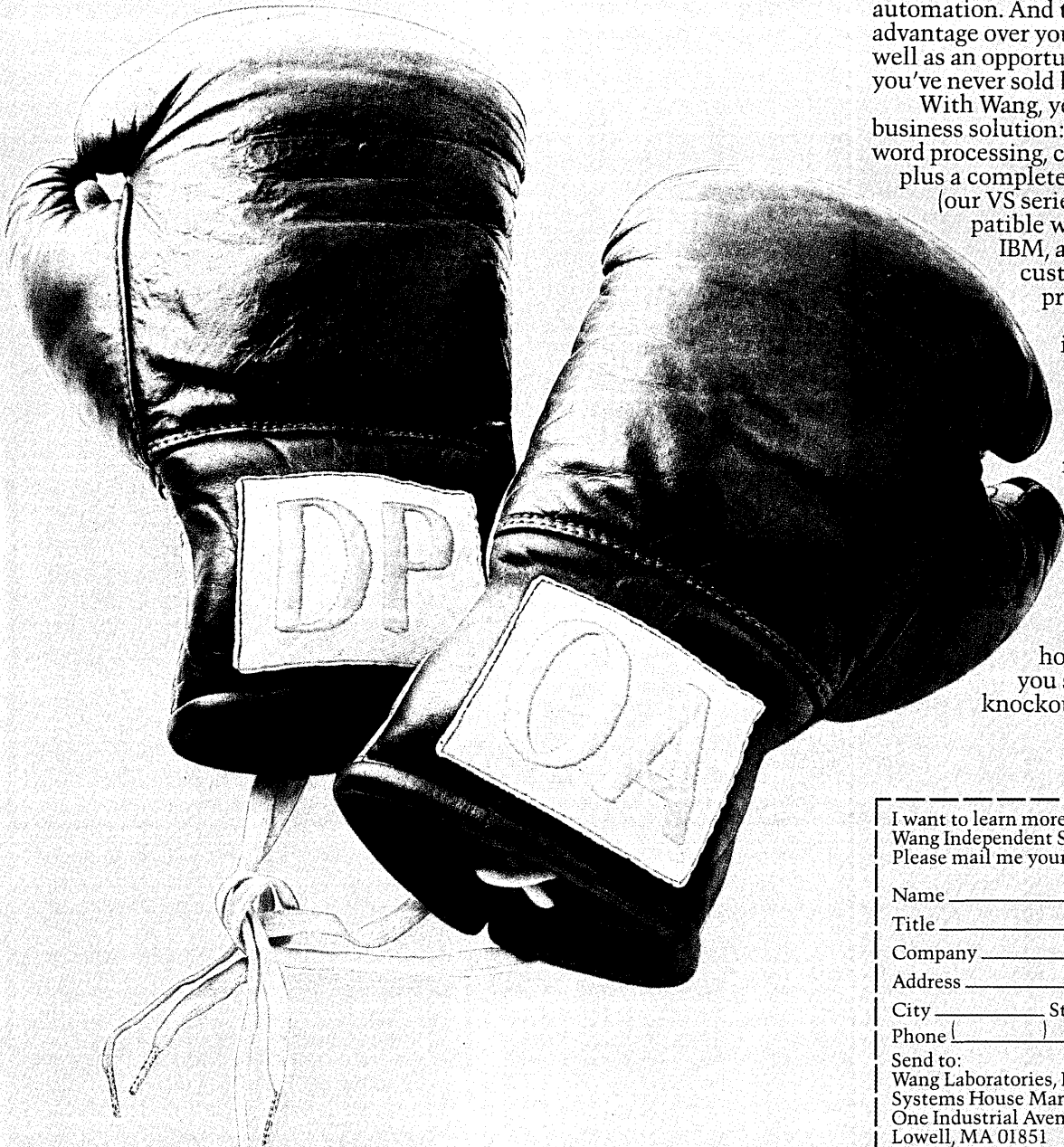

I want to learn more about becoming a Wang Independent Sales Organization. Please mail me your free brochure.

Name _____

Title _____

Company _____

Address _____

City _____ State _____ Zip _____

Phone (_____) _____

Send to:
Wang Laboratories, Inc.
Systems House Marketing, M/S 1408C
One Industrial Avenue
Lowell, MA 01851

WANG

We put people in front of computers.

Character	CPI-Line	CM-Inch
Pitch	126	10
PITCH (ENLARGED)	30	3
PROPORTIONAL	8	8
PROPORTIONAL (ENLARGED)	200	17
CONDENSE	110	8.0
CONDENSE (ENLARGED)	142	12
WIDE	91	8.8

If you've only seen our fine print, you're missing some great lines.

When people try C.Itoh Electronics' high performance daisywheel or dot matrix printers, they're quite impressed. So impressed, in fact, that our line of printers just may be the most widely used in home and business—nationwide.

But our commitment to the electronics industry doesn't end there. You see, we also offer OEM's and end-users a wide variety of state-of-the-art electronic products. All with the same reliability and performance that has everyone talking about our printers.

For starters, there's our line of clearly superior Liquid Crystal Displays. Thin, lightweight and compact, they come in an almost endless array of modules to satisfy virtually any application.

Then there's our selection of Mini-floppy and Microfloppy Disk Drives. They offer exceptional reliability and easy-to-integrate high density storage.

We sell a full range of CRT monitors, too. And each delivers unprecedented levels of character clarity.

Finally, there's our CIE 2400/3600 plotters. Available in 24- and 36-inch models, they provide the fastest 400 DPI performance on the market today.

Of course, it takes more than a great product to make a sale. There's also that little intangible called

working with the customer. And work with you we will. To develop products that meet your specifications.

In addition to developing and marketing our own unique lines, we buy products from many U.S. and international manufacturers and sell them to the worldwide

market. So you can benefit from a world of experience and the latest developments.

We also recognize the importance of outstanding support to all of our customers—OEM's, Systems Integrators, Distributors, or End-Users. And don't forget the solid backing of C.Itoh, our \$60 billion parent company with 125 years of experience and offices worldwide.

So call or write C.Itoh Electronics for more information on our lines of high performance printers, LCDs, disk drives,

CRTs, or plotters. And find out what you've been missing. C.Itoh Electronics, Inc., Headquarters, 5301 Beethoven St., Los Angeles, CA 90066, Tel (213) 306-6700, Telex 65-2451, TWX 910-343-7446, FAX (213) 390-1188.

C.Itoh Electronics, Inc.



There's gold in those value-added hills for vars doing a brisk business with AT&T's new unregulated Information Systems division.

BABY BELL'S BONANZA

by Claiborne J. Cordle

As many as 15,000 American firms are doing business as value-added resellers, and many of them owe their survival to big-time mentors like Digital Equipment Corp., Data General, and IBM. A year ago, AT&T's divestiture added another hefty vendor to that list, a division first nicknamed Baby Bell and now formally known as AT&T Information Systems. This totally unregulated heavyweight is actively competing for the attention of computer systems vars. Association with AT&T IS via purchase and remarketing of the 3B family of computers and/or the PC 6300, for example, could mean mouth-watering returns for vars who can make the grade.

How does a var qualify for an AT&T IS var program? What's AT&T IS actually looking for in the way of a partner? What's in it financially for you as a var? And how do you get started with a behemoth that is just entering the computer marketplace? Here are some answers.

A handful of fortunates was secretly recruited even before AT&T IS announced its entry into the business last March. Two major consulting firms quietly approached Washington, D.C.-based M/A-Com Information Systems in April of 1983, recalls Mike Abramovitz, vice president of the firm's marketing and sales support effort. "They didn't tell us who they were representing," he says. "They barely told us about the marketplace that this new company was going to get into. There were a couple of hints as to who they might be, like it was a multibillion-dollar corporation. I asked whether it was on-shore or off-shore, and when they said on-shore I kind of felt that it might be an AT&T." Interviews continued through the summer and in September M/A-Com signed a nondisclosure agreement. Then AT&T presented its position in person and the var agreement was negotiated. "When AT&T announced, we had at least a dozen packages ported over to their equipment, which added to our credibility," says Abramovitz.

But don't let M/A-Com's experience tempt you to put your feet up on the desk and wait for the phone to ring. Now that they've announced, you've got competition for those valuable var agreements, and while AT&T IS is still contacting companies their market research tells them are strong in certain vertical markets, your best chance to be noticed is to make the initial contact yourself—by phone, by mail, or at any of the numerous seminars and conventions where their wares are displayed. Be prepared to answer questions.

"Say you're a small var—we'll say \$5 million, somewhere in that range—and you make contact with us," begins Rick Morris, director of sales and customer support for AT&T IS's Computer Systems division in Lisle, Ill. "We'll explain to you the qualifying criteria. We'll ask you for a business plan. What kind of business relationship do you envision? What is it you would like to do with us? How do you intend to market our product and yours together? Where do you want to market that? Those are the kinds of elements that go into a business plan. That business plan can be anything from four or five pages long. I've also seen them an inch thick, depending on the company and whether they're national or regional," he explains.

If the Morristown, N.J.-headquartered AT&T IS is interested in your proposal, then you'll be asked to supply a certified copy of your financial statement. Following that, Morris continues, "there is an agreement that establishes the terms and conditions under which we will do business, and the discount appropriate to the level of business that you command."

Charles Redmond, general manager of the AT&T IS var program, is more explicit in his expectations of potential vars. "I'm going to ask you to tell me where your expertise lies in terms of specific vertical and/or horizontal applications. I'm going to ask you what you've demonstrated in that market thus far, what you've delivered, what you've written, and what kind of end users you now serve—and how many.

How large are you in terms of capitalization, sales force, market area? I'll want to evaluate your business plan from a financial perspective as well as from the perspective of what market niche you've targeted, and how viable that concept is. I'll want to see your software and/or hardware integration capability. I'll want to certainly understand your long-term goals as well."

MUTUAL PROFITS SOUGHT

Long-term goals are important to AT&T IS because, as Redmond explains, "We're not looking to sign on partners for six months or a year. We want to be working with the people we pick for years to come. We envision a relationship that is mutually profitable with no real end in sight." Already, notes James Edwards, vice president for strategic planning at AT&T Technologies, oem/var revenues will reach \$200 million in 1984.

From your perspective as a var, the long haul is important because you need to be sure that your objectives are compatible with those of AT&T IS. "Find out what their long-term products plans are," advises Herb Weiner, president of Omnicad, a Rochester, N.Y.-based AT&T IS var offering mechanical drafting software on the PC 6300 and a printed circuit board design system on the 3B5. "IBM has a history of things that they have to support, so if you become an IBM var, and you base your strategy on already available IBM equipment, you know they'll be able to support it. AT&T IS has a limited product line right now," Weiner cautions, "and you'd better make sure that your strategy fits into it."

It helps if your added value is in a vertical market in which AT&T has been traditionally strong. They are looking for applications in finance, health and medicine, transportation, education, factory automation, engineering and science, retail and wholesale distribution, and, of course, communications.

It also helps if you have contacts. In Omnicad's case, Weiner had years ago met

“We’ll ask you for a business plan. What kind of relationship do you envision?”

Jim Edwards, president of the Computer Systems line of business within AT&T Information Systems. “I called him up, not even knowing they were going into the computer business,” Weiner says, “and told him we’d like to do business with AT&T. That was in late spring, early summer, of ’83, and he put me in touch with Jack Scanlon [then head of the Computer Systems division at AT&T]. Things evolved from there.”

Also, by a kind of prior association, several of the Bell telephone companies, including Sonecor Systems, the unregulated New Haven-based division of Southern New England Telephone, and Cincinnati Telephone, were able to establish early var relationships simply by renegotiating the contracts they had with AT&T as part of the old Bell system.

One sure way to get the giant’s attention, though, even without privileged connections, is by demonstrating special competence in Unix. The operating system is at the heart of AT&T IS’s computer systems commitment.

Despite the assertion in one industry newsletter that Scanlon’s Unix-driven Computer Systems division was dealt a major blow when AT&T IS won corporate approval to offer the MS/DOS-based 6300 desktop, AT&T’s Redmond insists that the Unix commitment is as strong as ever, and he rejects the prediction that the absorption of CSD by AT&T IS will diminish AT&T IS’s long-standing promotion of System V as a universal standard.

Says AT&T IS’s Redmond, “AT&T IS vars probably buy from us anywhere from 10% to 50% of their total cost of goods sold. You could probably double that to come up with a revenue figure. And the great majority of that will be in 3Bs. That’s because the strategy for vars is to get Unix software developed, which vars are particularly well equipped to write. Their understanding of those end users, and their high expertise in vertical markets, are why we’re engaging them. The MS/DOS market is perhaps not as stable and long term a market as the Unix market. Unix is the mainstay of our product line. It’s very much at the core of what we’re doing. We’re most interested in companies that have developed specific packages that are Unix-based,” Redmond says.

WHAT EXPERTISE CAN MEAN

Feith Systems and Software in Philadelphia, whose added value is software for manufacturers and wholesale distributors, is a good example of what Unix expertise can mean to a var. Feith was originally an OASIS systems house that had been working with a Toron-

to company called UX Software that had developed a version of BASIC called UX-BASIC. “It’s like OASIS BASIC running Unix,” explains Donald Feith, company president. “That means all the software on the OASIS operating system can come over to Unix without modifications.”

As the agent for UX Software, Feith sold AT&T IS UX-BASIC, and became an AT&T IS var in the process. “We were approved because with our expertise in moving stuff from the OASIS operating system to Unix, all OASIS-based application software could move to the 3Bs through us. We’re working with some 400 OASIS systems houses worldwide that have about a thousand vertical applications, so it opened up that whole software market to the 3B family through us and UX-BASIC,” Feith boasts.

If you’re not a Unix specialist, don’t despair. AT&T IS basically expects two things from its vars: a solid system that adds real value to its equipment, and evidence that the company is not going to shrivel up and blow away at the first sign of a dry spell. “They don’t want their product to be embarrassed in the marketplace,” says Sonecor’s Donald Haag, director of engineering and strategic planning. “They don’t want to end up having to take all the service calls on a lot of products because the person who supplied them doesn’t do his job.”

Assume now you have successfully navigated the sea of var program criteria and have reached the contract negotiating stage. What happens then? “It’s a standard oem deal,” says Omnicad’s Weiner. “With a forecast done over a period of time, you agree to a quantity and you get a discount according to a schedule.”

The discount may vary, depending on what AT&T IS provides and what the var provides. For example, says Haag, “If I take product that doesn’t carry the name of the company and I don’t benefit from national advertising, then I’d like to get that cost out of the systems I buy.” Sonecor negotiated for other things as well, he remembers. “One of the things we wanted was to have access to all future products. We also wanted a long-term relationship, not a one-year relationship. And we wanted to be able to count very strongly on their support for our customers.”

Once the agreement to cover general business terms and conditions is in place, other decisions have to be made. “We sat down and worked with them,” Haag explains, “about how we would be able to sell the products, how we would get people trained on the products, how we would get product information, how we could get information software they had from third

parties—that type of thing. And now what we do is send down a forecast of the equipment we intend to sell in the next quarter and then we roll the forecast out on a month-by-month basis.”

CLOSING CAN TAKE MONTHS

According to Morris of AT&T IS, the closing of the contract up front can take anywhere from a couple of weeks to two or three months. In some cases, where the contracts are complex, it can be six months. For Sonecor it was three months. “At any rate,” Morris says, “at the end of nine months, the typical var will be ready to go to his marketplace with the joint product. At that point, the cooperative advertising, the joint sales calls, etc., would take place.”

So far, the process of becoming an AT&T IS var sounds not much different from becoming a var for anyone else. But the AT&T IS var program has a new twist—the introduction of what it calls the “master value-added systems distributor” to handle dealings with small- to medium-sized vars, leaving AT&T IS free to concentrate on the very large var accounts. Ultimately, AT&T IS’s plan is to use a number of regionally oriented master vars, which will focus on market penetration in their respective geographical territories. Currently, though, AT&T IS has enlisted only one super var—Ducommun Data Systems Inc., a Cypress, California-based division of Ducommun Inc., a multifaceted Los Angeles corporation with 1983 revenues of \$304 million.

Ducommun Data Systems is in effect an extension of AT&T IS and represents its response to what it perceives as changing distribution channels in the computer industry. Ducommun is chartered nationally to provide a marketing and support operation for smaller vars, and also to provide other add-on equipment for the machines of AT&T IS. “Only incidentally is it involved in distribution,” Morris says.

A var’s size determines whether it will work with a master var or directly with AT&T IS. “The strategy for using master vars such as Ducommun,” Redmond explains, “is that the cost of sales for us to handle the medium and small vars—those that at this point may only do, say, below \$5 million worth of business on an annual basis—might be a little too high for us to do profitably.”

Those large vars have special characteristics, adds Ron Jacobs, executive vp and general manager for Ducommun Data Systems. “They will probably do some level of service themselves. They’ll probably be national in scope. Their purchasing practices will have to be monitored closer just

YOUR BRAINS. OUR GUTS.

Parallel port included. Standard interface for popular printers.

Five full-length expansion slots for IBM PC/XT compatible option cards. Hard disk machine with 640K, real time clock, three I/O ports and display has two slots free.

Small overall dimensions, sturdy metal case, designed inside and out with horizontal or vertical operation in mind.

ROM BIOS AND MONITOR by ITT: Interrupt compatible with IBM PC/XT and more. Ever-ready menu-driven, diagnostic monitor debugger. Test hardware device by device and channel by channel. Examine registers, alter or dump memory, read or write tracks and sectors. Even set drive timing.

256K byte, parity-checked RAM on planar board. Combo board with one, two and three banks of 128K bytes each. Real time clock and parallel port also available to give 640K RAM total with only one slot used.

Serial (RS-232) communications port built in. Console I/O may be redirected to this port by switch setting. Menu-driven DOS utility (set up) to configure this port or redirect printer I/O to it. Communications program included.

ITT's own heavy duty, high efficiency, switching power supply (115 watts continuous service) saves weight without compromising support for fully-equipped machines. 95 to 132 volts or 180 to 240 volts.

Switch controls allow console I/O redirection to serial port — use whatever ASCII terminal you want. Enable/disable power-on memory test for faster starts on large machines. Enable/disable screen-saving blanking when left idle.

Floppy disk controller on planar. Saves a slot.

Space-saving half-height disk drives.

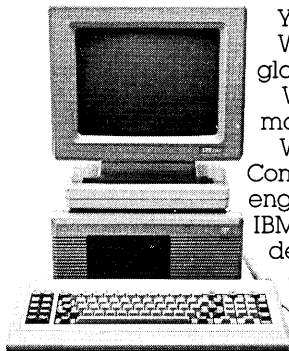
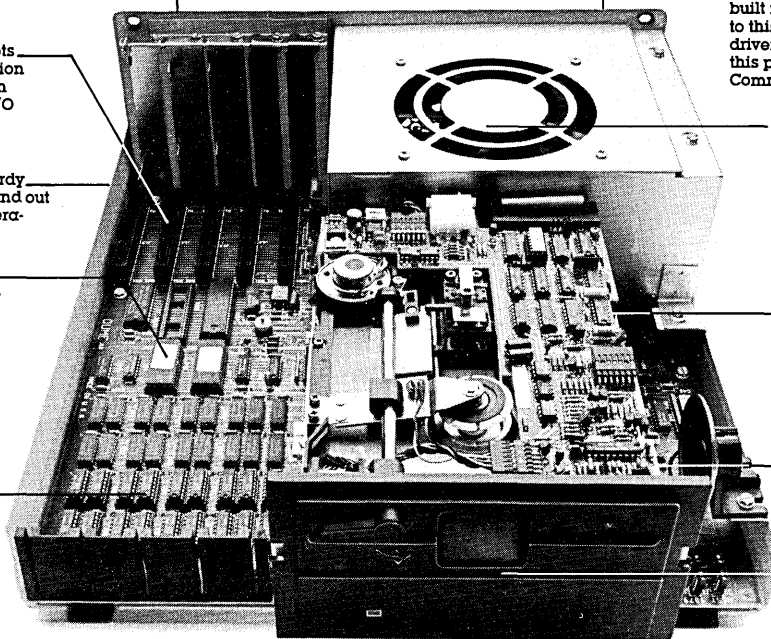

Monitor conveniently tilts and swivels. Green, amber or color. Three-position keyboard. Our very own, fully-supported ITT Mouse.

Brains.
So if you're interested, we're interested.

You know your marketplace. We know computers. A quick glance above will tell you that.

Which could obviously mean a match made in VAR heaven.

What will the ITT XTRA™ Personal Computer bring to the party? The best engineered system in the industry. IBM compatibility. Phenomenal dependability, flexibility, serviceability. All from a \$20 billion company committed to profitable partnerships with its resellers.

Guts.

What will you bring? The specific knowledge that can help us both tailor a useful tool for a specific market. For both large and small VARs.

Give us a call today at 800-321-7659. Or clip the coupon. It may well be the smartest thing you ever do. It's certainly the gutsiest.

IBM PC and XT are registered trademarks of International Business Machines.

Please send me more information on the ITT VAR Program.

Name _____ Title _____

Company _____

Address _____

City _____ State _____ Zip _____

Phone _____

Donna Sim
ITT Information Systems
P.O. Box 52016
Tempe, Arizona 85072-2016

ITT
PERSONAL COMPUTERS

HELPING AMERICA WORK SMART.

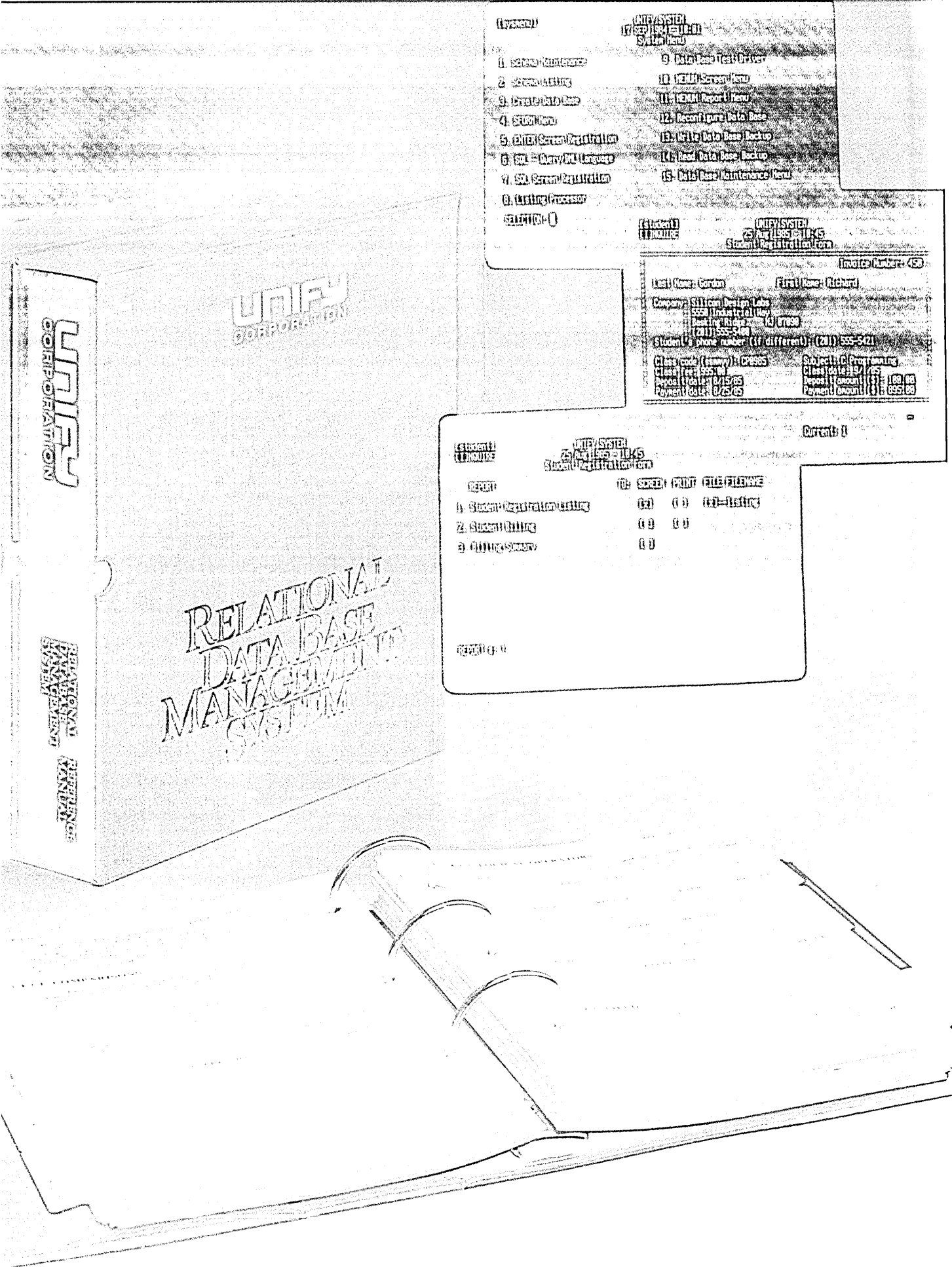

UNIFY SYSTEM
17 SEP 1984 11:01
SUNLAND

1. System Maintenance	9. Data Base Test Driver
2. System Backing	10. Data Base Screen Load
3. Create Data Base	11. Data Base Report Menu
4. Screen Load	12. Reconfigure Data Base
5. Data Base Screen Configuration	13. Data Base Backup
6. SQL - Query/SQL Language	14. Data Base Backup
7. SQL Screen Configuration	15. Data Base Maintenance Menu
8. Listing Processor	

UNIFY SYSTEM
25 OCT 1985 10:45
Student Registration Form

Image Number: 430

Last Name: Gordon First Name: Richard

Company: Silicon Design Labs
 555 University Blvd
 Austin, Texas TX 78758
 (214) 555-5111

Student's phone number (if different): (214) 555-5421

Class code (new): CS285 Subject: C Programming
 Class Fee: \$55.00 Class date: 9/7/85
 Deposit date: 8/15/85 Deposit amount (\$): 188.00
 Payment date: 8/25/85 Payment amount (\$): \$55.00

UNIFY SYSTEM
25 OCT 1985 10:45
Student Registration Form

Current: 0

REPORT	ID	SCREEN	PRINT	FILE	FILENAME
1. Student Registration Entry	(0)	(0)	(0)	(0)	REG-ENTRY
2. Student Billing	(0)	(0)	(0)	(0)	
3. Billing Summary	(0)	(0)	(0)	(0)	

0220 0 0

*UNIX is a trademark of AT&T Bell Laboratories.
 UNIFY is a trademark of Unify Corporation.
 Copyright © 1984, Unify Corporation, Lake Oswego, OR 97034

UNIFY. THE MIGHTY EASY DBMS.

UNIFY isn't only the fastest and most powerful of all UNIX*-based data base management systems—it's also one of the simplest to use. Which is why some 75 percent of those who see our manuals and buy a DBMS, buy UNIFY.

UNIFY guides the nonprogrammer through data base development with minimal steps, comprehensive menus, on-line HELP, elementary Query By Forms capability, and clear documentation.

UNIFY expedites applications development for users of all skill levels with features like PAINTE, for effortless forms design; SQL, the powerful, English-like query language; and a menu-handler that lets you quickly compile screens, queries and reports into menus customized to each user.

And for the skilled programmer, UNIFY offers the most extensive host language interface, for limitless flexibility when you need it.

All of which makes it mighty easy to see why UNIFY has been selected by more computer manufacturers than any other UNIX-based DBMS.

Judge for yourself. Send for our demo kit—disks, tutorial and reference manuals, all for only \$150—that shows you how to build virtually any application. Contact UNIFY, 4000 Kruse Way Place, Lake Oswego, OR 97034, 503/635-6265.

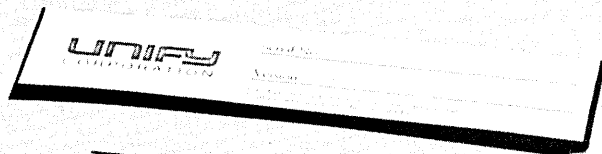

**RELATIONAL
DATA BASE
MANAGEMENT
SYSTEM**

UNIFY®
THE PREFERRED DBMS.

CIRCLE 83 ON READER CARD

One sure way to get the attention of AT&T IS is by demonstrating special competence in Unix.

because of the sheer numbers involved. The technical assistance will be broader in nature than that required by the smaller var. It's a question of magnitude." The specific magnitude is obvious when you consider AT&T IS does business with just over 50 vars; Ducommun was expecting to have up to 600 vars by the end of 1984.

Jacobs says that such specialization makes the relationship with AT&T IS remarkably complementary, and not at all competitive in their respective search for vars. "It depends on who gets the lead first," he says. "They've been very open in providing us with several thousand leads. By the same token, some very large companies have contacted us and we've turned them over directly to AT&T IS."

According to Jacobs, AT&T IS typically will refer a var to Ducommun "if they can't forecast a full year's volume that exceeds several million dollars of product, if they are unwilling to provide them with 90 to 120 days of frozen lead time orders, and if they are not nationally dispersed with offices all over the country."

Ducommun's role will be to keep those small vars from being overshadowed

by the big ones. "The reason we're in business is so that they won't get lost," Jacobs says. "They might get lost easier at AT&T IS."

In some cases, a rapidly growing var starting with Ducommun may later be switched to AT&T IS. "If at some point the var dealing with Ducommun is wildly successful and suddenly becomes very large," Morris explains, "Ducommun will turn to us and say at that point, 'they should be dealing directly with you, because they can get the kinds of service and support they need from you and discounts equal to or better than ours, and you ought to take them over.'" Much less likely is the possibility that a company with an established direct relationship with AT&T IS would be moved to Ducommun, except in the rare case of rapidly declining sales. In most cases, though, their projected volumes are large. Omnicad, for example, intends to ship in excess of 500 drafting systems a year, and AT&T IS prefers to maintain a direct link to such influential vars.

Save for the difference in customer size, Jacobs says the var programs of AT&T IS and Ducommun are identical.

FIRST FILL OUT A FORM

If you choose to approach Ducommun first, rather than AT&T IS, you will be given a var application form asking you about your product, your markets, what training you need, what your sales plan is, what your capitalization is—the same questions you'd be expected to answer for AT&T IS. The evaluation and approval process, however, probably will be much quicker—about 24 hours, Jacobs says. "It's really a very simple process. We have a number of people working on the qualification process and they have the ability to approve or disapprove." Disapproval is rare for vars who come to Ducommun. You need only to be able to communicate clearly that you do add value to the product, and what that value is.

"We're all trying to put everything in boxes in this world, and some things just don't fit neatly in those boxes," Jacobs observes. "Often you ask these vars a couple of questions and you find out that they're really adding significant value, but it just doesn't follow traditional lines. We had a dealer from North Carolina who looked like a retailer on the form. We called him back and said we can't do business with a storefront that adds no value. He said, 'I'm not a storefront. I write my own software and my target market is education and medical.' You never would have figured that out by reading his application."

Ducommun also handles all contract negotiations with the smaller vars. Their contracts are for one year and are renewable, like Ducommun's own var agreement with AT&T. The prices that vars get are determined by what services Ducommun provides, and by what their vars need as a competitive entry level for hardware and software purchasing. "We believe that every var should get the same price," Jacobs says. "We ask for a minimum commitment over a 12-month period that we think any valid var should be able to obtain." That minimum commitment is not determined by a fixed number of units. For example, one var might sell three 3B5s at something like \$80,000 apiece, and another might sell 15 3B2s at \$15,000 to \$16,000 apiece.

The commitment is a minimum annual dollar revenue figure, which Jacobs will not divulge. "All I can tell you is that December [1984] looks like a multimillion-dollar month. To get to that level so quickly from starting at nothing a couple of months ago is very heartening." ●

Claiborne J. Cordle is a free-lance writer based in Charlottesville, Va.



"Arnold, some pygmies are here to eat our termites."

CARTOON BY ARTEMAS COLE

The only Modula-2 native code compiler for 8086/8088-based machines and VAX[®] systems.

All the strengths of Pascal, plus improvements in every respect.

Modula-2 is Niklaus Wirth's second generation programming solution. All the best features of his Pascal language plus major features for true modularity, support for multi-tasking, type checking between program modules, syntax improvements, and features for increased portability (to name just a few).

A complete program development system.

LOGITECH MODULA-2 includes a complete implementation of Wirth's design, plus 8086 large model support and additional LOGITECH modules (including display handling and dynamic string handling).

A complement of powerful debugging tools—including compile-time error checks and symbolic debugging—is included.

Professional support from the people who wrote LOGITECH MODULA-2.

LOGITECH's Modula-2 is a professional development tool, backed by the most professional support available for Modula users.

LOGITECH's complete Modula family:

- MODULA-2/86™ native code 8086/8088 compiler
- MODULA-2/VMS™ VAX-resident compiler
- MODULA-2/VX86™ VAX to 8086/8088 cross compiler

Don't start another project without considering LOGITECH MODULA-2.

Trademarks: MODULA-2/86, MODULA-2/VX86, MODULA-2/VMS—LOGITECH, Inc.
Registered Trademarks: VAX—Digital Equipment Corporation

CIRCLE 84 ON READER CARD

LOGITECH MODULA-2

LOGITECH
MODULA-2

To order, or for more information,
call or write:

Chris Cale, 805 Veterans Blvd.
Redwood City, CA 94063
(415) 365-9852

In Europe contact: Willy Steiger,
LOGITECH SA, Switzerland.
(021) 77 45 45



LOGITECH

Xebec's New Owl Redundant Storage Technology

Then.

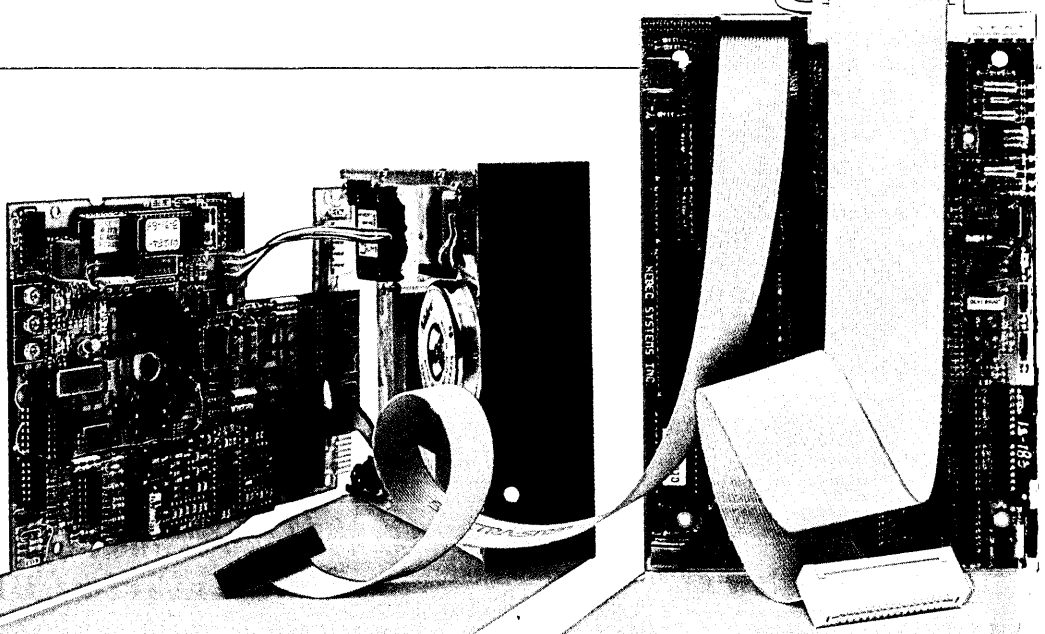

Microcomputer storage history has progressed by a series of small "next logical steps." A replacement of a component here, a refinement of technology there. But now Xebec has taken a giant step, with its Owl intelligent disk file.

On the surface, the Owl might look like other 10-megabyte, 5¼" half-high Winchester. Underneath, however, it's an example of superior technology. The integration of controller logic and drive electronics on a single board means not just one less PCB, but the elimination of expensive connectors and cabling, low power consumption (15 watts typical) and enhanced data integrity.

We've put data separation in the HDA for precise control of data windowing and the elimination of background noise. We've provided a diagnostics channel to the host that delivers meaningful error messages.

Just as our superiority in minicomputer controllers led the way to a similar superiority in micro controllers, and our tested pairs solutions evolved from our considerable subsystem and testing experience, so too the Owl

reflects our "top-down" engineering strategy—creating both technological and cost-of-owner-

Single-board drive and controller electronics insure higher reliability

Integrated data separation within disk drive delivers higher data integrity

Ruggedized design includes bead landing zone

Comprehensive diagnostics eliminate "What's wrong?" guesswork

Compatible with industry standard Xebec SASI bus for faster system integration

CORPORATE HEADQUARTERS
2055 Gateway Place, Suite 600
San Jose, California 95110 U.S.A.
(408) 287-2700

as Microcomputer Disk Two Words.

Now.

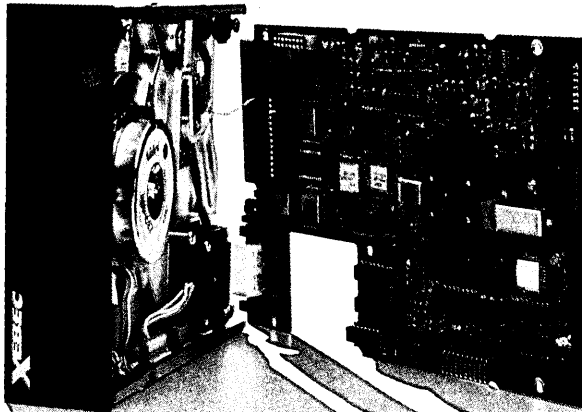

ship breakthroughs by designing sophisticated high performance, multi-user features into small-system, single-user environments.

The System-Engineered Solution.™

As a major user of drives, and a major testing resource for other drive manufacturers, we are concerned about drive reliability. And we've learned that it's not just a question of improving a component or consolidating some board real estate. The answer lies in careful consideration of overall system integration requirements.

The Owl epitomizes what we call the Xebec System-Engineered Solution. The focus is two-fold: on today and on tomorrow. Compatible now with industry-standard Xebec SASI, the Owl—by eliminating the ST506 interface—is

upwardly compatible for future higher densities, capacities and performance.

In broader perspective, Xebec's approach to OEM satisfaction rests on our proven experience, our vertical integration strengths—which now include production of heads and plated media—and our commitment to zero defect quality, by way of computer-aided design and robotics manufacturing.

Call Xebec today. Let us tell you more about the Owl. And how we can deliver the difference between then and now. Now.

SALES, INTERNATIONAL,
Belgium
32-02-762-9494
England
44-734-693511
Italy
39-6-350201

SALES, U.S.A.
Sunnyvale, CA (408) 732-7330
Irvine, CA (714) 851-1437
Atlanta, GA (404) 457-9872
Boston, MA (617) 740-1707
Dallas, TX (214) 361-0687
Baltimore, MD (301) 992-7377
Federal (301) 621-3010
Chicago, IL (312) 931-1420

U.S.A. AND CANADA DISTRIBUTORS
Kierulff
Hamilton-Avnet
Avnet Electronics
Hamilton Electro Sales

XEBEC
*The Quality
Investment*

CIRCLE 85 ON READER CARD

Now you have a choice



THE REEL ALTERNATIVE IS EVEN BETTER

No other streamer compares with the THORN EMI 9900 Tape Drive for performance, cost and quality. 9900 is only 8 $\frac{3}{4}$ -inches high, an attractive low profile tape drive that looks good on any desk, or in rack or cabinet.

Yet mail a standard 10 $\frac{1}{2}$ -inch reel of $\frac{1}{2}$ -inch tape through the front door, watch the spool lock and load automatically (confirmed by intelligent alphanumeric display) and seconds later you're on line with unformatted capacities of up to 69 Mbytes at 1,600 bpi PE or 138 Mbytes at 3,200 bpi PE. Streaming tape speeds are 25 or 100 ips.

There's no compromise in the 9900. We have combined the best and most innovative features into a highly competitive and compact package. We cannot hope to cover them here, so we hope you will give us the opportunity to demonstrate how THORN EMI 9900 is the reel thing in interchangeable data back-up.

THORN EMI 9900 is only one of our family of $\frac{1}{2}$ -inch streamers and sub-systems – part of our total commitment to remaining at the leading edge of tape recording technology, where we've been for over 30 years.

Call us for further details.



THORN EMI Datatech Ltd Data Products Division Spur Road
Feltham Middlesex TW14 0TD Tel 01-890 1477 Telex 23995
A THORN EMI Information Technology company

Integrated systems worth more than \$315 million are moving into fine restaurants and fast-food franchises.

DIGITAL DINING

by Philipp Harper

A revolution is taking place in restaurants all over the nation, and it promises to be just as sweeping, though less conspicuous, as the earlier advent of the fast-food shops. This revolution is not being heralded by golden archways, but by the appearance of computer hardware and software in kitchens, service bars, and back offices throughout the industry.

Whether it is a solitary microcomputer being used in a mom-and-pop operation for general ledger accounting, or an intelligent point-of-sale terminal functioning as a single element of a large distributed network, the computer is giving restaurateurs unprecedented control in all phases of their business.

A waiter can now send his orders to the various food and beverage preparation areas without leaving the dining room. Not only does this cut down considerably on foot traffic, but it also allows management to backtrack an order to the person who initially authorized it.

Even more impressive are some of the currently available POS terminals, with capabilities that far outstrip those of the mechanical cash registers from which they are descended. In addition to the traditional cash drawer function, today's new gear keeps a variety of running sales tallies, monitors inventory levels of each menu item and its ingredients, sets up employee work schedules, and then keeps track of the wages owed all workers, even if each one performs a different task at a different pay scale within the same pay period.

At the opposite end, back-office management tasks also are being automated. Software has been developed to accommodate the accounting idiosyncrasies of the restaurant trade, and tasks such as purchasing are streamlined when the back-office system is linked to the front-end inventory control. Indeed, it is this management-operations nexus that represents

one of the most prominent new directions in restaurant automation.

Referring to the trend toward total systems integration, the ceo of a leading systems house says, "The integration of operating systems for POS and back office will continue. Users want more and more information in a much more rapid time frame, and they want it in a much clearer representation to the user than they've ever had before."

The large companies that dominate the market are increasingly giving the "totally integrated system"—usually a POS network linked to a back-office pc—a place of prominence in their product lists. This trend toward function integration is expected to continue, setting the course in terms of product development for primary manufacturer and oem alike.

Analysts note that the broader system applicability that is evolving, coupled with the decline in hardware prices typical of the entire computer industry, is sure to translate into greater market appeal. Indeed, the demand for restaurant systems is expected to grow explosively through the remainder of the decade. That, at any rate, is the conclusion of a recent study of the market by a New York consulting firm.

By the end of 1983, says Frost & Sullivan Inc., some 120,000—or 20% of the nation's approximately 600,000 traditional restaurants—possessed a computer system of some kind. The figure for the fast-food segment was much higher, with about 70% of the 80,000 outlets boasting similar systems.

In terms of dollar volume, the New York firm says that systems sales to the restaurant trade will top \$316 million in 1984, with \$211 million in sales of turnkey systems. The firm further predicts that these sales will more than double by 1988, when a total volume of nearly \$647 million is anticipated. Turnkey sales again will dominate, hitting about \$485 million, if Frost & Sullivan is correct.

"Without question, it is a high-growth area, with a relatively low [current] penetration of the total restaurant population," says Doug O'Connor, president and ceo of Santa Ana, Calif.-based ATV Systems Inc., a leading purveyor of turnkey systems.

Developing the market over the next four years may not be as difficult as one might imagine. There already exists a substantial group of nonusers who are ripe for the introduction of automation. The public accounting firm of Pannell Kerr Forster in Houston estimates that 40,000 of the restaurants in this country doing more than \$750,000 in annual sales are prime candidates for some kind of automation.

SAME OLD SUPPLIERS MEET NEEDS

Poised to meet this present and future demand are essentially the same variety of suppliers that can be found in any vertical market. First and most important are the large hardware manufacturers working in concert with outside software houses. Then come the systems houses turning out their own proprietary solutions, followed by the oems, and sellers of unbundled hardware and software. At the bottom of the pecking order, but moving up fast, are the service bureaus, which are trying to preserve their revenue base by offering packages using their old software and databases tied to cheap microcomputers. The providers of turnkey systems, including cooperative efforts by large computer manufacturers and software houses, are currently the dominant force in the market, and they are expected to remain so. Lagging considerably behind, according to Frost & Sullivan, are the unbundled hardware and software dealers and service bureaus. Hardware sales will account for just \$44 million this year, compared to \$33 million for software and about \$27 million for service bureaus.

Of these three categories, only software sales are expected to increase relative

"The integration of operating systems for POS and back office will continue."

to the \$485 million in turnkey revenues projected for 1988. Software sales in that year are expected to hit nearly \$81 million, with the hardware and service bureau totals coming in at \$65 million and \$16 million, respectively. This effort in software development will probably be split between creating generic accounting packages intended for back-office use, and the design of custom packages to meet the specific front-end needs of individual users.

While the broadening of the overall market may eventually mean opportunities for small companies that are able to get to market quickly with innovative products, large firms now dominate. This is a natural outgrowth of the early adoption of front-end automation by the fast-food segment. Meeting the data processing needs of these chains, where each outlet requires multiple terminals, is best accomplished by a supplier of equal size.

Frost & Sullivan notes that the top five sellers to the restaurant trade accounted for nearly \$175 million in sales, or almost half of total market volume in 1983.

Ranked in order of sales, the top five are NCR, \$60 million; ATV Systems Inc., \$50 million; Toronto-based Remanco Systems Ltd., \$25 million; Datachecker/DTS, of Maynard, Mass., \$20 million; and Fasfax Corp., of Nashua, N.H., \$18 million. Sales figures are for POS and back-office equipment in all cases.

The situation at NCR, long known for its POS systems and its earlier electronic and mechanical cash registers, reflects the industry's shift toward greater integration, and the new emphasis upon back-office capabilities that this implies. Gordon E. Meister, head of NCR's hospitality division in Dayton, Ohio, calls the adoption of the microcomputer for restaurant use "the hottest thing in the industry in the last 18 months." The true potential of the machine in this area lies in its ability to be interfaced to POS systems, Meister adds, "so most of the leading vendors are developing POS interfaces."

PACKAGES FOR USER NEEDS

Though NCR offers standard hardware products in both the POS and micro areas—the 2160 and Model 4 respectively—the firm is working with a number of software houses on the development of a variety of packages to meet the needs of different types of end users. A small chain or even a single operation might want a back-office system capable of general ledger accounting, for instance. A large fast-food chain, which consolidates accounting at the corporate headquarters, may need a much more lim-

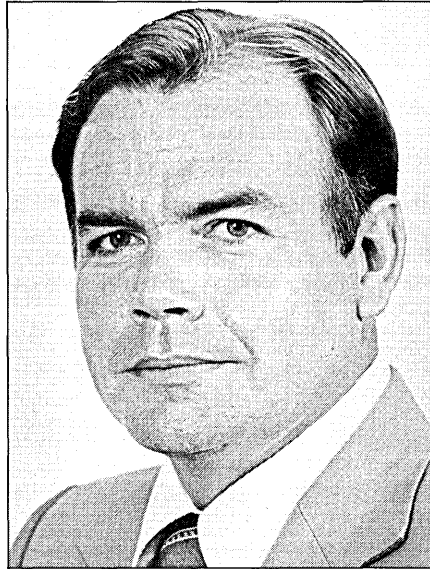

Swart of Burger King: "The POS is an inadequate technology that simply supports one aspect of the restaurant business."

ited back-office capability. Here, a back-office workstation, through which the manager could perform functions like changing the prices in the POS terminals, might very well suffice.

Prices for NCR systems begin at around \$18,000 for two POS terminals and a single back-office workstation. Expanding the system to five terminals pushes the price to between \$25,000 and \$30,000.

With an eye to the future, and perhaps on markets not yet tapped by NCR, Meister notes, "Even the small operators are getting into it. There are so many good new applications that the entire industry is picking it up."

NCR's closest competitor is ATV Systems, which has a slightly different orientation to the developing market for restaurant systems. Formed in 1981 through the merger of a handful of firms already involved in the restaurant market, ATV has a variety of offerings reflecting the diversity of its divisions. By building on the products already developed by its constituent parts, and then producing some new ones, ATV tallied sales of nearly \$20 million in its first full year of operation, and \$50 million in its second year.

ATV is a systems house that designs and packages its own hardware and software, and it prides itself on its ability to tailor its systems to the individual client. Says ceo O'Connor, "There are no generic solutions that can be taken off the shelf for normal restaurant operations." He points to ATV's 1983 rollout of equipment to meet

POS needs at 800 Jack-in-the-Box outlets. The software package that drives the ATV Medallion systems now in use at the restaurants was designed specifically for Jack-in-the-Box, O'Connor says.

The company's present product mix consists of three integrated POS systems: the 3200 and 4900 series; the Medallion; and the Delta, a standalone POS workstation. A fine-dining system called the Epicure is also offered. The fast-food system prices start at \$12,000, and the fine-dining packages at around \$25,000. The Delta sells for about \$5,000.

O'Connor describes the 4900 series and the Medallion as "third generation products" incorporating features not shared by the other products, such as redundancy built into the individual terminals that allows them to remain in operation even if the cpu crashes, and a more sophisticated operating system that can accommodate a back-office package.

Though ATV markets its back-office package strictly as an add-on, O'Connor sees integration as the key to the future. "Ten years ago, the big thing was the transition from the mechanical to the electronic cash register," he says. "Now, those who made the transition are looking for complete control. The thrust toward larger capacity memory, broader software packages, and the integration of operating systems for POS and back office will continue."

O'Connor issues a final caveat: "The equipment has got to be user friendly when you're talking about youngsters turning over in the [restaurant] industry five times a year."

The fine-dining or table-service side of the business is especially suited to integration of back and front because restaurant managers generally have more autonomy than do their fast-food counterparts. This autonomy includes accounting plus functions like purchasing and menu preparation. The need at this level has led to a number of interesting solutions.

PACKAGE FOR FINE DINING

Micros Systems Inc., a Beltsville, Md., firm with systems sales to the hospitality market of about \$16 million last year, has capitalized on its status as a value-added dealer enough for IBM to come up with a package geared specifically toward the fine-dining segment. A maker of microprocessor-based POS terminals since 1978, Micros Systems has been developing software that will enable a back-office IBM PC XT to control the firm's front-end systems.

Such a configuration is desirable, explains Thomas Nicholson, the firm's se-

“Only the Invitational Computer Conferences bring the latest OEM computer and peripheral products to your front door. You’ll find us there!”

And you’ll find other top OEM manufacturers, such as IBM, Control Data, DEC, Fujitsu, NEC and Seagate, to name a few.

In their 14th year, the “OEM Only” Invitational Computer Conferences bring you, the volume buying decision makers, together with the key suppliers of computer and peripheral products. The ICCs, a series of ten, one-day regional shows are convenient to where you live and work. The social business setting makes it easy for you to meet poten-

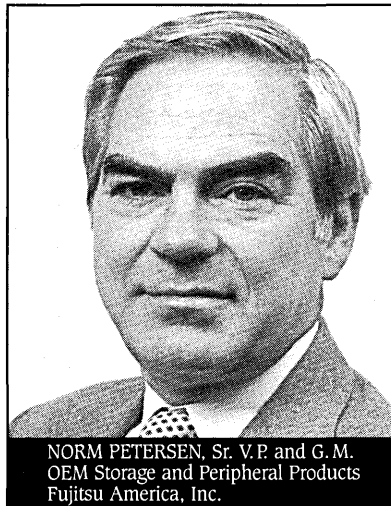

NORM PETERSEN, Sr. V.P. and G.M.
OEM Storage and Peripheral Products
Fujitsu America, Inc.

tial suppliers one-on-one, and attend high tech seminars of your choice. As an invited guest, there is no cost to you.

Hear what the OEM manufacturers have to say, learn more about their products, and remember, you may attend “by invitation only.”

1984/85 U.S. ICC Locations

Sept. 6, '84	Newton/Boston, MA
Sept. 25, '84	Southfield/Detroit, MI
Oct. 10, '84	Cherry Hill, NJ
Oct. 23, '84	Englewood/Denver, CO
Jan. 8, '85	Irvine, CA
Jan. 29, '85	Houston, TX
Jan. 31, '85	Dallas, TX
Feb. 26, '85	Ft. Lauderdale, FL
Mar. 19, '85	Palo Alto, CA
Apr. 2, '85	Nashua, NH/No. MA

Call your local OEM supplier for your invitation or fill out the coupon and mail to:

B. J. Johnson & Associates, Inc.
3151 Airway Ave., #C-2
Costa Mesa, CA 92626
Phone: (714) 957-0171
Telex: 188747 TAB IRIN



Yes! I need an invitation to your “OEM Only” ICC. The nearest ICC to me is: _____

I buy in volume:

- Computers
- Disk/Tape Drives
- Controllers/Interfaces
- Terminals/Graphic Displays
- Software
- Printers
- Memory Boards
- Modems/Multiplexers
- Power Supplies

Name _____

Title _____

Company/Division _____

Address _____

City _____ State _____ Zip _____

Mail To: B. J. Johnson & Associates, Inc., 3151 Airway Avenue, #C-2, Costa Mesa, CA 92626
Phone: (714) 957-0171 Telex: 188747 TAB IRIN



**"I invest my time in
high technology.
I invest my money in
U.S. Savings Bonds."**

William L. Rasmussen
Honeywell, Inc.

William L. Rasmussen, one of the developers of the ring laser gyro, says: "I've tried many forms of investment and I'm satisfied I can't do better than U.S. Savings Bonds."

Just look at the facts. New competitive-rate U.S. Savings Bonds are the answer to sensible savings without risk. Today's Bonds pay higher market-based interest rates—the sky's the limit. And a guaranteed minimum return protects your investment. Bonds are exempt from state and local taxes, so the effective yield is even higher.

Best of all, Bonds are easy to buy—wherever you bank, or through the Payroll Savings Plan where you work. No fees or commissions. And no worries. So save time and money. Buy Bonds.

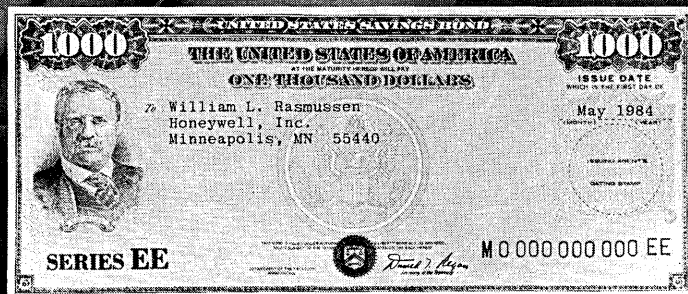

Take
stock
in America.



A public service of this publication.

“Only the Invitational Computer Conferences bring the latest OEM computer and peripheral products to your front door. You’ll find us there!”

And you’ll find other top OEM manufacturers, such as Bull Peripheriques, IBIS, Fujitsu, Tandberg, Tandon, Olivetti and Control Data, to name a few.

In their 4th year, the “OEM Only” Invitational Computer Conferences bring you, the volume buying decision makers, together with the key suppliers of computer and peripheral products. The ICCs, a series of six, one-day regional shows are convenient to where you live and

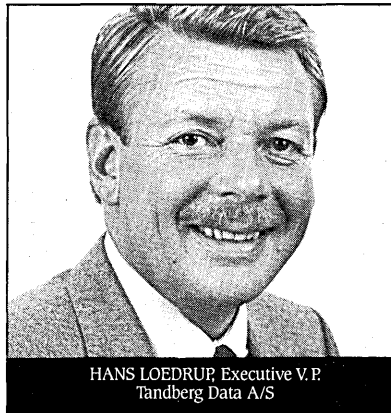

HANS LOEDRUR, Executive V.P.
Tandberg Data A/S

work. The social business setting makes it easy for you to meet potential suppliers one-on-one, and attend high tech seminars of your choice. As an invited guest, there is no cost to you.

Hear what the OEM manufacturers have to say, learn more about their products, and remember, you may attend “by invitation only.”

1984/85 Europe ICC Locations

- Oct. 9, '84 Munich, W. Germany
- Oct. 16, '84 Vienna, Austria
- Oct. 23, '84 Milan, Italy
- Feb. 28, '85 Paris, France
- Mar. 7, '85 Frankfurt, W. Germany
- Mar. 11, '85 Stockholm, Sweden
- Mar. 14, '85 London, England

Call your local OEM supplier for your invitation or fill out the coupon and mail to:

B.J. Johnson & Associates, Inc.
3151 Airway Ave., #C-2
Costa Mesa, CA 92626
Phone: (714) 957-0171
Telex: 188747 TAB IRIN



Yes! I need an invitation to your “OEM Only” ICC. The nearest ICC to me is: _____

I buy in volume:

- Computers
- Disk/Tape Drives
- Controllers/Interfaces
- Terminals/Graphic Displays
- Software
- Printers
- Memory Boards
- Modems/Multiplexers
- Power Supplies

Name _____

Title _____

Company/Division _____

Address _____

City _____ State _____ Zip _____

Mail To: B.J. Johnson & Associates, Inc., 3151 Airway Avenue, #C-2, Costa Mesa, CA 92626
Phone: (714) 957-0171 Telex: 188747 TAB IRIN

The equipment has got to be user friendly in an industry where the turnover rate is five times a year.

nior vice president of marketing, principally because it allows management to closely track inventory at each stage of the production process. The PC is able to convert the portions in which commodities are bought into those in which they are sold, making it possible to track the actual percentage of an ingredient that makes it to the table. The implications for waste reduction are obvious.

The system also aids in the timely reorder of inventory, since the back-office pc can poll the various POS terminals and determine which ingredients are in low supply. This kind of tight control is essential to the success of a restaurant, Nicholson asserts, because success or failure in the business often turns on the operator's ability to reduce costs by two or three percent.

Still another approach to integration sidesteps entirely the problems inherent in the marriage of front- and back-end systems. Jarasoft Systems, an Alexandria, Va.-based subsidiary of an Australian firm of the same name, has come up with a single software package named MIRAS. This offering provides both POS and back-office capabilities. Designed to run on micros, MIRAS is "compatible with damn near everything," claims Mark Missett, product

manager for MIRAS at MicroPride Inc., the New Jersey firm that is marketing the package in the United States.

The package permits a full array of service area and POS functions, while enabling the back-office manager to handle accounts receivable and payable and perform general ledger accounting. The package is priced at \$2,500 for a single user and \$3,500 for multi-user applications. MIRAS can accommodate up to 32 users, Missett says.

SUPPORT AROUND CORNER

"The package allows you to buy from the local computer store whatever is cost-effective for you, and whatever computer the store supports. So support is right around the corner," says Missett. He claims that MIRAS's hardware flexibility, coupled with its relatively low price, means that automation is now an option for even the smallest restaurant.

Ironically, small restaurateurs could very well be getting their back-office systems at about the same time that these capabilities are being introduced to the big fast-food chains. Though long a leader in POS systems, the fast-food segment has resisted back-office integration, favoring cen-

tralizing controls in headquarters or regional offices. Such resistance seems to be crumbling.

At McDonald's Corp. in Chicago, for example, the information processing department is now standardizing the POS equipment used at the roughly 1,500 company-owned outlets. Back-office functions will have no place in the revamped system, however. A conscious decision has been made to not give managers more control, says information processing head John Ozvath. "If we have the manager working with a computer instead of out there working with the customers or the crew, we feel we lose," he says. "So we've been very careful in preserving the integrity of the store and very careful in introducing change there. Technology is so abundant and there are so many things you can do. But it's like a lot of things: if it's not broke, don't fix it."

A different attitude prevails at the Miami-based home of the Whopper. In October of this year, the management of Burger King Corp. introduced a new restaurant-level computer system that encourages greater control and participation by outlet managers. Designed by the IBM Custom Group, the system is based on micros at the store level, with IBM 4300 mini-computers at 11 regional offices and 18 distribution centers, and with Big Blue's mainframes further upstream at the corporate level. The system will encompass the more than 500 company-owned restaurants, and the 3,300-odd Burger King franchises will be encouraged to join the network.

Burger King's vice president of management information systems, Bill Swart, says that existing POS terminals at individual outlets are allowed to offload their data to headquarters once a day via a strictly one-way communications link. All management support, including sales and production analyses, is then provided to the individual outlet from above. Under the new system, Swart says, every outlet manager will have the computing wherewithal to generate the needed management support at the local level.

The rationale behind the change-over is straightforward. "If you look at the POS today, it's an inadequate technology that simply supports one aspect of the restaurant business," says Swart. "The price value is simply not there. The cost of a POS in relation to the capabilities it can provide is terrible, if compared to the pc and its capabilities." ©

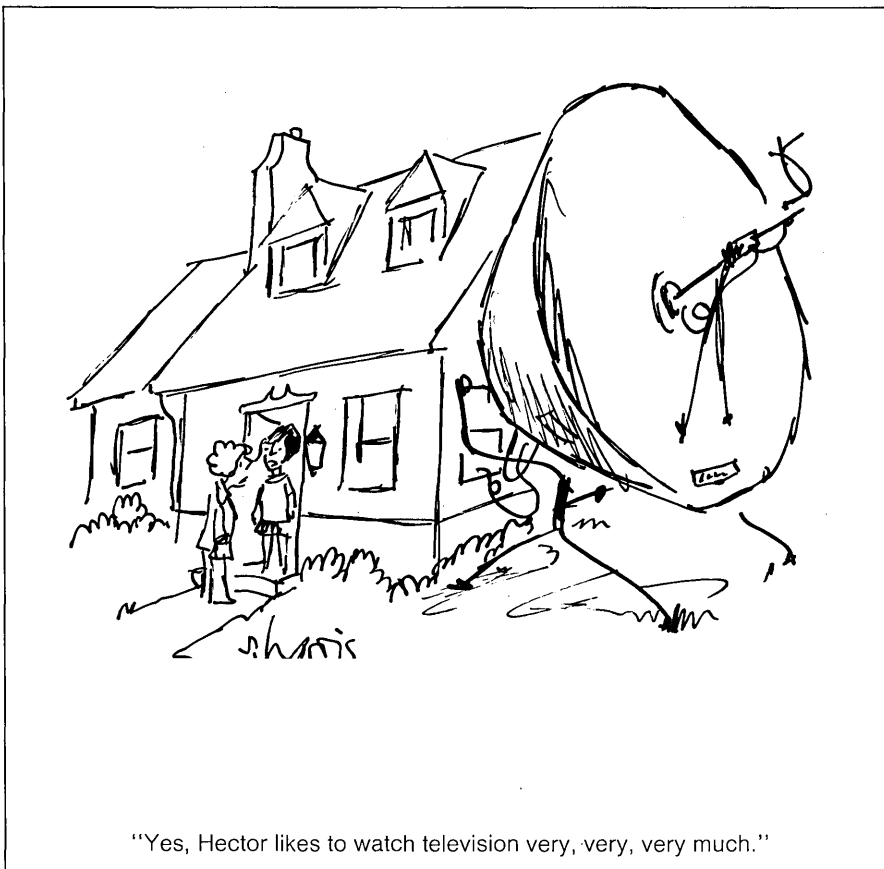

"Yes, Hector likes to watch television very, very, very much."

Philipp Harper is a free-lance writer based in San Diego.

CARTOON BY SIDNEY HARRIS

IN HEAD-TO-HEAD COMPETITION, OUR NETLINK BEAT THE TRUNKS OFF EVERY COMPETITOR.

We recently asked a number of data communication users to test our DCA Netlink on-site against any competing product. In every trial, against all comers, Netlink won. With a flurry of hard-hitting features.

The most telling blow: its data-voice-compressed video combination. Netlink can deliver all three simultaneously at various speeds. Via leased lines, microwave, laser, satellite, fiber optics—whatever transmission mode you use.

It can handle speeds of 50 bps to 2.048 million bps and transmit voice at low speeds without losing quality or speech recognition.

Because it's software driven, you can change channel speeds and configurations with the touch of a console. Or you can program it to change configurations at predetermined times.

And because it's an advanced time-division multiplexor, it is completely transparent and compatible with all your voice, image and data communications equipment.

So why not give it a shot. You'll discover as others have that for power, speed and flexibility, the DCA Netlink can't be beat.

For more information, write DCA, 303 Research Drive, Norcross, Georgia 30092. Or call toll-free: **1-800-241-5793**.

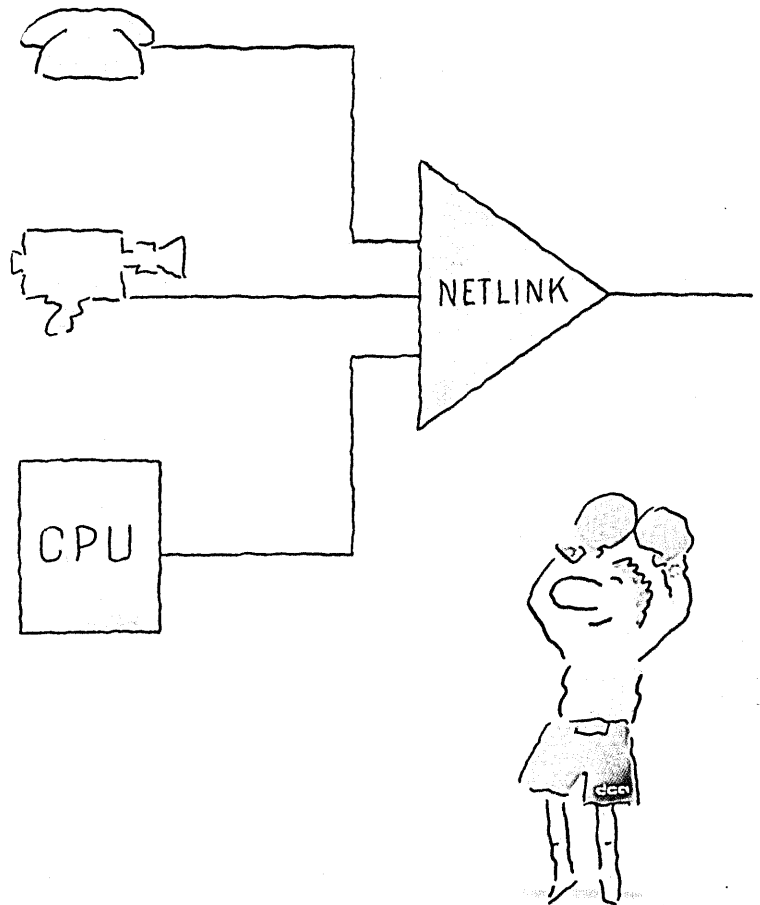

dca[®]

Digital Communications Associates, Inc.
DCA Products Are Available Worldwide.

CIRCLE 62 ON READER CARD

THE EVOLUTION

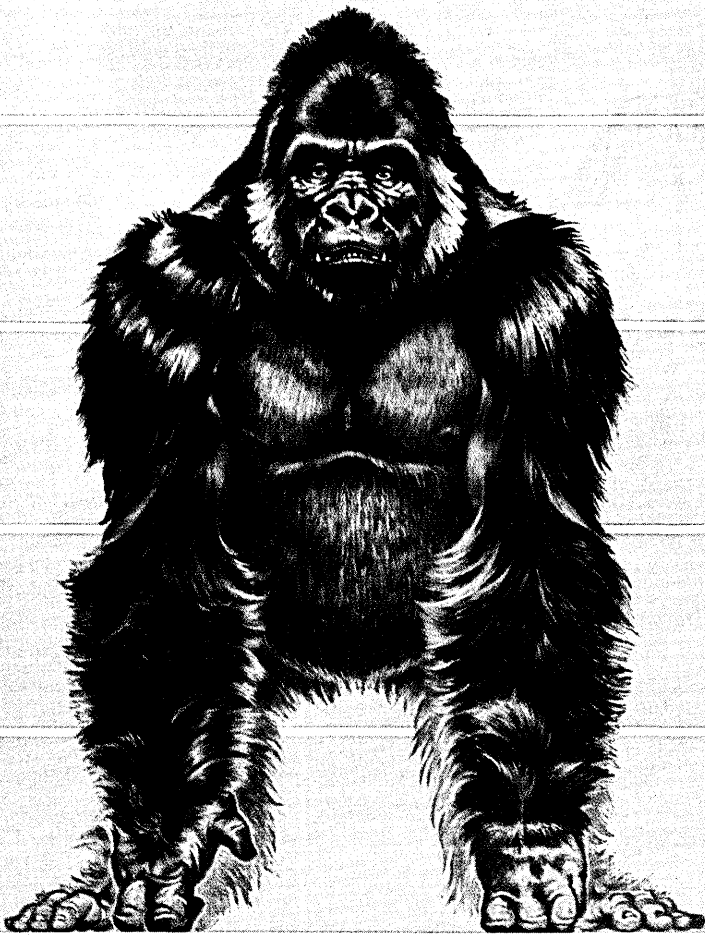

PBX
(Switchus interruptus)



LAN
(Linkus limitus)

OF MAN[®]

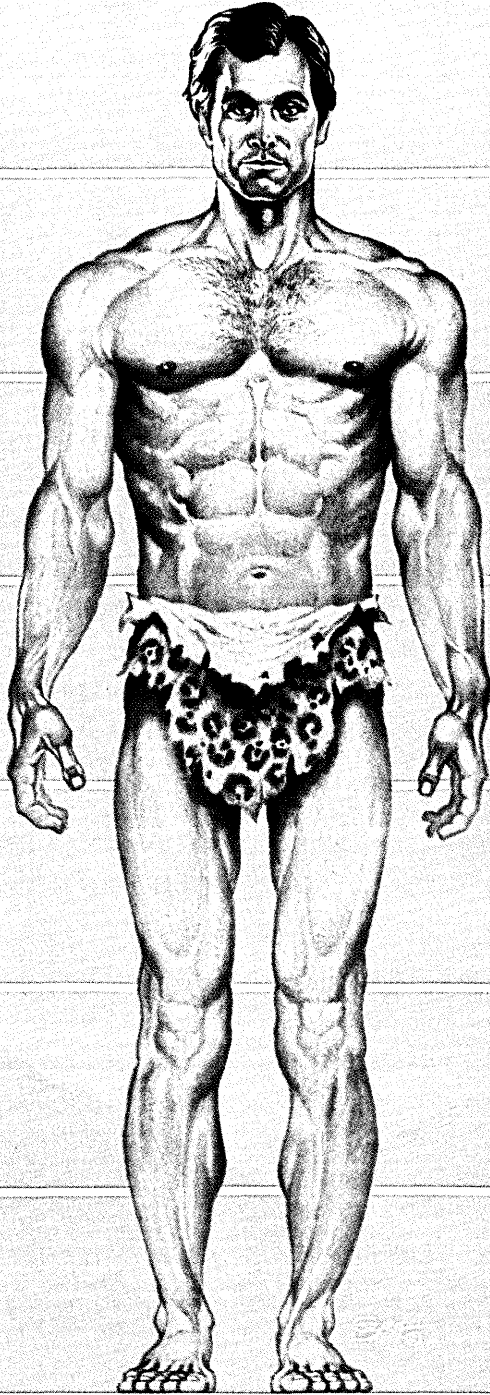

MAN
(*Connectus perfectus*)

The first step up the data networking ladder was the data PBX. It was good. But not very intelligent.

Then came the LAN. It was quicker and more flexible. But limited to just one office, just one network.

Now there's no reason to monkey around with either a Data PBX *or* a LAN.

Now there's MAN.

MAN: The Multiple Area Network.

MAN links multiple devices, multiple users, multiple networks and multiple locations.

It's the most highly evolved, highly intelligent communications system there is.

Where Data PBXs struggle to provide single connections for slow terminals, MAN makes it easy to access multiple sources from low *and* high speed devices.

Multiple sessions per port let you connect to a VAX,[™] then switch easily to an IBM[™] mainframe.

And PBXs have a single point of failure. MAN doesn't.

Survival of the fittest.

The LAN was a big step up from the Data PBX. MAN goes way beyond any LAN.

It not only lets you connect all your personal computers, printers, terminals, and mainframes to Ethernet, it lets you link your Ethernet to other Ethernets, remote nets, X.25 public nets, and SNA.

You can even link LANs across Tymnet and Telenet.

And MAN's Terminal Servers, Host Servers, and Gateways have the capacity to serve even the most demanding users like Sperry, NASA, GTE and Contel.

Call 415-969-4400. Or write us at 1345 Shorebird Way, Mt. View, CA 94043. We'll tell you all the reasons you should choose MAN over the competition.

It's the natural selection.

Bridge
COMMUNICATIONS INC.

The Multiple Area Network

CIRCLE 63 ON READER CARD

Batch Processing Systems Lease Agreement

Before you renew your current lease, call Northern Telecom for a 10-minute telephone audit. We'll match our proven, practical, reliable systems, our service, and our pricing with any on the market. In fact, Northern Telecom systems deliver more throughput per dollar than any competitive system. With constant pressure to contain costs, doesn't it make good sense to compare? Call now.



© Northern Telecom 1984

Match this:	Your system	nt northern telecom
Long-term savings on multi-year leases, plus discounts of up to 30% on lease renewals.	<input type="checkbox"/>	<input checked="" type="checkbox"/>
Service professionals in 157 cities. Average service response time in major locations is less than two hours. Nationwide, less than three hours.	<input type="checkbox"/>	<input checked="" type="checkbox"/>
State-of-the-art 1500/2000 lines-per-minute band printers combine high volume output and exceptional reliability.	<input type="checkbox"/>	<input checked="" type="checkbox"/>

30 days delivery on all batch system equipment.



Match our batch! Call 1-800-331-3113.

CIRCLE 64 ON READER CARD

HARDWARE

OFF-LINE

It's been only 21 years since the first communications satellite was launched by the United States. Since then, the neighborhood 22,300 miles above the equator has become packed with these devices, so much so that the Federal Communications Commission has permitted the spacing of these geostationary satellites to be reduced from four to two degrees apart. What with satellites launched from the ground and satellites carried into orbit by future shuttle missions, we can expect to have more hardware in orbit from more countries doing more things than ever before.

Inevitably, this condition will be a boon for computer users. Today, thousands of databases are within reach of millions of personal computers. Still, the most economical way to tap into all this information is with a telephone and a modem. Satellite services are simply too expensive for the benefits they provide, as far as most customers care. But as the sheer number of satellites and satellite interconnect services grows, the price issue is likely to diminish. As more companies enter this field and more of the nation's largest corporations set up their own private satellite networks, the cost of satellite transmissions is sure to drop.

Another element is to ensure that the signal reaches the correct party in a secure way. Sophisticated coding of the transmitted data provides addressing to individual units, thereby permitting discrete or network use of data channels.

It would seem, then, that a businessman's variation of a law of physics still rings true: what goes up must come down. In this case, satellites are going up and the cost of a satellite transmission should start coming down. A modest case in point is a firm called Satellite Broadcast Network Inc., located in Chicago. This

firm is making a variety of data available to personal computer users for \$950, by selling a compact receiving antenna that can be mounted on a roof for reception of data, thus bypassing phone lines. Currently, the phone companies don't see private satellite bypass as a threat, but if a significant downward pricing trend develops, some industry observers see ever more private networks established by the larger firms as lower cost makes them more practical.

The high-density floppy disks are catching on. BASF Systems Corp. and other floppy disk vendors are producing more of them. BASF plans large production increases for its high-density 5¼-inch floppy line this year. "A year ago, BASF sold virtually no high-density 5¼-inch disks in the United States," says John Healion, vice president for the West German firm's consumer products division, adding that "sales for the IBM PC AT indicate wide acceptance for the high-density diskette and proves our point that there's still plenty of potential left in the 5¼-inch market." He says BASF has been shipping this generation of floppy diskettes for almost two years, primarily to Japan. But even though there is undoubtedly more interest in the high-density 5¼-inch diskettes than there was a year ago, companies such as Sony Corp. still see a large market developing in the sub-5¼-inch market, especially with the recent introductions of major lap-sized computers. Apple, Hewlett-Packard, Data General, and others all support Sony's 3½-inch disk. That there are two emerging standards for microcomputer disk technology is not surprising, especially in the computer business. Users demand uniform standards, but the continuing variety offered by vendors leads one to believe that this industry is too uncertain about its products.

DUAL OPERATING SYSTEM

The Fortune 1000 is a line of workstations that run the Unix and PC/DOS operating systems. The options range from a single ASCII terminal to an intelligent workstation or a graphics workstation, to a complete Unix and PC/DOS networked personal computer with color graphics.

Working in conjunction with Fortune's existing 32:16-bit cpu, the desktop workstations provide users with as much or as little computing power as they need, as well as providing an integration between Unix and PC/DOS. The system can be upgraded to suit different needs.

It permits networking between IBM PCs and various Fortune products. Configurations and options include upgradable ASCII terminal with a 14-inch monochrome monitor, color monitor, hard or floppy disks, or both, networking or standalone capabilities, and high-speed data link to provide intelligent workstation capabilities with PC/DOS-Unix operating systems. Prices for the Fortune 1000 system start at \$650. FORTUNE SYSTEMS CORP., Redwood City, Calif.

FOR DATA CIRCLE 301 ON READER CARD

TOUCH SCREEN

Smart-Frame is an infrared-based device that brings the cost of adding touch sensitivity to computer displays down to the \$150 level in large oem quantities. Using a scanning technique that is able to locate a user's finger within a fraction of an inch, as well as detect motion across the screen, the product relies on a Motorola 68705 microprocessor with RAM, ROM, and 4-channel analog-to-digital conversion circuitry on-board. As a result it has 45% fewer parts than previous designs and requires no external controller. The product is available for 9-, 13-, and 19-inch flat panels and crt screens. The unit's infrared beams, generated by light-emitting diodes, are able to pass through a specially designed plastic bezel and therefore can be hidden away from the user's view and dirty fingers. Deliveries are slated to begin early this year. In single quan-

HARDWARE

titles the 9-inch Smart-Frame carries a single quantity price of \$450. CARROLL TOUCH, P.O. Box 1309, Round Rock, TX 78680.

FOR DATA CIRCLE 302 ON READER CARD

FRAME GRABBER

These three boards, designed to work in IBM PC or compatible computers, promise to enable the machines to handle full-color television images a frame at a time. The video display adapter is a graphics board that enables PCs to display continuous tone images on color televisions or standard RGB monitors. Its resolution is 256 by 200 pixels and images may use up to 256 colors from a 32,000-color palette. Each full-screen image requires 50,000 bytes of memory, but they can be compressed for transmission down to about 5,000 bytes. The image capture board is designed to capture single video frames from a video camera or tape recorder. It works under control of the PC's own microprocessor and captures an image in approximately 1/60th of a second. Finally, the PC NAPLPS decoder board converts the PC into a videotex terminal using that popular protocol. It is similar in function to the vendor's Sceptre videotex terminal. The video display adapter is available now for an oem price of \$500 in single quantities. The image capture board is also available now for a quantity one oem price of \$1,000. The decoder board is

available now for \$600 to oems. AT&T CONSUMER PRODUCTS, 5 Wood Hollow Rd., Parsippany, NJ 07054.

FOR DATA CIRCLE 303 ON READER CARD

SATELLITE LAN CONNECTION

TransLAN is a combination of hardware and software designed to connect several Ethernet or IEEE 802.3 local area networks in remote locations so that they appear as one large network through the use of broadcast satellites and earth stations.

The system provides a transparent interconnection for all LAN stations, regardless of their specific higher-level protocols. It consists of bridge hardware and software supplied by Vitalink that connects the LANS with digital transmission networks, including satellites and terrestrial lines.

Using technology developed by Digital Equipment Corp., TransLAN learns the network's configuration; that is, it remembers which stations are local and which are remote. LAN information intended to be sent to remote sites is automatically forwarded to the digital transmission network in a data-link-layer relay, or bridge, that screens and forwards information to protect the LAN and transmission system from unnecessary traffic.

In addition, the product has network management features that can be accessed from a local console or from a

management station anywhere in the network. It has eight V.35 or RS232C satellite channels or terrestrial link ports. Port capacity is 224Kbps. Frame processing rates are 4,000 frames per second filtering 1,500 frames per second forwarding. Security during transmission is also provided. TransLAN costs \$20,000. It includes hardware for an Ethernet/IEEE 802.3 connection, one synchronous I/O port card that can accommodate two V.35 or two RS232C connectors, a license for the software, and one year's software maintenance from Vitalink. TransLAN will be jointly marketed by DIGITAL EQUIPMENT CORP., Maynard, Mass. and VITALINK COMMUNICATIONS CORP., Mountain View, Calif.

FOR DATA CIRCLE 304 ON READER CARD

SOFTWARE ANALYZERS

The HP 64330 series is a line of software analyzers for debugging and troubleshooting programs written in high-level programming languages.

The first two analyzers support 68000-based microprocessors and 8086-based microprocessors for C and Pascal programming languages. The analyzers are said to improve the productivity of designers who program in these languages with measurements that match the program in concept as well as language. Global and detailed measurements allow designers to focus on software trouble spots.

For analysis sessions, the four measurements are used in a hierarchy beginning with a general overview and proceeding to more specific analysis. Measurements are available to do the following: check module flow to verify that subroutines and procedures are executing in the proper sequence, and that routines occur at the proper nesting level; check data flow to determine whether the parameters passed between modules are correct; trace the source code statements with a listing showing source lines in the high level programming languages together with the line numbers and actual variable values referenced by each source line during the measurement, and trace up to 10 variables in a code module to identify the actual values assumed during program execution and the source statements that assigned the values.

As an integrated part of the emulation subsystem, the analyzer has the ability to have direct control over the target system to run, break, reset, and load memory. The product is configured to suit the application by adding subsystems as needed for microprocessors in use. The system may be set up as a one-station system, a cluster of development stations sharing a hard disk and printer, or as a terminal to a host computer system.

HARDWARE SPOTLIGHT

REPLACES TYPEWRITER

The Wang Office Assistant is a multitasking office computer designed specifically for the secretarial marketplace. It combines the features of a typewriter, an advanced word processor, and a personal computer in one system. According to the vendor there is a need in the marketplace for a product that fills the gap between electronic typewriters and pcs, and secretaries and office personnel are looking for solutions to information processing needs beyond the typewriter. The product integrates the most common secretarial tasks, such as integrated word processing, forms processing, spreadsheets, and graphics, and offers hardware and software additions that move into other applications. It is targeted at small businesses or departmental users whose application needs don't currently justify either the level of sophistication or the expense of a larger office information processing system or even a fully configured pc.

The multitasking operating system gives users the ability to perform several tasks at the same time, such as editing a document while printing an envelope. A new task appears on the screen as the preceding one continues to run.

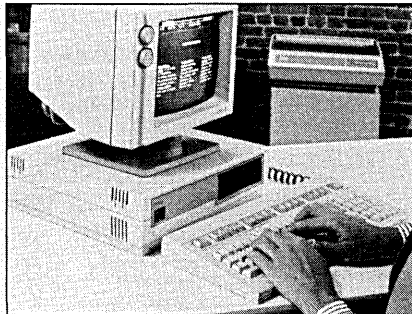

The product is designed for the nontechnical user for primarily word processing functions. It is user-installable and consists of a 12-inch monochrome screen, detached keyboard, and a base unit with 256KB of RAM, power supply, and a single 5¼-inch 360KB disk drive.

Options include letter-quality printers, disk drives, and a print-sharing device that permits up to four systems to share a large printer. RS232C ports on the back connector support output to third-party printers. Optional packages include graphics, on-line training, spreadsheets, reporting, and file management. The Wang Office Assistant costs \$2,400. WANG LABORATORIES INC., Lowell, Mass.

FOR DATA CIRCLE 300 ON READER CARD

Come See For Yourself DunsPlus: The Micro Solution That Reflects The Way You Do Business

Don't just take our word for it. Attend one of our nationwide seminars, "Innovations in End-User Computing," and judge for yourself. We'll show you how DunsPlus responds to your business demands without creating demands of its own.

What will you see at this seminar? We'll show you how DunsPlus has given the IBM PC/XT a built-in business environment—an adaptable business environment.

You'll see how easy it is to work with this menu-driven system. How single-button fast it is to access widely accepted software, like 1-2-3 from Lotus, MultiMate and Western Union electronic mail, already incorporated into DunsPlus. How easy? No DOS, no typing skills, no frustrating documentation.

And you'll see how DunsPlus gives you full flexibility to tailor its environment to your precise business needs. Add any variety of software and customized applications. Link DunsPlus to virtually any mainframe. You will see how DunsPlus can slip smoothly into the way you and your organization do business.

If your business demands answers, not claims, look at DunsPlus.

Innovations in End-User Computing Seminars are being held each month in these locations:

**Atlanta, Boston, Chicago,
Cincinnati, Cleveland,
Minneapolis, Dallas,
Houston, Detroit,
Philadelphia, Pittsburgh,
St. Louis, Washington D.C.,
Stamford, Hartford,
New Jersey, New York City,
Seattle, Los Angeles,
San Francisco, San Jose**

For dates or more
information, call today:
800 DNB-PLUS.

DunsPlus: An Innovation In End-User Computing From Dun & Bradstreet

DunsPlus

DB a company of
The Dun & Bradstreet Corporation

1-2-3 is a registered trademark of Lotus Development Corporation. MultiMate is a registered trademark of MultiMate International, Inc. IBM is a registered trademark of International Business Machines Corporation. DunsPlus is a trademark of DunsPlus, a company of The Dun & Bradstreet Corporation.

HARDWARE

Prices for the HP64330 series start at \$3,000. HEWLETT-PACKARD COMPANY, Palo Alto, Calif.

FOR DATA CIRCLE 306 ON READER CARD

DUAL SPEED DRIVE

The YD-380-1714 is a dual speed, half height 5¼-inch floppy disk drive. Giving systems designers the benefit of two standard formats in a single package, the drive's dual speed feature allows it to work with either the current standard format for 5¼-inch media, or the high capacity 5¼-inch floppies.

The drive can read and write data at 96 tpi track density on either the current standard 1MB double density, double track format, or the new high capacity 1.6MB unformatted/1.2MB formatted disk used on the IBM PC/AT.

The dual speed feature allows users to interchangeably use data and programs written either on standard or high capacity media. Because the 1.6MB capacity is format compatible with the standard 8-inch media format, replacing it with this 5¼-inch drive does not require data to be rearranged.

Standard features include disk pop-up mechanism, disk lever clamp, in-use indicator, and daisy chaining of up to four drives. Features include a read and write head, steel belt head positioning, and brushless motor. Data transfer rates are 500Kbps and 250Kbps, depending on speed. Track-to-track transfer rate is

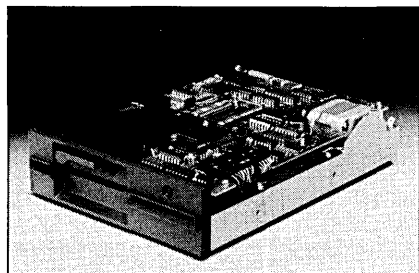

3usec. The YD-380-1714 is oem priced at \$200 per unit in quantities of 1,000. C. ITOH ELECTRONICS INC., Los Angeles.

FOR DATA CIRCLE 307 ON READER CARD

VOICE/DATA WORKSTATION

The Series 25 are workstations that provide integrated voice and data communication. They merge advanced telephone features with 3270 terminal system display.

The workstations are compatible with leading telephone systems and can perform simultaneous voice and data functions. An internal modem allows the system to dial into various asynchronous hosts and databases.

Two models are being offered, the 2510 and 2520. Both have a nonglare 9-inch display, an internal modem, a speakerphone, and password security.

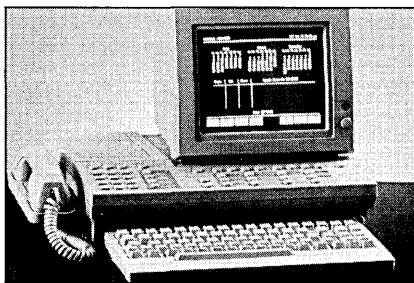

Telephone functions include autodial, a personal directory, three-party teleconferencing, user programmable telephone keys, and auto redial. Both models support calendaring functions with an audio and visual reminder.

In addition to telephone functions, both models support integrated asynchronous communications. The Model 2510 operates as an asynchronous display terminal with a tuckaway typewriter keyboard. The Model 2520 can be connected with a controller to emulate 3270 displays as well as handle the standard asynchronous communications. The 2520 includes a 3270-style keyboard.

The vendor will offer an upgrade for the 2510 to allow users to add 3270 capabilities. The purchase price for the 2510 is \$1,300. The purchase price of the 2520 is \$1,900. LEE DATA CORP., Minneapolis.

FOR DATA CIRCLE 308 ON READER CARD

RETRIEVAL AND ANALYSIS

The Metaphor system comprises hardware and software that extracts corporate and commercial mainframe data, translates that information into a user-defined form for inquiry and analysis, and allows tailoring of the system's analytical procedures to reflect individual requirements.

The system has an icon-based user interface that has been tailored for specific job functions in vertical industries. It is initially targeted at specific users within the finance and marketing functions of large consumer packaged goods companies, commercial banks, and financial planning and control operations of large companies.

According to the vendor, the system assures MIS managers that end users obtain only that information to which they have been granted access, while receiving information in a usable format. Before the system is installed in a company, the vendor works with users and MIS to extract, translate, and reorganize the data residing in a mainframe into a usable format.

Metaphor's management information retrieval system extracts corporate and commercial data from production files and databases in the IBM environment and converts the raw data into user-retrievable form for direct management

use. A system consists of workstations, database servers, file servers, communication servers, and printers. The system is connected via an IEEE 802.3 local area network. It supports interactive tools for information gathering, analysis, and presentation as well as all system, database, and host extract utility software.

A capsule feature, in which the sequential steps of individual analyses can be combined, allows users to create custom applications without technical support. Metaphor's eight-user entry configuration includes eight workstations, a 72MB file server, database server with an additional 72MB database storage module, and a full set of user and host communication software. It sells for \$64,000. METAPHOR COMPUTER SYSTEMS, Mountain View, Calif.

FOR DATA CIRCLE 309 ON READER CARD

TOUCH SCREENS

The MicroTouch DEC Kits allow oems and system integrators to configure Digital Equipment Corp. components with touch-sensitive screens. The kits are available for installation on the DEC Rainbow, Pro 350, VT220, and VT240 terminals, and the VT100 terminal series.

With the screen, users can select from menus, position the cursor, and create and manipulate graphics by touching the display. The touch-screen controller is fully programmable, allowing baud rates, data formatting, calibration, and modes of operation to be controlled by the host computer. In addition, the controller is available with a form of nonvolatile memory, an EEPROM, for the storage of calibration values and other parameters. The controller also electronically averages the entire area of touch contact to a single discrete point. This average makes it possible to accurately manipulate even a single letter on the screen using a finger.

The kit offers a resolution of 1,024 by 1,024 touch points, allowing for flexibility in screen layout and the creation and manipulation of graphics. The vendor also offers software support with the kits. An optional firmware package, Command Point, is available, which runs independent of the host computer on the touch-screen controller. The program has all the code necessary to create and manage touch zones. In addition, the program runs on the controller card and is able to off-load work normally done on the host computer.

The kits can be installed by the customer or at the vendor's facility. Single unit pricing for any DEC Kit, including installation, is \$1,600. MICROTOUCH SYSTEMS INC., Woodburn, Mass.

FOR DATA CIRCLE 310 ON READER CARD
by Robert J. Crutchfield

They get a PC growth path. You get the control.

Introducing the TeleVideo Personal Mini.
The growth path for everyone.

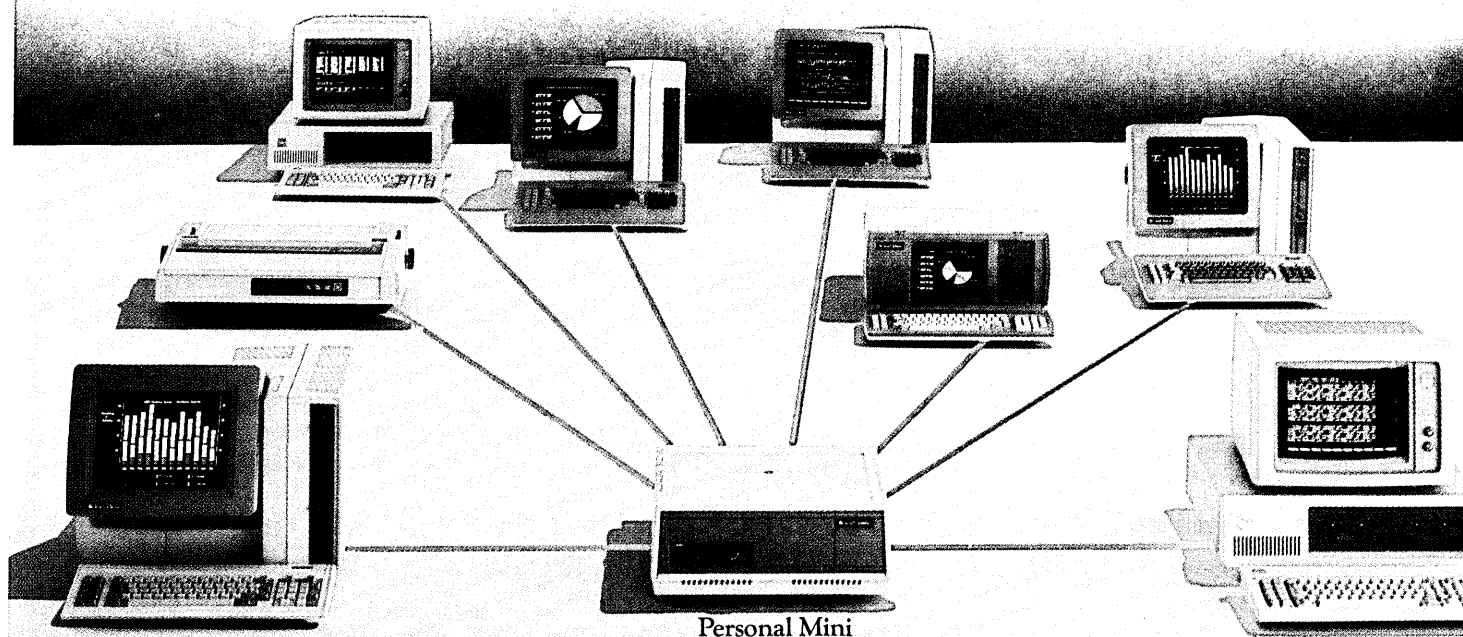

Personal Mini

People in your organization realized they outgrew their personal computers the first time they tried to share information or work together on a task. Standard PCs simply fall short of fulfilling their total business needs. Until now.

Until the TeleVideo® Personal Mini.™ It's the next rational step in your PC growth path. Just plug into it and grow.

Increases power and productivity.

It's the simple way to dramatically increase computing power and group productivity without sacrificing system manageability. It's the low cost way to network IBM® TeleVideo, and compatible PCs, as well as the new IBM PC AT.

Runs PC, multiuser and mini software.

Its powerful operating system easily supports popular PC software, mini-computer programs and especially multi-user applications development using such languages as RM/COBOL™ or MAI Business Basic.™ Without speed or performance tradeoffs. And with its 3270 emulation, any PC can talk to your mainframe. So your original investments in software, hardware and computer training can only become more useful.

Improves system management.

We also paid special attention to DP concerns. For reliability. System secu-

urity. Total system manageability. And of course, future growth.

The new Personal Mini. The first PC growth plan no one will outgrow. Ever.

Arrange to see it for yourself. Call toll free, 800-521-4897. In California, call 800-821-3774. Ask for operator 10.

Regional Sales Offices: Northwest (408) 745-7760, Southwest (714) 476-0244, Southcentral (214) 258-6776, Midwest (312) 397-5400, Southeast (404) 447-1231, Mid-Atlantic (703) 556-7764, Northeast (617) 890-3282, East (516) 496-4777, Rocky Mountain (408) 745-7760.

IBM is a registered trademark of International Business Machines. RM/COBOL is a trademark of Ryan-McFarland Corporation. MAI Business Basic is a trademark of MAI Basic Four.

The TeleVideo Personal Mini. The first PC compatible multiuser system.



Computers
© TeleVideo Systems, Inc.

Introducing connections for

With the new IBM Personal Computer AT/370, you can work with hundreds of VM programs and with mainframe data right at your desk. And only IBM offers a personal computer with VM capabilities.

Now that's a Smart Desk with very powerful connections.

The PC AT/370 lets you interact with your host computer, or operate stand-alone with the power of 64-bit System/370 architecture. It also gives you the ability to address up to eight megabytes of virtual memory.

There is faster response time because you don't have to wait for the host. And there is greater data privacy because programmers only have access to the host data they need.

You also get 20 or 40 megabytes of storage plus the capability of running thousands of existing IBM PC programs. This makes the PC AT/370 not only a powerful connection but also a very versatile one.

One further point: If you already have a PC AT or XT, it can easily be upgraded to a PC AT/370 or XT/370 respectively. Ask your IBM marketing representative for the details.

And if you want to receive literature on how the PC AT/370 can turn your desk into a Smart Desk, call 1 800 IBM-2468,

Ext. 82, or send in this coupon.

IBM®

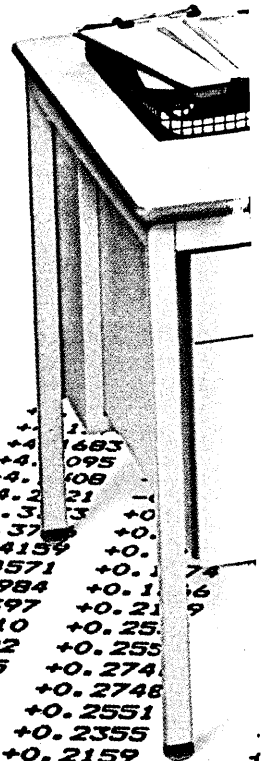

IBM 145
DRM, Dept. 3R/82
400 Parson's Pond Drive
Franklin Lakes, NJ 07417

Please send me more information on the new IBM PC AT/370.

Please have an IBM marketing representative contact me.

Name _____

Title _____

Company _____

Address _____

City _____ State _____ Zip _____

Phone _____

The Smart Desk from IBM

more powerful high-level thinkers.

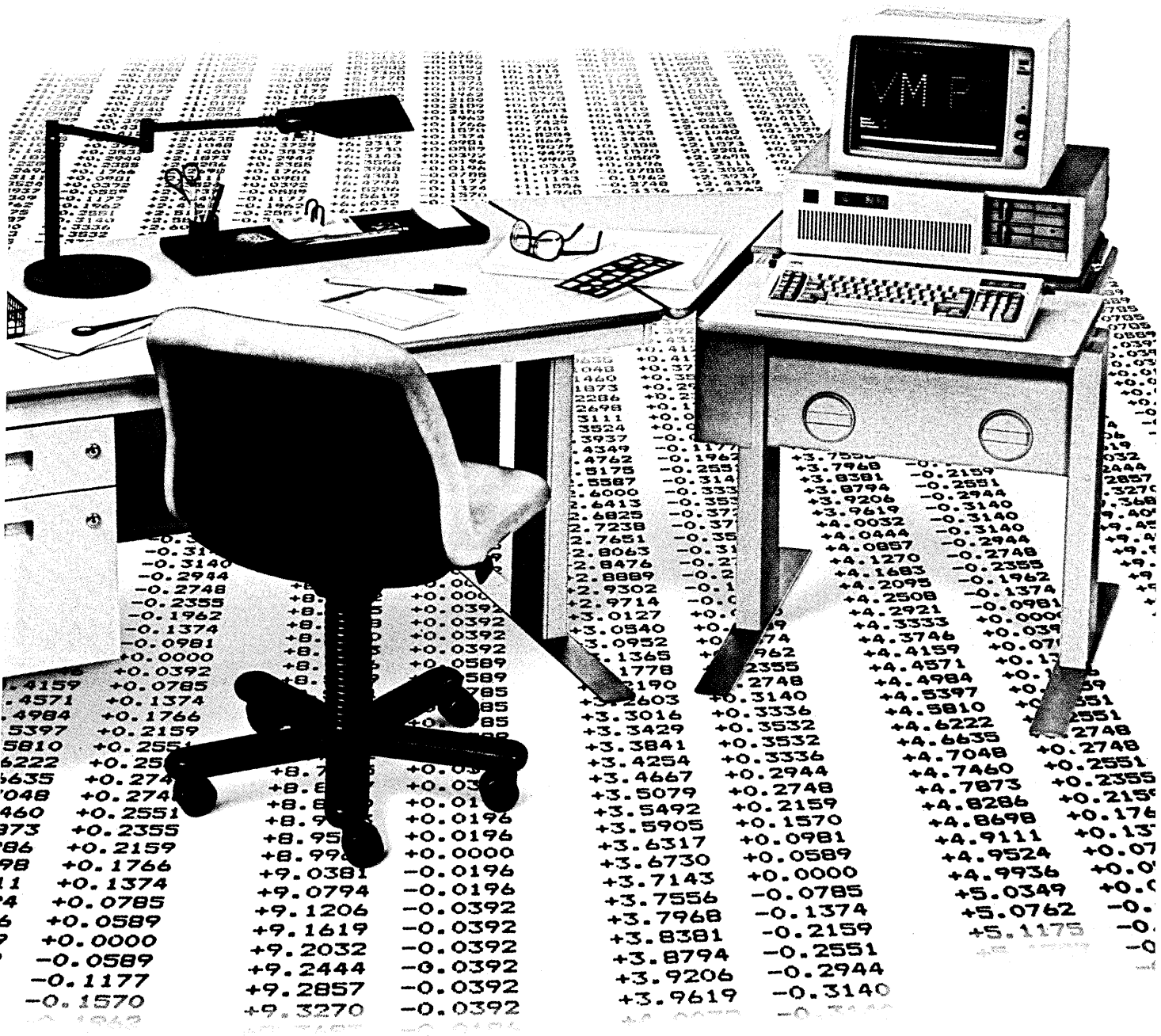



AFFORDABLY HYATT.

When you come to Hyatt, you always take away one surprising fact. The fact is, we're just as affordable as other hotels. What's surprising is that we give you so much more.

We give you our remarkably attentive Hyatt service, including express check-out and turndown service. A generous amenities package with fine soaps, shampoo and other essentials. Our rooms are spacious and elegantly furnished. Our restaurants are more inventive. You'll also find our friendly Hyatt atmosphere an asset when it comes to entertaining clients, when you want to do business with style.

Whether the company is covering your expenses or you're covering your own, no one will give you more for less. An affordable touch of Hyatt.

Don't you **WISH
YOU WERE
HERE**®

AUSTIN

Located downtown on Town Lake, surrounded by the central Texas hill country.

KNOXVILLE

Hyatt Regency at the Civic Coliseum looks over the scenic Tennessee River.

ORLANDO

Thrive in the sunshine at Hyatt, neighbor to Walt Disney World.

SAVANNAH

In Savannah's historic district, Hyatt views thriving Riverfront Plaza.

TAMPA

Hyatt Regency Tampa is downtown, 6 miles from airport, with health club, indoor whirlpool, outdoor pool.

HYATT  **HOTELS**

For reservations, call your travel planner or 800 228 9000. © 1984 Hyatt Hotels Corp.

CIRCLE 66 ON READER CARD

SOFTWARE AND SERVICES

UPDATES

When the name tag starts curling up on your lapel and you can't remember whose hospitality suite you're visiting, you must be in Las Vegas. Last year that city hosted three major trade shows; this year most users and vendors will be subjected to the city of lost wages only once, at next fall's Comdex. And judging from the reaction of some casino owners toward MIS conventioners, it seems to suit both parties just fine. During Comdex, a minor fracas arose when it was learned that the Circus Circus hotel had stopped accepting Comdex reservations weeks before the show. The hotel's rationale was that conventioners do not spend enough money at the gaming tables. Circus Circus preferred to leave its rooms open for people on vacation who, it said, spend more money gambling.

Never mind that the Comdex attendees paid full price for their rooms and food; forget the huge catering fees incurred by all those hospitality suites and parties; ignore the boon to the city's taxi business that 100,000 attendees represented. The attitude expressed by the hotels concerned Comdex's sponsor, the Boston-based Interface Group, and it met with the Las Vegas Convention and Visitors Association to address the issue. Granted, there are few places that can hold the Comdex show, and the size of the Las Vegas Convention Center must be considered. But the attitude of the town has changed. Courtesy has gone the way of the nickel slot machines and free food there. Yet the city's recent expansion of its convention facilities implies it wants to emphasize the convention trade.

Perhaps it is a question of the perception the locals have of out-of-town conventioners. Gautam Gupta, president of IDEAssociates, a Billerica, Mass., firm that makes peripherals for the IBM PC, summed

up the situation best when he noted that "Las Vegas only knows how to treat two classes of people well: high rollers and deadbeats." Let's hope the city changes its attitude about us low-rolling conventioners. After all, 100,000 of us using the nickel slots still adds up to a lot of money. In the meantime, it's worth noting that four trade shows -- the Office Automation, Interface, Softcon, and Comdex/Spring shows -- will all take place in one location at different times next year; see you soon in that much more pleasant city, Atlanta.

Since most people in the computer business end up visiting Las Vegas at least annually on business, it's about time someone developed a product for that market. Caesars World Inc. of Los Angeles and Screenplay Inc. of Minden, Nev., now sell a software package aimed at "helping players improve their skills through simulation of casino games as played in Nevada and Atlantic City." The first product is blackjack, to be followed by roulette, craps, and baccarat. If we all spring for the suggested \$70 price, Caesars may make high rollers out of us -- although it gets difficult to write off gambling debts on expense accounts.

Another unlikely game vendor is the public relations firm of Raymond Kowal & Wicks, Cambridge, Mass. It came up with "Big Buck\$, " a high-tech venture capital game. It's a high-risk, success-oriented board game that uses real-life events encountered by those who have staked their dreams on ideas and their second mortgages on their own ambition. The game follows the basic pattern of the many successes and failures of entrepreneurs, as players go through three levels of financing before reaching the holy grail: going public. No venture money was used in developing the \$19 game.

MICRO-TO-MAINFRAME LINK

Globe-Link/Real Time is a micro-to-mainframe link software package for data transfer between an IBM Personal Computer and any IBM 43XX series or plug-compatible host mainframe computer.

The product allows financial users to download and upload VSAM files between the host system and personal computer without special programming. Data created or modified on a PC can be uploaded to mainframe data files or special user libraries. Access to these files is controlled by multiple levels of passwords that ensure that only authorized users have access to the appropriate system and data.

Hardware requirements are an IBM PC, XT, AT, or compatible machine, 128KB RAM, one 160KB disk drive, and an IRMA 3278/3279 control unit or an asynchronous communication card and modem with a switched telephone line.

Software requirements are MS/DOS 1.1 or 2.0 for the PC. The mainframe requires CICS/VS Release 1.4 and above with ASYNC or 3270 protocol, DOS/VSE, OS/VSI, or MVS operating system, VSAM access method support, and COBOL DOS/VSE or OS/VS COBOL.

Additional features of the software include data extraction, summarization, and averaging of large files. Files may be transferred in several data formats compatible with the PC program. Error detection is provided by parity, block, and check character functions. Automatic retransmission after error detection ensures that only valid data is transferred. The mainframe portion of the Globe-Link/Real Time package is priced at \$10,000. GLOBAL-ULTIMACC SYSTEMS INC., Raleigh, N.C.

FOR DATA CIRCLE 326 ON READER CARD

FREE-FORM MICRO DBMS

This database management system is designed to let users store information in an unstructured form, without the restrictions of standard relational databases that organize information in rows and col-

SOFTWARE AND SERVICES

umns. While DayFlo permits the user to establish such categories, the field sizes are variable by record, and free-form data may be entered as well, the vendor claims. Moreover, fields may be added to particular records as needed, without reorganizing the database as a whole. The software can store up to 65,000 records of up to 32,000 bytes each. Unlimited record formats are permitted within a single database file and up to 100 separate indexes may be used per database. Sorts may be made on up to 10 keys at a time. The package enables limited word processing within any record, including cut-and-paste operations for preparing letters, memos, and other reports. Typical applications include indexing sales contacts, scheduling, tickler files, and project management. A more powerful report writer, ReportFlo, is also available. The cost of DayFlo is \$495 and ReportFlo is \$195. Both are designed to work on an IBM PC XT or AT with at least 320K RAM. Deliveries are immediate. DAYFLOW INC., Irvine, Calif.

FOR DATA CIRCLE 327 ON READER CARD

BUSINESS DATABASE

The Prompt database is designed for business analysts and planners to gain direct, on-line access to a comprehensive single source of textual information on industries, markets, companies, products, and technologies.

It contains abstracts of over 400,000 business-related articles published since 1980. Averaging 150 words in length, these abstracts are drawn from over 1,500 publications ranging from general interest and business periodicals to highly specialized journals. Included are studies of the industry and market trends, plus information on over 100,000 public companies.

The database is not limited to text. In many abstracts, numerical information

is presented in tabular format. More than 2,500 article abstracts are added to the database each week. The service is useful for investment research, corporate planning, portfolio management, merger and acquisition analysis, credit analysis, market research, and competitive analysis, among other applications.

The product is available through Screen, the same software through which users search, retrieve, and display information from the vendor's numeric-oriented databases. Screen also provides Prompt users with text-searching capabilities. By entering key-word qualifiers, users identify the companies, industries, or technologies they wish to study. Each abstract is coded by company, industry, and product, and geographical area. Users can begin with any of these qualifiers; the other qualifiers can then be used to continue the search.

Prompt can be accessed three ways: through traditional remote computing, through the ADP/Onsite Service, and through Datapath, which makes the database available to microcomputer users. The Prompt database was compiled by Predicasts Inc., and released by ADP Network Services. ADP NETWORK SERVICES, Ann Arbor, Mich.

FOR DATA CIRCLE 329 ON READER CARD

HUMAN FACTORS CAD

SAMMIE (System for Aiding Man/Machine Interaction Evaluation) is a CAD system that tests the comfort, viewing parameters, and movements of a person within environments prior to fabricating prototype models.

The system includes a computerized human model with built-in reach and sight capabilities, which simulate the movements of a person within a set of confines such as an airplane cockpit, car, office, or home. Virtually any size or shape person can be represented through

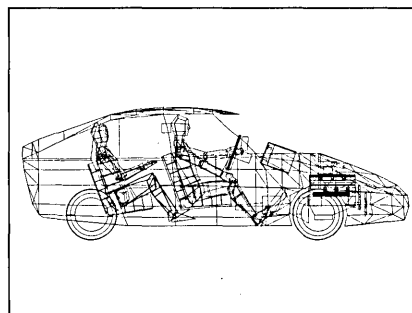

specific dimensional changes or statistical profiles of population groups. Analytical facilities include the ability for the user to "become" the model and look out on the designed objects or environments with the model's eye. Users can also interactively test the model's reach capability to any point in the workspace and can analyze the fit of differently sized human models into that given area.

According to the vendor, one feature of the system is its ability to identify no-hope situations early in the design process before mock-ups or prototypes are built. The product consists of three main groups of independent modules. The first group contains the three-dimensional modeling functions. The second provides the model and its related analysis facilities. The third group provides additional evaluation routines. It also communicates data to the vendor's three-dimensional modeling package, Prime Medusa, as well as to PDGS.

The system builds models of equipment or workplaces by specifying and assembling geometric shapes. The shapes are defined from this package or from another software link. The human model consists of 19 connected links representing a schematic human skeleton around which the three-dimensional solids are predefined to represent the outer contours of the human body. Another feature is the ability to create concave, convex, or plane mirrors on any surface in the workplace and to examine the reflections obtained from any vantage point. Mirrors can be automatically aligned so that particular objects appear in them from the chosen viewing position. There is also a facilities package used for visibility assessments. One routine automatically generates "Aitoff" projections, a standard requirement for aircraft cockpit visibility analysis.

All commands are English-like syntax and form. Many of the programs can be operated using the cursor as an alternative to command statements. Non-English versions of the system can also be produced. It is supported by a variety of monochrome and color terminals. SAMMIE can be sold standalone or in a bundled configuration. The system runs on the Prime 50 Series under the PRIMOS op-

SOFTWARE SPOTLIGHT

PC SELF-STUDY COURSE

"The IBM PC as a Business Tool" is a self-study course for business professionals looking to get the most utility out of the IBM Personal Computer. The course provides first-time users with comprehensive training in basic computer concepts, hardware, software, DOS capabilities, data protection, communications, and PC business applications.

The business applications addressed are spreadsheets, business graphics, word processing, database, and accounting applications. All these applications are taught with working software packages that are designed to illustrate general characteristics of software products. The software provided enables users

to combine the teaching examples with experimentation.

The course includes a set of diskettes containing the working software, cassette tapes, and a study guide with learning materials. Basic concepts are followed with practical business examples using the course software. The user is able to build a spreadsheet and graph it, and learn about accounting applications. Another feature is training in the Disk Operating System. Data integrity and protection are stressed throughout, as are backup operations.

The course sells for \$300. AUTOMATED TRAINING SYSTEMS, Woodland Hills, Calif.

FOR DATA CIRCLE 325 ON READER CARD

Oddly enough, most offices are better equipped for the future than the people who will create it.

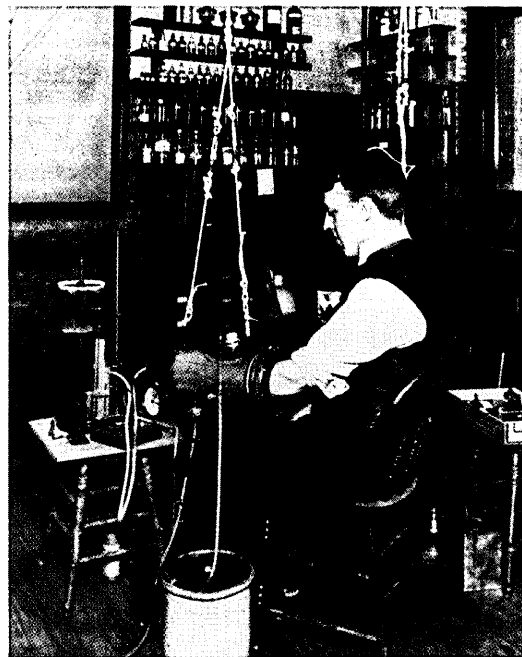

The MIT Museum

According to recent reports, this last year, businesses spent over \$10.5 billion automating America's offices.

Meanwhile, many of the scientists and engineers responsible for designing and developing America's new products are still using hand calculators.

Which is just preposterous.

Especially now that there's computer-aided analysis software that does what all technical professionals spend most of their time doing: analyzing data.

It's called RS/1™. And it's from BBN Software Products Corporation.

RS/1 is fully capable of making technical professionals 4-5 times more productive. Which in turn, will allow them to create considerably better, considerably more reliable new products. In a fraction of the time it now takes. In fact, a single copy of RS/1 running on a

single computer has already saved one company over \$7 million. In one plant. In one year.

Many leaders in American industry are already using RS/1 to get their new products out into the marketplace faster.

Don't expect them to tell you about it, though. They'd just as soon you continue spending your money only on getting your letters out faster.

For information call 1-800-251-1717, in MA 617-491-8488.

This one's for the VAX and PDP-11.

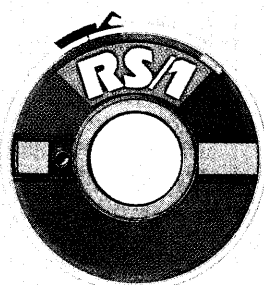

This one's for the PRO 350/380.



NOW ON THE IBM PC XT AND AT.

BBN Software Products Corporation

One Alewife Place, Cambridge, MA 02140

A Subsidiary of Bolt Beranek and Newman Inc. 

SOFTWARE AND SERVICES

erating system. Prices start at \$40,000 for the first license cost, which runs Prime 2250 and Prime 2550. The cost of SAMMIE for use with the remainder of Prime systems is \$50,000. PRIME COMPUTER INC., Natick, Mass.

FOR DATA CIRCLE 330 ON READER CARD

ARCHIVAL SOFTWARE

Disk FARMER (Disk File Archival Method with Easy Retrieval) is designed to be a highly productive addition to disk system maintenance on the Honeywell Level 66, DPS8, and DPS88 computers.

According to the vendor, it is capable of restoring disk storage capacity valued in the thousands of dollars, even on smaller systems. Its approach to both file archival and retrieval allows these savings to be attained with minimal effort, the vendor adds.

The software eliminates the waste of space on storage computer systems caused by the presence of infrequently used or unused files. These files originate as legitimate work files, distribution files for new or updated software releases, and as convenience or test files created by the programming staff and users of the computer system. According to the vendor, files that are not referenced for long periods of time tend to accumulate, leaving significant amounts of valuable disk storage space occupied by insignificant data.

The use of this product, in such circumstances, can initially recover extensive amounts of wasted disk space, and afterwards will provide additional returns when used on a scheduled basis. It will archive noncurrent files to tape. The occasional retrieval of archival files is a fully supported feature of the product, with the retrieval process typically requiring less than five minutes.

Through an on-line command that references a small archival database, the status of archived files and requests to return the file to permanent disk space may be entered and acted on without intervention by technical support or administrative personnel. Disk FARMER is available for a license fee of \$8,000 per cpu. EXECUTIVE SUPPORT PRODUCTS INC., Newport Beach, Calif.

FOR DATA CIRCLE 331 ON READER CARD

COMMUNICATION SOFTWARE

TRANSNET is an IBM mainframe-based communication software tool that allows previously incompatible office systems from vendors such as Wang and IBM to exchange editable text, data, and programs.

According to the vendor, the incompatibility problem is more critical to Fortune 1,000 corporations today than it was several years ago. This product allows most large organizations that have

many different office automation systems to communicate through IBM SNA.

Through SNA, this product provides communication among office systems utilizing Document Interchange Architecture and Document Content Architecture. The system is a fully compatible enhancement of IBM's DISOSS. This system aids in solving problems associated with networking IBM's office systems, such as the 5520 and 3270 TSO terminals, into an office environment.

The product supports the 5520 system and peripheral devices, Displaywriter, 3270 terminals, Wang OIS and VS office systems, and the PC Displaywrite II and Multimate word processing software products.

Using the product, two users can exchange text and edit identical documents on their respective screens, with each person's updates sent and incorporated automatically. The system also supports electronic mail distribution to an entire company of workstations supported by this product regardless of previous incompatibility, the vendor says.

Designed to be modular by function, transNet has a base price of \$35,000. Additional features are available that range in price from \$2,000 to \$35,000 each. NETWORK APPLICATIONS INC., Austin, Texas

FOR DATA CIRCLE 332 ON READER CARD

MICRO LINK SOFTWARE

The Personal Computer Support System links NCR mainframe computers to a variety of desktop micros. The software is designed to work with virtually any Intel 808X chip-based pc running under MS/DOS or CP/M operating systems.

The software also allows micros to perform like page mode terminals attached to the mainframe host via an asynchronous communication link. With PCDATBAS, PCSS allows the pc programmer to call the Total database management system via a standard DATBAS call.

With PCIO, the system allows the programmer to send and receive messages across the serial communication link to the mainframe, which allows development of sophisticated ddp applications. It also allows mainframe text files, which NCR calls SPUR files, to be downloaded to the pc for local editing via a micro editor program.

PCSS allows certain mainframe data files to be downloaded to a pc. Mainframe data can be brought to the pc or left on the mainframe, and the pc program can access the required data in either case, the vendor says. Personal Computer Support System prices vary. For users of Concom's T-COM, it's \$3,000 for the terminal emulation component and \$5,000 for the complete product. For non-T-COM users,

it's \$5,000 for the terminal emulation component and \$7,000 for the complete product, plus a 15% annual maintenance fee. CINCOM SYSTEMS INC., Cincinnati.

FOR DATA CIRCLE 333 ON READER CARD

ELECTRONIC MAIL SERVICE

RCA Mail is an integrated electronic mail service for business firms. The service, designed to operate with almost any type of computer terminal, uses uppercase and lowercase letters and a full 80-character-width screen.

It has a wide variety of message handling features, provides a complete interface to telex, and uses one-word commands. This service is part of a total electronic message service with access to the vendor's GLOBCOM domestic and international telex network. It can furnish around-the-clock communication with all major business centers in the United States as well as 18 overseas locations. The service may be connected to existing corporate communication systems.

It offers both intracompany use and public use via telex or electronic mail from a desktop computer terminal. The system uses English commands. There are no formats or lists of menus to sort through. Messages may be marked urgent, return receipt, registered, or private for only the addressee to read. Security levels can be assigned to members of the company using this service. Some users could be limited to reading routine messages, while others could have access to the full service.

A direct delivery option can be requested with the service so that incoming messages appear and are printed out on a terminal as they are received. A message also can be sent to arrive at a specific date and time. Information may be stored in a user's file so that it can be cross-referenced and retrieved or even edited while the user is away. With the service, a fill-in-the-blank form can be created for frequently sent messages and reports. Prices vary. RCA GLOBAL COMMUNICATIONS INC. (GLOBCOM), New York.

FOR DATA CIRCLE 334 ON READER CARD

CHANGE TRACKING SYSTEM

The ChangeTracker is an automatic change tracking system for load modules. It captures and records date, time, job name/user ID, and other statistics. An optional narrative describing the reason for the change is also available. A query/display facility provides management with an historical perspective for solving change-related problems. The ChangeTracker runs on the IBM/OS and costs \$6,500. SOFTWARE CORP. OF AMERICA, Herndon, Va.

FOR DATA CIRCLE 335 ON READER CARD

—Robert J. Crutchfield

The Marketplace... SOFTWARE SERVICES

ADVERTISERS' INDEX	
SOFTWARE SERVICES:	
Business Information Systems	145



CICS USERS

Screens Made Easy
BMS MAPS WITHOUT PROGRAMMING

ONLINE SCREEN DESIGN

AUTOMATIC BMS CODE COPYBOOKS DOCUMENTATION PROTOTYPING

ALL 3270 FEATURES

Business Information Systems, Inc.
3442 Stelhorn Road
Fort Wayne, Indiana 46815
219 - 485-9671

CIRCLE 501 ON READER CARD

"A little space."
— WILLIAM BLAKE
Songs of Innocence

"At little cost."
— KATHY MONAGHAN

Call me or Shirley Stirling for more details about the DATAMATION Marketplace at (800) 223-0743.

Ever wish you could start your day over?



Well, now you can!

Buy U.S. Savings Bonds and Get Your Future off to a Good Start!



Perform a death-defying act.

Have your blood pressure checked.

Give Heart Fund
American Heart Association

Payroll Savings for education ...and that's no CROCK!

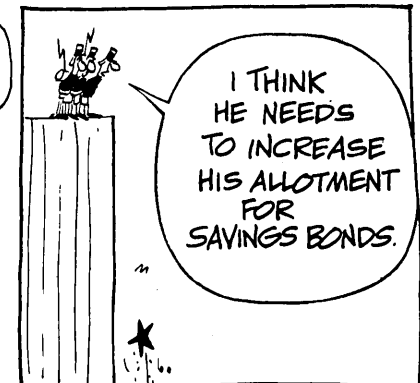
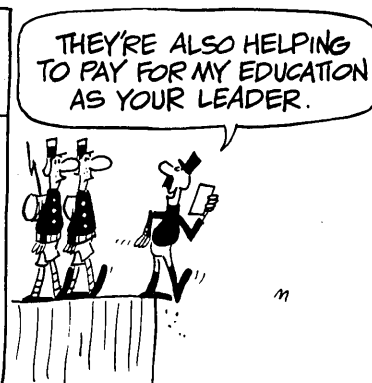

U.S. SAVINGS BONDS DIVISION
DEPARTMENT OF THE TREASURY

ACCESS INDIGE

INTRODUCING CONDUCTOR.
End-user access
to production data,
with full control
and security.

QUESTION?

Today — end-users need greater access to data. And MIS needs better control. To solve both problems, TSI introduces CONDUCTOR.

CONDUCTOR lets end-users get the data they need. CONDUCTOR selects, manipulates and delivers data to any end-user environment. Without programming. And CONDUCTOR gives MIS more control

than ever over quality and integrity, with a new degree of security.

While others have tried to solve the end-user problem, they've only addressed a small part. CONDUCTOR goes for the big picture. So remarkably different, there's virtually nothing else like it. Find out about TSI's CONDUCTOR today. And help eliminate access indigestion.

TSI International

DB a company of
The Dun & Bradstreet Corporation

For the facts on CONDUCTOR, call 1-800-227-3800, Ext. 7005 or write 187 Danbury Road, Wilton, Connecticut 06897.

CIRCLE 68 ON READER CARD

ON THE JOB

REGULAR, NO SUGAR, PLEASE

Coffee. The mere mention of the word sends images of the aromatic, ebony ambrosia coursing through one's senses in the wee hours of the morning. Hardly a day passes that, on your way to work, its fragrance doesn't permeate the atmosphere as you ride the elevators. Almost everybody drinks it, though all will argue about the best way to drink it.

For some, the beverage provides an opportunity to sit back and relax and

maybe mull over the day's events. For others, it stimulates the brain into the wide-awake, ready-for-action state needed for a hectic day. Still others avoid it like the plague, fearing dependency on it, perhaps opting for decaffeinated coffee to soften its side effects.

Beginning to sound like an advertisement? Maybe so, but in truth, a lot of office workers depend on it. You've shuddered at amber-stained mugs on some people's desks that look as though they

haven't been washed in days, maybe even weeks. You've seen ads on tv that just about promise instant success to the generation's "coffee achievers." Chances are, you've probably got a cup on your desk right now.

Since coffee is apparently an integral part of the workday, we've decided to take an informal look at how it gained its popular/unpopular status. Here are some of the responses we got from people in the industry when they were asked why they

ADVERTISING OFFICES

Advertising Sales Manager:

William J. McGuire
New York, NY 10022
875 Third Ave.
(212) 605-9715

Marketing Services Manager:

Kathleen A. Murray
New York, NY 10022
875 Third Ave.
(212) 605-9723

Eastern District Managers:

Francie Bolger, John M. Gleason
New York, NY 10022
875 Third Ave.
(212) 605-9400

New England District Managers:

Jack Orth, John M. Gleason
Newton, MA 02159
181 Wells Ave.
(617) 964-3730

Mid-Atlantic District Mgr.:

Patricia Joseph
Plymouth Meeting, PA 19462
Plymouth Plaza, Suite 201
(215) 825-4410

Southern District Managers:

Michael W. Andrea
4 Executive Park Drive N.E.
Suite 1205
Atlanta, GA 30329
(404) 633-5112

Warren A. Tibbetts

West Palm Beach, FL 33406
7621 West Lake Dr., Lake Clark Shores
(305) 964-6298

Southwest District Mgr.:

Randall A. Clark
1700 Eastgate Drive
Suite 103
Garland, Texas 75041
(214) 270-6461

Midwest District Mgr.:

Joseph P. Gleason
Chicago, IL 60601
3 Illinois Center Building, 303 East Wacker Dr.
(312) 938-2926

Western District Managers:

William M. Wilshire
Irvine, CA 92715
2061 Business Center Dr., Suite 111
(714) 476-2511

Robert J. Rielly

Los Angeles, CA 90035
1801 S. La Cienega Blvd.
(213) 559-5111

James E. Filiatrault, Janet Engelbrecht

Mountain View, CA 94043
2680 Bayshore Frontage Rd., Suite 401
(415) 965-8222

U.K., Scandinavia, Netherlands

Director - European Operations
Martin Sutcliffe, Robert Saidel
Technical Publishing Co.
130 Jermyn Street, London, SW1 4UJ, England
Tel: (44 1) 839-3916, Telex: 914911 TECPUB G

France, Belgium, Luxembourg, Spain

Vivien James
Technical Publishing Co.
130 Jermyn Street, London, SW1 4UJ, England
Tel: (44 1) 839-3916, Telex: 914911 TECPUB G

Germany, Austria, E. Europe

Martin Noble
Technical Publishing Company
6000 Frankfurt 1
Steinweg 7, W. Germany
Tel: (49 69) 28-80-63, Telex: W. Germany 4170039
TECP D

Italy:

Luigi Rancati
Rancati Advertising
San Felice Torre 5
20090 Segrate, Milano, Italy
Tel: 2-7531445, Telex: 311010

Switzerland:

P. J. Ruckstuhl
ALAS AG
Business-Centre
Schoegrund 1
CH 6343 Rotkreuz, Switzerland
Tel: (42) 642964, Telex: 864958

Japan:

Hiroshi Sato
IRM, Inc.
Rosei Building, 4, 1-Chone,
Higashi-Avabu, Minatoku
Tokyo, Japan
Tel: (03) 583-1161, Telex: 242-2588 IRMTOKJ

John K. Abely, President

Robert L. Dickson, Exec. Vice President
Edwin V. Burkholder, Senior Vice President/
Technology

Walter M. Harrington, Vice President/Finance
and Administration

Technical Publishing

BB a company of
The Dun & Bradstreet Corporation



NORTHROP



Data Processing Professionals:

WE BRING COMPUTER TECHNOLOGY AND PEOPLE TOGETHER

Northrop DSD, as a leader in the electronics industry with annual sales of \$250 million, continues to grow to meet the needs of its customers. Outstanding opportunities are available to those business data processing professionals who aspire to share in our commitment to excellence and advanced state-of-the-art technology.

WE OFFER:

- Environment utilizing an IBM 308X running MVS and IDMS Data Base Management System; CICS command level; COBOL
- Outstanding growth potential
- Competitive starting salary and full range benefits package, including tuition reimbursement, savings plan (401K), relocation assistance, generous vacation plan, health and dental coverage

Our current expansion includes openings in:

- **TECHNICAL SUPPORT**
- **SYSTEMS & PROGRAMMING**
- **INFORMATION CENTER**
- **OPERATIONS**

For immediate consideration, forward resume with salary requirements in complete confidence to: **Mr. David Kornhauser, Employment Representative, Dept. DP002, NORTHROP CORPORATION, Defense Systems Division, 600 Hicks Road, Rolling Meadows, IL 60008.** An equal opportunity employer M/F/V/H. **ONLY PRINCIPALS NEED APPLY.**

NORTHROP

Defense Systems Division
Electronics Systems Group

ON THE JOB

drink coffee:

"Speed." (Hmm. And word economy, too?)

"There's a little demon who lives in my right-hand drawer," said one aficionado. "I drink most of the cup, and pour a splash into the lid for him. He laps it up and rushes off, and sometimes doesn't interfere with my work again until 11:30 or so."

"Because it's better than shooting heroin."

"Never touch the stuff, it keeps

me up forever, and gives me the shakes."

"I can't even *talk* to anyone till I'm into my second cup."

"We couldn't run this place without it."

"The coffee here is so strong it doesn't even need a cup. I don't go near it."

One Silicon Valley flak likens decaffeinated coffee to low-lead gasoline, claiming that people "go ping" when they walk upstairs after drinking it.

The head of a New York-based

high-tech newsletter thinks that the way businesses run their coffee mills reflects the way they view their employees. "We're a small operation, yet we have a real nice setup. We've got espresso as well as regular coffee, and real cups, saucers, and spoons. There's even a bottle of Armagnac and a bottle of high-grade Scotch right next to the coffee maker. These big companies that throw any kind of cheap coffee at their employees are just basically treating their people as if they were furniture."

"It makes me sick."

Certain health complications can result from excessive caffeine indulgence. Doctors believe that dietary-induced methylxanthines (caffeine) can cause cysts in women's breasts (coffee, chocolate, and soft drinks are some of the caffeine-rich culprits blamed for benign fibrocystic breast disease).

According to *Prevention* magazine (published by Rodale Press, Emmaus, Pa.), "coffee nerves"—shaky hands and an overall jittery feeling—can be apparent within an hour of drinking as little as one cup of coffee. It doesn't take much to overindulge either; the journal says you can easily down three cups of coffee, two Cokes, and, say, two Excedrins in the course of a day and chalk up 560mg of caffeine. How so? The average cup of brewed coffee can pack a 105mg wallop of caffeine. And don't think you can get around it by drinking tea. A strong cup of English Breakfast tea delivers an equivalent dose, and even your average cup of Lipton or Tetley tea can contain as much as 70mg. of the drug. A can of Coca Cola contributes 64.7mg. of caffeine, and two Excedrin tablets go for around 130mg.

The Journal of the American Medical Association reported that doses of more than 250mg a day can produce distinctly observable and undesirable effects on the nervous system, and that both excessive use of caffeine and the effects of withdrawal from it can cause symptoms indistinguishable from those of an anxiety neurosis.

The American Pharmaceutical Association's *Handbook of Nonprescription Drugs* notes that "Doses larger than 250mg often cause insomnia, restlessness, irritability, nervousness, tremor, headaches, and, in rare cases, a mild form of delirium manifested as perceived noises and flashes of light" (5th edition, 1977).

Any of these symptoms sound familiar? Crts and vdts are currently in the hot seat for the very same complaints. So before you run off thinking your terminal is to blame for any of the above symptoms, better take a look at your diet first, and see if maybe caffeine isn't the problem.

—Lauren D'Attilo

Manager, Competitive Product Information

Burroughs Corporation's Corporate Product Information Group provides documentation and training material vital to our continuing leadership in the information processing industry. Maintaining our strong presence in a very competitive marketplace has created a position for an experienced Competitive Product Information Manager in our Detroit World Headquarters.

Your major responsibility is to provide recommendations and direction on how to improve the quality and effectiveness of Burroughs product documentation. You will evaluate competitive documentation and judge its image, content, and competitive posture. You will consider marketing practices, media, packaging, and development processes.

The ideal candidate should possess executive potential, breadth of vision and clear understanding of the product information segment of the information processing industry. You should have a minimum of a Bachelor's degree with a preference toward a technical writing or education technology degree, 10-15 years' experience in both technical writing and direct customer contact. A high degree of analytical capability and 30% to 40% travel are required. A background in consulting is highly desirable.

Burroughs offers an excellent salary, outstanding benefits and great potential for recognition and advancement. For confidential consideration, send resume and salary history/requirements to:

Manager, World Headquarters Employment
Dept. DAT-115, Suite 1C26
Burroughs Corporation
Burroughs Place
Detroit, MI 48232
An Affirmative Action Employer

Burroughs

THE QUESTION ISN'T WHO'S BIGGER.
IT'S WHO'S BETTER.

One of the simplest
reasons to buy

it.

Digital Ser





From the moment you choose Digital, our service organization goes to work to protect your investment. We'll develop your software applications. Train your employees. Keep your system up and running. We're ready to provide the support you need, whether you are running a single system or a large network of systems. Our engineers have even worked alongside customers to build new computer sites with the proper power, air conditioning, and fire protection. From start to finish, Digital Service is a smart decision.



Our people help your people develop the skills they need to get the most out of your Digital computer. We offer more than 500 courses on hardware, software, and office automation. At Digital's worldwide Training Centers. Or at your location. And, at your request, we will even customize training to meet your special needs.



Because no other business is like yours, Digital's software experts help you select the right applications for your business. Or they tailor programs to fit the way you work. And whenever you need the answer to a question or problem, specialists trained in your software applications are only a phone call away.

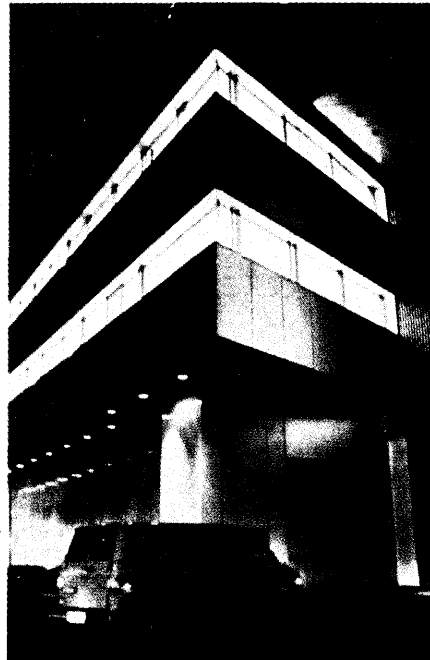

You select the level of service you need: whether you need on-site hardware support 24 hours a day, seven days a week, with our unique commitment to when service will begin, or the economy of carry-in or mail-in services. Digital gives you a choice.



Digital has over 20,000 service professionals worldwide to give you peace of mind with fast, personalized service. And we deliver that service when and where you need it. That's why Digital Service is the smart choice.

Digital Service is everywhere, because Digital's customers are everywhere. Our specialists regularly service Digital's systems on remote islands. On board ships. Even at the South Pole.

For more reasons to buy Digital Service, call 1-800-DIGITAL.

digital™

© Digital Equipment Corporation 1984

CIRCLE 69 ON READER CARD

IN 1985 ... MANUFACTURING TECHNOLOGY STRIKES TWICE

TWO GREAT SUPPLEMENTS ON THE HOTTEST TOPIC IN INDUSTRY

APRIL

As more and more companies hand production over to automation, they're discovering that doing it successfully means piecing together their own resources. Job functions interweave, manufacturing techniques are shared, islands of automation come together in networks.

Manufacturing Technology: Coverging on Automation explores how industry is making the transition from manual to technological production methods.

Be there with news of your own product or service. Take advantage of this rare advertising opportunity in the April issues of four prestigious magazines.

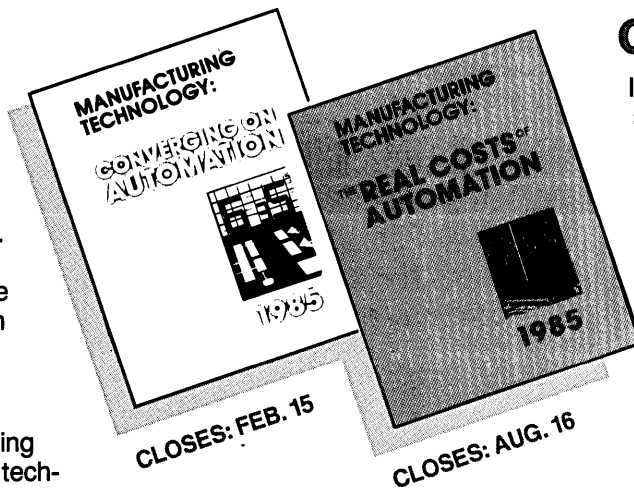

OCTOBER

Industry leaders need to understand and anticipate the latest technology coming to their plants. So put your product or service where they read, in this exciting supplement appearing in the October issues of four leading magazines.

Manufacturing Technology: The Real Costs of Automation looks beyond the price of machines. Examines the real costs of automation as

more and more companies learn to make the most of their resources—factory, finance, and personnel—to increase their paybacks on high-tech installations.

REACH OVER 400,000 KEY DECISION MAKERS IN THESE FOUR LEADING MAGAZINES

Not once, but twice! Two special supplements on MANUFACTURING TECHNOLOGY—the dominant topic among industry's key decision-makers and a great place to advertise computer/peripheral hardware and systems, MRP software and services, CAD/CAM systems and CAE workstations, robotics equipment, programmable controllers, data collection, factory automation systems, material handling systems.

You'll reach top corporate executives, managers,

engineers, consultants, EDP professionals—all in the manufacturing SIC's (20-39 & 89). And you'll reach them at a cost far below the combined rates of these four outstanding publications.

Technical Publishing

DB a company of
The Dun & Bradstreet Corporation

1301 So. Grove Ave., Barrington, IL 60010 • (312) 381-1840

A MAGAZINE WITHIN A MAGAZINE

CONTROL ENGINEERING

Process control valves
Computerized numerical control
Servo design

WITHIN A MAGAZINE

DATAMATION

WITHIN A MAGAZINE

BUSINESS MONTH

WITHIN A MAGAZINE

Plant Engineering

READERS' FORUM

SOFTWARE DESIGN SHUFFLE

We have many good methods today for software development and for project control. Somehow, though, we are stuck with the same poor software products and slipping project schedules. My theory is that there is a simple behavioral reason behind this: bad solutions are actually encouraged, and good solutions are not encouraged enough. Although my experience is with companies producing hardware and software for an international market, I believe that many professionals in other parts of the computing field will recognize the following situations.

Assume we have two equally difficult software design tasks: System A and System B. Two equally qualified project teams of about the same size are set up.

Project A is done carefully and in accordance with the project control and design methods prescribed by the company manuals. There are walkthroughs where every part of the design is critically scrutinized, and the original design is revised in depth more than once prior to detailed design and programming. The project manager has a close grip on the technical solution although the details are worked out by other team members. The construction becomes robust and consistent.

The project exceeds the original time plan slightly and uses up more manpower than was intended, but the deviations can easily be accommodated with the section's resources. Nobody above the level of the section manager is very much aware of the project.

Eventually, System A is ready for installation at customer sites. The confrontation with reality necessitates some adjustments, and it turns out that the user documentation has to be clarified at certain points. There are also some error reports, which lead to corrections, and a second release of the system. The corrections are minor, however. Essentially, the design proves viable and does not require major modification.

After the first few installations, the system is handed over to a maintenance group in the line organization. The transfer of knowledge does not pose any particular difficulty. As a by-product of all the walkthroughs and reviews, a lot of material is available on the different aspects of the system. In addition, the documentation is in fair shape, and the programs readable, if not fully up to the somewhat bureaucratic standards laid down in the programming handbook.

Ultimately, the project team members are assigned to other tasks. Unfortunately, there is no new challenging project

being started at the moment, so even some senior team members are given rather simple assignments. Some feel they are actually demoted after having made a near-perfect job of System A.

Within the company, System A earns a good reputation. It is a solid product to be proud of, and the salespeople find it easy to sell. Positive reactions from satisfied customers are readily available whenever a prospective client needs further convincing. In the development department, some say the project was unusually favored at resource allocation time. The system seems straightforward, so the task was probably not very difficult. It could have been carried out with less development manpower.

Project B has problems from the start. The project manager has an idea how to solve the problem in principle, but never gets the chance to control the project technically. For one thing, he has some unique knowledge about a certain other project that needs much postinstallation maintenance. In addition, there is one technically challenging part of System B for which he has a brilliant solution, and he wants to work out the details. So, most of the construction work is carried out independently by other team members without organized coordination.

In the beginning, the members of Project B feel they have great opportunities to realize their own technical ideas. They hear some members of the Project A team complain about having their "brainchildren" treated rather severely during design revisions and walkthroughs.

After some time, Project B is seriously behind schedule. Promises made to customers cannot be kept. When word of this gets around, some of the salespeople express their concern to the development department manager, who then demands a report. The project manager provides an in-depth technical description of the system, which obviously is extremely complex. But the current situation is rendered in optimistic terms: almost all the program modules are 90% programmed, and those parts still to be designed are minor supporting functions, such as system initialization and termination, the user interface, and some utility programs that will probably be necessary to operate the system. The new schedule attached to the technical report is called "realistic."

Somehow, the project seems to remain at the 90% stage for quite some time.

After a few more schedule revisions the department manager is again seriously concerned. At an informal meeting the project manager is obliged to confess that he cannot deliver a reliable ready date. By now it is also clear that the performance requirements will not be met: in fact, the system will be only slightly better than the obsolete system it is intended to replace.

These serious developments must be brought before the general manager, and the project is discussed at an interdepartment meeting. Cancellation is seriously considered, but the mar-

READERS' FORUM

keting people refuse. Too much time has been lost and the old system is hopelessly outdated. There is no alternative to offer the marketplace.

The project is given some additional resources, and after a great deal of mending and patching the product is considered acceptable. It is released, and installations start all over the world at sites where customers had almost given up waiting and threatened to change suppliers.

By this time the project manager, an outstanding technical expert, has been promoted to a position in which he is responsible for the introduction of future technologies. Several other team members have also left. The project is run directly by the section manager. The department manager is also deeply involved and technical questions around System B take up a large part of the weekly department meetings.

When System B's installations are up and running, things go from bad to worse. Error reports start pouring in. There are some fatal problems. The general manager receives telexes from key customers demanding immediate, on-site support. A crisis is at hand, and fast decisions are necessary. A task force is set up, comprised of the remaining team members and others who were involved at different stages of the project's development. They report directly to the general manager. Within a couple of days expeditions have been sent to Hong Kong, Paris, Toronto, and Wellington, New Zealand.

The entire company now knows that System B is very complex. All understand that it was badly designed from the start, but now it is obviously necessary to save the existing situation. The members of the task force win prestige. They make glamorous trips to other countries and give technical reports on the situation at each customer site to the general manager himself. Their fame is well earned: in-the-field debugging of a none-

too-well-designed system is a demanding task.

Years after the start of Project B the task force members are still indispensable. Although some sincerely try to get other assignments, their personal success is based on their unique knowledge of System B.

Moral of the story: make a bad system and concentrate on complicated error correction; you become a celebrated expert. Put in a serious effort to find the best possible solution from the start and run a well-disciplined and complicated project; since the task appears simple, you go unnoticed.

Unintentionally, management has encouraged the bad system solution provided by Project B. Those team members get exposed to upper management. They get to make the glamorous trips. They are admired by all.

The members of team A will be regarded as honorable and faithful employees—the type that receives a gold watch after 25 years. By some, they are regarded as introverted theorists. Still, that group is where the real expertise is found; that's where the truly professional work has been done.

Management must understand the inherent complexity of a task and not confuse it with the complexity of the solution. It is easy enough to find a complicated solution to a simple problem, but it takes a lot of effort to find the easy solution to a difficult task. Steps must be taken to encourage the solid, methodical work, and stop the emergency actions from getting all the attention.

Good software design requires an intellectual effort; new methods and standards alone are not enough. Without this intellectual effort, even the most conscientious professionals will choose the easy way out. They'll allow projects to run wild, which can only result in bad systems and frustrated programmers.

—Bo Sanden
Monterrey, Mexico

DIGITS BY ROY MENGOT



A TRAINING ALTERNATIVE

At modern data processing installations, the individual who provides employee dp training is bombarded with ads on everything from video assisted instruction and computer-based training to public seminars and consortium training. Some training methods use high-tech techniques, and most are expensive. For example, if an installation sends just one employee to a week-long public seminar, costs incurred include tuition, travel, hotel, and meals. The bill can easily total \$2,000 or more. How can most installations afford to train their staffs at such rates?

At Blue Cross and Blue Shield of North Carolina, Durham, we found an effective and reasonably priced way to deliver dp training: we run technical seminars. To make this idea work, a company needs an employee who acts as the training coordinator. This is a full-time job for medium to large data centers, but smaller companies could have this role filled by an employee who allocates only part-time efforts to the task. The training coordinator must find out what type of dp training the organization really needs, since staff members frequently ask for classes that may be of little real benefit to the organization.

Once the needs have been established, the trainer should find out, for each class, which employee has the greatest expertise in that subject area. Next, the training coordinator must get the in-house expert to agree to teach this subject. The expert is usually more than willing for a couple of reasons: it is an ego boost to be asked to teach or speak to a group, and the prospective teacher has an opportunity to head off potential problems

How to earn an MBA in one day.

LIMITED EXHIBIT
SPACE AVAILABLE
CALL 800-OAC-1985

MASTER OF BUSINESS AUTOMATION.

This certifies that

John Doe

has successfully completed the requirements for
MASTER OF BUSINESS AUTOMATION
by attending OAC '85 at the Georgia World Congress Center,
Atlanta, Georgia.

Having visited the world's largest exhibit and conference
on Business Automation, the above named is an expert on
the ways Business Automation can improve productivity,
efficiency, and profitability.
OAC '85 February 4-6, 1985

Alford Thomas *John Doe*

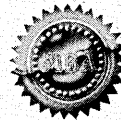

Attend OAC '85, February 4-6. And master the Business Automation revolution.

This is your only chance to see the largest, most extensive business automation exhibit and conference in the world.

February 4-6, Georgia World Congress Center, Atlanta Georgia.

See 150 major exhibitors including:

Apple Computer Inc.	Honeywell Information Systems
AT&T Communications	IBM Corporation
AT&T Information Systems	Lanier Business Products
Bell South Services	Minolta Corporation
Bell & Howell	McGraw Hill
Burroughs Corporation	NCR Corporation
Data General	NEC Information Systems, Inc.
Dictaphone Corporation	Radio Shack
Digital Equipment Corporation	Sperry
Dupont Company	Wang Laboratories
Eastman Kodak	Xerox Corporation
Hewlett-Packard Co.	

It's office automation and much more:

- Complete Conference Program with over 48 sessions in 6 program tracks:
- organizational impact of technology • office workstations
- ergonomics of the workplace • networking applications
- communications technologies and issues
- productivity and requirements evaluation
- Conference Keynote-Howard Anderson, Managing Director of the Yankee Group.
- 12 in-depth Professional Development Seminars
- The latest in Automation, Communications and Integration, including telecommunications and software
- Micro to mainframe connection

Get in the forefront of the
**Business Automation
revolution. Order your
registration information now.**
Call 800-OAC-1985

I can't afford to miss OAC '85. Please
rush me my registration information.

Name: _____

Title: _____

Company: _____

Address: _____

City: _____ State: _____ Zip: _____

Mail to:
OAC 85 AFIPS 1899 Preston White Dr. Reston, VA 22091 GD

OAC
'85
THE WORLD'S
BEST

Get Ahead of the Gang



Face it. We could all use a little concrete advice now and then.

Whether you're making a monumental decision like a career change, or a more routine one like an oil change, the free Consumer Information Catalog can make it easier.

The Catalog is published quarterly by the Consumer Information Center of the U.S. General Services Administration to bring you the latest on government programs and a mountain of other information that you can use.

The Catalog lists more than 200 government booklets to help you... start a business, find a job, plan your retirement, repair your home, or carve out a nutrition and exercise program to improve your profile. And many of these booklets are free.

So order your Catalog today. Any way you look at it, you'll be head and shoulders above the crowd.

Just send your name and address on a postcard to:

**Consumer Information Center
Dept. MR
Pueblo, Colorado 81009**

A public service of this publication and the Consumer Information Center of the U.S. General Services Administration



READERS' FORUM

long before they happen, since training will show programmers the correct (read: company preferred) way of performing certain tasks.

After the instructors are lined up, the training coordinator can begin to schedule the technical seminars. At Blue Cross, we hold information systems seminars once a week for as many weeks as necessary, from 10 a.m. to 11:30 a.m. This method has several advantages over a single all-day class. Managers are more willing to let their people attend since loss of staff time in class is more spread out, reducing the impact on projects. If an employee is having difficulty understanding some of the subject matter presented in a seminar, he or she has the opportunity to learn the material prior to the next seminar. In a one- or two-day class, that same employee might be hopelessly lost or might hold others back.

We've been offering technical seminars to data processing staff members for the past five years. Subjects most frequently taught are:

- IMS batch programming
- IMS TP programming
- advanced IMS calls
- Easytrieve/IMS
- the linkage editor
- COBOL internal sorts and report writer
- MVS dump reading
- OS job control language.

The number of sessions per course varies, depending on the attendees' needs. For example, the linkage editor may require only one session, while MVS dump reading often requires eight.

One of the primary reasons that staff interest in our classes runs so high is that in-house experts are the teachers. For most of the seminars, we have one instructor in information systems who is well prepared to teach. Our goal is to have two or three instructors ready to teach each class so the same person needn't be called every time.

Keeping up with developments in dp sometimes seems impossible. Technical seminars are one way for an organization to keep its data processing staff apprised of the information that will help them be as productive as possible.

—Mark Johnson
Durham, North Carolina

THE NEXT RUNG

Managing an organization successfully is a difficult task; managing one that involves computer professionals can be even more difficult because many of these people want a lot from their work. According to studies by Drs. J. Daniel Couger and Robert A. Zawacki, software professionals "have a stronger need for personal growth than any other professionals... and a negligible need for social interaction" (see "What Motivates Dp Professionals?" September 1978, p. 116). The computer nerd—the programmer who spends most of his time at a terminal working on a tough problem, forsaking many normal human activities—has become familiar to the point of stereotype.

Obviously, a person so obsessed with computing will eventually encounter difficulties and may cause serious problems for others if moved into a supervisory or managerial role.

It's ironic that the same traits that lead to success in the technical side of computing may lead to failure in the managerial side. This is a painful application of the Peter Principle, which postulates that in every hierarchy each employee tends to rise to his or her own level of incompetence. Here, however, the incompetence can be very subtle in that it involves the psychological rather than technical skills of highly talented people.

ADVERTISING INDEX

AST Research	26
Access Technology	80
Account-A-Call Corp.	9
American Hoechst	119
Ansul	48
Astrocom Corp.	159
BBN Software Products Corp.	143
BTI Computer Systems	113
Boeing Computer	92
Bridge Communications	130-131
Bull Computer	16-17
Burroughs Corp.	150
*C. Itoh Electronics, Inc.	128-16
Cambridge Systems	160
Codex	5
*Comdex Japan	128-14
Computer Associates	24-25
Computer Graphics '85	68
Cullinet	4, 12
D & B Computing Services	47
Datapoint Corp.	87
Dataproducts	19
Decision Data Computer Corp.	89
Digital Communications Assoc.	129
Digital Equipment Corp.	55-57
Digital Equipment Corp.-CSD	152-153
DunsPlus (div. D&B Computing)	135
ELXSI	37
Emerson Industrial Controls	79
GTE	151
General Optronics	84
*General Power Systems	128-13
Hewlett-Packard	124-125
*Hitachi	128-2/3
Hughes Aircraft Co.	75
Hyatt Hotels Corp.	140
IBM Corp.	106-107
IBM Corp.	138-139
IBM Credit Corp.	28-29
*ICC-Europe	128-31
*ICC-U.S.	128-29
ITIC	98-99
*ITT Information Systems	128-19
Index Technology	41
Infotron Systems	2
*Integrated Business Computers	128-7
*Interactive Systems	128-9
*Logitech, Inc.	128-23
M/A-Com Linkabit	67
Manufacturing Technology	154
Maxell Corp. of America	22
McCormack & Dodge	33
Memorex Communications	90-91
Memorex Computer Tape Div.	60-61
Micom Systems	Cv. 4
Motorola/Four-Phase Systems	82-83
N.B.I., Inc.	52-53
*NCR Corp.	128-10/11
Network Systems Corp.	97
Northern Telecom Inc.	132
Northrup	149
*Nova Graphics	128-4
OAC '85	157
On-Line Software Int'l	48
Oxford Software Corp.	95
Paradyne	100
Perkin-Elmer	1
Persoft, Inc.	47
Philon	58
Pilot Executive Software	35
Precision Visuals	81
Protocol Computers, Inc.	64-65

Quadram	105
Racal-Vadic	70-71
Renex Corp.	126
Roim Corp.	10-11
SAS Institute Inc.	Cv. 2
SPSS	15
SOFTCON	51
Software AG	42-43
Sperry Corp.	39
Sterling Software Marketing	63
TAB Products Co.	123
TSI International	146-147
Tact Technology	50
Tandem Computer	20-21

Technology Transfer Institute	8
Tektronix, Inc.	6-7
TeleVideo Systems, Inc.	111
TeleVideo Systems, Inc.	137
Tesseract Corp.	77
Texas Instruments	Cv. 3
*Thorn EMI Datatech Ltd.	128-26
Transnet Corp.	88
Tymnet	121
Ungermann-Bass	114-115
*Unify Corp.	128-20/21
*Wang	128-15
*Xebec Corp.	128-24/25
*OEM Edition	

Learn about the new fiber you need for your communications network.

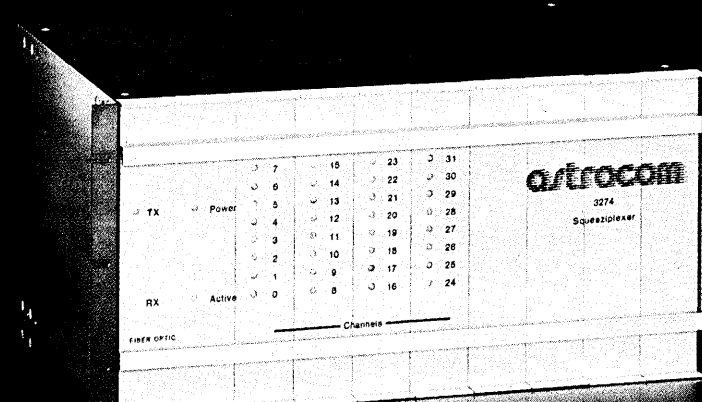

Now Astrocom's **SQUEEZIPLXER**® the unit that's been saving people space, time and money in local IBM® 3274 networks comes with a Fiber Optic cable option. With features like:

- Interference-free operation
- High transmission security
- Longer signal distance
- Lightning immunity

If this looks good to you, write or give us a call. Then let Astrocom provide the new fiber for your communications network.



120 W. Plato Blvd., St. Paul, MN 55107
(612) 227-8651 Telex: 297421

SQUEEZIPLXER is a registered trademark of Astrocom Corporation.
IBM is a registered trademark of International Business Machines

Industry Standard Features

Industry Standard Features

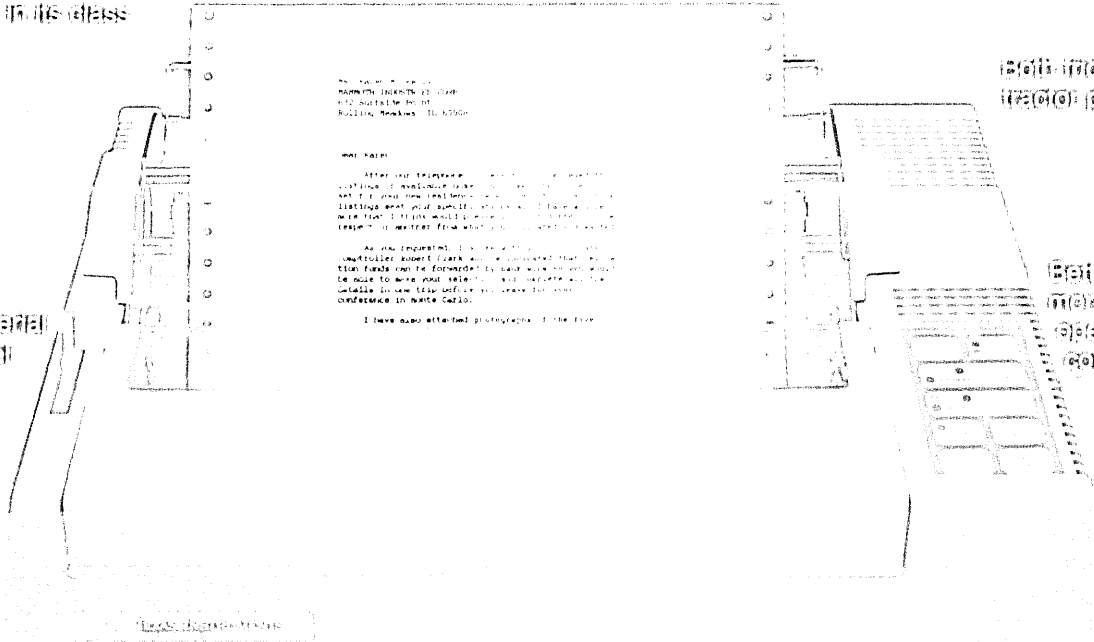

Reliability

Compatibility with Industry Standard Proprietary Software

Compatibility with Industry Standard Proprietary Software

TI-855: THE MOST VERSATILE MICROPRINTER

Feature rich, reliable, and compact, it can match the versatility, compatibility, reliability, and productivity of the OMI D500™ Model 855 microprinter. Here's why.

Two Printers In One. With the TI-855 you get the speed of dot matrix draft copy. Plus the precise clarity of the most advanced matrix technology for letter quality print. It's two printers in one... at one low price.

A Great Family Name. Texas Instruments is known for providing the world with the most advanced microprinters—the TI-855™. And for the same reliability into every expensive microprinter. Both the 855 and the TI-855 are part of the expanding TI line of high performance, low cost microprinters.

Hardware Compatible. The TI-855 microprinter is compatible with all major IBM hardware. And it provides both serial RS-232C subser and Centronics-style parallel standard interfaces.

Software Compatible. The TI-855 is industry standard ASCII compatible for compatibility with virtually all third party software. And it works with proprietary software needs, compatible with ANSI standards, and more.

Tough Font Modules For Quick Character Change. Three font modules can be interchanged with the front of the printer in one minute and are available for both models. Each contains both draft and letter quality characters for easy switching. Use them to remain and to reformat that traditional metal or plastic class wheels

more productive. And it's the most versatile microprinter. The TI-855 can print on 11 standard paper sizes, 14 standard paper sizes, and 17 standard paper sizes. It can print on 11 standard paper sizes, 14 standard paper sizes, and 17 standard paper sizes. It can print on 11 standard paper sizes, 14 standard paper sizes, and 17 standard paper sizes.

ANSI Standard. The TI-855 is ANSI standard compatible for compatibility with virtually all third party software. And it works with proprietary software needs, compatible with ANSI standards, and more.

Tough Font Modules For Quick Character Change. Three font modules can be interchanged with the front of the printer in one minute and are available for both models. Each contains both draft and letter quality characters for easy switching. Use them to remain and to reformat that traditional metal or plastic class wheels

Our IBM Protocol Converter is not the same under the skin!

Up to 16 channels.
Down to \$353 per channel.

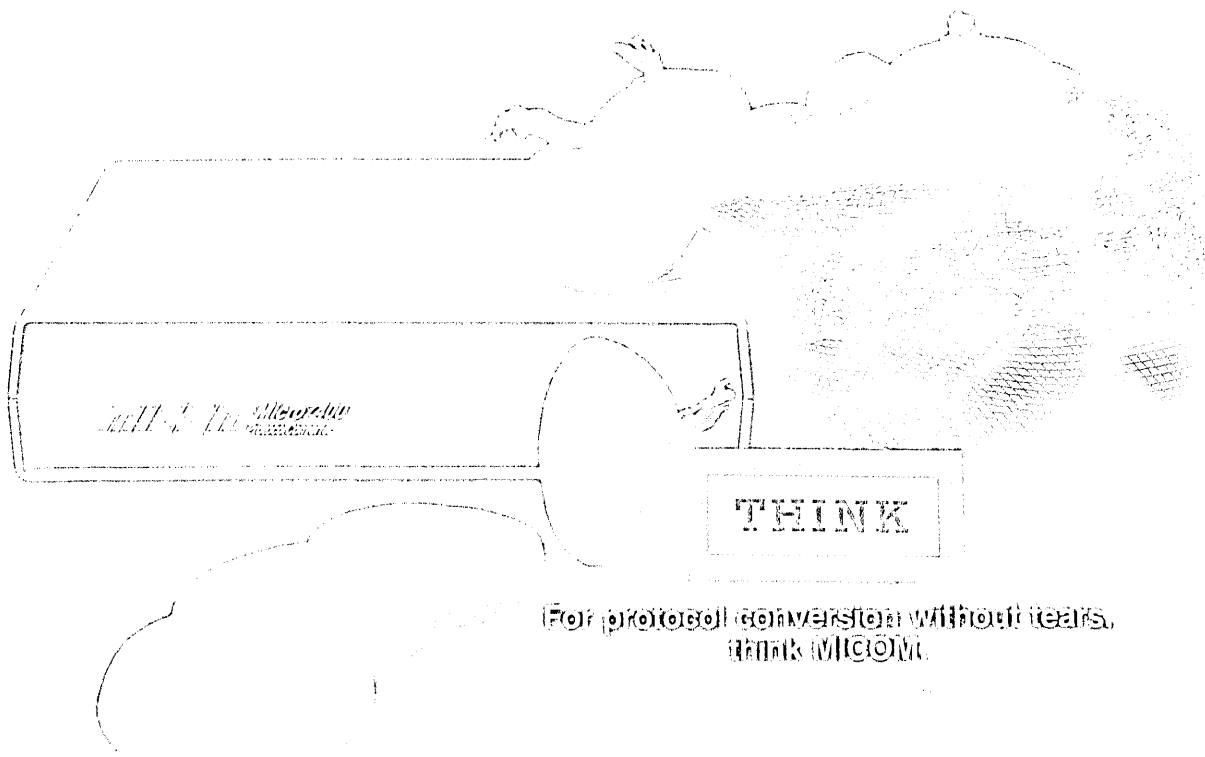

MICRO Systems Inc. • 2075 Woodhill Street • Chatsworth, CA 91311 • Telephone: (818) 882-8800 • FAX: (818) 882-8810
 Regional Sales Offices • Atlanta, GA • (404) 455-2959 • Boston, MA • (617) 577-0110 • Chicago, IL • (312) 882-0550
 Dallas, TX • (214) 252-0770 • San Francisco, CA • (415) 827-0820 • St. Louis, MO • (314) 576-7020 • Teaneck, NJ • (201) 882-0000
 MICRO Europe • Reading, Berkshire, England • (0734) 836800 • MICRO Europe • Newbury, Berkshire, England • (0345) 882000
 For literature please call (800) MICRO USA • 0208