

# DATA MATION 84

MARCH 1984

## THE TELECOM MANAGER EMERGES

1984  
MARCH  
1984  
920  
P  
CISMA



# 2X the speed, 3X the density, 4X the capacity, 1/3 the cost.

The first low cost GCR Tri-Density Tape System offering large system performance

Kennedy is, and has always been, the leader in peripheral tape technology. With Model 9400, Kennedy has done it again. For instance:

**2X the speed.** Model 9400 is a dual speed transport, operating at 45 ips in the GCR mode and 75 ips in the PE/NRZI modes with a maximum rewind speed of 500 ips.

**3X the density.** The drive utilizes Group Coded Recording at 6250 BPI along with previous industry standard densities of 1600 BPI/PE recording and 800 BPI/NRZI recording.

**4X the capacity.** In GCR mode, the Model 9400 can store up to 180 M BYTES of data (four times more capacity than the traditional 1600 BPI drive).

**More?** The Model 9400 features multiple processors to separate data handling and control functions. An 8088

processor provides overall system control and accommodates a variety of industry standard interfaces.

Among the many features of the 9400 is its RS-232 communication port and complete internal software which permits offline diagnostic operations via a terminal, the host computer or by a remote test facility with a phone modem.

**1/3 the cost.** Best of all, the Model 9400 is priced at about 1/3 the cost of a conventional GCR tape system. Kennedy Company... designers of the finest peripheral tape products for 20 years.

## KENNEDY

An Allagany International Company

1100 Sherman Ave. Monrovia, CA 91016

(618) 357-8331 • TOLL FREE 1-800-461-KENNEDY

TELEX: 51005720016 KENNEDY

TELEPHONE: 408-357-8331

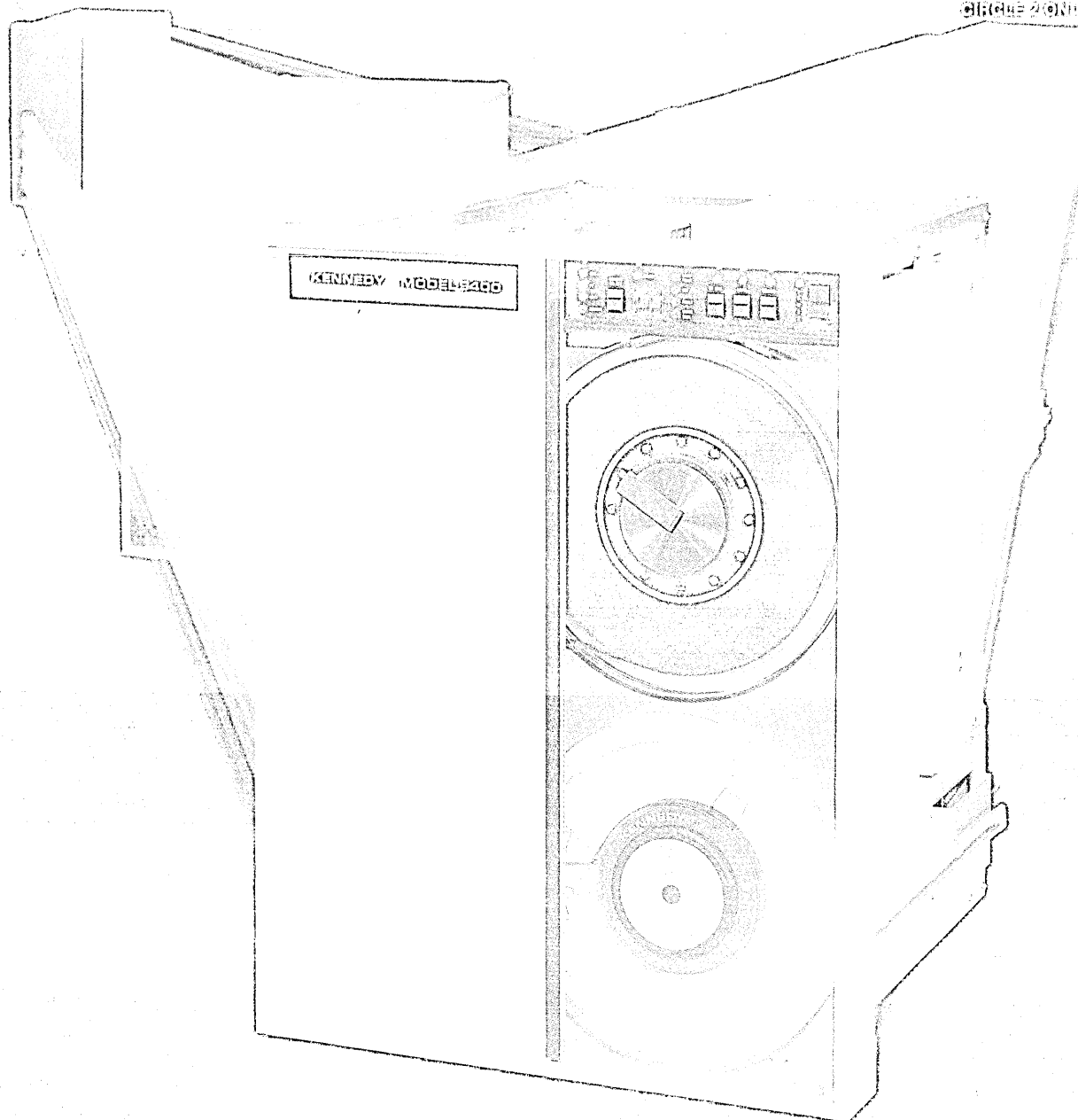

# KENNEDY • QUALITY • COUNT ON IT



# Now there are remedies for local networking headaches.

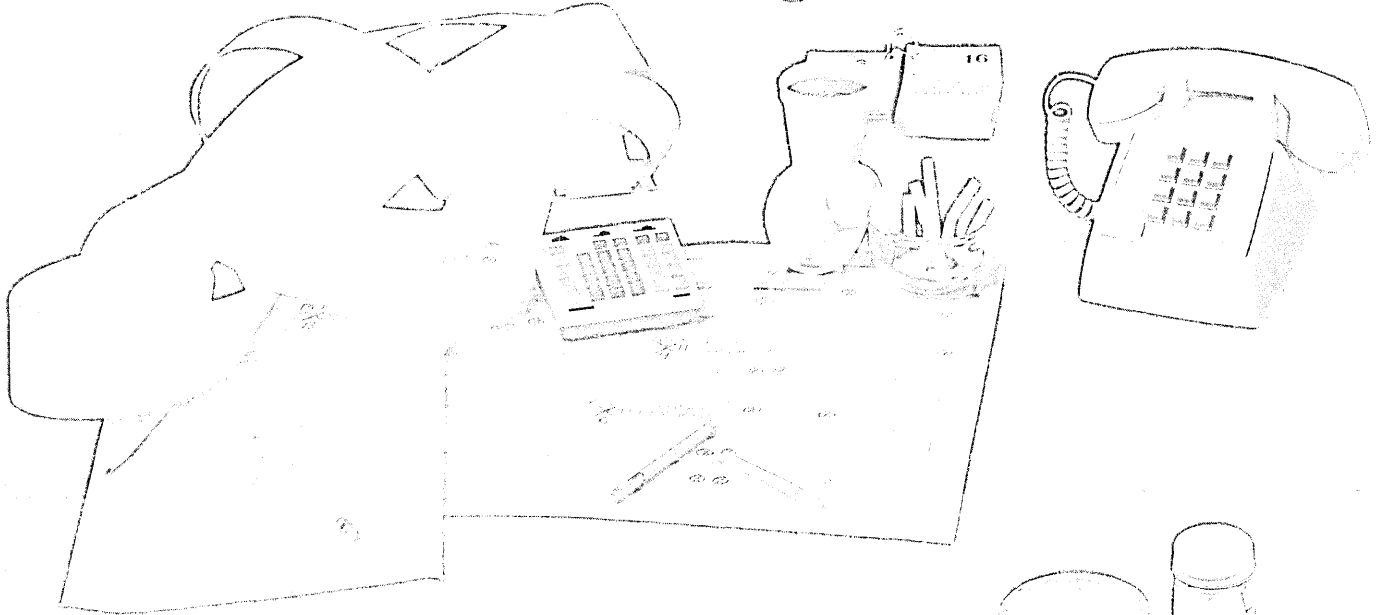

## Headache

We've got early to make a long-term commitment to baseband or broadband.

We don't want to get involved with more layers of protocol and more incompatibilities.

Fiber optic cable and coax is expensive and messy to install.

We're not ready to pour in a whole network now.

We already own a good deal of datacomm gear.

Division/Group/DP Managers want control of their own local datacomm.

We need Gateways:

- To the switched phone network
- To Packet Data Networks
- To other local networks.

**WE NEED IT FAST!**

We don't want to spend an arm and a leg.

## Remedy

Don't make one.

You don't have to.

Use your existing telephone wiring instead.

Install a piece at a time as you're ready.

Good. Connect it to the new network.

Give it to them.

○ Use dial-in and dial-out. No big deal.

○ Opt for X.25 compatibility.

○ Good thought. Use networks that are easy to interconnect.

Put in MICOM's INSTANET™—the *Instant* local network.

**That's the best part! Call or send today for literature and a price list.**

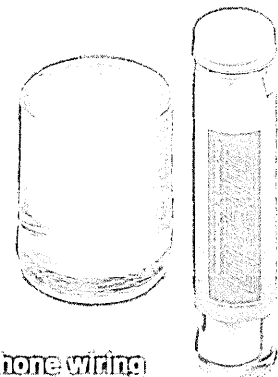

**MICOM** Corporation for Data Communications™

MICOM SYSTEMS, Inc. • 2015 Northrop Street • Chatsworth, CA 91311 • Telephone: (214) 998-9824 • TWX: 610/492-6610  
 Regional Sales/Service • Atlanta, GA • (404) 485-2889 • Boston, MA • (617) 527-4010 • Chicago, IL • (312) 789-2480  
 Dallas, TX • (214) 238-0774 • St. Louis, MO • (314) 576-7826 • Torrance, CA • (214) 886-4000  
 MICOM BORDER LTD. • Belconnen • 15 Craddock Road • Reading, Berkshire RG2 0AT, England • (0734) 856830 • Telex: 847165

CIRCLE 4 ON READER CARD

# RTA™ tells you about IMS response time before your users do.

Candle knows that when a business depends upon its IMS online system, that business is also vulnerable to the problems within that system. We developed RTA/IMS to help reduce user and customer frustrations because of poor response time. With RTA/IMS you won't be caught off guard by user complaints about poor response time. As a matter of fact, you can be warned when response times approach their thresholds, BEFORE your users perceive a serious problem.

For a graphic view of your response time, RTA/IMS features Moving Time Slot Analysis. RTA/IMS "Fixed Window" will continuously monitor the 10-minute response history for the transactions selected, whether or not the "Response Threshold" has been crossed. For dynamic warning of problem transactions, RTA/IMS "Dynamic Window" will display the 10-minute response graph only

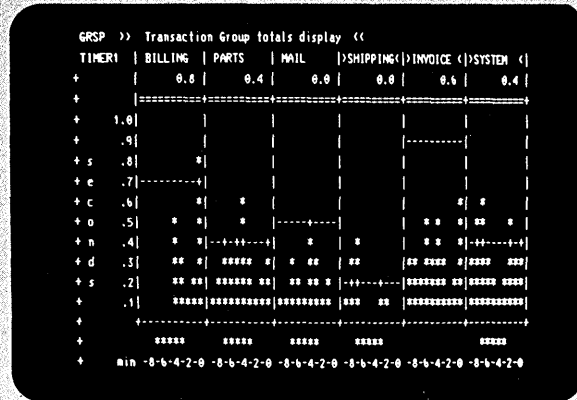

RTA/IMS Moving Time Slot Analysis displays "Fixed Window" (right side of screen) and "Dynamic Window" (left side of screen).

if the response time for the selected transaction has exceeded your acceptable response time level.

To recognize impending problems by spotting short-term trends, Time Interval Analysis presents response times for three distinct intervals such as 5, 15 or 30 minutes. To determine what your response time was for transactions at certain periods of the day (ex. 9:00-9:30, 9:30-10:00, 1:00-2:00, etc.), RTA/IMS Selected Time Slot Analysis will display the response time for your specified transaction—that simple and that easy.

RTA/IMS provides real-time feedback on IMS response time so that you observe short-term trends, receive dynamic warning of performance problems, and thus improve IMS service levels to your end users.

## Candle®

10880 Wilshire Blvd., Suite 2404  
Los Angeles, California 90024  
Phone 213-207-1400



# DATA MATION<sup>®</sup>

MARCH 1984/\$4.00 U.S.A.  
VOLUME 30 NUMBER 3  
This issue, 186,475 copies

## FEATURES

### 32 IN FOCUS

The ATM is leading the way toward the self-service society, Robert Garrison reports in "Easy Money."

### 120 TELECOM MANAGEMENT: AN EMERGING ART

Robert M. Dickinson

How the handling of telecommunication facilities can be tied to business strategies.



### 134 I, COMPUTER, TAKE THEE, PBX

William Ambrose  
and Diane Flood

Vendors are proposing to get a piece of the huge aftermarket the marriage of voice and data will generate.

### 147 IS IT THE PBX OR IS IT THE LAN?

Philip H. Reagan

The major networking technologies are clearly different, but which is more promising is not clear.

### 152 YOUR POCKET PROTOCOL PRIMER

Eric D. Siegel

A guide to the jargon of communication standards as easy as Dick and Jane.

### 158 THE OLD SCHOOL SELL

Willie Schatz

Educational market leader Apple and its rivals are crying, "Get 'em while they're young!"

### 169 COMPUTER INTEGRATED MANUFACTURING

Eric Teicholz

Optimizing production flow and scheduling, this concept combines manufacturing, design, and business functions.

### 179 LABOR RELATIONS IN THE AGE OF ROBOTICS

Charles Bruno

As factory automation improves efficiency, management and labor disagree on what it will do to employment.

### 185 A LEXICOGRAPHER'S ADVENTURES IN COMPUTING

Laurence Urdang

How an academic wrested an application from the jaws of early wp monsters.



### 198 APPLICATIONS SOFTWARE SURVEY

Of 3,000 users who rated 82 packages, 73% reported satisfaction with their purchases. More in this Data Decisions survey.

## NEWS IN PERSPECTIVE

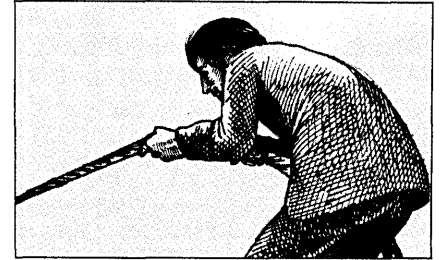

- 44 **SELLING ABROAD**  
Export laws on the line.
- 52 **THE WORKPLACE**  
Is Big Blue Big Brother?
- 61 **MICROCOMPUTERS**  
IBM to go portable.  
IBM lix AT&T in Unix mix.  
Selling software to go.
- 84 **DATABASE MANAGEMENT**  
RDBMS: is now the time?
- 93 **WASHINGTON**  
Hi-tech tax policies.
- 96 **COMPUTING SERVICES**  
CSC: a hectic 25 years.
- 104 **FOREIGN VENTURES**  
Two for the road.
- 116 **BENCHMARKS**

## DEPARTMENTS

- 8 **LOOKING BACK**
- 13 **LOOK AHEAD**
- 18 **CALENDAR**
- 23 **LETTERS**
- 29 **EDITORIAL**
- 225 **PEOPLE**
- 229 **HARDWARE**
- 239 **SOFTWARE & SERVICES**
- 249 **SOURCE DATA**
- 256 **ADVERTISERS' INDEX**
- 264 **ON THE JOB**
- 268 **MARKETPLACE**
- 272 **READERS' FORUM**

## INTERNATIONAL 224-1

- 3 **FROM HERE TO THERE**
- 11 **THE SOFTWARE/SERVICES SCENE**

## OEM SUPPLEMENT 225-1

- 3 **THE NEW ORIENT EXPRESS**
- 9 **THE OUTLOOK FOR  
INTEGRATED SOFTWARE**

COVER SCULPTURE BY GERALD SICILIANO  
PHOTOGRAPH BY ROBERTO BROSAN

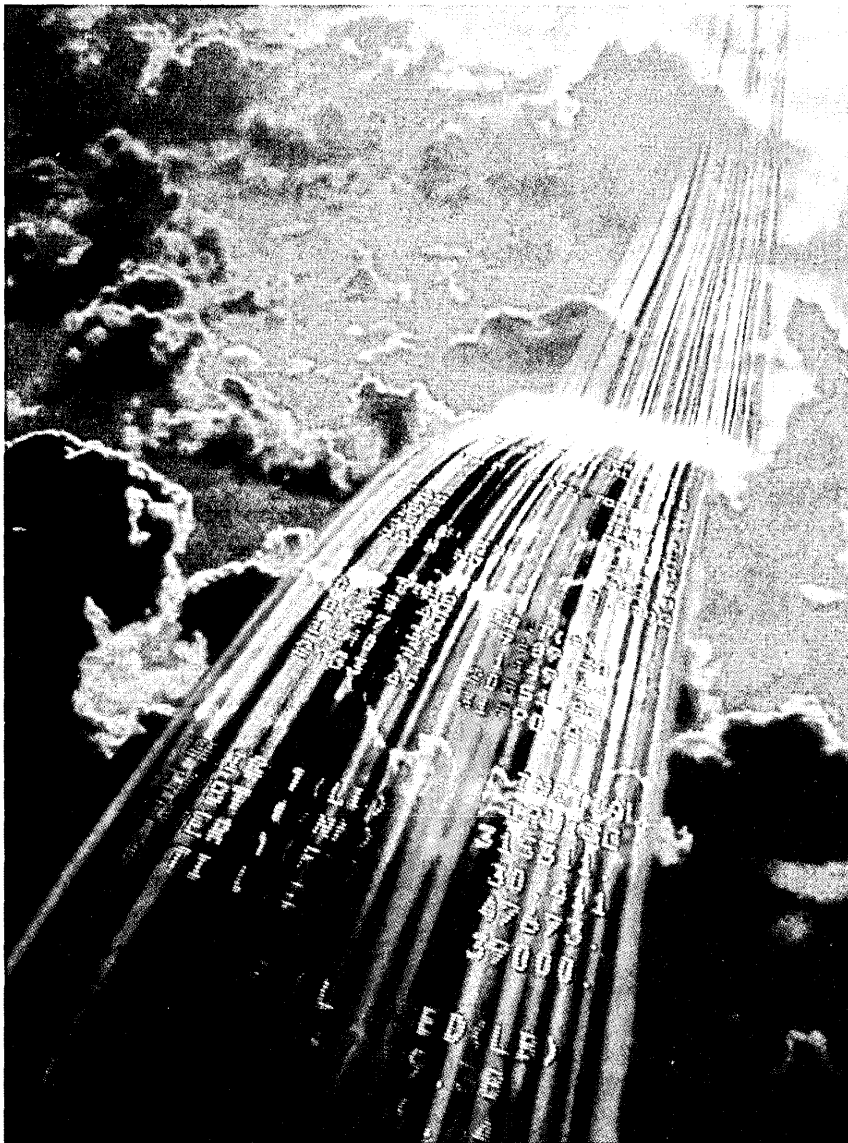

## From the cutting edge of NCR software engineering comes NCR/SNA Systems Network Architecture

If you are a computer manufacturer, or an OEM, there are two ways that you can implement SNA or X.25 on your systems:

- Do it yourself.
- Call NCR.

NCR systems engineers have developed portable communication products which can be easily implemented on a variety of processors and operating systems. These products allow for SNA communications, SNA network management and communication using X.25. Many of the products are immediately available, and could be ported onto most processors with minimum effort. And that's not all. NCR/SNA is backed by the

resources and experience of an international company with a long background in data processing, and with the engineering technology that will keep it among the leaders.

In 1984, NCR is 100 years young. If you are going to make a major investment in a strategic product, you'll want the innovative technology and service for which NCR has long been famous.

If you are a computer manufacturer or an OEM, and would like more information contact:

**NCR Corporation**  
**11010 Torreyana Road**  
**San Diego, California 92121**  
**Phone (619) 452-1020**

CIRCLE 6 ON READER CARD

**Editor** Rebecca S. Barna  
**Senior Editor** Larry Marion  
**News Editor** John W. Verity  
**Features Editor** Kenneth Klee  
**Senior Staff Writer** Parker Hodges  
**Copy Editor** Florence Lazar  
**Assistant News Editor** Michael Tyler  
**Assistant Features Editor** Deborah Sojka  
**New Products Editor** Robert J. Crutchfield  
**Assistant Copy Editor** Harriet Sigerman  
**Assistant Editor** Lauren D'Attilo  
**Editorial Assistant** Donna Lyons  
**Copy Assistant** Eric Brand  
**Bureau Managers**  
**San Francisco** Edward K. Yasaki  
**Los Angeles** Edith D. Myers  
**Minneapolis** Jan Johnson  
**Boston** R. Emmett Carlyle  
**Washington** Willie Schatz  
**Advisory Board** Lowell Amdahl,  
 Howard Bromberg, Philip H. Dorn,  
 Joseph Ferreira, Bruce W. Hasenyager,  
 David Hebditch, John Imlay, Terry G. Mahn,  
 Louis Naugès, Angeline Pantages,  
 Robert L. Patrick, Malcolm Peltu, Russell Pipe,  
 Carl Reynolds, F. G. Wittington, Amy Wohl.  
**Contributing Editors** Pamela Archbold,  
 Laton McCartney, Hesh Wiener  
**International Editor** Linda Ruyana  
**European Managing Editor** Paul Tate  
**Technology Editor, Europe** Fred Lamond  
**Foreign Correspondents** John Lamb,  
 London; James Etheridge, Paris; Peter Hidas,  
 Oslo; Norman Kemp, Sydney, Australia  
**Art Director** Kenneth Surabian  
**Assistant Art Director** Susan M. Rasco  
**Art Assistant** Catherine Kennedy  
**Production Manager** Geof McDonald  
**Publisher** James M. Morris  
**Executive Editor** John L. Kirkley  
**Circulation Vice President** Joseph J. Zaccaria  
**Circulation Manager** Mary Agnes Glenister  
**Operations Manager** Patricia Adamo  
**Research Director** Laurie Schnepf

### EDITORIAL OFFICES

**Headquarters:** 875 Third Ave., New York, NY 10022. Phone (212) 605-9400; telex 429073. **New England:** 1 Chaucer St., RFD 2, Sandwich, MA 02563, (617) 888-6312. **Washington, D.C.:** 4524 Windom Pl. NW, Washington, DC 20016, (202) 363-1326. **Midwestern:** 3607 Garfield Ave. S., Minneapolis, MN 55409, (612) 827-4664. **Western:** 1801 S. La Cienega Blvd., Los Angeles, CA 90035, (213) 559-5111; 2680 Bayshore Frontage Rd., Suite 401, Mountain View, CA 94043, (415) 965-8222. **International:** 130 Jermyn St., London SW14UJ, England, (441) 839-3916, telex 914911; 13 Stanley Place, Budd Lake, NJ 07828, (201) 691-0592, telex 499-4308.

## Technical Publishing

**BPA** Circulation audited  
 by Business Publications Audit

**ABP** Member American Business Press, Inc.

**DATAMATION** (ISSN 0011-6963) Magazine is issued monthly on or about the first day of every month. Published by Technical Publishing, a company of The Dun and Bradstreet Corp., John K. Abely, President. Executive, advertising, editorial offices, and subscription departments, 875 Third Ave., New York, NY 10022. Published at Lincoln, Nebr. Annual subscription rates: U.S. and possessions: \$42; Canada: \$60; Japan, Australia, New Zealand: \$100; Europe: \$90 air freight, \$190 air mail. All other countries: \$90 surface, \$190 air mail. Reduced rate for qualified U.S. students, public and school libraries: \$30. Single copy: \$4 in U.S. Special Datamatic/Dataguide issue: \$25. Sole agent for all subscriptions outside the U.S.A. and Canada is J. B. Tratsart, Ltd. 154 A Greenford Road, Harrow, Middlesex HA13QT, England, (01) 422-8295 or 422-2456. No subscription agency is authorized by us to solicit or take orders for subscriptions. Second-class postage paid at New York, NY 10001 and at additional mailing office. ©Copyright 1984 by Technical Publishing Co., a Division of Dun-Donnelley Publishing Corp., a company of The Dun and Bradstreet Corp. All rights reserved. "Datamation" registered trademark of Technical Publishing Company. Microfilm copies of Datamation may be obtained from University Microfilms, A Xerox Company, 300 No. Zeeb Road, Ann Arbor, Michigan 48106. Printed by Foote & Davies/Mid-America, POSTMASTER: Send address changes to Datamation, 875 Third Avenue, New York, NY 10022.



# SAS/FSP Gives You FSCALC...

New Product Analysis

Command ==> █ Define Mode

---

		YEAR_1	YEAR_2	YEAR_3	YEAR_4
TAXRATE	Tax Rate	22	22	22	22
INFLATE	Inflation Rate	0	7	8	6
D_UNITS	Delta Units	0			
D_PRICE	Delta Price	0			
UNITSOLD	Units Sold	50,000	57,500	66,125	76,044
PRICE	Selling Price	8.50	9.00	9.50	10.00
REVENUE	Revenue	425,000	517,500	628,187	760,437
RAW_MAT	Raw Material	150,000	184,575	229,242	279,446
DIR_LAB	Direct Labor	100,000	123,050	152,828	186,297
PACKAGE	Packaging	25,000	30,762	38,207	46,574
DISTRIB	Distribution	37,500	46,144	57,311	69,862
GROSS_P	Gross Profit	112,500	132,969	150,600	178,258
FIXED_C	Fixed Costs	40,000	40,000	40,000	40,000
NET_BTAX	Net Before Taxes	72,500	92,969	110,600	138,258
TAXES	Taxes Payable	15,950	20,453	24,332	30,417
NET_INC	Net Income	56,550	72,516	86,268	107,841

## Financial Spreadsheets on the IBM 3279.

FSCALC, the newest procedure in SAS/FSP™, gives you the friendliness of a personal computer and the power of your existing communications network.

The FSCALC procedure provides an interactive, electronic spreadsheet for financial modeling and analysis. You can use FSCALC for budgeting, financial and strategic planning, forecasting, new product analyses, depreciation scheduling, manpower and salary planning, portfolio management and "what if" analyses.

An on-line help facility makes FSCALC easy to use. You can consolidate screens, combining data from several departments into a corporate report. The FSCALC procedure features an unlimited spreadsheet size, with flexible row and column operations. You can even split screens to view your spreadsheet and programming statements at the same time. A sophisticated modeling language gives you true modeling capabilities.

Best of all, the FSCALC procedure is integrated with the SAS® System, giving you the tools for a complete Decision Support System.

Now you can enjoy the ease of a personal computer with the power of a mainframe—with FSCALC. Call or write today. SAS Institute Inc., Box 8000, Cary, NC 27511 USA. Telephone (919) 467-8000. Telex 802505.

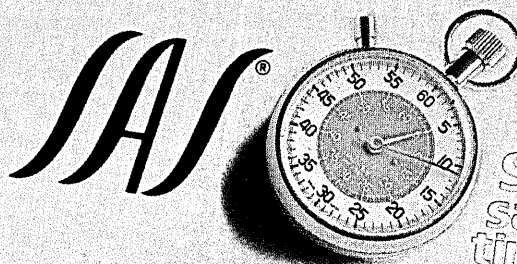

SAS saves time.

# Introducing COMPAQ PLUS, the first high-performance portable personal computer.

The makers of the COMPAQ™ Portable Computer, the industry standard, announce another breakthrough—the COMPAQ PLUS™ Portable Personal Computer. No other personal computer can handle so much information in so many places.

The new COMPAQ PLUS offers the power of an integrated ten-megabyte fixed disk drive in a portable. You get problem-solving power that no other personal computer can match.

## Plus a bigger payload

How much is ten megabytes?

Enough to tackle jobs that can't be conveniently handled on most personal computers.

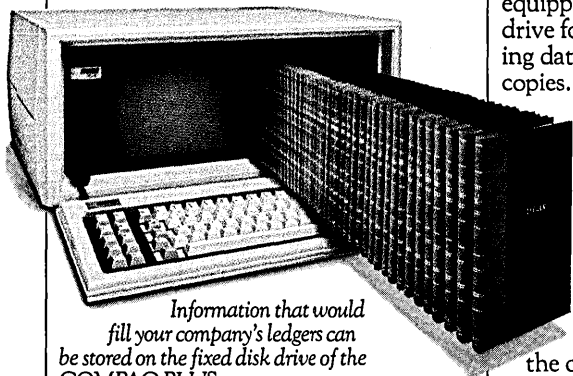

*Information that would fill your company's ledgers can be stored on the fixed disk drive of the COMPAQ PLUS.*

A mailing list of 100,000 names, addresses, cities, states, and Zip codes.

A full year of daily prices for every stock on the New York exchange.

Inventory records on a quarter million items.

The entire San Francisco phone book. And room left over for Peoria.

The fixed disk drive keeps all the information seconds away, ready to be searched, sorted, retrieved, analyzed or updated.

## Plus better use of your time

The integrated fixed disk drive will store programs. That means your most

used programs and data can be permanently kept in the COMPAQ PLUS, ready to call up and run.

With programs permanently stored, the COMPAQ PLUS becomes a well-informed traveling companion, a tool to help you apply your best thinking anytime, anywhere.

You could store a complete library of accounting programs on the disk—payables, receivables, general ledger, and payroll—with the company's books.

You could store an inventory control program with your inventory records and a list management program with your mailing list and a filing program with your personnel files.

The COMPAQ PLUS is also equipped with a 360K byte diskette drive for entering new programs, copying data files, and making backup copies.

## Plus more programs

More programs means more versatility. And the COMPAQ PLUS is impressively versatile because it runs all the popular programs written for the IBM® Personal Computer XT, available in computer stores all over the country. And they run as is, with no modification whatsoever.

And the high-capacity portable multiplies the productivity of every program it runs. Your inventory and its

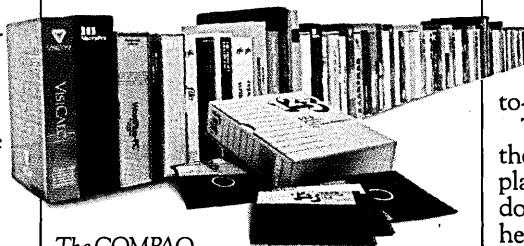

*The COMPAQ PLUS runs all the popular programs written for the IBM Personal Computer XT.*

control programs can go with you to the factory. Your books and your accounting programs can go with you to a board meeting. Your building specs and your project management programs can go with you to the construction site.

You're buying a computer to solve problems. Why not have more problem-solving programs to choose from?

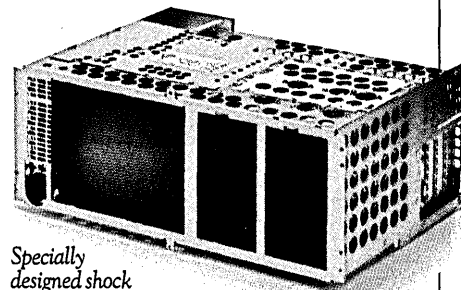

*Specially designed shock isolation system protects the fixed disk from jolts.*

## Plus a traveler's toughness

Life can be tough on the road. A true portable has got to be tougher. The COMPAQ PLUS is.

Its integrated fixed disk drive is unique, designed specifically to travel. Rough roads and hard landings don't bother it because of a specially designed shock isolation system that protects the disk from jolts and vibration.

All the working components are surrounded by a uniquely cross-membered aluminum frame. This structure, common in race car design technology, strengthens it side-to-side, front-to-back, and top-to-bottom.

The outer case is made of LEXAN®, the same high-impact polycarbonate plastic used to make bulletproof windows and faceplates for space suit helmets.

Does a portable personal computer really have to be this tough? Take a good look at your briefcase and then decide.



### Plus ease of use

The COMPAQ PLUS is big where it counts.

The display screen is big. Nine inches diagonally. Big enough to show a full 25-line-by-80-character page that's easy to read even if you're leaning back in your chair.

The keyboard is full-sized and typewriter-style for easy control.

With its built-in display, the COMPAQ PLUS makes a smooth, low profile on your desk, not an obstacle that you have to talk around.

### Plus an easy way to get started

If you're buying your first personal computer and you're not sure how much capacity you need, your choice is easier now.

Start with the COMPAQ Portable with single or double 320K byte diskette drives. If you need more capacity later, upgrade to the COMPAQ PLUS. A conversion kit is available that turns the COMPAQ Portable into a COMPAQ PLUS, complete in every detail and capability.

### Plus a lot more

The COMPAQ PLUS also works with optional printers, plotters, and communications devices designed for IBM's personal computer family.

It has two IBM-compatible slots for adding optional expansion boards. With companion programs, they'll let you share information with a network of personal computers in your office, communicate with your headquarters computer files while you're away, or add memory capacity if your needs grow.

*The COMPAQ Portable, the industry standard in portable personal computers.* ▼

*The problem-solving power of a high-performance desktop personal computer can now go where you need it.*

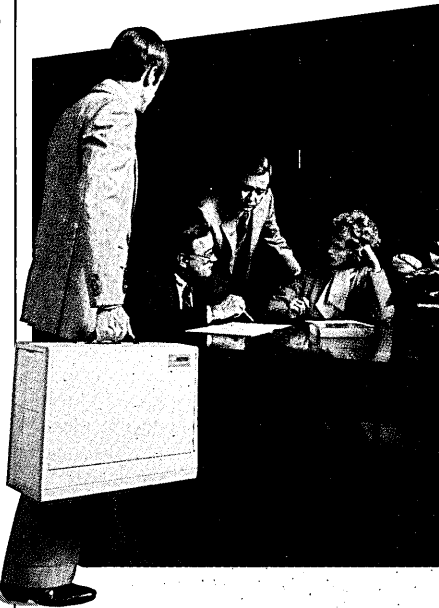

It's got high-resolution graphics and text on the same screen. A detached keyboard. Programmable function keys. Expandable memory. Dozens of other features that simply make it do a better job of personal computing.

And when you see all that the COMPAQ PLUS has to offer, you'll be pleasantly surprised by the price. The fact is, it costs hundreds less than comparably equipped desktop personal computers.

See the first high-performance portable personal computer. The COMPAQ PLUS—performance, programs, productivity. Plus problem-solving power.

*The new COMPAQ PLUS, the first high-performance portable personal computer.* ▼

## COMPAQ PLUS Specifications

### Storage

- One integrated 10-megabyte fixed disk drive
- One 360K byte diskette drive.

### Software

- Runs all the popular programs written for the IBM XT.

### Memory

- 128K bytes RAM, expandable to 640K bytes

### Display

- 9-inch diagonal monochrome screen
- 25 lines by 80 characters
- Upper- and lowercase high-resolution text characters
- High-resolution graphics

### Interfaces

- Parallel printer interface
- RGB color monitor interface
- Composite video monitor interface
- RF modulator interface

### Expansion board slots

- Two IBM-compatible slots

### Physical specifications

- Totally self-contained and portable
- 20" W × 8½" H × 16" D

**For the name of the Authorized Dealer nearest you, call 1-800-231-0900.**

©1983 COMPAQ Computer Corporation  
COMPAQ™ and COMPAQ PLUS™ are trademarks of  
COMPAQ Computer Corporation.  
IBM® is a registered trademark of International Business  
Machines Corporation.  
LEXAN® is a registered trademark of General Electric Company.

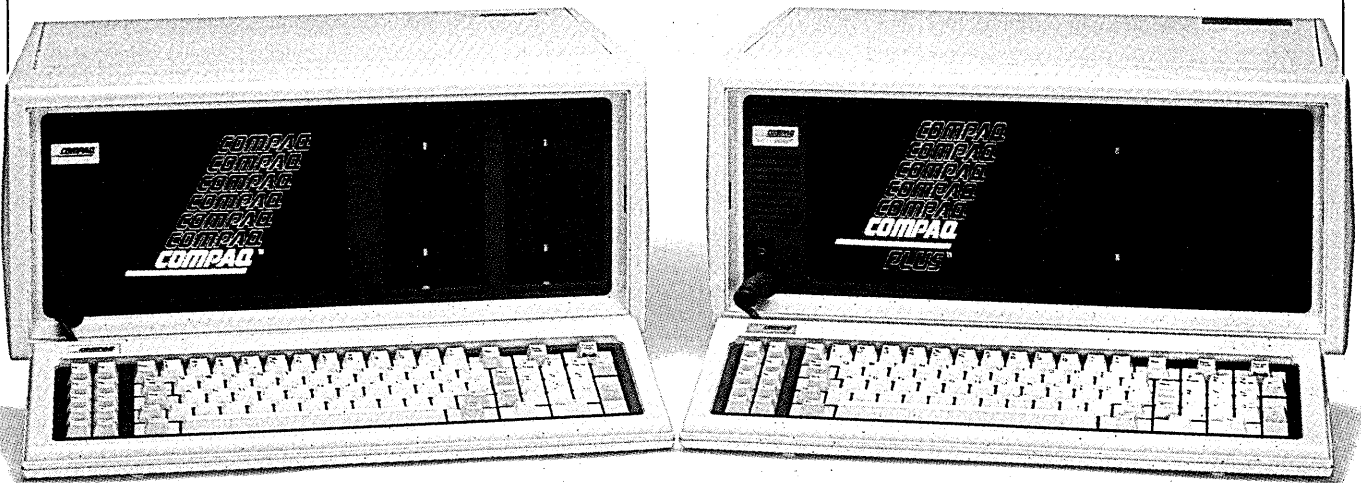

# COMPAQ PLUS™

**We offer more ways  
to help you  
manage a project  
than anyone else.**

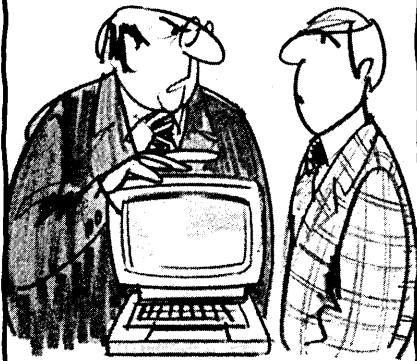

*"Look Fenton, just make sure everyone knows how to use the system, what the plan is, and how to get it done. Because I don't want to hear anymore about it."*

As the world leader in project management systems, we offer the widest range of systems and methodologies, along with our full support. All to keep even your toughest projects running smoothly.

#### **The Leading Project Management Systems**

AGS Management Systems provides the systems to plan, monitor, analyze, cost and manage any type of project. Our PAC II and PC/70 systems are used by over 2,000 major companies and government agencies worldwide.

#### **State-of-the-Art Methodologies**

Our systems development methodologies feature the latest structured analysis, design and programming techniques, including automated estimating.

#### **We'll Back You All the Way**

We can provide complete training and support with all of our systems and methodologies—before, during and after installation.

For more information write to AGS Management Systems, Inc., 880 First Avenue, King of Prussia, PA 19406. Or call:

**(215) 265-1550**  
Telex: 510-6603320

**AGS  
Management  
Systems** INC.

THE WORLD'S LEADER IN  
PROJECT MANAGEMENT SYSTEMS

**CIRCLE 7 ON READER CARD**

Twenty Years Ago/Ten Years Ago

# LOOKING BACK

## **MIGHTY MITRE**

*March 1964:* MITRE Corp. and its president, Clair W. Halligan, were under the editorial microscope in a DATAMATION interview.

The company was formed in August 1958 to fulfill U.S. Air Force needs. When the Semi-Automatic Ground Environment (SAGE) Air Defense System (developed at MIT's Lincoln Laboratory) was in the implementation phase, the Air Force realized this project required a larger systems effort than was previously anticipated. First, it formed a military organization called the Air Defense Systems Integration Division (ADSID) which was made up of R&D, logistics, and operating personnel. Next, it looked for technical support from various places, including industry and other organizations. It finally decided to ask MIT for Lincoln Laboratory's support. MIT figured the system engineering job was not appropriate for a university lab, but agreed to give temporary support to the project while sponsoring the formation of a nonprofit corporation to take on the permanent task—thus MITRE Corp.

The Lincoln Lab group that had been working on the project was transferred to the new company. Until the end of fiscal 1959, MITRE operated as a subcontractor to MIT. ADSID matured into the Command and Control Development Division (CCDD) and the scope of its duties was broadened to include the entire Air Force command and control systems in addition to SAGE. The Air Force asked MITRE if it would expand its duties as well, and the company assented. Sometime later, the Air Force formed the Air Force Systems Command, and CCDD became its Electronics Systems Division, with the same duties. MITRE continued to handle the system engineering for Air Force Command as well as related advanced planning and technological work.

Other MITRE projects included air traffic control for the Federal Aviation Agency (FAA) and technical support responsibility for the Defense Communications Agency's (DCA) National Military Command System.

## **BILL, PLEASE**

*March 1974:* Both Senator Sam Ervin (D-N.C.) and the Justice Department authored

bills aimed at preventing "snoopers" from getting into police department dossiers and related records. Ervin's bill (S. 2963) was designed to prevent credit bureaus, employers, and similar individuals or organizations from obtaining records of persons who had been arrested but not convicted. Said the Senator, "As many as 70% of arrest records do not contain dispositions . . . I would not be surprised to find that the percentage . . . is even higher in FBI files."

Ervin's bill was officially called the "Criminal Justice Information Control and Privacy Act of 1974." In effect, the bill would allow individuals and organizations outside the law enforcement community to obtain only conviction record information.

The Justice Department bill was similar, but it lacked the restrictions on exchange of data between law enforcement agencies that the Ervin bill proposed. Also, the Ervin bill would bar criminal justice information systems from keeping data obtained by informants. The Justice Department bill would not only allow the retention of the data, but would permit dissemination to outsiders at the discretion of the Attorney General.

Both bills maintained that operators of criminal justice information must keep accurate, complete records and seal or purge records if subjects have not been rearrested within a specific time period. They also provided access and challenge privileges to persons with such records.

The Justice Department bill, however, allowed access only to criminal offender records and not arrest-only or intelligence records. It would also have enforced agencies holding information to "take appropriate steps" to have changes made in any system to which it has provided the same information.

On the other hand, Ervin wanted to permit access to any data collected on the person in question, and would "adopt and publish regulations that provide for informing other agencies not only when a record has been corrected, but when it's been challenged as well."

Both bills would impose civil and criminal penalties for violations.

—Lauren D'Attilo

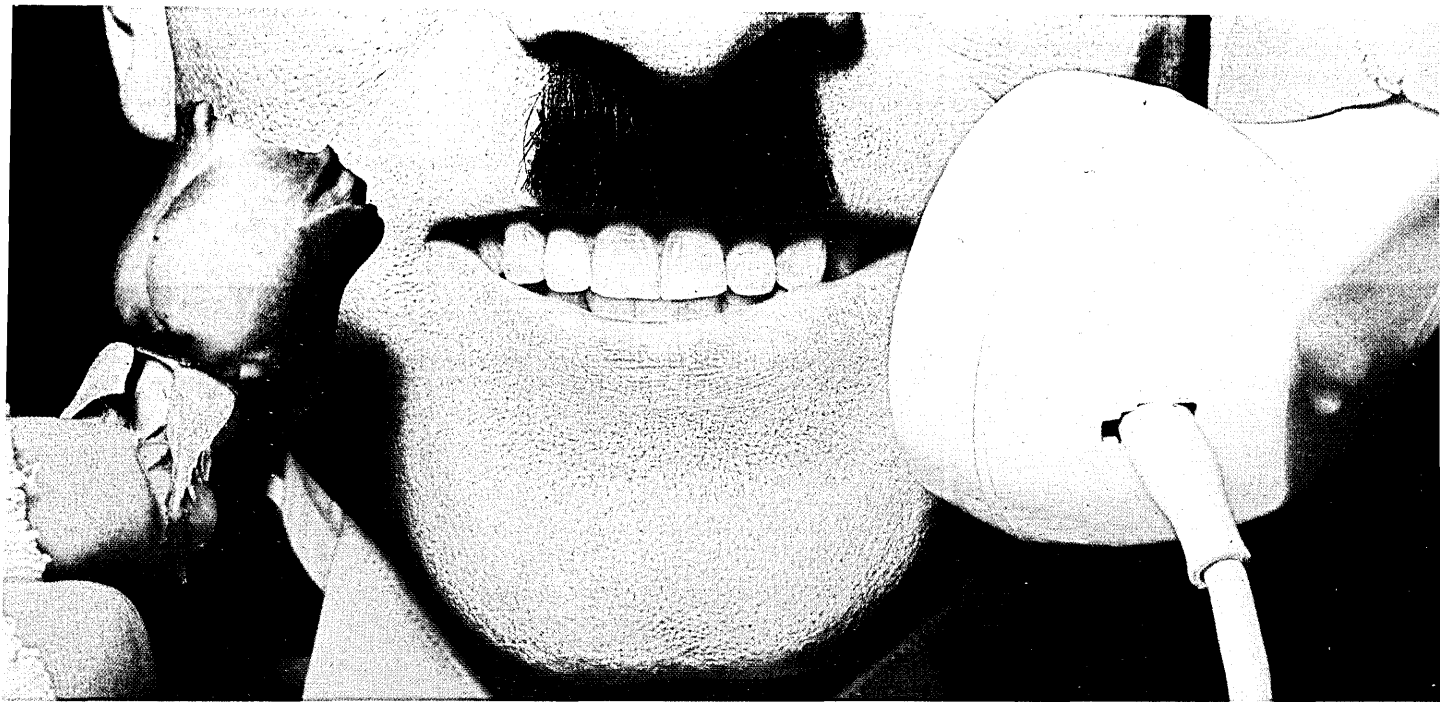

**“HELLO, IBM?**

**CANCEL MY ORDER  
FOR YOUR WORK  
STATIONS.”**

Decision Data makes better S/34, 36 and 38 work stations than IBM. The proof? More people choose Decision Data work stations than any other alternative to IBM. Over 30,000 Decision Data work stations have been installed to date.

And now, the new Decision Data work station offers many significant advantages over the IBM 5291 work station.

**The Screen.** Our glare-free screen tilts and swivels more easily—with brightness, contrast and power switches up front, where they are in easy reach of the operator. Our screen offers both block- and line-cursor styles. To conserve and lengthen CRT life, our screen dims automatically.

**The Keyboard.** Our contoured keyboard, with molded key caps, offers ergonomic design that opens a new era in operator comfort. Like the screen,

the keyboard provides a choice of tilt positions, plus a palm rest, an erasable scratch pad; an adjustable clicker for loud, soft or silent responses; and a detachable, coiled cord that lets the operator work up to six feet from the screen.

**The Decision.** With all of these features, Decision Data's advanced work stations cost less, occupy less space and help operators get more done more easily. Maintenance is provided by our own highly respected nationwide service organization. Depot-maintenance and annual-maintenance-fee-service terms are available.

You shouldn't buy a work station, a serial, line or letter-quality printer—or any other peripheral for an IBM S/34, 36 or 38 without talking to Decision Data first.



**Decision  
Data  
Computer  
Corporation**

Box 4503  
100 Witmer Road  
Horsham, PA. 19044

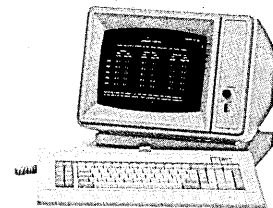

Please tell me more about the work stations that work harder.  Better yet, I'll phone  
**(800) 523-6529.** In PA call: (215) 674-3300.

Your Name \_\_\_\_\_

Company \_\_\_\_\_

Telephone \_\_\_\_\_

Address \_\_\_\_\_

City \_\_\_\_\_

State \_\_\_\_\_

Zip \_\_\_\_\_

**WE  
MAKE  
THE RIGHT DECISIONS**

CIRCLE 8 ON READER CARD

**HERO  
BREAKS  
DOWN  
OFFICE  
WALLS.**

# MDS HERO TRANSFORMS ISOLATED WORKSTATIONS INTO NETWORKSTATIONS.

The personal computer is not all pluses. This modern miracle of speed and precision has created a kind of cubbyhole mentality. Isolated, self-protective pockets of valuable information, inaccessible to other

computers or the rest of the organization.

How will your company move forward when its best thinking can't even move from office to office? Your company needs HEROS.

## IN THE OFFICE, HERO UNITES AND CONQUERS.

HERO™ is the intelligent, desktop Networked Personal Computer from MDS. It does everything an ordinary personal computer can do. And lots that it can't. HERO can form interactive alliances with mainframes, trade information with other computers, make peace between departments and convert diversified knowledge into decision-making power.



## HEROS LOOK GREAT IN BLUE.

HERO and IBM. Together, they're unbeatable. Mated with MDS SUPER 21™ Communications Processor, HERO slips comfortably into IBM SNA networks. It looks like Big Blue's 3270 SNA and 3776 remote-

job-entry systems. And our MDS SUPER SNA™ option gets both on one communications link. Additionally, HERO runs MS-DOS software, as well as a fast-growing library of MDS software programs.

## HEROS PLAY "SHOW AND TELL," NOT "HIDE AND SEEK."

HERO and SUPER 21 give you the power to liberate data from personal, departmental and corporate databases that used to play hard-to-get.

With INTELLIGENT 3270™ (an intelligence only MDS offers), your people can write their own

programs and integrate them with data in the mainframe. HERO lets you access the database, extract information, process it, display it, update it and utilize it. Then return it or store it right at the workstation.

## MDS HERO WILL MAKE A HERO OUT OF YOU.

With HERO and SUPER 21, what's been out of control will soon be under control. Yours. And your current investments in data processing will pay off even more handsomely. Instead of your system not working, it will be networking. Efficiently, effectively and economically.

Not just in the office, but throughout your entire organization.

Furthermore, MDS systems are planned for non-obsolescence. They're modular in design to accommodate future growth. So, like a hero, every MDS system is immortal.

## TOGETHER, WE'LL MAKE HEROIC STRIDES.

MDS is a multidivisional, multinational corporation. We've grown by helping our customers to grow. We'd like to do the same for you. Not just in IBM country, but beyond.

Wherever you are, or want to be, we are. MDS

offers service and support capability around the world. Around the clock.

Ask our customers about us. And give us a call. Dial **800-MDS-HERO**. Together, there's no barrier we can't break through.

**MDS** MOHAWK  
DATA  
SCIENCES

7 Century Drive, Parsippany, New Jersey 07054. And over 430 locations, worldwide.

MDS is a registered trademark and HERO, SUPER 21, INTELLIGENT 3270 and SUPERSNA are trademarks of Mohawk Data Sciences Corp. MS-DOS is a trademark of Microsoft, Inc.

CIRCLE 9 ON READER CARD



## The road to hell is paved with good intentions.

Speed. Convenience. Productivity.  
All good intentions. All up in smoke.

All because too many personal computers proved too much of a good thing. Too much independence. And not enough integration with your corporate MIS system.

But depend on our Direct 1600 series to put out the fire.

In one compact unit we can pack an MS-DOS™ and CP/M®-based computer, dual floppies, optional hard disk system, modem, selectable 80/132 character display, and full-featured DEC or HP terminal with DirectLink communications software.

So everyone can run their favorite personal computer programs. And

then transfer data and results between the host computer and their desks.

Spread sheet calculations, reports, corporate-wide data, all can be exchanged without re-typing, without errors. And without the compatibility problems

so common when personal computers and mainframes mix.

With just one piece of hardware from one supplier, everybody gets what they expected from personal computing. And from your MIS investment.

Call Direct at 800-538-8404 (408-980-1414 in California). Or write us at 4201 Burton Drive, Santa Clara, California 95054. We'll show you how to travel the road to micro-mainframe integration.

Without getting burned.

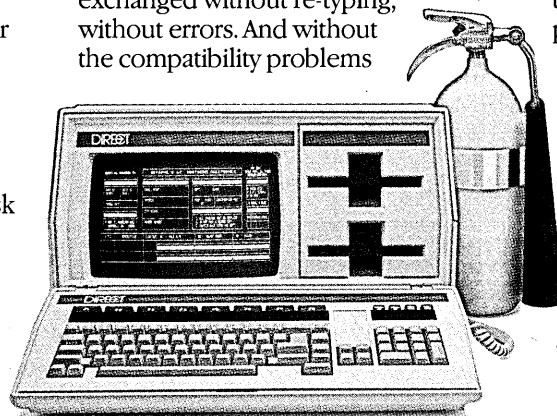

# DIRECT

© 1984 Direct, Inc. MS-DOS is a trademark of Microsoft Corp. DEC is a trademark of Digital Equipment Corp. CP/M is a registered trademark of Digital Research, Inc.

CIRCLE 10 ON READER CARD



# LOOK AHEAD

## AT&T'S PC PLANS

Speculation runs rampant as to AT&T's plans in the computer hardware area. One report, emanating from Eastern Management Group, Morris Plains, N.J., suggests the company will take the offshore route, introducing a family of Japanese machines this month. Reportedly, pcs resembling Apple's Lisa and MacIntosh are in the offing and could be shipped as early as June. A corporate spokesman would neither confirm nor deny the report, but one has to wonder what the reaction would be in Washington, where AT&T fought so hard to enter deregulated markets, if it were finally to come out with foreign-built goods.

## CMS FOR ALL

IBM seems intent upon extending its CMS operating system to run on a full range of machines, from desktop to mainframe. Currently, addressing limitations on the XT/370 personal computer inhibit CMS's function, while at the high end, where Extended Architecture (XA) is expected to reign, a full 31-bit version of CMS is not yet available. Work is under way at Yorktown Heights, N.Y., to correct the situation and help bring full XA and SNA support of CMS to the IBM product line. Some observers expect a desktop 4300, the Illiad, to be introduced later this year with VM/CMS support.

## NCR TOWER TO GET TALLER

July's NCC should see NCR Corp. introduce a broad range of new products including an upgrade of its Tower, a 68000-based Unix system sold to oems. Also being readied are a high-end dyadic processor mainframe, a laser printer, and a new personal computer in the Decision Mate line. Meanwhile, the company has been packaging its Tower system with Ryan-MacFarland COBOL and selling it against IBM's System/36 and 38 and Burroughs' B93 machines. NCR also just scored a much needed point by convincing Honeywell to use the NCR 9300 chip set, a 32-bit processor that can be microcoded to handle various instruction sets.

## NEW OA CO. IN THE WORKS

A tiny Sun Valley, Calif., startup headed by Dan McGurk, onetime president of Xerox Data Systems and founder of the Computer Industry Association (now CCIA), and Stephen L. Kurtin, founder of word processing equipment manufacturer Lexitron Corp., is readying an office automation product for late May or early June introduction.

## POPPA POPS UP AGAIN

Is that Ryal Poppa of Pertec Computer, Greyhound Computer, and DPF fame getting back into the computer business? Poppa took over Buckbee Mears Co.

# LOOK AHEAD

## SOFTWARE TAX BATTLES

in St. Paul, Minn., in early 1982, saying he'd get the manufacturing company into more advanced markets. Now he's acquired the Tampa, Fla., operations of Honeywell Inc., which makes subassemblies for the military and, interestingly enough, IBM's PC product line.

Rumblings of another battle in the state of California's war against sales taxes on software have been heard. Governor George Deukmejian has assigned a special commission to study "tax loopholes," one of which is understood to be the limitation of software taxation to the value of the media it's shipped on.

## TRUE BLUE

We hear IBM has been in the market for color video projectors for use in branch offices for sales and training. Reportedly, the company is most anxious to find a projector that can reproduce IBM Blue exactly, with no color shift.

## UNDERPASSING AT&T?

Local Bell Operating Companies have been worrying -- loudly -- about the threat to their business created by Bypass, the building of private corporate networks that bypass the local loops. But the newly independent BOCs may threaten their ex-parent, AT&T, with another kind of pass, Underpass. There is talk that further deregulation could let the BOCs begin to sell long distance services, undercutting AT&T's biggest moneymaker, AT&T Communications.

## RUMORS AND RAW RANDOM DATA

Look for IBM to introduce a version of Unix for its Series/1 minicomputer. Most likely to make it to market, perhaps as early as this spring, is a package developed by CMI, the Troy, Mich., computer leasing outfit. That firm has reportedly written a System 5 port of the AT&T operating system....Watch for Hewlett-Packard to drop 3M as a source of backup tape drives. Expecting the market for archival storage to increase sharply, HP's Greeley, Colo., division will soon introduce its own line of quarter-inch drives....A price war in the raw floppy disk drive market is putting pressure on Sony with its 3½-inch product. Company insiders say a 640K-byte drive will soon be priced at \$100 or less in large oem quantities. The next price target is \$50 for a 1-megabyte drive.... Striving to beat Tandem Computers at its own game, Stratus Computer, Natick, Mass., will in mid-April introduce a new fault-tolerant computer. The machine is claimed to be software-compatible with the two-year-old original Stratus cpu, of which more than 140 have been installed.

# Save 50% on your communications cost.

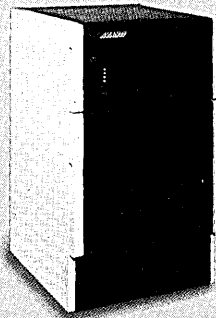

## Avanti's new T1 UltraMux.

It lets you take maximum financial advantage of low-cost T1 tariffs. Using UltraMux, you can replace up to 128 lines with one T1 line. Plus, you can have additional voice circuits, increased data transmission rates and more capabilities, too.

The UltraMux sends voice, data and video in any combination. That means the UltraMux can handle your telephone communications, data transfers and video teleconferencing. The system's high bandwidth, up to 10 Mbps, means you can use satellite, private microwave and fiber optic communications links now and T1C and T2 links as they become available.

## Ultra flexible.

Select the exact channel configuration you need; up to 64 synchronous or voice channels; 128 asynchronous channels. Maximum channel speed can go as high as 8.2 Mbps, and you can digitize voice at 16 or 32 Kbps.

If your communications mix changes at different times of the day or night, UltraMux can automatically change to match your required configuration. And for maximum utility, dynamic channel allocation assigns bandwidths only when needed.

The UltraMux has centralized point-to-point or network-wide control. So, from anywhere in the system you can monitor and test the entire system or its individual components, perform complete reconfiguration or change any operating parameter.

The UltraMux is flexible enough to expand as you do. Its modular interface works with whatever communications equipment you now use, and can easily adapt to future needs as well.

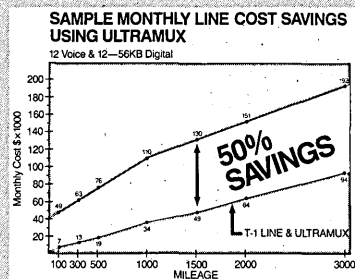
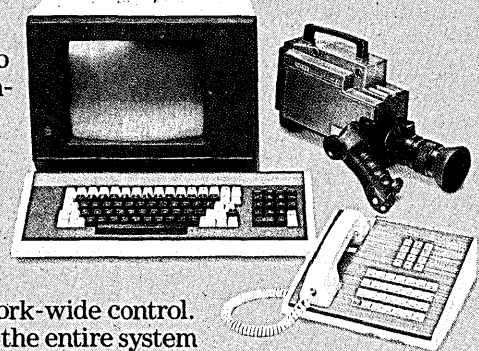

## Ultrafast payback.

This graph shows some typical monthly line cost savings using Avanti's T1 UltraMux. Depending on your usage you can easily save up to 50% or more.

We'd like to show you exactly how much Avanti's UltraMux can save your company. Just complete the coupon below. We'll send you a free, customized T1 UltraMux Cost Savings Analysis.

Send coupon to Avanti Communications Corp., Aquidneck Industrial Park, Newport, RI 02840, or call (401) 849-4660.

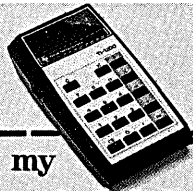

### Send my free T1 UltraMux Cost Savings Analysis.

To receive your free T1 UltraMux Cost Savings Analysis, please fill in the following information and send to Avanti Communications Corp., Aquidneck Industrial Park, Newport, RI 02840.

(If you need more space, or have more locations, use a separate sheet of paper.)

Transmission, current or planned between \_\_\_\_\_ and \_\_\_\_\_  
Location A Location B

Mileage (if known) \_\_\_\_\_

Type of circuit	Speed	Number of circuits	Monthly cost (if known)
Voice	XXXXX		
Data Sync <input type="checkbox"/> Async <input type="checkbox"/>			
Sync <input type="checkbox"/> Async <input type="checkbox"/>			
Video			

Name \_\_\_\_\_ Title \_\_\_\_\_

Company \_\_\_\_\_

Address \_\_\_\_\_

City \_\_\_\_\_ State \_\_\_\_\_ Zip \_\_\_\_\_

Telephone \_\_\_\_\_ Have a representative call

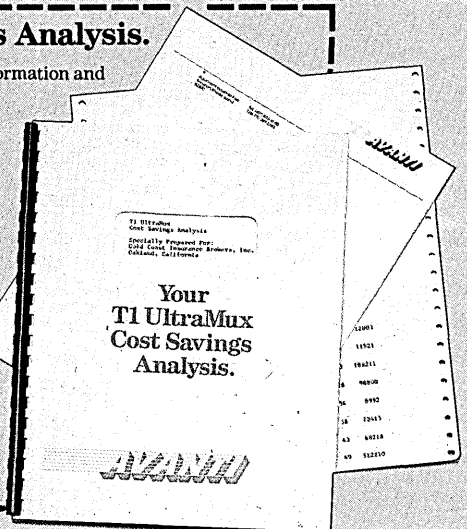

CIRCLE 11 ON READER CARD



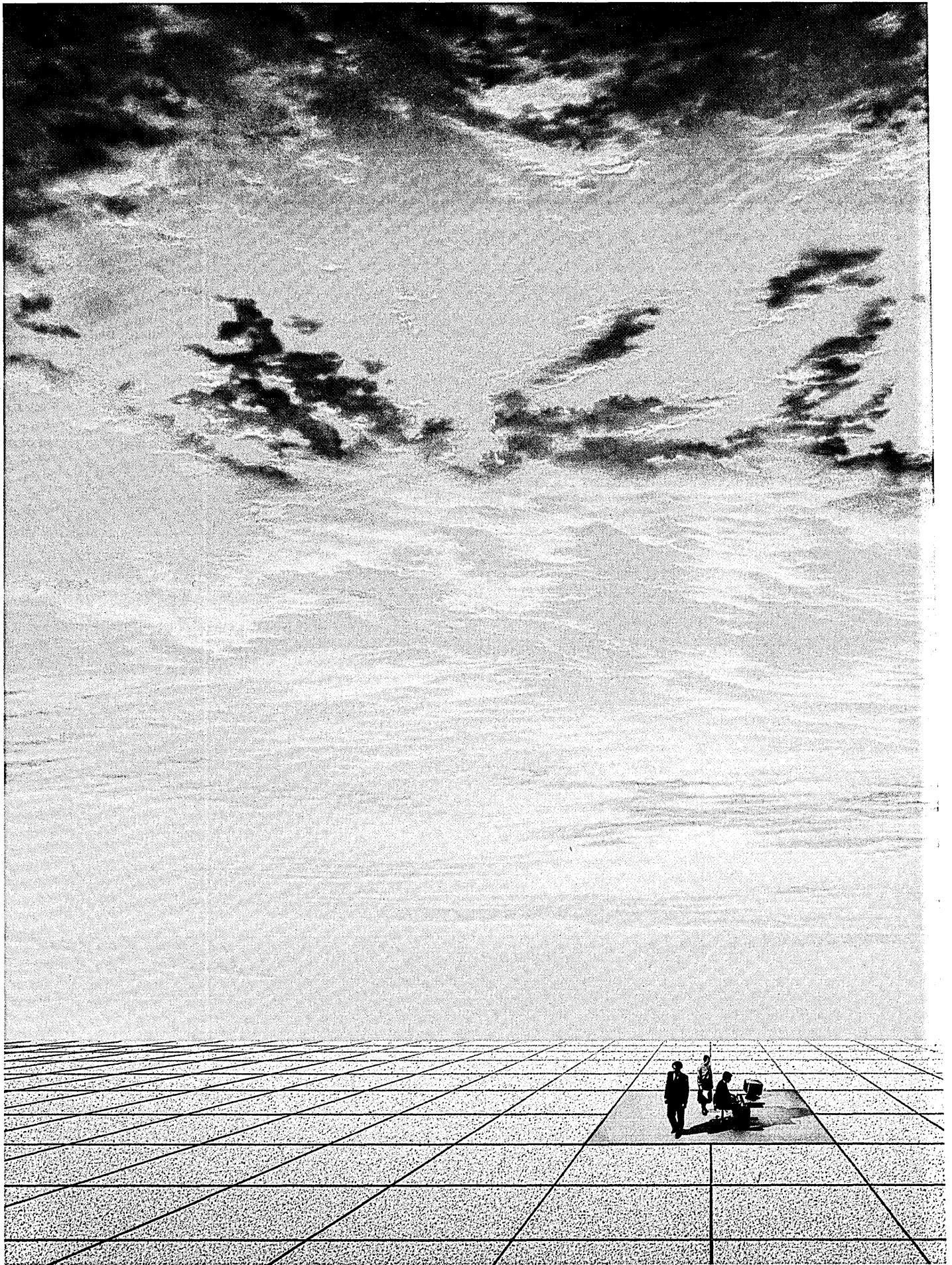



# Tomorrow's office won't have walls.

Soon, your office will be wherever you want it to be, wherever your business takes you.

You'll be right in the middle of things at a branch office hundreds of miles away, or at a plant on the other side of the world. You'll still have complete access to your company's total information resources.

A company called Ericsson is in the forefront of the new digital information technology that's wrapping up telecommunications, data processing and office automation in one big package.

Take Ericsson's new, all-digital Information Switching System, for example. Starting with the telephone lines you already have to connect every desk in every office, it ties voice, text and data communications into a total organization-wide network.

By adding modules, this network can be economically expanded from 100 to more than 20,000 stations: telephones, desktop terminals, printers, facsimile machines, computer interfaces and other office automation devices in whatever combination you need. It represents the most advanced application of distributed, multi-microprocessor technology available today.

All of Ericsson's 70,000 people work in just one field: information technology. To Ericsson this field extends from electronic typewriters to nationwide telephone systems. From lightwave cable to office automation networks. From computer terminals to satellites. From cellular radio networks to distributed data processing systems.

Ericsson integrates all these into one compatible technology, staying at the leading edge by spending 10% of its annual sales on Research & Development.

Find out more about the technological and financial strength of this innovative company. Ericsson, Inc., Greenwich Office Park 3, Greenwich, CT 06836-3110.

**ERICSSON** 

# CALENDAR

## MARCH

### **Automated Manufacturing 1984 (AM '84).**

March 19-22, Greenville, S.C., contact: AM84, P.O. Box 5823, Greenville, SC 29606, (803) 233-2562.

### **Federal Office Systems Expo (FOSE '84).**

March 19-22, Washington, D.C., contact: Mary Beth Gouled, National Trade Publications Inc., 9418 Annapolis Rd., Lanham, MD 20706, (301) 459-8383 or (800) 638-8510.

### **International Symposium on the Performance of Computer Communication Systems.**

March 21-23, Zurich, Switzerland, contact: Harry Rudin, IBM Research Laboratory, Saumerstrasse 4, CH-8803 Ruschlikon, Switzerland, (01) 724-2727.

### **The West Coast Computer Faire.**

March 23-25, San Francisco, Calif., contact: David Sudkin, General Manager, Computer Faire Inc., 570 Price Ave., Redwood City, CA 94063, (415) 364-4294.

### **Future Office Exhibition and Conference.**

March 27-30, Milan, Italy, contact: Carol Ross, Trade Promotion Officer, U.S. International Marketing Center, Via Gattamelata 5, 20149 Milan, Italy, telex 330208 or telephone (39) 2-4696-451.

## APRIL

### **DEXPO East 84.**

April 3-6, Boston, Mass., contact: Expoconsul International Inc., 55 Princeton-Hightstown Rd., Princeton Junction, NJ 08550, (609) 799-1661.

### **Hannover Fair.**

April 4-11, Hannover, West Germany, contact: Hannover Fairs Information Center, P.O. Box 338, Route 22 East, Whitehouse, NJ 08888, (201) 534-9044 or (800) 526-5978.

### **Intergraphics '84.**

April 9-12, Tokyo, Japan, contact: World Computer Graphics Association Inc., 2033 M Street NW, Suite 399, Washington, DC 20036, (202) 775-9556.

### **The Sixth Annual International Conference on Computer Capacity Management (ICCCM).**

April 9-12, Washington, D.C., contact: Institute for Software Engineering, 510 Oakmead Parkway, Sunnyvale, CA 94086, (408) 749-0133.

### **Association for Information and Image Management (AIIM) Conference and Exposition.**

April 10-12, Chicago, Ill., contact: Sue Wolk, Director of Conference and Exposition, AIIM, 1100 Wayne Ave., Silver Spring, MD 20910, (301) 587-8202.

### **International Personal Robot Congress/Exposition.**

April 13-15, Albuquerque, N.M., contact: International Personal Robot Congress, 1547 S. Owens St., #46, Lakewood, CO 80226, (303) 278-0662.

### **Videotex '84.**

April 16-18, Chicago, Ill., contact: London Online Inc., Suite 3314, 1133 Avenue of the Americas, New York, NY 10036, (212) 398-1177.

### **Office Automation & Computer Show.**

April 19-21, Salt Lake City, Utah, contact: Office Automation & Computer Show, Scott Marketing, 545 East 4500 South, Suite E-130, Salt Lake City, UT 84107.

### **AUTOFACT Japan Conference & Exhibition.**

April 25-27, Kobe, Japan, contact: Public Relations Department, Society of Manufacturing Engineers, One SME Drive, P.O. Box 930, Dearborn, MI 48128, (313) 271-1500.

## MAY

### **Session '84 (The National Conference of the Canadian Information Processing Society, CIPS).**

May 9-11, Calgary, Alberta, contact: CIPS Session '84, Canadian Information Processing Society, 722-500 4th Ave. SW, Calgary, Alberta, T2P 2V6 Canada, (403) 261-5744.

### **Computer Graphics '84.**

May 13-17, Anaheim, Calif., contact: Christine A. Radiske, National Computer Graphics Assn., 8401 Arlington Blvd., Suite 601, Fairfax, VA 22031, (703) 698-9600.

### **1984 IEEE International Conference on Communications (ICC '84).**

May 14-17, Amsterdam, the Netherlands, contact: Dr. T.A.C.M. Claasen, Secretary of the Executive Committee, Philips' Research Laboratories, P.O. Box 218, 5800 MD Eindhoven, the Netherlands.

### **Communications '84.**

May 15-18, Birmingham, England, contact: Kallman Associates, 5 Maple Court, Ridgewood, NJ 07450, (201) 652-7070; or Industrial and Trade Fairs Ltd., Radcliffe House, Blenheim Court, Solihull, West Midlands B91 2BG England, 021-705-6707.

### **Electro/84.**

May 15-17, Boston, Mass., contact: Nancy Hogan, Electronic Conventions Inc., 8110 Airport Blvd., Los Angeles, CA 90045, (213) 772-2965.

### **Mini/Micro Northeast-84.**

May 15-17, Boston, Mass., contact: Kent Keller, Electronic Conventions Inc., 8110 Airport Blvd., Los Angeles, CA 90045, (213) 772-2965.



**From**

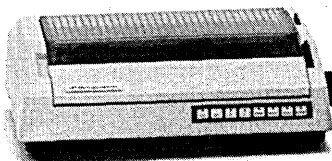

, to



## Nobody puts ideas on paper so many ways.

If you're using your printer with a personal computer, you probably need one that can handle a variety of functions.

At the same time, the price should be in line with the computer itself. Low.

The pint-sized Dataproducts printer in the picture costs about as much as one good software package.

It prints spreadsheets, graphics and illustrations, labels, multi-part forms—even letters that look like they were typed.

But let's say you're running a big computer and it's hundred-page reports you need. Pronto. Or documents by the millions.

The printer on the right finishes a full computer printout page in less time than it takes to sneeze. At 2,000 lines a minute, it prints much faster than you can see. Three shifts a day. Year after year.

In between these two special-duty Dataproducts printers are whole families of other Dataproducts printers—daisywheel

printers, non-impact printers, high-security printers for the government, and more.

In fact, we make more different kinds of computer printers than any other independent printer company in the world.

Very likely we make one that fits your needs exactly.

Write us at 6200 Canoga Avenue, Woodland Hills, CA 91365. Or phone (818) 887-3924. In Europe, 136-138 High Street, Egham, Surrey, TW 20 9HL England.

# Dataproducts computer printers.



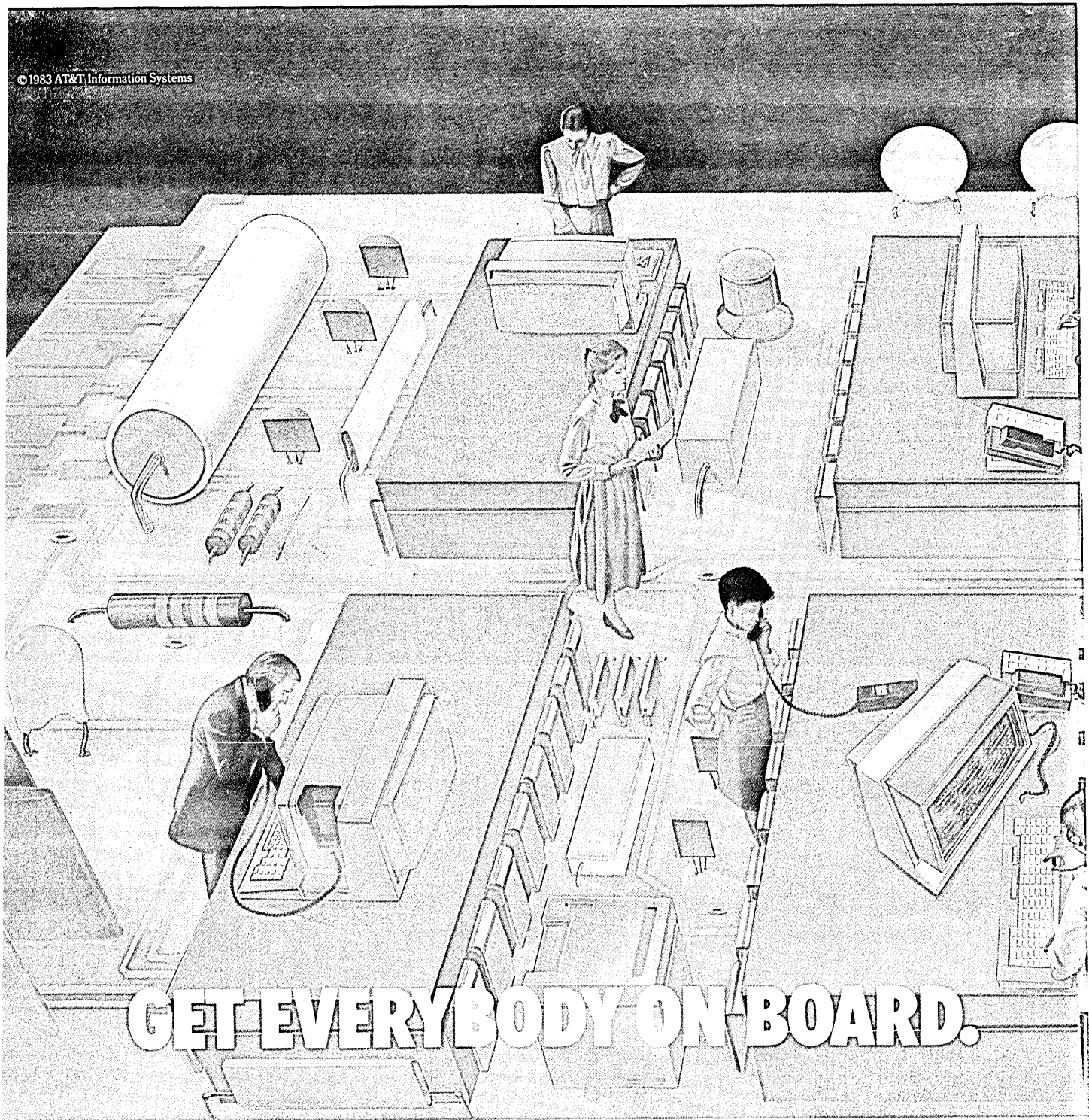

# GET EVERYBODY ON BOARD.

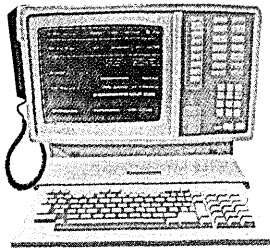

Now there's a way to let everyone in your company chip in.

AT&T Information Systems, whose unparalleled communications heritage has been bringing people together for over 100 years, now brings your company together. With DIMENSION<sup>®</sup> System 85, a digital state-of-the-art

communications and information management system designed to get your company moving ahead.

System 85 integrates your company so well because it is itself so fully integrated. Imagine a system that combines voice, data, office, network, building, and systems management and control functions. A system that features simultaneous voice and data transmissions, a non-blocking configuration, data-switching speeds up to 64 Kbps, capacity up to 25,000 lines, and increased customer participation in systems management.

And most importantly, a system with practical applications, like Message Center, Directory, and Electronic Document Communications. All this

makes System 85 the one system to choose when you've got to be right.

What's more, AT&T System 85 is the only integrated business system to offer all of these valuable functions that fully integrate your company:

*Voice management*—System 85 offers over 100 voice features like pre-programmed message paths for improved call coverage, advanced conferencing, and simultaneous transmission of voice and data.

*Data management*—An advanced Digital Communications Protocol (DCP) will enable data switching at transmission speeds of up to 64 Kbps. Our applications processor offers terminal emulation programs so you can communicate and share information

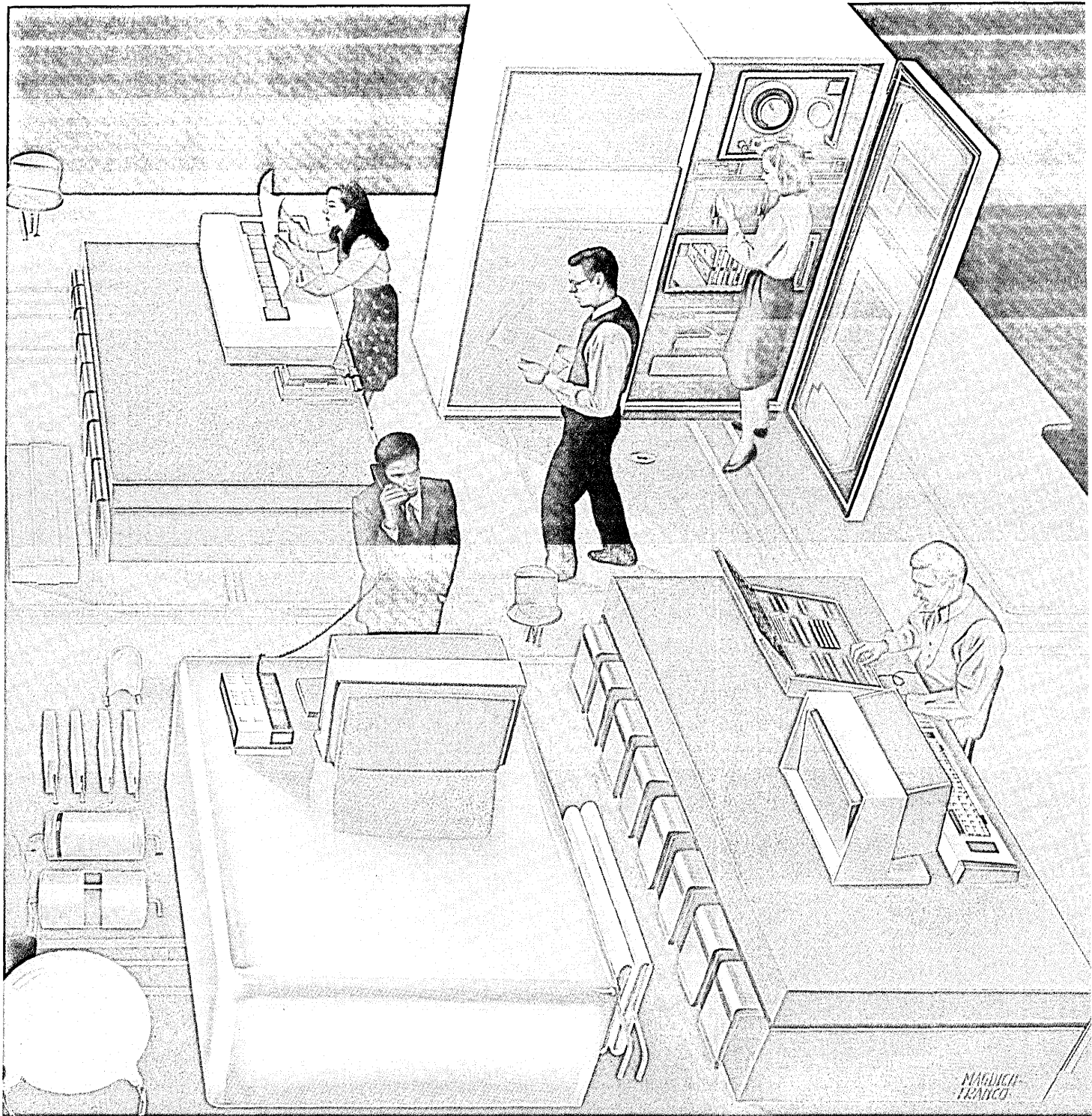

with a host computer.

**Office management**—Electronic Document Communications cuts down on routine paperwork by preparing, editing and sending information electronically. A Message Center answers calls, takes and stores all your messages electronically.

**Network management**—It centralizes control over and integrates voice, data, office, and building management functions into a single network. It reduces costs by routing long-distance calls over the most economical path.

**Building management**—Sensors monitor your doors and windows for increased security, and they can also regulate light, temperature and pressure to greatly reduce energy costs.

**Systems management and control**— Lets you manage and control the usage and operation of the system yourself, without assistance from outside technicians. You can rearrange terminals and their features with Terminal Change Management.

With System 85 integrating all of these functions, you'll be able to improve staff productivity at every level and get everybody on board. And as your company grows and changes, System 85's compatible and forward-looking modular architecture allows it to grow and change with you.

System 85 was developed by systems designers from Bell Labs. It's made with Western Electric product reliability and it's maintained with com-

prehensive, conscientious service from the largest service organization in the industry. To find out more, call toll-free 1-800-247-1212, Ext. 879M.

System 85 from AT&T Information Systems: It's part of the integrated office of tomorrow that you can board today.

**When you've got to be right.**





# INTELLECT.™

## NO SOONER SAID THAN DONE.

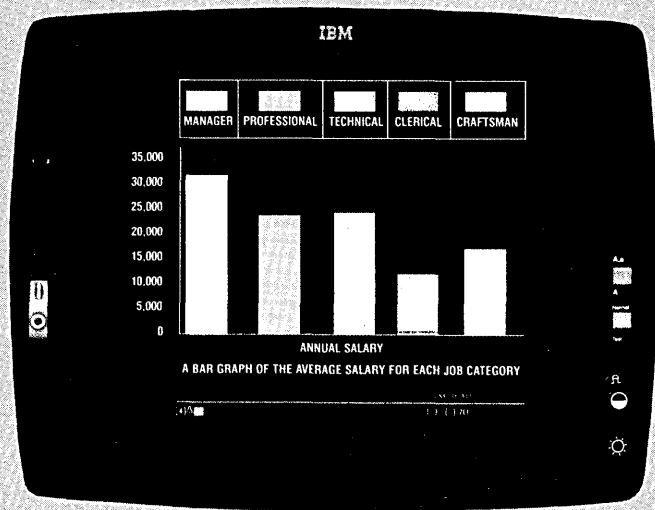
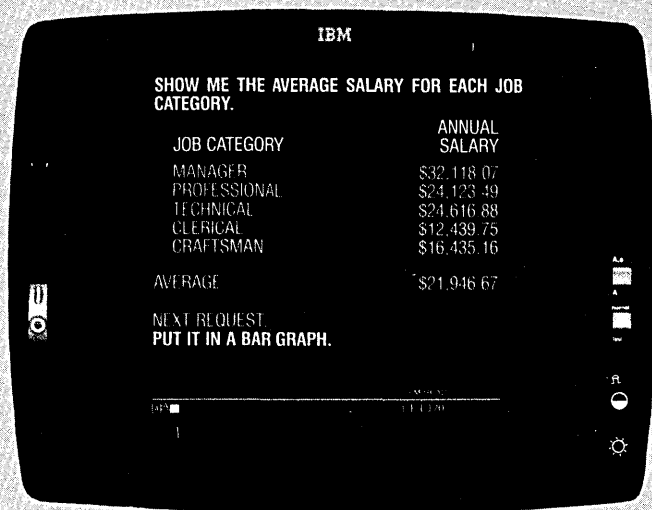

To use INTELLECT, the natural language query system, all you have to do is ask—in everyday conversational English—and you'll retrieve. Immediately, in either text or full-color graphics.

INTELLECT, the world's only successful *true* natural-language query system, is an ideal tool for your information center. INTELLECT's powerful information retrieval capabilities are so advanced that it understands questions and responds with answers as if you were talking to a knowledgeable colleague. Executives access data themselves—more easily than ever before—without learning any technical jargon or "computerese." It's so easy to use, it doesn't even have a training manual!

Whether you use INTELLECT as a retrieval system or as an effective data analysis tool, it transforms raw data in the data base into information and presents

it in finished color graphics in a matter of seconds. It's a live dynamic interface that fully integrates your existing database and graphic systems.

Already hard at work in hundreds of organizations, INTELLECT is ideal for marketing, finance, personnel, manufacturing, and banking applications.

INTELLECT is an important technological breakthrough. You can learn more about it by attending one of our nationwide seminars. Or put its amazing power at your fingertips in minutes with one of our demonstration tapes.

Call or write for more details. Look into INTELLECT, and be an eyewitness to the future of computing.



**ARTIFICIAL INTELLIGENCE CORPORATION**  
100 Fifth Avenue, Waltham, MA 02254 617-890-8400

CIRCLE 15 ON READER CARD

# LETTERS

## "CAN DO" MENTALITY UNDONE

I enjoyed Hugh Ryan's article entitled "End-User Game Plan" (December, p. 240). It points up the more complex issues in systems work that relate to the user-data processing interface. At this boundary, the success or failure of any practical systems development is determined.

As a student of consciousness and the mind, I wish to point out a gross error in what I call the "can do" mentality. My curiosity into the connection between the almighty internal dialog that rattles around in our minds and how we think and act led me to a very significant discovery. The "I can" approach to motivation, action, and task achievement is totally ineffective. The achievement of any goal based on an "I can" mental program leads to mental confusion and GIGO every time.

As a test of this, consider the following: Grasp a pencil tightly between your thumb and forefinger. Now keep repeating to yourself, "I can drop the pencil." The mind accepts this instruction and basically responds with, "Okay, I can drop the pencil, but what's next? You will find it impossible to instruct the mind to drop the pencil! Now, keeping the pencil tightly grasped between the thumb and forefinger, say the following, "I drop the pencil." By repeating this phrase you will find the muscles in your fingers quivering and relaxing. The pencil will drop!

The significance of this linguistic-neurological discovery points out how we have learned to sidetrack towards less than optimal mental functioning by the way we consciously and unconsciously talk to ourselves. No wonder that we use only 10% of our mental capacities. In addition, the "I can" mentality leads to a pure will power dominated goal programming. This coaching approach will result in very strong-willed, determined individuals who use the power of fear and insecurity to attain their goals. If successful, they win, but systems

and do lose! This mental programming results in a force-of-will office automation system and makes the human-electronic interface a very difficult barrier to overcome.

The "I do" mental programming, as advocated by W. Clement Stone and Napoleon Hill, will yield "egoless" programming and systems development. In addition, a significant benefit of this mental programming is very efficient time management. Things will get done, and without laying blame for missed deadlines or lack of funds and hardware on staff and upper management for not understanding the "technical" problems associated with completing a systems project.

The football coach approach to resolving the managerial problems facing all dp installations does work when we are using the types of language constructs that direct our minds correctly.

ISRAEL M. KNOBEL  
Data Processing Manager  
Shippers Management Corp.  
Philadelphia, Pennsylvania

## MICROLAND UNDERMINED

"Adventures in Microland" (November, p. 153) are more exciting and successful than you present. You correctly report that at Shaw Data Services we developed our own custom protocol converter, a "black box" that links IBM PCs to our Honeywell bisynchronous network. But what you fail to comment on is our clients' very successful use of the PC using downloaded data.

In the IBM PC, we provide our customers with a program that allows them to "translate" screens of data from our mainframe into a format that can be used by Lotus, SuperCalc, Multiplan, and other spreadsheet packages. This piece of software and the concept of the custom protocol converter have been extremely successful because they allow the end user to save the data that he wants and to prepare special reports that we may not be able to provide in

the time frame required.

The power of this concept is compelling to users, as it enables them to get things done on their own without slogging through the inevitable decision-making process for changes to a system that serves many, many different users.

At this point, we believe that the only downside effect is that a few of our clients have been so aggressive in developing local applications on the PC that they have reached beyond the capabilities of the PC and have developed systems that are not robust enough to be reliable and accurate in their operations.

But on the whole, this concept is now a proven and accepted fact of life in the micro-mainframe connection.

CRAIG M. SHUMATE  
Vice President,  
Corporate Planning and Development  
Shaw Data Services Inc.  
New York, New York

## FIGHTING BACK

I would like to reply to Mr. Philip Harris's review (December, Source Data, p. 281) of my book, *Needed: Professional Management in Data Processing*.

First, as to my background, I have 25 years' experience in data processing in a variety of industries, having held such positions as programmer, analyst/programmer, senior systems analyst, systems leader, and project manager. Experience has included both scientific and commercial applications areas with IBM and Univac hardware/software installations. Projects have run from small and short duration into very large and several years duration.

However unfortunate repetition might be, another charge leveled by Mr. Harris, it appears to be necessary to hammer when a large number of clichéd beliefs have become deeply entrenched in the dp field as the dominating beliefs upheld in "management" practices.

## LETTERS

If there is a problem in management viewpoints, whether dp or otherwise, it is that strong tendency to stress overcontrolling, almost to the point of strangulation of any creative initiatives on the part of employees.

What I discussed about project management concepts is correct. I again never intended to provide an in-depth analysis of control techniques or project management concepts, but to highlight some factors dp managers need to think about before jumping into controls at full speed, or at least point out that the controls mean the managers have a clear handle as to what is transpiring.

It was unfortunately necessary to include negativism in writing my book, a negativism that Mr. Harris has indicated undermines my case and has alienated him. Mr. Harris should know that in a consulting assignment, problems are very often uncovered. These problems can be whitewashed, glossed over as a minor cause for concern, or so presented as to draw attention to them, depending upon the nature of the assignment. Many an executive does not want to hear about such problems, unless they are presented with white kid gloves.

In sum, Mr. Harris's comments, criticisms, and opinions about my book bring strongly to mind the recent words of a

social research scientist friend who said, "None is quite so blind as the person who refuses to see, even after the evidence is placed before his eyes."

JOHN CALLAHAN  
Arlington, Texas

### SWITCHED DATA

The November Look Ahead column presents false and misleading information on the progress and capabilities of the Mitel SX-2000 Integrated Communications System. To set the record straight, the sx-2000 is being sold in three configurations: the SX-2000 S, providing 150 to 450 extensions plus trunks; the sx-2000 SG, with 250 to 3,000 extensions plus trunks; and the SX-2000 MG, taking the switch from 2,500 to 10,000 extensions plus trunks. The switch was not designed as a 20,000-line switch.

Starting in January, Mitel began shipping the sx-2000 SG with voice and data capability. The data capability at this initial software release provides up to 9.6Kbps of asynchronous data transmission. This is provided through the Dataset 1, connecting any data terminal or data circuit terminal equipment with matching data system stream formats or protocols through the SX-2000.

In April, the sx-2000 SG will be enhanced to increase the capability through

the use of Dataset 2, offering 19.2Kbps synchronous or 9.6Kbps asynchronous data transmission.

Mitel will continue development on the SX-2000 to provide increasing capability with subsequent releases. As you can see, the switch now going out is far more than a "speech only" version.

KEITH FAGAN  
Director,

Large Systems Product Marketing  
Mitel Corp.  
Kanata, Ont., Canada

### CORRECTION

In the January issue, the article "Touch Screens: Big Deal or No Deal?" quoted Aetna Life & Casualty consultant Richard Telesca as saying that his company had experimented with the Easel touch-sensitive information system but had dropped it. In fact, Aetna is still working with Easel's vendor, Interactive Images Inc., of Woburn, Mass., on ways of integrating Easel into Aetna's dp installations. \*

Your comments on DATAMATION are always welcome. We do reserve the right to edit the letters for either brevity or clarity. Letters should be addressed to Editor, DATAMATION, 875 Third Ave., New York, NY 10022.

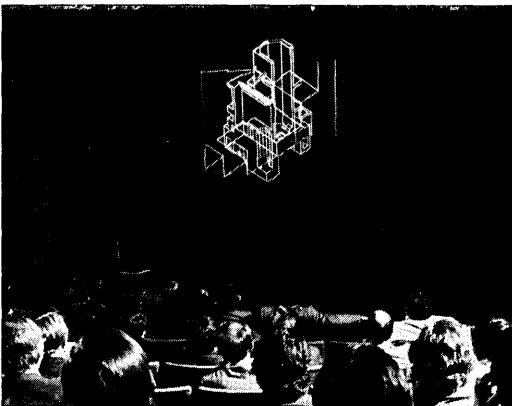

COMPUTER-AIDED DESIGN displayed by General Electric projector is viewed by Engineering Society of Detroit.

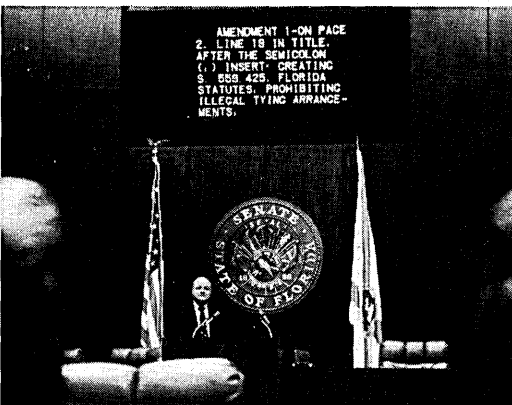

WORDS "PUNCHED UP" by clerk of Florida State Senate are inspected carefully before a vote.

## Invite your computer to meetings with General Electric Professional Large Screen Video Projection

With General Electric's exclusive system for bright, sharp professional-quality pictures, up to 25 feet wide, General Electric Professional Large Screen Video Projectors are making presentations more dramatic, more productive, and more convenient.

Whether videotape, live transmission, TV programming or data direct from your computer, the pictures projected can be seen by everyone in the room, all at once, even when room lighting is provided so viewers can take notes and refer to written material.

The color projectors show every viewer the same accurate color reproduction. An exclusive General Electric system registers the colors for you, eliminating time-consuming manual adjustments.

Portable and flexible, General Electric projectors are being used in a great variety of applications, including both rear and front projection. Ask our applications experts whether yours can be added to the growing list. Call or write: General Electric Company, Projection Display Products Operation, Electronics Park 6-206, Syracuse, NY 13221. Phone: (315) 456-2152. TWX 710-541-0498.

**GENERAL**  **ELECTRIC**

CIRCLE 16 ON READER CARD



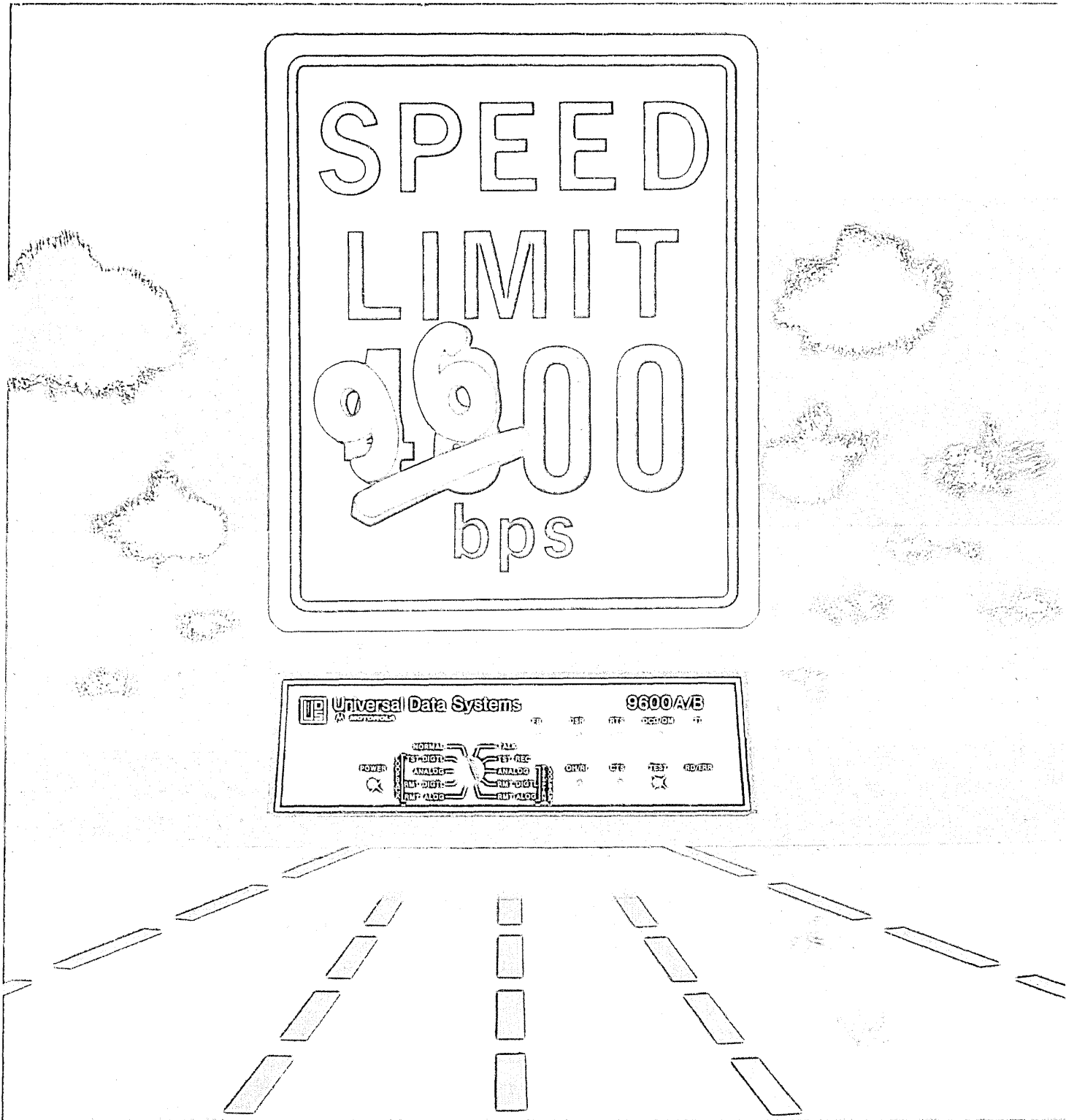

## UDS raises the speed limit for dial-up modems

At last there's a 9600 bps modem designed especially for the dial-up telephone network.

Our 9600 A/B is the ideal modem for projected system growth. Realize immediate line-charge savings by moving from 208 A/B to 9600 A/B now! Then, if your system demands dedicated lines, simple strap modifications will convert your modems. Nothing else changes!

A faster turnaround time than 208 A/B's further increases the 9600 A/B's efficiency. Multiple test modes are selectable from the front panel.

Contact Universal Data Systems, 5000 Bradford Drive, Huntsville, AL 35805. Telephone 205/837-8100; TWX 810-726-2100.

 Universal Data Systems

AA MOTOROLA INC.  
Information Systems Group

UDS modems are offered nationally by leading distributors. Call the nearest UDS office for distributor listings in your area.  
DISTRICT OFFICES: Old Bridge, NJ, 201/251-9090 • Blue Bell, PA 215/643-2336 • Atlanta, 404/998-2715 • Glenview, IL, 312/998-8180 • Columbus, OH, 614/895-3025 • Boston, 617/875-8868  
Richardson, TX, 214/680-0002 • Englewood, CO, 303/694-6043 • Houston, 713/988-5506 • Tustin, CA, 714/669-8001 • Mountain View, CA, 415/969-3323 • Silver Spring, MD, 301/587-0166

CIRCLE 17 ON READER CARD

Created by Daynard/Hall, Inc., Winter Park, FL

# Managing a Constant Wave of Facts & Figures



That's why over 5,000 companies are running

Software International has nearly two decades of experience in doing one thing with exceptional expertise: providing on-line, financial applications software for mainframe and mini computers.

We give you the special touch you need to anticipate and manage an increasing flow of numbers with accuracy and ease. When financial and accounting professionals want to run with confidence, they run with Software International.

Software International® software packages include:

- ▣ General Ledger and Financial Reporting
- ▣ Accounts Payable
- ▣ Payroll and Human Resource Management
- ▣ Accounts Receivable
- ▣ Fixed Assets Management
- ▣ Forecasting, Modeling and Reporting
- ▣ Micro-Mainframe Smart Link™ and Query.

Call or write:  
Software International,  
One Tech Drive  
Andover, MA 01810  
**800-241-3208**

Software International is a wholly-owned subsidiary of General Electric Software Products Company.



FOR THE FUTURE



With Software International financial applications software

GENERAL ELECTRIC SOFTWARE PRODUCTS COMPANY

# The Data Center is under your command.

## But is it under your control?



Value Computing's systems management software automates the critical tasks of production forecasting and scheduling, capacity planning, and resource allocation and accounting, and brings those tasks under centralized control. Your control.

The effects on data center operations are immediate: a more stable production environment...faster turnaround...fewer manual procedures...shorter night processing times...fewer mistakes, misunderstandings, re-runs...greater productivity from your operations personnel.

In short, a smoother running, better performing data center; a center where managers get the most intensive use of all resources. Without making a major capital investment in additional CPUs or peripherals.

We don't believe there's a more cost-effective way to improve the performance of your data center or the value of its position in your company. Call us and find out why more than 1500 users agree.

**Value Computing Software Systems:**

**DCMS**—The most powerful and comprehensive production scheduling and control system available.

**Comput-A-Charge**—The industry standard in job accounting and computer billing.

**VALU-LIB**—An entirely new tape management system designed for today's VS environments.

**SMF Express**—A unique package for the management of important SMF data.

## VALUE COMPUTING

THE OPTIMUM SOFTWARE FOR DATA CENTER MANAGEMENT

Value Computing, Inc., 498 N. Kings Highway, Cherry Hill, NJ 08034 (800) 257-8242. In New Jersey (609) 482-2500

CIRCLE 19 ON READER CARD



# EDITORIAL

## THE GREAT DIVIDE

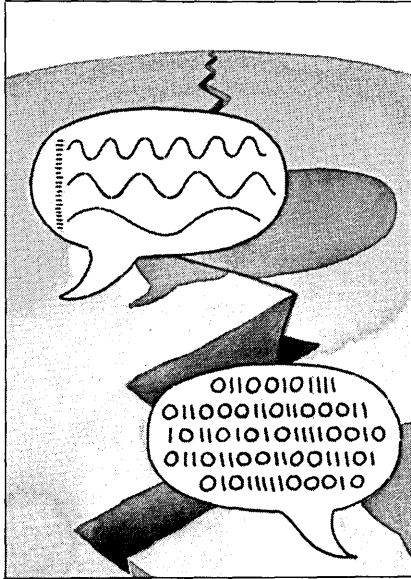

For years, few words passed between the telecommunications manager and the data processing manager. In addition to the fact that neither had much interest in the other's operations, they also spoke different languages. The bauds and bandwidth banter of the telecom group was unintelligible to the dpers, who spoke in bits and bytes. The fields of voice and data were miles apart.

Today, those turfs are not only closer, but in many cases they overlap. A voice/data PBX can serve as the cornerstone of a corporate communications system or as the backbone of an office automation system. Financial consolidation and reporting systems are as dependent on effective telecommunications as on efficient data processing. Technologies are becoming relatively easy to integrate. What's more difficult to integrate is job functions. It's time to bridge the divide between telecom managers and dp managers. And the gap is great.

Although telecom managers have been around twice as long as dp managers, their role through the years has remained more static. Trained largely by the Bell System, telecom managers functioned in a relatively controlled environment. They operated a budget based on current, and recurring, costs. Corporate communications was an expense item that was predictable at least five years out. Sure, Ma Bell's steady rate hikes had to be anticipated and taken into account, but there were few other variables. The work of telecommunications managers, often thankless, was seldom challenged—either technologically or by corporate management.

Situated in another corner of the corporate basement was the dp department. Masters of mystique, these dp types had quite a different budget to manage. Weighted down with multimillion dollar capital expenditures, the dp budget was not only mammoth, but also unpredictable. With so much money and manpower funneled into their departments, dp managers had frequent and often frustrating accountability sessions with corporate management. What's more, the expertise of the dp department was constantly being challenged by young whippersnappers, those fresh, feisty computer science graduates armed with the latest in this fast-changing technology.

What happened, of course, is history. The dp department moved up fast. Having tackled the challenges of constant change, ever-bulging budgets, and a growing dependence on them by corporate management, data processing managers had gained—whether by force or by fiat—valuable management expertise. Soon, dp managers were within earshot and arm's reach of top management.

And where was the telecom manager all this time? Still plugging away at the formula for assessing next year's corporate telephone costs.

The tables have turned on telecommunications managers. Today they face the management challenges that were met head-on by dp managers 10 to 15 years ago. Job responsibility includes both voice and data, and often spreads into the realms of data processing and office automation. And just when the pace of technological change picked up, the long-incumbent telecom supplier packed it in. The dismantled AT&T can now be eyed as an option rather than an assumption. That means capital expenditures loom large; indeed, corporate management is banking on its ability to depreciate some telecom equipment over time to keep communications costs down. The telecom manager-turned-purchasing agent has a much bigger budget to manage—and it's an elastic one at that.

Telecom managers are now in the limelight. Their challenge is greater than the management of what's traditionally been considered the telecommunications turf. It stretches well into the field of dp. That same challenge, in reverse, holds for the dp manager.

The technologies now talk to each other. So should the managers. \*



# A LONG, DRAWN EXPLANATION OF THE DCA

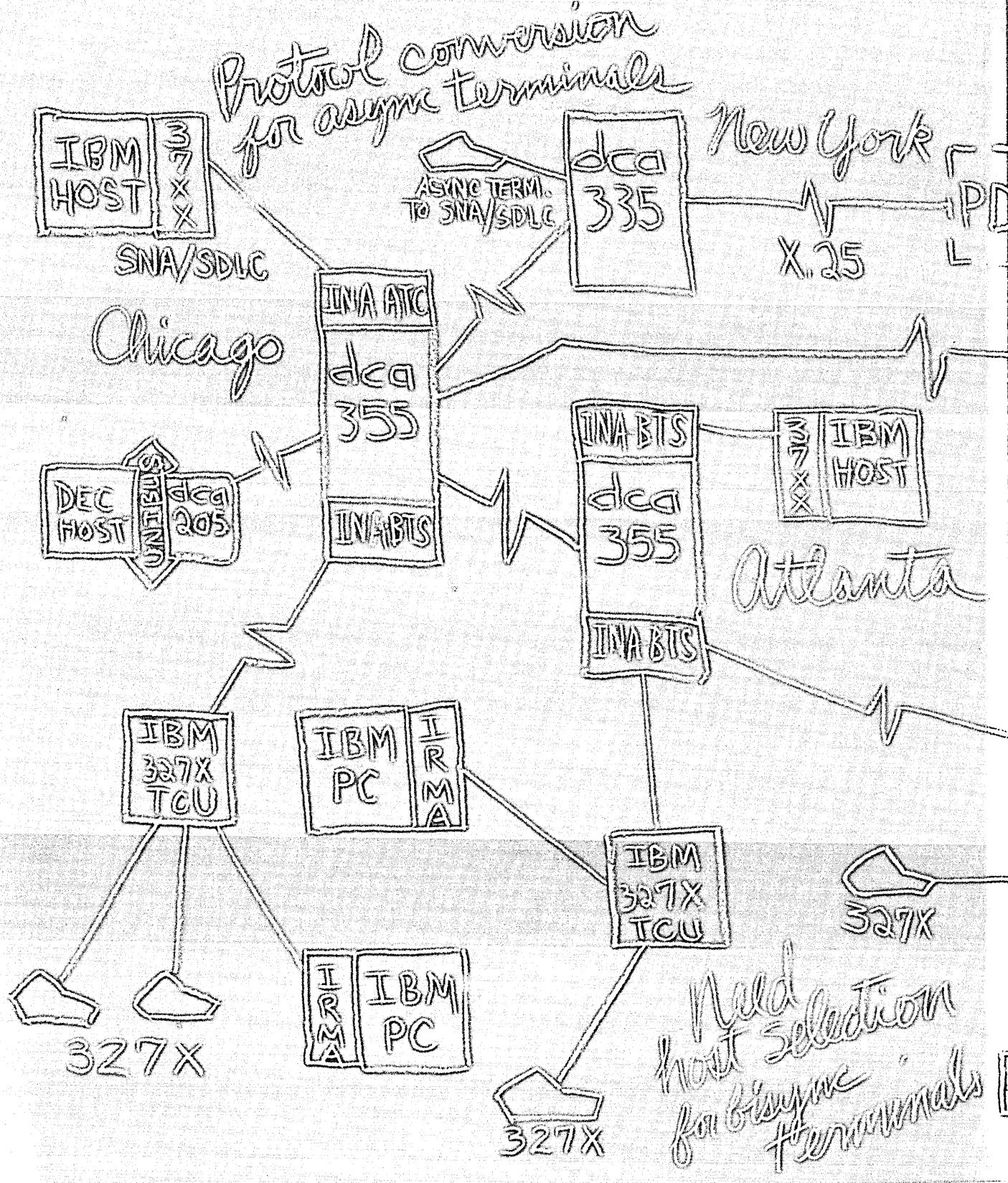

# OUT DATA NETWORK.

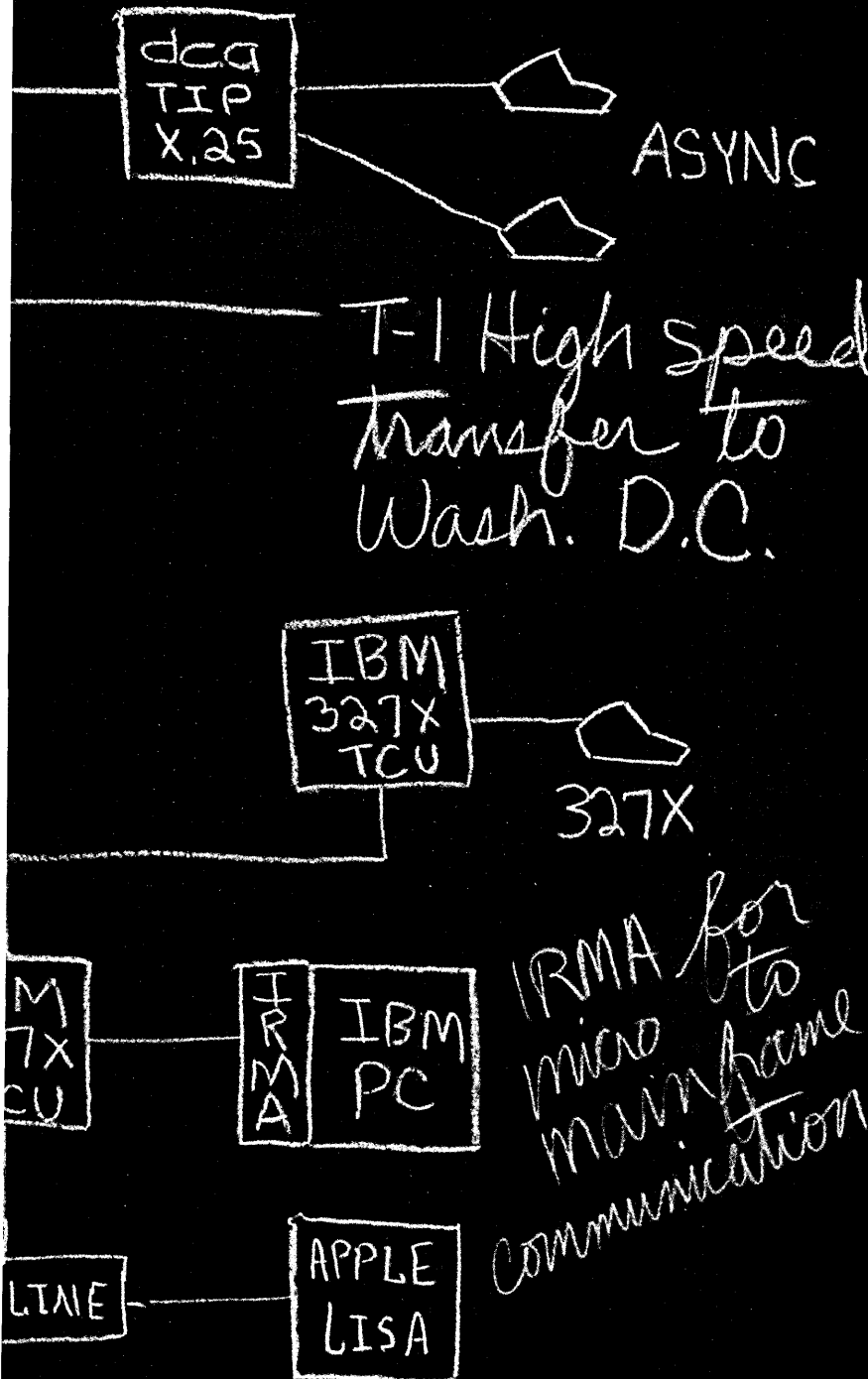

It's really very simple: A DCA network can integrate all your datacomm equipment — IBM or non-IBM — into one flexible, efficient system. We call it Integrated Network Architecture (INA). And it offers many remarkable advantages.

Like network transparency: Our hardware is compatible with all hosts and terminals — synchronous or asynchronous. So you're free to use less expensive async terminals and modems.

Host selection: With INA, any async terminal in the network can access any host in the network. Including IBM hosts, packet mode hosts and public data networks. And any 327X terminal can access any host running 3270 BSC.

High speed transmission: You can transmit combined voice and data at speeds up to 1.544 MBPS.

Modular hardware: You can upgrade and expand your network simply by adding — instead of replacing — low-cost DCA components.

And since data is routed through a network processor instead of a dedicated host, no host software is involved and no extensive programmer training is required.

Simplicity. Flexibility. Efficiency. Savings. Chalk them up to INA. From DCA, 303 Research Drive, Norcross, Georgia 30092. Call us toll-free: **1-800-241-5793.**

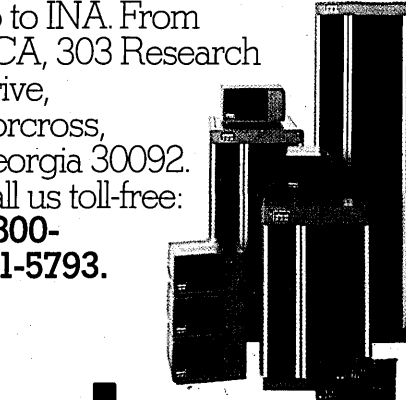

**dca**<sup>®</sup>

Digital Communications Associates, Inc.  
DCA Products Are Available Worldwide.

CIRCLE 20 ON READER CARD



# INFOCUS

## EASY MONEY

**Thousands of automated teller machines are linked in 125 nationwide networks. Has the wiring of America begun?**

by Robert M. Garsson

When banks first began dotting the American landscape in the early 1970s with automated teller machines—terminals that dispensed cash, accepted deposits, and performed other routine banking functions—there was little reason to believe that anything revolutionary was in the wind. Even after financial institutions began linking the terminals in networks, it was by no means obvious that a transformation of fundamental importance was under way.

But today, as the terminals are adapted to handle ever more self-service transactions, and as the networks continue to reach out into every corner of America, the promise of shared ATM networks is becoming clear. What has begun is nothing less than the wiring of America.

In the past three years the proliferation of ATMs and networks has been nothing short of astounding. The Bank Marketing Association, in a report on shared networks, says that by 1980, there were 20 such networks sharing from 15% to 20% of the 10,000 ATMs then installed in the United States. Two years later, says BMA, 110 networks shared 45% of the 32,000 ATMs in place.

Today there are widely varying estimates of the number of ATMs and the number of shared networks. Richard Dart, a product manager at Cambridge, Md.-based consultants Trans Data Corp., says a recent survey turned up an installed base of 35,000 ATMs, about half of which are shared by 154 networks; some 8,000 of the banks not yet part of a network, about half, said they planned to join one within the next few years.

Another independent market researcher estimates that 47,000 ATMs were installed in the U.S. By 1990, there will be 125,000 machines shooting \$20 bills into depositors' hands, says an ATM consultant.

As for the number of operating networks, estimates start at 200 and work down to 125, because of the consolidation of duplicative regional systems.

Nationally, there are seven shared networks. The oldest is American Express Co.'s Express Cash, a network of traveler's check dispensers that also interchanges with bank-owned ATMs. It currently links over 1,000 terminals in 16 states.

The bank card associations have

also jumped into the game. MasterCard began operating its MasterTeller network last year and Visa will start its network this year. MasterCard says it will link over 1,000 ATMs in 24 states this year, and Visa promises to have over 3,500 terminals linked in 30 states.

The remaining networks include Nationet, a Dallas-based network that says it will link 13 regional networks with nearly 6,000 terminals in 26 states in 1984; Automatic Data Processing Inc.'s The Exchange, which will connect more than 1,000 ATMs in 33 states this year; Cirrus, a bank-owned network that will tie together over 3,500 terminals in 41 states; and Plus, another bank-owned network that promises to have over 3,000 terminals on-line in 47 states by year end.

For the consumer, the benefits have been quick and dramatic. A customer of New York's Chase Manhattan Bank, for example, finding himself cashless in San Francisco, need only find a Bank of America ATM to make a withdrawal from his checking account back home. Wiped out at a craps table in Caesar's Palace casino and hotel in Las Vegas, a Manufacturers Hanover bank client from New York has only to walk 50 feet or so to a pair of ATMs in the hotel lobby, operated by Plus and Cirrus.

Although the networks are still in their infancy, bank electronic funds transfer (EFT) managers have begun to think of them as electronic highways over which many

**ATMs now spit out ski lift tickets, airline tickets, and hotel receipts as well as cash from brokerage firm accounts.**

kinds of financial data can be transported. Across the country, network operators are working feverishly to adapt their systems to support electronic payments at the retail checkout counter, or point of sale, as such transactions are more commonly known (December, p. 99).

In the retail environment, the consumer would present his ATM access card—also known as a debit card—to the merchant. The information encoded on the card's magnetic stripe would be read electronically and routed to the issuing bank's host computer. As a security measure, the consumer would enter his personal identification number, which the bank computer would verify. Assuming the user had sufficient funds in his checking account to cover the purchase, the transaction would be authorized and the consumer's account would be debited. At the end of the day, when settlement is made, the merchant's account would be credited.

And down the road, the same networks are expected to be adapted still further to support home banking. MCI Commu-

ILLUSTRATION BY MICHAEL GARLAND

# CASINO



## IN FOCUS

nications Corp., which has its own telecommunications network, has announced plans to support home banking by wiring consumers from their homes into ATM network switches. "We want to take advantage of the networks banks have built," explains MCI vice president for planning Philip S. Nyborg.

Together, point-of-sale and home banking could move the nation a giant step closer to the "cashless society" that has in the past seemed so close and proved so elusive.

The shared networks constructed to support ATMs seem so rife with potential that only now is the versatility of the dispensers themselves recognized. If they can be used to dispense cash, then why not also adapt them to spit out ski lift tickets, airline tickets, hotel receipts, or almost anything else that involves a payment and a piece of paper? Indeed, they are being adapted to handle all of those tasks and more.

Best known, thanks to a television advertising campaign, is Avis Rent-a-Car's automated return system, which uses an ATM manufactured by Diebold Inc., Canton, Ohio, the nation's leading manufacturer. The user inserts a credit card, calls up his bill, punches in a few details, such as the

### **Insurance used to be cheaper than the cost of data security devices. Not anymore.**

car's mileage, and is given an itemized receipt after the transaction is completed. In Chicago's O'Hare Airport, American Airlines is testing an NCR terminal that permits a customer to make a flight reservation, pay for it, and receive a ticket.

In short, the ATM is leading the way toward the self-service society and all the convenience that the American consumer is widely believed to prize so highly.

Without shared networks, however, the self-service terminal, whether it be a ski lift ticket dispenser or a cash dispenser, would be of limited value. By linking it to the credit card authorization system, customers can use MasterCard, Visa, or American Express to pay for the transaction. And by linking it to one or more of the shared bank networks, customers can use their debit cards to pay for the items with cash from their checking accounts. As brokerage firms begin to link their asset management accounts to ATMs, consumers will eventually be able to access all their assets—from their stocks to the equity in their houses—at an ATM.

The potential of shared networks runs far beyond point-of-sale and home banking. "These discussions usually focus on the retail, or consumer, side," says D. Dale Browning, senior vice president of Colorado National Bank of Denver and president of Plus System Inc., one of seven

## TYING THE KNOT

Sharing ATMs presents no overwhelming technological problems for banks, especially since so many software packages are available to run network switches. Paul R. Kramme, president of Nationet—a Dallas, Texas-based national shared network that bills itself as a "network of shared networks"—says his member networks have spent anywhere from \$10,000 to \$30,000 each developing interfaces to Nationet's Carleton, Ind., switch.

The Nationet switch was purchased from Anacomp Inc., Indianapolis, one of four vendors that provide most of the switching software in use today. It runs on a Perkin-Elmer 3200 series superminicomputer. "The protocol we use is a pretty straightforward IBM protocol," says Kramme.

One problem for the industry as a whole has been the lack of standardization. Although ANSI's X9.2 committee has worked out an industry standard, it has yet to be adopted. "Fortunately, most of our members are using protocols that were based on the proposed ANSI X9.2 standard," Kramme says. "It will make life easier for everyone, though, if they adopt a single standard."

That is especially true in the retail point-of-sale area, he adds. "If we want to move toward a system that everyone [consumers, merchants, and financial institutions] has access to, we don't have much choice. There has to be a single standard." Fortunately, he says, a number of the large national networks—which, in turn, influence the standards adopted by their member banks—use protocols based on ANSI X9.2.

The evolution from ATM sharing to retail point-of-sale payments will present problems for some, but should prove no trouble for those proprietors of networks who have had their eyes on the merchant's checkout counter all along. "The technological and operational requirements of expanding from ATMs to point of sale is not difficult at all," says Darwin Deason,

national shared ATM networks. "But there is even more potential on the wholesale, or corporate, side," he adds. The networks could be used as an alternative to the Federal Reserve System to clear checks electronically, he notes. They could be used for such corporate cash management products as cash concentration, funds transfer to disbursement accounts and vendor payments. In many ways, Browning says, they could provide an alternative to the bank-operated automated clearinghouses (ACH), another electronic funds transfer network, but one Browning regards as "a dismal failure."

Others—most notably George White, publisher of *White Papers*, Montclair, N.J., and perhaps the nation's foremost advocate of the ACH system—take the

chairman of Affiliated Computer Systems, the Mercantile Texas Corp. subsidiary that operates the Mpack network in Texas. That is especially true, he adds, "if your network was designed with that thought in mind."

Roger J. Abouchar, division vice president of Anacomp, says that perhaps half the nation's networks purchased the capacity to process point-of-sale payments as well as ATM transactions. Those that did not, he adds, will find themselves replacing their switches at some point—or face the prospect of being shut out of the point of sale market. The Anacomp switch comes in a modular package, with one module to support ATM interchange and the other to support point-of-sale transactions. "Most of our customers just pay for the ATM module at first," Abouchar says. "But both modules are included, so when they get ready for point of sale, all they have to do is pay the licensing fees for that module."

How big a market exists for network switches is anyone's guess. "I've seen estimates of as many as 800 switches being installed by the end of the decade," Abouchar says. "I think that's high, but an estimate of 500 is fine with me." While the prices vary depending upon the network, a single switch can run from \$300,000 to \$500,000, he adds.

The market for terminal devices is, if anything, even larger. Susan Skinner, a Donaldson, Lufkin & Jenrette, New York City, securities analyst who once followed banks and now tracks the stocks of companies that provide technology to banks, thinks as many as 245,000 terminals of one kind or another may be purchased by the end of the decade. That ranges from full-service ATMs to cash dispensers to a card reader and personal identification number (PIN) pad device that can be attached to a merchant's electronic cash register. "If you just average out the cost at \$17,000," says Skinner, "that means we're looking at a \$4.2 billion market."

opposite view. Instead of creating new ATM networks, the industry should adapt the existing automated clearinghouse system to support point of sale and ATM interchange. "The ACH is already there," says White. "It's inexpensive and it works."

While the ACH network reaches every bank in the country, not all the links are electronic. Small, technologically unsophisticated banks, for example, are likely to receive printouts of ACH tapes, rather than magnetic tapes or electronic transmissions of ACH data.

Whether or not bankers like the automated clearinghouse network, its existence could force them to step up the pace on shared ATM networks, because nonbank competitors are tying into the ACH system.

# Self-dFENSE™ for EDP managers.

The micro invasion has begun. And, chances are, you've now got a lot of different people in a lot of different departments using a lot of different micros.

Now there's a way for you to control and maximize the benefits of all the different micros in your domain.



## Fight back with dBASE II.®

dBASE II is the relational database management system from Ashton-Tate that enables you to manage your micro-based corporate data resources with the high level of consistency and sophistication you've enjoyed with mainframe and minicomputer systems.

Armed with dBASE II and the dBASE II RunTime™ program development module, you can write programs which will enable micro users in each department to "do their own thing" while creating complete database consistency throughout the company.

dBASE II is a powerful, flexible way for you to effectively manage the micro proliferation.

## Help is here.

If you'd like to know more about how dBASE II and RunTime can help you win the micro management battle, contact Ashton-Tate today. 10150 West Jefferson Boulevard, Culver City, CA 90230. (800) 437-4329, ext. 217. In Colorado (303) 799-4900. In the U.K. (0908) 568866.

ASHTON · TATE ™

dBASE II is a registered trademark and RunTime is a trademark of Ashton-Tate.  
Suggested retail price for dBASE II is \$700.  
© Ashton-Tate 1984



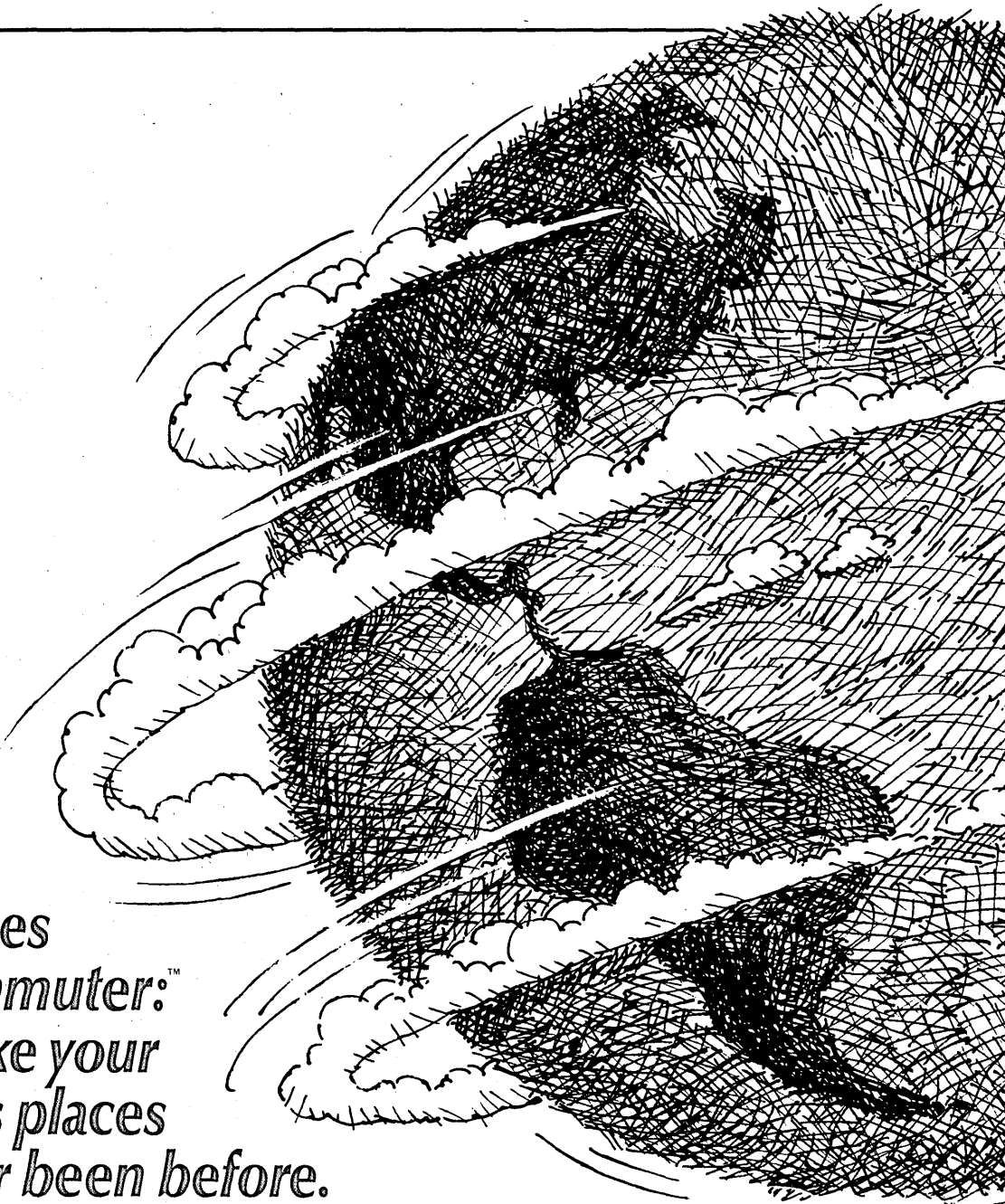

*Visual  
introduces  
the Commuter:<sup>™</sup>  
It can take your  
business places  
it's never been before.*

**Heavyweight power, memory, and true IBM® PC compatibility in a portable 16 pound computer.**

The portable computer can be a very powerful business ally.

But like any good business partner, the right one can be very hard to find. Some portables are powerful. Some are IBM compatible. Some are affordable. And some are actually portable.

However, there's never been one portable computer that could gracefully combine all of the above. Until now.

**Put the power of a desk-top computer in your hands.**

Introducing Commuter,<sup>™</sup> the powerful portable computer. When you carry it, you're carrying all the capacity, capabilities, and features of a desk-top computer. Yet you're carrying only 16 pounds.

Commuter comes with a 16-bit 8088 processor. 128K of memory, expandable to 512K. Single or dual floppy disk drives, each with 360K bytes of storage. A large 80 column by 16 line optional flat panel display, designed to be easily removed when Commuter is used with an external monitor. A full 83 key keyboard with an IBM PC layout, including numeric pad and ten function keys. And IBM compatible color graphics and monochrome support.

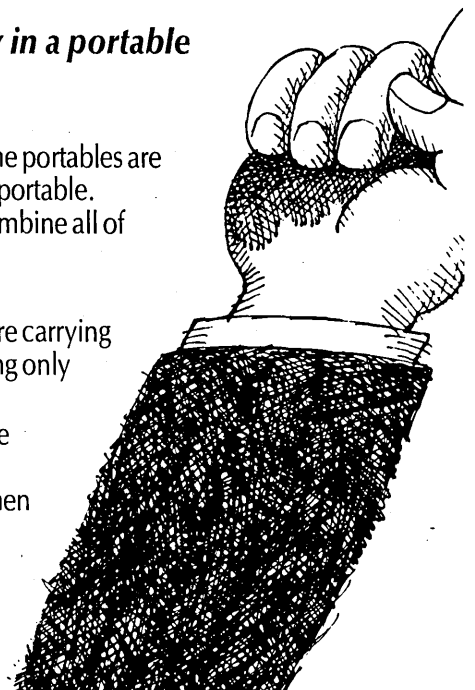

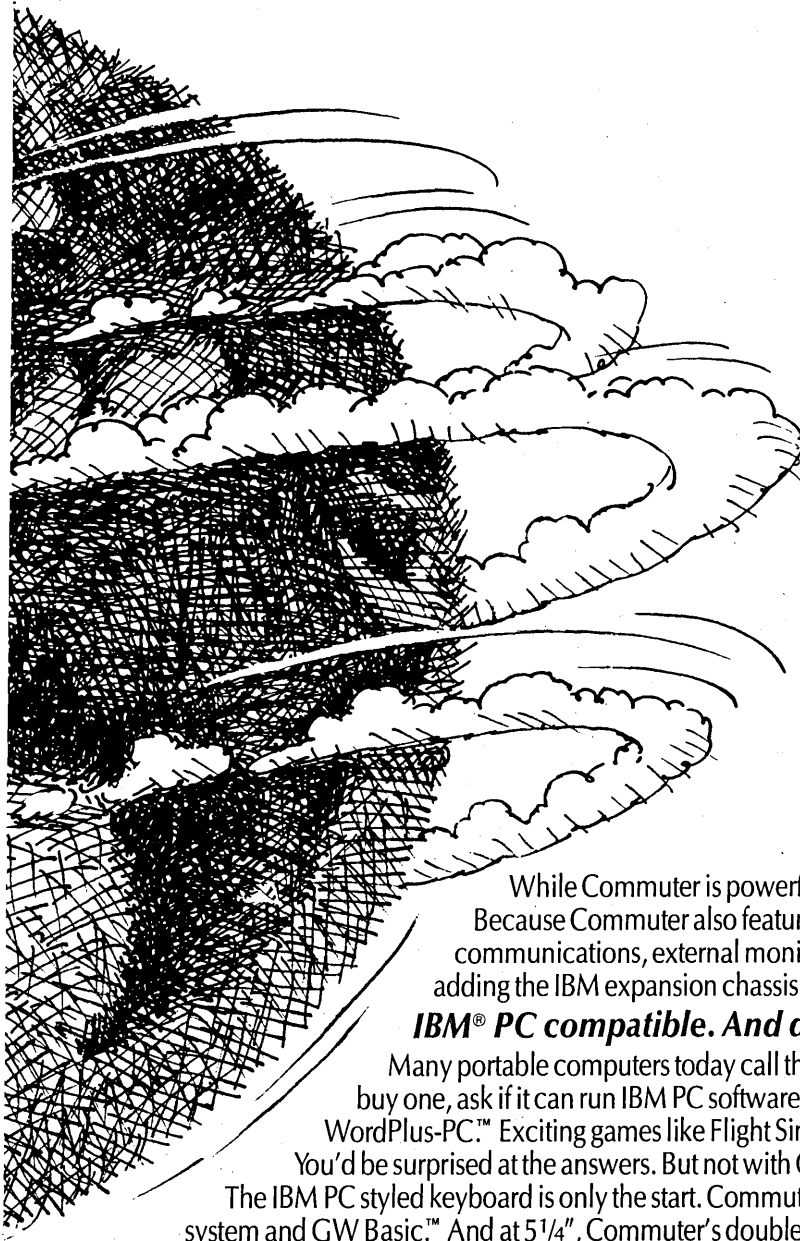

While Commuter is powerful enough to stand alone, it can really grow on you. Because Commuter also features built-in ports for adding printers, hard disk, communications, external monitors, and your television set. Even a built-in port for adding the IBM expansion chassis.

**IBM® PC compatible. And downright sociable.**

Many portable computers today call themselves IBM compatible. But before you buy one, ask if it can run IBM PC software. Business programs like Lotus®1-2-3,™ VisiCalc™ or WordPlus-PC.™ Exciting games like Flight Simulator.™ Or educational games from Spinnaker.™ You'd be surprised at the answers. But not with Commuter. In fact, think of it as an IBM PC to go.

The IBM PC styled keyboard is only the start. Commuter comes bundled with the MS-DOS™ operating system and GW Basic.™ And at 5 1/4", Commuter's double-sided double-density diskettes are directly transferable to and from the IBM PC. So you can take advantage of the hundreds of business accounting, word processing, financial planning and other software packages available for the IBM PC. Without having to modify a thing.

**At \$1,995 and 16 pounds, it's never been easier to pick up a portable computer.**

At 15"x18"x3 1/2" with built-in handle and carrying case, the Commuter can go anywhere a briefcase can. It fits easily under an airplane seat. Because it weighs just 16 pounds (about half the weight of other portables in its class), Commuter is very easy to handle. And its \$1995 price can save your business a small fortune even before you pick it up.

For more information on Commuter, the portable computer, call us today at **1-800-847-8252** (in Massachusetts, call **1-800-462-5554**), or write Visual Computer Incorporated, 135 Maple St., Marlboro, MA 01752. Or visit your local Commuter dealer and weigh the differences for yourself. But hurry. At only 16 pounds and \$1995, Commuters are definitely going to be picked up fast.

**Commuter. It can take your business places it's never been.**

Visual Computer Incorporated is a wholly owned subsidiary of Visual Technology Incorporated. COMMUTER is a trademark of Visual Computer Incorporated. IBM is a registered trademark of International Business Machines Corp. Lotus and 1-2-3 are trademarks of Lotus Development Corp. VisiCalc is a trademark of VisiCorp. WordPlus-PC is a trademark of Professional Software Inc. Spinnaker is a trademark of Spinnaker Software Corp. MS-DOS, GW Basic and Flight Simulator are trademarks of Microsoft Corp.

**CIRCLE 22 ON READER CARD**



## IN FOCUS

The relevance of the ACH network has become especially clear in light of a pilot program Exxon USA has begun in Phoenix. In that test, Exxon will be issuing its own debit card to customers who sign a form authorizing the oil company to debit their accounts through the ACH system. When they purchase gas with the card, known as Auto-Card, Exxon will initiate an ACH debit through Chase Manhattan Bank. For the customer, the incentive to use the card is the same 5 cents a gallon discount Exxon gives cash customers. For Exxon, the advantage is that it can issue a debit card nationwide to anyone with a checking account, without waiting for the banking industry to come to terms with shared networks and point of sale.

"The question is, how many cards do people want to carry around in their wallets," comments John F. Fisher, senior vice president of Banc One Corp. of Columbus, Ohio, and a leading advocate of Visa Inter-

### About two thirds of a bank's customers refuse to use automated tellers.

national's Electron, a point-of-sale card designed for the on-line authorization and direct debit environment. He adds that the Exxon pilot is a clear warning that banks must get their act together if they don't want to be locked out of the point-of-sale market altogether.

The Exxon debit card test is not the only dark card on the shared ATM network horizon, as far as the banks are concerned. Data security has been considered a low-priority subject thus far, but as more and more payments are made electronically by more and more ATMs connected by ever-increasing miles of cables, banks are now thinking about encrypting transmissions between ATMs and the data centers. Indeed, for many years it was cheaper for a bank to buy antitheft insurance than to buy encryption hardware. "Eighteen months ago, bankers were saying, 'No problem, we can get insurance,'" recalls security expert Stephen W. Leibholz, president of Analytics Inc., Willow Grove, Pa. "Today every bank we visit is interested." The Analytics package now protects the EFT room of the Federal Reserve Bank of New York, as well as several New York City banks.

The confusion in data communications circles due to the divestiture of AT&T's operating companies also threatens the health of newborn ATM networks. ADP's network of teller machines cost the parent company \$5 million last year over and above fees paid by the banks for the service, according to a recent report by analyst Sandra P. Kraus of Kidder, Peabody & Co., N.Y. "The company's ATM business," she says, "is not expected to be profitable until fiscal 1985," because of the cost of data

communications and other problems.

Physical security for ATMs could also become important. "If we start to see murders or rapes at ATMs," Marlborough, Conn.-based market researcher Linda Fenner Zimmer said at a recent ATM conference, it will become increasingly difficult to persuade consumers to use unguarded off-site ATMs. It's already tough—about two thirds of a typical bank's customers refuse to use a machine for their withdrawals and deposits. Zimmer, who has achieved the status of an industry guru, notes, "There really is a 33% barrier."

Perhaps the most notorious example of a bank using coercive measures to bolster ATM usage was Citibank's policy of restricting customers who maintain low balances to ATMs while letting those who keep large sums on account use human tellers as often as they liked. Citibank rescinded its policy under fire from local media and customers, but that doesn't mean that banks aren't looking for other ways to encourage customers to line up for machines rather than tellers. Philadelphia's Girard Bank, widely acknowledged as a leader in the pricing area, charges customers 30 cents for each check for using human tellers and pays 20 cents to those who use terminals to make deposits, a model that is likely to be widely imitated as banks come under increasing pressure to price their services explicitly.

Since the first automated teller began whirring and clicking out cash in 1969, bank EFT managers have tap danced with some creativity around the question of return on investment. The price of an ATM can reach \$40,000, not including service, the cost of replenishing the machines with cash, or the cost of computer systems to support them. Most bankers justified their investment in electronics by talking about customer convenience and competitive edges, rather than by quantifying cost savings that arise from the displacement of paper or the replacement of human tellers.

Today, banks are under pressure from declining lending spreads, increased competition from nonbank financial services companies, and deregulation. As a result, many have begun to insist upon productivity advances in return for their ATM expenditures. Some now require that a human teller be laid off or reassigned each time an automated teller is installed. And in bank branches equipped with ATMs, machines are expected to handle routine functions such as deposits and withdrawals, while human employees are expected to tackle more complicated transactions and sales.

But while some institutions are still struggling to justify their investments, others have decided they can make money on ATMs. First Texas Savings Association has begun installing the first of a projected 1,000 ATMs in 7-Eleven stores throughout

the Lone Star state. The object is not to win new customers for First Texas—a traditional argument for off-site ATM deployment—but to make money for the thrift institution. In this respect, First Texas and its innovative president, Robin Glackin (who learned banking while at New York's Citibank, arguably the industry's leader in technology), are pioneers. Only a handful of others around the country have committed themselves to the proposition of earning a profit on ATMs, and none has proven that it can be done.

What makes the First Texas venture possible, however, is the shared network. "I doubt that 7-Eleven would have been interested if we could deliver only our own customer base or that of one network," acknowledges Glackin. On the other hand, he says, First Texas could never have justified the investment unless all or at least most of the state's bank customers would be able to use the terminals. First Texas had to win a Justice Department antitrust decision for access to both of the state's major shared networks, Mpack and Pulse. Afterwards, it quickly parlayed that approval into a contract with Southland Corp., Dallas, the parent of 7-Eleven.

The convenience food store chain will collect rent for the floor space occupied by the ATM, and in addition a per transaction fee. In return, the bank will collect fees from the other banks connected to the networks.

While nearly everyone agrees that sharing is critical to the success of ventures such as in-store ATMs and retail point of sale, it took a good deal of swallowing before banking industry officials began to di-

### Some banks require that a human teller be laid off each time an ATM is installed.

gest the idea. Sharing was considered foreign—indeed, radical—to many bankers in the early days. They thought the industry was losing its competitive will. Bankers who had invested heavily in their own proprietary networks thought they had bought themselves a competitive advantage in the marketplace and they were loath to invite other banks to share their treasured network.

A variety of forces prompted the move to shared networks. In some cases, banks were looking for ways to circumvent restrictions on branching across state or county lines. Pulse and Mpack gave Texas bankers an opportunity to offer statewide service to their customers in spite of intrastate branch banking restrictions. Small banks sought ATM networks as a way to compete with the larger, big city banks who could afford to place large numbers of tellers on street corners, in shopping centers, office buildings and transportation depots.

# Data Spectrum™

*Bringing Information to light.™*

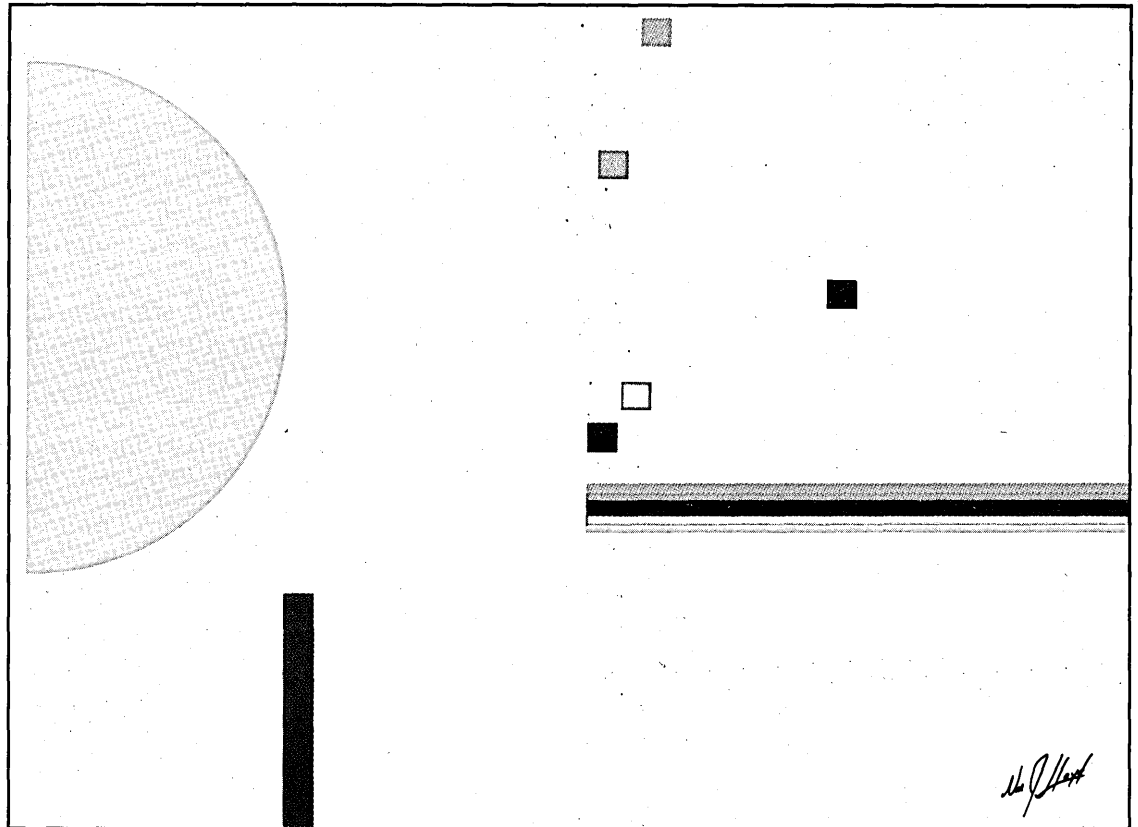

## **Would da Vinci have settled for a Crayon?**

A great artist must command his tools and his medium to fully express his creativity...to solve his design problems. To solve information problems, you need to command an information management system that allows you the flexibility to design solutions tailored to your needs.

Data Spectrum™, is a comprehensive and powerful information management system for business and personal use that goes beyond "user friendly" to downright "people affectionate."

Data Spectrum is the master work of information management. It allows you to customize the organization of information to your specific needs. To search, sort, analyze, edit, evaluate and merge files as you want. And even to generate forms, reports, labels and standard letters.

All menu driven. All built in. With special features like "RAPID TRANSIT": A new file management approach that processes smaller files at blinding speed and automatically switches to "LARGER FILE ORIENTATION" to handle larger files.

Destined to set a new standard in the industry, Data Spectrum's on-screen tutorial blends text,

graphics, humor, sound and animation to lead the user through the concepts, uses and operating techniques of this innovative software package.

On-screen tutorial and powerful program functions make Data Spectrum the universal information management system and problem solver. And a work of art. Our program up-date service and information "Hot-Line" will keep it that way.

So if you are looking for solutions rather than just software, Data Spectrum will bring them to light.

Write or call us for your nearest computer dealer carrying Apple or IBM versions of Data Spectrum. If there is no dealer in your area, you can order Data Spectrum directly from us...with a full money back guarantee. 1-800-232-6902 Illinois Residents 312-298-0997. Advanced Business Computing, Inc. 1580 N. Northwest Highway, Park Ridge, IL 60068-1471.

Apple is a registered trademark of Apple Computer Inc.  
IBM is a registered trademark of International Business Machines Corporation

**CIRCLE 23 ON READER CARD**

## IN FOCUS

Furthermore, it was relatively easy to tie ATMs together into networks. A switch in a computer facility identifies transactions intended for another institution and routes them to the appropriate processing facility (see "Tying the Knot," p. 34).

Sharing gained considerable credibility over the years as banks came to realize that while there are limits to how many terminals they could afford to buy, their customers' desire for convenience was nearly insatiable. Even banks with many ATMs are deciding that sharing offers a way to maximize the return on their investment.

Some holdouts do remain—most notably California's "Big Five" banks—but increasingly the antisharing argument is being relegated to the status of a straw man dragged out only at conferences for public flogging. "It's less and less of an advantage to have a proprietary net," says Linda Fenner Zimmer. "People who were once dead set against sharing have changed," she added. "I know I have."

What does raise the hackles of many bankers now that they share ATMs is access to, and ownership of, their ATMs by non-banks. In the first case, a good many bank-

ers were up in arms when securities broker Paine Webber gained access to MasterCard's MasterTeller network for its Resource Management Account customers. That access came through State Street Bank & Trust Co., Boston, which issued a MasterCard gold card to Paine Webber's RMA customers.

Even more threatening to banks, however, is the prospect of supermarkets purchasing ATMs and point-of-sale terminals, opening them up to bank customers, and charging banks each time one is used. Currently, supermarkets find it competitively necessary to offer check cashing ser-

**Increasingly the antisharing argument is being relegated to the status of a straw man dragged out only for public flogging.**

vices and pay banks as much as 10 cents an item for that privilege. The prospect of seeing the payments system turned on its head so frightened bankers that in Florida and California, the banks quickly formed a statewide shared network after a grocery chain in those states began installing ATMs.

Robert L. Klingler, president of Winter Park, Fla.-based Freedom Savings and Loan Association's Central Florida division and one of the industry's most respected figures, conceded late last year that Florida's statewide shared network, known as Honor, "was born out of fear of Publix," a supermarket chain that had begun installing ATMs in its stores with plans to charge banks each time a customer used one.

Klingler explains: "To keep Publix from picking off banks one at a time, the banks said, 'We'll form Honor and surrender en masse. But we'll go one step further. We'll pay for the switch instead of using the one you built.'"

Following Klingler's analysis, then, the prospects for shared network growth seemed bright indeed. There will always be a Publix looking for ways to offer customers a bit more convenience than its competitor down the road. The banking industry will almost certainly move quickly to protect its payments system franchise each time a new Publix steps forward. And the more competitive the fight between banks and competitors, the easier it will be for consumers to get cash. Anywhere. Anytime. \*

Robert M. Garsson is a reporter for *American Banker*, a New York City-based daily newspaper of the banking and financial services industry. He covers bank operations and technology and has followed the rise of shared ATM networks for several years.

## COM-MAIL SYSTEMS WIN HANDS DOWN

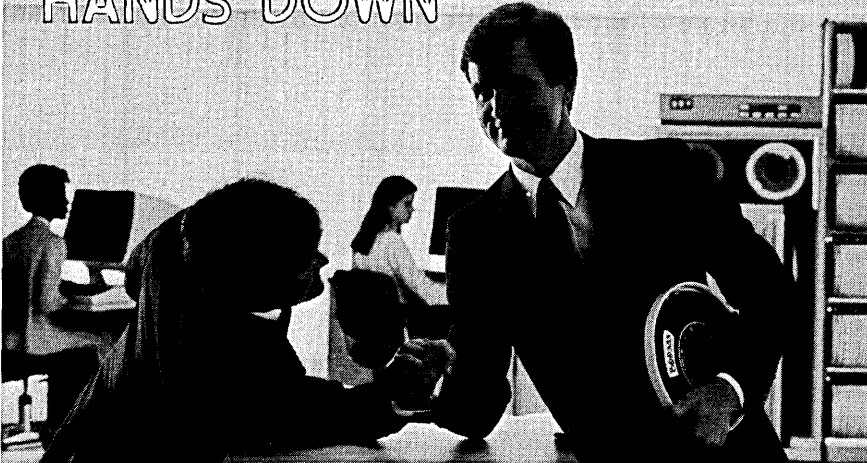

### GET A GRIP ON YOUR MAIL MANAGEMENT PROBLEMS.

Benchmark-winning performance nationwide makes COM-MAIL® products the industry standard for speed, accuracy and reliability.

**SAVE WITH CARRIER ROUTE SORTING SYSTEM (CRSS).** Optimizes postage discounts for greatest bottom line savings. Totally parameter driven. Needs no user coding. No royalty fees. Maintenance optional.

**GETZIP + 4 DISCOUNTS WITHEZ-9.** Add the extra 4 digits to your ZIP codes—without programmer intervention—IN ONE PASS of an address file with a ZIP + 4 master file.

#### MORE HANDS DOWN WINNERS FROM COM-MAIL.

- EZ-5 Zip Code Correction
- List Conversion
- Duplicate Elimination (Merge/Purge)
- Generalized Selection
- Regular Presort
- Label Printing

**HAND OVER YOUR MAILING PROBLEMS** to the advanced mail management software system with proven performance and savings from day one! COM-MAIL's fully integrated

systems, individually or in combination, turn mailing problems into profits.

CALL TOLL FREE  
**(800) 368-5806**  
LOCAL (202) 537-7281

**COMNET®**  
COMPUTER NETWORK CORPORATION  
CON-MAIL® Division, Dept. DA104  
5185 MacArthur Boulevard, N.W.  
Washington, D.C. 20016-3387

I WANT TO SAVE MONEY IMMEDIATELY. CALL ME TO SET UP A FREE BENCHMARK.  
 Send more information.

NAME \_\_\_\_\_  
TITLE \_\_\_\_\_  
COMPANY \_\_\_\_\_  
ADDRESS \_\_\_\_\_  
CITY \_\_\_\_\_  
STATE \_\_\_\_\_ ZIP \_\_\_\_\_  
PHONE \_\_\_\_\_

Products require  
IBM/COMPATIBLE or  
UNIVAC 80/90 MAINFRAME

CIRCLE 24 ON READER CARD



STABILITY

MULTI-TASKING

MAINTENANCE

MULTI-USER

ELEGANCE

PORTABILITY

PROVEN

COMPATIBILITY

HARDWARE INDEPENDENCE  
COMPATIBILITY  
SOUND INVESTMENT

LANGUAGES  
MATURE  
APPLICATIONS  
SECURITY

STANDARD

EVOLUTIONARY

PRODUCTIVITY

FLEXIBILITY

LANGUAGES  
COMPATIBILITY  
TRAINING

COMPATIBILITY  
PORTABILITY  
ELEGANCE

MATURE  
PROVEN  
RELIABLE

DOCUMENTATION  
EASY TO USE  
DEVELOPMENT

MULTI-TASKING  
SOUND INVESTMENT  
FLEXIBILITY  
EVOLUTIONARY

MULTI-USER  
STANDARD  
HARDWARE INDEPENDENCE

PRODUCTIVITY  
SERVICE

COMPATIBILITY  
RELIABLE

EDUCATION  
BUSINESS

EXPANDABILITY  
MAINTENANCE  
DOCUMENTATION  
EVOLUTIONARY

DOCUMENTATION

PRODUCTIVITY  
SERVICE  
TRAINING

DOCUMENTATION  
MAINTENANCE  
SUPPORT  
SERVICE

MULTI-TASKING  
SOUND INVESTMENT  
EVOLUTIONARY

EASY TO LEARN  
EASY TO USE  
PRODUCTIVITY  
FLEXIBILITY  
FAMILIARITY

BUSINESS  
EDUCATION  
INTERNATIONAL

MATURE  
APPLICATIONS  
FAMILIARITY  
EASY TO LEARN  
INTERNATIONAL  
PROVEN

ELEGANCE  
PORTABILITY  
RELIABLE  
COMPATIBILITY  
POWERFUL

SUPPORT

MULTI-TASKING  
SOUND INVESTMENT

MATURE

PRODUCTIVITY







# NEWS

## IN PERSPECTIVE

### SELLING ABROAD

## EXPORT LAWS ON THE LINE

**The industry isn't too happy about proposed changes to the U.S. high-technology export laws.**

**by Willie Schatz and Paul Tate**

The U.S. computer industry and European customers are outraged over recently proposed changes to this country's export laws that would tighten government control over the shipment of high-technology products overseas.

The protests, informal at press time but expected to be voiced through proper channels in coming weeks, arose from proposals by the Department of Commerce that foreign resellers of U.S. high-technology goods get licenses for each transaction. The proposal came following public criticism of the department by the Department of Defense. The latter has been seeking for the past year to stem what it says is a large volume of "militarily useful" gear being diverted to Soviet bloc countries.

The two federal agencies are vigorously vying for control of high-technology exports and have been bickering between themselves about which should have the last say in awarding export licenses. DOC has been proudly wearing the industry's colors against DOD's national security banner. Washington observers said in early February that DOC had a narrow lead over DOD, but DOD has been coming on very strong in the final quarter of the contest. And what DOD wants, DOD usually gets.

"Never mind my role as a lobbyist," said an attorney in the capital, who is experienced in international affairs and has been retained by a computer trade organization. "As an American citizen it makes me very nervous to think about DOD controlling all exports everywhere in the world. They would put all kinds of pressure on their contractors to toe the line. And they'd be totally unresponsive to business."

In Europe, the criticism was even harsher. "I think they've got a bloody nerve," said Parry Mitchell, chairman of United Leasing, which deals in computers in West Germany and the United Kingdom. "We have our own equivalents of the Commerce and Defense Departments here in Europe and there is no need for this U.S. involvement. What price the NATO alliance?"

For such organizations as United

Leasing and even computer users themselves, the proposed changes to the U.S. Export Administration Act would make life a good deal more difficult. For instance, an IBM user in northern Paris who wanted to upgrade his system and sell the old one to a user across town would be required to get a reexport license from the U.S. Commerce Department. At least that's what the law in Washington would require. Whether or not such users would take heed was seriously questioned by industry representatives in the U.K. and on the Continent.

The proposed regulations would require that the final destination of U.S.-originated goods on a list of restricted items would have to be reported every three months by active resellers.

Times grew tough for exporters on Jan. 19, when DOC's Office of Export Administration (OEA) released proposed changes to its distribution license (DL) program (see box). The proposed tightening of the rules would exclude certain items such as semiconductor devices and lasers from the DL, restrict use of the DL to firms with proven export compliance records, require lists of expected end users and more specific descriptions of exports, and tighten controls on reexporting overseas.

"They're trying to tighten up on what they think are the excesses of the past several years," says Tom Christiansen, manager of international trade relations for Hewlett-Packard. "We knew for the past year that DOC was working on the DL. But no one expected this. It would have been nice to see that there had been a demonstrated need for these proposals. But I haven't seen any evidence of that at all. That makes it pretty annoying."

"It's also going to make it a hell of a lot harder to do business. There's definitely going to be more paperwork, and all our export operations will cost more. It's going to be difficult enough for large firms like us, but it's going to be really hard for smaller firms. Large firms ought to know by now how to stand at attention, click their heels three times, and face the east. But for smaller firms it's like the straw that broke the camel's back."

Almost. Business may be in the intensive care ward, but its condition may be

**"I think they've a bloody nerve," says a European computer leasing executive.**

only grave, not critical. It might even linger on that list for a while, or recover more quickly than expected, but its future is not totally within its control. On the chessboard of exports, it is fact becoming little more than a pawn.

Industry's best hope lies in persuading DOC that its writing style is horrible. Nowhere is it written that the DL changes

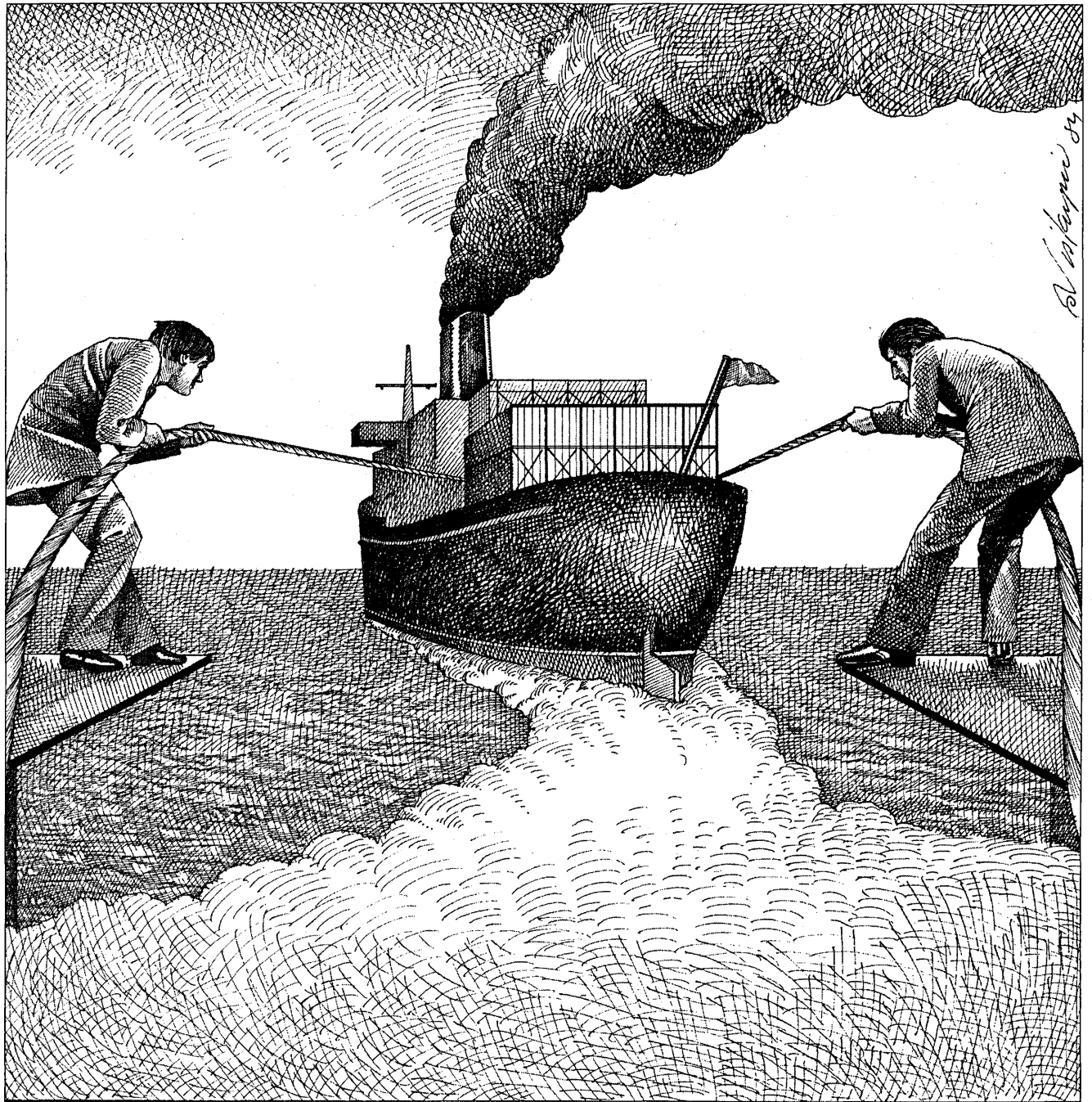

ILLUSTRATION BY GARY VISKUPIC

will take effect as written. The original proposal required comments in 30 days. Numerous industry groups requested another 60 days to get their act together. DOC was mulling that over. Under ordinary circumstances, 90 days is an average time in which to solicit comments. Rather than seek industry input, another normal procedure when an agency contemplates such significant changes in its regulations, DOC first met with business representatives two weeks before releasing the DL proposals. By then the proposals were a fait accompli. In essence, DOC said, "Here it is. If you don't like it, write to us."

"These proposals and DOC's attitude have caused a lot of distress," says an

executive at one of the top 10 computer manufacturers, which has a significant overseas business. "The DL is the lubricant that makes export control function. Without

**Industry's best hope lies in persuading DOC that its writing style is horrible.**

the DL, the government would be inundated with export requests."

It's no picnic now for DOC. The agency estimates there are currently 700 DL holders, including most of the largest U.S. exporters. The American Electronics Association (AEA) estimates that U.S. exports of electronics products alone exceed \$26 bil-

lion a year. More than half that dollar volume is products subject to DOC licensing. Without the multiple licenses, DOC says it would have to issue about a million individual validated export licenses a year, compared to the current total of 90,000.

"From an exporter's point of view, that kind of delay would be intolerable," the computer executive says.

That's not to say exporting is such a snap now. Why, then, would DOC, heretofore business's best friend in Washington, want to alienate its constituents? Is there a method to the agency's apparent madness?

Well, yes. Retreating before DOD's potent offensive, DOC is trying to regroup and preserve its turf.



## NEWS IN PERSPECTIVE

"I think these proposals were released because of the pressure DOD's [been] applying following the news about this so-called technology leakage," said Hugh Donahue, vice president of government programs and international trade relations for Control Data. "There's a constant turf battle about whether DOD can look at DLS. Right now it can't except in certain circumstances where DOC thinks DOD should look."

DOD wants to be as ubiquitous in export licensing as it is in military contracting. Under the Senate's version of the Export Administration Act Amendments (see "The Hitch in High-Tech Trade," October, p. 148), the agency may get its way. If the Senate version of the bill passes, Section 10(g) of the EAA of 1979 would become a veritable blank check for DOD to see anything it damn well pleases.

DOD's vision is much more restricted under the House's half of the EAA amendments, which that body passed last Oct. 27. This legislation is far friendlier to business, which makes it all the more irritating that industry was first in time, but may not be first in right. The Senate was expected to pass its bill last month. Both bodies were then scheduled to go to conference to see if they could iron out their considerable differences. They weren't going to be able to char for very long, because the EAA, which had already been extended twice, once by presidential emergency, past

### **Damned with very, very faint praise was the Commerce Department, which drew criticism from other government officials.**

its scheduled Sept. 30, 1983 expiration, was slated to perish anew on Feb. 29.

In the interim, DOD was aggressively protecting its turf and vigorously trying to encroach on DOC's. Following the seizure last fall in West Germany of a VAX 11/782 reportedly bound for the Soviet Union, Defense Secretary Caspar Weinberger and Treasury Secretary Donald Regan held a press conference in which they said the U.S. had prevented "an espionage coup" by the Soviets and made the world safer for democracy.

Praised to the skies for their brilliance were the Treasury Department, the Customs Service via Operation Exodus, and the Defense Department. Damned with very, very faint praise was the Commerce Department, which Regan suggested should "do what it should have been doing in view of these things. If there is a slippage in that system, it is something that we will be reviewing with Commerce."

In other words, the fault, dear exporters, lies not in DOD and Customs, for they are wonderful. It resides in DOC, which

## DOC'S PROPOSALS

You wouldn't think four pages in the Federal Register could create such a fuss. And you probably ain't seen nothing yet.

DOC justifies its proposed tightening of the distribution licensing (DL) of exports as part of a continuing review of export administration policy, particularly those that control shipments of high-technology goods.

The proposed changes would drastically alter the current DL procedures, a prospect that has industry people screaming in the night. Acting Assistant Secretary of Commerce William Archey describes the new rules as "clear tightening," which, if made final, would restore the rules to what they had been until the early 1970s.

These seven major proposed changes are what industry is concerned about:

- A number of commodities considered to be high diversion risks will be excluded from the DL procedure. Currently, exports of these products are denied only administratively to certain license holders for certain destinations. These products would be eliminated from DLS except for NATO countries (excluding Spain), Australia, Japan, and New Zealand.

- For DL consideration, an exporter must have obtained no fewer than 50 individual validated export licenses in the year prior to applying for the license. Currently, firms must have a reasonable expectation that the DL will replace individual validated licenses.

- Foreign recipients of exports from the U.S. distribution license holder located outside NATO countries (excluding Spain), Japan, Australia, or New Zealand must list the names and addresses of customers to whom they expect to sell products they receive pursuant to the DL. Quarterly updates of new customers must be supplied to DOC.

- No commodity received by a foreign consignee under a DL may be resold or reexported to a customer located outside a NATO

could prevent such leakages if it were only doing its job.

"It was absolutely unconscionable for those two to call a press conference," says Rep. Don Bonker (D-Wash.), chairman of the House Subcommittee on International Economic Policy and Trade. Bonker has batted cleanup in industry's lineup all season, and it is his bill that was passed by the House.

"There was no reason for them to create all this publicity unless they wanted to hurt our chances of passing our bill," Bonker says. "This is clearly the work of [Assistant Secretary for International Security Policy Richard] Perle and company. They never sit idly by. They're always looking for a chance to get their point across.

country (see exceptions noted above) until the consignee has obtained a certification from its customer that the commodities obtained under the DL will not be reexported without DOC approval. Since this policy is new, there's nothing with which to compare it.

- The application for a DL must include more specific information on commodities proposed for export under the DL. Now only broad descriptions are required.

- Foreign consignees will be prohibited from taking undue advantage of the reexport provisions of the Export Administration Regulations, which permit certain reexports without written authorization of DOC. Now unknown foreign end users or customers can receive multiple shipments which, in DOC's infinite wisdom, could create national security concerns.

- The drop shipment procedure is being modified to restrict the ability of certain overseas firms and individuals from receiving products under a DL. This would mean that a U.S. exporter could no longer ship directly to a customer. The product would have to go through a middle company in another country.

"The timing of these relates to the fight between DOC and DOD," says a Washington attorney experienced in these matters. "The tougher and harder DOC looks, the less claim DOD has that DOC is soft on business."

Archey wasn't closing the door completely, so maybe looks are deceiving.

"If industry can suggest refinements to our proposals that give us the degree of control we deem essential while avoiding some unintended disruption of normal trade practices," he offered, "we will consider them before the rules become final."

Industry was a cinch to take Archey up on his offer. But industry wasn't holding its breath.

—W.S.

"Did DOC drop the ball? When my subcommittee finishes its investigation, we'll show that DOC was vigorously doing its job. Weinberger and Regan raised more questions than they answered. And aren't we talking security matters here? If the seizure were that big a deal, the last thing you'd want to do is go public with it. When all the facts are in, we'll see that they made a lot more out of it than was really there."

Well, this was only a VAX 11/782. Weinberger was selling it as state-of-the-art hardware and software that would have accelerated Soviet military modernization programs. No way business didn't buy that line.

"This isn't that big a deal," Control Data's Donahue contends. "DOD seized on it to push its case. But it was shipped under

# RAMIS II MAKES YOUR INFORMATION CENTER A GREAT PLACE FOR PEOPLE.



RAMIS II's complete solution is the most effective way to multiply the productivity and satisfaction of your end users and your Information Center staff. Today, RAMIS II means success at hundreds of Information Centers around the world.

## POWER AND SIMPLICITY FOR END USERS

RAMIS II provides everything users need for maximum productivity. Its powerful report writer, relational database and language, full-color business graphics, SAS® interface, and many other capabilities meet the most advanced decision support needs. And, with our new RAMLink, IT series, and RAMIS II/PC software, end users have the ideal solution for mainframes and personal computers.

RAMIS II English comprehension extends the power of your Information Center to a multitude of new computer users. Through ad-

SAS® is a registered trademark of SAS Institute, Inc.

vanced knowledge-based technology, even people who've never been on speaking terms with a computer can ask questions, obtain answers, and create reports in only a few minutes using everyday English.

## EFFICIENCY AND RELIABILITY FOR SUPPORT STAFF

Our complete solution lets your existing staff support many more users by dramatically reducing the number of products you need. And RAMIS II makes your support job easier with built-in computer-based training plus facilities to monitor and control usage.

RAMIS II delivers the performance and reliability needed to tackle even the largest decision support tasks with confidence. In fact, because RAMIS II is also a complete application development system, single-user systems can evolve smoothly into full-fledged applications.

## LISTEN TO OUR USERS

Send for our free guide, "Why Information Centers Succeed." It contains practical suggestions for success from RAMIS II Information Center staffs of organizations like yours. Organizations that have found that RAMIS II, the real leader in complete software for business, is the sure way to make an Information Center a great place for everyone.

To get your copy, contact your local Mathematica office, call toll-free (800) 257-5171, or return the coupon below.

## MATHEMATICA PRODUCTS GROUP

A MARTIN MARIETTA DATA SYSTEMS COMPANY  
P.O. Box 2392  
Princeton, NJ  
08540



Please send me a free copy of "Why Information Centers Succeed."

Name \_\_\_\_\_

Title \_\_\_\_\_

Company \_\_\_\_\_

Address \_\_\_\_\_

Telephone \_\_\_\_\_

Computer \_\_\_\_\_ Operating System \_\_\_\_\_

DA3

## RAMIS® II... THE LEADER BY DESIGN

Boston (617) 357-9424 Chicago (312) 870-9710 Dallas (214) 788-1916 Houston (713) 850-8697 Los Angeles (213) 670-6962  
New York (212) 980-9077 Princeton (609) 799-2600 San Francisco (415) 461-6315 Washington, DC (202) 484-5752 Basel (061) 429923  
Bergen (5) 321300 Buenos Aires (541) 410081 Calgary (403) 290-0668 Heidelberg (06221) 14051 Hong Kong 5-435714  
Johannesburg 27 11 789-1808 Kingston (809) 929-7223 London (01) 580 3681 Milao (2) 546-8080 Montevideo (2) 906788  
Ottawa (613) 236-8616 Paris (1) 776 41 71 Santiago (2) 31014 Singapore 273 9255 Stockholm (8) 520720 Sydney (02) 923 1677  
Tel Aviv (052) 70364 Toronto (416) 671-2272

CIRCLE 25 ON READER CARD

## NEWS IN PERSPECTIVE

a DL. Even if DOD were looking at DLs, this would have made it through. Then DOC put out these proposed regulations to show it can play tough, too."

"This seizure means very little technologically," says the trade association's attorney, who is a former DOC official. "This is clearly DOD's doing. It's funny how over the last year, seizures or arrests involving high-tech exports have happened at crucial legislative points. If DOC had not been under intense pressure and attack by DOD, it would have proceeded much more slowly and analytically with the DL proposals. DOC feels under siege and is trying to hold off DOD's jurisdictional assault.

"And DOD should talk about inefficiency? You're talking \$1,000 wrenches with them. They probably spend more money transporting senior officers from Alaska each year than DOC spends on its EAA enforcement. The real pressure is being felt by the major companies that have military contracts. They've been told by DOD and their company executives to ease off on the criticism of DOD's export control policies."

So the beat goes on. No one was giving odds on the chances of a new EAA passing by Feb. 29. Meanwhile, more groups were dressing for battle. Seven trade associations formed the Industry Coalition on Technology Transfer, for which HP's Christiansen chairs the DL group. An 18-member Business Group on the Export Administration Act, including the Computer and Business Equipment Manufacturers Association (CBEMA) and the Computer and Communications Industry Association (CCIA), wrote to seven key officials of the Reagan Administration to plead their case.

"What bothers me most in this whole thing is that Commerce never even talked to the Computer Systems Technical Advisory Committee, which we specifically set up for high-tech exports," Control Data's Donahue complains. "They totally ignored us. Now, if these regulations stand as written, we won't be able to do business with China because we won't be able to get a DL for a few years. And our drop shipments will be much more expensive.

"Am I angry at DOC? No. But I'm pretty damn disappointed that the private sector gets caught in the middle of this turf battle, because we're the ones who are going to suffer," the CDC official says.

European suppliers and governments are not amused, either. "We have made many protests in Washington to get the extraterritoriality provisions dropped," explains a spokesman for the European commission in Brussels. "We find the whole thing totally unacceptable," declares another EEC source. "It is a blatant imposition on our internal markets."

The U.K.'s trade and industry minister, Norman Nesbit, went even further. "It is contrary to the principles of interna-

tional law," he complained after IBM U.K. had sent a letter to 30 of its top U.K. customers reminding them of their obligation to the Commerce Department.

European suppliers have also found the regulations hard to swallow. The U.K.'s ICL, which, like most companies, has transatlantic oem deals, says it has "experienced considerable delays in obtaining U.S. authority to export," and adds that there have been cases when it has "obtained U.K. licenses, and then been refused a license by the U.S."

Over the past two years the value of exported U.S. technology goods has more than doubled to over \$60 billion. That international trade is becoming almost impossible to control: too many U.S. systems are passing too many of the world's airports to monitor where they are all ending up.

U.S. customs officials can stop direct shipments to the Soviet bloc, but indirect trade, via a third party outside the U.S., is another ball game. The major Western countries are all members of the coordinating committee for export control (COCOM), which lists restricted equipment, but there are still gaps in the armor of the Western

### **"And DOD should talk about inefficiency? You're talking \$1,000 wrenches with them," says one former DOC official.**

alliance, and some countries are more vigilant than others. The U.S. can easily lose track of a piece of hardware. A machine may leave Chicago destined for Switzerland, but eventually find its way through illicit channels to Moscow. One observer estimates that around 30 Digital Equipment VAX machines have found their way into the Soviet bloc over the last 18 months and that micros are going over the borders "in huge volumes."

Plenty of real evidence exists that the trade is widespread and stopping it isn't easy, although a bid by U.S. and European customs, called Project Exodus, has had some limited effect. In the U.K. two directors of computer company Datalec, Bryan Williamson and Chris Carrincan, have been charged with evading export controls and shipping equipment worth \$2.25 million, mostly DEC systems, to Soviet bloc countries ("The British Connection," August, p. 148).

Other shipments of barred equipment have been seized in the U.S., Sweden, and West Germany, and the tightening up campaigns by customs officials have even led to the removal of Sinclair home computers from the duty-free shop at London's Heathrow Airport.

These successes are touted by DOD as only the tip of the iceberg in illicit high-tech trade, and it is with a view to tighter control of the movement of U.S. systems

that the Commerce Department is considering beefing up the EAA regulations.

One major problem is what constitutes potentially militarily useful high-tech gear? Can the Soviets run a submarine fleet with an IBM PC? Could they upgrade Pac Man to launch a nuclear attack? These questions may appear facile, but the concern in Washington, and particularly in the Pentagon, that seemingly benign computer products may be used for malevolent purposes is serious.

There is a list of restricted high-tech products that require special licenses to be shipped to Soviet bloc countries, compiled by COCOM in a back office of the U.S. Embassy in Paris. All NATO countries, Japan, and Australia are COCOM members, but the list covering computers was put together in 1976, which in this industry makes it about as useful as an eleventh-century road map is to a twentieth-century truck driver. "Some of the products on there you couldn't give away on either side of the Curtain," comments one observer.

The list is scheduled for review in May 1984, and already the Pentagon is pushing to have a whole range of new products, including the IBM PC and other 16-bit micros, added to it.

The list will also include software, which is now covered under the EAA as technical data. There have already been cases where European companies have been frustrated in their attempts to get hold of U.S. software by the Commerce Department. Late last year, Unix supplies were cut off to some 150 international companies for reasons of national security while changes were made to the operating system because it contained the U.S. data encryption standard (DES).

Doug Eyeions, a council member of the European Computer Services Association, is particularly concerned by the possible extension of controls over software exports. "Up to now it has not been too much of a problem, but the situation has escalated over the last six months and the consequences for Europe of tight controls are serious. Most of the operating systems come from the U.S., and restrictions on the flow of these could paralyze many European software developments."

The European users, meanwhile, are perhaps the least concerned of all at the moment. The spokesman for the IBM Computer Users Association in the U.K., George Goodwin, admits "total indifference" to the moves to tighten export controls. "Most of the regulations have been around for years and they have had little effect on us," he says. "After all what are they going to do if I don't comply to the rules—refuse to sell me a system? And as for the latest proposals, I don't think they will affect us much either. Stupid law is often disobeyed." \*

**WHEN IT COMES TO SOLVING  
BUSINESS PROBLEMS, ONE COMPANY  
IS A MILLENNIUM AHEAD.**

**MILLENNIUM**

Several years ago, a team of McCormack & Dodge researchers uncovered a remarkable paradox in business software:

Business problems don't fit into compartments. Yet even the most sophisticated software packages operate on the principle of compartmentalization. In the very same vendor product line, you find general ledger packages designed one way, accounts payable another, fixed assets yet another. In actual use, these separate designs become separate walls. Barriers to problem-solving.

Because McCormack & Dodge researchers identified this paradox first, we are years ahead of the industry in overcoming it. Our Millennium series is designed and built, from the ground up, as a genuinely borderless product line. A true family of systems in which the whole works as smoothly as any part, making the most efficient use of all your data processing resources.

With Millennium, and only with Millennium, a business person asking a question in one system can instantly enter a correction in another, seek an answer in a third, update a fourth—and move with total freedom through the entire vast information universe.

When it comes to solving business problems, McCormack & Dodge is a Millennium ahead. Shouldn't you be too?

**WHEN YOU THINK ABOUT TOMORROW,  
MILLENNIUM MAKES SENSE TODAY.**

**McCormack & Dodge**

**DB** a company of  
The Dun & Bradstreet Corporation

McCormack & Dodge Corporation, 1225 Worcester Road, Natick, MA 01760  
Sales and support offices throughout North and South America, Europe, Asia, Australia and Africa. 800-343-0325. Telex: 710-325-0329

CIRCLE 26 ON READER CARD

# NEW FROM CINCOM: THE MANAGE USER SERIES™

## MAINFRAME PERSONAL COMPUTING POWER WITH DP CONTROL.

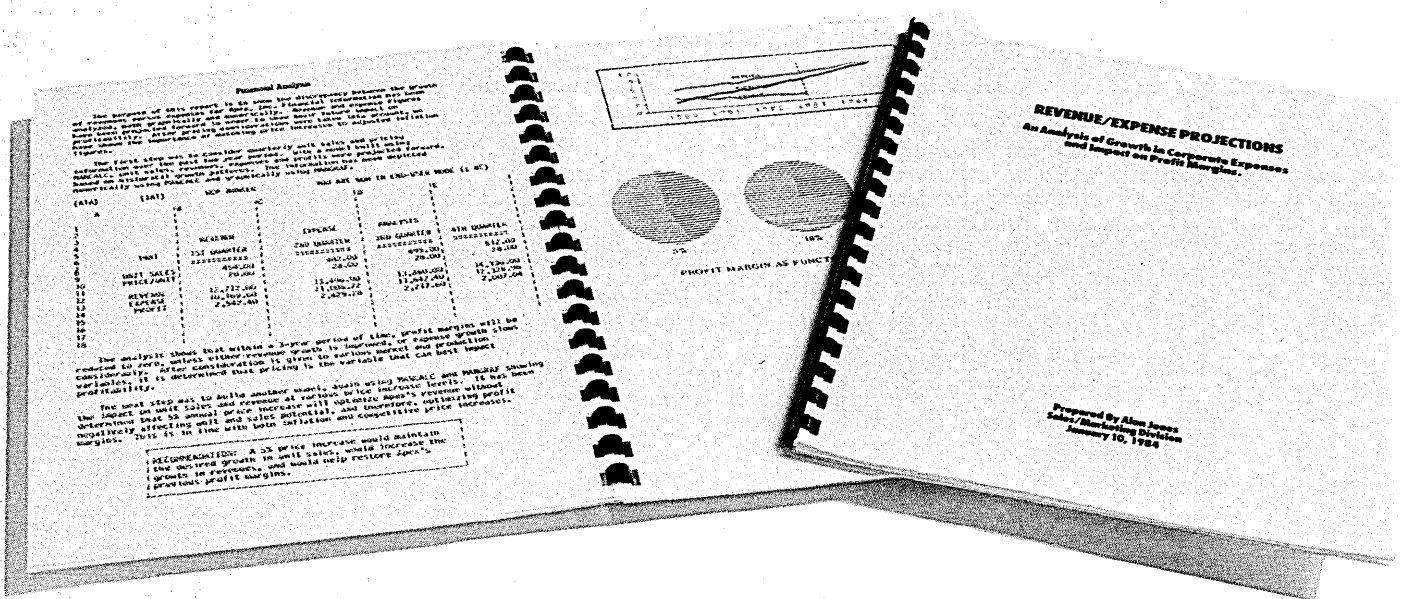



# MANAGE USER SERIES

Cincom's new MANAGE USER SERIES™ combines the benefits of personal computing capability, mainframe power and greater data processing control into one comprehensive Decision Support System.

corporate files, or build models based on private data as well.

- MANTIS is Cincom's industry acclaimed application development language. As the "integrator" of the MANAGE USER SERIES, MANTIS provides an effective bridge between the Development Center and the Information Center.

## Personal Computing On The Mainframe

Simply explained, the MANAGE USER SERIES is Cincom's family of integrated mainframe software tools that work together as one powerful Decision Support System. No other software vendor offers such a wide range of Decision Support capabilities at the mainframe level.

Using the power and accessibility of the mainframe, MANAGE enables data processing to provide a wide range of personal computing capabilities while maintaining control over the corporate data resource. And because MANAGE has a conversational, user-friendly personality, it easily wins friends among end-users.

## Powerful Decision Support Tools

currently integrates four powerful tools that allow end-users to access, store and use production information from the corporate mainframe to aid in key business decision making:

- MANTEXT is a sophisticated free-form text processing system that enables users to access corporate files for the creation of business documents and corporate mailings.
- MANGRAF is an advanced business graphics tool that provides output from on-line applications using centralized production data base information.
- MANCALC is a 3-Dimensional electronic spreadsheet that facilitates "corporate-size" models and can automatically load information stored in

```

MANTEXT
SECTION DAN LIB DAN 0004 JENNY
1 2 3 4 5 6
considerably. After consideration is given to various market and
production variables, it is determined that pricing is the
variable that can best impact profitability.
The next step was to build another model, again using MANGRAF and
MANGRAE, analyzing the impact of unit sales and revenue at various
price increase levels. It has been determined that a 5% annual
price increase will optimize Apex's revenue without negatively
affecting unit and sales potential, and therefore, optimizing
profit margins. This is in line with both inflation and
competitive price increases.
304 1.52
STR 10.00
RECOMMENDATION: A 5% price increase would maintain the desired
growth in unit sales, would increase the growth in revenues, and
would help restore Apex's previous profit margins.
304 200
    
```

MANTEXT—Text Processing

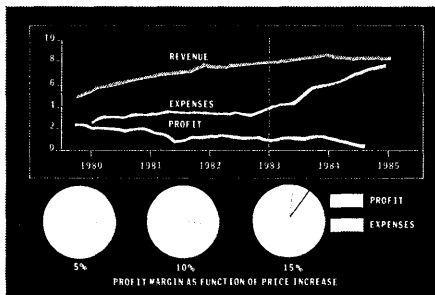

MANGRAF—Business Graphics

(A1A)	(A1B)	POP BUNKER	YOU ARE NOW IN END-USER MODE (UEI)			
1	A	B	C	D	E	F
2						
3						
4		REVENUE	EXPENSE	PROFIT		
5						
6	TIME	1ST QUARTER	2ND QUARTER	3RD QUARTER	4TH QUARTER	
7						
8						
9	UNIT SALES	151.00	142.00	133.00	124.00	
10	PRICE UNIT	24.00	24.00	24.00	24.00	
11						
12	REVENUE	3624.00	3408.00	3192.00	2976.00	
13	EXPENSE	10,164.00	11,056.00	11,948.00	12,840.00	
14	PROFIT	2,512.00	2,352.00	2,192.00	2,032.00	
15						
16						
17						
18						

MANCALC—Spreadsheet

## End-User Productivity Through Integration

The key to the power and versatility of MANAGE is its elegant integration. MANAGE provides the tools needed for preparation of business reports and day-to-day decision making. And because all components of MANAGE can access central or personal data files, users can merge a multitude of data types, display them graphically, simulate "what-if" futures and document the findings in one business report. The power of MANAGE is limited only by one's own creativity.

## Another Major Cincom Technology

Like TIS™, ULTRA Interactive Data Base System™, MRPS™ and MANTIS™, MANAGE USER SERIES is a member of the integrated family of new Cincom software technologies. From data base to application software to Decision Support, the name Cincom has come to stand for excellence in software technology the world over.

For more information on MANAGE, or any of our new integrated software technologies, simply contact the Cincom Marketing Services Department, 2300 Montana Avenue, Cincinnati, Ohio 45211.

**800-543-3010**

(In Ohio: 513-661-6000)  
(In Canada: 416-279-4220)

 **Cincom Systems**

Excellence in Software Technology.

## NEWS IN PERSPECTIVE

### THE WORKPLACE

# IS BIG BLUE BIG BROTHER?

**Some Italian trade unions apparently think so and have taken the manufacturer to court.**

by Marco Merlini

IBM faces legal charges in Italy that its mainframe data security products are actually tools with which the company closely monitors its workers' performance on the job. The computer maker is accused by a trade union of using the SLR (service level reporter) and RACF (remote access control facility) software packages to track in excessive detail the productivity of IBM workers who use video display terminals all day. The situation is potentially explosive for it bears directly on the use of the two software products throughout Italian industry and the rest of Europe.

Renato Rivero, chairman and managing director of IBM Italy, and four company directors must answer to an Italian judge on charges of having "consented to the use of equipment suitable for carrying out remote control of employees' activity." The case is being watched closely by many Italian unions as a test of the country's strict Statute of Labor, a law that governs management's monitoring of workers.

The statute is composed of two parts, the first of which sets a ban on "the use of audiovisual equipment and other machinery that aims at the remote control of the workers' activity." The second part governs cases where remote monitoring is not the primary objective of a particular machine or tool, but is a by-product, resulting from "organizational and productive requirements or from guaranteeing the security of the work." In such cases, authorization for the monitoring equipment depends on an agreement hammered out with trade union representatives. The Statute of Labor does not deprive the company of the power to control the activity of its employees but requires that such control be regulated.

SLR and RACF are programs IBM sells to mainframe customers, SLR for optimizing a computer system's use of limited resources—memory, cpu time, disk I/O, etc.—and RACF for controlling access

through terminals to programs and data files resident in the system. To use SLR, one must monitor the system's workload in fairly minute detail, while RACF keeps track of authorized and unauthorized attempts to gain access to the system. In particular, RACF controls access by way of passwords that are assigned to each operator on the machine and entered through a keyboard or through magnetic identification cards.

Italian trade unions are concerned that the two IBM programs make it easy for IBM management—and, potentially, IBM customers—to keep track of the date, time, and frequency with which terminal operators handle transactions on the machine. Behind IBM's label of "confidentiality and security," the unions say they see a hierarchical control of access to sensitive information. Behind the label of "performance evaluation," they see an insidious monitoring of the quantity and quality of individual workers' performance.

In 1982, the trade union at IBM's Vimercate plant raised a legal protest against the introduction of RACF into a system in use there. At the time, Judge Michele di Lecce had numerous boxes of SLR records seized. IBM told the court it wanted nothing more than to improve security of its systems, to prevent access to confidential information.

After some discussion, IBM and the trade union representatives reached an agreement: the control of access to all pro-

### **The Italian Statute of Labor strictly governs management's ability to monitor worker performance.**

grams, transactions, and data was to be carried out through group codes that would prevent the individual operators from being identified. Data showing work performance would be collected in such a way that only a group of at least four operators could be identified.

Individual operators, however, could be held responsible for particularly confidential or vital information—personnel or company property information, for instance. Further requirements were to be subject to joint examination by company and union representatives.

This arrangement seemed to solve the problem for both sides, except that a question arose about how to define "confidential and vital." To put it bluntly, how could the two sides make their agreement work when they were united only by their supreme incomprehension of each other?

IBM claims it held a series of meetings in which it "provided the trade union side with all the relevant information on the classification of data, on its confidentiality and vital nature, based on an extremely detailed analytical examination." It was de-

# Get everything done by Friday!™

Invoices. Paychecks. Mailing lists and form letters. Inventory. Reports. And just about any file handling that needs to be done around the office.

Get them all done quickly, efficiently and accurately any day of the week—by Friday!™

Friday! is the revolutionary new electronic file handling system for your microcomputer from Ashton-Tate, the people who invented dBASE II®. It's just \$295 (suggested retail price).

For the name of your nearest Friday! dealer, drop us a line. Ashton-Tate, 10150 West Jefferson Boulevard, Culver City, CA 90230. (213) 204-5570.

## ASHTON-TATE

dBASE II is a registered trademark and Friday! is a trademark of Ashton-Tate. ©Ashton-Tate 1983

CIRCLE 28 ON READER CARD



## STATE OF THE ART.

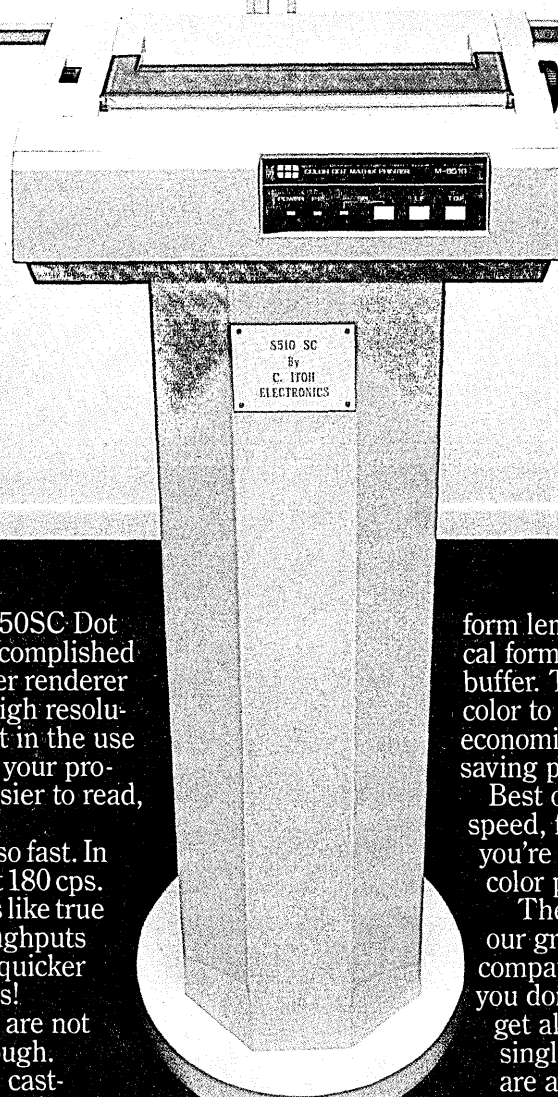

**C** Itoh's new 8510SC/1550SC Dot Matrix Printer is an accomplished graphic artist. A master renderer of tables, charts and other high resolution graphics. And an expert in the use of color. All of which boosts your productivity by making data easier to read, organize and interpret.

The 8510SC/1550SC is also fast. In single-color mode, it prints at 180 cps. And thanks to advancements like true logic seeking printing, throughputs are a fast 100 LPM — that's quicker than many 200 cps machines!

Of course, C. Itoh printers are not only fast and colorful, but tough. They come with heavy duty castings, a rugged stepper motor and a synthetic ruby print head that has a 100-million-plus character life — all standard.

Also standard are down-loading for special character sets. Variable

form length, 6-channel electronic vertical formatting. An expandable print buffer. The capability to switch from color to a black ribbon, quickly and economically. Plus a long list of time-saving paper handling features.

Best of all, you can get all this high speed, full-color performance for what you're probably paying for a single-color printer!

The 8510SC/1550SC is part of our growing family of software-compatible low-profile printers. So if you don't need multi-color, you can still get all these features in a choice of single-color printers. All of which are available in two carriage widths, plus serial or parallel interfaces.

C. Itoh's expanded 8510/1550 family. The state of the art in printers. For full details, contact C. Itoh Electronics, Inc., 5301 Beethoven St., Los Angeles, CA 90066. (213) 306-6700.

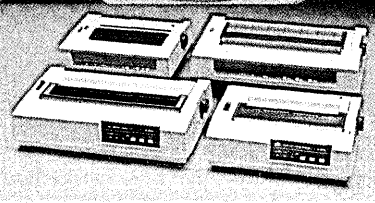

Shown are 8510B/1550B, 8510SC and 1550S.

### C. ITOH ELECTRONICS

A World of Quality

CIRCLE 29 ON READER CARD

OEMs/Distributors:

# Meet the supermax family

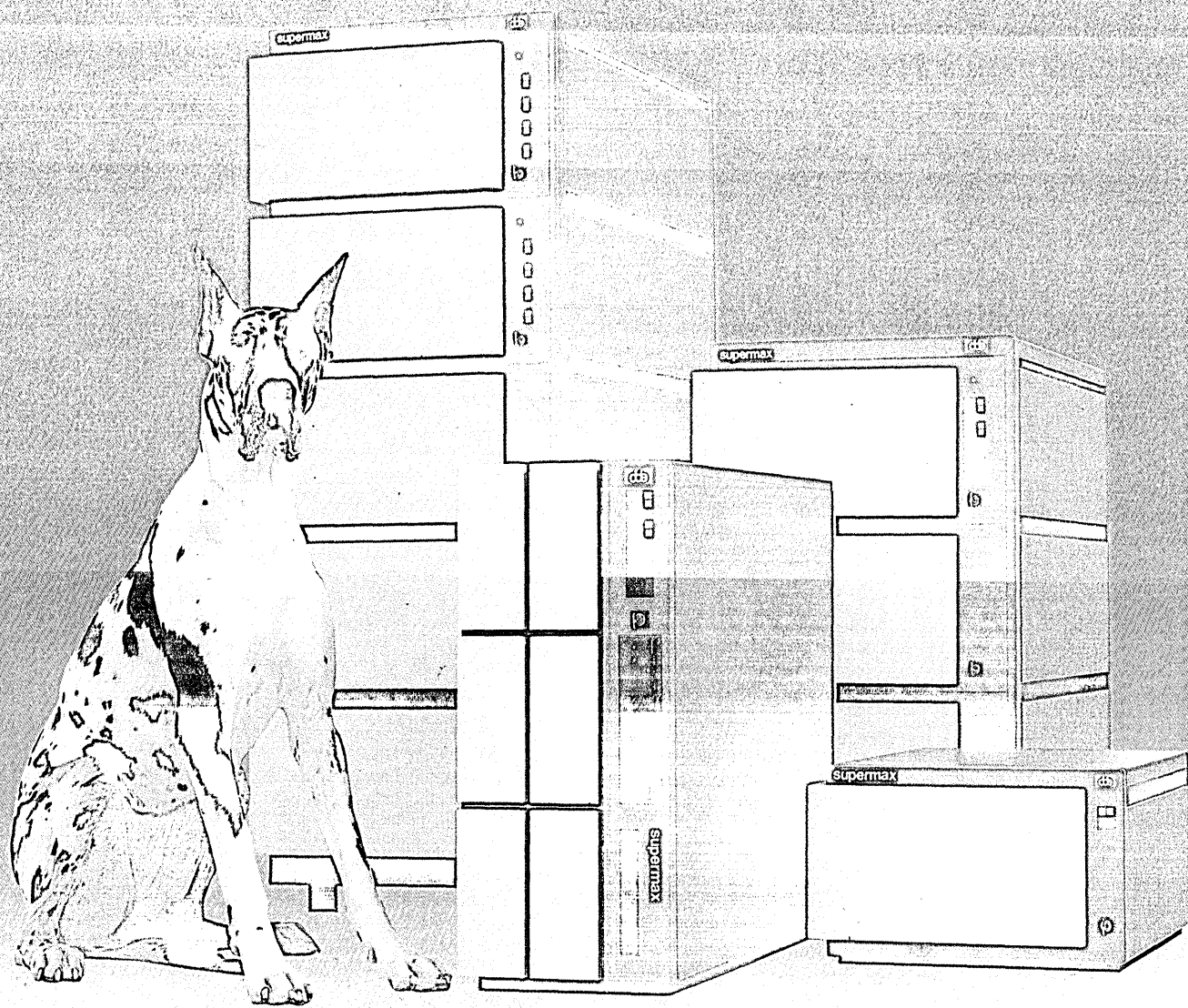



# — the great Danes at the Hannover Trade Fair

Supermax is more than  
a "super-micro"

## Hardware

### Power:

Multi-CPU, 1-8 MC68000 CPUs  
6-4.8 Mips performance  
32 bit architecture  
Intelligent I/O controllers

### Expandability:

1 to 8 MC68000 CPUs  
256 KB - 128 MB  
Up to 128 users  
10 MB - 10 GB hard disk  
Modular construction

### Reliability:

Standard ECC  
No-break battery backup  
Remote diagnostics

## Software

### Operating System:

Multi-CPU  
Multi-user/tasking  
UNIX™ System III compatible  
Berkeley enhancements  
Relational Database

### Languages:

Pascal  
C  
ANSI '74 COBOL  
Fortran '77  
Business Basic

### Communications:

2780/3780  
JES 2/HASP  
3270 SNA and BSC

Our new multi-CPU SUPERMAX is more than a super-micro. It compares with them, but can grow to a size and a power with a price-performance that cannot be matched by either super-micros or super-minis.

SUPERMAX gives OEMs and distributors an ideal vehicle for rapid development of new, and expansion of existing markets. Its unique architecture satisfies user requirements for flexibility, reliability, and longevity.

OEM's and distributors:  
Choose the cost-effective solution

— it is available now!

See us at CEBIT, Hall 4  
Booth 1906/2006, April 4-11

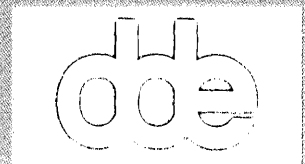

Danish Data Electronics A/S  
207, Herlev Hovedgade  
DK 2730 Herlev, Denmark  
Telephone: int. +45 2 84 50 11  
Telex 35258 dde dk

UNIX is a trademark of Bell Laboratories



## NEWS IN PERSPECTIVE

terminated that about 30% of the transactions at the Vimercate plant fell into the confidential category, while 45% were deemed

### It was discovered that IBM was keeping duplicate records from the two software packages.

confidential at a plant in Segrate.

"This does not correspond to the truth," says Gianfranco Traini, provincial secretary of the Italian Metalworkers Feder-

ation (FLM) and one of the signatories of the legal action. "Joint examination means agreeing together what are the vital areas, and not a 'company dictum' on what they are. It goes without saying that such areas cannot involve practically all the plant, as IBM would like—that is, 90% of the employees using vdu's 90% of the time."

The company's response to that criticism was less than generous. "We have signed an agreement that provides for joint examination, therefore for meetings, not for new agreements," declared Raffaele

Zallone, a legal advisor to the firm, who accompanied the police as they seized the SLR records. "And these meetings have taken place. As far as the power to decide what data and information are vital or confidential, it is clear that it is a matter exclusively for the company."

"IBM is applying the agreement on joint examination in accordance with this interpretation, selling RACF and SLR in Italy as freely as it does other software products," Zallone added.

In a rare showing of openness, the company has made Zallone available for interviews with the press, an indication of how important the situation is to IBM.

At this point the two parties each stood its ground in what appeared likely to be a lengthy standoff. Then, all of a sudden, the situation took a dramatic turn.

An analysis of the thousands of papers taken from IBM's offices disclosed that the company was keeping duplicate records, one copy of which contained operators' personal codes and another that used only a system or departmental code. A trade

### "The legality of the agreement signed by both sides grew out of the principal objective of security, which legitimized the use of such [remote control] programs."

union lawyer, Mario Fezzi, claims to have reconstructed from the IBM records a profile of every single worker that contained such information as the quality of transactions carried out by the worker, the portion of operations not completed because of operator error, the number of hours worked by the operator, the number of input and output transactions, the time taken for each transaction to be completed, the memory used, and the number of lines printed out for each transaction.

Of particular concern to the union officials was the measurement of error rates, as well as the rates of transactions per hour.

"The affair of the duplicate records is rather delicate because it takes us outside the terms of reference of the second clause [of the Statute of Labor], which refers to unintentional remote control [of workers]," comments Judge Michele di Lecce, who is presiding over a preliminary inquiry. He made his comments in an interview with DATAMATION.

"The legality of the agreement signed by both sides grew out of the principal objective of security, which legitimized the use of such programs and only secondarily led to remote control of the workers' activity," di Lecce says. "Now, however, remote control has become one of the principal objectives, not an attendant and neces-

# VMSCHEDULE

## VMSCHEDULE has reduced our prime-time workload by 30%."

VMSCHEDULE—A complete scheduling package for end users and management:

- Optimizes machine use by running scheduled resource-intensive events during off-prime hours
- Saves systems personnel time by automatically running repetitive operations without intervention or initiation
- Automatically re-schedules events when the machine has been down
- Provides optional load balancing features
- Uses simple English sub-commands
- Allows concurrent operations by several users
- Increases security by verifying passwords
- Requires no mods to CP or CMS

**703-821-6886**

**VM** Software Inc.

Name \_\_\_\_\_

Title \_\_\_\_\_ Company \_\_\_\_\_

Address \_\_\_\_\_

City \_\_\_\_\_ State \_\_\_\_\_ Zip \_\_\_\_\_

Phone \_\_\_\_\_ CPU \_\_\_\_\_

2070 Chain Bridge Road, Suite 355, Vienna, Va., 22180

DTM-0384

CIRCLE 31 ON READER CARD

**A lot of terminal manufacturers have tried to copy our ergonomic design**

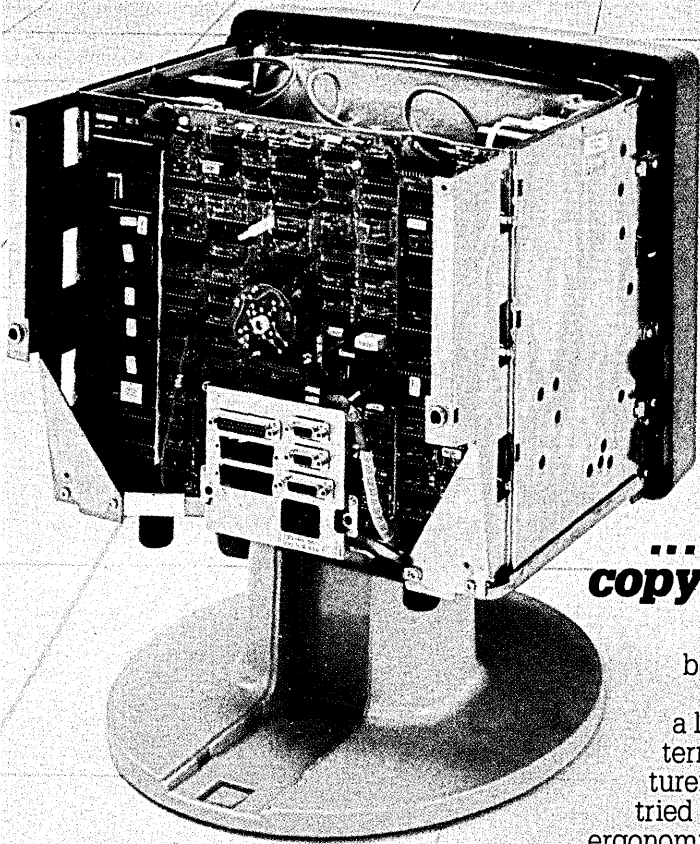

**... It will be a lot tougher to copy our performance**

In 1980 when Tandberg Data introduced the TDV 2200 family, they were the first and only terminals in the world meeting the stringent specifications of the 1985 German Ergonomic Standard... a standard set to protect the safety, health and comfort of the operator. The TDV 2200 includes such features as tilt, swivel, height adjustment, ultra-low profile, detachable keyboard for comfort of operation, non-reflective surfaces, and anti-reflex tube for screen clarity. Since its introduction and as a testimonial to its innovative design, over 50,000 units have

been installed. Today, there are a lot of "me-too" terminal manufacturers who have tried to copy our ergonomic design and that's certainly a plus for the industry. But, with our new TDV 2200S, an even improved version, it will be a lot tougher to copy our performance.

The TDV 2200S can emulate virtually any popular terminal and protocol. It can be equipped with up to 56k bytes of memory and some models will store up to eight pages of data. It has superb communications capabilities including

networking; up to 1024 different characters in a single terminal; optional high resolution business graphics; a 70Hz refresh rate for flicker-free viewing; and a 15" screen and big letters for easy readability.

Like its predecessor, the TDV 2200S also features sixteen soft switches called PUSH keys that recall previously stored words, phrases or code sequences; a simplified menu protocol that cuts set-up time in half; and character, page, block or line/field transmission. No other terminal on the market today can match all of these features. But, they are probably trying.

So, you can wait while they try to catch up with us, or you can go with the terminal that sets the pace for the industry. Tandberg Data, Inc., P.O. Box 99, Labriola Court, Armonk, N.Y. 10504. Phone: (914) 273-6400. Telex: 137357 Tanberg Arnk.

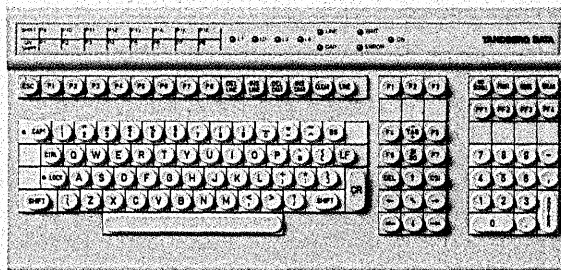

**TANDBERG DATA**  
Tandberg Data, Inc.

# Management may never know the power of this envelope.

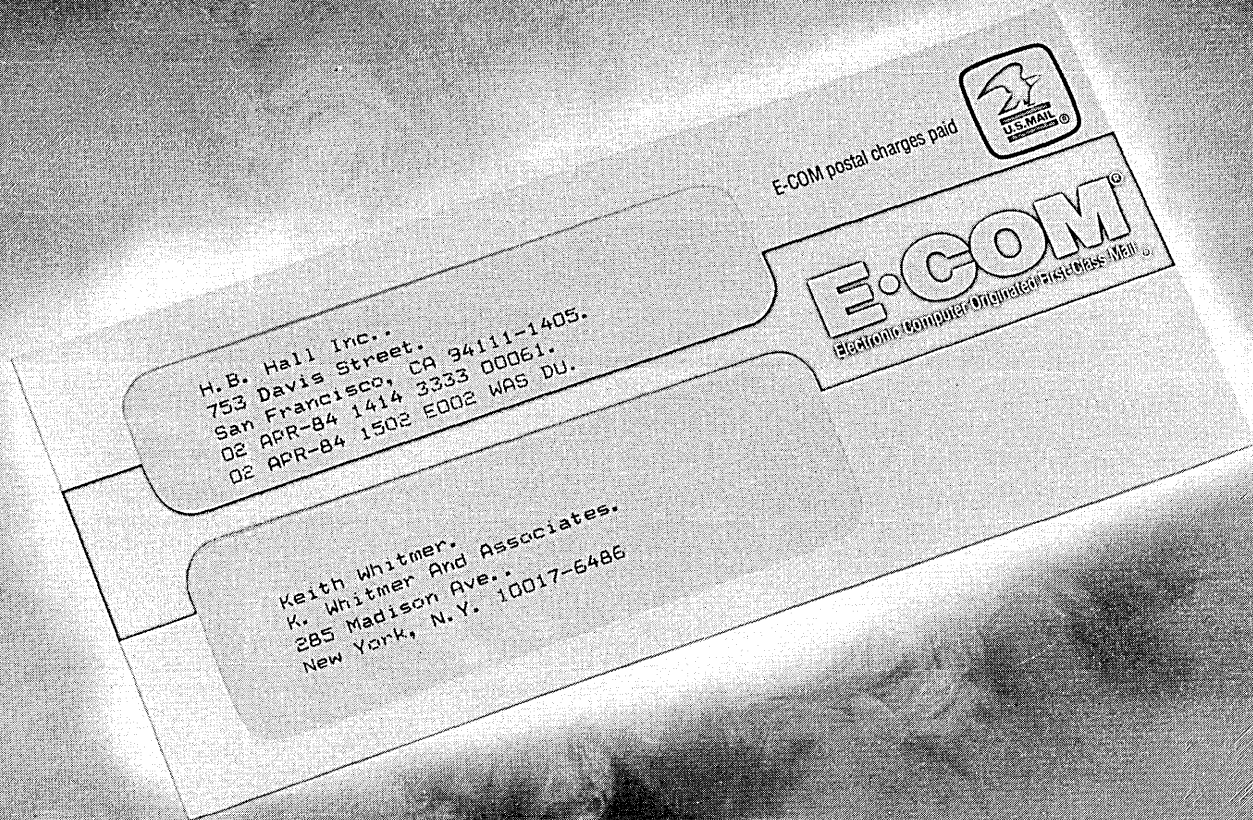

## Unless you tell them.

©USPS 1984

**You don't have to tell management how easy it is to implement \*E-COM® service.** That can be your secret. Tell them instead about the power of an E-COM service mailing. How letters can be sent right from the company computer. How the Postal Service prints, folds, inserts, seals and delivers these letters for you. How the distinctive blue envelopes of E-COM service lend visibility and impact to your mailing.

Since you're the one who gets E-COM service up and running, you have three options—all of them easy. First, you can write the system

interface yourself. It takes about a day, and Postal Service consultants are standing by to give you any help you need. Second, you can buy a dedicated interface from a third-party vendor. Third, you can access E-COM service through an independent communications carrier, without bringing the system in-house at all.

As part of the D.P. department, you're in a unique position to tell your management about the power of E-COM service. So find out more. Send us the coupon you see here. You may never again get so much credit for so little work.

\*Electronic Computer Originated Mail  
**CIRCLE 33 ON READER CARD**

For more information on E-COM service, mail this coupon to:

U.S. Postal Service  
E-COM service, P.O. Box 23990  
Washington, DC 20026-9989  
Or dial toll-free **1-800-842-9000** Ext. 300

Name \_\_\_\_\_

Title/Position \_\_\_\_\_

Company/Organization \_\_\_\_\_

Street Address \_\_\_\_\_

City, State, ZIP Code \_\_\_\_\_

**E-COM®**   
**DELIVERS IMPACT.**

IT THAT THOUGHTFUL ISN'T THAT THOUGHTFUL

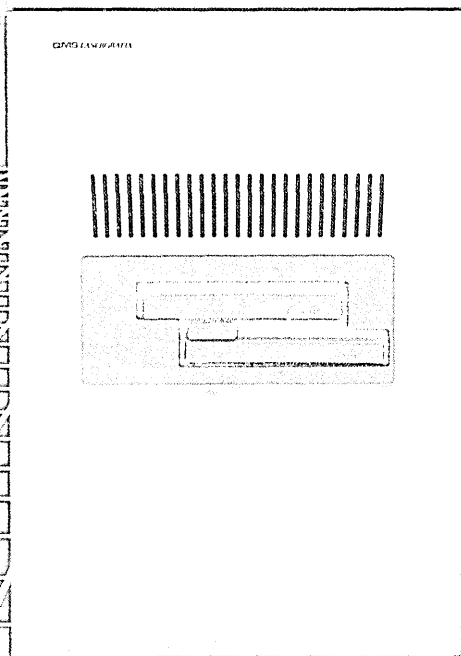
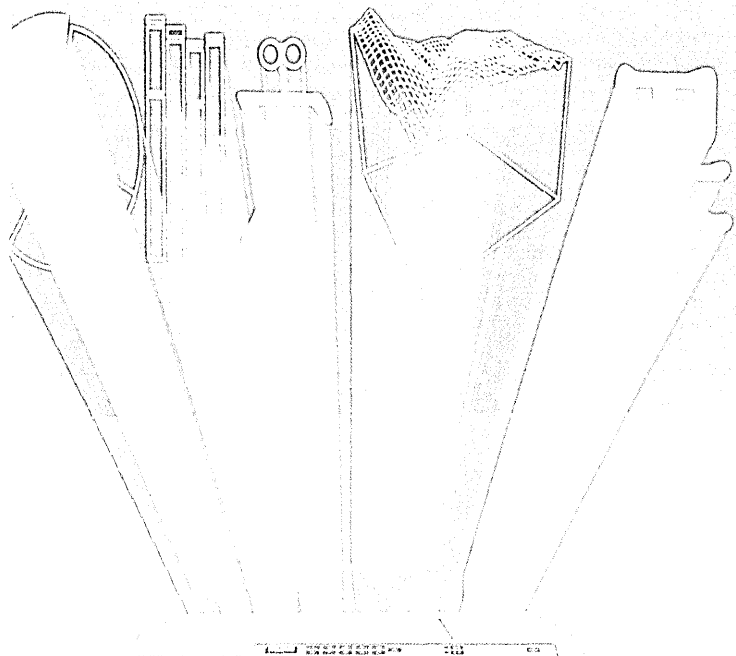

It's not that you're not thoughtful. It's that you're not using the right tools.

For the past few years, you've been using a laser printer that's slow, noisy, and expensive. Now you've discovered the Lasergram 1200. It's the only laser printer that's fast, quiet, and affordable. And it's the only one that can print at 600 dots per inch. That means you can print text that's as sharp as a photograph. And graphics that are as detailed as a drawing.

The Lasergram 1200 is the only laser printer that can print at 600 dots per inch. That means you can print text that's as sharp as a photograph. And graphics that are as detailed as a drawing. And it's the only one that can print at 600 dots per inch. That means you can print text that's as sharp as a photograph. And graphics that are as detailed as a drawing.

The Lasergram 1200 is the only laser printer that can print at 600 dots per inch. That means you can print text that's as sharp as a photograph. And graphics that are as detailed as a drawing. And it's the only one that can print at 600 dots per inch. That means you can print text that's as sharp as a photograph. And graphics that are as detailed as a drawing.

processing

The Lasergram 1200 is the only laser printer that can print at 600 dots per inch. That means you can print text that's as sharp as a photograph. And graphics that are as detailed as a drawing. And it's the only one that can print at 600 dots per inch. That means you can print text that's as sharp as a photograph. And graphics that are as detailed as a drawing.

And it's the only one that can print at 600 dots per inch. That means you can print text that's as sharp as a photograph. And graphics that are as detailed as a drawing.

And it's the only one that can print at 600 dots per inch. That means you can print text that's as sharp as a photograph. And graphics that are as detailed as a drawing.

Circle 1200 on Reader Service Card  
**FINE INNOVATION**

Send me the Lasergram 1200 laser printer. I'll be sure to check out the graphics and printing quality. Please contact me in any of the following ways:

Name \_\_\_\_\_ Title \_\_\_\_\_

Company \_\_\_\_\_

Address \_\_\_\_\_

Type of system you are now using \_\_\_\_\_

Number of pages per month \_\_\_\_\_

Circle 1200 on Reader Service Card

**QUALITY MICRO SYSTEMS**  
 P.O. Box 31250 - Atlanta, GA 30388

CIRCLE 34 ON READER CARD



## NEWS IN PERSPECTIVE

sary part. We are entering the realm of the first clause and are beyond the possibility of introducing programs following the trade union agreement. An agreement in itself serves no purpose; the only problem is the violation of the law."

IBM continues to claim that the information was statistical in nature and was intended for use only as a guide to improve the facility's organization.

IBM legal advisor Zallone declares, "You can glean data concerning people from any data processing system. From there to claiming the existence of remote control surveillance, however, is an enormous and unbridgeable step in logic. It is clear, in fact, that computers, as they are used by men, carry data that can refer to operations carried out by users. On the oth-

### **Of particular concern to the union officials was the measurement of error rates and transaction rates.**

er hand, these data, because of their incoherence, partiality, and above all lack of objective standards of comparison, are not suited to carry out any sort of remote control on the activity of individual operators."

But what about the records of error rates? What exactly is meant by an error?

Taking into account that there can be many causes of such errors, it is not assumed or proven that the errors necessarily originate with the employee, Zallone argues.

His trade union counterpart, Fezzi, objects. "We do not believe it is necessary to identify the operators to record the loading of the computer. The records of the departmental and system codes are sufficient. The records of data on the operations of individual workers have no purpose but remote control of their activity."

Into the IBM-union fray now jumps Professor Giancarlo Maggiolini, who prepared an expert opinion for the magistrate. His conclusion? "Only if the system of objectives and standards to which the various measures must comply, and if the significance of the individual objectives or technical standards is laid down, is it possible to make valid evaluation of performance. It is obvious that the data collected and systematized and visualized, or which can be visualized, by SLR, which provides indicators for the use of resources, can also provide individual and group evaluation, as well as acting as a deterrent against the improper use of the dp system. It is worth reiterating that there are no elements in the records or standard SLR documentation that indicate whether or how this evaluation is done." In other words, remote control surveillance of

workers remains an abstract potential.

Anything but abstract, FLM retorts. "There is certainly no need for codified standards for the computer to control workers. We are not dealing with an engineering problem of designing control, but a legal one. The law bans control, not simply its exercise, or the way it is exercised. That is without considering that the section head with all the experience knows full well the

### **Unions are watching the IBM case carefully and may instigate legal action against other users of computer security systems.**

standard pace and ways of work that individual results have to match up to, and that IBM is the company where at the end of every year a report is drawn up on every employee by the boss.

"In this case records of the kind now on trial, even if they do not lead to immediate disciplinary action, can contribute along with other information to forming integral profiles of the employees. You can imagine the possible effects on their career, pay increases, and promotional prospects," asserts Fezzi.

The judicial inquiry is still under way and no one can say how it will turn out,

# This April twice the maga

April 1, 1984

**D A T A T A N**

April 15, 1984

**D A T A T A N**



but unions are said to be already inspecting the use of SLR and RACF at IBM customer sites and the use of similar programs run on other vendors' computers. Honeywell, for example, is marketing a package called Sesame, which is said to handle data security functions and which may raise the unions' ire. Trade union sources say that several more legal actions similar in nature to the IBM affair are being readied but held off until the IBM case is determined. The sources decline to name the prospective defendants, but suggest that some fairly large corporations may be sued.

Monitoring workers by computer has gained notoriety lately in the United States, where workers at the *New York Times* classified ad desk, telephone company operators, and auto workers have complained of being watched too closely by machines.

"It's a big number in the white collar unions," says Harley Shaiken, an MIT professor whose forthcoming book, *Work Transformed—Technological Choice in the Computer Age*, discusses the issue in depth. "Even supermarkets, where the holographic scanners look so benign, have the potential to rank workers according to their productivity. Information is not an abstract quantity. It matters a great deal who is collecting it and how they collect it."

## MICROCOMPUTERS

# IBM TO GO PORTABLE

**The industry leader has two portable versions of its personal computer, Crackerjack and PPC Two.**

by R. Emmett Carlyle

While claims by Apple for its new Macintosh personal computer still ring across the industry, and with AT&T soon to make its pc debut, IBM is poised to bedevil both contenders with a pair of portable computers.

A machine weighing less than 30 pounds, the Portable Personal Computer is now being shipped in limited quantities at a competitive \$2,795 price. "If the machine lives up to its code name, Crackerjack [something 'exceptionally fine,' according to the dictionary], it will turn the whole industry on its ear," says one insider. And there's more.

According to Robert Fertig, a Greenwich, Conn., industry analyst, IBM's 30 lb. portable has a number of features that will divert buyers from Apple and AT&T. First is the new software, which allows clusters of portables, PCjr's, and PCs to share a hard disk in what Fertig refers to as a "bastardized LAN arrangement." Software and cable for a five PC combo, for example, cost a little over \$2,000, but there are as yet unannounced features, he claims. Chief among these is an extra Unix-like operating system based on Microsoft's Xenix, and a much lighter PPC Two, this time a 15-lb. flat panel display-based system that could be announced within 60 days. Version Two is also expected to offer the MS/DOS/Xenix combination.

For the present, Jack will sell close to Mac's price, and will offer comparable graphics and an optical mouse, built-in 9-inch display, dual-sided 360KB diskettes, and 256K RAM main memory with its Intel 8088 processor.

Fertig points out that a comparably configured PC would cost around \$5,000, and thus heavy price-cutting of the venerable three-year-old PC can be expected to follow shortly.

Apple has been careful to make sure its "Big Mac" attack (February, p. 61) has not been on a collision course with IBM's

# l, it'll be zine it is today.

## DATAMATION®

## DATAMATION®

Every month over 165,000 information processing professionals depend on *Datamation*. It's the best read, most respected publication in the computer industry worldwide.

And to help our readers cope with the increasing demands of their jobs, *Datamation* will be increasing its frequency beginning this April. Two issues every month. 24 issues a year. More vital information. More in-depth features. More timely topics. And *twice* the opportunity to stay ahead of the world's fastest moving business.

*FULL DUPLEX*

**4800**

**2win**

# blips!

## LE full duplex modem

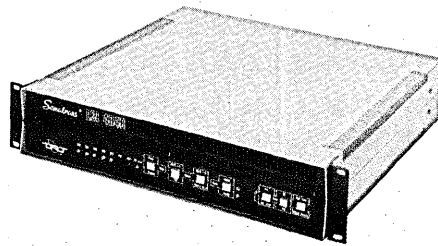

For more information



88, rue Brillat-Savarin - 75640 Paris Cedex 13 - France,  
Phone (1) 581.11.12 - Télex 250838 F

CIRCLE 35 ON READER CARD

# EMULATION PLUS + AMBER

## FROM AMPEX

The figures are in. Ampex Emulation Plus terminals with ergonomically superior Amber now outsell our white and green phosphor VDT's 4 to 1. But the choice is still yours. With all three colors available as standard on all three Ampex ASCII editing terminals, you've got flexibility.

Built-in flexibility to emulate up to 20 popular models\*, with eight resident character sets in your choice of detached selective-type or programmer

keyboards. Price flexibility, starting with our new low-cost Di25, on up to our Di50 and Di75. Flexibility to customize both hardware and firmware. And most importantly, maintenance flexibility through a nationwide network of TRW service centers. That's total flexibility.

Find out why Ampex Emulation Plus terminals with Amber are challenging the market with loads of features and flexibility at a price you won't believe. Call your nearest Ampex distributor, or give us a call direct at 218-416-1575.

\*Including models from Televideo, Lear Siegler, ADPS, Hazeltine, DEC, and SOROC.

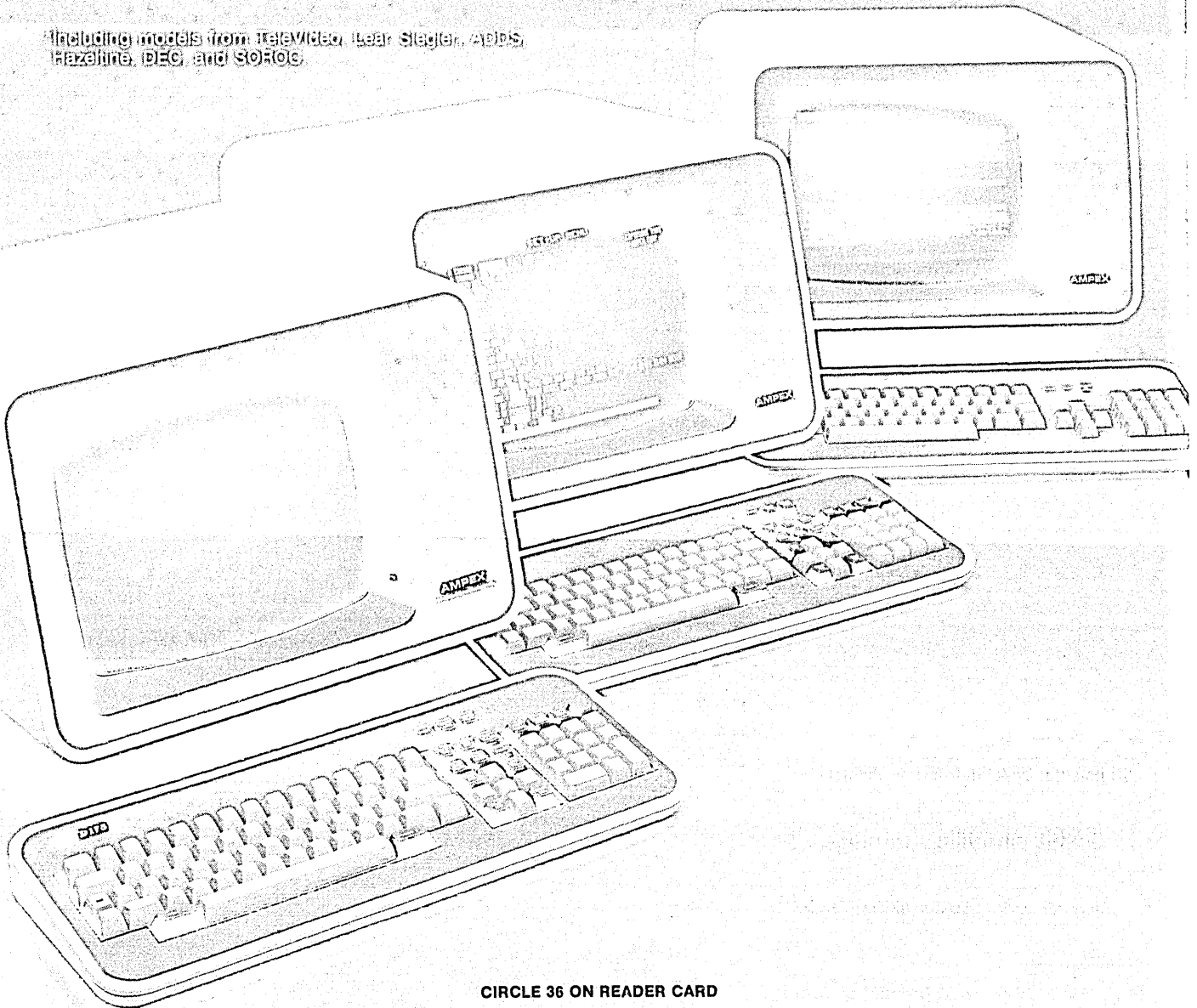

CIRCLE 36 ON READER CARD

## NEWS IN PERSPECTIVE

PC. Apple is reportedly trying to maintain its solid number two status in the personal computer business by offering what it calls a "viable alternative" to IBM's standard. Macintosh is not compatible with IBM and offers its own proprietary operating system, MacOS. The lack of IBM compatibility has greatly reduced Apple's potency in large corporate accounts, and so most observers feel that Mac will score its biggest successes with users in the home, education, and small business sectors.

But despite being blocked in the corporate market, Apple is apparently still insistent on widening its horizons. Reportedly, Apple chairman Steven Jobs thinks this can be achieved by adopting Unix—already popular in the university and government sectors, and seemingly everyone's favorite for a commercial standard.

But here, as with Apple's Lisa computer, IBM seems to have anticipated the company's thinking and looks to have beaten Macintosh to the punch by optimizing Unix at the portable level on a Mac-like system, observers point out.

Apple is aware that it must maximize interest in Mac in this postannouncement period. The company is trying to rebound from two flops, the Apple III and Lisa, and needs to raise its delivery volume and hook third-party software developers to

### **Apple Computer is reportedly toying with the idea of bringing Unix to its personal computer line.**

maintain dealer interest.

The IBM announcement, says one source, "will definitely defuse Apple's thrust. Users will be offered a choice between IBM and Apple in the same markets, and nobody doubts IBM's ability to manufacture in high volume and effect better distribution and end-user marketing. It could be a very one-sided contest."

The inclusion of a Unix-like operating system on the portable will also divert buyers from AT&T. Ken Bosomworth, president of International Resource Development, Norwalk, Conn., claims that AT&T's production and marketing have "gone completely out of sync. Production is completely gobbled up in the manufacture of outmoded analog switches, many of which won't even find a distributor or a buyer by year's end. The factories are still functioning as if they were supplying the old captive market that the Bell telephone companies represented. Little production capacity is being aimed at real market need—especially in the computer sector AT&T has just entered with great fanfare."

The result, says Bosomworth, has been a shortage of 256K RAMs and the 3B computer family that AT&T hopes to launch soon to battle IBM. The forecasts now circu-

# The system that lets you forget to remember.

# NCR COM

All you do is tell the NCR 5300 Computer Output Microfiche (COM) recorder how many duplicates you want. Then forget it. The recorder tells the new in-line duplicator what's needed. And that's what you get, completely collated.

All that without operator intervention. And at the fastest speeds you'll find in any COM system.

The system is flexible, too. You can choose between wet or dry-silver recorders. And duplicators that produce vesicular or diazo copies.

However, don't take that string off your finger yet. Wait until you've talked to your local NCR Micrographic representative. For more information call or write NCR Micrographic Systems Division, Box 606, Dayton, Ohio 45401. 1-800-543-8130 (in Ohio, 1-800-762-6517).

**NCR**  
Micrographic Systems Division

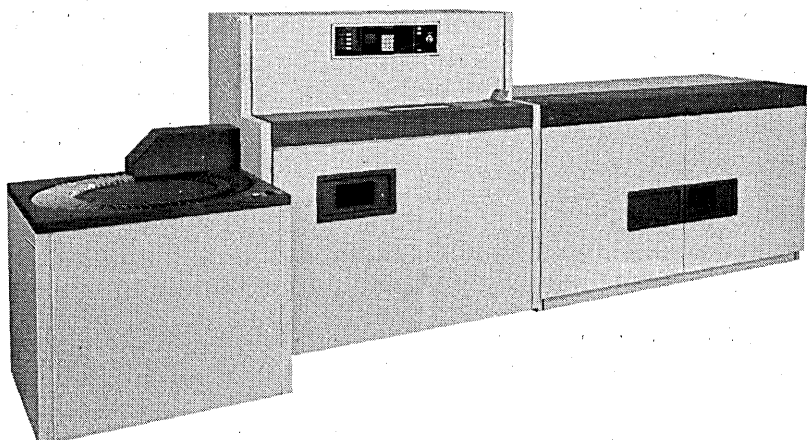

NCR provides worldwide service and support for the NCR 5300 COM Systems.



## NEWS IN PERSPECTIVE

lating within AT&T are that the 3B family of 32-bit minis may not emerge until next year!

Having opened the floodgates for Unix to become a commercial standard—a fact demonstrated effectively by AT&T's keynote speakers at the recent Uniforum gathering in Washington, D.C.—IBM has demonstrated its marketing prowess once

### The January introduction by IBM of Unix for its PC was seen as a slap on the wrist for Microsoft Inc.

more, by reaping an early harvest. While AT&T's speaker was telling a packed auditorium what would be coming from the telecom giant, IBM announced, and was selling, its new Unix operating system for the PC in the lobbies, corridors, and demonstration rooms of the Washington Hilton.

The January announcement of the PC/IX, while hurting AT&T, was also seen by many as a slap on the wrist for the Bellevue, Wash.-based Microsoft. So far IBM's PC/DOS operating system (a modified form of Microsoft's MS/DOS) has been the featured

operating system on IBM's PC, PC/XT, and PCjr. But IBM has grown increasingly troubled by its growing dependence on Microsoft, and the attendant loss of control of its PC family, industry sources explain. This, coupled with Microsoft's aggressive marketing and comments from its much-quoted young chairman, Bill Gates, that make it seem as if Microsoft invented the PC, have alienated the company from IBM, sources add.

Xenix, as Microsoft is quick to point out, is by far the most popular version of Unix on micros. Bearing this in mind it seemed a natural for the PC. But IBM chose instead to commission Interactive Systems Corp., Santa Monica, Calif., to modify its version of AT&T's Unix System 3 for use on the PC and offer that instead.

"It was some measure of IBM's desire to find an alternative to Microsoft that it did this. Because Interactive's Unix more typically runs on larger systems such as DEC's VAX, the Intel 8088 is not an ideal host for it," says one observer.

IBM has since recommended that a minimum of 256K main memory—"ideally 512K"—and 10MB of additional fixed

disk is required for its new Unix. "For effective multi-user/multitasking, IBM knows it really needs to offer 20MB disks for the PC/IX," one source confided, "and this is one of the primary reasons it has recently cut back its 10MB orders from Miniscribe and Seagate, and is actively hunting 20MB disk suppliers."

Thus, Interactive's version, which is expected to be extended upwards to bridge IBM's VM systems, is not appropriate for IBM's portable.

Microsoft, on the other hand, has guided much of its recent operating systems development into the portable business. A miniaturized version of its MS/DOS was built into the popular 4-lb. Radio Shack TRS-100, which was manufactured in Japan. Microsoft watchers anticipate further work with the host of Japanese companies expected to bring portables to the U.S. marketplace.

Though IBM is clearly aware of the dangers of placing all its eggs in one basket, it looks as though the company has returned once more to Microsoft, this time requesting that Xenix be optimized at the portable level. Microsoft's director of Xenix development, John Ulett, declined to comment on any aspect of the story. The company would say only that it will offer some guidelines to its strategic and product directions around the middle of this month.

As for IBM, talk of Unix revolutionizing its entire product line is now rampant

### Some observers expect IBM eventually to offer Unix on its full line of machines, from desktop to mainframe.

within the company, according to one former senior executive. "I expect [Unix] to become fully portable from 8088 micro to mainframe level." This means, he says, that the same applications program will run across a variety of different computers and hardware generations from desktops to mainframes.

IBM's PC/IX is only the first of many steps. It will be followed by compatible versions for 4300s, 308Xs, and the company's Sierra/Trout mainframe family. IBM has already shifted much of its new software development into Unix's programming language, C, to achieve greater portability, he adds.

Fertig expects IBM's local area network and an associated relational database capability within LANS (known within IBM as R Star) to be announced shortly, to neatly glue these components together.

Having already shifted to MS/DOS and Concurrent CPM at the 8-bit and 16-bit micro levels, IBM's proposed adoption of Unix at the 32-bit level has not gone down well with IBM diehards who are more accustomed to creating rather than following somebody else's standards. One source



**CRACKERJACK:** IBM's 30-lb. Portable Personal Computer comes with one double-density, dual-sided disk drive, 256K of RAM, and, one hopes, a strong handle. The \$2,795 price and "bastardized LAN" software now available will pressure Apple Computer Inc.'s Macintosh as well as put AT&T further behind in the personal computer sweepstakes. Sources say a new Unix-like operating system will soon be available for PCs and PPCs in a cluster. A 15-lb. version of the FPC will soon be announced, sources add. It will use a flat panel display instead of the 9-inch amber crt-based system announced by IBM a few weeks ago.

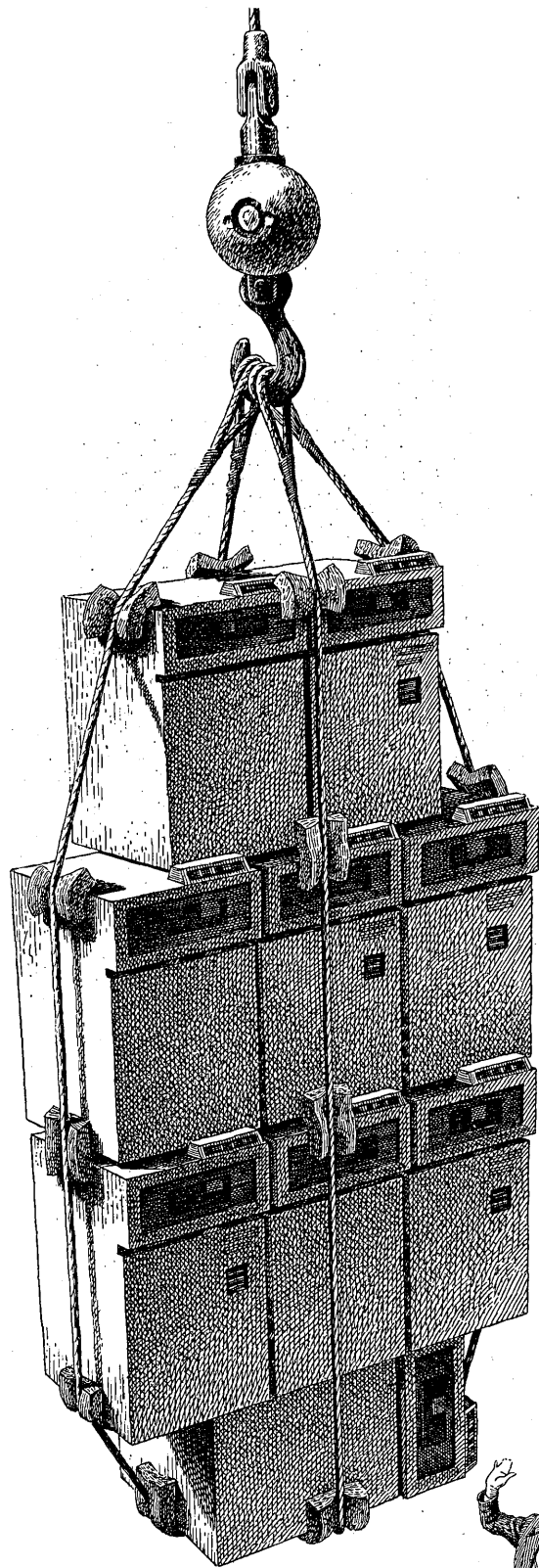

## How to put 640 square feet of computer disk storage in a 7' x 3' space.

There's no way to store that much data in that little space if you're using disk drives. Even 3380 class. But Masstor Systems' M860 Mass Storage System — a different kind of data storage technology — can solve the problem.

The entry-level M860 stores 55 billion bytes of data on-line and can be expanded to 440 billion bytes. At one-quarter the cost of disk. And less than 4% of the floor space. It also automates tape operations, making processing much faster and more economical.

The M860 is a third storage alternative for your IBM and other plug compatible mainframes. One that offers more on-line storage capacity for your new applications and requires no conversion of your existing programs. Masstor has an M860 solution for Sperry, Honeywell, DEC/VAX and CDC mainframes, too. As well as a way to hook them together in a network: MASSNET.

The M860 and MASSNET are two of a family of Masstor Systems' strategic products that allow you to move, store and share data efficiently and economically.

To find out more, contact Dave Ball at Masstor Systems Corporation, 5200 Great America Parkway, Santa Clara, California 95050. (408) 988-1008. And cut your data storage problems down to size.



## MASSTOR SYSTEMS

Strategic solutions to moving,  
storing and sharing data.

## NEWS IN PERSPECTIVE

says that IBM's Unix task group has been heavily criticized for sponsoring so many forms of the software.

They've been asking, perhaps with good reason, "Where's *our* operating system in all of this?" \*

# IBM LIX AT&T IN UNIX MIX

**The computer maker has beaten the phone company to the punch on its own operating system turf.**

by R. Emmett Carlyle

It seems to be a case of IBM pouncing as AT&T dithers. In January the computer giant unveiled a Unix-like operating system, PC/IX, for its PC and stands poised to do the same thing with its first portable computer (see "IBM To Go Portable," p. 61).

The timing of the PC/IX announcement was pure IBM. The system was demonstrated at the Uniform show in Washington, D.C., the largest Unix gathering on record, and clearly expected to be a showcase for AT&T and its products. In one stroke, IBM managed to both preempt and defuse AT&T's thrust on its own home turf.

"We also sold a lot of systems," chuckled demonstrators at the IBM stand—a last-minute addition to the show.

By the third day of Uniform, experts were already predicting that PC/IX will grow to become the de facto standard for *all*

## Two Unix standards, System 3 and System 5, have emerged and drawn loyal followers.

multitasking desktop pcs below \$25,000. In addition, the most powerful and most commercial of the three Unix user groups, /usr/group, is about to ballot its members on a proposed industry standard Unix it has drafted and intends to submit to IEEE later this year. According to /usr/group's standards committee chairman Heinz Lycklama, its proposals are based on Unix System 3, *not* on the System 5 version that AT&T is trying to get the industry to adopt.

It's worth noting that Lycklama is vice president of system development at Interactive Systems Corp., Santa Monica, Calif., which adopted Unix for IBM and its PC. Both Lycklama and IBM confirm that PC/IX is based on Unix System 3 with only a few minor variations from the /usr/group's proposed standard. Thus, IBM would appear to have the additional weight of a whole

user group behind its already considerable marketing momentum, before AT&T ever leaves the starting gate.

Unix System 3 emerged from Bell Labs as the first truly "standard" Unix within the Bell System, and was first licensed to oems and vendors in 1981. AT&T has since modified System 3, and last year threw its weight behind the new version, System 5.

"With System 5," says Jim Isaak, marketing director at Charles River Data Systems, Boston, "AT&T has begun its seduction of the industry. This is the first level at which it has offered support and training, and the first level at which it is optimizing the operating system with its own hardware and applications."

An example of this trend was forthcoming at the Uniform show where AT&T unveiled a new release of System 5 (called 5.2), which improved its performance and throughput. "Here, for the first time, a revision of Unix was tied to an AT&T product, namely the Teletype 5620 terminal with

## TO SEE 3B, OR NOT TO SEE?

Could the new AT&T have so messed up its production that it might not ship a new computer line this year? Some observers clearly believe so.

Ken Bosomworth, president of International Resource Development (IRD), Norwalk, Conn., while still holding out hope that AT&T's 3B family may be unveiled in 1984, believes it won't appear in any volume.

"There seems to be a classic mismatch between AT&T's production and marketing, reminiscent of Chrysler's problems in the old days," says Bosomworth. "Western Electric's factories are still churning out old switches, cable, and other telephone gear as if the captive Bell telephone company market still existed for them."

Bosomworth believes that large numbers of "outmoded" ESS 1A and 2A switches will be built that don't have a user or even distributor's name on them. "By year's end they could have a billion dollars' worth of goods piling up in their inventories, around 10% of all production for the year, and all looking for a home."

With production capacity tied up this way, the company is unable to satisfy *real* market demand for its computers, digital switches, and the vital semiconductor chips that they're built from. "Last year AT&T shipped only 100 of its Dimension 85, while all the time there was a market for at least 10 times that number," Bosomworth added.

The net result is that AT&T cannot even satisfy internal demand within the Bell System for 256K RAMs or 3B-20 computers, never mind sell on the outside, the IRD president believes.

added 'windowing,' and this is only the first step," says Isaak.

"We'd be utter fools," says Jim Edwards, marketing vice president at AT&T Technologies, "if we didn't maximize Unix by providing the best price/performance hardware to run it. We'd just be providing the industry with an operating sys-

## Some observers think Digital Equipment has the most to lose as Unix establishes itself in the mainstream commercial market.

tem so that somebody else can get all the hardware business."

In broader terms, this optimization will soon encompass a whole family of computers, the 3B series (February, p. 64), featuring Bell's innovative Bellmac 32-bit micro and 256K RAM chips, which Edwards claims will be popularly available this year.

In some quarters of the /usr/group, and *all* segments of IBM, this optimization is

"It's an open secret," counters AT&T Technologies marketing vice president James D. Edwards, "that we're experiencing production constraints in the semiconductor area. But who isn't? IBM has just come out and admitted that it's having trouble getting enough MOS DRAMs from Intel."

Two years ago the semiconductor industry was far from capacity," Edwards continues. "But today, coming out of a recession, we're all at capacity and straining at the seams to meet demand. For us, it's only a temporary hitch. We're bringing new factories on stream to meet the demand."

Despite confirmation from several Bell Labs sources, Edwards denies that AT&T is unable to meet internal demands for its 3B family. "That was last year's problem. If we didn't sell a single 3B-5 or 3B-20 computer on the outside this year, we'd still do over \$600 million's worth of business internally from the computers—and meet our demands."

Could production and marketing be out of sync to the tune of \$1 billion by year's end? "Hell, no. We're still producing certain bipolar parts for both old and new ESS switches, but they've all got customer names on them. The same goes for cable and all the rest. The only way you'll know for sure," he quips, "is to check our inventory at the end of the year."

"It goes without saying," he concludes, "that if we've been so maladroit in planning our business that our entry into the computer industry is flawed, we'll look like a bunch of nincompoops this time next year. But I don't expect this will happen. And you don't have to worry, you'll see 3B this year!"

—R.E.C.

# PICK UP WHERE IBM® LEAVES OFF.

Portable or desktop, you're way ahead when you pick up CORONA PC™. Because we give you everything you've ever wanted in an IBM<sup>1</sup>-compatible PC and more. For a great deal less.

## COMPATIBLE AND MORE.

Our systems run all software that conforms to IBM PC programming standards. And the most popular software does.

We deliver twice the memory, with room for eight times as much.

We deliver a fast-access 320K floppy drive, a communication port and an improved IBM PC keyboard with indicator lights.

Our systems include high-resolution monitors (12" desktop, 9" portable) for crisper, cleaner displays, and both have built-in high-resolution graphics (640 x 325).

You get a complete system, ready to go to work.

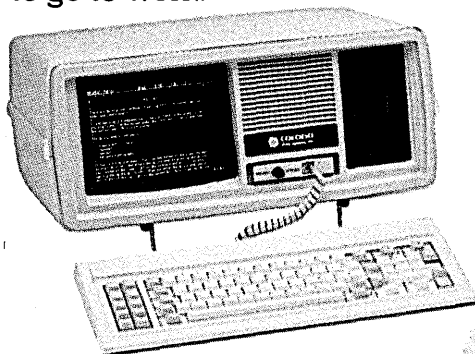

## MORE VERSATILITY.

With all the necessary features built into the main unit, the four expansion slots can be used for your special needs. For example, color or our optional 10MB hard disk.



## MORE SPEED.

Our RAM-disk software gives you temporary disk-type storage that works many times faster than disks.

## PLUS SOFTWARE.

Our systems come with the operating system: MS-DOS.<sup>2</sup> A programming language:

GW BASIC.<sup>2</sup> A training course: PC Tutor.<sup>3</sup> A professional word processor: MultiMate.<sup>4</sup> Plus DOS utilities and demonstration programs. Or you can get the p-System<sup>5</sup> from N.C.I. and write or run portable Pascal packages.

## ALL FOR A GREAT DEAL LESS.

Even with all the extra features and performance, our systems still cost significantly less than the equivalent IBM PC.

Drop by your nearest CORONA PC dealer for a very convincing demonstration. Or contact us at 31324 Via Colinas, Westlake Village, CA 91361. (213) 991-1144 or (800) 621-6746 toll-free. Telex 658212 WSLK, in Europe 76066 CDS NL.

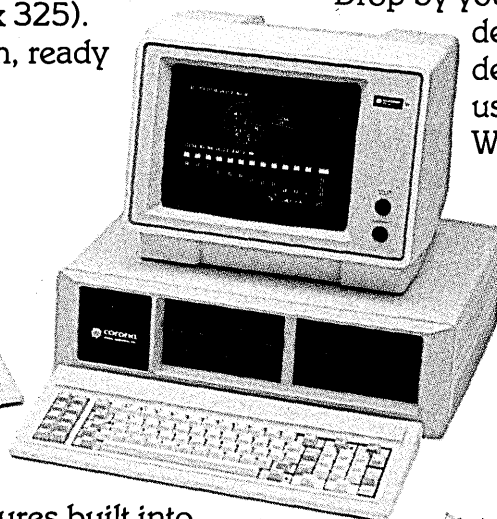

©Corona Data Systems 1983. 1. TM International Business Machines. 2. TM Microsoft. 3. TM Comprehensive Software Support. 4. TM Softword Systems. 5. TM University of California.

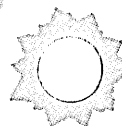

**CORONA**<sup>TM</sup>  
data systems, inc.



# Finally, the definitive for reaching today's— data communications

It's called ANI™—Advanced Network Integration. From Infotron.

ANI is a definitive path for network growth and management that's reflected in a family of data communications products and services.

It gives you something you haven't had before—the means to plan and implement a data communications network based on long-term strategy.

ANI covers everything we make—from simple modems to stat muxes, to high-speed

muxes, to network concentrators, to intelligent data switching systems.

ANI also includes everything we do. Systems engineering, from technical support to turnkey operations. Installation. Training. Telephone consultation and dialup online diagnostics. And worldwide field service.

#### **Growth.**

ANI products grow with you.

They're based on an architecture that's simple to expand and upgrade.

Because ANI products can

be expanded both in size and function, they're easily integrated into larger, more complex networks. They grow with you instead of becoming obsolete.

#### **Flexibility.**

ANI products are versatile.

They can accommodate computers and terminals with almost any combination of protocols and speeds.

And because of their modular structure, ANI products will accommodate bridges to other networks, and gateways to public and private resources.



# path and tomorrow's - objectives.

## Management.

Management and control are vital to the operation of large, widely-dispersed networks.

ANI products give you the tools for monitoring activities, gathering statistics and keeping informed of events as they occur. From a central point, networks can be configured to meet changing requirements and provide diagnostics for solving problems.

Regardless of network size

or complexity, ANI provides complete accountability for network operation.

We're Infotron. We wrote the book on data communications and networking. It's yours for the asking.

For your free copy and for information on ANI products, use the coupon, or call toll-free: 1-800-345-4636.



Infotron Systems Corporation,  
9 North Olney Avenue, Cherry Hill, N.J. 08003,  
or call toll-free 1-800-345-4636.

Please send me more information about  
ANI™, plus a free copy of *Making It Through  
the Maze of Data Communications*.

D3/84

Name \_\_\_\_\_

Title \_\_\_\_\_

Company \_\_\_\_\_

Address \_\_\_\_\_

City \_\_\_\_\_ State \_\_\_\_\_ Zip \_\_\_\_\_

Telephone \_\_\_\_\_

**See us at Interface, Booth 230.**

**Infotron communications networking. First in performance and reliability.**

## NEWS IN PERSPECTIVE

seen as a process of "locking in" the industry to AT&T hardware. Future versions of AT&T's Unix (Versions 5.6 and 6) will only be offered with proprietary virtual memory architecture elements. This is one big reason why /usr/group and IBM will want to add their own equivalents of 5.6 and 6 to their System 3 base, and thus retain a viable alternative to pure AT&T Unix.

This raises the immediate problem of too many versions of Unix. While Systems 3 and 5 struggle with each other for greater market penetration, Microsoft's Xenix version, which is currently in use on 80% of all micros using Unix, and the University of California at Berkeley's 4.2, which has recently found a strong advocate in Digital Equipment Corp., are also vying for recognition.

Bernie Toth, marketing manager for DEC's Ultrix program, says that 4.2 is the most powerful Unix implementation available and the only one that will support true 32-bit virtual machine architectures. "The Berkeley software has been optimized for use on VAX and that's why we've adopted it as the basis for our new Ultrix operating system," he explains.

"We would hope that as IBM and AT&T move from Systems 3 and 5 into virtual machine versions, they will adopt the Berkeley algorithms," says Toth. But this

seems unlikely, according to observers at Uniform, because of the intimate connection between 4.2/Ultrix and DEC's VAX hardware. So far DEC has been the prime beneficiary of AT&T's push to Unix, by providing the PDP-11 and VAX hosts for the development. In like manner, it has reaped a harvest in universities and government sectors where Unix is a virtual standard. AT&T Technologies vice president of computer systems, Jack Scanlon, points out that 90% of all computer science graduates in the U.S. have been exposed to Unix systems—

### Microprocessor makers are rushing to get Unix onto their 32-bit chip families in expectation of a major market boom.

"a fact highly relevant to the rate at which the operating system is now being accepted in the commercial sector," he adds.

DEC now stands to lose this business and AT&T, its single largest customer, as the telecom giant begins to adopt its own computer hardware and to sell to DEC's customers. One DEC source says this process won't happen quickly: "AT&T is having problems producing enough 3B systems for its own internal consumption (see box) and in certain sectors, especially Long Lines, it is

temporarily having to move back to VAX."

Nevertheless, these doubts were enough for experts at Uniform, such as Richard Schreiber of California-based research house Dataquest, to mount a "DEC is in danger" theme. Schreiber says, "Another danger is that IBM and other pc and workstation builders will be able to use Unix to log into VAX systems and take away its add-on business."

Toth was not unduly concerned. "We believe our customers will prefer our MicroVAX workstations because through Berkeley 4.2 they are the only true 32-bit virtual Unix machines." Still, by its adoption of 4.2, DEC does seem to have painted itself into a corner by opposing the "mainstream" efforts of IBM and AT&T. "Whatever happens," Toth confided, "we'll follow whatever standard emerges. That's always been our policy at Digital."

Despite what Unix watcher Jean Yates called the "muddy" standards picture, IBM's position seems crystal clear. Once its PC/IX operating system (which licenses for a one-time \$900 charge) hits the streets next month, the beginning of a serious flow of Unix applications software in the commercial sector should take place as independent software companies scramble to accommodate IBM's multimillion-unit PC business. But Unix System 5 applications might not be too far behind.

Motorola announced at Uniform that it has completed a ported version of AT&T's System 5 specs on its 68000 family of 32-bit processors. "The completed port was submitted to AT&T just before Christmas, and its approval is expected anytime," says Tom Beaver, director of Motorola's Microsystems operations.

The race is now on among Intel, National Semiconductor, and Zilog to achieve the same feat with their new 32-bit micro families. Spokespeople for all three claimed that their ports would be forthcoming by year's end, with Zilog seemingly first in line. These companies are also cutting individual deals with third-party software companies to get applications written for their Unix System 5 micros.

AT&T and Motorola both revealed that Digital Research (DRI), Pacific Grove, Calif., the creator of the industry standard CPM and Concurrent DOS operating systems, is an early choice as an ally. With AT&T, DRI is helping to produce a Unix System 5 applications library, and act as merchandiser and middleman in the distribution process.

Motorola, in turn, has called on DRI's new family of portable compilers, which allows programmers in high-level languages such as COBOL and FORTRAN to work with Unix without having to change their source programs.

The net result of all these moves is that applications will be created in 1984.

# dBASE II™

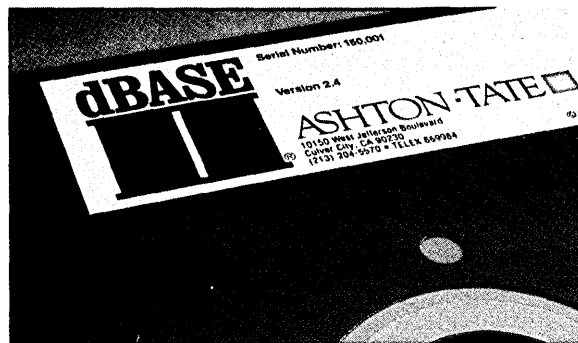

dBASE II® is, quite simply, the bestselling database management system (DBMS) made for any computer.

Doctors and lawyers, accountants and salespeople, stockbrokers and students, big business and small—over 150,000 users around the world are all managing their data better with dBASE II.

Books have already been written about it. Hundreds of independent businesses are based on it. And other microcomputer programs measure themselves against dBASE II.

For the name of your nearest dBASE II dealer, contact Ashton-Tate, 10150 West Jefferson Boulevard, Culver City, CA 90230. (800) 437-4329 ext. 217. In Colorado, (303) 799-4900. In the U.K., (0908) 568866.

ASHTON-TATE □™

© Ashton-Tate 1983.  
dBASE II is a registered trademark of Ashton-Tate.  
dBASE II has a suggested retail price of \$700.

CIRCLE 41 ON READER CARD

# Introducing The ONYX Office.™



The new ONYX Office. It makes everyone in the company think they have their own personal computer.

And with the ONYX Office, even small and medium-sized businesses can enjoy the power and versatility of the UNIX Operating system.

With none of the complexity.

And new, brilliantly designed ONYX computers and terminals put an end to the problems that go with personal computers in the multi-user office: availability and high cost per terminal. The cost of an ONYX system for eleven users? Under \$2000 per user. Much less than eleven personal computers. With remarkable ONYX Office versatility built in. Including:

**ONword.™ The ONYX Office Word Processor.**

A Wang™-like word processor with some even more sophisticated functions, including split windows. Its user menu, and a myriad of screen editing features provide tremendous flexibility in formatting, unmatched by any other system.

**ONbase.™ the ONYX Office Database Management System.**

A fast, powerful relational database system that allows the novice to use it as easily as a professional

## The first integrated office information package for the UNIX™ operating system.

programmer. Applications can be developed, even by the end-user with ONbase non-procedural tools.

**ONmail.™ the ONYX Office Electronic Mail Program.**

ONmail creates, sends, and receives mail, supporting hard copy devices and terminals. It uses mailing lists, storing and retrieving documents. The system notes mail received in the user's inbox.

Summarizes what has been received, what has been read, what requires priority. Provides for certified, confidential and urgent mail.

**ONcalc.™ the ONYX Office Electronic Spreadsheet Program.**

Now anyone can now do forecasting easily using these unique ONcalc features: optional data display in bargraph format, financial and statistical functions, internal rate of return; least squares, present value, standard deviation, and future value. Separate spreadsheets can be merged.

Using the power of the UNIX operating system, files and data can be moved between applications, combining functions of ONword, ONcalc, ONbase, and ONmail.

**ONYX Office CONNEXION.™**

A run-time shell, providing a superfriendly menu and an innovative link between applications. For the software developer and systems integrator the development version of CONNEXION ties vertical applications into the ONYX office to make a complete package.

The Onyx Office, a retail value of \$5,000, is now bundled with every ONYX-UNIX system we ship.

## Make the Connection

# ONYX-UNIX

OPERATING SYSTEM

Onyx Systems, Inc., 25 E. Trimble Road, San Jose, CA 95131  
In Calif. (408) 946-6330, outside (800) 538-6813

Unix System Administration courses now available nationwide. Call Onyx today to register.

UNIX is a trademark of Bell Laboratories, Inc. Wang is a trademark of Wang Laboratories, Inc. ONYX Office, ONbase, ONcalc, ONmail, ONword, and Connexion are trademarks of Onyx Systems, Inc.

CIRCLE 42 ON READER CARD

# Who brings low-cost graphics together with the best names in software?

digital VAX TV/780

EDT Editors	EMACS	VI	WORD-II
SAS Data Analysis	TELL-A-PLAN	DATA CONNECTION	
ANVIL 3900	PATRAN G	SUPERMAN	GEOMOD
ANSYS	TELL-A-GRAPH	SAS GRAPH	
CAD PLOT 10 Easy Graphics II			
Presentation Aids			
Graphic Development			

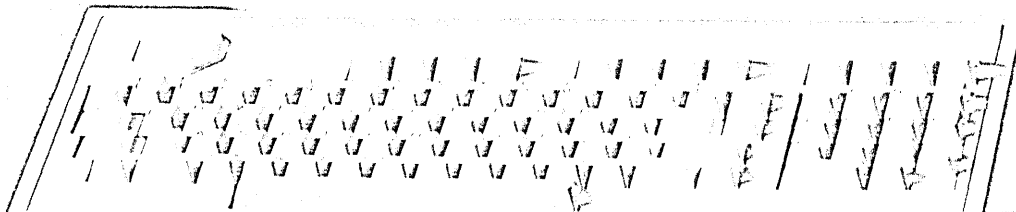
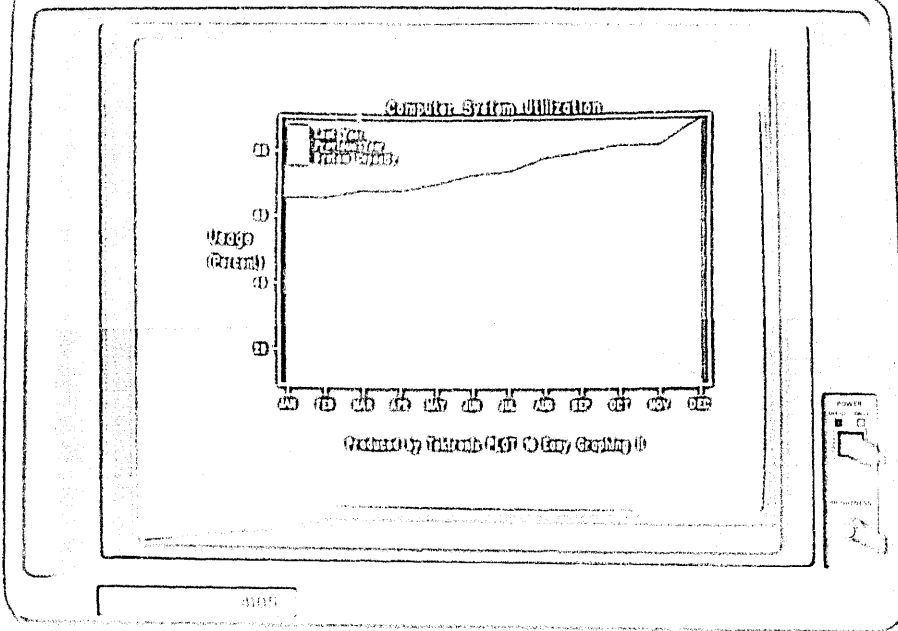

VAX and VAX/80 are registered trademarks of Digital Equipment Corporation. PLOT 10 Easy Graphics II All Rights Reserved. © 1984 Tektronix, Inc. All rights reserved. 010105



# Tektronix.

**No graphics terminals connect you to better utility or applications software, or with a broader range of computers, than Tek's desktop 4100 Series terminals.**

Among the dividends of Tek's long leadership in graphics are the scores of program development tools and powerful applications packages already on-file and immediately compatible with most computers.

From analysis to reporting, cartography to CAD: compatible

software helped make Tek's low-cost 4100 Series an immediate success.

**Major software vendors like ISSCO, SAS, Precision Visuals and many others offer 4100 users flexibility in data analysis and presentation.**

In more technical, engineering and scientific environments, users can take advantage of ANSYS,<sup>™</sup> PATRAN-G,<sup>™</sup> ANVIL-4000,<sup>™</sup> GEO-MOD,<sup>™</sup> Tek PLOT 10 Computer-Aided Drafting and Easy Graphing II.

Tek PLOT 10 graphics development software library is installed on more computers than any other in the world. It now includes the core standard IGL; the new international standard GKS and TCS, nucleus for scores of specialized packages.

**The 4100 Series lets you take full advantage of all these powerful software resources.**

Fast, flexible, and priced fully equipped from just \$3995, quantity one, the 4100 Series

includes VT100 compatibility and ANSI X3.64 text editing right along with its exceptional graphics.

Choose from a range of resolution, segment

It's a very quiet and reliable push-button easy desktop unit that doubles as an alphanumeric printer. Single quantity cost is just \$1595.

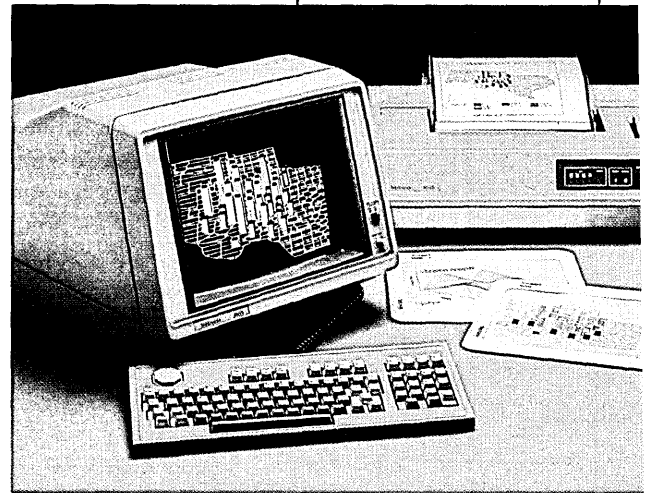

Powerful graphics team with Tek 4695 color copies and transparencies for a complete desktop analysis and presentation system.

memory and color capabilities, backed by performance unique to the price range—including a flicker-free 60 Hz non-interlaced display. 38.4K baud communications. And color manipulation by keyboard function keys.

**The companion 4695 Color Graphics Copier now makes color copies practical.**

Your Tek Sales Engineer can help you find the perfect software for your computer, your needs, and our graphics. For literature or the location of your local Tek sales office, call toll-free: 1-800-547-1512. In Oregon, 1-800-452-1877.

## Call Tek

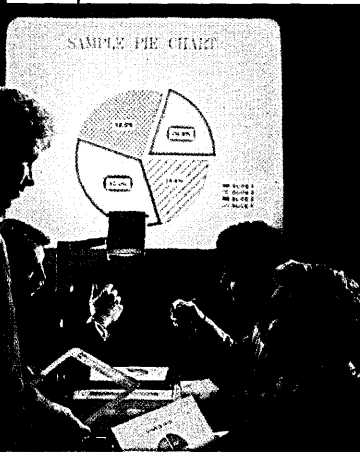

Presentations come alive with the communications impact of full color transparencies that can be produced in minutes.

**Tektronix**<sup>®</sup>  
COMMITTED TO EXCELLENCE

# Fill in your IBM micro/mainframe communications picture.

AST Research, the leader in IBM PC enhancement products, brightens your micro/mainframe communications picture with a full palette of economical, integrated hardware/software masterpieces. With AST Products, you can emulate IBM terminals or create PC-based Local Area Networks.

## AST improves your office operating cost picture.

AST communications products give your IBM PC the flexibility to act as a terminal for your host system or as a stand-alone computer for smaller tasks. Your PC won't bog down the mainframe with unnecessary small jobs and local computing on the PC eliminates phone line charges too. Get the power of a mainframe when you need it and personal computer convenience right at your fingertips.

## Applications solutions that are strokes of genius.

AST keeps pace with your ever-changing applications requirements with reliable, high quality, cost effective communications products. AST products provide support for Bisync and SNA/SDLC communications protocols as well as networking multiple PC's for sharing resources.

## Choose AST products — by the numbers.

These AST communications packages are currently available:

1. **AST-SNA™** emulates a 3274/3276 controller and 3278 or 3279 display terminal using SDLC protocol.
2. **AST-BSC™** emulates 2770 batch RJE and remote 3270 display terminals using 3270 Bisync protocol.
3. **AST-PCOX™** allows your PC to connect to an IBM 3274/3276 cluster controller via coax cable and emulates a 3278 or 3279 display terminal.
4. **AST-3780™** emulates 2770, 2780, 3741, and 3780 RJE workstations using Bisync protocol.
5. **AST-5251™** emulates a 5251 Model 12 remote workstation connected to an IBM System 34, 36 or 38.
6. **PCnet™** is the first Local Area Network designed specifically for the IBM PC or XT and the PC-DOS 1.1 or 2.0 operating system.
7. **CC-232™** is a user-programmable dual-port card capable of communicating in Async, Bisync, SDLC, or HDLC protocols.

CIRCLE 44 ON READER CARD

Discover how well AST can fill in your micro/mainframe communications picture. For descriptive data sheets, write or call: AST Research Inc., 2121 Alton Ave., Irvine, CA 92714. (714) 863-1333. TWX: 295370ASTRUR

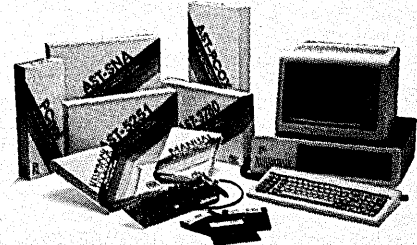

**AST**  
RESEARCH INC.

## Number One Add-Ons For IBM PC.

IBM is a registered trademark of International Business Machines Corporation. PCnet is a registered trademark of Orchid Technology, Inc. AST-3780 is a product developed by AST Research, Inc. and Wilmet Systems, Inc. AST-5251 is a product developed by AST Research, Inc. and Software Systems, Inc. of Jefferson City, MO. PCOX is a product developed by CXI Inc.



## NEWS IN PERSPECTIVE

Unix finally is on the move in the commercial sector.

As AT&T's Scanlon puts it: "What was once a research oddity at Bell Labs has become a major new force in the computer industry." But one abiding question at Unixforum was, "Does AT&T have the legs to keep up with the monster it created in its labs?"

As one Bell Labs attendee so poignantly asks, "How do we learn to run like IBM?" \*

# SELLING SOFTWARE TO GO

**Tymshare faces significant challenges in pioneering the electronic distribution of software to large corporations.**

by Jan Johnson

"It's inevitable. It's an idea whose time has come."

The idea of electronic distribution of microcomputer software has set venture capitalists and industry watchers buzzing. Already more than a dozen new ventures have sprung to life, offering services direct to the home or to retail outlets. Even mass marketers and convenience stores, such as K-Mart and 7-Eleven, have stepped forward to give this new technology a try.

Yet with all their zeal, these ventures have so far missed targeting the large corporations that face a growing army of microcomputers to be managed. Does electronic software distribution solve any problems for MIS managers? Tymshare Inc., Cupertino, Calif., thinks so. Its new InfoTym service, scheduled for testing this summer, appears to be the only electronic distribution scheme aimed specifically at the corporate market.

Tymshare believes that the flood of micros has brought with it a wide range of incompatible and inconsistent software, which has become increasingly difficult to manage. Inconsistent software leads to inconsistent data and a breakdown of the corporate data structure, argues Mike Nason, Tymshare's manager of teledistribution management.

"We are looking at serving the MIS manager who has people getting software from everywhere," he explains.

Without some kind of control over micro software, "users could be working with different spreadsheet products or different versions of the same product, and everyone could be manipulating their data

# TOMORROW'S LEADING SOFTWARE PROFESSIONALS ARE EARNING M.S.E.'S TODAY.

At the Wang Institute of Graduate Studies, students in the Master of Software Engineering (M.S.E.) program are preparing for positions of increasing technical and managerial responsibility. Students at the Wang Institute:

- study technical and managerial aspects of software development and maintenance;
- learn to plan, organize, and supervise software projects;
- work in teams in a cooperative environment;
- use a large and growing collection of software tools to analyze, specify, design, implement, test, integrate, and modify software products;
- acquire the theoretical foundations needed to assess new developments and stay current following graduation;
- interact closely with faculty members who have significant industrial and academic experience in software engineering; the current student/teacher ratio is 7 to 1.

Both full-time and part-time programs of study are available. More than 20 companies are currently sponsoring students at the Wang Institute. Graduate assistantships are available for unsponsored full-time students.

Educational programs at the Wang Institute are open to all qualified applicants. For more information, call or write:

Janis Ackerman  
School of Information Technology  
Wang Institute of Graduate Studies  
Tyng Road  
Tyngsboro, MA 01879  
Telephone (617) 649-9731

D 384

Please send me additional information about the school's Master of Software Engineering degree program.

Name: \_\_\_\_\_

Business \_\_\_\_\_

Address: \_\_\_\_\_

\_\_\_\_\_

\_\_\_\_\_

Home Phone: \_\_\_\_\_ Bus. Phone: \_\_\_\_\_

Yrs. software development exp.: \_\_\_\_\_

Degree(s): \_\_\_\_\_ Field(s): \_\_\_\_\_



## NEWS IN PERSPECTIVE

differently. The same piece of corporate data could be going through several different programs and giving several different answers," Nason states.

Nason views InfoTym as a way of cracking down on the influx of incompatible software. The service could act as an on-line software catalog, giving MIS managers a means of centralizing their control over micro software. Only software listed in the catalog would be purchased by a corporation's employees. Titles could be easily changed, removed, or updated to provide

a current selection, and custom programs written by the MIS department could be included beside commercially available titles.

### InfoTym is intended to help MIS managers crack down on the influx of incompatible microcomputer software.

titles. Through automatic downloads performed at night, or through a memo telling all users when to "pick up" their software, the nightmare of maintaining many differ-

ent programs begins to fade away.

"I think [electronic distribution] is a great idea," comments Duane Maas, an in-house microcomputer consultant for Montgomery Ward in Chicago. He estimates that by year-end his company will have some 450 micro users. "I can't manage 400 people," he says.

The InfoTym service is designed to aid users such as Maas by acting as a cross between "a library and a copy center," Nason says. The service allows end users to place calls to the InfoTym computer center from standard terminals, such as VT-100s, or from microcomputers. They would be connected to a corporation-specific library of software titles, established by the subscriber firm's MIS department. End users could then make selections, and the program would be downloaded to a "master" computer or disk-copying unit located either in the firm's dp shop or in its in-house computer/software store, Nason suggests.

At the core of the electronic distribution service is a dedicated order processing computer programmed to track "who bought what, when" and to produce audit trails and accounting records. After an order is processed, the transaction is sent to a file server, which holds master copies of all software packages in the catalog. The file server copies the requested program, and either sends the copy to a customer's computer or writes it to disk for shipment.

At present, there is only one file server, and it is hardwired to the order processing computer. In the future, Nason says, remote servers will be located at customer locations as masters and connected to the central order processor located at Tymshare's Cupertino headquarters.

If Tymshare is to succeed with InfoTym, it must overcome three major hurdles that face all would-be electronic software distributors. It must secure contracts allowing it to distribute the most popular software currently sold through other channels; learn how to ship software instantly while delivering supporting documentation more slowly; and come to grips with the possibility of reviewing software for users.

Perhaps the most challenging hurdle before Tymshare is the search for and signing of quality titles. Electronic distribution has met with a cool reception from those who own rights to the most coveted software packages.

"Publishers aren't ready for this," observes Roger Collins, chairman and president of Xante Corp., a Tulsa, Okla., electronic distributor of games and home software packages. "It's a mind-set change for them. Although they knew electronic distribution was coming, most thought it was at least five years away. But it's not; it will be here in 1984."

Dave Wagman, chairman of Softsel Computer Products, the huge Inglewood,

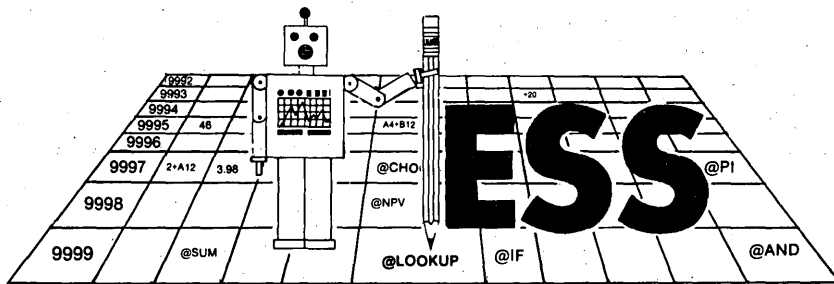

## Electronic Spread Sheet for VM/CMS & MVS/TSO - Not Just Another CALC -

**Powerful** - Spreadsheet size is limited only by available virtual storage. ESS easily handles spreadsheets with thousands of rows and/or columns.

**Proven** - Already in use at over 100 installations.

**Compatible** - ESS accepts the same commands as VisiCorp's VisiCalc® program for microcomputers. A person familiar with VisiCalc® can be using ESS productively in minutes. In addition, ESS can load and save files in VisiCalc® format.

**High Performance** - Assembler language code and sophisticated storage management techniques give you fast response, even with very large spreadsheets.

**Easy to Install** - Just load the ESS program. No additional program products or languages are required.

**Cost Effective** - ESS gives all your users access to personal computing capabilities for just \$220 per month. Compare that to the cost of buying hundreds of microcomputers.

**Questions?** - For more information about ESS, or to arrange a 30-day free trial, call or write TRAX.



TRAX Softworks, Inc.  
10801 National Blvd., Suite 205  
Los Angeles, CA 90064  
(213) 475-8729

CIRCLE 46 ON READER CARD

# Now Wang gives you office automation on a platter.



Introducing Wang Office.  
It's the kind of comprehensive office software and communications package only Wang could put together:

Because only Wang can bring you the most advanced electronic mail. Only Wang can bring you the newest in time and task management. Only Wang can bring you the industry's best word processing.

And only Wang can put all of this together with the world's most advanced communications in one flexible package — easy to put in place and virtually transparent to the user.

With Wang Office you can not only process information, you can send it to, or retrieve it from, any office, anywhere in the world.

Instantly.

Wang Office. Thirty years of commitment, innovation and technology.

Yours.

On a platter.

For more information on Wang Office, call 1-800-225-9264. Or write to: Wang Laboratories, Inc., Business Executive Center, One Industrial Avenue, Lowell, MA 01851.

## WANG

**The Office Automation  
Computer People.**



**“In your development center, ADS/OnLine will increase productivity and reduce your company’s applications backlog.”** —Don Heitzmann\*

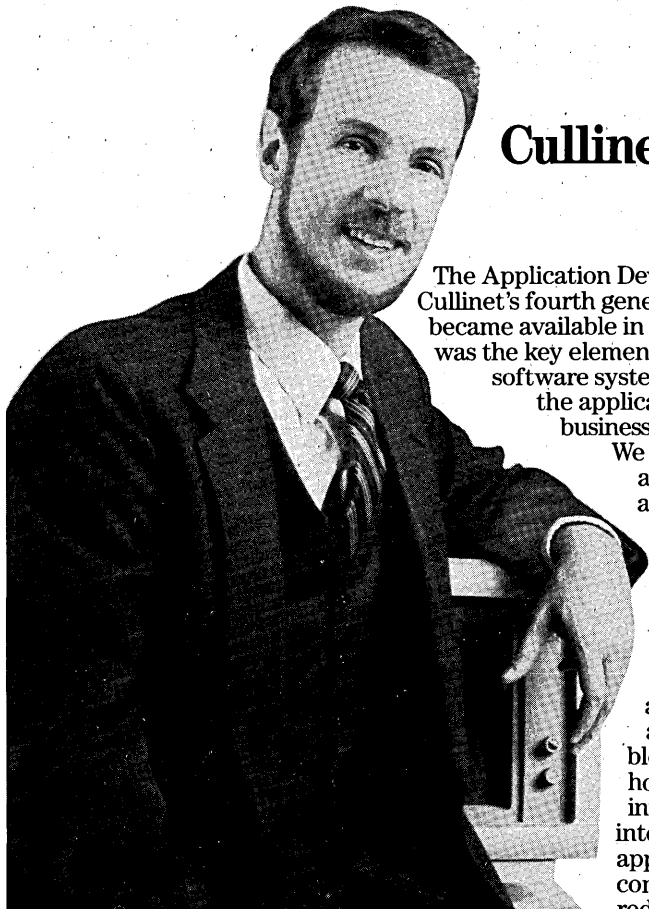

## Using ADS/OnLine Cullinet created the best applications software ever built.

The Application Development System, Cullinet’s fourth generation language, became available in 1981. ADS/OnLine was the key element in our database software system needed to address the application software business in a whole new way.

We set out to develop advanced financial and manufacturing applications; applications designed in the 1980’s all built using this fourth generation language. Today, Cullinet offers the finest financial and manufacturing applications available, featuring both horizontal and vertical integration. Horizontal integration means that all applications share a common database so redundancies and

inconsistencies are eliminated. Vertical integration means all applications are built using ADS/OnLine and advanced database technology so they are easier to install, tailor and maintain.

Using ADS/OnLine, we developed advanced applications much faster than if we used traditional methods. In your development center, ADS/OnLine can increase productivity and reduce your company’s backlog.

ADS/OnLine eliminates up to 70% of the lines of code in a typical COBOL program. This can result in a dramatic increase in programmer productivity. In addition, ADS/OnLine is easily learned by COBOL programmers, so your programming staff can become more productive in less time.

Applications can be built more efficiently with ADS/OnLine because it is a non-procedural language. The developer simply paints the screens on a terminal and fills in the blanks to define the applications program. Plus, automatic editing and automatic error handling detect input errors with no code written at all. And the complete integration of ADS/OnLine, with all Cullinet database facilities, not only ensures control over the application development function, but also guarantees the performance necessary to run these applications in day-to-day operations.

ADS/OnLine has been a key to our success in applications software. It could do the same for you in establishing new information systems and eliminating your applications backlog in the 1980’s and 1990’s.

Attend a comprehensive seminar explaining this advanced fourth generation language and Cullinet’s other database software products. To participate in one of the 700 Cullinet seminars scheduled internationally, send in the coupon or call 1-800-225-9930. In MA, 617-329-7700.

Computer \_\_\_\_\_  
Name/Title \_\_\_\_\_  
Company/Department \_\_\_\_\_  
Address \_\_\_\_\_  
City \_\_\_\_\_  
State \_\_\_\_\_ Zip \_\_\_\_\_  
Phone ( ) \_\_\_\_\_

Mail to: Cullinet Software, Inc., 400 Blue Hill Drive, Westwood, MA 02090-2198 Attn: Corporate Meetings  
Cullinet Software products are designed to run on IBM 360/370, 30XX or 43XX or plug-compatible computers.

3/84 DM

# Database: Cullinet

© 1984 Cullinet Software, Inc., 400 Blue Hill Drive, Westwood, MA 02090-2198

CIRCLE 48 ON READER CARD

## NEWS IN PERSPECTIVE

Calif., distributor, agrees with Collins to a degree. Publishers are reluctant, he says, but they are not deaf to the idea. "They are taking a wait-and-see attitude. Most, if they can be convinced that they are not cutting their own throats, will go for the incremental revenue" promised by electronic distribution, he claims.

Wagman is pragmatic about the issue. "If [electronic distribution] makes sense, it will happen. We see it as an opportunity for the future." Others in the ranks of software distributors have adopted a more militant attitude, urging their colleagues to "band together and fight this thing," several industry sources confirm.

Tymshare is behind the titles signing game. It does not have a well-conceived vendor strategy, and it has been slow to take the titles issue seriously. In contrast, Gimcrax, a McLean, Va., startup that has targeted low-end software and home delivery as its market, took a keen interest in that aspect of the business early on. "We created a department that does nothing but massage vendors," says Nat Forbes, Gimcrax's founder and president. Forbes claims his company has signed on 20 titles, all from the Softsel hot 100 list. Many of these may be public domain software, warns Esther Dyson, editor of *RELEASE 1.0*, a computer industry newsletter. The more important consideration is the quality of the software, not the amount.

Documentation is the second blemish on the rosy face of electronic distribution. It may not become a critical issue in

### Perhaps the most challenging hurdle facing Tymshare is the search for and signing of quality software titles.

the corporate environment, however, because management can exert control over the training of users and the timing of software delivery. But it is a problem at the retail end of the business and can infiltrate MIS departments through retail channels.

"You've got to ask yourself," suggests Softsel's Wagman, "does a customer want to buy a part now and get the rest later? Then why not get the whole thing later, the packaging, the keyboard template, the documentation, and whatever else goes with the diskettes?" Even within retail channels, this issue may fade, as more authors and publishers add on-line documentation, on-line training, and on-line help facilities to reduce the user's dependence on accessory items.

InfoTym and other electronic distribution strategies also face challenges posed by electronically delivered software evaluation services. "An evaluation service is something I want more than anything," says a swamped Earl Mott, in-house micro-computer consultant for Deere & Co., Mo-

line, Ill. Maas of Montgomery Ward also hails a review service as an essential part of an electronic distribution scheme. "A service that would let me try out new software packages without laying out \$400 to \$500 per package—that would be great."

Tymshare, however, chose not to offer an evaluation service as part of InfoTym's repertoire. It's a "low priority" item, Nason confirms—especially since the firm can refer requests for such a service to an outside source, Softyme Inc.

Softyme, a San Francisco-based

startup cofounded by former Tymshare executive Bob Colten, has been working for more than a year with Tymshare to develop a version of InfoTym targeted at the retail market.

The Bay Area firms appear to have divvied up the market according to their strengths and interests. "The Fortune 500 companies—that's a different kind of sell. We don't know how to do that," says Tom Hargadon, Softyme's chairman. Instead, Softyme is intent on building an end user software delivery system for computer

# NOW YOU CAN ADD IBM® 3270 TERMINALS IN MINUTES INSTEAD OF DAYS.



PATENT PENDING

### Introducing the Coaxial Doubler™ from Fibronics. Try it for 30 days. Free.

With a pair of new Coaxial Doublers from Fibronics, you can add or move an IBM 3270 terminal or printer anywhere you want in minutes! And without technical assistance.

That's because Doublers support two terminals on one existing coaxial cable. And they're as easy to install as a lightbulb.

You don't waste time and money waiting for someone else to pull a new dedicated cable.

### Anyone can install the Doubler.

No special tools, software, set-up or adjustments are necessary. Just plug three cables into each Doubler unit. One Doubler connects the controller to the shared cable. The other Doubler connects the shared cable to two terminals.

What's more, Doublers are extremely compact, maintenance free and require no electrical power.

### The Doubler is transparent to your IBM terminals and printers.

Doublers support the full speeds of IBM terminals at distances up to 5,000 ft. With absolutely no degradation of response time and no changes to hardware or software.

### Call toll free 1-800-342-5986 for a free 30-day trial.

Doublers cost only \$490 a pair and are covered by a full five-year warranty.

They also come with a free 30-day trial. Call now and we'll send you a set of Coaxial Doublers within 48 hours, complete with connecting cables if needed.

Don't think twice. Order yours today. And the next time you add or move a terminal, turn waiting time into working time.

## Fibronics

International Inc.

fiberoptic communications

218 West Main Street, Hyannis, MA 02601 Telephone: 617-778-0700 Telex: 951297

IBM® is a registered trademark of the International Business Machine Corporation.

CIRCLE 49 ON READER CARD

MARCH 1984 81

**NOW CCA'S  
MODEL 204 DBMS  
CAN DO SOMETHING  
EVERY EXECUTIVE  
CAN APPRECIATE.**

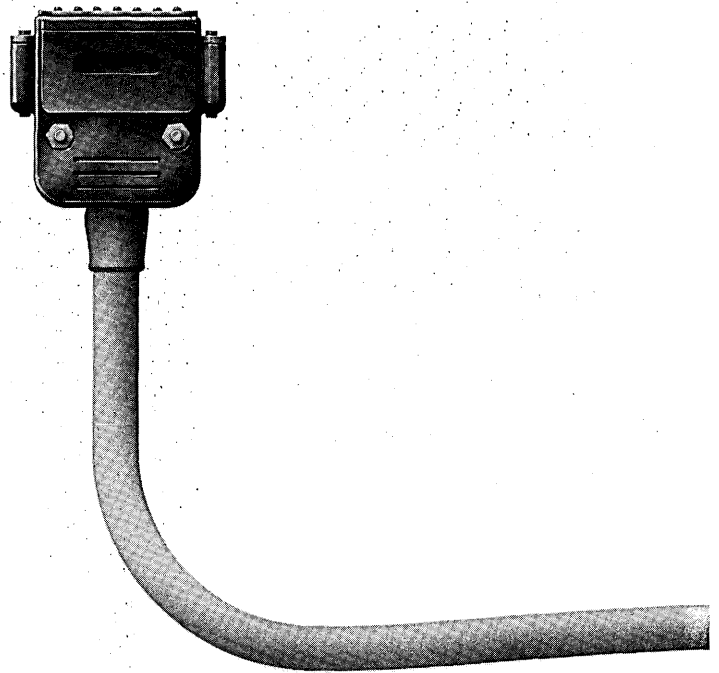

# TALK SENSE TO THE IBM PC.

Introducing PC/204, a link that lets PC users turn mainframe data into spreadsheets effortlessly.

PC/204, the newest productivity tool from Computer Corporation of America, is a powerful, efficient, easy-to-use software link between IBM personal computers and mainframes. It effectively answers the pressing problem of how to let corporate managers take full advantage of today's personal computers for making decisions, while also giving them access to the corporate database in a format they can use.

First, PC/204 guides PC users as they browse through the MODEL 204 database. Then it extracts the data they need and converts it into meaningful management information for spreadsheet analysis. Lotus 1-2-3 for example. And PC/204 does all that automatically. Without the PC user having to understand anything about mainframe technology.

If you aren't already using Lotus 1-2-3, we can supply it along with PC/204. Or you can use any current IBM PC business package.

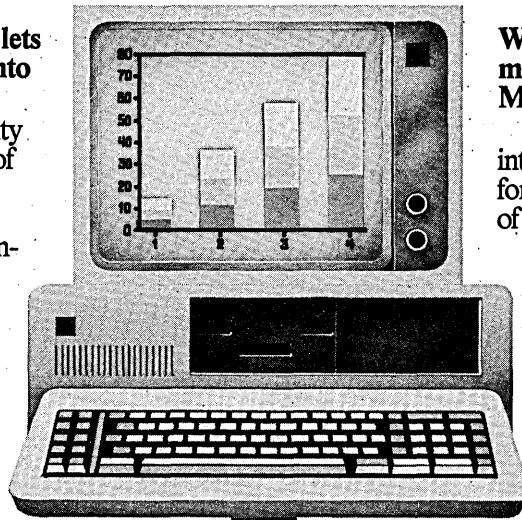

While PC/204 is helping business managers, it's also helping MIS directors.

PC/204 uses the power and intelligence of the personal computer for increasing the overall efficiency of an application.

For one thing, it improves performance of the mainframe by off-loading some of the processing to the PC, while reducing PC users' response time. It also makes communication between the PC and the mainframe more efficient.

What about security and control? PC/204 provides individual management views of the corporate database while still allowing PC users access to all the information they need.

PC/204 is the latest reason to get MODEL 204 DBMS which has been so highly rated for performance and programmer productivity.

For more information or to arrange for a demonstration of PC/204's capabilities, simply return the coupon or write to us on your letterhead.

## Computer Corporation of America

### CCA's Executive DBMS Seminar Schedule

March					
Columbus, OH	Mar. 1	Tallahassee	Mar. 14	San Diego	Apr. 12
Detroit	Mar. 22	Tulsa	Mar. 1	St. Louis	Apr. 18
Hartford	Mar. 15	<b>April</b>		Washington, D.C.	Apr. 4
Honolulu	Mar. 22	Albany	Apr. 26	<b>May</b>	
Houston	Mar. 29	Anchorage	Apr. 12	Atlanta	May 15
Jacksonville	Mar. 13	Boston	Apr. 12	Austin	May 10
Louisville	Mar. 6	Cleveland	Apr. 19	Baltimore	May 15
Minneapolis	Mar. 9	Dayton	Apr. 26	Charlotte, NC	May 8
New York	Mar. 27	Little Rock	Apr. 5	Cincinnati	May 2
Pittsburgh	Mar. 13	New Orleans	Apr. 5	Ft. Worth	May 3
Portland, OR	Mar. 29	Norfolk	Apr. 10	Harrisburg	May 2
Richmond	Mar. 20	Philadelphia	Apr. 3	Milwaukee	May 3
Rochester	Mar. 22	Phoenix	Apr. 19	Orange City	May 24
Saddle Brook, NJ	Mar. 6	Princeton	Apr. 10	Pittsburgh	May 8
Salt Lake City	Mar. 7	Raleigh	Apr. 10	Santa Clara	May 24

Yes, please tell me more about: ( ) PC/204 ( ) MODEL 204 DBMS

- ( ) Send me a brochure.  
 ( ) Send me info on free DBMS seminars, or call our seminar coordinator.

NAME \_\_\_\_\_ TITLE \_\_\_\_\_

COMPANY \_\_\_\_\_

ADDRESS \_\_\_\_\_

CITY \_\_\_\_\_

STATE \_\_\_\_\_ ZIP \_\_\_\_\_

TELEPHONE \_\_\_\_\_

Operating System: ( ) MVS ( ) DOS ( ) CMS ( ) Other: \_\_\_\_\_

Computer Corporation of America  
 Four Cambridge Center, Cambridge, MA 02142 (617) 492-8860

DM3PC

## NEWS IN PERSPECTIVE

stores, called the Express.

The Express is an intelligent terminal that contains a list of available software titles and a number of selection aids, such as written reviews and canned demonstrations. Based on the IBM PC XT, it produces an order entry screen for customers.

After the order is taken, the transaction is handed off to the master unit in the retail store or in the MIS department. The master places a call to Tymshare's order processing computer and receives the output. Up to six Expresses can be connected to one master.

The Express is to have answers for the 10 most asked questions associated with software programs listed in the catalog. It also will keep track of reported bugs. Softyme says it intends to forward reports of bugs to software publishers periodically as part of its vendor relations strategy.

Softyme's retail distribution service will be brought up on InfoTym before Tymshare launches its corporate version this summer. While Tymshare has yet to put a price tag on its corporate service, Softyme is quoting \$3,000 for the initial investment and \$300 per month to cover updates to the software catalog and selection aids.

Each company has agreed to license its technology to the other. As a result, Tymshare expects to be selling master units and some Express units to its corporate customers. Both companies hope to package their combined efforts and sell the total service to other concerns, such as Radio Shack and Xerox computer stores. Softyme is focusing its efforts on computer and software store chains, such as Businessland and Computerland.

Although the outlook appears bright for electronic distribution services, InfoTym's lifespan could be short. The history of the timeshare business suggests that the

dp industry is going in-house with its services. Users may perceive InfoTym as a short-term fix while they develop a long-term micro-to-mainframe integration strategy. Once that strategy is installed, the thought goes, the electronic distribution services—but not the software review services—would be brought directly under MIS control.

Tymshare is prepared for that to happen, Nason says. When a customer is ready to move its software distribution service in-house, Tymshare is prepared to license InfoTym software to that customer. Now, however, users are just beginning to experiment with the possibilities of electronic software distribution, so the process of adopting such a technology throughout the company and then moving it in-house seems to be sometime off.

## DATABASE MANAGEMENT

# RDBMS: IS NOW THE TIME?

**Vendors think so, but they are still striving for improvements in operating speed.**

**by Edith Myers**

Ease of use is what most vendors are claiming for their products, and what most users seem to be seeking among data processing wares. Purveyors of relational database management systems believe this, and so believe their time has come.

## SPEED LIMITS

The success of Tymshare's InfoTym service depends partly on AT&T. Currently, data move from the order site to InfoTym at a paltry 9,600bps, at which rate today's sophisticated forecasting programs can take over three minutes to transmit. The cost of telephone lines and the inconvenience of tying up the file server at the customer end for such a long time for each program—given the high volume of software shipments Tymshare expects—could prove a significant detriment to the whole service. Yet Tymshare's file server is capable of moving data at 56Kbps.

The catch is that the firm cannot move up to that rate until AT&T gets out its new CSDC (circuit switched digital capability), a shared switched network that sends digital instead of analog signals over twisted pair.

According to Mark Mortensen, CSDC project manager, special equipment is

required at both the sending and receiving sites and at central switching offices.

AT&T sources say the technology is ready to go. The holdup is the Federal Communications Commission. FCC wrinkles are expected to be ironed out within six months, at which point the decision to offer CSDC will rest in the hands of the local operating companies.

The newly divested companies may have their hands full with CSDC, however. The alleged advantage of the service is that it runs over plain old twisted pair—but that twisted pair better not be too old or there could be big noise problems, AT&T sources say. Many locales may have to be rewired before the service can be installed, these sources acknowledge. Despite these problems, those in the electronic distribution business are watching developments with an eager eye.

—J. J.

## PRINTRONIX

### DOMESTIC DISTRIBUTOR TERRITORIES

NM: El Paso Cty, TX  
BFA Corporation  
(505) 292-1212 TWX/TLX: 910-983-1157  
PR: VI  
Computec Systems Corp.  
(809) 781-7880 TWX/TLX: 325-2326  
N. DE; S. NJ; E. PA  
Denco Data Equipment  
(215) 542-9876 TWX/TLX: 510-661-0638  
N. IA; MN; ND; SD; W. WI  
Dytec North  
(612) 645-5816 TWX/TLX: 910-563-3724  
S. IL; S. IA; KS; MO; NE  
Dytec South  
(314) 569-2990 TWX/TLX: 910-764-0840  
AL; FL; GA; LA; MS; NC; SC; TN  
Gentry Associates  
(305) 859-7450 (800) 432-2226 (Florida)  
TWX/TLX: 810-850-0136  
CA; N. ID; NV; OR  
Group III Electronics  
(213) 643-6997 TWX/TLX: 910-348-7103  
N. NJ; NYC  
Logon/TMA  
(201) 646-9222 TWX/TLX: 710-991-9710  
KY; MI; OH; W. PA; WV  
Lowry & Associates  
(313) 227-7067 TWX/TLX: 810-242-1519  
S. DE; MD; VA; DC  
Mesa Technologies, Inc.  
(301) 948-4350 (800) 638-2039  
TWX/TLX: 710-828-9702

NY State  
NACO Electronics  
(315) 699-2651 TWX/TLX: 710-541-0439  
AZ; S. ID; MT; VT; WY  
Par Associates  
(303) 371-4140 TWX/TLX: 910-932-0180  
N. IL; IN; E. IA; E. WI  
Peak Distributors, Inc.  
(312) 255-0707 TWX: 910-687-2267  
HI  
Peripherals of Hawaii  
(808) 538-7797  
CT; ME; MA; NH; RI; VT  
S & S Electronics  
(617) 458-4100 TWX/TLX: 710-343-3456  
AK  
Sector Systems  
(907) 276-8825  
AR; OK; TX  
U.S. Data Associates  
(214) 680-9700 TWX/TLX: 910-867-4838

## PRINTRONIX

### SALES OFFICES

**Atlantic Regional Office**  
Printronic  
7½ Harris Road, Nashua, NH 03060  
(603) 888-6140 TWX: 710-228-8017

**Central Regional Office**  
Printronic  
700 E. Ogden, Suite 202, Westmont, IL 60559  
(312) 325-3662 TWX: 910-651-0116

**No. Calif. District Office**  
Printronic  
50 W. Brokaw Road, Suite 64, Rm. 101  
San Jose, CA 95110  
(408) 297-8045 TWX: 910-338-2290

**Southeast District Office**  
Printronic  
P.O. Box 12008, 8000 S. Orange Ave., #109  
Orlando, FL 32809  
(305) 859-5574 TWX: 810-850-0240

**Southwest District Office**  
Printronic  
9451 LBJ Freeway, Suite 220, Bldg. B  
Dallas, TX 75243  
(214) 680-3168/3169 TLX: 758-760

**Western Regional Office**  
Printronic  
17500 Cartwright Road, P.O. Box 19559  
Irvine, CA 92713  
(714) 863-1900 TWX: 910-595-2535

## PRINTRONIX

### INTERNATIONAL OFFICES

For names and addresses of International Offices and Distributors, contact Printronix International Headquarters:

Printronic  
17500 Cartwright Road, P.O. Box 19559  
Irvine, CA 92713 U.S.A.  
(714) 863-1900 TWX: 910-595-2535



Now, there's a full line of band printers with the same performance you've come to expect from Printronix.

The Printronix DataPrinter™ Series.

With precisely formed characters even through six-part forms, our data printers consistently deliver Printronix quality.

Printronix versatility means interchangeable print bands for multiple type styles and a choice of four quiet DataPrinter models: 600, 750, 1000 or 1200 lines-per-

minute models for high volume super-mini and mainframe output.

Because high speed is no speed when the printer is down, Printronix reliability is built into the DataPrinter Series. With an average of six months between service calls and over 90% parts commonality, maintenance costs are surprisingly low.

And service takes only minutes, so our data printers keep performing. A digital display panel alerts the operator while a unique rear control panel and door allow

the operator or service rep to quickly access the printer.

Now, you can call Printronix for not only top quality matrix line printers but for the best of the band. The DataPrinter Series.

THE FIRST LINE IN PRINTERS.

**PRINTRONIX**

For more information, contact Printronix at 17500 Cartwright Rd., P.O. Box 19559, Irvine, CA 92713, 714-863-1900. TWX: 910-595-2535. Outside California: 800-556-1234, ext. 66. In California: 800-441-2345, ext. 66.

# THE ONLY BAND PRINTER GOOD ENOUGH TO BE PRINTRONIX.



See us at INTERFACE® '84, March 12-15, Las Vegas Convention Center, Booth #884.

CIRCLE 51 ON READER CARD

# You Decide.

If you want opportunity and challenge,  
the choice is Tandem.

We pioneered the field of fault-tolerant computing. And, with our new TXP\* system, we've taken on-line transaction processing further than anyone had imagined.

As careers go, however, what makes Tandem different—and, we believe, better—is that we support the notion that the essence of success in our business is founded in opportunity and challenge for each of us:

## Data Base Management

### Relational Data Base Management

- Design and implementation of full relational capabilities for Tandem's data base software
- Experience implementing data base management systems, data/system dictionary systems, and/or data manipulation interfaces
- Architectural and/or design experience in the above areas is also desirable

## Diagnostics

### Diagnostics Technical Leader

- Define on-line diagnostic architecture, design methodology and tests for fault-tolerant systems
- BSEE required with custom VLSI background and management experience
- MSCS/EE desirable

## Quality Assurance

### Software QA Technical Leader

- Provide leadership to a team of QA developers as an integral part of the software development process
- Experience in quality assurance and knowledge of data base management or operating systems desirable

### Software QA Developer

- Provide input to the software development process to help ensure high quality new products
- Provide tools and formulate assurance procedures
- Experience in quality assurance and knowledge of data base management, operating systems, data communication, or compilers desirable

## Data Communications

- Develop and enhance software for networking, network management, terminal access methods, link level protocols, facsimile interfaces, and satellite earth station interfaces
- Positions require experience developing communications software. Specific experience with X25, SNA, NCCF/NPDA, SDLC, BSC, Group III facsimile, or earth station control is highly desirable

## Operating Systems

- Design, develop, and debug operating systems software
- 5+ years' experience in operating system development required
- Kernel design experience desirable

## Processor Microcode

- Design and develop processor instruction set and I/O channel microcode
- Requires 5+ years' experience including parallel microcode development

## Languages

Several positions available for developing/enhancing production quality compilers for COBOL, FORTRAN, and block-structured languages. Requires 1-5 years of compiler writing experience using automatic Parser-generator techniques.

Call Joy Mar COLLECT at (408) 725-5097 for more details about these positions, and about our 6-week paid sabbaticals. Or send your résumé to her attention, Tandem Computers Inc., Dept. 3/10, 19333 Vallco Parkway, Cupertino, CA 95014. We are an equal opportunity employer.

Principals only, please.

# TANDEM

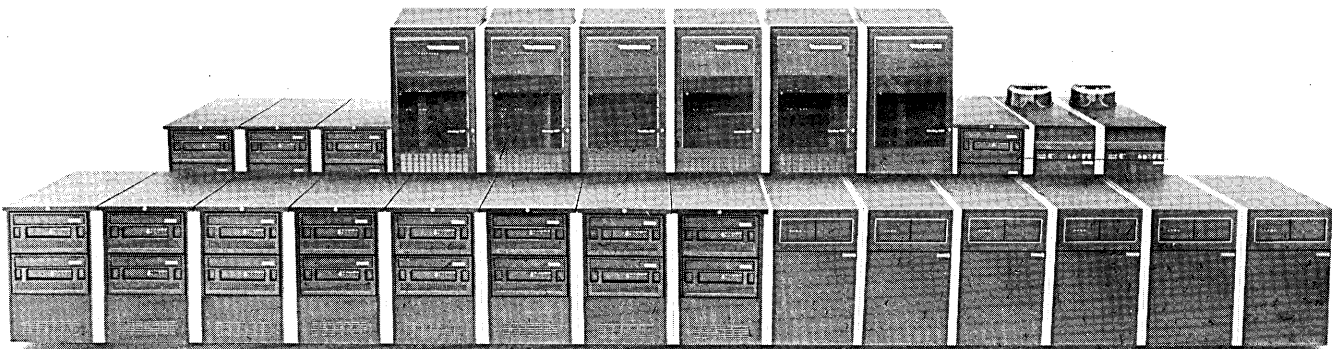

Makers of TXP, the most powerful on-line computer in business today.

\*Trademark of Tandem Computers Inc.

# A 60% faster terminal response time can give you the edge in the processing race.



## The quickest way to break bottlenecks.

A manufacturer experienced serious growth problems. Troublesome data bottlenecks were wasting valuable time and money. We put our 4305 Optimizer to work. It's a solid state I/O subsystem designed to bring relief to overworked systems.

### The results?

A 66% reduction of online response time, at a 16% increase of online transactions. Most importantly, a 22% increase in prime shift CPU usage. Our customer expanded the CICS online network from 280 to 400 terminals. The bottleneck had finally been broken.

These impressive results led to an important decision: rather than buying a new CPU or adding more costly memory, the Optimizer was installed.

## The best way to manage heavy traffic.

This service company had a great number of TSO customers. Too many, it seemed, because their system couldn't handle the work. At first, our customers looked at a new CPU—a major step. Then they let us show them what our Optimizer could do.

The results: a 35% improvement in overall performance. And a consistent response rate which is characteristic of our Optimizer. They saved 30% to 40% on response time and even more during peak usage. In fact, our Optimizer proved most valuable during times of the heaviest TSO traffic.

## Optimizing your system is the way to go.

These are just two examples of what our 4305 Optimizer can do for you. If your business is having growing pains, our

Optimizer offers speedy relief. More productivity. More reliability. More power savings. Increased storage capacity—up to 192 MB. Greater flexibility through 2305 or 3380 emulation, all transparent to your system. In addition, you get the support and service you can count on.

We rest our case.  
Storage Technology Corporation,  
Louisville, CO 80028;  
Phone: (303) 673-4063

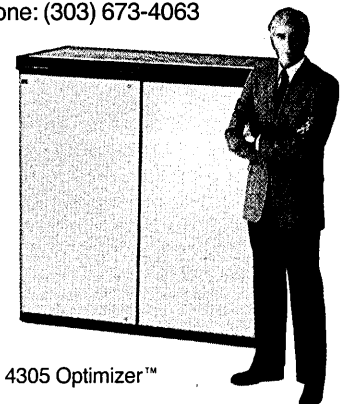

The 4305 Optimizer™

## Storage Technology

CIRCLE 53 ON READER CARD

## NEWS IN PERSPECTIVE

Microdata Corp., Irvine, Calif., with its Jan. 30 announcement of the Microdata 1000 workstation, made much of the fact that it provides a relational database. "This means inexperienced computer users can search for and retrieve virtually any information without complicated commands or specialized programs," said the company.

As with most of the easy-to-use features in data processing, relational data-

### **The emphasis in a relational system is on end user problem solving.**

bases were born of complex research done, for the most part, in universities. One such project was Ingres, begun in the mid-'70s at the University of California at Berkeley. It was pure research.

"Relational database is an answer," Michael Stonebraker, a UCB professor involved in the project, said in the late '70s. "Now what is the question?"

Stonebraker subsequently went on to help found Relational Technologies Inc. (RTI) of Berkeley, one of a growing number of companies that think they have found the question or questions.

RTI was formed in 1980 by Stonebraker, Gene Wong, and Larry Rowe, all of UCB. Stonebraker and Wong are still on the school's faculty in addition to their connection with the commercial firm.

What RTI did was to take the UCB Ingres relational database management system, then in the public domain, rewrite it for portability, and add function for commercial appeal.

Another move toward commercial appeal was the appointment last December of 16-year IBM marketing veteran Peter Tierney as vice president of marketing. Tierney's charter is wider penetration of commercial mainframe markets and of the micro market, which RTI entered late last year with MicroIngres.

The most touted feature of relational database systems is data independence, which facilitates changing the database and programs after an application is implemented. A relational database has only one data structure, a table with records and field that can be subdivided and/or linked by a common item. With the older and more widely used hierarchical database management systems, users have to know how data are stored. With relational systems they don't, which makes data extraction easier.

Industry observers point out that the relation database concept was first put forth by Ted Codd of IBM more than 10 years ago, but only in the past few years has the idea been made commercial. This trend began about the time IBM first unveiled Query-by-Example, a mainframe system originally designed as a test of relational concepts. Soon after that unveiling, mainframe DBMS vendors touted their own relational enhancements to current products and the host of mini- and micro-based RDBMS systems began to emerge.

Last June, IBM signaled a full force move into the relational arena with its introduction of DB2, a mainframe database package that won't replace IMS but will have access to IMS files.

Some 30 relational systems have been introduced into the personal computing market, although only a few of them have made any appreciable penetration. The relational system's operating characteristics—namely, a large consumption of computing time—have made it largely impractical on microprocessor-based systems.

"The more complex the transaction, the better our product performs," says Tierney, adding, "this has been great for our initial markets, the industrial and scientific research users." A constraint to date, he admits, has been operating speed, but he feels this will soon be overcome. "There are no technical barriers. We know we can increase the speed by a factor of two in the next six months."

Joaquin Miller, vice president, Pacific Software Manufacturing Co., another Berkeley company offering a relational da-

### **Britton Lee's database machine was used by a Houston company to put some 15 million records on-line.**

tabase manager, likens a hierarchical database to an organizational chart. "With relational databases we go back to the idea of file cards. All linkages are implicit in the data. It's a join operation, a card collator."

The emphasis in a relational system, he said, "is on end user problem solving. Users can get their applications on-line and avoid the programming bottleneck at the computer center. This is because a relational database operates in terms a nonprogrammer can understand."

Pacific's Sequitur software is designed expressly for the office environment that incorporates word processing. Pacific was founded in 1981.

Where Berkeley is home to two of the early RDBMS contenders, Silicon Valley, to the south, claims three. Oracle Corp., Menlo Park, sells a package called Oracle, which comes in versions for large IBM mainframes, PDP-11s, and 16-bit micros running under Unix.

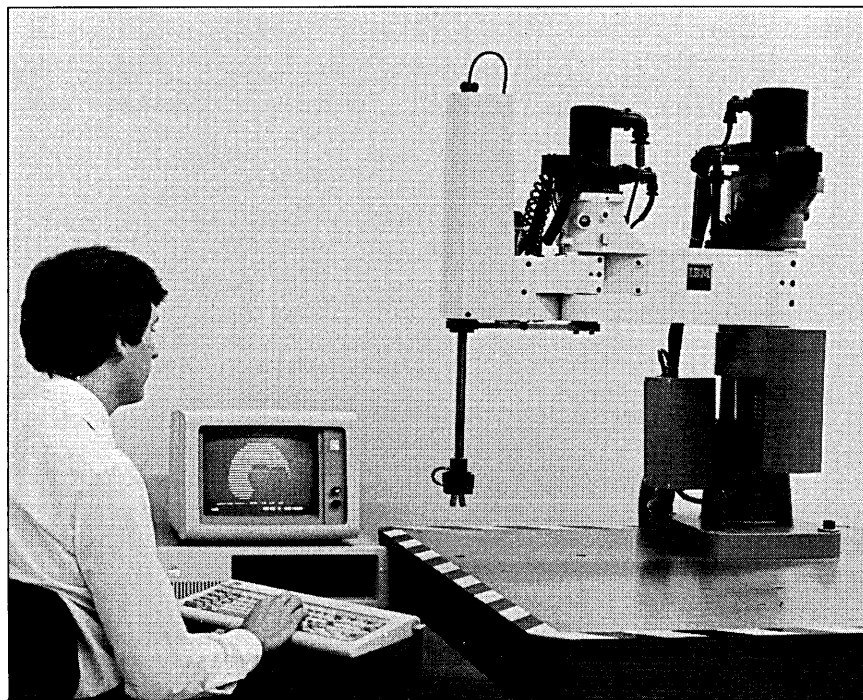

**NEW IBM ROBOT:** The model 7545 manufacturing system is claimed to handle a wide range of electromechanical assembly, fabrication, and material-handling tasks. Priced at \$36,000, the new machine is an upgrade of IBM's 7535 system, adding continuously variable vertical axis, a longer vertical range, and a more powerful roll motor. It can handle loads of up to 22 pounds, IBM says. The company also introduced a new version of its AML programming language that, running on the IBM PC, helps users program the 7545 with high-level commands. The new software carries a price tag of \$3,000 a copy. The company said the new hardware is being delivered now.





# So what's a few inches of bad tape?

"Tape's tape," you say.

That's true unless the tape you write on now can't be read later. Then things could get really hung up.

Sure, tape's the last thing you want to think about; but it's often the first thing you hear about when things go wrong. So start off right.

With Memorex.<sup>®</sup>

Every inch of Memorex computer tape is tested to give you the greatest data security. And while some companies scrape away imperfections—calling it "certification"—we'd rather reject them. To keep you on the safe side.

Now Memorex has two newly formulated tape products that take our well-known quality a step further. Both are engineered for durability and

dependability in the critical 6250 bpi and 1600 bpi worlds. And each is backed by a 25-year warranty.

**QUANTUM<sup>®</sup>II.** Our new premium tape features higher output and that extra margin of safety for your critical data. It's write/skip free at 6250 bpi.

**MRX<sup>®</sup>V.** The new high-output, multi-purpose tape provides excellent value and dependability.

Don't take chances with your data. Trust it to Memorex Tape. We won't leave you hanging.

For more information, call 800-222-1150.

**MEMOREX**  
A Burroughs Company

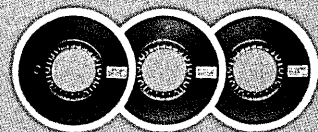



**NOW THAT YOU'VE GOT  
EVERYONE ON-LINE...**

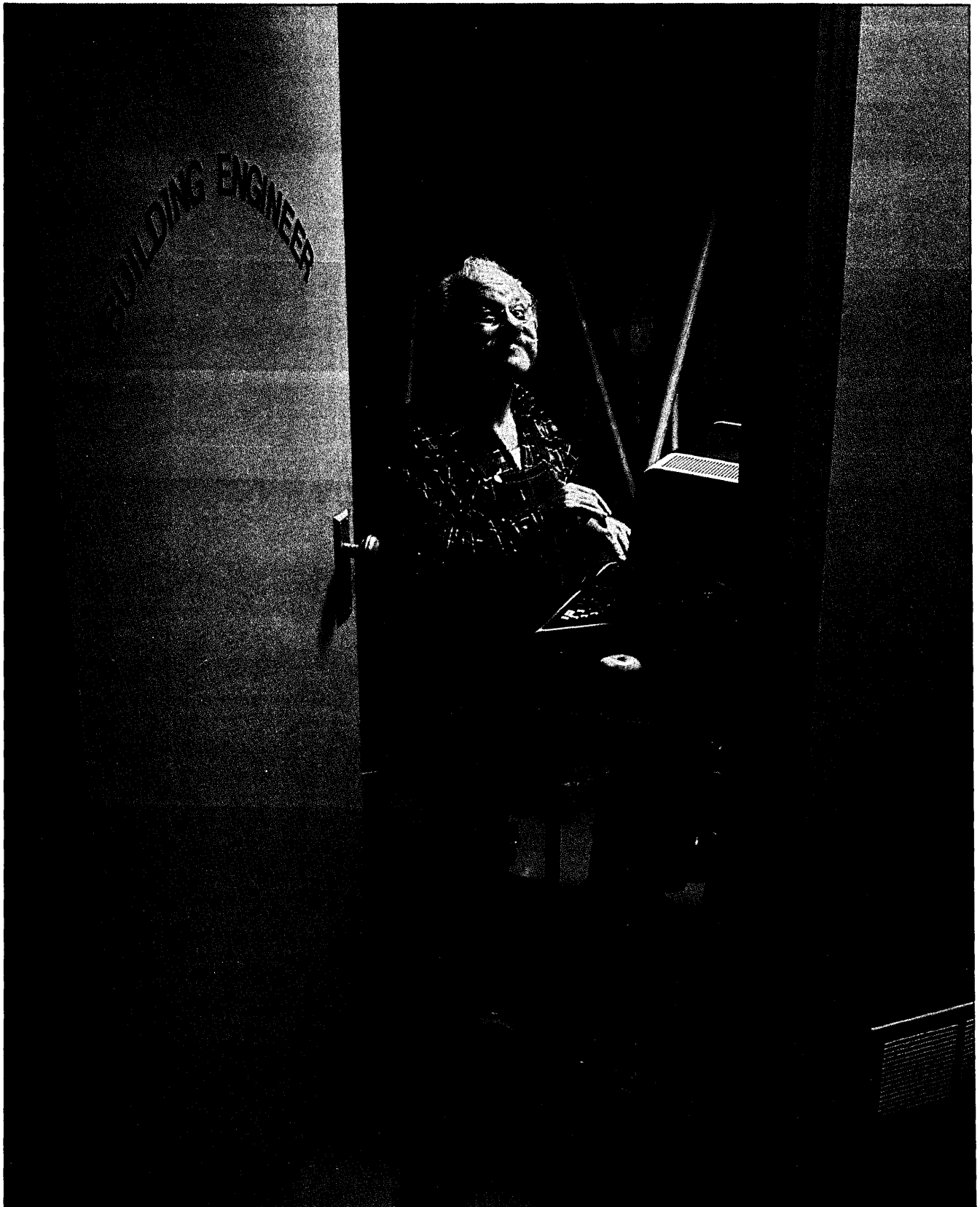

# HOW ARE YOU GOING TO KEEP THEM IN LINE?

## IS DATA CENTER MANAGEMENT SOFTWARE THE SOLUTION?

You bet.

Since large data centers are now controlling thousands of terminals, the *automatic* tracking of resources, users ... and their myriad problems ... has become mandatory.

The management of such a far flung organization has become so complex — and critical — that “going it alone” simply isn’t feasible anymore.

So, UCC has developed a new kind of software package to help you effectively manage today’s data center: UCC-8 Data Center Management Software.

## WHAT IS DATA CENTER MANAGEMENT SOFTWARE ANYWAY?

It is a total solution to these new kinds of management problems ... not just a patch. It provides you with all the information and tools you ... and your people ... need to keep the operation running smoothly. It’s a “Help Desk”, an “Information Center” and a “Command Center” all rolled into one ... only better.

## DOES IT HANDLE PROBLEM MANAGEMENT?

Yes. It will keep track of every one of your hardware and software problems. It will automatically respond to the problem ... and guide its solution.

## DOES IT HANDLE CHANGE MANAGEMENT?

Yes. It will control all equipment and procedural changeovers ... every step of the way.

## DOES IT HANDLE INVENTORY MANAGEMENT?

Yes. It will keep tabs on every one of your vendors, and every piece of their equipment.

## WHAT ELSE DOES IT DO?

It will monitor the immediate status of every project in your shop. It will identify the expense associated with every particular problem. And it will help you determine priorities and assign responsibility for every project.

In fact, it can do all of this for your entire company ... as well as your DP Department!

## HOW CAN I FIND OUT MORE ABOUT UCC-8?

Simple. Call us at 1-800/527-5012 (in Texas, 214/353-7312). We’ll be delighted to answer all your questions about what is probably the most essential piece of software to come down the pike in years: UCC-8 Data Center Management Software.

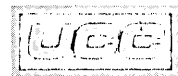

**The most complete software company in the world.**

University Computing Company  
Dallas • Toronto • London • Paris • Frankfurt • Zurich

# WHEN IT COMES TO CONTROLLING YOUR DATA NETWORK,

## THE IDX-3000™ PUTS YOU ON THE RIGHT TRACK.

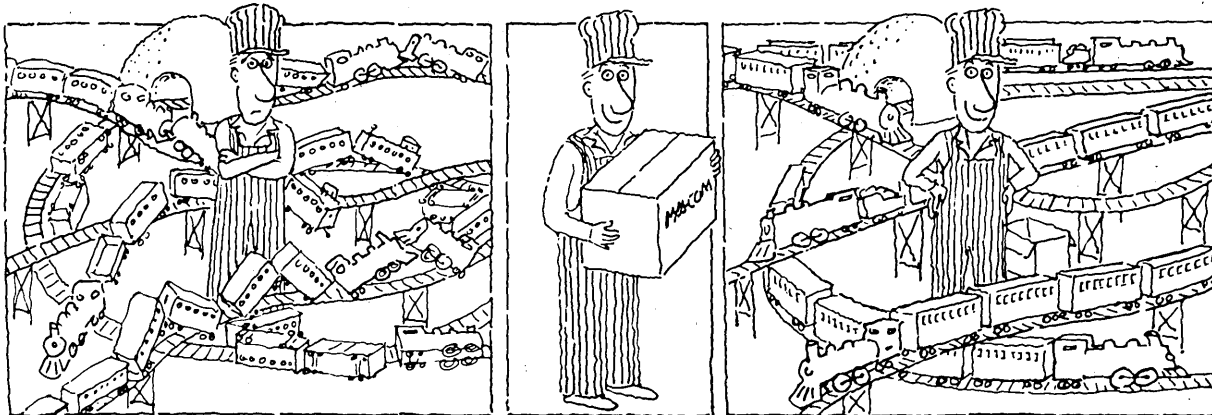

Control can be a major problem with a large network. That's why our IDX-3000 Local Communication System features the IDX-Net™ network controller. With IDX-Net, you handle configuration management on-line. You can manage major network topology changes, such as disaster recovery, with only a few keystrokes.

IDX-Net lets you access network control commands and diagnostics from any terminal in the network, including dial-up. This means that you, or M/A-COM Linkabit's Hotline Service, can diagnose your problem in seconds without having to be in your computer room.

### **Programmability**

IDX-Net's 68000-based network controller software provides you with the capability to interface host-resident application programs to the network. You can build-in your own custom-tailored network management features.

### **User convenience**

In addition to traditional data PABX port contention and resource selection, IDX-Net provides your authorized users with many of the features offered by modern telephone

systems. They can connect, disconnect and hold lines to multiple computer resources and execute third-party connects.

### **For the office of now**

With the IDX-3000, you can start with a small system that fits your current needs and budget, then grow to obtain non-blocking, full-duplex asynchronous communication for as many as 3072 lines, all at data rates of up to 19.2 Kbps. The IDX-3000's proven T1-based technology is fault-tolerant, with optional redundancy features throughout its distributed architecture, and automatic, continuous self-testing. The IDX-3000 isn't one of those products of the future. It's here now—proven, in use, and backed by M/A-COM, one of the nation's largest communication companies.

If you want to get control of your network, contact Ruth Stoffel at M/A-COM Linkabit, 3033 Science Park Road, San Diego, CA 92121, toll-free (800) 626-6640 or (619) 457-2340. We'll put you in control.

© 1983 M/A-COM Linkabit, Inc.  
IDX-3000 and IDX-Net are registered trademarks of M/A-COM Linkabit, Inc.

### THE NETWORK YOU CAN CONTROL



CIRCLE 56 ON READER CARD

## NEWS IN PERSPECTIVE

In nearby Palo Alto, Relational Database Systems Inc. is just shipping release 3.2 of its RDBMS, Informix. The company said the release is based on the fastest B-Tree access method available, its C-ISAM, and incorporates design techniques that boost speed and productivity. The firm, founded in 1980, claims to have been first to offer an RDBMS explicitly for the Unix and 16-bit microcomputer markets.

Also offering an RDBMS for the Unix market is Logical Software Inc., Cambridge, Mass. "We see it [Unix] as the operating system of the 1980s," says Douglas Kalish of Logical.

David L. Britton, president of Britton Lee Inc., Los Gatos, Calif., whose company sells an Intelligent Database Machine (IDM) based on the Berkeley Ingres, contends the IDM makes it possible for personal computers to do the work of a mainframe and extract information from a corporate database on a common basis.

As an example, he points to Houston On-Line, an offering of Products Diversified Inc. of Houston, which had a 15 million-record database and had examined a variety of hardware and software offerings to handle it. The records are real estate records for the city of Houston.

Products Diversified settled on Britton Lee's IDM and multiple Alpha Micro front ends. The IDM is the hub of the system

### **RDBMS vendors seem to have chosen Unix as their main operating system, perhaps because of the software's popularity on a broad range of hardware.**

controlling all access to the database. The IDM is capable of supporting up to 64 different hosts, mainframes, minis, and micros.

Britton says software-only RDBMS approaches often suffer from significant system overload and response degradation. A computer dedicated to database management, he says, can optimize performance while providing a cost-effective solution. Such a computer is a database machine.

Response time definitely is a concern of users of relational database systems. M. J. "Stu" Stedwell, a senior software engineer for General Electric's Corporate Information Systems Planning Operation in Bridgeport, Conn., has been supporting Ingres for a number of GE divisions for a year. "It's not very fast. If you try to do something on-line, that's a problem. If you work in the background in a batch mode, it's fine."

Stedwell's group has a corporate license for Ingres from RTI and can sublicense GE divisions. Eighteen divisions currently hold sublicenses and Stedwell regularly demonstrates Ingres to other po-

tential users. His demo is on-line, but "we use a small database so there's no problem." He evaluated Ingres along with other database management systems, both hierarchical and relational. "I like it [Ingres] because it's easy to use and its documentation is excellent." \*

## WASHINGTON

# HI-TECH TAX POLICIES

**A vocal group of electronics companies wants a break from the tax man so they can remain competitive.**

**by Willie Schatz**

Despite its image as the cure-all for the ailing U.S. economy, all is not copacetic in the high-tech world. When it comes to taxes, the industry's complaint is the same as heard from the average citizen: the other guy gets all the breaks.

While they aren't necessarily mad as hell, electronics companies say they just aren't going to take it anymore. They've said so in "High Technology Tax Policies for the 1980s," a document they hope will influence tax legislation in their favor.

The report, which consumed a year's work and 2,000 pages of information, was prepared by the Ad Hoc Electronics Tax Group. Participating were 20 corporations, including Apple Computer, Control Data, Data General, Digital Equipment, Hewlett-Packard, Honeywell, IBM, Intel, NCR, Perkin-Elmer, Sperry, Tandem Computers, Wang Labs, and Xerox. The issue was significant enough for even IBM and its archrivals to sign off on the final version.

The document was then submitted for consideration to five electronics trade groups: American Electronics Association (AEA), the Computer and Business Equipment Manufacturers Association (CBEMA), the Electronic Industries Association (EIA), the Scientific Apparatus Makers Association (SAMA), and the Semiconductor Industry Association (SIA).

The Ad Hoc Group came out firing. "Recent studies show that since the early 1960s, high technology electronics companies have faced relatively high U.S. income tax burdens compared to U.S. companies generally," the report says. "These studies also show that the impact of the Economic Recovery Tax Act [ERTA] of 1981 and the Tax Equity and Fiscal Re-

sponsibility Act [TEFRA] of 1982 has been to continue and in some ways to exacerbate this trend. The most recent studies indicate that federal income tax burdens on high-technology electronics companies in 1982 were from 40% to 75% higher than for the average U.S. corporation."

These numbers were not plucked from the sky. Studies by the Joint Committee on Taxation and *Tax Notes*, a weekly publication covering federal tax developments and rulings, show that in 1981, average effective tax rates on U.S. income for U.S. companies were in the 18% to 21% range. The effective rates for the two industry categories relevant to high-technology electronics companies, however, were much higher: 27% to 28% for instrument companies and 25% to 28% for computers and office equipment.

Times got tougher the next year. Overall corporate effective tax rates on U.S. income declined in 1982 to 16.6%. But the effective rates for computers and office equipment have remained at 26.5% and those for instrument companies have held fast at 22%.

"Without question these tax rules affect the ability of U.S. companies to compete in international markets," the report notes. "They affect the survival and prosperity of the industry in every market."

Even under what it perceives to be an oppressive climate, the industry isn't exactly starving to death. But you never know when the Japanese or some other nationally backed competitor might steal your market. So to insure domestic tranquility and provide for the common defense, the group made several recommendations to the associations. The hope is that those recipients

### **Overall effective tax rates on corporate U.S. income declined in 1982 to 16.6%, but computers and office equipment makers continued to pay 26.5%.**

will pass the good word around Washington and make certain it reaches Capitol Hill.

To create the necessary rules changes, the group recommends:

- A value-added tax (VAT, or officially a "transactions-based consumption tax") applied to all goods and services but rebated with respect to exports. The group determined this method would be more beneficial than increasing corporate income taxes or using income surtaxes.
- Making permanent the research and development (R&D) tax credit authorized by ERTA, and expanding university research and equipment donations. The group calls this "the highest tax legislative priority for the industry and its associations in 1984." The "High Technology Research and Scientific Education Act," which would ac-

## NEWS IN PERSPECTIVE

comply both goals, is pending in both the House (H.R. 4475) and the Senate (S. 2165).

- Changing the Accelerated Cost Recovery

**The major sticking point appears to be the value-added tax proposal, which has drawn criticism from several quarters.**

System (ACRS) to allow taxpayers to elect to expense short-lived equipment. This would provide high-tech companies with incen-

tives equal to those that ACRS provides companies using long-lived equipment.

- Much more favorable tax treatment for foreign income, and amended foreign tax credit provisions. "U.S. companies investing abroad pay the highest tax rates anywhere," said group economic consultant Emil Sunley during the press conference at which the report was released. "The rules need to be fundamentally rethought."

- Looking more kindly on the employee equity participation programs enacted in 1981.

"We know these changes won't happen overnight," group counsel Paul Oosterhuis of Washington's Hogan and Hartson understated. "We want to start people talking now so we can see results soon. We think we've set an agenda for 1984 that will cause a lot of changes in 1985 and 1986."

The debate has already begun. The five trade associations all endorsed the report, though let the record reflect that none of them fell in love with it. None officially adopted the report as association policy, although the respective boards of directors were expected to consider it with all deliberate speed.

How much legislative and political weight the document will carry depends on the decisions of those various boards of directors. The Ad Hoc Group "self-destructed," as Sunley put it, when it delivered the report to its intended beneficiaries. The group's business was business, not politics.

"There was a consensus among the 20 companies, but that doesn't mean there will be any among the trade associations," says Al Spurney, director of EIA's International Business Council. "I'm sure the difference in points of view among the companies in my association and among the five trade associations will show up. There are elements in the report, like making the R&D tax credit permanent, that will fly right

**"We've laid out a road map for the candidates on what would be of interest to us," says Robert Kirkwood, HP's director of government affairs.**

through every association. There are others, like the VAT, that could be controversial. I'd think that would be resisted by the manufacturers of home computers, among others."

It's sure to be resisted by one legislator. Where he leads, others may follow.

"The biggest surprise in this whole report is their mild endorsement of the VAT," says Rep. Ed Zschau (R-Calif.), chairman of the Republican Task Force on High Technology. "That's not good tax policy. I don't like the idea of a significant invisible added tax."

"The notion that we need a tax system that's more consumption-oriented and less savings-oriented is correct. This report addresses that idea very well. But I oppose the VAT. There's no question that the VAT can raise revenue. It's just a bad idea." That isn't the Ad Hoc Group's problem.

"The group tried to put down tax measures that would benefit high tech," Spurney says. "They didn't consider whether any are politically feasible."

"We've laid out a road map for the candidates on what would be of interest to

CAP GEMINI DASD Presents

# LAMOND ON IBM

**San Francisco**

The Westin Miyako

May 2-4, 1984

**Washington, DC**

The Sheraton International

Conference Center

May 7-9, 1984

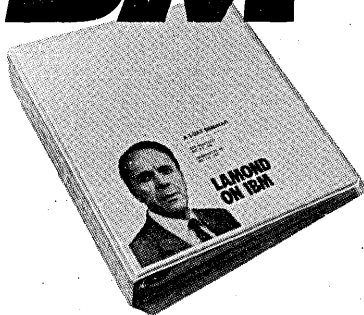

Fred Lamond, internationally esteemed researcher and strategic-planning authority, thinks and speaks IBM.

From the user's perspective.

More than 2,500 DP decision makers in 19 cities worldwide have already profited from

his insightful and constructive analysis of IBM.

Lamond's intensive three-day seminar (12 sessions) discusses current and projected IBM policies. Products. Applications. Trends (including IBM PC).

Emphasis is on cost-effective alternatives to IBM recommended growth and migration paths. Designed to help you examine options and reduce the cost of doing business with Big Blue.

Call now for your free Seminar brochure, (800) 558-5148 in Wisconsin (414) 355-3405, or write:



**CAP GEMINI DASD™**

9045 North Deerwood Drive  
Milwaukee, WI 53223

CEU ACCREDITED

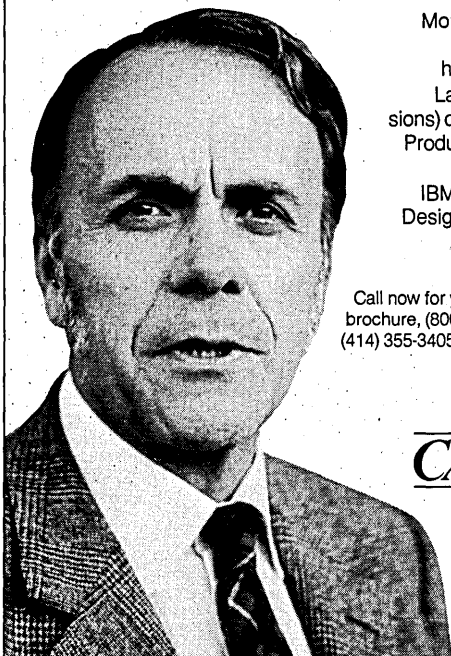

CIRCLE 58 ON READER CARD



# The second most important part of any computer.

Whether you sell computers or buy computers, you have your own most important reason for choosing or recommending a particular system.

But whatever anyone's highest consideration, second on the list of priorities is always efficient, reliable service.

And that's where MTTR comes in. We're in business to keep a company's computers in business with first quality maintenance and service. And we do it with a style and a sense of personal caring that's like nobody else's.

## Every second counts.

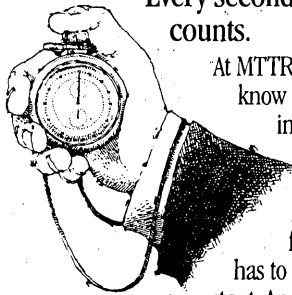

At MTTR, we know how

important the computer is to the American office of the 80's. A broker has to have stock quotes at his fingertips now. An engineer has to have a schematic in an instant. And a CEO has to have a P & L in his hands whenever he wants it. That's why we'll be there fast, usually within two hours of any call, no matter where that call comes from in the United States. And because we're a single source for all repairs, all it takes is one call to solve a problem.

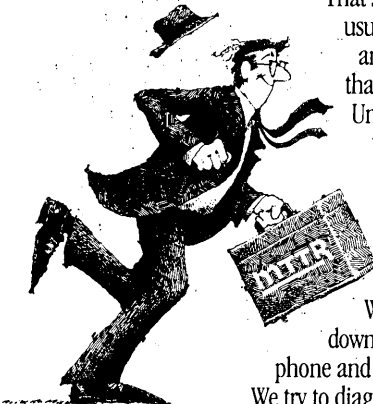

## Just a second.

When a computer breaks down, our clients pick up the phone and have us within seconds. We try to diagnose a problem over the phone. Then we'll fix it from our base, or we'll send a field service engineer, who knows that company and its equipment, on a

rush mission to repair. After all, MTTR stands for Mean Time To Repair.

## Second to none.

Personal service comes first with us. That's why we do more than repair computers as fast as we can. Because we care about giving the best possible service, we send repair people with an average of 15 years of experience and outfitted with what is the finest replacement equipment to get the job done right the first time. We're constantly training our people (at our expense, not our client's) to fix the newest equipment on the market. Our same

top quality service goes to every client, no matter what their size.



## We second the motion.

If you want to know more about us, ask our clients.

We maintain and repair computers for some of the most important companies in America.

"When our equipment fails during the day or after business hours, we can call our MTTR repair people, and they respond quickly."

John Faccibene, Corporate VP, Dir. of Communications, Paine, Webber Jackson & Curtis, New York.



## You don't have a second to lose.

Send us this coupon today, and we'll send you more information on MTTR. National Headquarters, 2540 Metropolitan Drive, Treviso, PA 19047

**MTTR**  
HIGH TECHNOLOGY  
FIELD SERVICE

Name \_\_\_\_\_  
Title \_\_\_\_\_  
Company \_\_\_\_\_  
Address \_\_\_\_\_  
City \_\_\_\_\_ State \_\_\_\_\_ Zip \_\_\_\_\_

If you can't wait another second, call our toll-free number, and talk directly to us. 800-233-MTTR. In Pennsylvania, call (215) 364-3737.

**MTTR**  
INC.  
HIGH TECHNOLOGY FIELD SERVICE

National Headquarters, 2540 Metropolitan Drive, Treviso, PA 19047

The second most important part of any computer.

## NEWS IN PERSPECTIVE

us," says Robert Kirkwood, director of government affairs for Hewlett-Packard and director of the Ad Hoc Group. "They've been asking and we haven't been saying."

Now they're talking. Whether the candidates are listening is something else again. They might want to ponder Kirkwood's suggestion that the report could become the bible for a candidate seeking support from high-tech industries. Playing hardball early this election year, Kirkwood warned that if a candidate doesn't support

permanency of the R&D tax credit, it would be a "telling sign" that he couldn't give a damn about high technology.

He might still be elected, though. "I'd hate to be judged or judge somebody else on one statement," Zschau says. "There's some truth to Kirkwood's statement, but it's only one piece of the technology puzzle. You really have to look at whether someone understands what makes technology work."

No one doubts it works. The industry just thinks the job costs too much. \*

## COMPUTING SERVICES

# CSC: A HECTIC 25 YEARS

**The company has seen some rough times but today's business looks good.**

**by Edith Meyers**

It's been a stormy quarter of a century for Computer Sciences Corp., El Segundo, Calif. The company will be 25 years old April 16. In some businesses this would be a coming-of-age point. In the computer industry it earns senior citizen status.

The storm has produced a rainbow. The company expects revenues to exceed \$700 million for the current fiscal year, which ends April 1. An initial capitalization of \$100 has grown to \$146 million.

It all started with three men and a contract to do a compiler for the Honeywell H-800. The three men were Fletcher Jones, Roy Nutt, and Bob Patrick. Jones came out of North American Aviation, Nutt from United Aircraft Corp., and Patrick from CEIR (Corporation for Economic and Industrial Research).

Today the company ranks 84th in revenues on Fortune's 1983 list of 100 diversified service companies and would rank

**"My big interest is in how well, or badly, we manage large software projects."**

371st on the Fortune 500 if it were an industrial company. It ranked 18th in the last DATAMATION 100.

From systems software, it has expanded into systems integration, communications, facilities management, medical claims processing, and network services, among other activities. It is listed on the New York and Pacific stock exchanges, has some 20,000 shareholders, and employs 14,000 people at more than 150 locations in 19 countries.

It didn't come easily. The company was known as a high flier in the '60s and a hard luck company in the '70s. Early on it became and still is the nation's largest systems house.

Of the three founders, only Roy Nutt, who was a member of the original FORTRAN development team at IBM in 1957, remains at CSC. Patrick left early and today is a computer consultant working from a ranch in Rosamond, Calif. Jones died tragically in 1972 in a private plane crash near his ranch in Santa Barbara County. He was

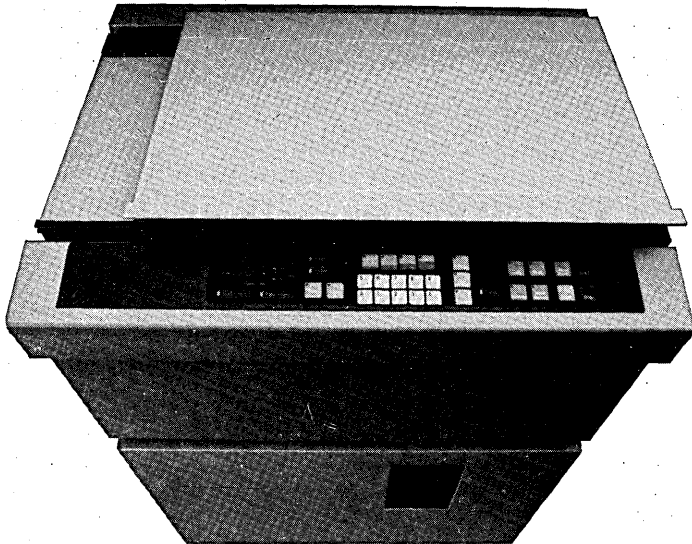

## Meet the KEL Model 5211 Laser Page Printer

### Higher technology for higher performance

The KEL Model 5211 Printer combines advanced laser, optical and Charged-Coupled Device imaging technologies in a new and extraordinarily versatile cut-sheet page printer. For sophisticated text and document processing applications, the Model 5211 is today's higher-performance choice.

With eight type fonts available concurrently, the Model 5211 makes style and/or size changes without interrupting document preparation. Printing resolution is 240 dots per inch, providing a sharp, high-quality image. The Model 5211 prepares up to 20 letter-size pages per minute, printing bit map graphics as well as alphanumeric characters.

### Unique document scanning and transmission capability

The Model 5211 takes high performance printing a step higher. Using Charged-Coupled Device technology, the Model 5211 scans documents at 240

dots-per-inch resolution, transmitting bit information via its RS232C I/O interface. Available only on the Model 5211, this optional feature gives you a uniquely efficient and convenient way to digitize image data.

An optional electronic forms overlay feature enables the Model 5211 to merge and print down-line-loaded forms with variable data, eliminating manual changing of preprinted forms. A local copy option lets you use the Model 5211 as an office copy machine.

KEL Model 5211. The higher performance printer. For complete information, use this magazine's reply card or contact KEL directly.



**KEL, INC.**

400 West Cummings Park  
Woburn, MA 01801 (617) 933-7852

KEL, INC. is a subsidiary of Kanematsu Electronics Ltd., one of the leading Japanese suppliers of computer products.

CIRCLE 149 ON READER CARD

# Decision-making tools for the Information Age

With the Matrix GGR™ management, DB, MIS and other personnel instantly format charts, graphs and text of artist quality for colorful 35mm slide and 8" x 10" transparency presentations, right from your mainframe or network, with the in-house advantages of quick turn around and controlled confidentiality.

We will supply you, without charge, the necessary driver software for your decision-making on the Matrix GGR™ 04/2 main frame computer.

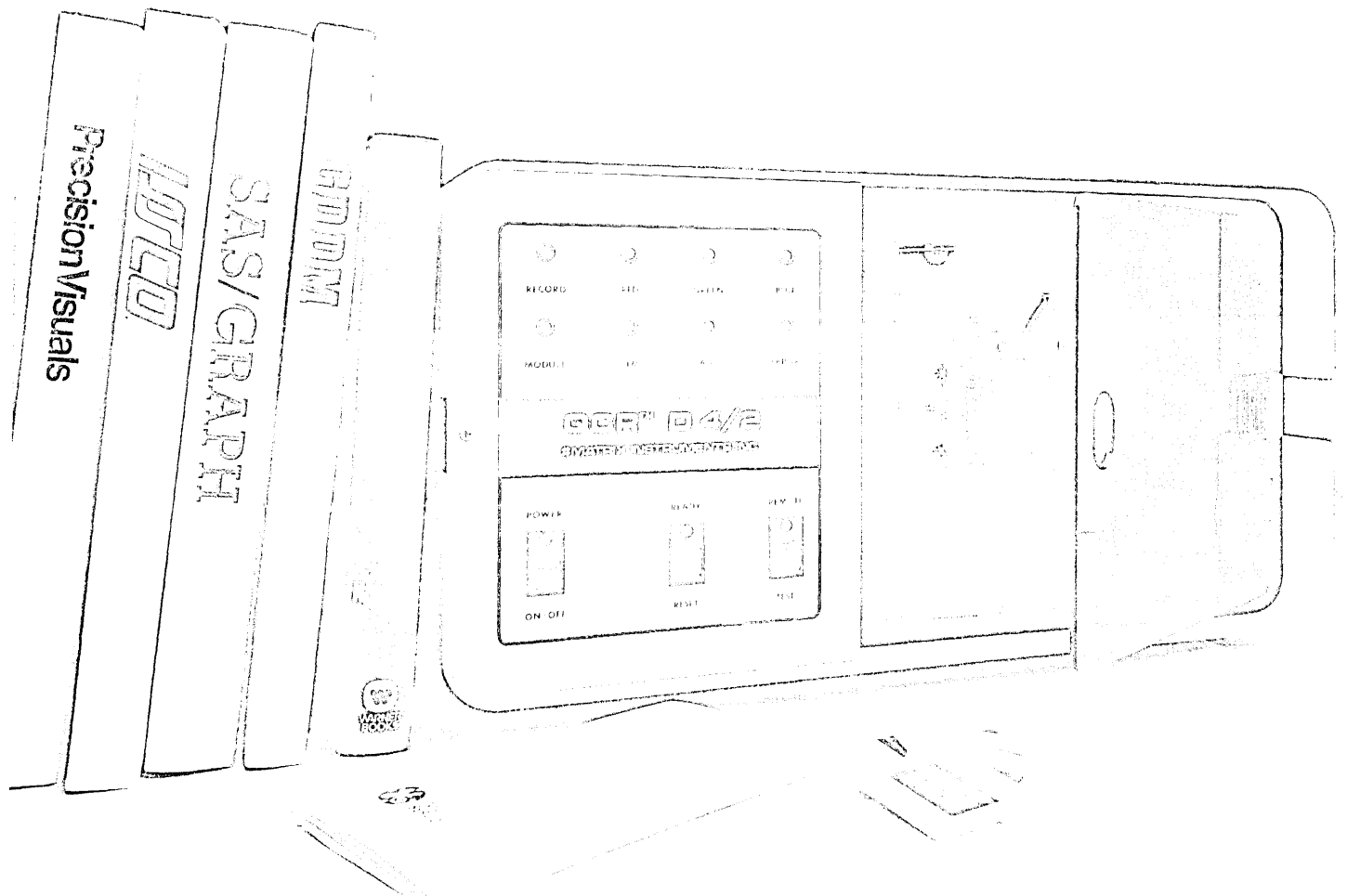

**MATRIX INSTRUMENTS INC.**

One Ramland Road, Orangeburg, NY 10962, Telephone: 914-365-0190 or Telex: 6853232

In Europe, please contact:

Honeywell Europe S.A., Avenue Henri Matisse 14, B1140 Brussels, Belgium, Tel: (32) (02) 243 1487 or Telex: 24535

**CIRCLE 60 ON READER CARD**

GDDM is a trademark of IBM.

SAS/GRAPH is a registered trademark of SAS Institute Inc.

ISSCO is a registered trademark of Integrated Software Systems Corporation.

# A growth market.

The kids of today are the real growth market of tomorrow. They are the doctors and nurses, the engineers and scientists, the teachers and journalists, the leaders who will create tomorrow's prosperity.

It will take your company's help to assure these children a first-rate college education because today colleges are having a hard time coping with the high costs of learning.

Invest in the future of America by giving to the college of your choice.

You'll be making an investment in the leading growth market of America. And you couldn't ask for a better investment than that.

Send for our free booklet: "Guidelines—How to Develop an Effective Program of Corporate Support for Higher Education." Write CFAE, 680 Fifth Avenue, New York, NY 10019.



**Invest in the future of America.  
Give to the college of your choice.**

A PUBLIC SERVICE OF THIS PUBLICATION AND THE ADVERTISING COUNCIL **Ad CFAE** COUNCIL FOR FINANCIAL AID TO EDUCATION INC. 680 FIFTH AVENUE, NEW YORK, NY 10019

## NEWS IN PERSPECTIVE

41 years old. His death was a part of the hard luck syndrome of the '70s for CSC.

That syndrome also included a \$62.8 million write-off in 1972 of development expenses for the Infonet division necessitated by an impending Fair Accounting Standards Board (FASB) ruling on expensing development; a stock plunge in '72 from \$34 a share to \$2, caused by the write-off; problems and some notoriety over an Off-Track Betting system developed for New York State in '72 and '73, most of which were more political than technical; and an investigation by GSA, launched in 1978, into possible overpayments to CSC in 1973, 1974, 1976, and 1977. This investigation led to an indictment in 1980 and two subsequent trials, both of which exonerated CSC and named employees.

In 1980 the company came into some unwanted publicity in California in connection with a MediCal system it developed for the state. "There were problems at first," concedes a company spokesman, "but these involved the doctors and other providers who didn't understand or want to use the system." The California claims processing contract with CSC was won late last year for another five years. A similar

**"It had features that now are appearing in things people are calling applications generators."**

contract was signed with Alaska, and one with Colorado was announced in February.

One of the prime designers of the MediCal system was Jules Schwartz, who joined the company in 1970. Best known for his association with JOVIAL (Jules's Own Version of the International Algebraic Language). "That was a joke originally," he quips. "It was to have been OVIAL for our own version but JOVIAL got into a contract." Schwartz joined CSC as a "senior kind of consultant, an administrative reviewer and producer in the commercial area. My big interest is in how well or badly we manage large software projects."

What he likes about working for CSC is that "there's always an opportunity to get into something new." Upon joining, he says, "I knew it was a big company with many diverse activities."

It wasn't so big when Joel Erdwinn joined in July 1960. Employee number 21, he hired on to work on a FORTRAN compiler for the LARC (Livermore Advanced Research Computer) at Lawrence Livermore Laboratories. When Erdwinn joined CSC it was in an office "across the street from the racetrack [the stable entrance to Hollywood Park]. Then they moved to the most convenient office ever, above a bakery," in Malaga Cove on Palos Verdes Peninsula. The company moved to its present headquarters facility in El Segundo in 1962.

# Only MSA software makes your mainframe work 100 times harder

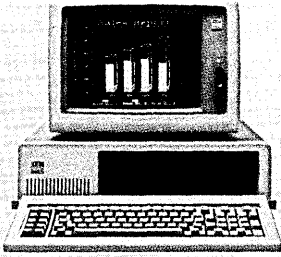

1. Now MSA's Executive Peachpak II™ links personal computers to the mainframe. So you can...

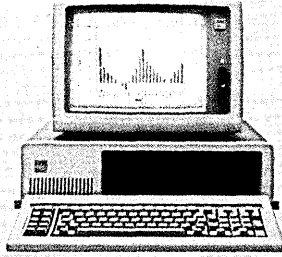

2. Use your PC to access all your MSA mainframe systems, from General Ledger to Manufacturing.

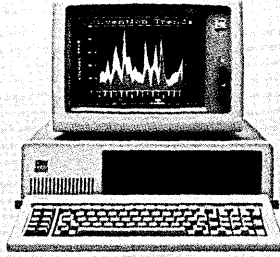

3. Access entire mainframe files, so you can work with large amounts of information at one time.

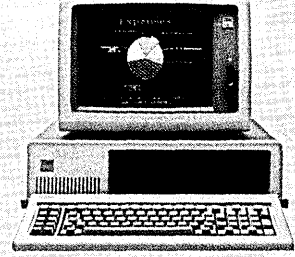

4. Choose the exact mainframe information you need, as much as you need, in the form you need.



5. Use it with Peachtree Software, 1-2-3™ from Lotus, DIF™, VisiCalc™, or other micro software.

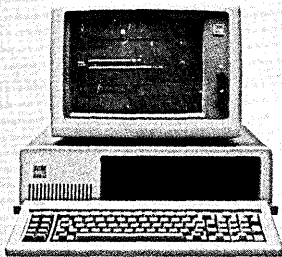

6. Replace terminals with PCs at about the same cost—with many more capabilities.



7. Plug PCs directly into your existing online network.

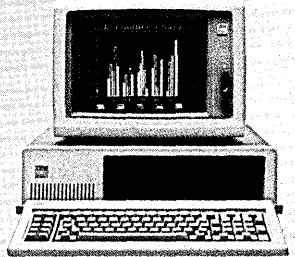

8. Or establish dial-up access with regular telephone lines.

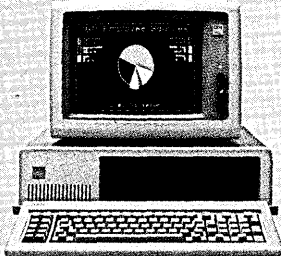

9. Interface mainframe data directly to typewriters, graphics plotters, and printers.

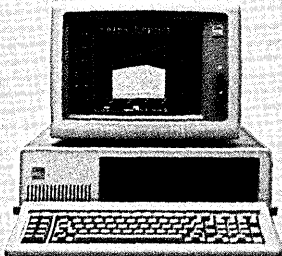

10. And automate your office economically.



11. Install this new technology in less than one hour.

Send for our free brochure, and find out all 100 ways to increase your productivity.

12.-100.

You've got your own personal computer. Now what do you do with it?

Thanks to MSA's new Executive Peachpak II™ software, you can do more than you ever dreamed.

MSA's new Executive Peachpak II links your personal computer directly to your company's mainframe. So you can get to vital information without waiting for print-outs.

It includes all the functions you'll need to really make your PC useful: an electronic spreadsheet, graphics, report production, telecommunications and much more.

And it's perfect for use with IBM's new 3270 PC.



For a free brochure that shows you 100 specific ways you can use Executive Peachpak II to get mainframe information through your PC, contact Robert Carpenter at (404) 239-2000. Or write Management Science America, Inc., 3445 Peachtree Road, N.E., Atlanta, Georgia 30326.

**MSA**  
The Software Company

**MSA makes the mainframe link to personal computers a reality**

Executive Peachpak II is a trademark of Management Science America, Inc. DIF is a trademark of Software Arts, Inc. 1-2-3 is a trademark of Lotus Development Corp. VisiCalc is a trademark of VisiCorp, Inc.

CIRCLE 61 ON READER CARD



# This book can save your company a lot of money.

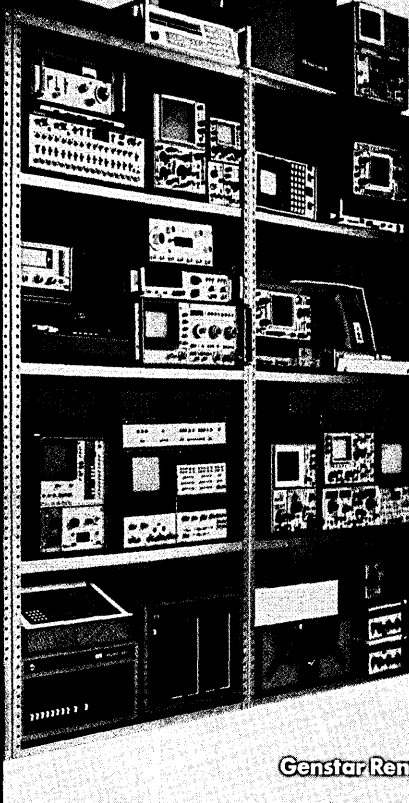

**You can rent  
all these products  
NOW!**

- Amplifiers
- Wave and Distortion Analyzers
- Logic Analyzers
- Microprocessor Analyzers
- Data Analyzers
- Network Analyzers
- Power Line Analyzers
- Scope and Recorder Analyzers
- Spectrum Analyzers
- Attenuators
- Calibrators
- Cameras
- Counters
- Scopes
- Desktop Computers
- Filters
- Function Generators
- Noise Generators
- Pulse Generators
- Signal Source Generators
- Sweep Frequency Generators
- Generator Synthesizers
- Radio Frequency Current and Resistance Meters
- Digital Meters
- Power Meters and Thermistors
- Microprocessor Development and Analysis
- PROM Programmable
- Oscilloscopes
- Calibrators
- Diode Probes
- Power Supplies
- Probes
- Digital Printing
- Recorder/Plotters
- Event Recorders
- Magnetic Tape Recorders
- Generator Recorders
- Strip Chart Recorders
- Temperature Recorders
- AC Recorders
- Sources
- Synthesizers
- Time Markers
- Graphical Remunit
- Mixers and Absolute Couplers
- Test Benches
- Test Cells
- Test Chambers
- Test Sits
- Index
- Terms and Conditions
- Inside Back Cover

**Catalog**

**Genstar Rental Electronics, Inc.**

## It's free, too.

GSA Contract GS-04S-23560

**GENSTAR**  
**Rental Electronics, Inc.**  
**(800) 227-8409**

In California (213) 887-4000 • (415) 968-8845 • (714) 879-0561

**This coupon brings you a recession-beating catalog by return mail!**

- It's free, so send it quick!  
 I'd also like a free catalog on "like new" items you're selling.  
 Don't wait. Call me today at: \_\_\_\_\_
- The equipment I'm most interested in is: \_\_\_\_\_  
 \_\_\_\_\_  
 \_\_\_\_\_

NAME \_\_\_\_\_ TITLE \_\_\_\_\_  
 ORGANIZATION \_\_\_\_\_  
 ADDRESS \_\_\_\_\_ MAIL STOP \_\_\_\_\_  
 CITY/STATE/ZIP \_\_\_\_\_  
 TELEPHONE \_\_\_\_\_

**Complete coupon and mail to:** Genstar Rental Electronics, Inc, 6307 De Soto Ave., Suite J, Woodland Hills, CA 91367

D-384

© Genstar Rental Electronics, Inc. 1983

**CIRCLE 62 ON READER CARD**

## NEWS IN PERSPECTIVE

Erdwinn went to Europe for CSC in 1970 where he worked on LACES (London Airport Cargo EDP System) for London's Heathrow Airport and on similar, smaller versions of the same thing for airports in Paris. "We tried to sell this to U.S. airports but they seemed to want to do it themselves."

He returned to the U.S. in 1978 and began work on CSTS (Computer Science Time Sharing), the operating system now used by Infonet. Today he's looking ahead. "I'm into fun and games. We look at the future. Our charter is operating systems and language. I'm the resident expert on expert systems."

Owen Mock joined CSC in 1961. Fletcher Jones talked him into joining. "Jones and I went back to 1953. We both worked for North American. I ran an open shop and he was my customer." Mock, too, worked on CSTS, but today he's looking at the IBM PC/XT. He sees CSC's success as due to "a combination of Fletcher and Bill [Hoover, currently president and chairman]. Fletcher was an entrepreneur, the guy with the big ideas. Bill has his feet on the ground. He got us through tough times back to reality [the time after the Infonet development write-off]."

Roy Nutt, who goes back with CSC farther than anyone there now, says he had no vision in 1959 of a company like today's

**"It turned out to be a larger investment than we had expected."**

CSC. "I thought we might end up with say 100 people, still doing systems programming. We reached that point very early."

He recalls that the company branched into applications programming some time in 1960. "We had a small contract with JPL that got us into the applications mode."

He also remembers the company's first actual employee. He's Bob Paul who still is with the company on the East Coast. Paul recalls, "[Jones and Nutt] would send me out of the room when they wanted to discuss policy for their employee."

Of the FACT compiler CSC built for Honeywell under that first contract, Nutt says, "It had features that now are appearing in things people are calling applications generators. For instance, a flowchart of a standard updating system was built into the compiler. The compiler understood what standard update procedures were. All logic was supplied automatically." The Honeywell H-800, he says, "had a surprisingly long life. The last one died five years ago."

In mid-1962, Nutt remembers, CSC got its first contract from IBM: to do FORTRAN and COBOL compilers for machines IBM later opted not to build. "This left us out on a limb for awhile, but we were soon

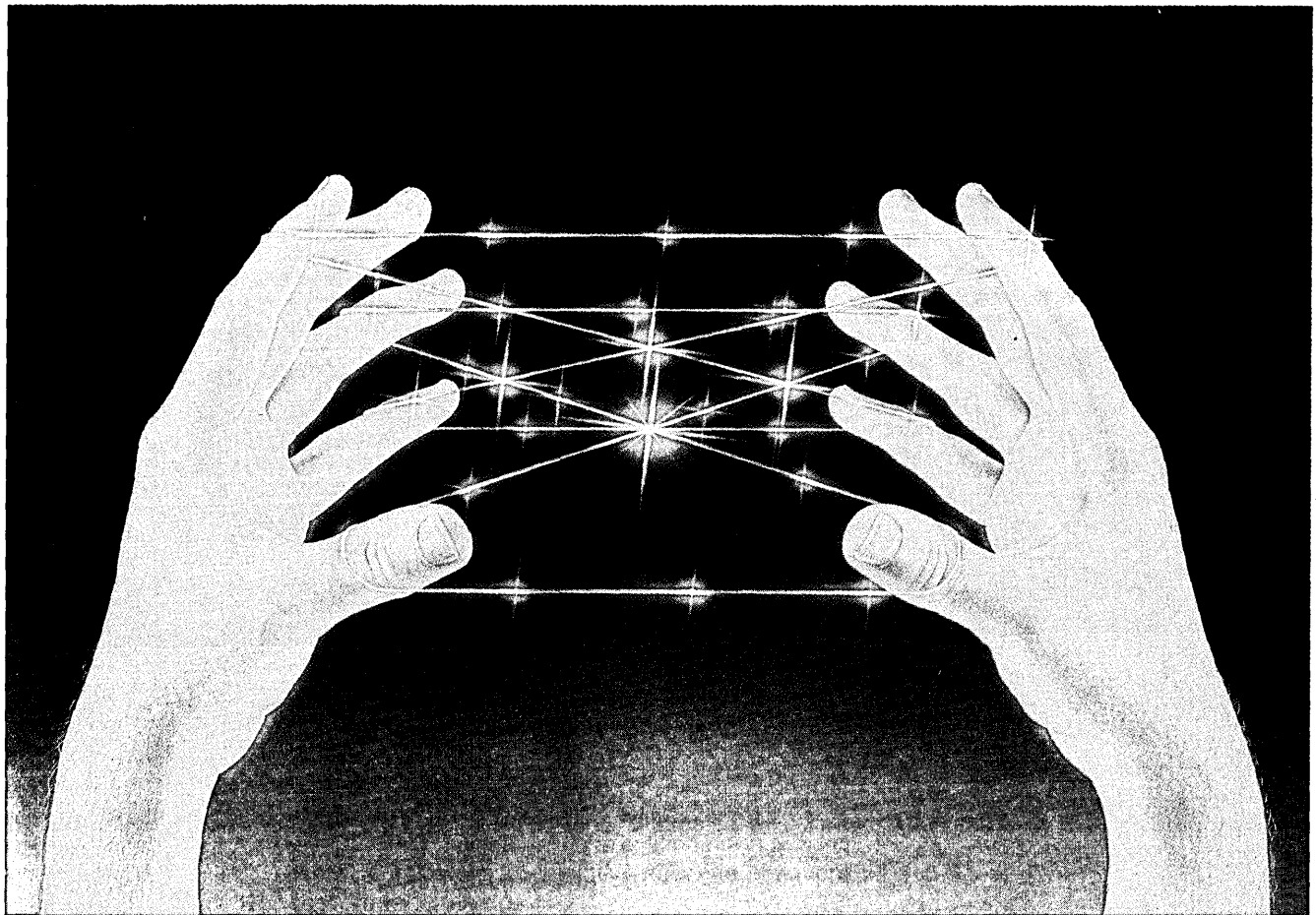

## Do you have a data communications network or does it have you?

Why tie up your resources when you can take advantage of ours? And there's never been more reason for taking advantage of RCA Cylix than right now during this period of deregulation and livestiture. Here's why.

Unlike the other guys, we don't just hand you a line. We deliver the stars. Because we're a satellite based, value-added network. Providing end-to-end management and a permanent virtual circuit that's perfect for transaction oriented applications.

What's more, you'll always get our undivided attention. Because data communications is all we do. And since you're working with just one company—not several—you'll never get lost in the shuffle.

RCA Cylix isn't just more convenient. It's also more efficient. Setting up your own network involves a huge commitment of time, personnel and capital funds. Our single vendor simplicity eliminates all that.

One phone call puts our experienced people to work for you. Setting up your

network. Handling all those dealings with all those phone companies. And then keeping your network running smoothly thanks to our unique service concept. Plus our design flexibility makes growth easy.

We can do all this more efficiently than you can due to our years of experience. And that can save you money. Because research indicates that personnel, benefits and associated overhead account for up to 1/3 of all networking costs.

Whether you're expanding an existing network or building a new one, now more than ever RCA Cylix is not only the easy choice. But the right one for data networking anywhere in the United States, Canada or Alaska. For more information

# RCA

## Cylix Communications Network

*Not just a source but a resource.*

and our free brochure, "Managing Your Network: Post-Divestiture Costs and Concerns" call our marketing department today at 901-683-3043. Or send in this coupon.

NAME \_\_\_\_\_

TITLE \_\_\_\_\_

COMPANY \_\_\_\_\_

ADDRESS \_\_\_\_\_

CITY \_\_\_\_\_ STATE \_\_\_\_\_ ZIP \_\_\_\_\_

PHONE \_\_\_\_\_

Protocols currently used (including lookalikes)

IBM 3270  SDLC

Burroughs Poll/Select

X.25  Other \_\_\_\_\_

Number of remote locations \_\_\_\_\_

Geographic Scope

National

Regional

Local

**RCA Cylix Communications Network**

Dept. D, 800 Ridge Lake Boulevard  
Memphis, TN 38119, 901-683-3043



# Connect with success.

**IRMA™ is the industry's most successful IBM 3270  
Decision Support Interface™, with more than 25,000 installations.**

IRMA, the first coaxial cable link between the IBM PC/PC XT and IBM 3270 networks, delivers the industry's best performance record. She's working successfully right now in more than 25,000 installations worldwide, giving PC users easy, economical mainframe data access, selection, storage and communication back to the mainframe.

And she's more capable than ever, with standard text file transfer software for VM/CMS and MVS/TSO mainframe environments, IBM 3278 Models 2, 3, 4 and 5 and IBM 3279 Models 2A and 3A screen support, plus optional APL Terminal Emulation.

If you want PC/3270 decision support that goes to work literally minutes out of the box, connect with success.

With IRMA, the industry's most widely used and most thoroughly proven decision support interface. For information write DCA, 303 Technology Park, Norcross, Georgia 30092. Phone (404) 448-1400, TLX 261333 DCAATL. Or call us toll-free 1-800-241-IRMA. **Connect with success.**

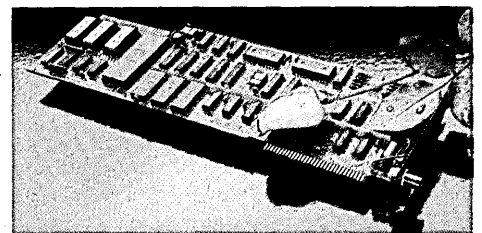

**dca**<sup>®</sup>  
Digital Communications Associates, Inc.

## NEWS IN PERSPECTIVE

back to work on the 360/67. It turned out this was not the right horse to choose. In 1966 or thereabouts, we did a series of graphics packages for IBM."

Nutt believes two events in 1965 had a big impact on the nature of CSC. One was the acquisition in January of two ITT subsidiaries in the telecommunications field and the other was a facilities management contract won in August to run the Atomic Energy Commission's Hanford Atomic Research Center in Richland, Wash.

Of the acquisitions, he says, "ITT had to divest them because of conflict of interest implications. We had a potful of cash left over from a public offering. It got us a whole new dimension. We were into the communications business and we had an entree into the federal government."

For the Richland contract, CSC was a finalist along with General Electric. "Brash CSC bid against the beast and won," says Nutt. "It changed the nature of the company overnight. We picked up 75 or 80 people, mostly from GE, and gained a remote location. For the first time we were dealing with computer operations people as well as professionals.

"We already had begun a service bureau," he remembers of the '65 period. "It was a result of a contract we had with Univac. One of the first Univac 1107s was installed in this building [headquarters in El Segundo]. We used it to check out all software we did for Univac, and we could sell time as well."

The company was marketing remote batch processing as early as 1964. "We did our first tests with Houston in 1963. We had opened a branch office there and used it as a guinea pig," Nutt recalls. Actual selling began in Los Angeles and San Diego in 1964. "In 1965 or '66 we decided that business did not offer a good enough return, so we sold it to University Computing. We reentered the real timesharing business later with Infonet."

Nutt remembers the years 1964, 1965, and 1966 as "a very interesting era." In that period, CSC formed CompuTax, a computer-based tax preparation service later sold to Commerce Clearing House at a tidy profit. In the same time frame, CompuTicket, a ticketing and reservation service in competition with Control Data's Tickertron, was started but was a failure. "You win some and you lose some," comments Nutt.

Also in those years, "we started marketing in Europe. We got our first major contract from Philips and later started a joint venture company with them that didn't work the way anyone thought it would, but it led to Computer Sciences Europe." Philips is still a good CSC customer.

Then, in the late '60s, came the beginnings of Infonet. "It turned out to be a

larger investment than we had expected. Independent market research firms were quoting big numbers. We had done some work for GE and concluded that they weren't doing it right. . . ."

Nutt says two different IBM machines were the first considered for the Infonet timesharing system. Neither machine ever made it big. The first was discarded by CSC because it was learned IBM didn't plan a follow-on. With the second, CSC would have had to modify the operating system. IBM's Federal Systems Division wanted the same modifications and there was a tentative plan whereby CSC would do these for FSD and would get the machine under a favorable arrangement. "Katzenbach [Nicholas deB. Katzenbach, IBM chief counsel and former attorney general] nixed that. No tie-in sales. This left us with the option to go with Univac at a substantial discount. IBM had no discounts then."

Nutt believes the effects of Fletcher Jones's death on the company were not really felt until recently. "At the time he died, Bill Hoover was already aboard handling the administrative part of the company. But Fletcher was very magnetic and he had a clear picture and a better picture of where markets are going than anybody else. If he'd been here when the micro came on the scene, we might have had a better understanding of where they were going to go. He might have been able to crystal ball it better."

Hoover joined CSC from JPL in 1964 as manager of the Los Angeles division at the age of 34. "Fletcher Jones and I agreed that neither of us was a great manager," says Nutt. "Jones was a promoter and I could manage technical groups. We found in Hoover a man who understood the whole problem."

Of 1964, Hoover says, "I knew the principals personally and respected them. I considered the technical staff of the highest quality. Actually, I was in awe of them."

Hoover became president of CSC in 1969 and was given the added titles of chairman and chief executive officer after Jones's death in 1972.

The next 25 years will probably see as much if not more change, for, as Joel Erwin comments, "the nature of the field is changing and you gotta change with it. You gotta be nimble on your feet."

Nutt is more specific. He feels CSC and other big, established companies were late in reacting to the micro. "We might have had packages for micros now." He doesn't see CSC jumping into this, but, "when the micro becomes much more sophisticated like the mainframe, when it becomes so easy to use that everyone will have one in his home, then the software will be sophisticated and bigger. It won't be possible for two men to do it in a garage. Then. . . ."

## FOREIGN VENTURES

# TWO FOR THE ROAD

**The merger of two French manufacturers has produced a \$2.75 billion telecommunications conglomerate.**

**by James Etheridge**

The French have too great a sense of aesthetics to believe that big is always beautiful, but they certainly seem to think that big is economic and efficient.

That theory will be tested firsthand when France's two leading telecommunications titans—CIT Alcatel and Thomson-CSF—team up. Out of this merger will come CIT-Thomson-Télécommunications (CTT), a company that France hopes will be a real force in the worldwide telecom realm. The potential is clearly there, and so are the revenues. If the two companies' 1983 revenues were combined for a total turnover of FF22.2 billion (\$2.64 billion), CTT would be among the world's top five telecommunications manufacturers.

The new company will be split into two sections, the Public Telecommunications Division under Christian Fayard, the managing director of CIT Alcatel, and the Company Communications Division headed by Jacques Darmon, manager of Thomson-CSF's communications arm, Thomson Télécommunications.

Darmon believes the new group's overriding goal is to increase exports, primarily by breaking into the American market. "We [the two companies] export 20% to 30% of our production and our target is to



Thomson chairman Alain Gomez

PHOTOGRAPHS BY N.S. RUSH/PAUL GAUTHIER



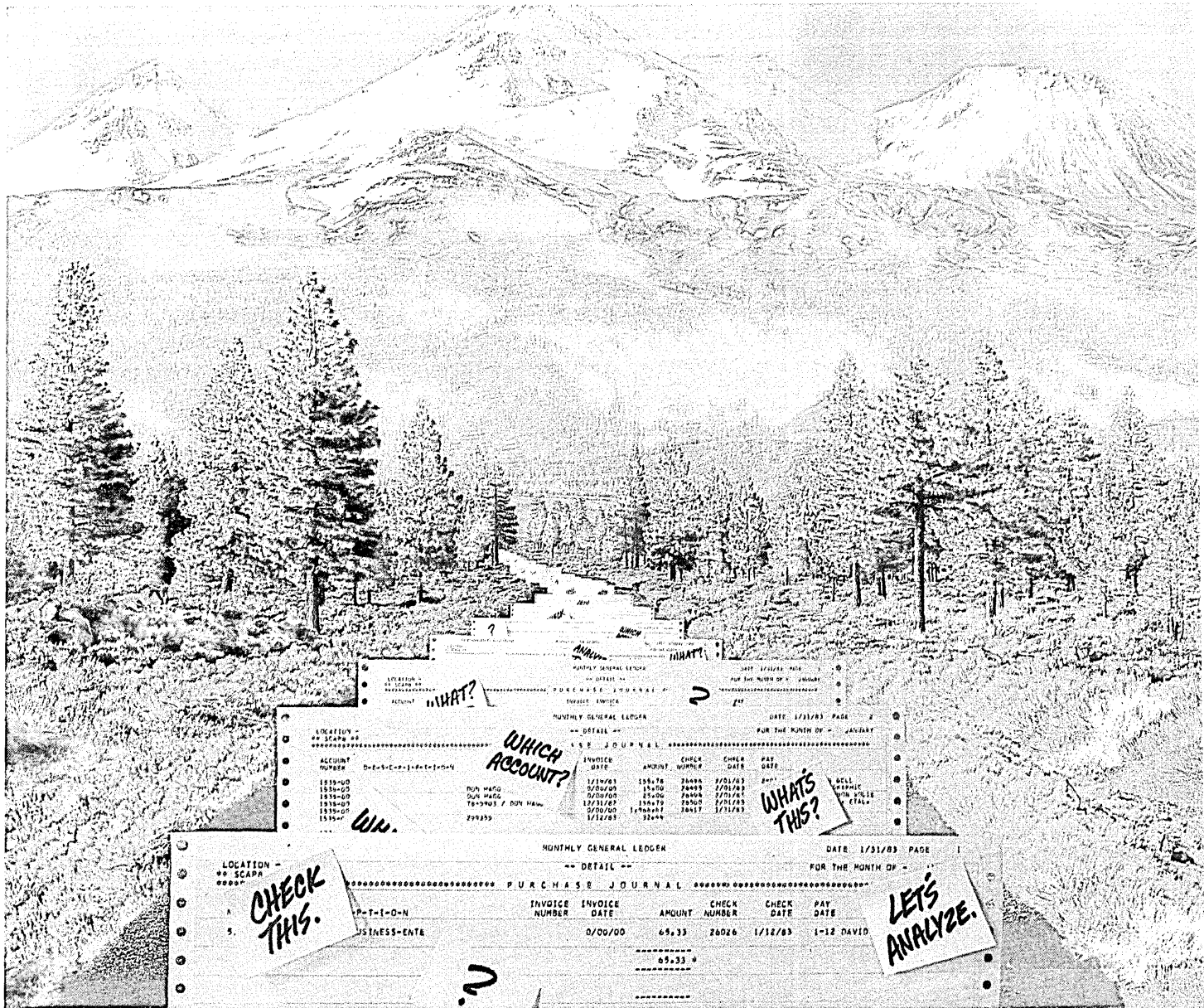

# THESE POINTS OF INTEREST ARE BROUGHT TO YOU BY POST-IT NOTES.

When you're facing miles of data, it helps to have a few signs to point the way.

Post-it® Notes are handy for calling attention to questions or problem areas, for indexing print-outs, even for temporarily labeling computer tapes. Their unique adhesive sticks when you want it to, comes unstuck when you want it to.

Post-it Notes are available from your local office supply dealer. Ask for a free sample, or phone toll-free 1-800-621-5282. Commercial Tape Division/3M.

"Post-it" is a trademark of 3M.

3M hears you...



CIRCLE 65 ON READER CARD

☉☉ If I invest in a multifunction workstation, how can I be sure it'll communicate with what I already have? ☉☉

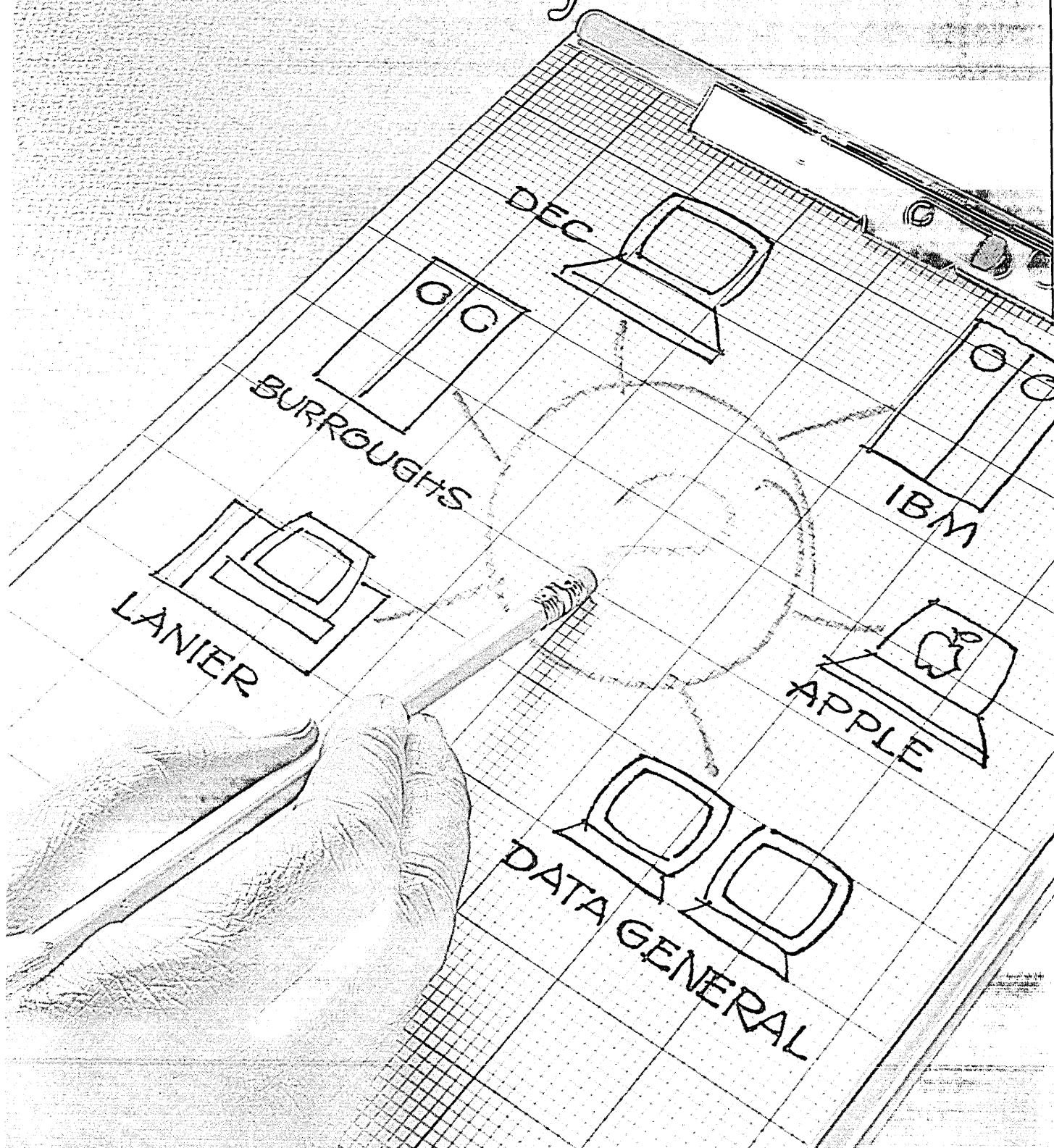

## Northern Telecom's information processing products have the communications capability you need.

Besides being compatible with each other, Northern Telecom's 503 desktop computer and 565 and 585 information processing systems communicate effectively with a multitude of mainframes, including IBM, Burroughs and CDC. They also talk to other minis such as DEC, Hewlett-Packard and Data General. Not to mention word processors such as Lanier, and even micros such as TRS-80 and Apple.

This means you'll have more flexibility—and more control over your information system. Even if more and more personal computers are becoming a part of it. Our 500 family supports the CP/M® operating system software, so employees can have the personal computing capabilities they want, while your company keeps the organizational unity it needs.

At the same time it's running CP/M, the family can also be running its own unusually powerful operating system which is compatible across the whole 500 line. It permits a unique approach to multitasking—with a few simple keystrokes, up to 16 tasks can be performed simultaneously on the same terminal. Data processing, personal computing, spread sheets, word processing, information management, electronic mail, whatever task needs to be done can be done at the same time. An incredible timesaver.

All in all, the 500 series is quite a family. Versatile, reliable and a perfect example of Northern Telecom's OPEN World\* commitment to compatibility. Northern Telecom is a world leader in digital technology and we're using this expertise to make sure our products fit comfortably into a multivendor world.

For more information, call 800-621-6476 (in Illinois 800-572-6724), or write to Northern Telecom Inc., P.O. Box 10934, Chicago, IL 60610.

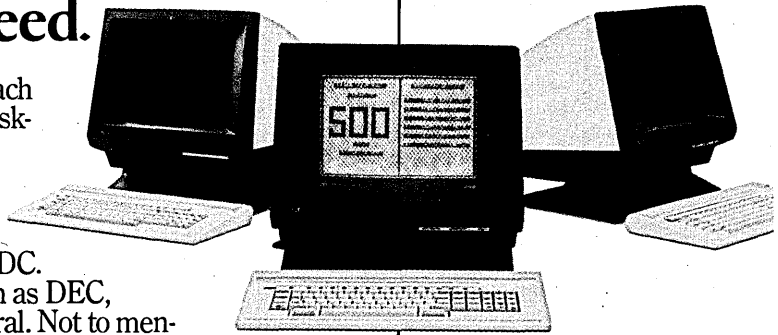

The 500 Family.

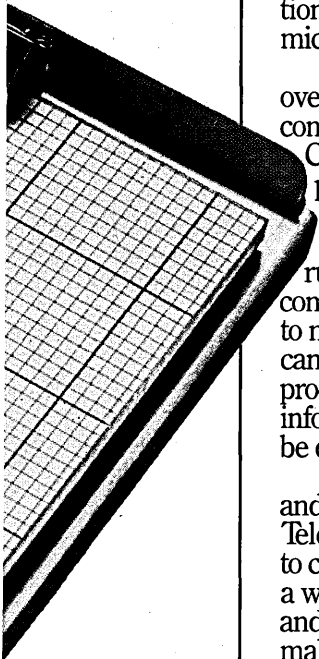

®Trademark of Digital Research Inc.

\*Trademark of Northern Telecom Limited

CIRCLE 66 ON READER CARD

## NEWS IN PERSPECTIVE

increase that to 60%," Darmon explains. "We are already quite strong in markets outside Europe. Our priority now is North America, because European markets are too closed." Darmon claims that Thomson is one of the few companies in the world that's strong in both public time division switching systems and digital PBXs. "These are the products that can best be adapted to the American market," he says.

Darmon also sees the merger as a good way to boost R&D. "We can now spend twice as much on each group of products as the two companies were able to do individually before."

That kind of argument, however, does not carry much weight in certain quarters. Compagnie Générale d'Electricité (CGE), CIT Alcatel's parent company, is regarded as sluggish and not very innovative by some people in the French telecommunications industry. In fact, the French PTT has been responsible for much of the innovation in public switching systems. The company's E 10 telephone exchange, for example, was developed by the PTT—not CGE.

With more R&D muscle, the new group should be able to be more innovative. Theoretically, CTT should also be able to offer a broader product range, filling in the current gaps in its office automation equipment line. These office automation wares



Jacques Darmon, manager of Thomson Télécommunications

could be sold along with its business communications systems.

This dual sales strategy is being used by an increasing number of telecom companies that expect to see more revenues from the terminal side. Therefore, the group's weakness in the workstation market could put a damper on its future growth.

Growth considerations were also

factored into the merger decision. The man behind the merger was Thomson chairman Alain Gomez. The Thomson chief felt his group could improve its performance in the consumer electronics and defense systems fields if it divested itself of Thomson-CSF Communications, the division that markets public and private telecommunications systems. Gomez received a warm reception when he approached CGE managing director Georges Pebereau, who agreed to the marriage proposal. Under the deal, Thomson-CSF Communications will be melded into CGE's communications arm, CIT Alcatel.

That was the easy part. Putting it all together and making it work will be more difficult. The merger operation is being carried out in two steps. Under the first step, Thomson-CSF Communications will be spun off from the Thomson group at the beginning of this year. The government will own 48% of the new venture, which will be called Thomson Télécommunications; Thomson will retain a 40% stake, while CGE will hold the remaining 12%.

CGE has also created a holding company—84% interest going to CGE and 16% to Thomson. This new holding company owns 50.1% of CIT Alcatel. A joint research company (51% CIT Alcatel and 49% Thomson Télécommunications) called Alcatel-Thomson, has also been set up during the

**NEW!**

# DYL-280 II: The reliable, fully documented, user-friendly software system for you.

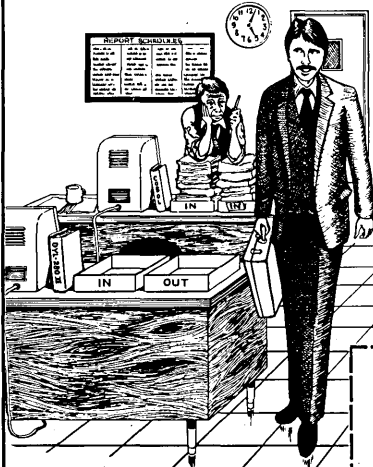

You can leave the office at 5:00 o'clock, your projects completed, with the reliable, user-friendly DYL-280 II software system. Call or clip the coupon now, before 5:00 o'clock. Or is it 7:00 for you tonight? Contact us today.

### Here's what DYL-280 II can do for you:

- Cut your programming time in half and dissolve your program backlog with one of the most comprehensive, multi-purpose information and file management software systems available for your IBM mainframe.\*

- Provide ease-of-use for your end-users with DYL-280 II's everyday, English language syntax, plus a specially designed "end-user option."
  - Write your own custom letters using simple, flexible commands—a feature seldom found in file management systems on the market today.
  - Feel confident by selecting your software from a family of award-winning software products. Rated #1 and #2 in their category on Data Decisions' most recent Systems Software Survey (check box on coupon for more details), Dylakor products are supported by the in-house technical specialists who developed the software.
  - Choose the plan that best fits your budget from convenient lease to purchase options.
- \*For IBM 360/370/30xx/43xx and compatible mainframes.

YES, I need greater productivity, efficiency and speed in a RELIABLE, FULLY-DOCUMENTED, USER-FRIENDLY information and file management software system. Please send me detailed descriptions of the benefits DYL-280 II offers me and include the facts on the Data Decisions Systems Software Survey.

I can't wait. Have an Account Specialist call me.

Please just put me on your mailing list for now.

Name \_\_\_\_\_ Title \_\_\_\_\_  
 Company \_\_\_\_\_ Phone \_\_\_\_\_  
 Address \_\_\_\_\_  
 City \_\_\_\_\_ State \_\_\_\_\_ Zip \_\_\_\_\_  
 Computer \_\_\_\_\_

Mail NOW to: Dylakor, 17418 Chatsworth Street, P.O. Box 3010, Granada Hills, CA 91344

**CALL DYLA KOR RIGHT NOW AT 818-366-1781** to talk with an Account Specialist and learn more about the detailed benefits that DYL-280 II offers you. Or, clip this coupon and mail it TODAY.

**NEW DYL-280 II** is brought to you by an award-winning, 15-year pioneer in the software industry.

**Dylakor**

A Sterling Software Company

DTM



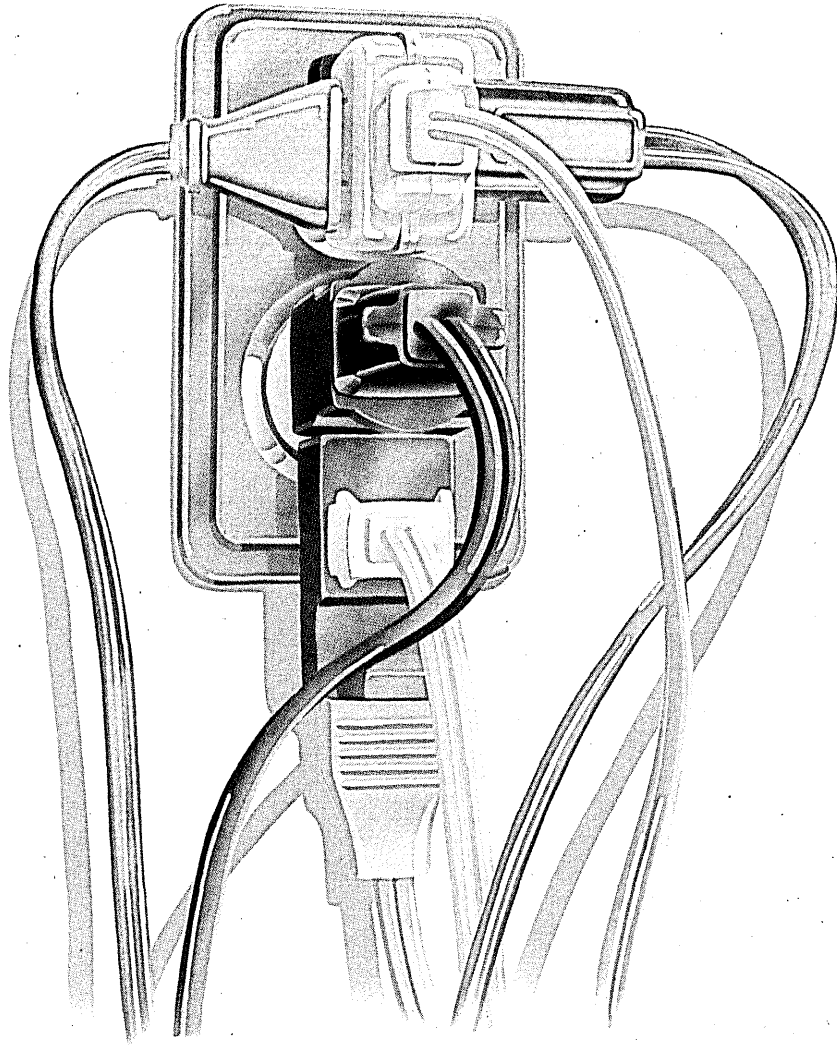

## **Pull the plug on your inefficient data communications. We can help.**

Many data communications networks, perhaps yours included, have grown in the same add-on way as this common octopus plug arrangement. Yes, it works. But it contains many built-in risks and could ultimately let you down.

The time is right for you to take a careful look at how General DataComm can streamline and improve your data communications, and save you money at the same time.

### **Here's how.**

Since we are a full-line data communications manufacturer, everything from modems and multiplexers to network management systems and service support, we can design a complete system for your company. It will not only work better but save line costs, too.

When we install a system it not only means higher efficiency now but it will expand easily to meet your needs tomorrow.

### **Tie your network together.**

Our true systems approach also helps eliminate compatibility problems. Since we design and manufacture the full product range, you can be sure everything will always work in harmony.

Put our experience to work for you, especially now in the new divested telecommunications environment.

For a free brochure detailing our approach and product range call or write to General DataComm Industries Inc., One Kennedy Avenue, Danbury, CT. 06810. (203) 797-0711.



**General  
dataComm**

*We're the full line data communications company.*

**The Data Movers**

**CIRCLE 68 ON READER CARD**



# SPINWRITER INTR

Now you have a choice of fully compatible Spinwriters for your IBM PC and XT.

First, a few words about the original, the Spinwriter 3550.

It was the first and only totally compatible letter-quality printer for the IBM PC. It plugs directly into the IBM PC and works with every piece of IBM PC software, as well as all popular third-party application packages, such as WORDSTAR™, WORDPLUS™, VOLKSWRITER™, VISIWORD™, MULTIMATE™, BPS GRAPHICS™, LOTUS™ 1-2-3™ and VISICALC™.

It even looks like it was made for the IBM. Now, as good as the Spinwriter

3550 is, we recognize that a single printer can't take care of every business or professional office need. So we've added another IBM PC compatible Spinwriter: The 2050.

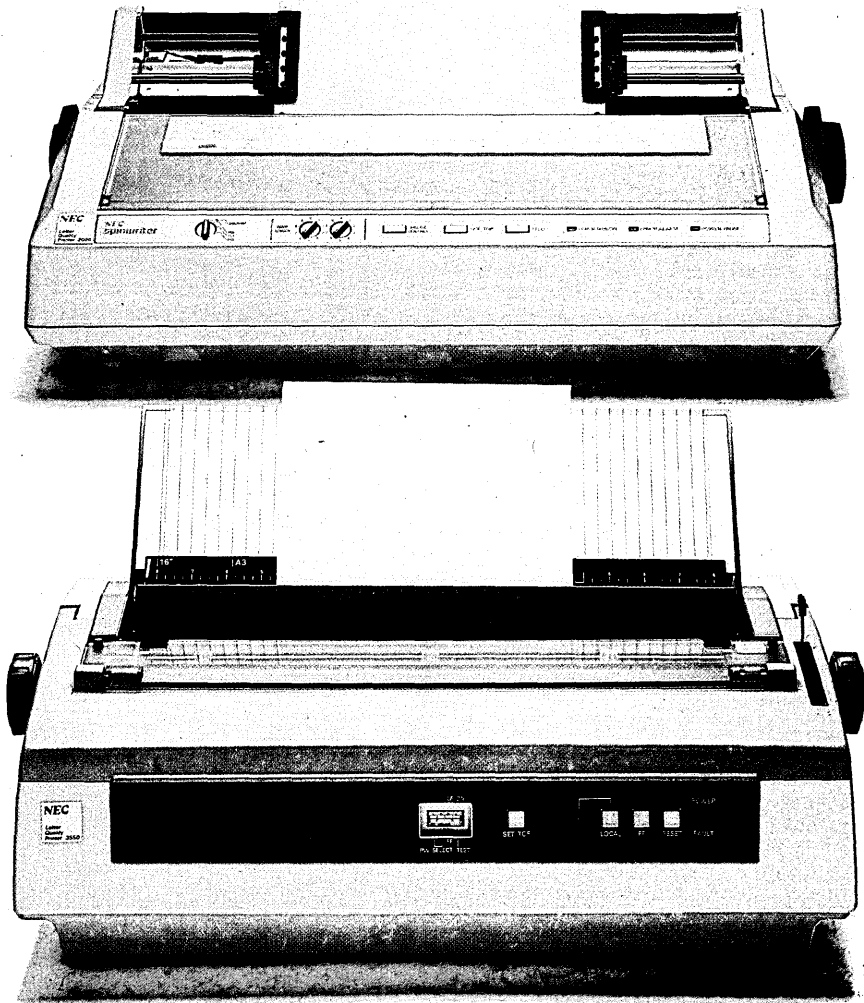

NEC MODELS OFFER SPEEDS OF 200 AND 350 WORDS PER MINUTE.

The new 2050 has a printing speed of 200 words per minute. And while it costs less, the print quality is still impeccable. So if low-volume letter-quality printing is what you need, the 2050 is your answer.

**60 different print thimbles let your IBM PC look its best.**

One of the things that gives our Spinwriter capabilities you can't even get on other printers is our unique "thimble." Each thimble holds up

to 128 characters. You can even have two different type faces on one thimble or print multiple languages from a single thimble. Think of how handy

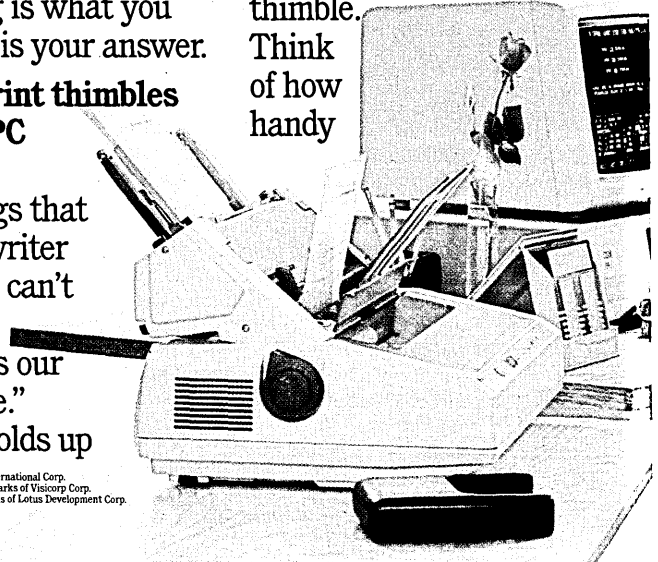

OUR UNIQUE "THIMBLE" PRINTER OFFERS UP TO 128 CHARACTERS AND HIGHER QUALITY PRINTING.

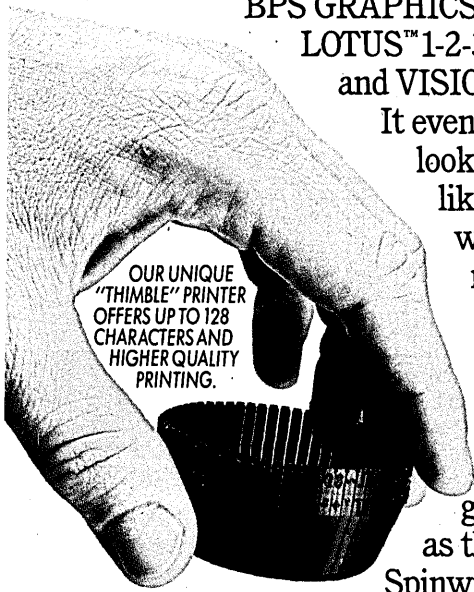

Spinwriter is a trademark of NEC Corp. IBM is a trademark of International Business Machines Corp. WORDSTAR is a trademark of Micropro International Corp. WORDPLUS is a trademark of Professional Software Inc. VOLKSWRITER is a trademark of Lifetree Software, Inc. VISIWORD and VISICALC are trademarks of VisiCorp Corp. MULTIMATE is a trademark of Softword Systems, Inc. BPS GRAPHICS is a trademark of Business & Professional Software, Inc. LOTUS and 1-2-3 are trademarks of Lotus Development Corp.

# PRODUCES A SPINOFF.

that would be if your business is international.

On the other hand if you have special printing needs, you can opt for a full alphabet plus numbers, sub- and superscripting and scientific and arithmetic symbols.

Incidentally, for all their versatility, our inexpensive

ABCDEFGHIJKLMNOPQRSTUVWXYZ  
abcdefghijklmnopqrstuvwxyz  
ABCDEFGHIJKLMNOPQRSTUVWXYZ  
АБВГДЕЖЗИЙКЛМНОПРСТУФХ  
ABCDEFGHIJKLMNOPQRSTUVWXYZ  
Δ→β≡³ρ/+⁸&\≡/⁹⁰¹⁴α⁵⁷∞₂≥⁶↑

ABCDEFGHIJKLMNOPQRSTUVWXYZ  
abcdefghijklmnopqrstuvwxyz

ABCDEFGHIJKLMNOPQRSTUVWXYZ  
"£¡~', \$-Æ†æ¿™¡£ø°° ¡jßðáÀ"æø

SPINWRITER OFFERS OVER 60 DIFFERENT TYPE FACES.

thimbles last for over 30 million impressions.

So it won't end up costing you a fortune to look like a million.

**No matter what form your business takes, Spinwriter can handle it.**

A Spinwriter can actually

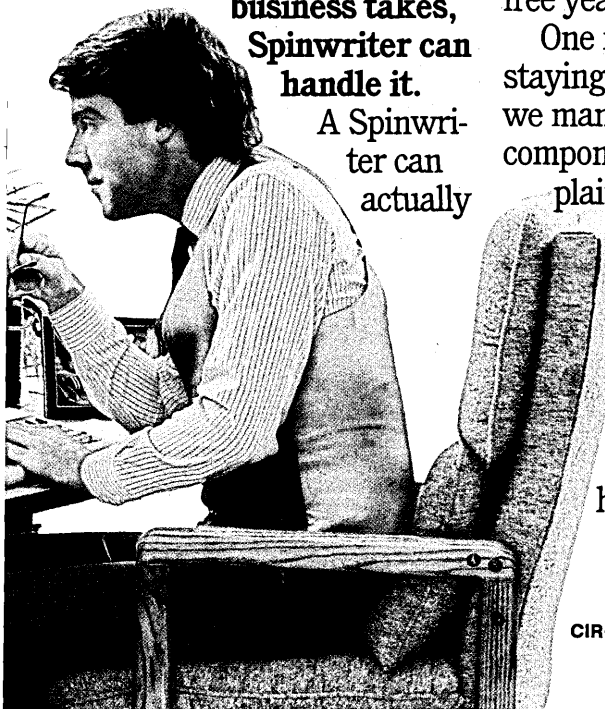

help you put your communications in better shape. It can use any of our nine interchangeable forms handling options. And they can all be easily installed and changed by the operator.

Want to dash off a few hundred original letters to your customers? Our sheet-feeder is just the ticket. It will print on your letterhead and second sheet or envelope.

Standard features include continuous forms handlers that take paper up to 16 inches wide, variable size forms, and multi-part forms.

**Spinwriters have a hard-earned reputation for reliability.**

Spinwriters hold the industry record for mean-time-between-failure. Over 3,000 hours. Which, in terms of average personal computer usage, adds up to more than two trouble-free years.

One reason for Spinwriters' staying power is the fact that we manufacture every major component. It also helps explain why NEC Information Systems is the number one supplier of letter-quality printers to PC users in America. Of course, someday you may need a little service. If you do, it's nearby. We have a large group of

SPINWRITER CAN OPTIMIZE YOUR IBM PC CAPABILITIES.

CIRCLE 69 ON READER CARD

NEC-trained professionals all around the country. It's also quick. Because of our modular design, normal repairs take less than 20 minutes.

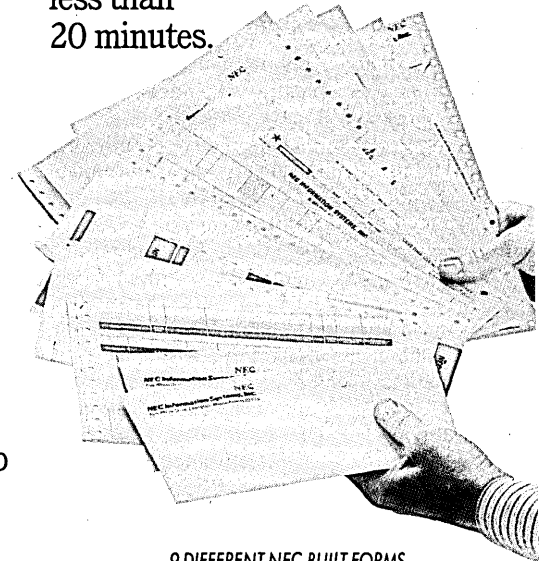

9 DIFFERENT NEC-BUILT FORMS HANDLERS AUTOMATICALLY FEED ANY OFFICE FORM YOU HAVE.

You'll find Spinwriters at participating ComputerLand stores, Sears Business Systems Centers, IBM Product Centers nationwide, Entré Computer Centers and authorized NEC Spinwriter distributors. Or call 800-343-4418 for more information. And find out why more and more IBM PC users are saying, "NEC and me."

**NEC  
AND  
ME**



NEC Information Systems, Inc.  
1414 Massachusetts Avenue,  
Boxborough, MA 01719

## NEWS IN PERSPECTIVE

provisional phase.

Although CGE has only a 12% interest in Thomson Télécommunications, it's already taken over the company in managerial terms. It has three years to complete the merger with CIT Alcatel. When the second and final step comes, by Jan. 1, 1987, the definitive corporate animal—CIT-Thomson

**"This is a waiting game. We are developing our muscles before speaking to others."**

Télécommunications—will be born. CGE will have a majority holding in CIT and Thomson will carry up to 40%.

The linkup should benefit both Thomson and CGE. The divestiture of the communications division frees Thomson to pursue more profitable market areas. The merger also gives CGE strong standing in the public telecommunications market and more potential in the private telecom arena. In addition, CGE has managed to significantly increase its corporate clout with a minimum of investment—a situation that angered some financiers and industrialists. CGE's 12% stake gives it total control of Thomson Télécommunications. The reorganization also gives it an excuse to get a fresh injection of government funding—FF720 million (\$85.5 million), to be exact.

Successive governments have felt that the concentration of France's industrial might is right. President François Mitterrand is no exception. His industrial policy does differ in one critical respect from that of his predecessor, Giscard d'Estaing, however. While d'Estaing promoted the development of the private sector, Socialist Mitterrand believes that the state should have control over the largest industrial groups. Therefore, at the beginning of his presidency, Mitterrand nationalized France's five largest manufacturing companies, including the massive CGE and the Thomson group. The result is that 50% of the French electronics industry is now under government control. The recent reorganization of the telecommunications industry may, therefore, seem to be no more than a redistribution of activities in the public sector.

When Thomson Télécommunications and CIT Alcatel officially team up to become CIT-Thomson-Télécommunications, the government's holding in Thomson Télécommunications will revert to CGE, in exchange for additional shares in the already nationalized group. And despite the fact that both Thomson-CSF and CIT Alcatel are publicly quoted companies (their parent firms own less than 100% of their equity capital), the private shareholders were not even consulted about the deal.

The merger move also made the PTT mad. The PTT, while not expressing itself publicly, made it known that it resented the disappearance of all semblance of competition between its two principal suppliers. It also felt its power had been diminished for the benefit of CGE. The French PTT also had its wings clipped recently as a result of a ministerial reorganization that stripped away its independent status.

While the PTT minister, Louis Mexas, publicly defended the merger, it was clear that the PTT was fundamentally opposed to the alliance. In fact, PTT executives are still voicing their resentment at the idea of being subservient to their main supplier. Nonetheless, it can maintain some degree of competition in the telecommuni-

**About 50% of the French electronics industry is now under government control.**

cations market in the future by awarding more contracts to smaller suppliers like Matra, SAT, Sagem, and TRT.

In some observers' eyes, the merger solution was an admission of failure—the failure of both companies to have concluded appropriate international agreements. According to one industry analyst, the deal between CGE and Thomson has only brought

## ALL YOUR DATA COMMUNICATIONS & TELECOMMUNICATIONS NEEDS

- Racal-Vadic Modems
- Test Equipment
- Short Haul Modems
- Switches
- Protocol Converters
- Multiplexors
- EIA Cables and Connectors

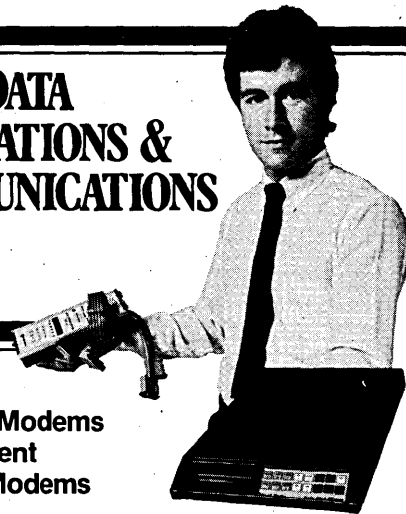

Modem Mart features Racal-Vadic's 212PA Modem

JUST A PHONE CALL AWAY

IN OHIO  
(800) 362-6883

OUTSIDE OHIO  
(800) 321-2510

**MODEM MART**  
905 Bassett Road  
Cleveland, OH 44145

## TERMINALS FROM TRANSNET

PURCHASE PLAN • 12-24 MONTH FULL OWNERSHIP PLAN • 36 MONTH LEASE PLAN

Authorized Distributors — Carry the COMPLETE lines of:			MONTHLY RATES			OR Purchase
			FULL Ownership 12 mo.	Lease 24 mo.	Lease 36 mo.	
DEC 	LA50	Personal Printer .....	\$ 62.	\$ 35.	N/A	CALL FOR DETAILS
	LA12A	Portable Printer .....	182.	101.	69.	
	LA120KSR	DECwriter III .....	220.	122.	83.	
	LQP02	Letter Quality Printer .....	269.	149.	101.	
	VT101	CRT Terminal .....	115.	67.	43.	
	VT102	CRT Terminal .....	143.	80.	54.	
	VT131	CRT Terminal .....	153.	85.	58.	
	VT220	CRT Terminal .....	110.	62.	42.	
TI 	TI707	Portable Terminal .....	62.	35.	N/A	
	TI820KSR	Terminal Pkg. ....	211.	117.	80.	
	TI850	Printer w/Tractor .....	57.	32.	N/A	
	TI855	Dual Mode Printer .....	86.	48.	32.	
TELE-VIDEO 	TV914	TIH/Swivel CRT .....	62.	35.	N/A	
	TV950	CRT Terminal .....	103.	57.	39.	
	TV970	TIH CRT Terminal .....	115.	67.	43.	
NORTHERN TELECOM	NT6K00	Displayphone .....	124.	69.	47.	
	NT6K55	Modem 212/A .....	47.	26.	N/A	
ENVISION	215	Color Txt/grph CRT .....	306.	170.	115.	
	230	Color Graphics CRT .....	623.	346.	234.	

FULL OWNERSHIP AFTER 12 OR 24 MONTHS • 10% PURCHASE OPTION AFTER 36 MONTHS

### PERSONAL COMPUTER SYSTEMS

Visit our computer stores in Union and Ocean, NJ  
AUTHORIZED RETAIL DEALER

APPLE® IIe, III and LISA — DEC RAINBOW — TI PROFESSIONAL

SUPPLIES — FREE CATALOG — CALL

DEC is a registered trademark of the Digital Equipment Corporation.

APPLE is a registered trademark of Apple Computer Inc.



**TRANSNET CORPORATION**

1945 ROUTE 22 — UNION, NJ 07083

In NJ (201) 688-7800 • (800) 526-4965 • TWX 710-985-5485

CIRCLE 70 ON READER CARD

CIRCLE 71 ON READER CARD

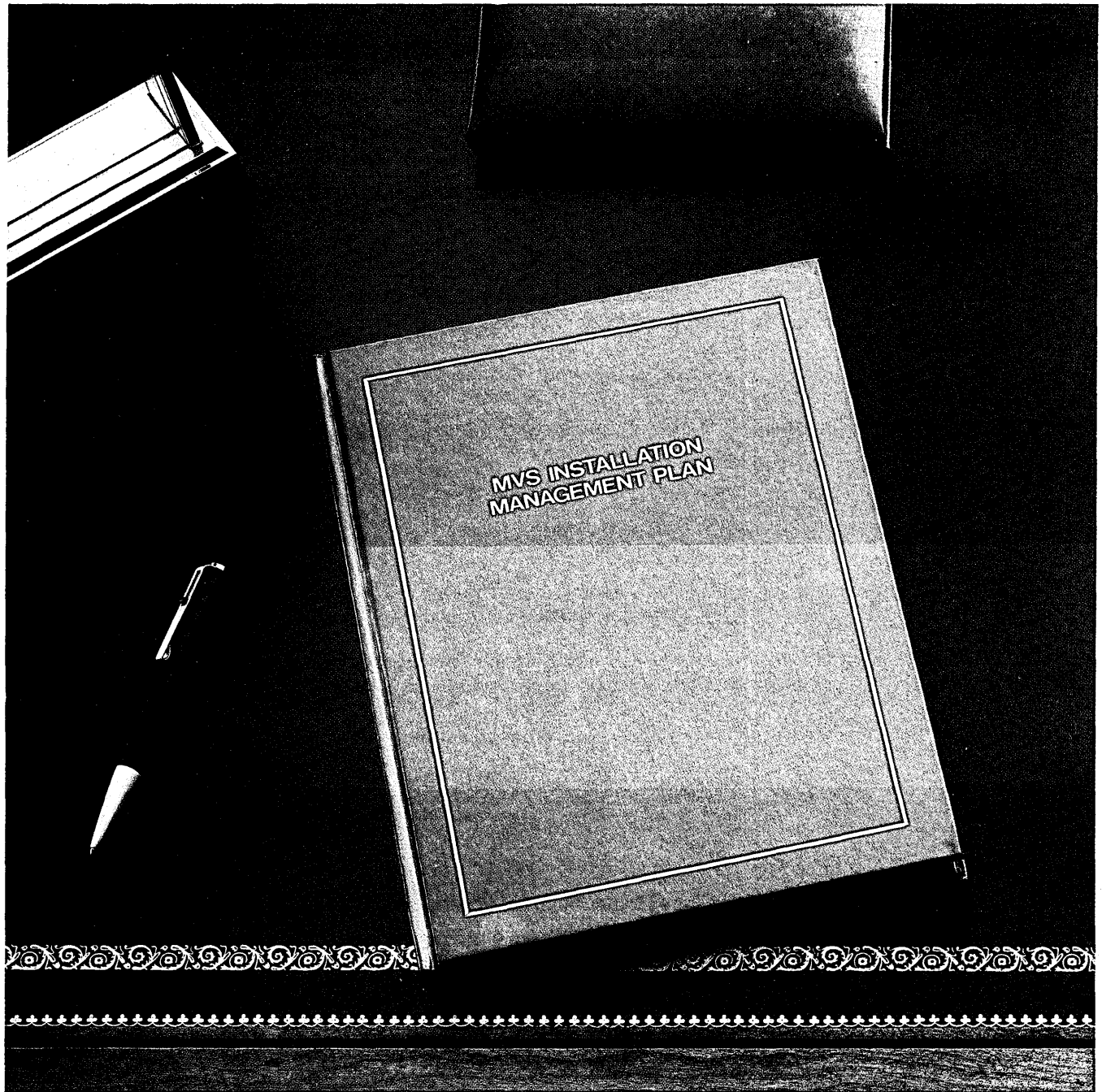

## For the concerned computer executive... a rare first edition.

It costs you nothing. But it details how your company can save staff time and hardware upgrades through the use of MICS, our MVS Integrated Control System.

It analyzes your installation's current environment and recommends a specific course of action for realizing these savings. It gives the names of executives like you who have taken advantage of our suggestions.

And the plan is yours for the asking. Unconditionally.

Simply direct a member of your staff to request a plan questionnaire. Have it filled in and returned to us.

We'll do the rest.

We want you to know us and MICS. To understand why 19 of the top 20 Fortune 500 industrial firms are our users. And to recognize us as the standard-setters for MVS installation management. That's why we're making you this offer.

It's in the book!

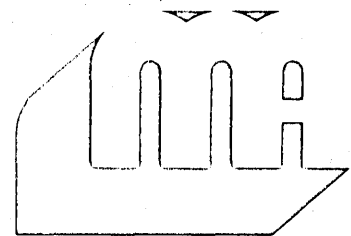

**MORINO ASSOCIATES**

<b>MORINO ASSOCIATES, INC.</b>	<b>MORINO ASSOCIATES (UK) Ltd.</b>
8133 Leesburg Pike	118 Victoria Street
Vienna, Virginia	St. Albans
22180	Hertfordshire
U.S.A.	England AL1 3TG
Tel: (703) 734-9494	Tel: St. Albans (0727) 37464

CIRCLE 72 ON READER CARD



# BRIDGE COMMUNICATIONS.

## We've Got Connections For LAN Communications.

Bridge Communications. We are the high-performance source for local network systems. With a growing family of second generation, 68000-based LAN systems designed to help you get the most out of your computer equipment. A family evolving to meet today's communications needs. And, more importantly, tomorrow's.

We offer a broad range of connections. Like our Communications Servers, the GS/1, and our newest entry, the GS/100.

The GS/1 can connect up to 32 (the GS/100 up to 10) RS-232C equipped computer, peripheral and communications devices to any Ethernet LAN. Devices like printers and storage subsystems. Mini-computers and mainframes. Even clusters of PCs and terminals can be interconnected to share information and resources. With throughput rates unmatched by anyone in the industry.

Tymnet is a trademark of Tymshare Inc.  
Telenet is a trademark of CTS Inc.

If you're connecting local networks together over private or public communications lines, consider our Gateway Servers. Using Tymnet™ or Telenet™, our X-25-based GS/1 can make your local network span the continent. Our GS/3 can connect your Ethernets together. Across the office. Or across the country.

If you're currently developing a resource-sharing network, discover our full-featured LAN family. Included are multiple open sessions per port, symbolic port naming, command file macros, extensive network management, rotaries, "help" facilities and port access control. If you'd like more information, contact the Bridge representative in your area for a demonstration. Or write us at:



Bridge Communications Inc.  
10440 Bubb Road Cupertino, CA 95014  
Tel: (408) 446-2981 Telex: 176 544  
Boston (617) 890-6122  
Washington D.C. (202) 429-2042



## NEWS IN PERSPECTIVE

the new group some time. It remains just as important to cooperate with other big outside companies. "In the short term, the key to the group's success will be the quality of its marketing and the international agreements it manages to conclude."

To strengthen its micro muscle, Thomson recently signed a deal to distribute Eagle Computer's 16-bit PC-2 (which it will sell as the Micromega 16). The company has been offering the top of the line Micromega 32 since late 1982.

The analyst nevertheless agrees that the new group will be in a better position to compete internationally. "The critical threshold for generating an adequate R&D effort seems to be a turnover of at least \$1 billion, which the new group now has by combining revenues in public telecommunications." On the other hand, he also sees management bottlenecks emerging as a result of the fusion of two parallel work forces. "There is a danger that the most talented and ambitious junior managers may become frustrated and leave, because there are more chiefs than Indians."

Its strength in time division switching systems and digital PBXs gives the group considerable potential in world markets. Its weakness is on the office automation side. CGE's recent agreement with Olivetti represents a lost opportunity on that score, since it didn't take advantage of the Italian company's expertise in OA systems. Under the pact, the companies will jointly manufacture and sell electronic typewriters in France. Olivetti will also market CRT Alcatel's Minitel videotex terminals in Italy.

CGE was undoubtedly reluctant to invest more than the absolute minimum in a tie-up with Olivetti (it acquired only a 3% interest in Olivetti, while public financial institutions bought 7%). Olivetti, for its part, was equally determined to keep the French government from getting too much control over

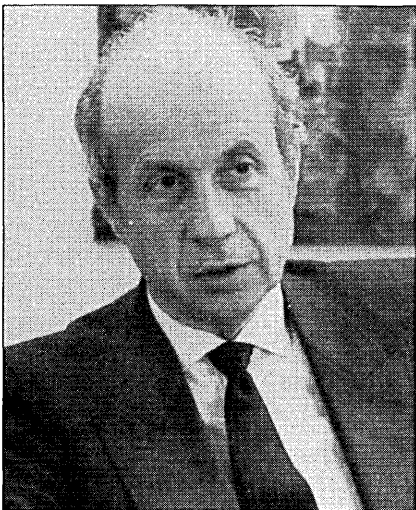

Georges Pebereau, managing director of Compagnie Générale d'Electricité

its affairs. French firms had owned 33% of Olivetti before the CGE agreement.

Olivetti is hoping to hook up with other outsiders to build its telecommunications base. The newly created CGE/Thomson company is also looking for North American partners in the OA and telecom sectors. One rumored candidate is the U.K.'s Plessey, which bought the public switching division of U.S.-based Stromberg Carlson at the end of last year. Thus, Plessey could theoretically provide the CGE/Thomson venture with the bridge it needs to

break into the American market. Some industry watchers, however, feel that a pact with Plessey would be a mistake. "Plessey," according to one analyst, "doesn't have much of a future in public switching."

And what about CGE/Thomson's overall future? France is hoping that the new combined company will be able to win significantly more worldwide business. The current setup, however, is not enough to guarantee a prosperous future for a company that will still have to fight tooth and nail against such giants as AT&T and IBM.

## Remember the Seminar of 1776?



## If Computers Existed 200 Years Ago, These Men Would Qualify as Seminar Leaders for Technology Transfer Institute

### BENJAMIN FRANKLIN

As developer of the Post Office would discuss office automation and electronic mail.

### JOHN HANCOCK

Encryption and security.

### ALEXANDER HAMILTON

Electronic banking and transfer of funds.

### THOMAS JEFFERSON

The inventor of indoor plumbing would discuss local area networks.

## You Won't Forget the Seminars of 1984!

When you need to learn about a specific subject within the computer/communications and data processing industry, you really should learn from an expert. As those men were so considered 200 years ago, so will our speakers be 200 years from now. Call or send for our newest Spring 1984 brochure outlining all of our offerings. We urge

you to attend one of our seminars and discover why TTI seminars have become the standard in the field against which others are measured.

**Call or write today for further information including cities and dates:**  
**(213) 394-8305**

- Database: A Manager's Guide — HOLLAND
- Database: A Builder's Guide — HOLLAND/COLE
- Implementation of Database Systems — BERNSTEIN/GOODMAN
- Relational Data Base — CODD/UPHAM/WEINBERG
- Executive Strategies for the Information Age — HOLLAND
- Information Center Software Selection — ATRÉ
- Queueing Systems and Computer Applications — KLEINROCK
- SNA — MARKOV/PIATKOWSKI
- Experts on Networks — KLEINROCK/WARMEN.HOVEN/WEIR/ROBERTS

Please send me more information on the seminars I have checked

- James Martin 1-Day Seminar
- James Martin 5-Day Seminar

NAME \_\_\_\_\_  
COMPANY NAME \_\_\_\_\_  
ADDRESS \_\_\_\_\_  
CITY/STATE/ZIP \_\_\_\_\_  
TELEPHONE \_\_\_\_\_ BSE 3/84

- Strategic Planning for Telecommunications — McQUILLAN/GUESTS
- The Integrated Voice/Data PBX — ÖPDERBECK
- IBM MVS I/O Configuration Management — ARTIS/BUZEN
- Structured Techniques for Fourth Generation Languages — McCLURE
- Capacity Planning — BUZEN/DENNING/SCHWETMAN
- Controlling Software Projects — DeMARCO/LISTER
- The Micro-Mainframe Connection — McQUILLAN/MATHAISEL
- Evolving to Electronic Banking — SVIGALS/LONG
- Strategic Planning for Office Automation — WOHL/MORGAN

**TECHNOLOGY TRANSFER INSTITUTE**  
741 10th Street, Santa Monica, CA 90402  
**CIRCLE 74 ON READER CARD**

## NEWS IN PERSPECTIVE

### BENCHMARKS

**KILLS MAINFRAME:** Citing chronic architectural and performance problems and escalating costs, Storage Technology Corp. canceled its much ballyhooed CMOS mainframe development project. The effort had cost some \$75 million by the time it was canceled, and company officials expected the cancellation costs would come to an additional \$10 million to \$20 million. The project will ultimately cost the Louisville, Colo., firm only some \$25 million to \$35 million, however, since a limited partnership kicked in the first \$60.7 million. As the projected development costs spiraled upward, the leaders of the 300-investor group balked, forcing STC to toss its own money into the effort—despite company assurances that the product would be able to pull in some \$70 million in revenue during 1984 and become profitable in 1985. The company had expected to sell about 30 units in 1984 and some 2,000 to 3,000 over the mainframe's 10-year life span, but when the effort was put on the block, not a single buyer could be found. As a result, the cancellation will add a sizable write-off to the company's already bleak fourth-quarter earnings statement, although no one at STC would speculate on the size of the write-off or the quarterly loss. STC lost some \$6.9 million in the third quarter, its first quarterly loss ever, and following a flat first half the company is sure to wind up the year with a significant loss. Hopes for a turnaround continue to fade, as the company failed to meet its scheduled shipping date for its optical disk product.

**RESIGNS:** IBM's decision to kill its Josephson junction technology development late last year has cost it the services of Hollis Caswell, a General Technology Division vice president who had oversight responsibility for the Josephson pilot line. Caswell resigned last month to join Burroughs Corp. as vice president for special programs. Caswell headed IBM's Applied Research Division in Yorktown, N.Y., during much of the \$100 million research and development program. In 1978, he became the director of IBM's East Fishkill, N.Y., semiconductor laboratory, where he oversaw the tooling and operation of the Josephson pilot line. Caswell is expected to have discretion in selecting R&D projects for Burroughs, as long as they are consistent with Burroughs' general plans. He will report to Burroughs president Paul G. Stern, the Detroit mainframer said.

**BACK ON TRACK:** Digital Equipment Corp., only three months after posting an earnings plunge that saw its stock price fall \$30 in two days, announced that its second quarter net earnings had risen 32% over the same period in 1982. The upswing gave

DEC a quarterly income of \$80.4 million, compared to \$15.8 million in the previous quarter and \$60.9 million in the corresponding quarter of 1982. Revenues for the period, which ended Dec. 31, 1983, were \$1.4 billion, up 40% from the last year. Company president Kenneth H. Olsen said that many of the administrative problems that had plagued the company and contributed to the first quarter plunge had been solved. "I'm confident that most of these problems are behind us and that the company can sustain the momentum established in the quarter." In solving those problems, administrative expenses rose 51% over last year, to \$308 million. The stronger earnings also reflected increased shipments of the VAX-11 and Micro PDP-11 mini lines and the firm's three micro lines. Some 30,000 DECmate II, Rainbow, and Professional systems were shipped in the second quarter, compared to 19,000 in the first.

**SHAVED AGAIN:** Sperry Corp. cut the prices on its Sperrylink office system for the second time in eight months, this time by an average of 7%. A typically configured Sperrylink workstation, including the desk station, diskette subsystem, printer, and software, now lists for \$7,869. The system must be attached to a Sperry 1100 series mainframe, limiting the potential market for the product. When it was first announced over a year ago, company officials were overjoyed with the system's performance, privately noting that it was even responsible for some mainframe sales. The rapid acceptance apparently caused a rapid saturation, however, because Sperry has had difficulty selling the system recently, company observers say. The Sperrylink system was also the cause of a corporate reorganization at the end of last year, in which the office information systems and communications & terminals groups were merged into an Office Information Systems Division. The current price reductions, which range as large as 34% on some items, follow a 25% price slashing last spring and a major enhancement last June.

**HITACHI PAYS UP:** In the denouement of IBM's suits against Hitachi, the Japanese company finds itself contributing handsome sums to IBM's coffers. At a press conference recently, Hitachi senior executive managing director Yasuo Miyauchi said his company will be paying IBM some \$2 million to \$4 million each month as part of the financial settlement. The money represents both the general settlement and fees covering IBM-derived software currently being sold by Hitachi. As that software is phased out, an IBM spokesman said, Hitachi's payments will decrease. Hitachi has already sent funds over to IBM, which will say only that it has received the money and that the amount is less than half the \$267 million

listed as "other income" in its fourth quarter statement. Hitachi president Katsushige Mita said the payments would indeed decrease in size and that they would have no critical effect on his company's finances.

**ON THE BRINK:** Victor Technologies Inc., the Scotts Valley, Calif., personal computer maker that has endured massive losses and slashed operations, was pushed to the edge of bankruptcy by a group of six of its creditors, which claims that Victor owes them \$12.8 million. The six companies filed a petition in federal bankruptcy court in an attempt to force the firm's manufacturing unit into Chapter 11 bankruptcy proceedings. The manufacturing unit was the only part of the company named in the petition; the parent company, which sells the personal computers made by the manufacturing unit, was not named. Victor as a whole reported a whopping \$37 million loss in the third quarter of 1983, against revenues of \$46.1 million. Arnold Quittner, the Los Angeles attorney for the creditors, said that the \$12.8 million Victor owes those six companies is but a fraction of the total Victor debt—some \$90 million. Quittner said he had been told by Victor executives that the firm would not contest the petition. The six creditors are Tandon Corp., Chatsworth, Calif., \$10 million; Epson America Inc., Torrance, Calif., \$1.3 million; Prestige Electronics, Minneapolis, \$1.2 million; Hamilton-Avnet, Culver City, Calif., \$300,000; and two Hamilton-Avnet subsidiaries, \$8,000.

**NEW PROTOCOLS:** Standards for interconnecting electronic mail networks have been submitted for approval by CCITT, the international standards commission. Known as the X.400 series, the protocols cover the connection of public message systems and the connection of private systems into public ones, according to Ian Cunningham, a Bell Northern Research engineer who headed up the group of company representatives that hammered out the specs. He said the protocols have purposely been made "application independent" so that arbitrary groups of binary data may be exchanged through networks. A protocol for standard memoranda has been set, however, that provides commonly used fields like address and body text so that memos can be processed easily by machines. The body text can include pages of teletext information, Groups 3 and 4 facsimile code, and other standard formats. Among the companies involved in determining the standards are Bell Northern, Northern Telecom, GTE Telenet, ITT Dialcom, IBM, AT&T Information Services, Xerox, and Digital Equipment. Cunningham said that products using the new protocols, which should gain full CCITT approval by the coming fall, will appear on the market by the end of the year.

# OUR 21,000 LPM PRINTER TAKES MANY FORMS.

If you need high volume and flexibility, you should know that the DatagraphiX 9800 isn't just a 21,000 LPM laser printer. It also accepts the widest variety of paper form sizes of any non-impact printer, with form widths of 6.5" to 16" and a length range of 3.5" to 14". And all 9800 printers feature perf-to-perf printing on paper weights of 16 to 110 pounds, depending on paper type.

The 9800 series is an entirely new generation of non-impact, high speed laser printers — with more functions, features, and reliability. It offers up to 34 standard character sets, with a font editor that helps you create a nearly unlimited variety of fonts, logos or signatures of your

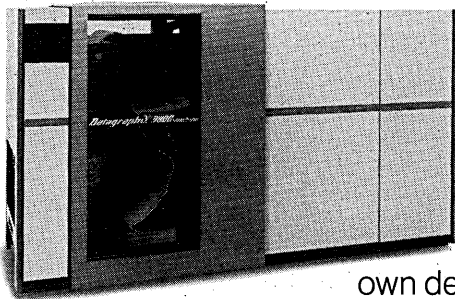

own design.

The 9800 series comes in a variety of on-line, off-line, or on-line/off-line configurations compatible with a broad selection of CPUs. Off-line models offer user-oriented menu-driven software, hard copy log, 6250 BPI tape drives with ping-ponging capability and more. On-line models offer full IBM 3800 compatibility, in addition to the advantages of DatagraphiX's advanced engineering.

Combine these advanced features with excellent print quality and unmatched reliability, and you begin to see why DatagraphiX is recognized as a supplier of superior computer output management products. The full-featured 9800 printers are available now, setting industry standards for up-time in customer sites throughout the U.S. and Canada.

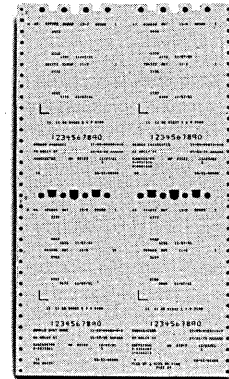
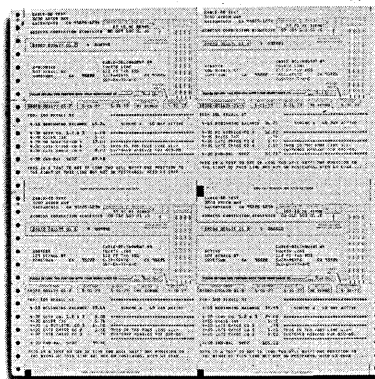
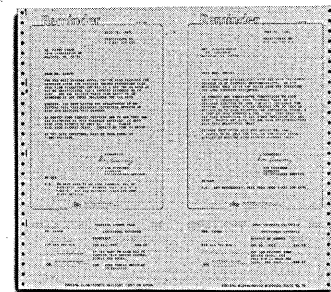
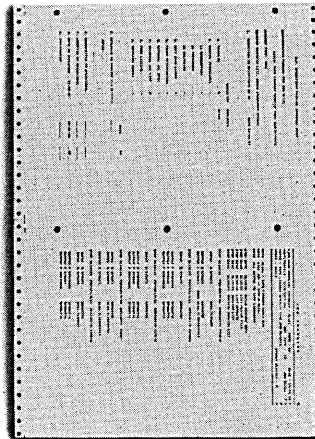
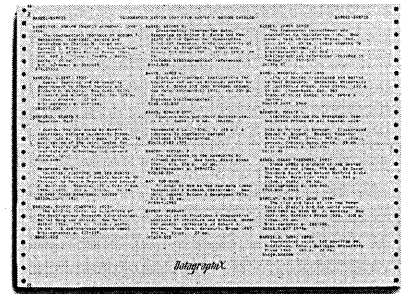
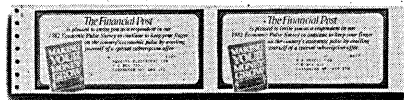
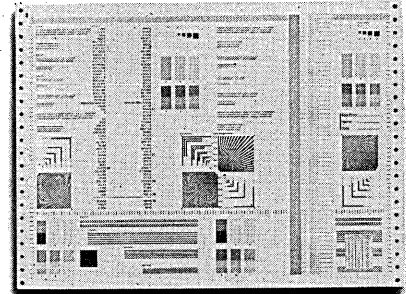
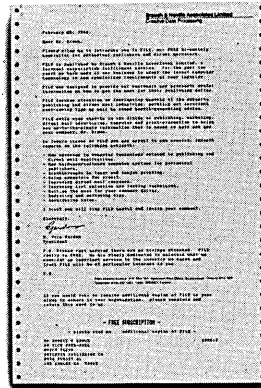

**DatagraphiX**<sup>®</sup>

The Computer Output Management Company  
a General Dynamics subsidiary.

Dept. 3515, P.O. Box 82449, San Diego, CA 92138  
(800) 854-2045, Ext. 5581  
In California, please call (619) 291-9960, Ext. 5581  
TWX: 910-335-2058

# Computers took the strain out of processing data.

## Now Raytheon has taken the strain out of data processing.

Introducing the PTS-1000/4000 family of 3270-type information display systems. Designed to combine mainframe compatibility, operator comfort, and peace of mind for DP managers too.

How can we promise all that?

After more than a decade of experience in 3270 emulation, Raytheon designed the PTS-1000/4000 family to offer the utmost in flexibility, so you can mix and match any of our new controllers with any of our new display and printer terminals.

When it comes to operator comfort, no one offers interactive displays with more built-in ergonomic features than Raytheon. Features especially designed to ease the strain on one's neck and back, hand and wrist, and eyes.

The microprocessor-based PTS-1000/4000 family enables efficient distribution of your data processing workload with flexible configuration options and extensive self-diagnostic capabilities. Binary synchronous, systems network architecture (local and remote), and airline link control

communication protocols are supported. Large and small control units, multiple screen sizes, and a wide variety of peripheral input/output devices and printers can be mixed and matched with varying star, multidropped cabling, or multiplexed configurations.

Special system features include productivity enhancements like local format storage, response time monitors, row/column indicators, and unprotected field indicators.

As for the DP manager's peace of mind, Raytheon offers flexible financing and leasing options, competitive pricing, over 2000 service people worldwide, and a commitment for today and tomorrow that can come only from the largest independent supplier of intelligent terminal processing equipment.

The PTS-1000/4000 information display systems from Raytheon Data Systems. We take the strain out of your data processing. For the sales office nearest you, check your telephone directory or call 1-800-343-6676.



### **Raytheon Data Systems**

Box 7, Marketing Communications  
1415 Boston-Providence Turnpike  
Norwood, Massachusetts 02062



CUSTOMER NAME.....Data Logic.....  
ACCOUNT NO.....9283A.....  
CONTACT NAME.....P. Jones.....  
P.O. NO.....RJ293844.....  
BILL TO ADDRESS.....29 Marylebone..... SHIP TO ADDRESS...(Same).....  
.....London NW15JX.....  
.....England.....

QUANTITY	ITEM	ORDER REF. NO.	PRICE	DATE SHIPPED
26	4C1	238512	43.11	1/86
12	7F2	932910	27.42	1/18
30	3C5	327922	52.38	1/17
41	2X8	729384	81.16	1/23
75	6K7	298342	36.58	1/27
53	8J3	394828	74.99	1/28

ENTER to confirm -- PF3 to cancel -- PFS to continue

→Z532

□M 70 L22 C001

RAYTHEON DATA SYSTEMS

RIDER







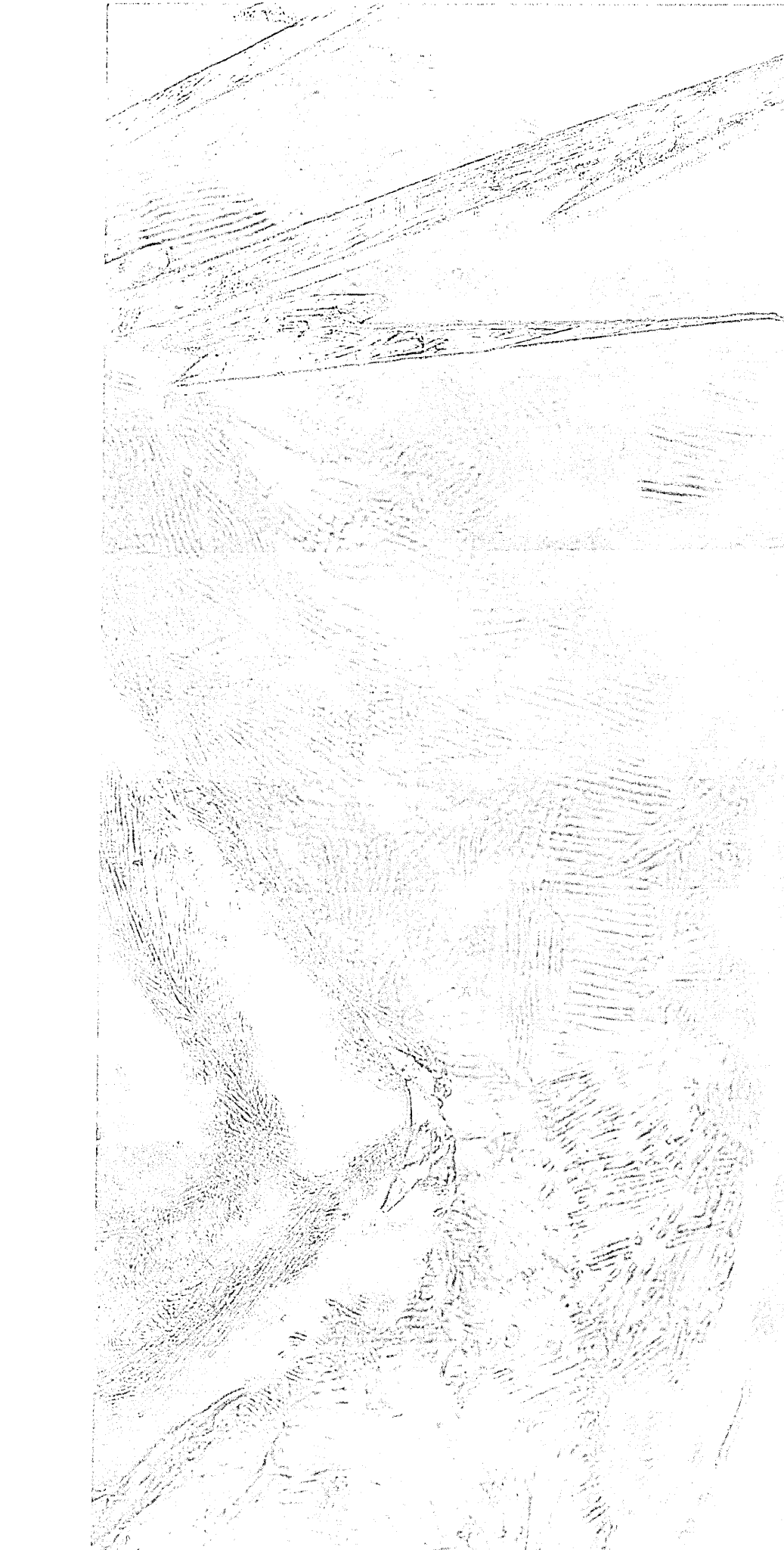

Like *dp* before it, telecommunications is changing from a backroom function to a vital corporate resource.

## TELECOM MANAGEMENT: AN EMERGING ART

by Robert M. Dickinson

Without communications there is no information revolution, no office automation, no computer-integrated manufacturing, no telecommuting, no *flextime*, no private mailbox with disk terminals.

But much is known, and this generation may see discussion which leads to working solutions to these questions: Which computer network architecture is right? What will be the consequences to us of an unregulated, open, competing, or deregulated telecommunications market? But these technological and economic questions have something overshadowed some more fundamental problems: how can organizations best *manage* the telecom function? How can the development of telecommunications facilities best fit in business strategies?

Most organizations have made some attempt to answer these questions with regard to data processing and the *dp* manager. But they are only now beginning to grapple with them in regard to telecommunications and the telecom manager. They have just begun to consider telecommunications in terms of:

- its role and positioning in the enterprise;
- the kind of person who should manage it;
- the professional staff needed to make it work; and
- the major issues they'll have to address over the next five years.

What sort of progress are they making? To find out, we conducted an informal study. We wanted to see if we could begin to answer the question: is the telecommunications manager coming of age?

We gathered information about trends and views in several ways. We searched our files of corporate experience and consulting engagements. We held discussions with our clients from several executive round tables in which we participate—computer, telecommunications, and office automation. We used files on more than 30 clients and prospects, and more than 50 organizations were represented on the various round tables from

PHOTOGRAPH BY MICHAEL HIGGINS FOR ENR

Develcon introduces

# DEVELSWITCH

An advanced intelligent switching system for people who want it all.

Of course you deserve it all. And to satisfy your desire for performance, we're introducing the Model 9006 Develswitch, a technologically superior intelligent data switching system. Once you learn more about it, you'll find that Develswitch stands out from all others with its unique combination of advantages that reduce costs, provide extraordinarily broad applications flexibility, speed communications, enhance convenience and allow for easy growth. If you really want it all for your datacomm network, now you can have it with Develswitch.

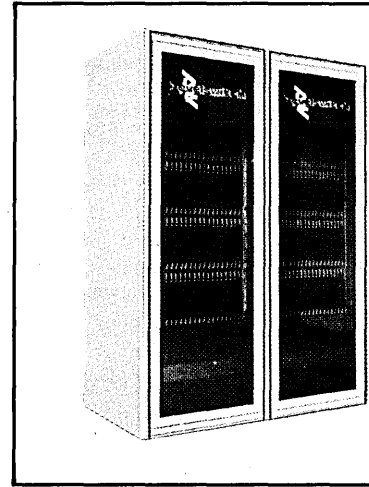

## Develswitch Model 9006 Intelligent Data Switching System — Features/Advantages

The Model 9006 represents the current state-of-the-art in intelligent data switching systems, and the logical evolution of our many years of switching experience. With automatic port contention and selection for thousands of synchronous or asynchronous conversations, the 9006 incorporates sophisticated software enhancements which provide a high level of system customization features never before available, along with many new features that offer unprecedented performance advantages. With Develswitch, now you can have it all. Ask us today for technical literature or applications assistance.

### Consider these Develswitch features:

- CONTENTION AND SELECTION for asynchronous and synchronous lines to speeds of 19.2 Kbps
- ADVANCED SYSTEM SOFTWARE increases applications flexibility, speeds communications, reduces costs
- NETWORK SUPPORT for up to 2000 lines per switch
- 16 USER-PROGRAMMABLE SYSTEM PROMPTS allow customization to meet specific application requirements
- PRIORITIZED QUEUEING with update and exit options
- FIELD-UPGRADABLE MODULES provide virtually unlimited growth capabilities
- SPEED SELECTABLE FORCE CONNECTIONS
- MULTIPLE PROCESSOR CONTROLLERS to accommodate even the largest networks
- OPTIONAL REDUNDANT POWER SUPPLY
- ENHANCED SYSTEM OPERATION DISPLAYS show complete and instantaneous system status
- AUTOBAUD OR CONFIGURED speed/code/party connections
- PARTY LINE CONNECTIONS
- MESSAGE FORWARDING provides current connect information
- CONFIGURATION MEMORY backed up by battery
- ACU SUPPORT
- TANDEM LINK HARDWARE/SOFTWARE connects two or more intelligent data switching systems
- 5 Mbps THROUGHPUT
- SYNCHRONOUS SELECTION via X.21 protocol or Keypad Select Unit
- DOUBLE SAMPLING via operator command
- TRUE AUTOMATIC SWITCHOVER to redundant common logic
- SPECIAL SOFTWARE ENGINEERING SUPPORT through our customized software services to meet your precise application
- 8 CHARACTER PROGRAMMABLE PASSWORDS AND DIRECTORIES
- SELECTABLE TIME-OUT INTERVALS
- SINGLE OR TRIPLE BREAK DISCONNECT
- 43401 OR HIGH LEVEL Limited Distance Data Set line interface cards
- CHOICE OF RS-232, barrier strip and mass terminated backpanels
- INDIVIDUAL DIRECT LINE-TO-LINE ACCESS
- FULL DIAGNOSTICS including over 70 error messages, over 20 statistics and on-line validation of firmware
- SUPPORTS ALL COMMON CHARACTER SETS including ASCII, EBCDIC, BCDIC, correspondence
- COMPATIBLE WITH ALL DEVELCON intelligent switching and data transmission products
- ONE-YEAR WARRANTY, NATIONWIDE SERVICE



**DEVELCON ELECTRONICS, INC.**  
4037 Swamp Road  
Doylestown, PA 18901  
Telephone: (215) 348-1900  
Telex: 84-6389

Develcon data transmission products . . . cream always goes to the top.

CIRCLE 77 ON READER CARD



Develcon Electronics is a leader in data communications technology. We are manufacturers of a complete line of data sets, intelligent switching equipment and network systems.

## A number of companies continue to keep telecommunications outside the IS organization.

which we were able to draw information. Clients and round table members were companies with revenues ranging from \$1 billion to \$100 billion, doing business in communications, computers, financial services, banking, insurance, publishing, and pharmaceuticals. The federal government was also represented.

Finally, we conducted a wide-ranging, interview-based survey of key executives in 25 major corporations. Each responding company is in the Fortune 500 category or equivalent and has relatively large and complex telecommunications requirements. (Again, respondents represented a wide spectrum of industries, including insurance, banking, financial services, communications, manufacturing, petroleum, publishing, and consumer products.) We used a standardized questionnaire to elicit information on each of the topics listed above. Communications managers weren't the only ones surveyed; in over half the cases, we also talked to executives responsible for information services, office automation, and administrative services. We also were able to obtain the views of some senior corporate executives and line managers.

Our results show that the telecommunications function is changing in many ways. To some extent the trends are similar to those in data processing, but there are differences as well. And while general trends are quite apparent, there are many variations among individual companies, reflecting the fact that these companies are in different businesses and have different cultures, styles, and priorities.

### TELECOM NOW MORE IMPORTANT

Without doubt, the telecommunications function is becoming more important and consequently more visible. Telecommunications decisions are much more frequently major ones, requiring the involvement of senior corporate management. The management council of a large manufacturing firm recently spent weeks debating the pros and cons of a full-motion, color teleconferencing project. Line managers, particularly in marketing, are becoming more aware of the need to involve telecommunications experts early in new projects for order entry, point-of-sale transactions, and inventory management. Financial executives have learned that improved financial consolidation and reporting systems depend on efficient and effective telecommunications.

At the same time, there has been a steady trend toward consolidating telecommunications activities under a single manager. The most common organizational positioning for the expanded telecommunications function is as a major component of corporate

information systems (IS). The most frequent example consisted of a telecommunications division within the IS department, reporting to the department head and equal in status to systems development and computer operations. The second most common situation was for the telecommunications division and the computer operations division to be combined under one operations manager, rather than to report directly to the senior IS executive. This was most often the case when the chief IS executive was a participating member of senior management. (There is increasing talk about a chief information officer [cio], but few enterprises have yet adopted this terminology. Our survey indicates, however, that this trend will continue and that we will see the cio or equivalent position accepted in a majority of cases in the next five years.)

A number of companies continue to keep telecommunications outside the IS organization. A few place it in some technical arm, such as R&D or engineering. Others have retained it in facilities management, or in an administrative or general services organization. A few have placed telecommunications on a par with IS, reporting directly to senior management. As might be expected, this is most common where communications services are part of the company's business or form an integral component of some of the company's products.

Many enterprises that have included telecommunications within the IS organization have nevertheless left the operation of one or more networks elsewhere. In some cases the corporate telephone network, and sometimes even the data network, is still being operated by the administrative services department. All our survey respondents, however, felt that this would change over the next five years because of more complex technologies and growing opportunities and pressures for integration. They felt that the telecommunications function would come to include all aspects of communications management: planning, design, and operation.

The most common consolidation of telecommunications components was found to be voice, data, and image transmission (i.e., facsimile). In addition to being responsible for an evolving telephone system, telecommunications people in the consolidated organization are generally leading the way in new initiatives such as advanced PBXs, digital voice transmission, and local networks. They are primarily responsible for planning and designing data communications networks and for managing the data transmission and switching portions of the networks. IBM's Systems Network Architecture (SNA), however, is a special case. Over half of our survey respondents had implemented or were planning to implement SNA. In each case,

responsibility for the project was shared by dp management and telecommunications management.

There is some variation in responsibility for data communications within the data centers themselves. One manufacturing firm assigns all data communications technical control to the communications division. A comparable firm assigns it instead to the individual data center managers.

### TIME-SHARING A DP CHORE

Timesharing was usually viewed as a data processing responsibility, with telecommunications providing only the necessary modems and linkages. Similarly, electronic mail was viewed as a software product, usually assigned to the office automation group. For example, one financial institution implemented an electronic mail system involving several thousand terminals. The project was carried out by the OA group; the telecommunications people were brought in only to assist with installation of the necessary lines. (It's worth noting that computer companies market electronic mail packages as office automation products and deal primarily with the OA people.) Where teleconferencing was being pursued, the consolidated communications departments had primary responsibility in a minority of companies. Teleconferencing prototypes were generally the bailiwick of the office automation group. Full-scale teleconferencing setups—whether full-motion color or freeze-frame video, or even audio-only conferencing—were generally managed and operated by an administrative services organization. Our respondents did not foresee a significant change in these specialized services over the next five years.

Wherever telecommunications was kept separate from information systems, the senior IS executive has almost always found it necessary to establish and maintain internal telecommunications expertise within IS. For example, the IS manager of a leading international communications company established a high-level staff group of data communications experts reporting directly to him. He did this to facilitate his dealings with the corporate telecommunications service organization. He readily admits to some duplication of expertise and effort, but says he cannot function without it. This problem can be expected to grow, since data communications is becoming such an integral part of IS.

As might be expected, changes in the organization and positioning of the telecommunications function require careful study by management. We were involved in one such study—a review of adp, telecommunications, and office automation throughout the bureaus of the U.S. Department of the Treas-

## Telecom pros who view current trends as an opportunity to reach for power are viewed with suspicion by their dp counterparts.

sury. We found considerable variation in how these activities were organized and where they reported. Although the bureaus varied widely in mission and size, ranging from the IRS with 80,000 people down to the 1,200-person Bureau of the Public Debt, we concluded there was a general need for a common approach to these activities. We recommended a consolidated information systems organization for each bureau, including adp, telecommunications, and office automation, reporting where possible directly to the bureau head. Variations in bureau mission and size could be accommodated primarily by tailoring the structure and components of each IS organization.

Similarly, we found in our survey that the most effective telecommunications organizations, as viewed by the respondents themselves, had resulted from recent studies carried out or commissioned by senior management. In one multinational company, for example, corporate telecommunications had always been under the administrative services department. Five years ago, after a high-level study, the company placed telecommunications under a services manager within a new IS department. Recently, the company conducted another study of its entire IS function. Some components were subsequently reduced in size or combined, but telecommunications was expanded and the telecom manager began reporting directly to the IS department head. Fourteen of our respondent companies had recently studied or were in the process of studying their telecom organizations. In all but one case, it appeared that the size, responsibilities, and positioning would be enhanced to some degree. In those situations where organizational problems with telecommunications were identified, the major cause cited was a lag in senior management awareness of the growing importance of telecommunications.

### TELECOM'S ROLE NOW ESSENTIAL

From our work, our contacts, and our survey, it appears that there is an accelerating trend toward integrating telecommunications with data processing and office automation into an overall information function. In almost all cases, moreover, our respondents felt that telecommunications had become (or was about to become) essential to the success of the enterprise, directly affecting the quality and profitability of products and services.

An insurance company that formerly sold only policies now "sells" information first, both to agents and to policyholders, and policies second. Telecommunications is viewed as an essential part of the process. This view came not only from companies in industries such as communications, insur-

ance, and financial services, where information and information delivery has become part of the enterprise product and service portfolio, but also from petroleum, automotive, and appliance firms. In the latter cases, the attitude wasn't articulated as well, because the direct contribution to corporate revenue is less apparent.

There were many expressions of frustration with the lag in senior managements' awareness. This lag is expected to create difficulties in addressing technical issues such as compatibility and integration, and business issues such as improving decision making about telecommunications. In this regard, the telecommunications profession may be contributing to its own problems. Telecom professionals who view current trends primarily as opportunities to reach for power are viewed with suspicion by their dp counterparts and are likely to be mistrusted by senior management. On the other hand, managers who view their role too narrowly will likely delay progress or fail to prepare their organizations for the increasing complexity of the telecom task.

These observations led us to examine the nature of the telecommunications manager's job, and to consider the makeup of the telecommunications staff. Our research confirmed that telecom jobs are changing, along with the role of telecommunications in the enterprise. Like the dp executive, the telecommunications manager is evolving from a behind-the-scenes technician to a front-line member of management, participating frequently and directly in many key decisions and activities. The manager's technical know-how is perforce becoming much broader than in the days when the principal technology was telephony. Moreover, the days when a great deal of technical reliance could be placed on the telephone company are over. With the breakup of AT&T, the technical and business alternatives become much greater and more complex. New technologies and combinations of technologies will further complicate the picture. Most respondents felt that the size of the telecom staff and the number of technical specialties will grow dramatically. Thus, while the technical know-how of the telecommunications manager will have to be broad, it will probably be deep in only one or two aspects of telecommunications, such as voice or data networking. Over half of the telecommunications executives surveyed had come from data processing/data communications. Many of the executives with telephony backgrounds had undertaken major programs to upgrade their skills in other technical areas.

Most significant, all the nontelecommunications executives surveyed felt that it was critical for the telecommunication man-

ager to have good business skills and a solid working knowledge of his firm's activities. Beyond this, there was little consistency as to specific skill recommendations for telecommunications managers. One respondent felt that *any* engineering degree plus an MBA would be adequate. Another placed great emphasis on computer science. A third insisted that the discipline instilled by working as a systems analyst would help ensure a better telecommunications manager. One respondent even argued that a liberal arts major (capable of understanding technical issues) would do best because he could "see the forest and not just the trees."

Both telecommunications and non-telecom respondents generally agreed that the changing role of telecommunications would lead to enhanced career opportunities. They expected telecom managers to gain increased recognition and new opportunities for rotation into other functions—including advancement into senior management. A minority felt the latter would not occur. They believed that telecommunications specialists, including managers, would pretty much remain in telecommunications, although recognition and rewards would improve.

Almost everyone agreed that managerial competency and the practice of management in telecommunications needed to be improved. It appears that in the old days, telecommunications could be pretty much left to roll along by itself. It didn't need much in the way of management focus. Now that telecommunications is being thrust into prominence, there is a need for sound management tools and practices.

### NEED FOR STATEMENT OF ROLES

Our conviction is that there's a need for clear and complete statements of missions and roles. A few organizations have taken this step; the one-page mission and role statement for the corporate telecommunications function in one company starts with the following broad declaration: "Provide high quality, cost-effective telecommunications services to XYZ Corp.'s departments and subsidiaries, in support of business objectives, through capable personnel skilled in providing direction and service within a changing technological environment."

The statement then proceeds to elaborate on specific roles: advising senior management, providing functional guidance to telecom staff in other parts of the company, and managing operational, consulting, and coordination services. The senior management advisory role, as a further example, reads in part: "Prepare advice regarding the effectiveness of telecommunications activities and people, develop recommended ap-



# You Don't Need Five Reports

# ONE

**JARS REPORT WILL DO!**

**Clear, Concise Reporting on All Your Computer Resources**  
JARS consolidates all resource statistics from DOS, OS, CICS, TSO, VM, IMS, ICCF and any data you define — into a single database giving you the one report you need for effective cost distribution in your IBM 360, 370, 303X, 43XX and All PCM environments.

JARS is the comprehensive accounting, billing, cost distribution and performance system which lets you account accurately and bill equitably for all resources used.

**See for Yourself — Proof Positive!**

For additional information on this innovative package,  
contact Johnson Systems at **1-800-368-1010**



8300 Greensboro Drive, McLean, VA. 22102 1-800-368-1010 or (703) 821-1700  
NATIONAL OFFICES: Chicago (312) 655-3490 San Francisco (415) 562-4818 Dallas (214) 247-3252  
CIRCLE 78 ON READER CARD

## The telecom staff will need communication skills not only to explain and clarify, but to motivate and persuade.

proaches for resolving strategic telecommunications issues, and prepare assessments regarding the impact of telecommunications technologies on XYZ Corp."

These statements should be kept current to reflect changes in technology and the business. They should support corporate goals and the roles of other information systems functions. They should be well understood by all parties—senior management, users of telecommunications services, colleagues in other IS functions, and members of the telecom staff.

Our survey indicated that most telecommunications organizations do not formally articulate mission statements. This is unfortunate, because such statements can greatly improve communications among telecom and other parts of the enterprise, including senior management.

Mission statements must be supported by an effective program of management practices, such as managers' accountabilities. Accountabilities are the things that managers and their units are expected to accomplish in a given period of time. They are not the same as individual performance ob-

jectives, since a manager must use his management skills to get things done through others—the members of his unit. Abbreviated examples of managers' accountabilities, which must reflect each company's culture and philosophy, might be:

- Carry out study, make recommendations, and obtain approval for upgraded worldwide message switching system by second quarter 1984.
- Improve throughput of message center by 20% over 1983 and reduce unit costs by 12% under 1983 by year-end 1984.
- Develop and promulgate company policies and standards on corporate facsimile facilities by third quarter 1984.
- Reduce 1983's four-week turnaround time on telecommunications consulting projects to an average of three weeks by first quarter 1985.

These accountabilities may be annual or multiyear, and are supported by detailed action plans. One company we've worked with refers to them as milestones, another as planned managers' commitments.

We asked our contacts and survey respondents several questions pertaining to

managing the telecommunications professional staff. First, we tried to ascertain changes in skills that might be required over the next five years. Not surprisingly, the variety of technical skills and number of people are expected to increase. No particular technical area is expected to decline in importance, although the nature of some may change. For example, voice communications will be digital to a much greater extent, which can't help but affect the voice specialists.

### NEED FOR PERSONAL SKILLS

Besides the universal agreement that better business skills will be required, there was great emphasis on the need for increased personal skills, such as the ability to communicate effectively, both orally and in writing. Respondents felt that telecom professionals will be working much more closely with others—clients/users, marketers, colleagues in other IS functions, etc. Telecommunications people will work with management on projects involving major investment decisions or corporate commitments, such as installing an expensive new PBX or the wiring of a building

## In 1955, the artificial heart valve was just an idea. This year, it saved my life.

For over 30 years, The American Heart Association has invested research money in ideas. Lifesaving ideas like the artificial heart valve, cardiopulmonary resuscitation and drugs to control high blood pressure. Today, these ideas save lives.

Despite this progress, one of every two American deaths is caused by diseases of the heart and blood vessels.

If today's ideas are to grow into the lifesaving techniques of tomorrow, the American Heart Association needs your support now.

American Heart Association,  
We're Fighting for Your Life.

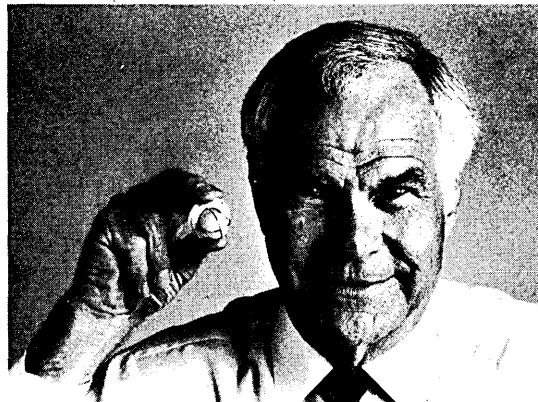

**American Heart Association**

WE'RE FIGHTING FOR YOUR LIFE

with fiber optical cable. They will advise client groups on local area networks, often taking the initiative in such projects. They will help end users solve the pc communications puzzle. They will work with marketers as senior members of project teams in such areas as distributed warehousing, order entry, and point-of-sale data gathering applications. They will work with transportation managers in improving control and utilization of far-flung assets. The list is long and growing, and the telecom staff will need communication skills not only to explain and clarify, but to motivate and persuade. Most respondents felt that programs were needed to upgrade these skills in current and projected staff.

Further, respondents tended to view skills concerns as part of a larger performance and career management problem for telecommunications. We found considerable dissatisfaction with current career management frameworks. A family of consistent, interrelated jobs organized into a career ladder was present in less than a third of our respondent companies. In most firms, job descriptions ranged from nonexistent to an un-

related, out-of-date hodgepodge. A few companies had ladders of titles for IS as a whole, but these were not tailored to telecommunications. Many respondents also felt that the actual process of performance and career management was being neglected. They complained that functions such as career counseling, coaching, and performance appraisal were not being carried out in telecommunications as well as they should be.

There are exceptions. One company we surveyed, and with whom we've worked, has come a long way. Mobil Corp.'s systems and computer services department (SCS) several years ago identified the need for a comprehensive, integrated performance and career management program that incorporated both the framework and the process we have talked about. Telecommunications is a major, integrated component of SCS, with nationwide headquarters and worldwide responsibilities. We worked with Mobil management to develop a separate tailored family of telecommunications jobs, arranged into parallel technical and managerial ladders. For example, the senior telecommunications manager, who carries out his technical re-

sponsibilities by supervising a staff, has a counterpart—the senior telecom consultant, whose main responsibilities are research, evaluation of technology, and high-level consulting with clients.

Each job is described by a job standard that is assembled from master lists of responsibility levels, task descriptions, personal skills levels, and preparation requirements for the next job up the ladder. Each job interlocks with the jobs above and below it, as well as its counterpart on the other half of the ladder. (Each job also relates to its equivalent in other functional areas such as office automation, applications, and operations.) Job titles are consistent with other functions in SCS, and are descriptive enough to be understood by those outside the department.

We also worked with Mobil to institutionalize the process of performance and career management of telecommunications within SCS. SCS management requires that every key assignment be supported by a written objective statement, be reviewed periodically, and be assessed at its completion or termination (or set date for indefinite assignments). Mobil SCS also puts great emphasis

## UPDATE: Protocol Converters

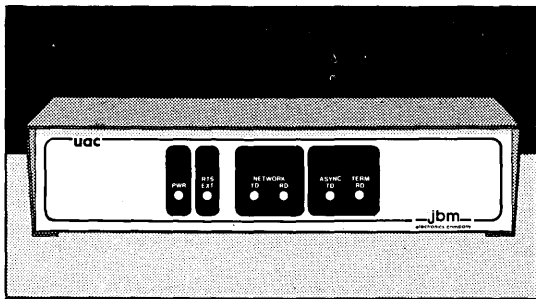

### The JBM 3270 Protocol Converter

The JBM 3270 Protocol Converter provides modular growth capabilities - up to 16 ports and has powerful on board diagnostics for network management. The JBM 3270 Protocol Converter furnishes high performance conversions through a microprocessor for each async device. The cost is low - as low as \$450/port and has proven performance with hundreds of customer installations. JBM provides immediate service and offers a one year warranty on parts and workmanship. For more information about the JBM 3270 Protocol Converter, contact the vendor at:

**—jbm—**

6020 N. Lindbergh Blvd. • Hazelwood, Missouri 63042  
(314) 731-7781  
... the data communications electronics company

CIRCLE 79 ON READER CARD

## WHEN PROFIT IS ON THE LINE, DOES YOUR PRODUCTIVITY MEASURE UP?

### Amcor Software ... The Measurable Difference

Productivity has a major effect on your profit. Accounting Application Software from Amcor can dramatically increase productivity among your accounting staff, while improving the cash-flow within your organization. The powerful reporting capabilities provide up-to-date information for management decisions.

Designed for DEC® PDP-11, RSTS and VAX, VMS computers, Accounting software from Amcor is available for:

- Accounts Receivable • Accounts Payable • Payroll
- General Ledger/Financial Management

Amcor's Accounting Systems incorporate a unique Data Base Design. Our user-oriented products are easy to learn and operate, so you can be up and running in a minimum amount of time.

Please call TOLL FREE at 1-800-626-6268 for more information.

**amcor computer corp.**

1900 Plantside Dr., Dept. D-384  
Louisville, KY 40299



\*DEC, PDP, RSTS/E, VAX and VMS are registered trademarks of Digital Equipment Corporation.

CIRCLE 80 ON READER CARD

**The Northern Telecom system:  
A benchmark in batch processing  
that keeps getting better.**



Northern Telecom batch processing systems have proven themselves, in more than a decade of use in a variety of applications, to be among the most reliable, practical, cost-effective systems ever developed. They deliver more throughput per dollar than any competitive system.

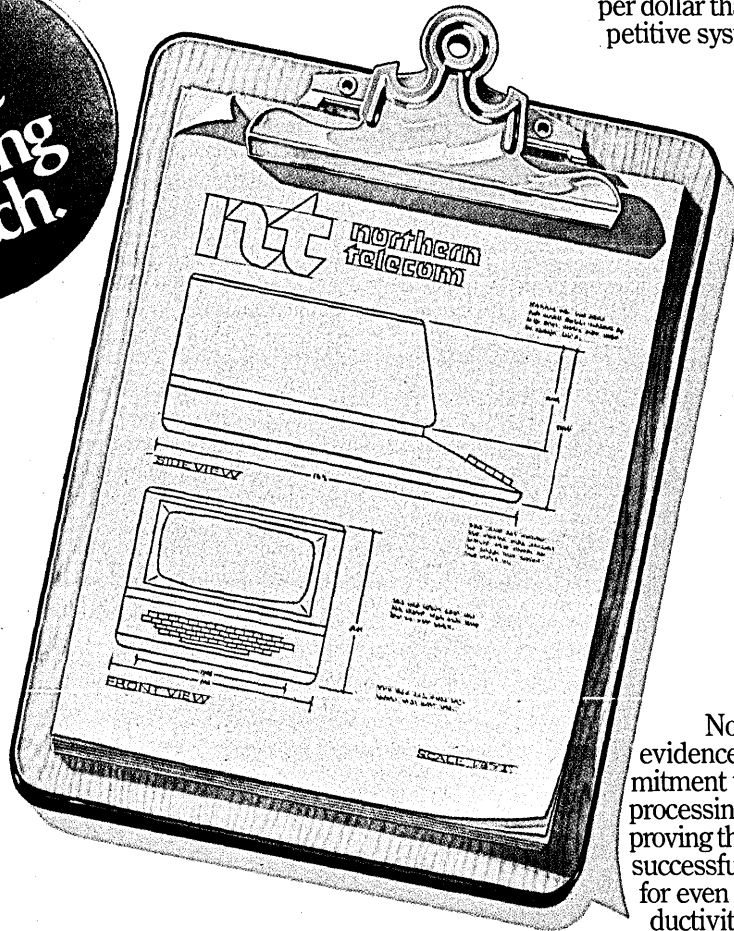

Now, as solid evidence of our commitment to batch processing, we're improving these already successful systems for even more productivity. For

instance, we're introducing a new high-speed band printer with changeable type. Operating now with IBM's SNA, we've also added new, low-cost distributed data processing capabilities for more system versatility, and to provide for future growth toward the integrated office.

# We're back



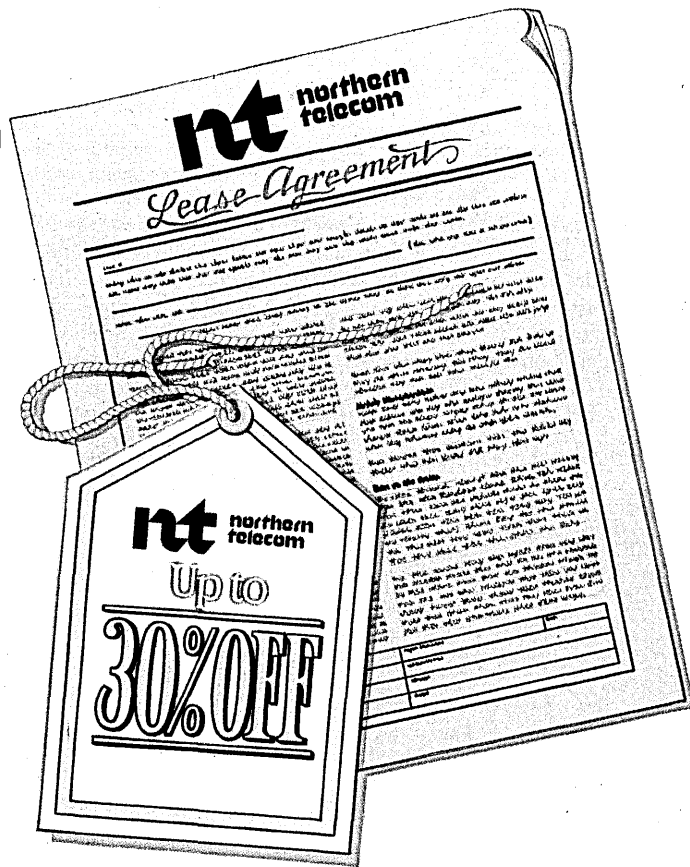

**Time-proven performance with long-term savings.**

Northern Telecom's aggressive pricing is more proof of our commitment to batch. Our discount structure offers long-term savings on multi-year leases. And at renewal time, you can save even more with discounts up to 30%.

**Your processing may be remote, but Northern Telecom service is on the spot.**

With service and maintenance professionals located at 157 cities nationwide, we're able to provide prompt response to your call for service. How fast? Two hours in major metropolitan areas; four hours in most other areas of the country. And our multi-year maintenance agreements guarantee continuing, low-cost operation of your Northern Telecom system.

If your system lease expires within the next six months, *now* is the time to find out more about batch processing from Northern Telecom.

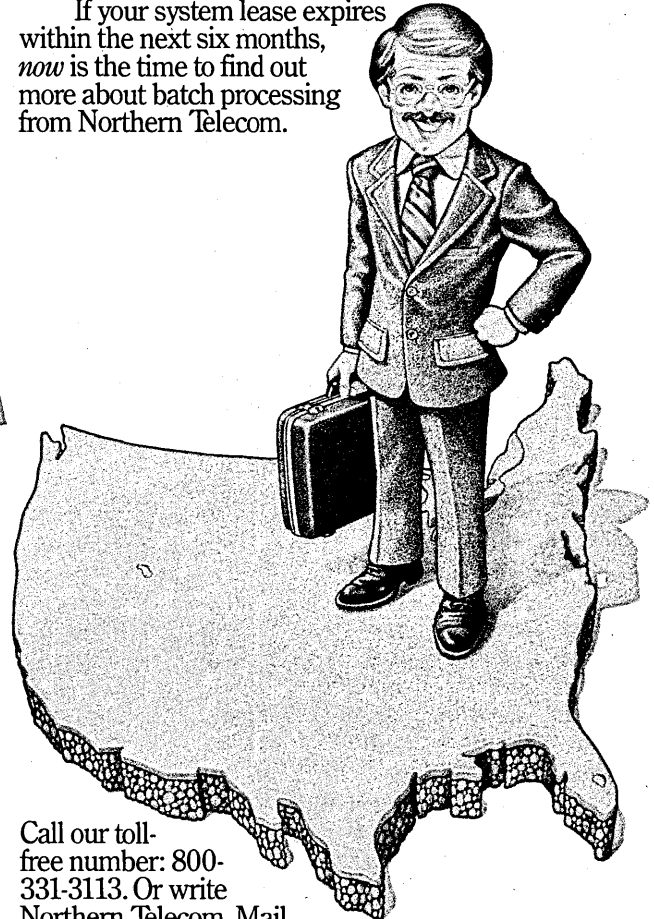

Call our toll-free number: 800-331-3113. Or write Northern Telecom, Mail Station T-240, P.O. Box 1222, Minneapolis, Minnesota 55440. We'll show you how we can tailor a batch system to your specific needs. And save you money, too.



**ing batch!**



## Technical integration challenges abound, but so do organizational, business, and even psychological integration issues.

on continuous coaching by managers throughout the cycle. The results of reviews and assessments form the basis for the annual performance review, which has been a traditional practice for Mobil. Thus, the special, intensified performance and career management program instituted by Mobil scs builds on existing corporate practices. The program has worked well so far, but Mobil recognizes

the need for continual emphasis and reinforcement.

### MAIN ISSUES AHEAD

We concluded our study by asking our contacts and respondents to describe the main telecom issues they expected to have to address in the next five years. Universally, they agreed that compati-

bility and integration would be major challenges for telecommunications as well as for data processing and office automation. Compatibility problems were fairly simple to describe, though not necessarily easy to resolve. Integration problems were much tougher to articulate. Technical integration challenges abound, but so do organizational, business, and even psychological integration issues. Worst of all, the end user doesn't really want to hear any of this. He wants his electronic desk to be as integrated as is his current desk with paper, pencil, and telephone, and he wants the new process to be transparent.

The telecommunications staff obviously cannot solve these problems alone, but they will have to play a vital role. They must be aggressive without being offensive; they must take the initiative but let others take it too; they must lead sometimes, but also be prepared to follow.

Are telecommunications managers coming of age? To some extent the jury is still out, but we're beginning to get some hints at the verdicts. The question is posed in the plural because there will be a plurality of answers. Clearly, telecommunications is coming of age as a technology and a service. It is becoming a vital part of every sizable enterprise, whether government or private. In most cases, however, the nature and positioning of the telecommunications function (and the level of its manager) is far from settled. In the long run, the quality of management practices will determine how much and how quickly telecommunications will contribute to the success of the enterprise over the next five years. \*

Robert M. Dickinson is a partner at Performance Strategies Inc. (PSI), a New York-based management consulting firm that provides tailored programs to help improve the effectiveness, managerial competency, and performance management of information systems functions. Before joining PSI, Mr. Dickinson spent 22 years as an executive with Exxon Corp. He founded Exxon's internal office systems consulting group and helped establish a solid reputation for Exxon as a leading-edge user company in office automation.

# Soup Up System Response Time with the FastDASD Performance and Reporting System

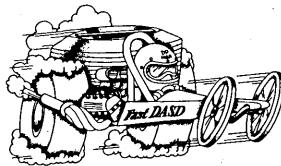

FastDASD steers you around the potential roadblocks in OS supported data centers. Like evolving user needs. Or equipment changes. Or growing demands on resources. FastDASD, a unique software performance system, automates time-consuming DASD analysis and reorganization.

Here are some FastDASD benefits.

**Eliminates CICS and DBMS Degradation.** It identifies data set and PDS contention, then recommends reorganization for faster access times. It analyzes across volumes too, so you can balance I/O workloads.

**Saves Implementation Time.** FastDASD simulates data set reorganizations and shows how system response will improve before you make any changes.

**Interfaces With Graphic Display Systems.** The FastDASD History

File interfaces with SAS® and Easytrieve® to present system trends.

**Speeds Up Moves to New Equipment.** Before the move, FastDASD calculates the optimum data set organization.

FastDASD focuses on key areas of system performance. It records data set activity, seek activity and data set accesses; locates defective tracks; and recommends data set reorganization. Its concise reports show you how to implement performance decisions.

And FastDASD requires minimum training, installs in minutes, needs no "hooks," no IPL's. You can use it immediately.

To find out how you can get behind the wheel and take FastDASD on a 30-day trial drive just fill out and mail the coupon.

Or call 800-368-7638.



Software Corporation of America

455 Carlisle Drive  
Herndon, VA 22070  
Tel. (703) 471-1545

Name \_\_\_\_\_ Title \_\_\_\_\_

Company \_\_\_\_\_ Phone \_\_\_\_\_

Address \_\_\_\_\_

City \_\_\_\_\_ State \_\_\_\_\_ Zip \_\_\_\_\_

OP SYS \_\_\_\_\_ CPU \_\_\_\_\_ #DASD spindles \_\_\_\_\_

SAS is a registered trademark of SAS Institute Inc. Easytrieve is a registered trademark of Pansophic Systems, Inc.

CIRCLE 82 ON READER CARD

Reprints of all DATAMATION articles are available in quantities of 100 or more. Details may be obtained by telephoning Mary Ann Hariton, (212) 605-9729 or by writing to DATAMATION, 875 Third Ave., New York, NY 10022.

What  
three letters  
represent the  
most powerful  
on-line computer  
in business  
today?

# T

## The most powerful on-line

Time was, the answer to the previous page was as easy as ABC.

But that was yesterday.

Today, the world of business computing is being introduced to a system featuring over two-and-a-half times the performance and twice the price/performance of its nearest competitor.

A versatile system. Able to compile the information of the largest corporations into a single relational data base. Instantaneously updated and fully available across the entire system.

An expandable and compatible system. Allowing the simple addition of future programs and equipment, without sacrificing past investments.

And most importantly, a system that won't let you down. Because its fault-tolerant design won't let itself down. Even if a major component fails.

This system isn't from IBM.

It's from Tandem.

Introducing the NonStop TXP™ system.

### TXP: 32-bit transaction processing.

The TXP system processes high volume loads faster and more economically than any other system. Executing over 100 transactions per second now and thousands of transactions in the near future.

It's built around multiple parallel 32-bit processors. Each addressing 16 MB of physical memory and over a gigabyte of virtual memory.

To help memory keep pace with that kind of processing, TXP pulls 64 bits on each memory access.

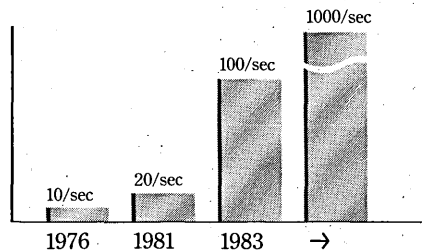

**Our success can be summed up in a second.** Transactions per second. Numbers unsurpassed in the industry. On-line systems that fit your needs today. And tomorrow. With more processing power on the way.

The TXP system also features parallel data paths. Manipulating 32 bits of information in a single cycle, two 16-bit operations in the same cycle.

And TXP incorporates extensive pipelining, to process multiple instructions simultaneously. Each processor overlaps instructions in three levels: Fetching one, while preprocessing a second, while executing a third.

While helping TXP deliver full 32-bit power, for less.

### Cache memory pays off in faster response times.

Cache memory is a high-speed data storage area between the proc-

essor and main memory. It lets the processor store more frequently used information closer. So it can get to it faster.

And our tests have shown that the TXP cache memory has a 98% "hit rate." Which means the requested data is virtually always nearby for fast access.

The result? Larger volumes of work can be processed in shorter amounts of time. Helping TXP to be even more productive.

Making cache memory pay big dividends.

### A system you'll expand, not disband.

Most computer systems have very limited expandability. So if a company outgrows its computer's capacity, it usually means starting again from scratch.

Selecting and buying a larger and more expensive system.

Then reprogramming.

Then re-training.

Plus all the chaotic disruption and

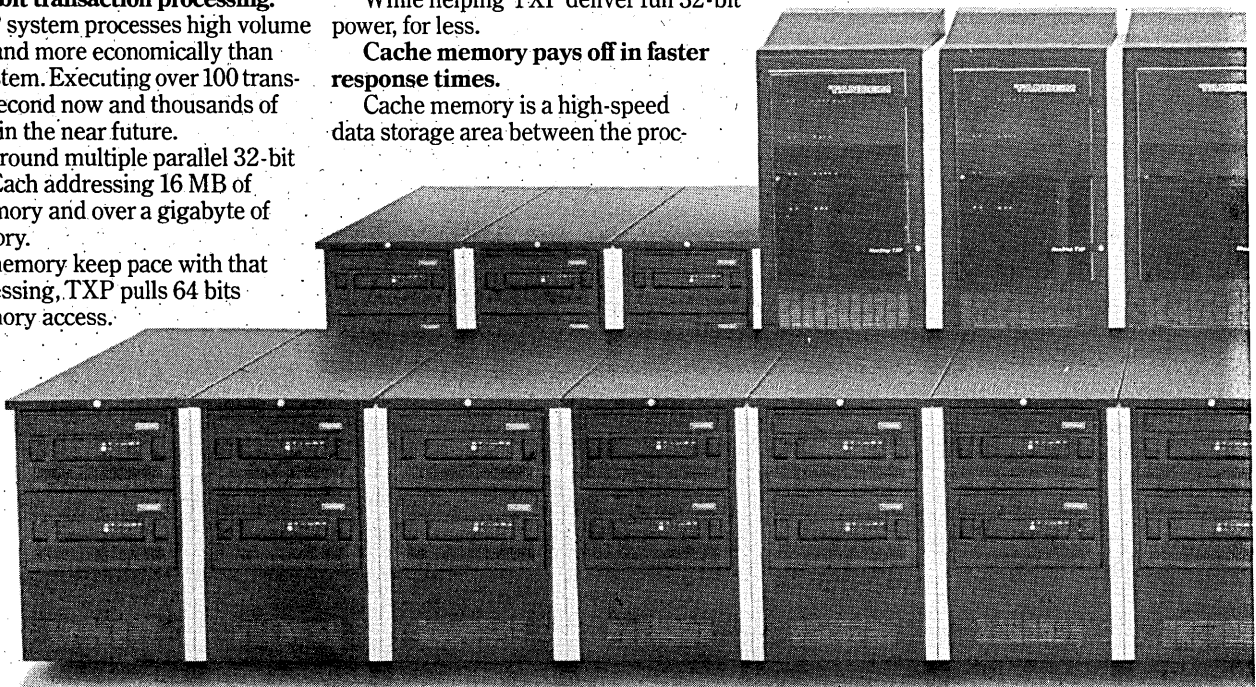

# TP

## omputer in business today.

massive loss of revenue that's unavoidable during the switch-over.

Not so with the TXP system.

It can expand from two to 16 processors. Increasing its power by a factor of eight.

That's more power than any of the largest mainframes.

And the additional processors can be installed while TXP is running at full speed. No downtime. No reprogramming.

Still not enough power? Up to 14 TXP systems can be joined together by high-speed fiber optics. Linking the systems together as one computer with 224 processors.

But that still isn't the full potential of the TXP.

TXP systems at up to 255 sites can be joined in a worldwide network. Generating the power of over 4,000 processors.

And that gives TXP the most powerful on-line computer capacity in business.

Expandability our competition wishes they could disband.

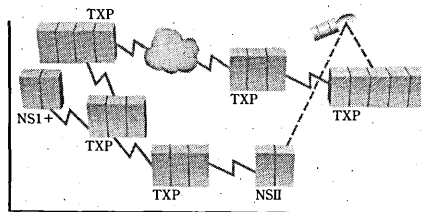

**The most powerful computer network in business today.** Users access a single unified global data base from any of thousands of terminals anywhere in the system.

### **NonStop™ system compatibility from the people who started it all.**

TXP can process more information and support more programs, users and devices than any other computer designed for on-line transaction processing.

Devices you most likely already have. Even devices made by IBM.

But what if your company isn't quite ready for the TXP system's awesome power?

We suggest the Tandem NonStop II™ system. The second most powerful on-line computer in business today. The cost effective solution for medium to large corporations.

What if your company is somewhere between a NonStop II and a TXP?

No problem. They can be combined. They can share the same data and programs. In fact, NonStop II and TXP processors can coexist in the same cabinets.

And what if your company needs even a smaller computer?

We make a smaller computer.

The Tandem NonStop I+ system.

Perfect for those low-volume sites where less processing power is needed.

Tandem literally wrote the book on NonStop™ transaction processing. That's because we introduced the first NonStop system.

Over eight years ago.

And for over eight straight years, despite attempts by others, we've continued to lead the industry.

**Learn all about TXP, ASAP.**

For complete literature, contact your local Tandem Sales Office.

Or write Tandem Computers Incorporated, 19333 Valco Parkway, Cupertino, California 95014.

Or call us, toll-free. (800) 482-6336.

TXP is the most powerful on-line computer in business today.

Without question.

# **TANDEM**

**NonStop Transaction Processing**

CIRCLE 83 ON READER CARD

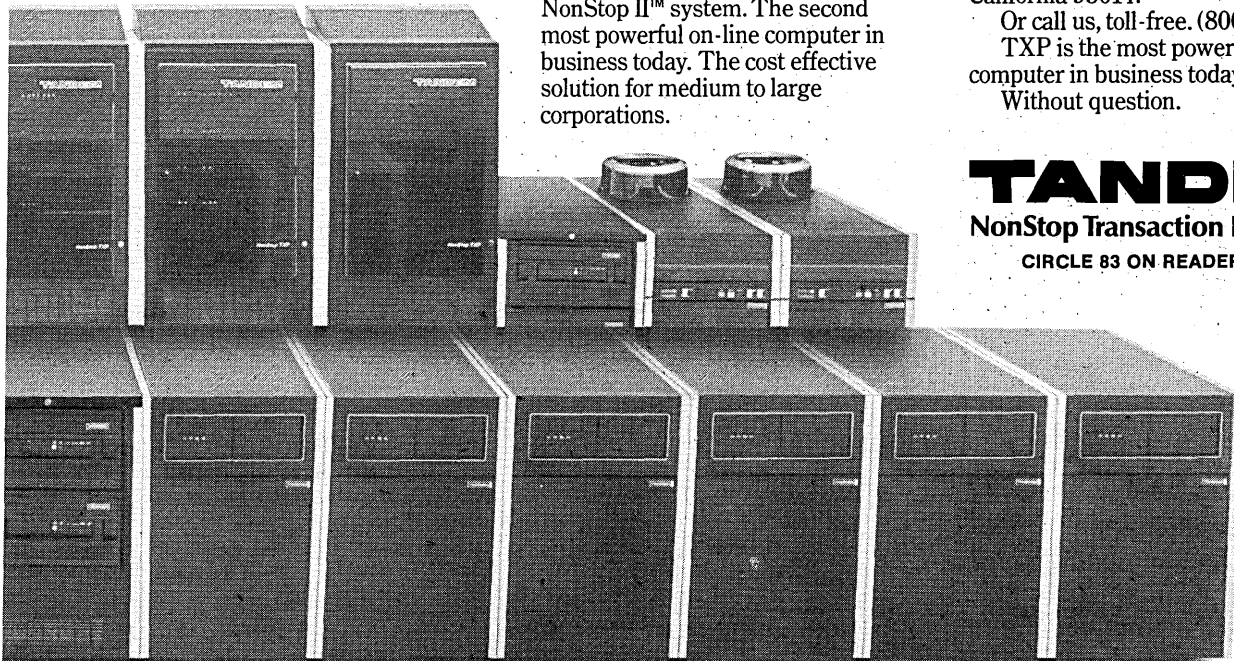

## Will the offspring of these marriages control the future of office automation?

# I, COMPUTER, TAKE THEE, PBX

by William Ambrose and Diane Flood

Computer companies are proposing to PBX vendors, PBX vendors are choosing among some very eligible dp suitors, and the scent of orange blossoms is everywhere. Wedding fever has struck.

What's the attraction? Why are computer makers falling all over themselves to hold hands with PBX makers?

Sure, as the so-called hub of the modern office, the PBX promises to connect all those incompatible dp products now on the market. But the real money will be in the aftermarket—potentially worth gigabucks—that the marriage of voice and data will generate. With billions potentially in the pot, everybody, especially heavyweights like IBM and AT&T, wants a piece of the action.

Meanwhile, NEC and other Japanese suppliers have been building voice and data systems for years, and are already launching integrated products developed internally.

The problem is that the North Americans have had a little trouble making voice-data integration work. Take IBM. The colossus of Armonk has failed to come up with a suitable PBX of its own, has dined briefly with tiny Canadian PBX supplier Mitel, and has recently spent \$300 million for 19.3% of Mitel's archrival, Rolm.

Raising the stakes even higher, IBM is shipping 60,000 PCs a month, most of them to desks with nothing but a phone jack and no hope of any other kind of network connection any time soon.

If IBM doesn't do something, and quickly, its huge PC base will just become a vehicle for someone else's network products. Once that happens, the network aftermarket could slip from IBM's hands. In other words, the PC could turn quickly from IBM's biggest success story to one of the biggest marketing disasters in the information industry's history.

What to do? Line up with a PBX supplier fast.

Other data processing vendors face IBM's problems, more or less. Like IBM, they are jumping on the telephony bandwagon.

But they too are finding that the road to voice and data integration is rough, and most have decided they can't make it alone. Datapoint tried and failed. So did Wang. Telephony supplier Northern Telecom also tried and failed.

To make voice-data integration work and to get a share of the office systems aftermarket, companies are having to learn to work together. For the first time in data processing history, competitors are agreeing to agree.

Wang and Northern Telecom have dropped their patent suit in favor of cooperation.

Honeywell and Swedish telecom giant L.M. Ericsson have set up a joint development company.

Digital Equipment Corp. has cooperation agreements with Northern Telecom, Rolm, Intecom, and Mitel.

IBM, of course, now has a stake in Rolm.

Even AT&T, the giant of telephony, has agreements with Convergent Technologies, Hewlett-Packard, and Wang.

The driving force behind the PBX as hub of the office is the user. Users want to integrate their voice and data requirements in an efficient, economical fashion.

"We are reaching a new period in the industry," says Paul Byrnes, vp systems architecture, Honeywell's Information Systems Division. "There is a coming together of voice and data communications as more of an integrated services offering. The industry is moving at such a pace that soon it will not be uncommon to see voice/data terminals on the desk. [We need] to accommodate integrated voice/data communications."

The PBX is being accepted by computer companies as a key to this integrated office network. "I do see PBX as hub of the office," says Ross Snyder, publicity manager, business systems for Hewlett-Packard. The PBX is "the most pervasive method of integrating office equipment."

The Hewlett-Packard view of the world, according to Snyder, is one terminal per employee. For the most part, communi-

cations between these terminals and the computer will be via the business exchange (PBX) and not the more costly local area network (LAN). (Snyder does point out that for those applications requiring LAN applications, HP will support the faster throughput with a LAN.)

Bob Fleming, research analyst with the Gartner Group, agrees that current PBX generations will be used as hub of the office, in the short term, with users adding LANs as needed, but "in 10 years PBX and local area network technology will merge and there will be one product." According to Fleming, users will want the PBX to be the communications hub because the wiring is in place and because the PBX is already the interface to phone networks.

This view is shared by Honeywell. A data/voice PBX-based network will not necessarily compete with the local area network, says Honeywell's Byrnes. "Even if you have a LAN, you still need systems capability to provide a link to the external information net. You need a system to allocate varied forms of information *outside* the company."

### VOICE-DATA PBX OFFERINGS

PBX vendors have been saying for years—campaigning for years may be more accurate—that by integrating voice and data communications PBXs will emerge as the central controller of the automated office, tying together all communications functions, including voice, data, and, eventually, video. There is a lot of ground to be covered, however, in terms of product capabilities and market acceptance, before PBX suppliers can prove they're right.

To date, only four suppliers have shipped PBXs capable of switching data: Rolm, InteCom, Northern Telecom, and AT&T. And the number of data lines shipped with these companies' products is far from remarkable.

The most advanced voice/data PBX actually being shipped is the Integrated Business Exchange (IBX), produced by Intecom Inc. of Allen, Texas. The IBX provides simultaneous voice/data switching at 57.6Kbps,

PHOTOGRAPH BY ROBERTO BROSCAN





# To find the leader in IBM-compatible display

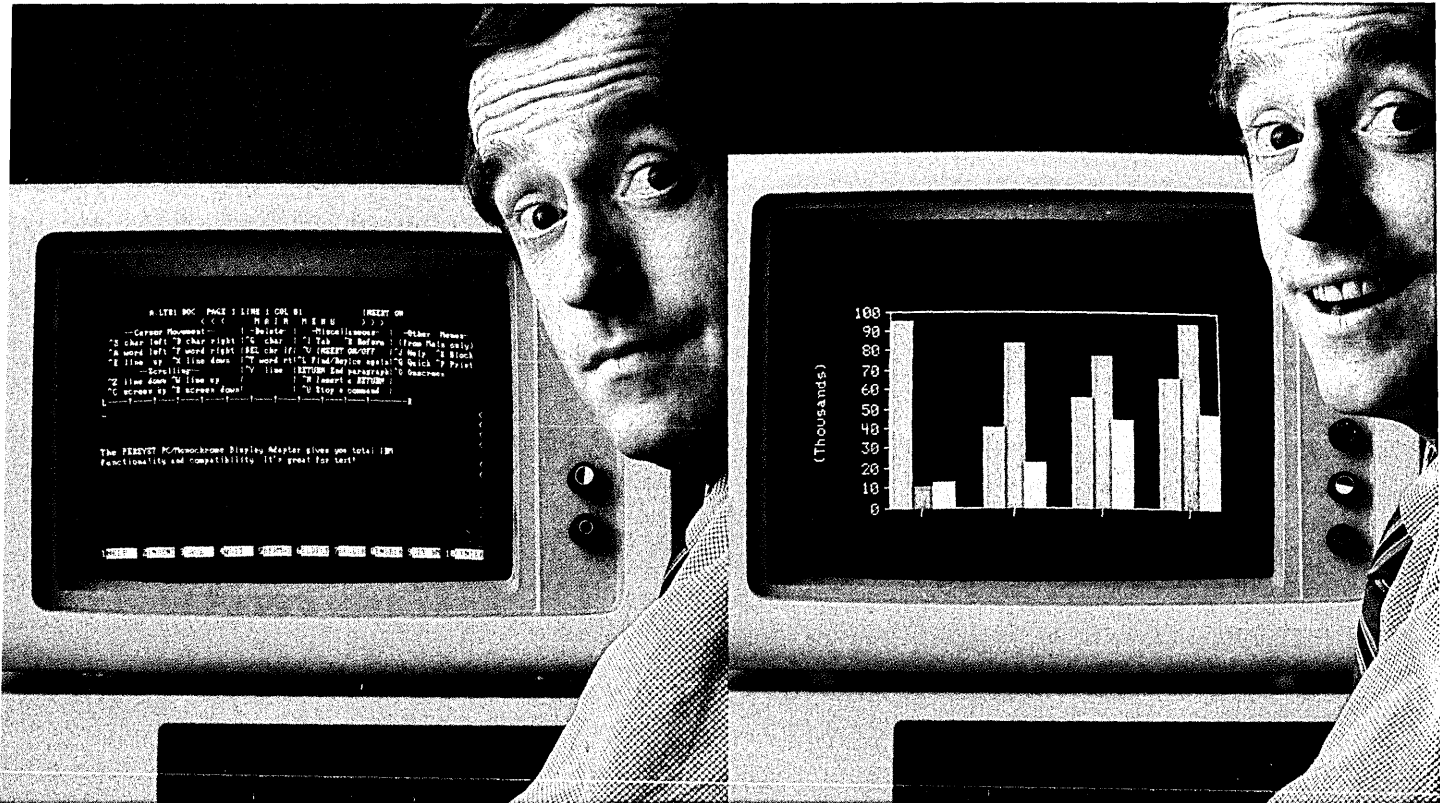

**Persyst PC/Monochrome™. For monochrome text, the same standard of performance and quality as IBM.**

When Persyst first examined the opportunities in the manufacture of display adapters, we began by looking at IBM.

We saw excellent alphanumeric text in monochrome. And good graphics in color.

So we engineered our Persyst PC/Monochrome™ and PC/Color Graphics™ display adapters to meet the IBM standard. These two basic adapters deliver the same reliability, same performance you expect from IBM. With special availability and price considerations that appeal to the systems specifier and OEM.

**Persyst PC/Color Graphics™. For color graphics, the same standard of performance and quality as IBM.**

But mere sufficiency does not earn leadership. So when we designed our new super display adapter, we looked beyond the limits of IBM adapters and IBM display monitors.

And in the process, we redefined the basic utility of display adapters and displays for personal computers.

**The Persyst BoB™ super display adapter. A new system standard.**

Now you can get the clearest, sharpest alphanumeric text resolution ever on a high-resolution\* personal computer display—with a 10 x 16 character cell—in monochrome or color. In fact, BoB resolu-

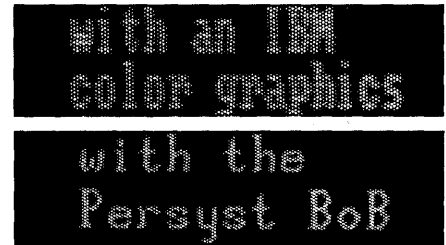

*BoB provides the highest level of text resolution ever. Even in color.*

tion is as crystal clear as anything on an IBM 3278 terminal.

Equally important, BoB provides brilliant support for IBM-compatible graphics packages, with 640 x 200 resolution on both monochrome and color displays. Plus optional 640 x 400 resolution for custom applications.

Which makes possible, for the first time, superior quality text resolution on the same color monitor that handles graphics. BoB, the Best of Both. A new standard.

**Custom programmable character sets. BoB supports special applications.**

What's more, BoB supports up to three character sets. Two in ROM,

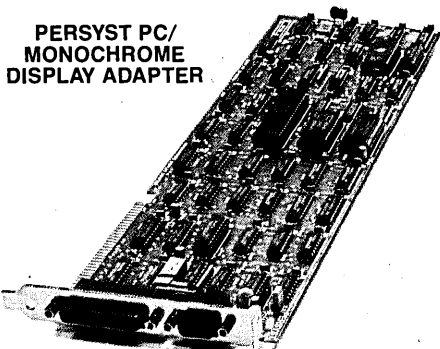

**PERSYST PC/MONOCROME DISPLAY ADAPTER**

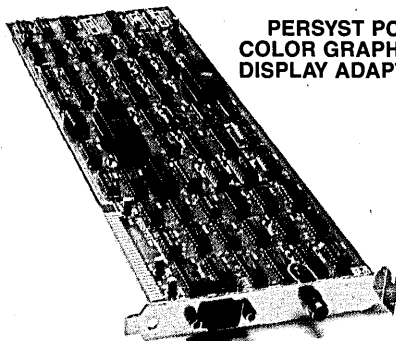

**PERSYST PC/COLOR GRAPHICS DISPLAY ADAPTER**

# Adapters, you have to look beyond IBM.

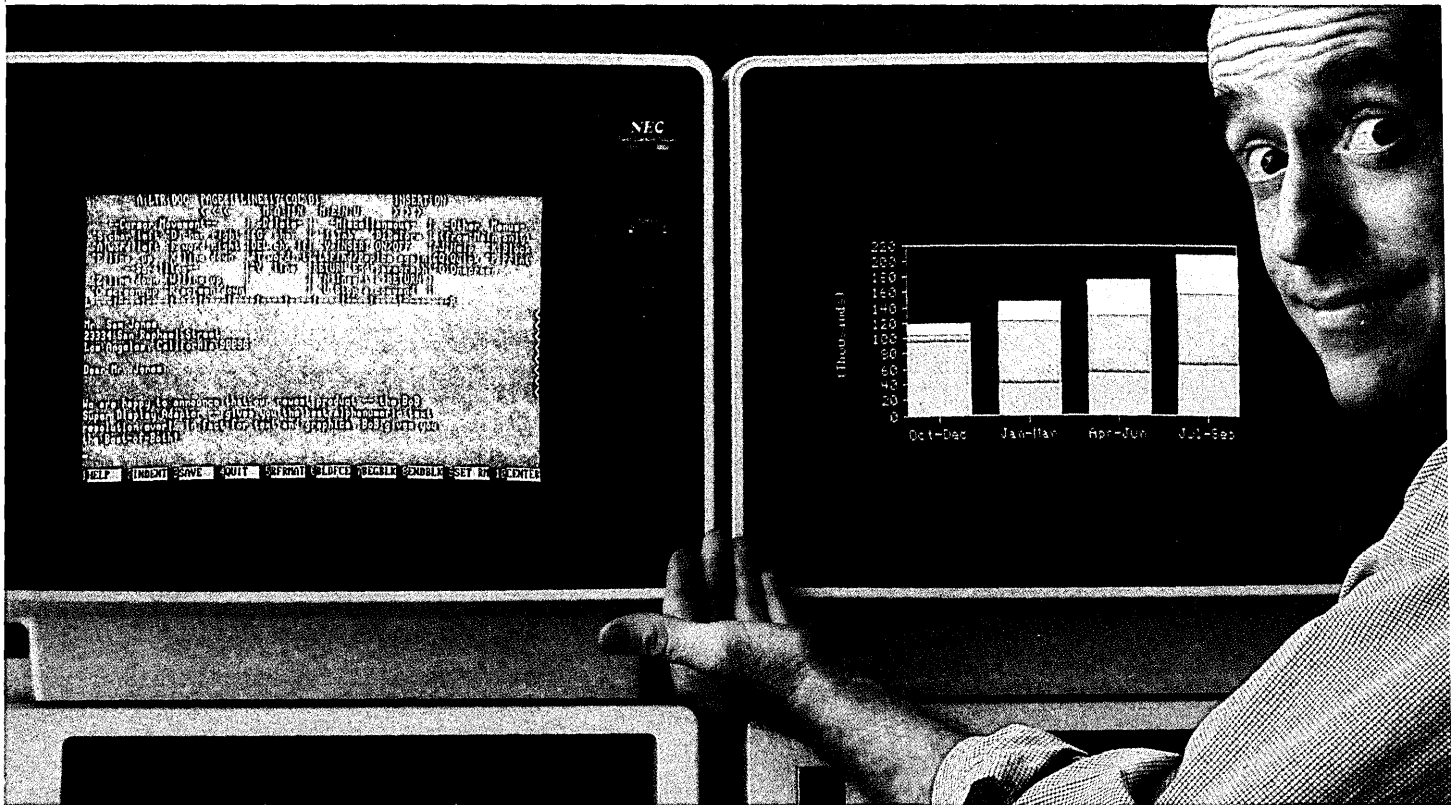

**Persyst BoB™ Super Display Adapter. The highest resolution available for alphanumeric text, excellent color graphics, and programmable character sets together on a single board. Not available from IBM.**

and one downloadable into static RAM.

This unique option lets you design and download up to 256 custom characters. In any combination of language, scientific notation or graphics sets.

So now, you can tailor character sets to your specific application today. And change them to match your requirements tomorrow.

BoB even lets you software select between all three ROM/RAM character sets.

Powerful new flexibility, only available with BoB.

**The widest range of display adapters for the IBM PC. Insist on Persyst.**

Only Persyst can offer the systems specifier and OEM a true choice of display adapters. Monochrome and

color graphics for great basic performance. BoB for enhanced performance.

For complete information, we invite you to call or write Nancy Woodard, Product Marketing Manager.

Persyst Products, Personal Systems Technology, Inc., 15801 Rockfield Blvd., Suite A, Irvine, CA 92714. Telephone: (714) 859-8871. Telex: 467864.



Foreign languages. APL programming language. Scientific notation. BoB permits utilization of any combination of character sets.

**PERSYST  
BoB DISPLAY  
ADAPTER**

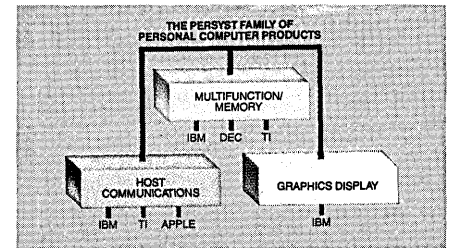
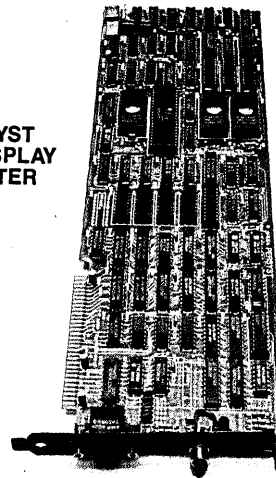

**PERSYST™**  
"You can only do it with Persyst!"

\*NEC JC-1410P2(A), NEC JB-1410P2(A), and other NEC compatible monitors. IBM is a registered trademark of International Business Machines Corp. NEC is a registered trademark of Nippon Electric Corp.

CIRCLE 84 ON READER CARD





# SECURITY

Protect sensitive information with Ven-Tel's 212 SECURITY PLUS. Password restrict any terminal to calling only the destinations and applications you authorize. Telephone numbers, passwords, account numbers, and log-in codes are concealed to prevent unauthorized disclosure or use.

Ven-Tel security is not limited to password protection. You are secure in the confidence that your Ven-Tel modem is the most reliable and dependable in the world.

Security is the assurance that Ven-Tel has committed the investment in research,

development and production facilities necessary to continued industry leadership and provide off-the-shelf delivery.

Security is knowing that the modem you buy from Ven-Tel is the most modern, technologically advanced product available on the market today. It is knowing that when you need help, a Ven-Tel technical support specialist is as close as a telephone call. It is the confidence that Ven-Tel will be there with service and support for your equipment as long as you own it.

For information call: (800) 538-5121.

CUSTOM & OEM CONFIGURATIONS AVAILABLE



**Ven-Tel**

2342 Walsh Avenue, Santa Clara, California 95051 (408) 727-5721

CIRCLE 86 ON READER CARD

## The increasing role that voice switching is playing in office networking schemes comes as no surprise to many.

and with a 10Mbps throughput can accommodate high-speed data as well. Local area network capabilities are now available by adding a proprietary hardware feature called LANmark, which provides Ethernet capabilities within the switch itself.

Other voice/data PBX vendors have retrofitted older voice switches to accommodate data. Rolm began shipping data terminations on its Computerized Branch Exchange (CBX) in February 1982. "Data features are sold almost entirely with new systems at present," notes Rolm's Skip Wilder, data communications product manager. "Our target market is intraoffice communications. Data terminations are used to connect user terminals with a company's computer facilities, i.e., mainframes and minis."

Rolm's new CBX II has much greater data capabilities, switching voice and data simultaneously at up to 64Kbps. The CBX II also has a modular architecture that will allow users to connect high-speed LANs. "The CBX II will act as a traffic cop," explains Gartner's Fleming, "routing traffic and providing a gateway to wide area communication networks." But a fully featured CBX II will not be available until late this year.

Northern Telecom's SL-1 and AT&T's System 85 are designed primarily for voice, and are retrofitted to handle data. AT&T provides data capability for its older analog Dimension PBX as well. Both are moving toward greater data capabilities. AT&T will announce a proprietary LAN for its System 85, and Northern is thought to be working on a "data trap" to shunt data traffic off voice lines and into separate data switches.

Finally, two state-of-the-art systems are just about to hit the market. CXC Corp., Irvine, Calif., and Ztel Inc., Wilmington, Mass., are developing PBX systems. Both systems are fully modular and distributed, incorporating PBX and LAN architecture. Both companies have stated their commitment to the office automation market. "We intend to be the best office communications company around. That means being able to handle a lot of things—computers, peripherals, terminals," said Robert Hawk, vice president of strategic planning for CXC.

### FAILURE TO INTEGRATE

The increasing role that voice switching is playing in office networking schemes comes as no surprise to many. Distributed data processing (ddp) equipment suppliers, in particular, have been trying to integrate voice switching into their systems for years with no success.

Datapoint, San Antonio, Texas, is an example of a company encountering difficulties in providing both voice and data capability. Datapoint's ddp systems are connected

via a LAN the company calls ARCnet. With over 5,000 systems installed, the company tried to develop a switch to handle lower-speed data and voice requirements.

Datapoint began development of its Integrated Switching Exchange (ISX) in late 1977, and five years later, in May 1983, canned the program. Three beta switches had been installed and Datapoint was forced to pull the ISX off the market for one good reason: it didn't work. Datapoint's losses in the ISX program were not substantial, amounting to little more than \$10 million, but the company has stated that it will probably not put money into any further PBX development, either alone or with another company. It may pursue compatibility agreements, however.

On the PBX side of the coin, Canadian telecommunications supplier, Northern Telecom Ltd., once had designs on becoming a leader in end-to-end office automation networks. The telco supplier was hoping to project its extensive voice networking experience into computer greatness. Northern went out and bought Data 100 and Sycor for \$248.5 million back in 1978. Operating losses relating to the company's Electronic Office Systems division (responsible for Data 100 and Sycor) amounted to more than \$200 million from 1980 to 1982. The company states that while that division is still reporting a loss, it is "flirting" with profitability.

IBM failed to develop a switching system for the U.S. market although the company insists that its 1750 analog switching system being marketed in Europe is a viable product. Former IBM chairman Vincent Learson admitted a few years ago that the 1750 PBX "was a dud, is a dud, and always will be a dud." IBM does continue to invest heavily in communications however, with sizable R&D facilities on both sides of the Atlantic. The company tried a technical exchange agreement with upstart Canadian PBX supplier, Mitel Corp., but soon switched to Rolm instead. It is understood that little, if anything, grew out of the Mitel deal.

Internal PBX development efforts by North American computer companies have failed for one basic reason: switching voice is different from switching data. The learning curve of developing voice switching capability was underestimated. To get far enough out on that learning curve requires such heavy investment that companies may be better off looking for technical exchange partners.

The Japanese, by contrast, have had no such problems with internal development. NEC, for example, has an unparalleled balance of expertise in voice and data switching. For decades, the company developed each area separately and has now pulled them together in the System 2400, a new PBX that connects all NEC's dp products. Indeed, much

of what others are still working on, NEC offers today.

As the number of sprouting partnerships indicates, dp vendors have come to realize the difficulties of integrating voice and data on their own. "We realize it is a very expensive undertaking to keep up technologically," says Byrnes of Honeywell. "It is an undertaking too large for any one firm to do. Joint development [with Ericsson] is meant to offset the high costs of development."

IBM, not surprisingly, thinks it will dominate the integrated information processing market. And, wherever IBM moves, its presence makes markets. Within months of having launched its Personal Computer, for example, the company had become the dominant force in the pc industry. With about 60,000 units manufactured per month, the IBM PC is pushing aside leaders like Apple and setting standards in the market for years to come.

All those PC users are beginning to clamor, however, for some sort of communications capability. The easiest way for IBM to solve that problem is via telephony technology, or the twisted pair wires already connecting all the desks on which those PCs sit.

IBM's \$300 million and rising investment in Rolm seems certain to resolve some of these problems and may well render de facto standards for integrating computers, terminals, and the voice network. "Standards will come out," says Richard Moley, vice president of marketing for Rolm, "and other companies can then come in. Customers need choices."

Rolm has high hopes for its relationship with IBM. The IBM-Rolm agreement "doesn't change our strategy," says Moley, "but allows us to move much faster toward fully integrating voice and data on a PBX." Rolm has recently announced a number of products specifically aimed at the office automation market. In addition, the company's CBX II has been designed for future expansion, permitting it to provide bridge and gateway functions between LANs such as Ethernet or the IBM token passing ring LAN.

IBM's investment in Rolm is one indication that IBM is abandoning its closed access policies of old, and that its strategy is shifting to allow greater attachability.

### HONEYWELL AND ERICSSON

Honeywell needs a shot in the arm, and that is exactly what it hopes to gain from its relationship with Sweden's telecommunications giant, Ericsson Inc. of the Ericsson Group of Stockholm. The shot is Ericsson's MD 110 advanced PBX, which will be sold by Honeywell as a stand-alone product and as part of an integrated building control system. Honeywell has a



## Could Burroughs and ITT be examples of companies trying to go it alone?

long-term commitment to integrate voice, data, text, and image processing on a common set of communication facilities.

At the time of the announcement, Jerry Meyer, systems group vice president of Honeywell Information Systems, said, "The strategic importance of these technologies for the development of office systems is well understood. Access to these developing technologies . . . will enable us to bring in integrated communications systems . . . and to plan for future innovative offerings for the office."

While neither company will divulge the extent of its financial investment, the investment in terms of people is significant. Approximately 150 technical people have been transferred from existing Honeywell and Ericsson operations to the joint company.

NCR's only presence in the PBX market is through its 19% investment in Ztel Inc. The investment is at arm's length and so far there has been little exchange between the two companies. "They will want to integrate a PBX-type device," says William Karavatos, vice president, marketing and sales, with Ztel. If Ztel has trouble getting its PBX to market, NCR's \$5 million or so investment will be no great loss.

Karavatos indicated that future product strategies include expanding into more office automation features and terminal equipment. Its NCR connection may prove valuable when it gets to that stage in its development. In the meantime, Ztel continues to work on its PBX, called PNX, which will be available in June 1984.

Other dp companies are expected to get into the courtship of joint ventures. Hewlett-Packard, for example, is on the prowl. Now, however, HP's involvement is limited to technical agreements with PBX suppliers. The company is in a good position to extend its commitment—it ended its current fiscal year with \$750 million cash. "It's reasonable to expect that we'd put our money where our mouth is," says Hewlett-Packard's Snyder. According to Snyder, the company is in the process of negotiating some sort of cooperative agreement.

Wang is another company thought to be on the lookout for a PBX product to integrate with its office automation systems. The company is counting on WangNet, its broadband LAN, to tie together its extensive installed base of roughly 250,000 workstations. But for WangNet to work, it must be capable of switching voice.

Wang says it is trying to develop its own PBX, but if history is any lesson, Wang will be forced to go outside for a product. In the meantime, Wang, like Hewlett-Packard, is pursuing technical exchange agreements.

Equity position agreements such as IBM's stake in Rolm and joint venture agreements such as Honeywell/Ericsson are two types of strategic partnering to make the PBX fit into the integrated electronic office.

A third type of strategic partnering is the cooperative agreement being pursued by Northern Telecom. Northern's first such agreement was with DEC, with whom it developed a computer-to-PBX-interface (CPI). The cooperative agreement with DEC also provides for product certification; joint solving of any problems at customer sites; future product development; and some marketing coordination. Northern's Henry Theloosen, director of product line management, said, however, that these points have not yet been acted upon, though we can expect some action in that area in the near future. Northern's strategy, according to Theloosen, is to sign up a few select companies under its cooperative agreement program. Currently the company has similar agreements with Data General, Hewlett-Packard, and Wang. Theloosen indicated that from eight to 10 companies would be an optimum number in the program, with each company a leader in its particular field.

### USING THE LICENSING AGREEMENT

The fourth level of the computer communications connection is the reciprocal certification of products to permit connection of PBXs and data processing or office automation systems.

CPI and AT&T's Digital Multiplexed Interface (DMI) are good examples. In addition, CPI is being licensed by Northern to a number of computer and office automation companies while DEC is licensing it to PBX companies like Mitel, Rolm, and InteCom.

AT&T announced toward the end of last year its DMI program and the signing of Hewlett-Packard and Wang. At that time, Frank Vigilante, AT&T Information Systems Division president, said, "The announcement clearly signals our intent to open efficient interfaces to our advanced systems and to work closely with other vendors in the information marketplace to help define a universal interface for their equipment to our systems." Specifications are being made available to the public.

Datapoint can be expected to join in on one or both of the CPI and DMI offerings.

Besides Northern's cooperative program, the company has also issued certification licenses to about 30 companies for a \$500 fee. An additional 70 or more compa-

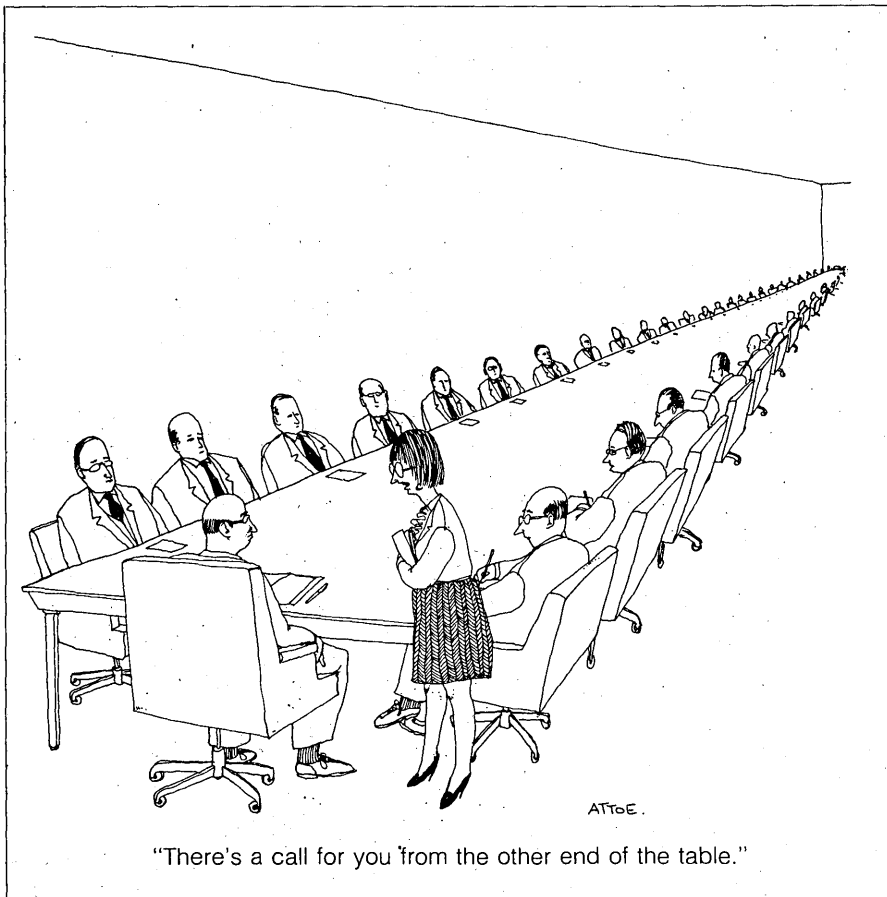

# IF YOU WANT THE BEST APPLICATIONS DEVELOPMENT TOOL, TALK TO THE PEOPLE WHO DEVELOP THE BEST APPLICATIONS.

Of all the applications development tools ever designed, only one has the proven success of our new Millennium SDT.

Because Millennium SDT was designed by McCormack & Dodge, a company with over a decade of proven success developing applications.

M & D design teams have developed everything from accounts payable to payroll/personnel software. Recently, they've won industry acclaim for developing the only family of systems on the market with a genuinely borderless environment. The Millennium series.

What made the Millennium series possible was our discovery of Millennium SDT, a remarkable tool based on a remarkable truth: eighty percent of the functions in all applications are, in fact, generic. Which means that 80% are reusable.

This discovery allowed us to vastly simplify and accelerate our entire systems development process. Tasks that once took months suddenly took days.

If Millennium SDT revolutionized our systems development process, think of what it can do for yours.

Not only will your backlog disappear. You'll be a Millennium ahead.

## START WITH THIS APPLICATION.

Name and Title \_\_\_\_\_

Company \_\_\_\_\_

Address \_\_\_\_\_

City \_\_\_\_\_ State \_\_\_\_\_ Zip \_\_\_\_\_

IBM Mainframe Model \_\_\_\_\_

## WHEN YOU THINK ABOUT TOMORROW, MILLENNIUM MAKES SENSE TODAY.

### McCormack & Dodge

**DB** a company of  
The Dun & Bradstreet Corporation

McCormack & Dodge Corporation, 1225 Worcester Road, Natick, MA 01760  
Sales and support offices throughout North and South America, Europe, Asia, Australia and Africa. 800-343-0325. Telex: 710-325-0329

CIRCLE 87, ON READER CARD

## If history is any lesson, Wang will be forced to go outside for a PBX.

nies have submitted applications for the certification license.

Data General, from the data processing side, has been signing up with companies like InteCom, Northern, Rolm, and United Technologies. Data General's strategy, according to Colleen Fitzgerald, product manager, cooperative ventures, is to "provide the customer with a wide range of communication alternatives utilizing the PBX as an alternative to providing our own product." She continues, "It also allows us to provide our capabilities to the PBX installed base."

What about the biggest of them all, AT&T? What will AT&T, with its huge base of telephone exchanges and prodigious cash flow, do now that it has divested its telephone company subsidiaries and is free to sell computers? For years AT&T has made minicomputers for internal use. AT&T has an enormous base of operating systems, residue of having recently managed 1 million employees. Moreover, its Bell Labs division developed Unix, the operating system that is fast becoming standard for 32-bit micros.

Today, AT&T is trying something new. Following IBM's example with the PC,

the company has arranged to buy office systems from outside suppliers. An agreement with Convergent Technologies has been announced. According to Charles Brown, AT&T chairman and ceo, the company will announce 30 new products in 1984. Many of these are expected to be for data processing and other office data needs.

Notable for their absence from any kind of PBX partnering arrangement are Burroughs from the computer side and ITT from the telecommunications side. ITT does have office automation and distributed processing products—the company recently introduced its personal computer. And Burroughs does have a communications and network group. Could these two be examples of companies trying to go it alone? Or perhaps they are privately working out details of a joint partnering agreement. ITT has recently hired a number of Burroughs people. ITT doesn't yet have a digital PBX, although it is testing CXC's Rose PBX for a possible oem deal.

Consensus throughout all four levels of strategic partnering is that the PBX, or some form of the PBX, will be the hub of the office. Indeed, Northern's Theloosen says, "The

PBX will not only be the hub of the office of the future, it will be a lifeline of the office of the future."

The company, or companies, that gain control of the office network will also have the jump on the add-on peripheral or aftermarket. And that market has a potential value of billions of dollars.

If North American companies want to get the jump on the Japanese, who for their part are well positioned to gain a strong presence in the aftermarket, they will have to stop pussyfooting around and start investing real dollars and developing real strategies and real products. \*

William W. Ambrose is chief industry analyst for Northern Business Information Inc. and editor of *The Telecom Strategy Letter*, which analyzes competitive strategy in the telecommunications industry.

Diane Flood is editor of *The Telecom Market Letter*, a Northern Business Information publication covering telecom market developments.

**"Before, I couldn't get a memo from my CRT to my secretary's word processor."**

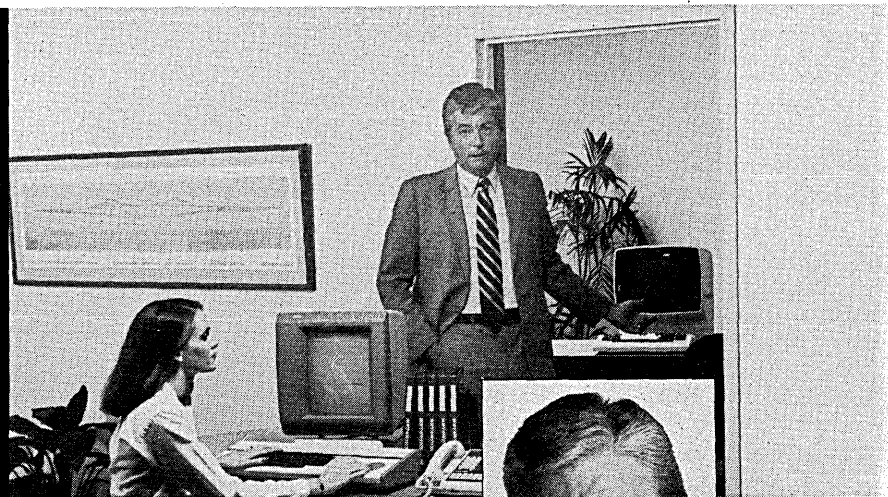

**"Before Soft-Switch,™ that is."**

"It used to be difficult to share information at our company because our office equipment comes from different vendors. Consequently, when we needed a finished document, all of the information had to be re-keyed for the word processors.

"Not any more. Soft-Switch lets us exchange all of that information intact, with no document clean-up.

"Soft-Switch is a Document Control System from ITI, and it runs on our IBM mainframe. It permits documents created on one type of equipment to be used by other devices, regardless of the vendor (word processors, personal computers, printers, etc.).

"Soft-Switch gives us extensive edit level translation capabilities. It stores documents in libraries on the mainframe—no more hunting for diskettes for last year's reports. And routing is simple and efficient. Whether the document goes

to storage at the mainframe, or to a device across the hall, or to 25 branch offices around the country, Soft-Switch requires just one command. Conveniently, the recipient gets the document directly from the mainframe. This is especially useful when you route across time zones.

"It's simple to install and doesn't need much maintenance. The staff likes it because it's easy to use, requires very little training, and just about eliminates document back-up.

"Soft-Switch supports both MVS and VM/CMS operating systems, and it's the first Document Control System that's fully compatible with IBM's DIA/DCA.

"Soft-Switch is available for most major OA equipment. And if you don't have a mainframe, you can still use Soft-Switch by time-sharing through CiSinetwerk Corporation.



"For years you've been hearing about 'integrated' offices.

Well, now you really can integrate what you want, when you want—with Soft-Switch. Check it out. Call ITI."



**Integrated Technologies, Inc.**

... we integrate technologies

200 North Warner Road  
King of Prussia, PA 19406  
(215) 768-9330 • TELEX: 469600

IBM is a registered trademark of International Business Machines Corporation.

**CIRCLE 88 ON READER CARD**

DISCOVER THE DYSAN DIFFERENCE

# What Is The Dysan Difference?

Unmistakable quality. That's the Dysan difference. Only Dysan goes so far in every step of the design, manufacturing and testing processes to ensure precision magnetic media . . . the finest money can buy.

That's why, each and every Dysan Product—from Diskettes and Mini Diskettes to Disc Cartridges, Rigid Discs and Disc Packs—are certified 100% error-free.

And when you consider the amount of time and money you invest loading data onto magnetic media, can you really afford anything less than Dysan quality?

To order, just contact your local Dysan office. Or call us direct TOLL FREE at (800) 551-9000. Discover the difference Dysan quality can make for you.

**Dysan**  
CORPORATION

Corporate Headquarters:  
5201 Patrick Henry Drive  
Santa Clara, CA 95050  
(800) 551-9000



CIRCLE 89 ON READER CARD

# TOUCH ME

### DATA PROCESSING

Touch Me is the most powerful, flexible, and easy-to-use data processing system ever. It's the only system that lets you work with data the way you think about it. You can enter data in any format, and you can retrieve it in any format. You can even create your own data processing programs without writing a single line of code.

Touch Me is the only data processing system that lets you work with data the way you think about it. You can enter data in any format, and you can retrieve it in any format. You can even create your own data processing programs without writing a single line of code.

### BAR GRAPHS

Touch Me's bar graphs are the most powerful and flexible ever. You can create bar graphs for any data set, and you can customize them to look exactly the way you want. You can even create 3D bar graphs, and you can animate them to show changes over time.

### ELECTRONIC MAIL

Touch Me's electronic mail system is the most powerful and flexible ever. You can send and receive electronic mail from anywhere, and you can attach files to your messages. You can even create your own electronic mail system, and you can integrate it with your Touch Me database.

### TOUCH SCREEN

Touch Me's touch screen interface is the most powerful and flexible ever. You can use a touch screen to enter data, to retrieve data, and to create reports. You can even use a touch screen to create your own data processing programs.

### WORD PROCESSING

Touch Me's word processing system is the most powerful and flexible ever. You can create, edit, and format documents, and you can integrate them with your Touch Me database. You can even create your own word processing system, and you can integrate it with your Touch Me database.

### MEMOS

Touch Me's memo system is the most powerful and flexible ever. You can create, edit, and format memos, and you can integrate them with your Touch Me database. You can even create your own memo system, and you can integrate it with your Touch Me database.

### LANGUAGES

Touch Me's multi-language support is the most powerful and flexible ever. You can use Touch Me in any of the following languages: English, French, German, Italian, Japanese, Korean, Spanish, and Swedish.

### PERSONAL COMPUTER

Touch Me's personal computer support is the most powerful and flexible ever. You can use Touch Me on any of the following personal computers: IBM PC, IBM PC XT, IBM PC AT, Compaq, and others.

### POINT PLOTS

Touch Me's point plot support is the most powerful and flexible ever. You can create point plots for any data set, and you can customize them to look exactly the way you want. You can even create 3D point plots, and you can animate them to show changes over time.

### SPREAD SHEETS

Touch Me's spreadsheet support is the most powerful and flexible ever. You can create, edit, and format spreadsheets, and you can integrate them with your Touch Me database. You can even create your own spreadsheet system, and you can integrate it with your Touch Me database.

### AREA CHARTS

Touch Me's area chart support is the most powerful and flexible ever. You can create area charts for any data set, and you can customize them to look exactly the way you want. You can even create 3D area charts, and you can animate them to show changes over time.

### THE SOURCE

Touch Me's source code support is the most powerful and flexible ever. You can view and edit the source code for any Touch Me program, and you can create your own Touch Me programs.



CTM, CRASIC and PASCAL MT+ are registered trademarks of Digital Research, Inc. SUPER CALC 2 is a trademark of Sorcim, Inc. Personal Pearl is a product of RSI Corporation. dBase II is a product of Ashton-Tate Corporation. BSTMS is a product of Broom Software Corporation. CP+ is a product of Taurus Software Corporation. The Source is a servicemark of Source Telecomputing Corporation. IBM is a registered trademark of International Business Machines Corporation.



# Four-Phase is helping more than 2,000 DP managers win the productivity game.

## Now it's your turn.

It's easy to win the distributed information processing game when you play it with the Series 4000 from Four-Phase. The Series 4000 is an integrated, growth-oriented system designed to communicate within your IBM environment. No other vendor gives you so many functions for so many years at such affordable prices. In the distributed processing arena, that's the way to score points with both end-users and top management.

**You win the DDP game with software.**

Four-Phase provides one of the most impressive and complete collections of software ever offered from one company. Our packages make integrating Four-Phase computers remarkably easy. And guarantee a logical growth path for years to come. Here's just a sample of what we provide:

**Interactive processing: VISION®** — For creating custom applications from order entry to transaction processing. It provides a high level of functionality that can be used in any distributed environment. And VISION is easier and faster to program than COBOL.

**Word processing: FOREWORD®** — Our powerful shared-logic word processing system allows text to be entered, stored, edited, distributed and printed.

**Graphics**—For business graphics, the Graphics Management System (GMS/IV) gives you an easy way to condense and conceptually present data that's easily understood by decision makers.

COBOL—Industry standard COBOL is used to write programs for handling keyboard-entered data and general batch processing.

**When they want PC's, you've got them!**

If your end-users are like most these days, they're clamoring for their own personal computers. We play that

# MFE

### The action starts with the Multifunction Executive.

The key to the Series 4000 game plan is the Four-Phase Multifunction Executive (MFE). This unique and powerful control program monitors each multifunction terminal in your system. Its ability to run multiple software programs allows your users to perform 16 different tasks from any terminal on the system. And each of your users can access all of our software packages with one keystroke. You get maximum distributed processing capability and control.

Plus, MFE dynamically allocates selected peripherals so that each device can be used by more than one program. The result—MFE eliminates the need for multiple processors, duplicate terminals and other peripheral devices at installations that require concurrent execution of software.

game, too. Because at the flick of a switch, our multifunction terminals suddenly become stand-alone PC's. So now you can give your users the distributed processing capabilities they need, AND the personal computers they want. All in one integrated system.

**2,000 winners can't be wrong!**

Four-Phase was the first company to introduce the integrated approach to multifunction distributed processing. Today, there are more than 15,000 installed Series 4000 systems, helping people like you manage the information needs of over 150,000 end-users. And every machine is backed by our Customer Support Operation and over 1,000 field service people to provide continuing support and reliability at every level.

Four-Phase customers have been winning the DDP game for years. You can, too. To find out how, call us today at 1-800-529-6050, ext. 1599. In Arizona, call 1-800-352-0458, ext. 1599. For a free poster of this illustration, write to us at 10700 North De Anza Blvd., M/S 52-6A9, Dept. P., Cupertino, CA 95014.

VISION, FOREWORD and Multifunction Executive are registered trademarks of Four-Phase Systems, Inc. MOTOROLA and (M) are registered trademarks of Motorola, Inc. Four-Phase and the Four-Phase logotype are registered trademarks of Four-Phase Systems, Inc. GMS/IV is a trademark of Four-Phase Systems, Inc.

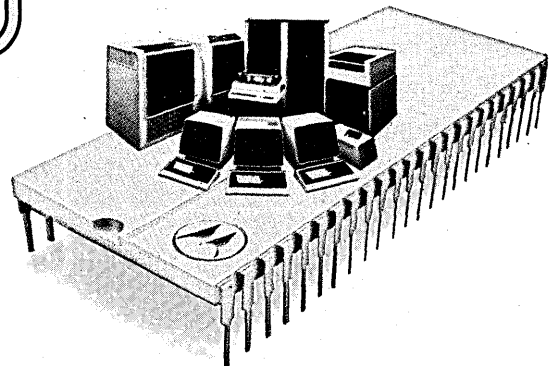

**MOTOROLA INC.**  
Information Systems Group



**Four-Phase Systems**  
The Office Automation Company

# BE A HERO!



## Look carefully at the way your computer installations are protected against fire.

Facts you should know:

- 1.** Fires *do* occur in and around computers—more often than most people realize.
- 2.** When fire strikes, your company risks far more than the loss of valuable electronic equipment. The destruction of vital software and the interruption in business continuity are the real risks.
- 3.** There are many excellent fire extinguishing agents available for structural and other types of fire protection. But only one—Halon 1301—has no drawbacks when it comes to protecting computer installations.

- 4.** Ansul Halon 1301 Systems provide fast, clean, safe, automatic, cost effective fire protection specifically designed for your computer installations.

So be a hero. Remind the people responsible for your business continuity that there *is* an effective solution to the fire problems that threaten your vital electronic equipment and software.

Let us send you our free booklet, "Facts About Protecting Electronic Equipment Against Fire." Write Ansul, Box M, Marinette, WI 54143. Or call (715) 735-7411.

# ANSUL HALON SYSTEMS

CIRCLE 92 ON READER CARD

## Twisted pair or coaxial cable? How to resolve your networking dilemma.

# IS IT THE PBX, OR IS IT THE LAN?

by Philip H. Reagan

That is the networking question for the '80s. In the typical office of the present, terminals and on-line workstations are multiplying like loaves and fishes. At IBM, for example, the ratio of employees to terminals is less than two to one, and at Bell Laboratories there are as many terminals as there are employees. Major corporations and many smaller organizations frequently have multiple mainframes and minicomputers supplied by at least two vendors. And it is not unusual to find more than a dozen manufacturers represented among the terminals, word processors, and personal computers that dot corporate landscapes.

Is the modern, computerized, digital PBX really the machine to tie all of this often incompatible equipment into a coherent office automation scheme? Certainly the old modem-multiplexor methods for networking are fast losing their appeal.

The two alternatives that have emerged are local area networks (LANs) and integrated, voice-and-data digital PBXs. They present clearly distinct approaches to the same problem, and the choice between them is by no means clear.

But, first, what are we talking about?

The newest PBXs transport, switch, and process both voice and data completely in digital form and do it on familiar, twisted-pair telephone cable. These modern phone systems offer a tremendous range of features that improve usability, productivity, and manageability. More than just a computerized switchboard, these new systems can interconnect telephones, terminals, personal computers, word processors, and a wide variety of other office equipment. Major suppliers include AT&T, Intecom, Mitel, Northern Telecom, and Rolm.

A local area network uses a single cable, most often coaxial, to carry a tremendous quantity of data. Devices connect directly to the cable, or, more typically, to branches that tap off the main cable. These are logical connections, accomplished by breaking data streams into packets, each of which carries a variable amount of data and bears the address of both the sending and receiving devices. Thousands, and even tens

of thousands, of devices can share the same cable. And because the intelligence is distributed in independent devices, no single failure can bring down the network. Some of the better known LANs are Ethernet, Datapoint's ARCnet, and Network Systems' HYPERchannel and HYPERbus.

Modern digital PBX systems provide all the functions of traditional PBXs and add features made possible by the digital central switch and by the computer itself. The up-to-date PBX connects, or switches between, phones, data devices, integrated voice-and-data terminals, and off-site phone systems.

It is not unusual for vendors of such systems to offer in excess of 50 features, available mainly as options. Typically, these options are essentially software features, driven by configuration tables unique to each user organization. A system can be specifically designed to meet the needs of almost any conceivable organization. Even more important, these systems can be reconfigured rather easily to handle changing conditions and mobile users.

While PBX systems have obvious advantages for voice traffic, it is their potential for data support that justifies the new digital systems for many users. Some of the major advantages of using PBXs for data are the improved price/performance ratios, the familiar twisted-pair telephone wiring, and the many user and management features.

Price/performance ratios are indeed very good.

In contrast to analog PBXs, which economically support only 3 or 4KHz per voice channel, digital systems typically provide up to 64Kbps per channel. And no modem is necessary for local networking because the signal being transmitted is already digital. Even with higher speed transmissions, the required interface devices are less expensive than most modems. Too, both asynchronous and synchronous data are now supported by most modern PBXs.

Up-to-date PBXs offer many features for data that correspond to features designed for voice support: port contention with queueing, rotary addressing of host ports, speed calling, and access control, among others. Diagnostic capabilities and management control systems also use the same techniques

and resources that are used for voice. These shared capabilities all contribute to the low cost of adding data transmission to a modern PBX system.

Another contributor to the appeal of these PBXs is the twisted-pair copper wiring that connects them to the rest of the world.

This kind of wiring is familiar, well understood, and easy to design and manage. Depending on the vendor, voice and data may use the same pair, or additional pairs and some special wiring may be needed. Each connection, whether it is to a workstation, a host port, or a telephone, requires a pair of wires. When a device is moved or another added, a pair of wires must likewise be moved or added. And while PBXs are usually very reliable systems, they can be shut down by a failure of the switch, the controlling computer, or some other central, shared component.

Centralized PBX systems are particularly attractive in environments with on-line terminals and centralized computer centers. For example, with centralized hosts, the wiring between the PBX and the computer room can often be reduced to a single cable.

Once a digital PBX is installed, it is usually easy to add data to the system. Data terminations can be added a few at a time as needed. This simplifies planning and managing data traffic.

### **GREATER CAPACITY REQUIRED**

As more data lines are installed, more capacity must be added to the switch. Since this capacity may involve a substantial cost, it must be planned carefully. If the average daily use of the network is low, then the cost contributed by the switch is also low, and network costs are moderate. So the PBX solution may be particularly useful in an office environment where terminal use is low.

(Some of the newer systems make intermittent use convenient with easy log-on—"one-touch dialing"—and automatic log-off when the terminal has not been used for a predetermined period of time.)

One problem with PBXs is the high cost of keeping a workstation on-line more or less continuously: the connection requires a dedicated line through the switch. This can

## In contrast to a PBX, a true local area network uses packet switching to achieve high performance through shared access to a single cable.

be expensive. PBX switches are usually designed for about 15% utilization for both voice and data traffic. Luckily, continuous use is rare in most office applications. In data processing applications like data entry and customer information applications, however, day-long use is quite common. In these cases, a PBX is probably not the best solution.

(A data PBX, without the voice, is often an excellent solution because switch costs are low and inexpensive line-drivers can be used. Data PBXs can also be used with existing analog PBXs and their wiring plants by adding voice-over-data modems that put high frequency data signals on the existing wire pairs. This can be an excellent solution in a stable environment with heavy on-line requirements. Data PBXs also have port selection features that allow workstations to conveniently access several hosts. Partly because these systems are aimed at low-cost application, they are simpler and tend to have less flexibility and fewer functions than modern voice-and-data PBXs. Some users consider a data PBX to be a limited, even dead-end, solution.)

In contrast to a PBX, a true local area network uses packet switching to achieve high performance through shared access to a single cable. LANS are effective because data applications often create "bursty" transmissions. Put another way, users' workstations tend to make short transmissions of large amounts of data separated by much longer periods where they transmit relatively little data: peak data rates are much higher than average data rates. Peak-to-average ratios of 100 to 1 and even 1,000 to 1 are typical. LANS take advantage of this characteristic; they use capacity only when they need it. Packets from many nodes can be intermixed on the cable, giving each node the ability to transmit at up to the full link rate—typically 1Mbps or more—when necessary.

These higher rates are becoming increasingly desirable. Both office automation and data processing are using more intelligent workstations, devices that need to transmit and share files and programs with each other as well as with distributed hosts. The increasing use of graphics also requires higher transmission speeds. Moreover, LANS are virtually error-free: powerful error checking and automatic correction capabilities are built into the networks.

To decide between these systems, top management will have to get answers to half a dozen key questions, not the least of which is, what does it cost? Management analysis at General Motors has shown that in recent years 50% of total data processing costs have come from data communications. Because costs at other organizations are approaching similar levels, the need to carefully examine

and manage communications becomes increasingly apparent.

The primary questions that must be asked in order to make the PBX decision are these: What are true current and future requirements? What are the alternatives and their associated costs? What is the impact on the organization? What human factors should be considered? What are the risks? And, of course, that most complex question, how do costs, benefits, implementation schedules, and all the rest interrelate?

Devices are connected to PBXs and LANS in somewhat different ways. A PBX data connection typically starts at the central switch with a data line card. Each card supports a number of connections or lines into the switch. A cable runs from the switch and line card out to the user area. Several pairs are peeled off the main cable to terminate in a wall outlet. From the wall outlet, a multipair cable runs to an interface box or card. The connection unit may be a standalone box or it may be integrated into a terminal or phone, reducing both cost and need for desk space.

Typical cost for the PBX connection device and share of the line card is \$500. When the leading non-Bell supplier, Rolm Corp., announced data capabilities several years ago, the price was \$600 to \$800 per data line. Today, the Rolm price for the same capability has dropped to about \$400 per data line.

To this must be added the cost of a share of the wiring and of the central switch. These costs are much harder to pin down, because they depend on switch capacity and on how much new or supplemental wiring is needed. Added up, each voice or data line usually costs from \$1,000 to \$1,500, installed, with the central switch representing about a third of this. If any line will be in continuous use, additional switch capacity will be needed, easily adding another \$1,000 to the cost of that connection. At the other end of the connection, typically a host computer, costs are similar. Computer port costs are usually several hundred dollars each, with wide variations that depend on the speed and type of connection.

So the total cost, end to end, of each PBX-managed channel, is usually in the \$2,000 to \$4,000 range, depending on transmission speed, availability, and usage.

### LOWER HOST PORT COSTS

LAN costs are very straightforward. For terminals operating at up to 19.2kbps, the per-connection cost is in the \$350 to \$500 range. The host port cost can be reduced by supporting many virtual or logical ports from one network interface card connected to the host bus or channel. So the cost of an end-to-end connection that can be

constantly in service is in the range of \$900 to \$1,100.

To help justify the use of a PBX for data, the argument is advanced that the PBX uses the "same wiring for both voice and data." The "high cost of coaxial cable" used in LANS is then mentioned. Both statements are deceptive.

Can the same wire be used for voice and data? The answer is, "Yes, but at an extra cost."

Almost all modern, digital PBX systems installed today require that one or more additional pairs be used to carry data traffic in parallel with the pair carrying the voice. Only a few of the more expensive systems can multiplex digital voice and data on the same pair of wires. When a careful analysis is made, a cost must be assigned to this same-pair feature, and that cost must be compared to the cost of simply installing the extra pairs.

Next, look at the cost of the wire. It is true that coax costs in the range of \$1 to \$4 a foot, installed, compared to much lower costs for twisted-pair telephone cable. However, each and every twisted pair must run from the data connection back to the switch, often hundreds or even thousands of feet.

In contrast, a single coaxial cable can easily support thousands of data connections and new connections can tap on to the cable anywhere, without running back to a central facility. Many users find this an especially valuable feature in growing environments where workstation mobility is high.

Careful analysis shows that, in reality, the two systems are roughly the same in wiring cost per outlet; the major "wiring" cost turns out to be the outlet itself. Here, the costs begin to diverge, because each coaxial outlet can support many data terminations, and each PBX outlet can support only one. That PBX outlet must be equipped with a data termination back at the switch.

LAN suppliers offer network interface units that connect from two to 32 devices, each operating at 9600bps or more. Where necessary, the coax outlet can be split several times and each split can support additional large volumes of traffic.

When you consider that virtually all new PBX systems require completely new wiring plants, the myth of cheap PBX cable suffers somewhat. So, the cost advantage appears to be clearly with LANS at present. Costs, however, are vastly different for different vendors as well as for each user environment.

The PBX and the LAN both offer their own significant benefits in terms of performance, speed, usability, and flexibility. PBXs, for example, have the advantage of no delay, while LANS will occasionally create annoying delays. On the other hand, LANS



# CalComp puts its reputation on another line.



## The CalComp line of electrostatic plotters.

You already know CalComp as the leader in pen plotters. Now, we've taken our reputation for reliability, commitment and support, and placed it on our complete line of electrostatic plotters.

CalComp's line of electrostatics gives you a choice of 11", 22" and 36" plotter/printers. Each is perfect for plot previewing at an affordable price, and is ideal for mapping, business charts, graphics and a wide range of other

applications. And by using clear mylar media, you can also produce finished-quality drawings.

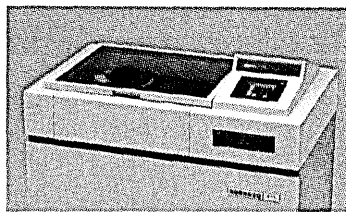

THE 953 CONTROLLER

To make it as easy as possible for electrostatics and pen plotters to work together, CalComp also offers a family of 95X controllers.

These unique and versatile controllers can drive up to eight electrostatic plotters with a pen plotter, freeing your host computer for more cost-efficient tasks.

Let CalComp's sales repre-

sentatives and graphic consultants find the right electrostatic to fit your needs. Write us now, because we're placing our reputation on the line—for you.

CalComp, 2411 West La Palma Ave., P.O. Box 3250, Anaheim, California 92803. Or call (800) 556-1234, ext. 156. In California call (800) 441-2345, ext. 156.

**CALCOMP**  
A Sanders Graphics Company  
 **SANDERS**



## Data communications costs on PBXs will also go down, perhaps even faster than for LANs.

tend to offer higher burst speeds, which may be more important for some users.

In terms of flexibility, the nod has to go to a true local area network where every outlet can support many devices or none at all, and where devices can operate simultaneously at several different speeds. LANs also have the advantage that new outlets are simply tapped from existing cable, while PBXs require that each outlet be cabled back to the switch.

Deciding which technology is the more risky is difficult: both are relatively new, and therefore somewhat untested and unfamiliar. But while some PBX makers bear household names, many of the current LAN suppliers are small or startup companies. There is also the familiar risk of technological obsolescence if the "wrong" solution is chosen.

Potential impact on customers and employees and on business systems and procedures is also an important consideration for management. LANs will have a much greater impact than PBXs because the operational philosophies and the hardware are so different. The PBX, on the other hand, seems familiar, because the PBX data solution is so similar to voice networking schemes; little retraining is required either for users or for maintenance personnel.

LANs, in contrast, present new and different technologies to deal with. But vendors claim the advantages of LANs more than offset this concern. The LAN solution offers higher speeds, multiple virtual circuits through a single connection, and the ability to layer new network features onto existing products. These characteristics present both opportunities and problems for both vendors and users.

Last, we must look into the future. A network will probably be installed in phases, beginning with the most appropriate worksta-

tions and applications. Then, within two years, the typical organization will nearly double the number of on-line workstations. As products and costs change rapidly, it will become obvious that, whatever network technology is selected, much of it will actually be implemented with somewhat different products than originally foreseen.

### ASSESS WHAT'S AHEAD

It is, then, essential to assess what the future may hold. For LANs the direction is fairly clear. Costs will come down at the rate of 20% to 30% a year as products move down the learning curve and into volume manufacture, and as LSI chips perform most of the interface functions now being done with discrete logic.

Higher performance and new features can be added at little cost because the architecture of LANs is layered, allowing new capabilities to be added on top of the data transport facilities. In addition, the performance can be improved within a layer without affecting the interfaces, and, hence, without affecting the application software. This is possible because the interface boxes have their own intelligence and are independent of any central logic or resource.

Data communications costs on PBXs will also go down, perhaps even faster than for LANs. Vendors will discover how to design and build these systems to offer improved integration and lower costs. But advocates of digital PBXs have been forecasting very low cost connections for many years, and these low costs have yet to be realized. It is doubtful that PBXs can catch up with LANs in this decade.

One key question is the extent to which PBXs and LANs can be integrated into long distance networks. Currently, PBX systems do not offer data transmission compatible with public circuits. As a result, the trans-

mission link must be converted as it goes into, and comes off of, the public network. If this problem is solved, it will give PBX-switched data an important advantage and will eliminate the need for modem pools to access these networks. Something similar could happen with LANs and public packet-switched networks; today, LAN gateways are quite expensive.

In summary, circuit-switched PBX systems are most appropriate in a stable environment where workstations are of relatively low intelligence. LANs are more appropriate where the workstations are intelligent, with moderate to high growth and mobility.

In most cases, then, LANs provide the following clear advantages for local networking: lower cost per connection, higher throughput, and greater potential for the addition of new capabilities. PBXs offer familiarity and fewer problems of implementation.

Which of the two, then, offers more? Some feel that the tremendous throughput, many connections per port, and layered applications will favor LANs. Others feel that PBXs based on the ubiquitous twisted-pair wiring and compatible with voice systems will carry the day.

No matter which system is chosen, it will be the foundation for whatever strategies of data communication are to follow. Management must insist that the choice of a networking solution be based on the best possible information about the alternatives.

Here are some pointers that can help you choose the networking solution for your particular situation:

- Characterize your enterprise and its environment;
- Note your problems and your objectives;
- List your alternatives;
- Use numbers, real numbers, where they are important;
- Use the best judgment of the available professionals;
- And, finally, analyze the true cost of each network component based on complete case studies and on firm, comprehensive system quotations. #

Philip H. Reagan is general manager of the San Francisco-based California Systems Group, specialists in data processing and office automation. He has 25 years' experience in the planning, design, and management of information processing systems.

This article is based on material from a seminar developed by California Systems Group and presented by the Center for Advanced Professional Education in Santa Ana, Calif.

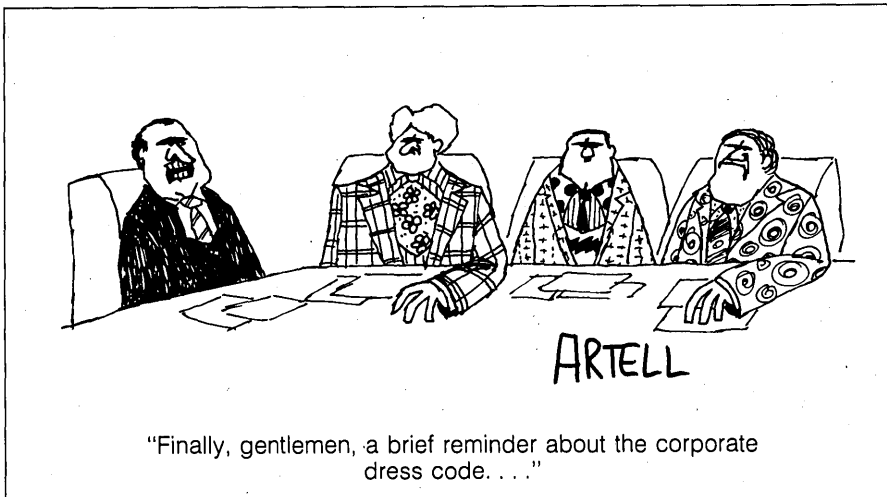

CARTOON BY MICHAEL ARTELL

# SPERRYLINK™

OFFICE SYSTEM

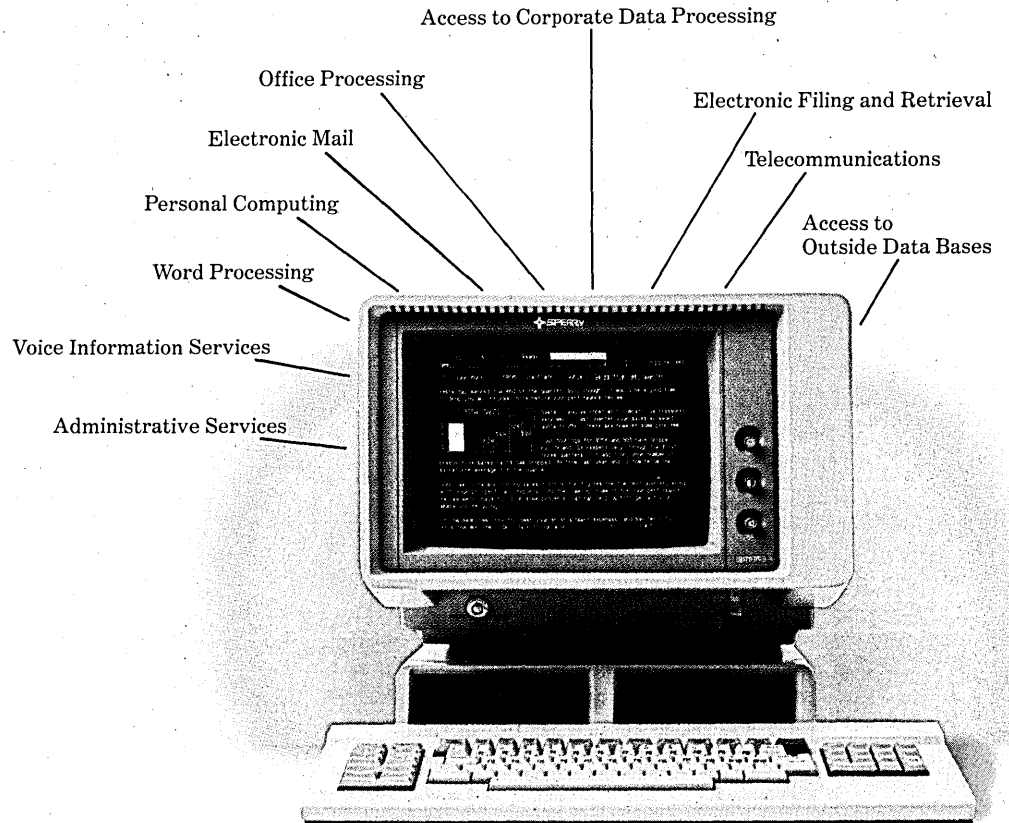

## Just about the only thing it won't do is brew your morning coffee.

SPERRYLINK. The one piece of equipment that can handle all your office automation needs.

It ties into the central computer for mainframe information and mainframe support.

It's a data processor when you need to handle data, a word processor when you need to handle words.

It's a personal computer for filing, retrieving, keeping your calendar, your time schedule, your memo board.

And it's a telecommunications terminal with

electronic mail and digitized voice capabilities—your link to the outside world.

This is the SPERRYLINK System. A system beyond conventional ideas of office automation. Beyond words and numbers, voice and image.

It's the one system that finally brings it all together.

For more information call 800-547-8362, toll-free. Or write us. Sperry Corporation, Computer Systems, Department 100, P.O. Box 500, Blue Bell, PA 19424.



We understand how important it is to listen.

A guide for those who find the language of data communications to be more annoying than enlightening.

by Eric D. Siegel

# YOUR POCKET PROTOCOL PRIMER

Without standardized procedures, communications on a network would resemble dinner-time in a house where the kids have taken over—everyone talks, nobody listens, lots of warmth is generated, but not much information is transferred. Fortunately, such procedures do exist and are standardized by manufacturers and technical committees. These standardized sets of procedures, called protocols, govern the interaction of terminals, computers, and networks. With the increasing interdependence of data processing and data communications, and the increasing va-

FIG. 1  
THE PROTOCOL PICTURE

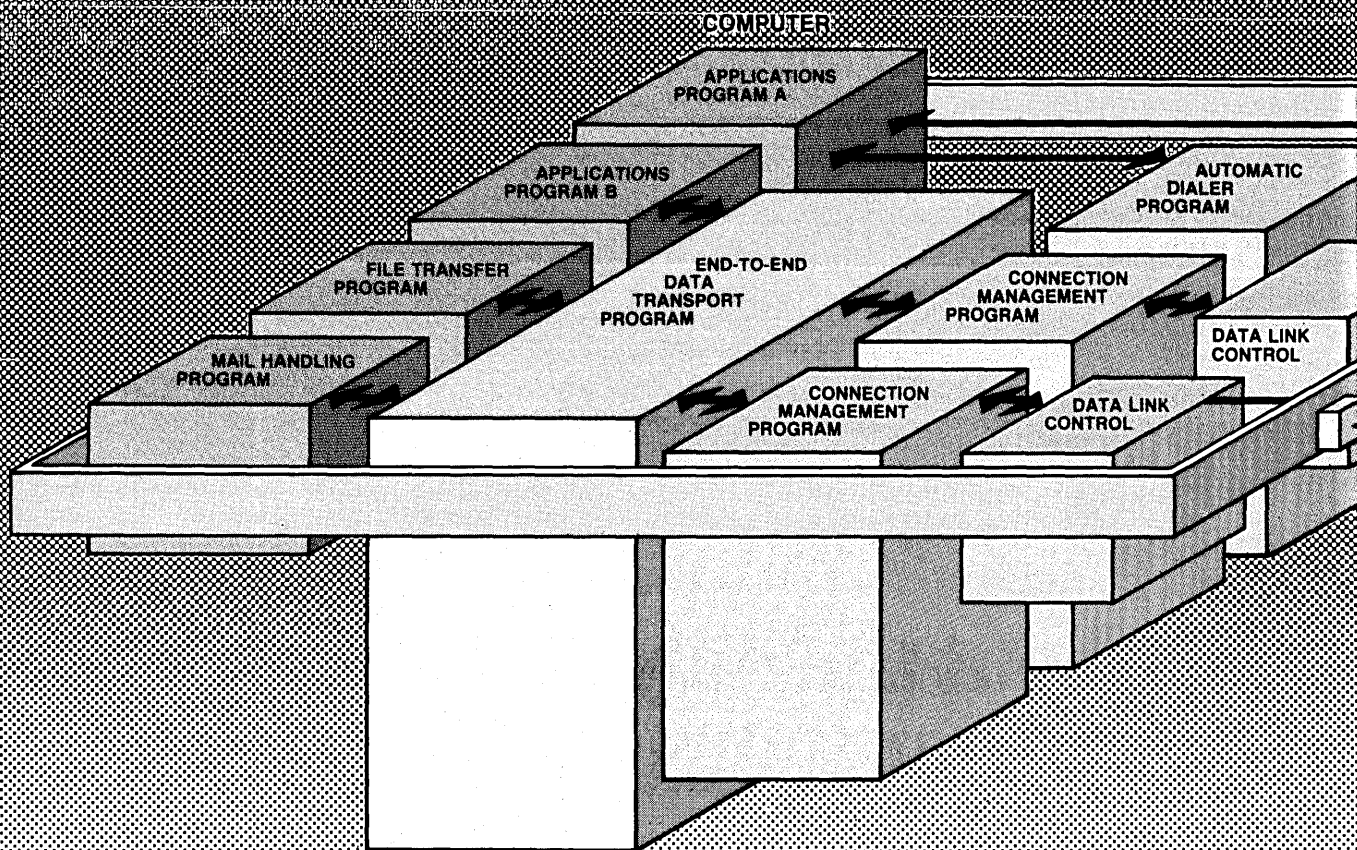

**Physical Protocols  
(Layer One)**

RS232C  
MIL-STD-188  
RS449  
V.24  
X.21 bis  
X.21  
V.35  
303

**Data Link Control  
Protocols  
(Layer Two)**

Start-Stop  
BSC (Bisync)  
HDLC  
SDLC  
UDLC  
BDLC  
ADCCP  
CSMA  
CSMA/CD  
Token

**Network Connection  
Management  
Protocols  
(Layer Three)**

X.21  
X.25  
Request-Response  
Autodial

**Gateway Protocols**

X.75  
IP  
GGP

**End-to-End Data  
Transport Protocols  
(Layer Four)**

TCP  
TP

riety of products and services offered by telecommunications vendors, a basic knowledge of protocols is vital to every dp manager. But as the complexity of the communications task has increased, so has the number and complexity of the protocols. The dp manager attempting to build and maintain a data communications system is often swamped by the resulting jargon and confusion.

It is nevertheless possible to create a readily understood framework that will illustrate the use of the various protocols, such as X.25, Bisync, and HDLC, explaining their relationships in a way that will help the manager understand protocols and deal with ven-

dors and data communications specialists.

Fig. 1 shows the basic protocol framework. It may look complicated at first glance, but it becomes far simpler as we examine it piecemeal—one protocol set, or layer, at a time. We will use the layering convention established by the International Standards Organization in their Open System Interconnection (OSI) reference model. Our task of understanding may be simplified in this manner because, generally speaking, protocols in one layer do not interact with protocols in other layers. The sender's protocol-handling software for a particular layer interacts with the receiver's protocol-hand-

ling software for the same layer only. For example, the layer two protocol, which regulates the transfer of data over a single link, does not interact with the protocol defining the physical connection between terminal and modem (layer one) or the protocol used to establish an end-to-end path through the entire network (layer three). We will start with the layer one protocols and build upwards. *Physical interconnection protocols (layer one)*. These are the protocols dealing with the physical interconnection between the communications system and the data terminal or computer. They specify the shape and size of the interconnecting plugs, the electrical char-

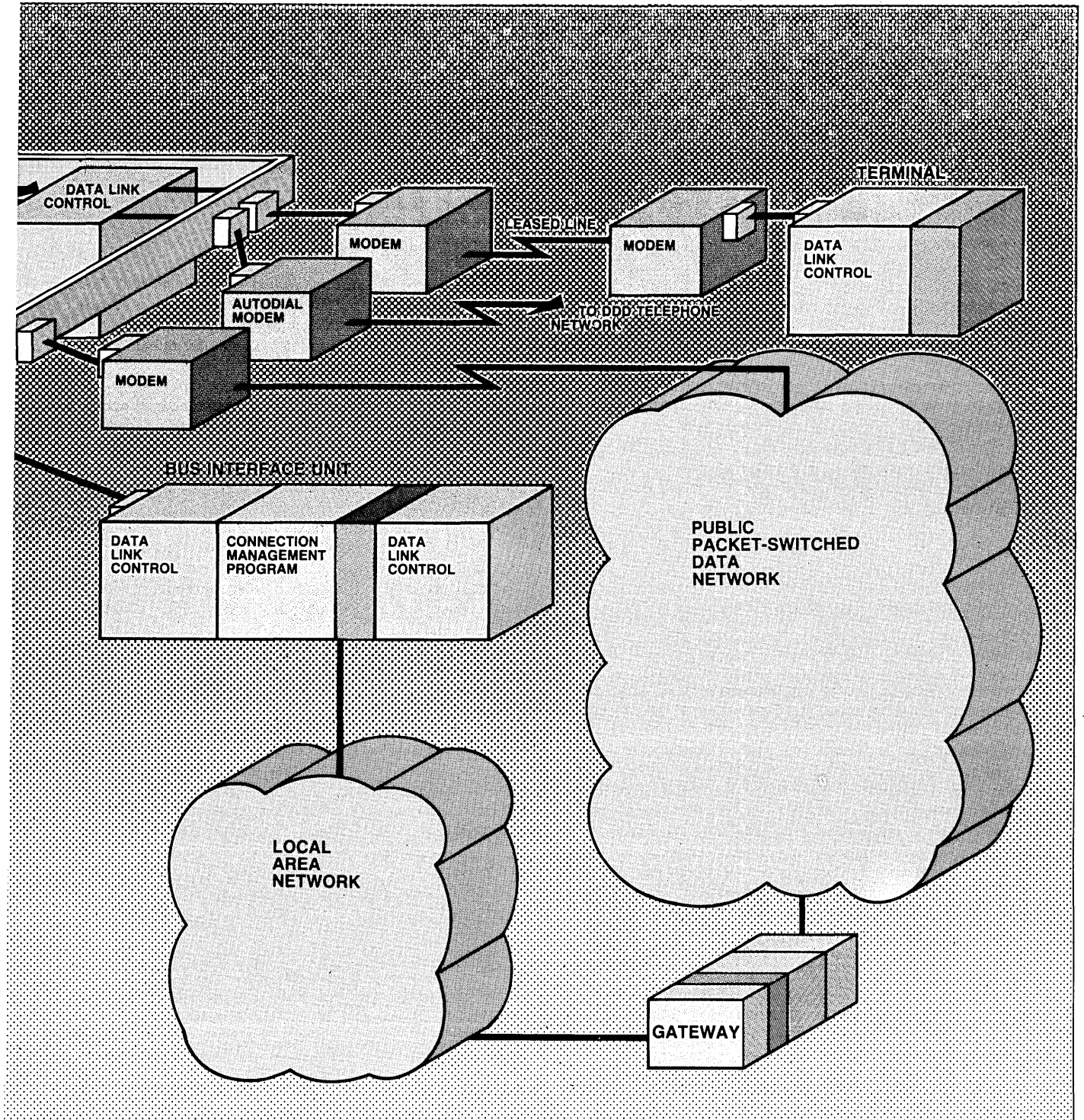



## Specialized gateway protocols are used to control the transfer of addressing, billing, and supervisory information among networks.

acteristics of the signals appearing on the plugs' pins, and the meanings of those signals. Some pins carry data, some carry timing and synchronization signals. Others carry control signals used to coordinate the actions of network and terminal—e.g., a signal indicating that the modem is ready for operation.

Typical standards for layer one protocols are the Electronic Industry Association (EIA) RS232C; the Department of Defense MIL-STD-188; EIA RS449/RS442/RS423; the Western Electric 303; the Consultative Committee for International Telephony and Telegraphy (CCITT) V.24/V.28 (also called CCITT X.21bis); the layer one portion of CCITT X.21; and CCITT V.35. The EIA RS232C (and its equivalents V.24/V.28 and X.21bis) is the most common standard for commercial use at speeds below 20,000 bps, while 303 and V.35 are the common standards at higher speeds. RS449/RS422/RS423 and MIL-STD-188 are not as common, being used primarily by the federal government, but they can usually be connected to RS232C devices with an inexpensive adapter.

*Data link control protocols (layer two).* A simple physical connection is not sufficient to guarantee accurate transmission of data. Both sender and receiver must agree on a protocol to detect and recover from errors, to initialize operations, and to handle multiple terminals or computers on the same physical line. The data link control protocol handles these functions. Software or hardware programmed to handle the rules described in the protocol standard are installed in terminals and computers where they can process data just before the data is transmitted over the physical interface or just after the data is received from the interface.

The start/stop protocol, which is virtually no protocol at all, is normally used for asynchronous (Teletype-like) communications where characters are transmitted individually, without first being collected into groups of characters, or blocks. It specifies only a simple error detecting parity check scheme and provides synchronization for individual characters.

### COMPLEX PROTOCOL STANDARDS

Most nonteletype communications use more complex protocol standards that can handle more of the possible layer two functions. Communicating with compatible layer two software at the remote end of the connection, sophisticated protocol-handling software can detect errors through parity checks or error detection codes. It can also automatically request re-transmissions, and manage traffic on the single link among a number of terminals and computers. IBM's binary synchronous communications protocol, called BSC or Bisync,

was one of the first. The international standard high-level data link control (HDLC) protocol, with its close derivatives SDLC (IBM), UDLC (Sperry/Univac), BDLC (Burroughs), and ADCCP (the ANSI Advanced Data Communications Control Procedure), is a more modern alternative. It is more efficient in its use of the communications system, but requires more intelligence in the terminals.

Local networks use a number of special purpose protocols to govern their very high speed communications. Typical are carrier-sense multiple access (CSMA), CSMA with collision detection (CSMA/CD), token passing, and variants of the HDLC protocol.

*Network connection management protocols (layer three).* For many point-to-point systems, layers one and two are all that are needed. For more complex networks some method of establishing a path or route through the network is needed, whether through dialing or transmission of routing control information. Layer three (network layer) protocol standards define the formats to be used in transactions between user equipment and the network's switching systems.

The simple method used by a computer to communicate with an automatic telephone dialer can be considered to be a layer three protocol. More complex telecommunications services and routing tasks require more complex protocols. Layer three of the CCITT's X.25 protocol standardizes the formats to be used in communicating with the switching nodes in public packet switched networks. (Layers one and two deal with the physical and data link layers.) Similarly, layer three of CCITT's X.21 protocol does the same for public circuit switched networks. Local area networks (LANs) use a simple request and response technique to transfer routing information between a user and the network's bus interface unit.

It is possible to interconnect different networks, allowing data traffic to flow from one network through others to reach a remote destination. Specialized gateway protocols are used to control the transfer of addressing, billing, and supervisory information among the participating networks. Typical protocol standards are the CCITT's X.75 (for use with public packet switched networks that also use X.25) and the Department of Defense's (DOD) Internet protocol (IP) and gateway-to-gateway protocol (GGP).

*End-to-end data transport protocols (layer four).* After a path has been established through a network by a layer three protocol, a layer four (transport layer) protocol can be used to carry the data and ensure that it is delivered accurately, despite any failures on the part of the network or lower layer protocols. These protocols have only recently been developed. Examples are the DOD's transmis-

sion control protocol (TCP) and the new international transport protocol (TP).

*Service protocols.* Usually running as applications programs, some software packages use formats that are standardized by the service protocols to transfer files, mail, and terminal traffic over the connections provided by the protocols discussed above. These service protocols are placed above the layer four protocols in the hierarchy, usually in layers six and seven. Examples are Arpanet's file transfer and virtual terminal protocols.

*What about SNA?* Systems Network Architecture (SNA) is IBM's approach to structuring a computer communications network. SNA defines the rules and methods for constructing a network with IBM's own protocol layering system, and protocols specified for each protocol layer. The functions are similar to those in the OSI reference model. For example, an SNA network uses SDLC to define the procedures used to transfer data across a single data link or around an IBM 8100 system's loop; and, in a higher layer, SNA uses a path information unit (PIU) transmission header protocol to route packets of data between network elements.

*Protocol development trends.* As we have seen, a respectable number of stable, well-defined vendor independent protocols are available for use in layers one, two, and three. But the situation for higher layer protocols is still in a state of ferment. National and international standards organizations are constructing standards for these higher layers, but with a very few exceptions (such as DOD's TCP and the Arpanet protocols) they will not be widely used and thoroughly debugged for a number of years. Until they are, users must rely on vendor-specific protocols that are usually not constructed to handle traffic between different vendor's equipment. \*

Eric D. Siegel is a staff consultant at Network Strategies Inc., Burke, Va., and provides consulting assistance to commercial and government clients in computer network design, network architectural issues, performance measurement, software design, and systems security. He was previously employed at MITRE Corp., and holds a BS and a master's in electrical engineering and computer science from Cornell University.

### REPRINTS AVAILABLE

Reprints of all DATAMATION articles, including those printed in 1982 and 1983, are available in quantities of 100 or more. Details may be obtained by telephoning Mary Ann Hariton, (212) 605-9729.



# Qume's ANSI terminal hits all your hot buttons.



Qume's QVT 103™ has all the features that matter most in an ANSI terminal.

It's fully compatible, providing complete emulation of Digital's VT 52\*, VT 100\*, and VT 131\*. For substantially less cost than any of these terminals.

It's extremely reliable, thanks to Qume's advanced engineering and stringent quality control standards.

And it's backed by top-notch support through Qume's network of repair depots and GE's expert nationwide service.

But perhaps best of all, there's the security of doing

business with a strong, stable supplier. Qume is one of the world's largest manufacturers of computer peripherals, and a subsidiary of ITT Corporation.

Before you make your next terminal order, pick up your phone and hit *our* hot buttons — toll-free. We'll give you complete details on the QVT 103 ANSI terminal, and our other QVT alphanumeric and graphics terminals. Qume Corporation, 2350 Qume Drive, San Jose, CA 95131.

Call toll-free: 800-223-2479

\*Digital and Digital VT 52, VT 100, and VT 131 are registered trademarks of Digital Equipment Corporation.



**THE  
QVT-103™**  
Your best  
investment  
in productivity.

**Qume**  
A Subsidiary of ITT



The new IBM Modem.  
It stacks up as never before.

The new rack-mounted IBM 3868 Modem saves you space. And money. And effort.

Space, because IBM's new one-inch-wide vertical package allows you to mount up to 12 modems in one enclosure that fits a standard 19-inch rack.

Money, because each enclosure needs only one power supply and cooling system to support all of its modems.

And you manage your network with less effort because the IBM 3868 Modem has the same high availability and rock-steady reliability as other modems in the 386X Series—plus an enhanced Link Problem Determination Aid (LPDA).

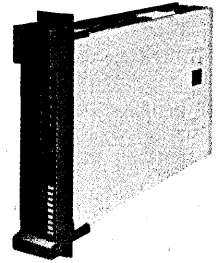

Working with software available for many IBM host systems, the LPDA performs greater end-to-end management. Now line conditions are identified further downstream from the host, and in more detail. For example, conditions in any multi-point circuit can be pinpointed to a particular leg, including tailed configurations off multi-plexed links.

In fact, to help you keep your network humming, the LPDA and host software monitor and provide you with a line quality value, a receive signal level, an error-to-traffic ratio and modem self-test results to help you isolate line problems. Now you can more precisely communicate them to your communications carrier.

*And because the 3868 Modem is so reliable, it's backed by a full three-year warranty.*

Try them for up to four weeks: just select 2400, 4800 or 9600 bps line speeds. If you purchase in quantity, discounts are available.

To get your copy of a free brochure, or to arrange to have an IBM representative contact you, call toll-free, 1 800 IBM-2468, ext. 82. Call your IBM representative or return the coupon.

IBM  
DRM, Dept. BO/82  
400 Parson's Pond Drive  
Franklin Lakes, NJ 07417

- Please have an IBM representative call me.  
 Please send me more information on the IBM Modem.

Name \_\_\_\_\_

Title \_\_\_\_\_

Company \_\_\_\_\_

Address \_\_\_\_\_

City \_\_\_\_\_ State \_\_\_\_\_ Zip \_\_\_\_\_

Phone \_\_\_\_\_



**Kids will compute, but whose logo will they see next to their lessons?**

# THE OLD SCHOOL SELL

by Willie Schatz

At some point during their school day, the vast majority of American schoolchildren will probably encounter a computer. Think of all those hearts and minds available to the enterprising vendor. Better yet, imagine all those potential dollars flowing into that vendor's checkbook. If the kids are weaned on your machine, you're probably set with them for life.

In that case, look for many bumper crops of Apples. According to September 1983 statistics compiled by Market Data Retrieval (MDR), Westport, Conn., Apple has 49.4% of the school education market. Next is Radio Shack with 21%, followed by Commodore with 15.2%. Barely visible are Atari at 2.9%, IBM at 2.7%, and TI at 2%.

MDR counted 325,000 computers out there when school opened in September. That's a 160% increase from September 1982. That means there's approximately \$550 million in sales to be made. And there's much, much more to come.

Computers have been installed in 62.4% of elementary schools, 80.5% of junior high schools, and 86.1% of high schools. High schools have 43% of the installed base, elementary schools 35%, junior high schools 18%, and all special schools 4.2%.

But that's this year's lineup. Next year you'll need a new scorecard. Like the iceman, IBM cometh. You don't think they introduced the PCjr for peanuts, do you?

"IBM will obviously have an impact in education because it's IBM," says a source at Talmis, a Chicago market information and consulting service. "It's clearly going to be a major player. Now it's only a minor player. But whether it can take over the school market as fast as it did the desktop world is very, very questionable.

"It won't be nearly as easy. IBM doesn't have all those hooks like it did in the business world. It's also going to need software and product. We haven't seen any of that yet. They're going to have to work a lot harder to take over the school market."

Not to worry. It takes more than a little blood, toil, tears, and sweat to scare off

Big Blue, especially when there's so much gold in them thar classrooms. But so far, IBM, the mainframe everywhere else in the industry, isn't panning out. Apparently, while the company was thinking office, its competitors were thinking classroom.

## PRICE IS A SLOPPY SECOND

They were also contemplating software. Price is nice, but it finishes a very sloppy second to software in the classroom. Your hardware may be the greatest thing going, but if you want to score points in readin', 'ritin', and 'rithmetic, you'd better have the right stuff to go inside your machine. Without it, you'll be sent home from school. Permanently.

"The most consistent complaint of educators is that there's no good software out there," says a source at Science Research Associates (SRA) in Chicago. SRA, a wholly owned subsidiary of IBM, has been publishing educational software since 1980 and developed Computer Discovery, the first product used on a micro to teach computer literacy. The firm now publishes 28 separate titles, with three to six levels available for each.

"There's a limited number of serious software programs," the source says. "There's been a gradual increase since 1980, but most products still lean toward games. We tend to concentrate on the serious ones. We might take as long as 18 months to make a program. And we make more products for Apple than anyone else."

Therein lies Apple's strength and IBM's weakness. According to Sofsearch International, a San Antonio research firm, there are 6,258 educational packages available for your brain's health. According to *Swift's Educational Software Directory*, 2,000 of those can run on Apples.

"We had success in the beginning because of the availability of third-party educational software," says Chris Bowman, Apple's manager of educational marketing. "The hardware isn't worth much without the software. Schools bought our machines even though we weren't the cheapest. As we developed that installed base in 1980-81, there was even more incentive to develop software for us rather than our competitors. Now with

so many districts having invested in our machines, it's going to be extremely difficult to convince them to switch.

"The other reason we've done so well—one third of our business involves education—is that teachers are not wild about big business. We have the image of being concerned about education. When you see computers and education, the first word you think of is Apple. If it's safe for the office manager to buy an IBM, it's just as safe for the educator to buy an Apple."

IBM would like to make it much less safe. Maybe even dangerous. In addition to its much publicized PCjr, IBM is embarking upon an intensive campaign to develop PC-compatible software.

"The education marketplace is very important to us," says Robert Rowe, IBM's manager of curriculum development. "We're very anxious to be there. We are there now, and doing very well, as a matter of fact.

"We think it's very obvious that the PCjr is very important to us in the education marketplace. It's much more affordable than the PC, and most of the PC software runs on the jr. We think that will help us greatly. We've had a tremendous marketing effort this year. We've got a much stronger presence than people give us credit for. Most of the surveys missed us. That strength won't show up until next fall."

Asked to provide numbers to support his claim, Rowe declined. But there appears to be an increasing number of software makers taking him at his word. Companies such as Classroom Consortia Media (CCM) of New York City or Computer Systems Research (CSR) of Avon, Conn., are betting all their chips on Big Blue's number.

"Where IBM leads, we will follow," admits Ed Brennan, president of CCM and also founder and executive director of the Staten Island Cooperative Continuum, a consortium of more than 100 public and nonpublic schools and universities in New York's least known and least appreciated borough. "In 1980-81, when we were developing our software, we made a definite decision not to go with the flow of cheap micros. In IBM we found an ally who understands what's needed to tap the market."

ILLUSTRATION BY BRIAN AJHAR

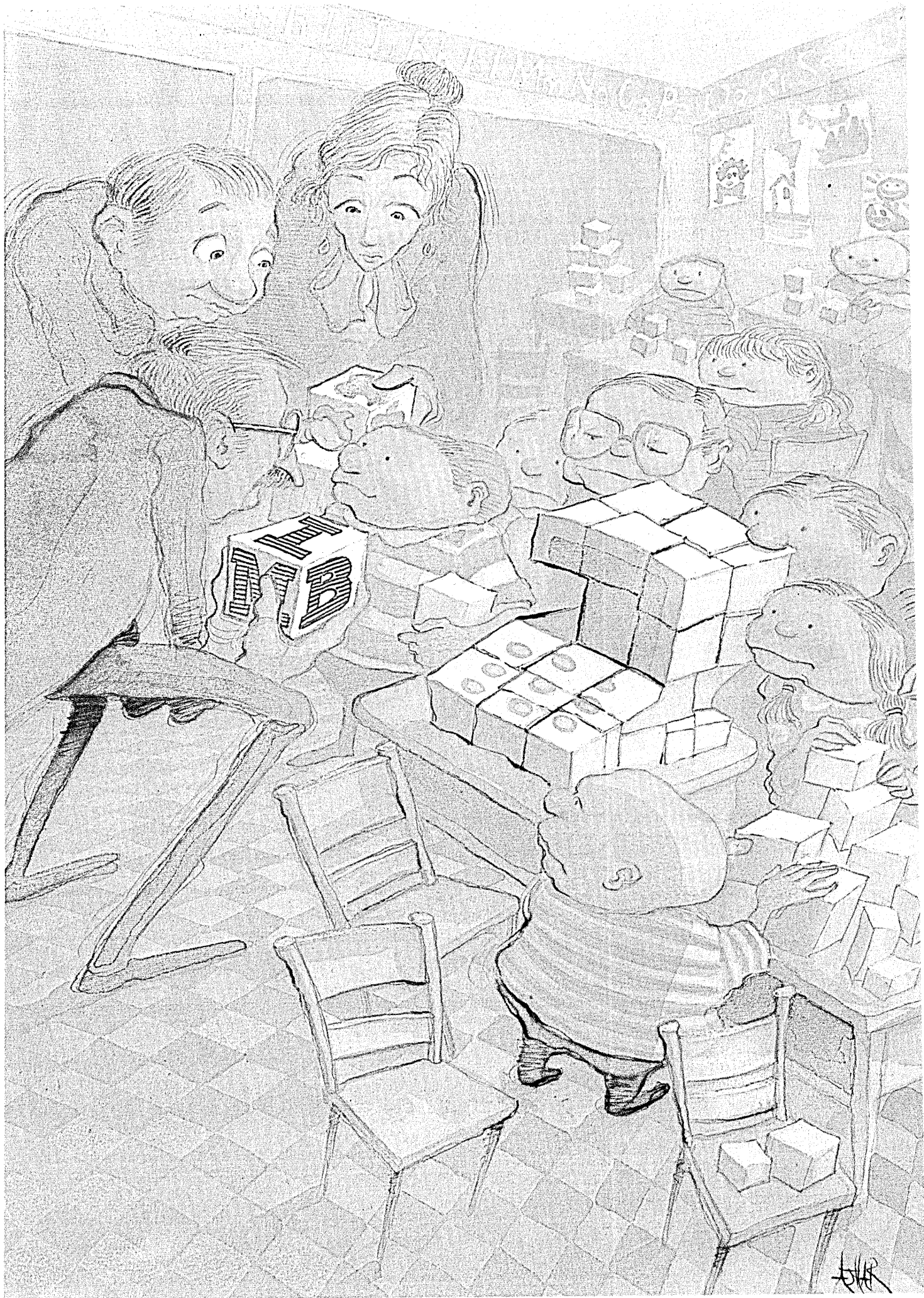



## "Teachers are not wild about big business," says Apple. "We have the image of being concerned about education."

### BRAINS AND BRAWN

After two years of negotiations and an exhaustive review by Big Blue of CCM's software offerings, the two signed a contract last October. CCM will be the brains, IBM the brawn. What CCM develops, IBM will buy, market, and support. By June, CCM expects to have about 50 products available for the educational market. It plans to produce five to 10 programs per quarter thereafter.

"CCM is one of a number of vendors we're dealing with to encourage the development of educational software," Rowe says.

"We're trying to go beyond the traditional drill and practice programs—although we consider those very viable—to specific courseware and tutorial programs."

CCM isn't offering your everyday, drill-and-practice, by-the-numbers software. This is the good stuff. Menu-driven, simultaneous graphics and text, hidden teacher access, and colors so vibrant you'd swear they were by Technicolor. No program reaches a student without being reviewed by a teacher panel. All is not totally blissful, however; a CCM product costs twice as much, \$69, as the average software program.

"A lot of people might think we're taking a big risk," says Don Shaw, president of Business Counselors Inc., a Kinnelon, N.J., consulting firm that handles CCM's national marketing. "We don't. We're not keying on the older machines like Apple, Tandy, and Commodore. We have every confidence IBM will succeed in the education market and we'll ride along right with them."

CCM ought to make sure it fastens its seat belt. Its future is barely present on its home turf. Apple and Tandy together have 90% of the installed base in Staten Island schools, with Tandy leading 60-40 in grades 9-12 and 55-45 below eighth grade. IBM is fifth, behind Atari and Commodore.

CCM could care less.

"We were ready to blow out everything the first week in November," Brennan says. "But we've held an awful lot back because of the PCjr. There's no sense being able to provide service when people can't get the product yet."

"We see the PCjr being a winner of significant proportions. IBM will be the dominant force from the day the first one arrives." Just in case there's a cosmic upheaval on that day, CCM is modifying a few of its programs to be compatible with Apple. "By 1986," Brennan contends, "IBM will be it."

That's just what CSR is counting on. Big Blue will market the company's Trainer 3000 system as the IBM Personal Computer Instructional System (PCIS).

According to CSR, the PCIS, which was developed for the IBM PC, provides many

### "I WANT TO BREAK INTO COMPUTERS."

After all these computers go into the schools, what do kids want to learn? At a conference of educators and pupils at New York's Teacher's College last summer, a *New York Times* reporter queried grade schoolers about their interest in computers. A few sample responses:

"I want to break into government computers," says Robert.

"I want to find a baby deer to take care of," says Erik.

"I want to change my grades," says Robert.

"It makes me very tired. It gives me a very small headache," says Jonathan.

"You are the boss, and it does the work," concludes Erik.

capabilities previously available only on IBM mainframes. It's also the first product to be marketed by IBM's direct sales force through the Integrated Systems Group. PCIS allows those with no programming skills or authoring experience to create, present, and administer computer aided instruction (CAI) on the PC. With the CAI market expected to grow by 60% per year and reach \$3 billion by 1986, if the Dataquest research firm counts correctly, PCIS just might help IBM grab a significant hunk of that change. Of course, it won't send CRS to the poorhouse, either.

"We originally had this product on Apple II and IIe machines," CSR president Michael Daversa says. "As soon as the PC was announced, we switched. There's a real reluctance to accept Apples in large-scale IBM organizations, which are our principal customers. And we couldn't get the performance out of the Apples."

"Our arrangement isn't exclusive, but it doesn't make good business sense to go elsewhere. We've got no plans to make the product available on anything but the PC. It remains to be seen what happens with the PCjr in education. But I'm not worried about IBM making it in the educational market. I'd hate to be in Apple's shoes. It's going to be fierce out there."

Like now it's a Sunday afternoon stroll in the park? And with Big Blue coming on, we're talking savage.

### BETTER TO GIVE THAN RECEIVE

Take donations, for example. The schools certainly do. Apple, Tandy, and IBM can't give their products away fast enough. It's the micro answer to "Can You Top This?" 'Tis better to give than receive and all that—especially if you're

the donee—but this is ridiculous.

The Apple Foundation, established in 1980, is swamped with proposals every year. It grants equipment to the winners, be they academic or individual. It also runs a summer institute and publishes research books. In the last few years, it's given away more than \$1 million worth of hardware.

Then there's the company's "Kids Can't Wait" program. Neither could Apple, once it discovered just how profitable donating could be. "Kids Can't Wait" is a present from the California legislature. Following the failure of a congressional proposal—dubbed "the Apple bill"—to grant federal tax incentives to companies that donate equipment to schools, a California version was enacted.

Knowing a good thing when it saw it, Apple offered a complete IIe system to every school in California. About 95% said sure, we'll take it, meaning Apple parted with 9,250 systems worth \$20 million. Bowman wouldn't say how much of a tax break the company received, but a knowledgeable source put it at \$1.5 million.

"Other companies participated, but not to the extent we did," Bowman says. Their loss, perhaps.

Tandy gives away training rather than machines. The company offers free courses in BASIC I and II and a 20-hour educational overview at its 420 nationwide computer centers. The training is available to any teacher in the U.S., whether or not he or she uses Radio Shack computers. Ron Stagell, senior vice president for computer marketing at Tandy, estimates the company has trained 150,000 teachers in the last three years. Tandy also mailed free of charge to the country's 103,000 schools an audiovisual presentation called "The American Education Challenge." It's a generic training program on computers and how they can be used in the classroom. The programs are the key tactic for protecting Tandy's educational market share in the face of the IBM onslaught.

"IBM obviously has an impact on any market it goes after," Stagell admits. "Do we stay up nights worrying about how it will affect us in the educational market? Absolutely not. We believe we've got long-term relationships with many, many schools and school districts that give them no incentive to switch to anyone else."

Better late than never, IBM is rapidly making up for lost time, though. Through its PC Literacy Program, the company has donated 1,500 PCs to 89 high schools and 12 colleges in New York, Florida, and California. IBM trains teachers from the participating institutions. Then the teachers return and show their pupils that computers are not the embodiment of evil. This program will set Big Blue back a mere \$8 million.

**WHY  
SETTLE  
FOR A  
SOFTWARE ONLY  
SHOW...  
WHEN  
THERE'S  
COMDEX?**

# **NOW... THERE'S COMDEX/WINTER, TOO.**

ANNOUNCING the most important new computer event for 1984 — COMDEX/Winter! The **third U.S. COMDEX** — the show that brings computer industry manufacturers and resellers together again.

Everyone knows you can't run software without hardware and related products. That's why COMDEX/Winter makes sense. The new computer show that helps you keep ahead of new product announcements, new companies, and new technologies — software and hardware. It's the right place for you to build, expand, upgrade, and support your ISO network, just as you always have at COMDEX but...

## **IT'S A SOFTWARE ONLY SHOW**

That's right. COMDEX/Winter offers the option of separate software and hardware sections in the same exhibition facility! You'll get double the benefit that "software only" and other product-specific expositions could possibly offer...plus...

## **IT'S A HARDWARE SHOW, TOO**

COMDEX/Winter provides the added pull of hardware and related products exhibited **with software** in one place at one time! There's no need to invest your trade show dollars in anything less, because COMDEX/Winter is...

## **BUILT ON THE PROVEN COMDEX SUCCESS FORMULA**

COMDEX is recognized as the **trade show for the computer reseller network**. And, like other COMDEX shows, COMDEX/Winter is a high pay-back investment. It delivers the highly-qualified ISOs that you want — and need — to do business with! And, it couldn't come at a better time. The computer industry is growing and evolving so fast that **nothing less than a third COMDEX can help you stay in the lead!**

Don't settle for software only when COMDEX/Winter will bring it all to you — software, hardware, and all the related products. Come do business and profit at COMDEX/Winter '84. And, do it in April in Los Angeles — the home of the 1984 Olympics! Get all the facts. Call us today, toll-free at (800) 325-3330/in Massachusetts (617) 449-6600.

 **COMDEX/Winter '84**  
**DON'T SETTLE FOR ANYTHING LESS.**

April 5-7, 1984  
Los Angeles Convention Center  
Los Angeles, California

Produced by,



world's leading producer of computer conferences and expositions including COMDEX/Winter, COMDEX/Spring, COMDEX/Fall, COMDEX/Europe, COMDEX in JAPAN, INTERFACE, FEDERAL DP EXPO, and the nationwide COMPUTER SHOWCASE EXPOs.

# "I'm not worried about IBM in the educational market. I'd hate to be Apple. It's going to be fierce out there."

On a more elementary level, IBM is experimenting with a "Writing to Read" program. The company has donated more than 300 PCs and typewriters and tens of thousands of other pieces to 100 schools in seven states. The concept, now in its second year, is being evaluated by the Educational Testing Service, Princeton, N.J. You remember them. They're the ones who made up the SATs, LSATs, and those other wonderful exams to see if you were smart enough to go to college. If all goes well, IBM will expand the program next fall.

All this, of course, is in addition to the standard educational discount. Think you got a great deal on your personal computer? Compared to what educational institutions receive, you got killed.

## WITH FIVE YOU GET AN APPLE

Apple now offers a 30% discount off the suggested retail prices of all its products except Lisa. And that's not all, folks. For every five personal computers or software packages you buy at discount, Apple will toss in a sixth for free.

"Our discounts were all over the lot," Bowman says. "The majority were below 30%. But we're not doing this because we see a threat from anyone. We needed to standardize our discounts. If we had to go to bat on price, we would have lost a long time ago. Everybody discounts aggressively to schools."

For all you fortunate school purchasing agents, Tandy will take 20% off its list price of \$1,000. What you see is what you get. There's no bargaining on the list price.

"We don't have a suggested retail price," Tandy's Stagell says. "Besides, no one ever pays that anyway. We don't deal in the world of high suggested retail prices."

"There's no question that our discount is almost always better than 30% off someone else's. I challenge anyone to take our discount, measure it against someone else's, and say theirs is better."

IBM offers a "standard educational discount." Does that mean 20%? Thirty percent? Only Big Blue and its customers know for sure, and they aren't talking.

Maybe that unknown number will be good enough. Or maybe it won't have to be. Maybe those three letters and that magic logo will be enough to turn America's elementary and junior high school classrooms into miniature IBM product centers. As went personal computing, so may go educational computing.

Then again, it may not. There are factors present in the educational market that didn't exist in the desktop market. Even for Big Blue, the future in educational computing will not be the cakewalk it enjoyed in big business personal computers.

"It's tough to develop good software," says Ken Brumbaugh, executive director of the Minnesota Educational Computing Consortium (MECC). The MECC co-

ordinates computer education in a state where 100%—as in all or every one—of the schools have a computer. MECC also reviews and develops software, and contracts to buy equipment for Minnesota schools. It's produced more than \$1 million worth of software for Apple. MECC is the standard against which others are measured.

"It's not worth it to try and develop the perfect package," Brumbaugh warns. "It's foolish to try and make it an A plus program rather than A minus. It's more important to serve more people and more teachers than to be perfect."

"You need software for everything, and the software producers are going to have to produce better programs. They're gradually doing it. But it takes three or four years to produce the perfect package. The world has a bigger appetite than that."

Well, maybe not the world. But surely the schools. If a district purchasing agent waits three or four years for the perfect program, he'll be on the street pretty damn quickly. It's like waiting for the perfect personal computer. Godot will get here first.

## RACE GOES TO THE CREATIVE

Still, the software race will go to the creative. Educators' lamentations notwithstanding, that species does seem to be fruitful and multiplying. Programs such as Rocky's Boots, from the Learning Company, Menlo Park, Calif.; Spellicopter, by Designware of San Francisco; Bank Street Writer, courtesy of New York's Bank Street College; and Music Construction Set, from Electronic Arts, San Mateo, Calif., are all designed to let children learn without realizing they're doing so. No more dull drill and practice sessions. Many of these are targeted for the home user, but you can bet your report card they'll find their way into classrooms. Who knows? With these programs, learning might actually be fun. Or at least not torture.

For a relatively new kid on the block, computers in the classroom seem to be going over very well. The growth has been geometric, bordering on the exponential. The kids get smarter and enjoy themselves more, or so the party line says. The vendors get richer and get the first graders addicted to their machines, or so they hope. But they're certainly not having a grand old time out there. Market share seems to change daily. The first one now may later be last. And it's only going to get worse.

"Radio Shack had everybody by the tail," a knowledgeable and influential state education official says. "Then it slowed down. It just doesn't have the right machine out there. Atari stumbled badly, too. Meanwhile, Apple made some positive changes.

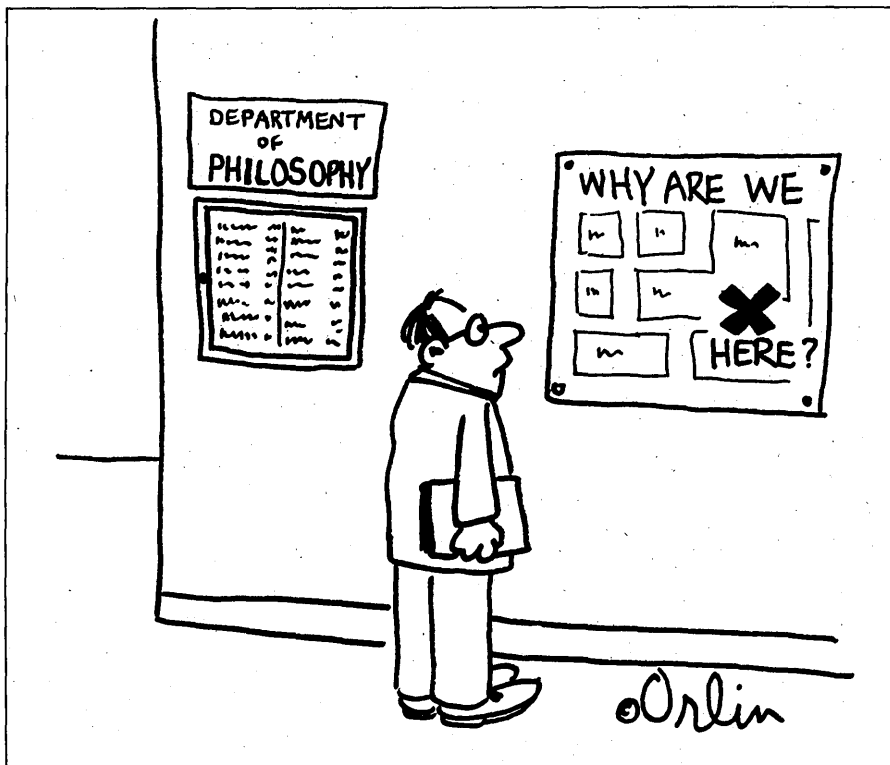

Orlin

CARTOON BY RICHARD ORLIN

# Compare Network Performance Management Systems.

Feature	Emcom 3729 NPMS	Avant Garde Net/Alert*	Tesdata SMART
Application monitoring	<b>Unlimited number standard</b>	8 Typical hardware change required; extra cost	30 Maximum (proposed) hardware change required; extra cost
Individual transaction record available	<b>Yes</b>	No	No
Network alarms	<b>33 types</b>	5 types	4 types
Immediate display of network alarms	<b>Yes</b>	No	No
Intelligent line data display	<b>Yes</b>	No	No
User-programmable automatic alarms trap	<b>Yes</b>	No	No
Protocol discrepancy alarms	<b>Yes</b>	No	No
Line utilization analysis	<b>12 real time and 30 databased components</b>	3 real time components	2 real time components
Network configuration recognition	<b>Automatically generated and verified</b>	Manual entry required	Manual entry required
Entire database available to host	<b>Yes</b>	No	No
Local (non-host) database	<b>Yes</b>	Yes	Yes
Low maintenance design	<b>Yes</b>	No	No
Special A.C. power	<b>None required</b>	Required	None Required

\*Net/Alert is the registered trademark of Avant Garde Computing, Inc.

## Emcom is the winner.

Emcom's 3729 Network Performance Management System provides complete documentation and accountability. Network control personnel consistently report higher productivity and improved relations with both vendors and online users.

After reviewing the facts, more and more companies choose the 3729 NPMS. For power, performance and flexibility, Emcom is the proven winner.

Visit our hospitality suite at the Circus Circus Hotel and Casino during Interface '84.

**EMCOM**

Emcom Corporation  
800 East Campbell Road  
P.O. Box 741715  
Dallas, TX 75374-1715  
214 437-1488



## Radio Shack had everyone by the tail. Then it slowed down, Atari stumbled, and Apple made positive changes.

Now it's selling software all over the place."

"The problem with Radio Shack software," an observer says, "is that you have to get it in the mail or Radio Shack sells it for you. That means there's less incentive for outside parties to develop it for you."

"Until somebody gets some substantial software out there, I don't see people

flocking to IBM," the Talmis analyst says. "There's nothing to run on it."

When that something comes along, it won't be cheap to run it, either. For \$669, the Peanut is nothing more than a shell.

"If you want to do anything with PCjr, you'll have to have 128K," Brumbaugh says. "That means, of course, that 128K will

become the standard. But the PCjr for \$750 is not the one you'll see in schools. You still need a cable, advanced BASIC, a cartridge, and more memory. You're talking \$1,300 without a disk. Other microcomputers will undoubtedly come up with an alternative."

Two companies are convinced they currently have one.

"Our educational marketing program isn't based on price," Tandy's Stagell says. "We see the need for teacher training and classroom computer literacy. We've proven we can achieve both. We've got 100 titles of purely classroom available. We've got cooperative agreements with almost every major publisher in the U.S. to whom we lend our software expertise.

"We're talking about a Model 4 selling for \$800. Why should anyone be interested in a \$1,300 machine that has no courseware support?"

"Two people have a lot to lose," the Talmis analyst contends. "Radio Shack is losing market even though it's still selling machines. As the market leader, Apple's share figures to be chipped away although it remains very strong.

"I expect IBM's share to be up to 5% this year. Unless the PCjr comes out with a lot of software, it will be limited to the junior and senior high schools. Not many schools will want the lower-end machine. But it's hard to predict the impact until we see it."

It's not necessary to see it. It's enough to have heard about it and know it's coming.

"There's no question IBM is making a major push in education," Apple's Bowman says. "They're going to sell the PCjr in that market to push into the home. They're going to focus on education the same way they sold Selectric typewriters to schools. It's going to affect everybody, but it will affect our competitors more. IBM will erode the market share of the vendors below us.

"They'll have some impact on us because of their enormous resources. Their sales force is bigger than most small towns. Their R&D budget is bigger than our total sales. But our market share has increased over the last two years while our competitors' has decreased. They're going to take a lot more from Radio Shack and Commodore than from us because we're so much stronger. Don't forget that nobody in the business market had a share of that the way we have in the educational market. It's going to be much harder for IBM to do what it did in the personal computer market."

"If they dominate, and I'm not saying they will, it's going to take them a lot longer than 18 months," the Talmis source says.

No problem. Time is on IBM's side. It always has been. It always will be. \*

## Martin Marietta Aerospace Data Processing Opportunities

Martin Marietta Aerospace, NASA's prime contractor for the Space Shuttle External Tank has immediate openings for Data Processing professionals. Because we actually manufacture the external tank, you'll get to see the actual results of your efforts.

### COMPUTER PROGRAMMER/ANALYSTS

Immediate opportunities exist for individuals experienced in:

- **UNIVAC 1100**  
ASC11 COBOL  
DMS 1100  
DDL, SDDL, DMU  
DML, QLP  
DPS 1100, TIP  
D/B Editor
- **APPLICATION EXPERIENCE**  
Shop floor control, Scheduling, Manufacturing, Inventory, Purchasing, Configuration Management, Quality, Engineering.
- **DATA BASE OPENINGS**  
Analyst, Design, Administrators with above hardware, software and applications experience.
- **CAD/CAM PROGRAMMER/ANALYST**  
Experience In Software and System Administration In Computervision with a BA/BS preferred.

These opportunities exist at our Michoud Assembly Facility located in suburban East New Orleans.

Qualified candidates interested in learning more about these opportunities at Martin Marietta should forward resumes, including salary history, to: Martin Marietta Aerospace, Denver Glazier, Dept. DM-384, P.O. Box 29304, New Orleans, Louisiana 70189. We are an equal opportunity employer, m/f/h.

**MARTIN MARIETTA**

CIRCLE 99 ON READER CARD



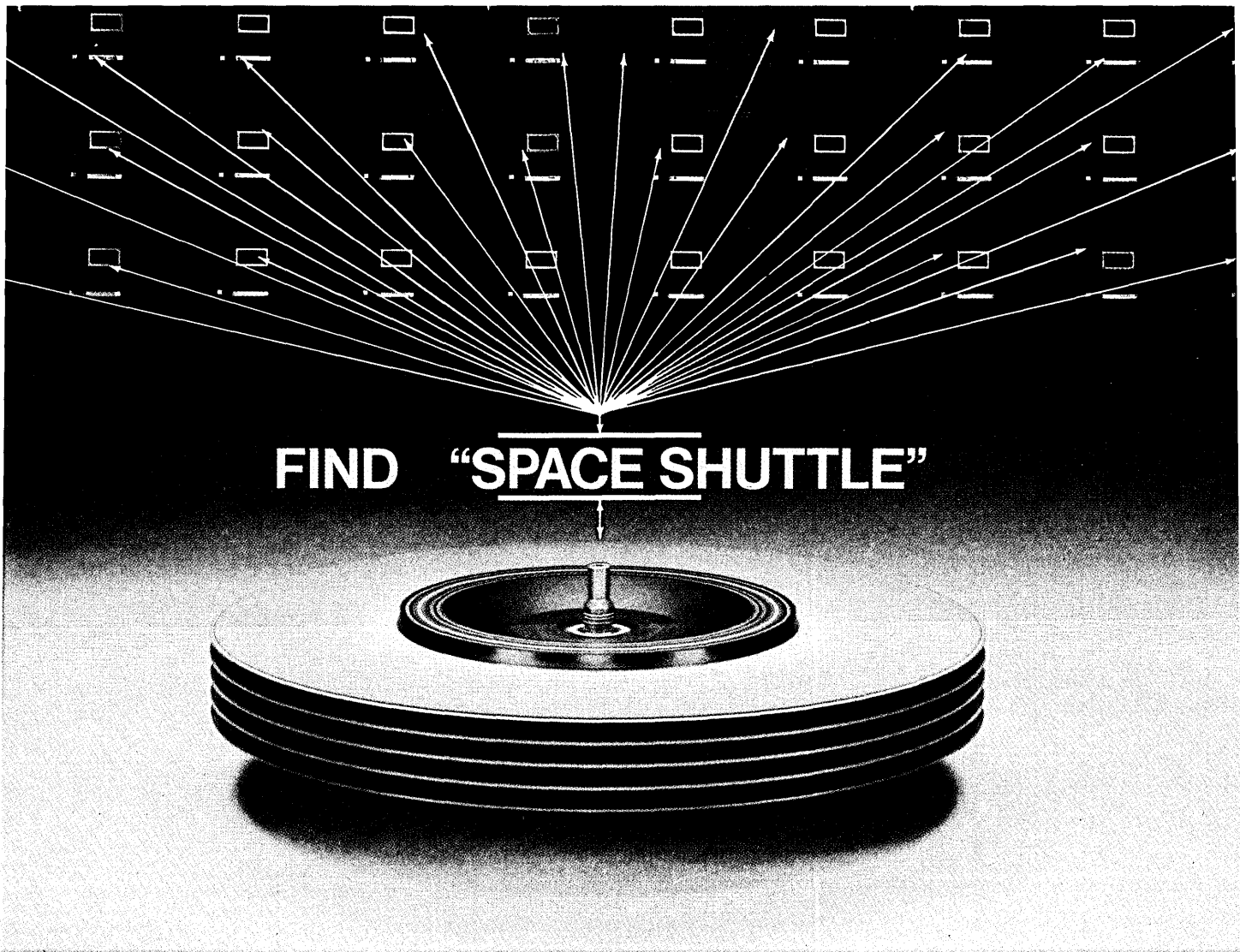

**BASIS retrieves  
information from  
1 to 10,000,000  
records in  
nothing flat.**

Tired of manually searching through massive files of data? Let BASIS turn your existing files into an automated Information Center.

Imagine a system that retrieves textual information within seconds, the same way a database management system retrieves data. That's BASIS, a proven, interactive retrieval system that does much more than examine titles.

BASIS actually probes to find the key word or phrase you're looking for within any record. Then it displays a list of all records containing the word or phrase you specified. BASIS also dis-

plays any or all of the information, and prints hard copy if you want.

BASIS can turn your existing files into an automated Information Center within a few days. *So if you have one or ten million records that need rapid referencing, see what BASIS can do for you. Call or write for a descriptive brochure today.*



**Battelle**

Software Products Center  
505 King Avenue  
Columbus, Ohio 43201  
Telephone (614) 424-5524

BASIS runs on DEC VAX®, Prime and Wang VS minicomputers, and on IBM, CDC, DEC® and Univac mainframes. DEC and VAX are trademarks of Digital Equipment Corporation.

**CIRCLE 100 ON READER CARD**



**"WE CHOSE VAX BECAUSE  
NO PRODUCT HAS A BETTER SET  
OF INFORMATION MANAGEMENT  
TOOLS."**

—A STEVEN OUZOUNIAN, Vice  
President, Equitable Relocation  
Management Corporation

VAX is automating everything they do at ERMCo. From home finding to home purchase, equity payments, property management, the entire relocation process. The company is swapping typewriters for terminals, eliminating manual procedures, creating the paperless office.

**A**t Equitable Relocation Management Corporation, they're installing what Steve Ouzounian calls, "the best system in the relocation business for collecting and distributing information.

"We're connecting eleven regional VAX-11/750s with a VAX-11/780-resident data base via DECnet." Every aspect of our business is being networked—real estate brokers, available homes, mortgage data, city demographics, all our suppliers and their performance records—this is no trivial data base."

The network is designed to put up-to-date information into the hands of ERMC's counselors in five seconds or less anywhere in the country.

"Responsiveness is the key," Steve explains. "Our people can now make the transferee confident about every decision he or she has to make. With VAX™ systems we've got the answer, or the way to find out.

"We shopped hard," Steve recalls, "and VAX Information Architecture clearly had the best integrated, easiest-to-use tools. We're using them all. DBMS, DATATRIEVE™ reporting, FMS forms management, plus ALL-IN-1," Digital's new office information package. VAX has catapulted us into the Information Age.

"With Digital's help, we've got VAX systems operating in a mainframe environment. They've met our demanding phase-in schedule, and helped to design a system that expands with our business. Quite simply, they've made us more competitive for years to come."

Meanwhile, it's getting harder and harder at ERMC to find a typewriter, or a pencil. Or a question that can't be answered.

Ask us about VAX.

Call toll-free: 1-800-DIGITAL, extension 200.  
Or write: Digital Equipment Corporation, 200 Baker Avenue, Attention: Media Response Manager, CF01/M94, West Concord, MA 01742.

# VAX



**digital**

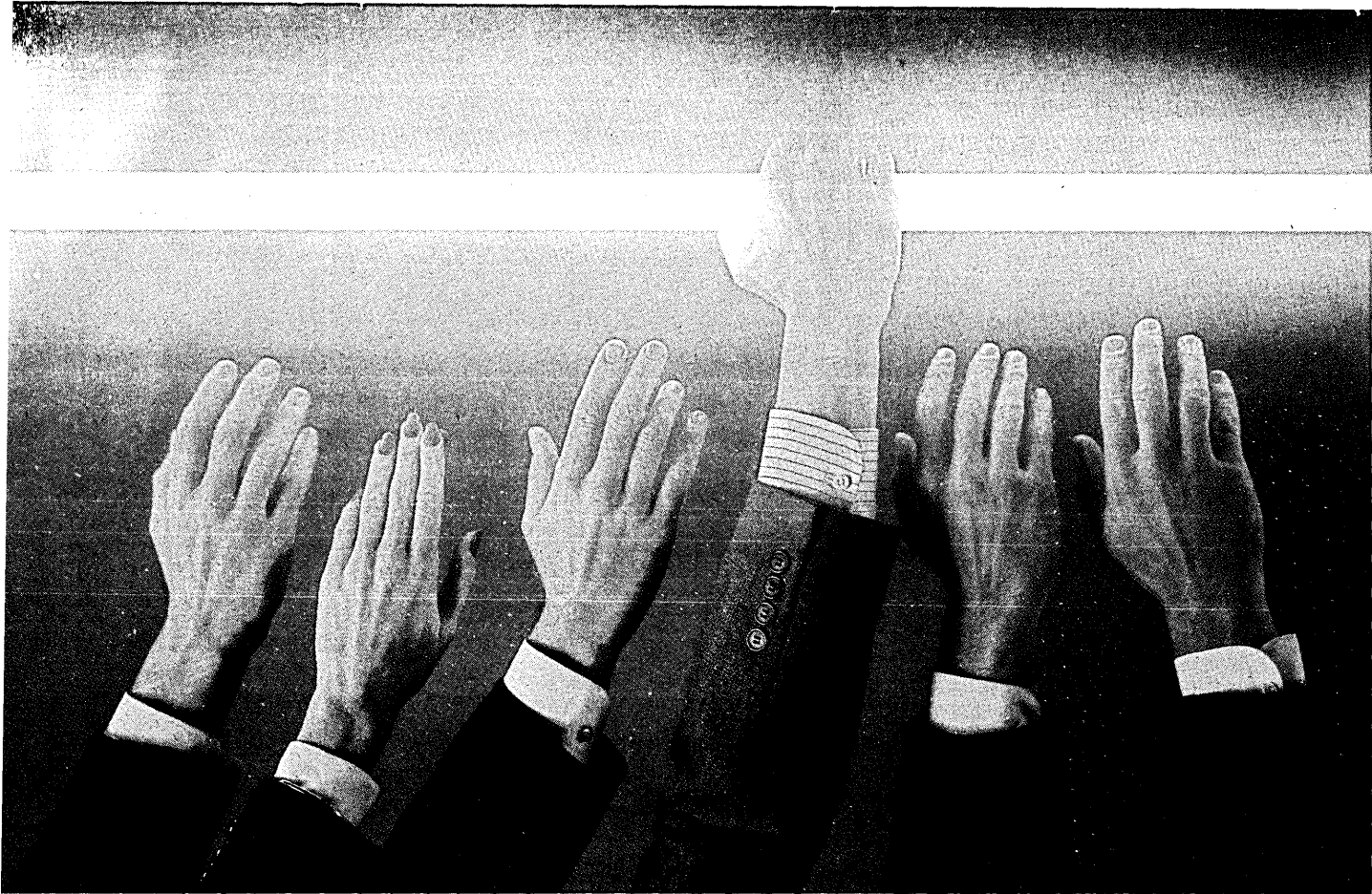

# How To Get A Better Grip On Your 3270 Network.

## With More Flexibility Than Ever Before.

Getting a grip on your 3270 applications is a real challenge. You've got to find the best way to bring IBM host applications to non-3270 terminals and personal computers. Without a lot of fuss and bother.

Fortunately, Datastream has a flexible solution. One that won't cost you an arm and a leg.

With our 3270 SNA or BSC Cluster Controllers, you can attach personal computers, ASCII terminals and printers to IBM hosts, giving more people 3270 functionality. And giving you more control of the computing activities in your company.

Our Multi-Path Controller allows personal computers and ASCII terminals to communicate not only with multiple IBM mainframes, but with minicomputers (including DEC®) and time-sharing hosts as well. It even allows personal computers and terminals in the network to talk to each other.

All Datastream controllers feature security, dial-in or direct-connect access, remote dial-in diagnostics and more.

To extend your 3270 investment even more, use our controllers with Datastream's low-cost Display Stations. They offer 3278 functionality keystroke-for-keystroke. Plus features even IBM doesn't have. Like DEC VT100 emulation. Remote dial-in. Additional soft keys. And other 3290-type keyboard features like 24 PF keys.

All this makes for a very tidy, secure, economical way to expand your network.

And put 3270 within everyone's reach.

**Call toll free: 800-952-2500**  
(Outside California)

## DATASTREAM

2520 Mission College Blvd.  
Santa Clara, CA 95050  
408/986-8022

**SEE US AT INTERFACE, BOOTH #1364.**

®DEC is a registered trademark of Digital Equipment Corporation.  
©1984 Datastream



**From the designer's desk to the factory floor,  
CIM moves products along through the use of a  
single digital database.**

# COMPUTER INTEGRATED MANUFACTURING

**by Eric Teicholz**

In the United States, our gross national product is comprised of service industries (63%), manufacturing (24%), and the extractive (e.g., agriculture) and construction industries (13%). Since "service" does not result in the direct creation of wealth, we can subtract these industries from the GNP. This results in manufacturing being responsible for close to two thirds of America's real wealth.

Obviously, any tool that increases manufacturing productivity will have a profound effect on our GNP. At the present time, technology, particularly computer integrated manufacturing (CIM) technology, has demonstrated the greatest potential for improving our manufacturing productivity (see Fig. 1).

Most CIM technology is currently being developed in the U.S.—yet its most innovative implementation has thus far been in Japan and Western Europe. For example, Japan's Fujitsu Fanuc operates a factory for producing robotic parts; it is almost entirely unmanned during night shifts. By using CIM technology, the Messerschmidt Bolkow-Blohm plant in West Germany enjoys a lead time of 18 months for the production of fighter planes. A similar plane produced conventionally would require a lead time of at least 30 months.

The objective of CIM is to develop a cohesive digital database that integrates manufacturing, design, and business functions. Information is sent on demand and as needed to the largest number of intra- and interdisciplinary groups as possible. The ideal CIM-controlled system will design and manufacture parts without disruption, from raw materials to the finished product (see Fig. 2). In a CIM-controlled factory, machines create products under the hierarchical control of computer networks that optimize production flow and scheduling. After executing their

respective tasks, all machines report on work and operating status, current state of being, and other technical and administrative data.

Current applications involving CIM

technology include one or more of the following manufacturing functions:

- vendor procurement schedules,
- product planning and manufacturing,
- order entry and scheduling,
- material requirements planning (MRP),
- material and stock inventory and control,
- performance measurement,
- cost control and accounting,
- quality control,
- status reporting.

Most manufacturing components in the U.S. are produced in low-volume lots of 50 pieces or less. This means that a great deal of time is spent altering part routing and reprogramming machine operations, which results in slow and costly production sequences. At present, it is estimated that up to 95% of a batch-type metalworking shop's production time is spent simply on moving and storing workpieces.

To speed up the production process for its small-lot batch manufacturing, the General Electric's Aircraft Engine Business Group (AEBG) is implementing CIM capabilities that allow for the flexible and changing manufacturing requirements needed for product variations and for controlling material flow. The objective of GE's CIM effort is to optimize yield while minimizing lead time, by using a network of automated manufacturing operations located at several AEBG plants. For three years, most of the work has involved linking together several hundred numeric control (NC) machines. Before the modernization is completed in 1985, GE will have spent over \$750 million implementing CIM functions.

The components of GE's CIM system at AEBG include elements involving process planning, quality planning, and master computer operations (see Fig. 3). For example, product design data from remote CAD/CAM systems can be teleprocessed to a central GE

FIG. 1

## SOME CIM BENEFITS

Ed Adlard, supervisor of manufacturing software at Metcut Research Associates, Cincinnati, Ohio has compiled a list of CIM-related benefits using a variety of surveys and industry averages. Examples of these benefits and their corresponding productivity percentage gains include:

<b>GROUP TECHNOLOGY</b>	
New part design	52
Shop drawings	30
Industrial engineering	60
Production floor space	20
Raw material stock	40
Setup time	69
Production time	70
Work in process inventory	62
Overdue orders	82
<b>PROCESS PLANNING</b>	
Planning activities	58
Direct labor	10
Material	5
Scrap and rework	10
Tooling	12
Work in process	5
<b>MATERIAL REQUIREMENTS PLANNING</b>	
Productivity	5 to 30
Work in progress inventories	30 to 50
Late orders	90
Labor requirements	10



facility where manufacturing plans and numerical control tapes are produced for various manufacturing aircraft engine parts. Individual manufacturing units are connected to a single cpu, supplying all production instructions using direct numerical control (DNC) techniques.

GE considers the evolutionary approach to manufacturing, whereby new capabilities and technologies can be added rapidly with minimum disruption to the existing process, as the single most important aspect of CIM.

### CIM NEEDS LONG-TERM PLANNING

Planning and implementing CIM requires a long-term commitment by management. One lesson GE learned is that CIM works best when subsystems are incorporated in a modular and phased manner. Planning, therefore, becomes extremely important. A company must start with a thorough awareness of current and projected capabilities of CAD/CAM systems within the organization. Only then can CIM planners specify database interactions between design and manufacturing functions (e.g., how information is organized, maintained, and transferred from one database to another).

Analyses must then be performed, relating to potential integration of business planning, engineering design, manufacturing control, shop floor monitoring, and process automation functions. Afterwards, it is possible to define and cost-justify relevant CIM components and prepare the modular and phased implementation plan.

The CAM capabilities of major CAD/CAM vendors have traditionally lagged behind those of CAD. It is obviously more difficult to automate, in a generic fashion, the routing and assembling of parts on a shop floor than it is to generate graphic images on a crt display. Yet vendors are accelerating the integration of CAD/CAM and CIM database functions because of the anticipated quadrupling of the current CIM market to \$100 billion within the next decade (according to a recent report by Arthur D. Little Inc., Cambridge, Mass.).

Current R&D efforts of major CAD/CAM vendors focus on three CIM areas: numeric control, robotics, and process planning and group technology.

**Numeric control.** NC represents the most mature CAM technique. For years, the machines responsible for drilling, milling, torch cutting, and bending materials into finished parts have been programmed by technicians using a number of NC programming languages. There are currently hundreds of NC equipment manufacturers (and proprietary languages) resulting in some 20,000 NC machines installed each year. Because there are

FIG. 2

## CIM FUNCTIONS

### Business Planning and Support

Economic Simulation  
Long-term Forecasting  
Customer Order Servicing  
Finished Goods Inventory Mgmt. ◀

### Engineering Design

Computer-Aided Drafting  
Computer-Aided Tool Design  
Group Technology  
CAD ▶

### Manufacturing Planning

Process Planning Systems  
Parts Programming  
NC Graphics  
Tool & Materials Catalog  
Material Requirements Planning  
Production Line Planning Simulation  
Bill of Materials Processors  
Machinability Data Systems  
Computerized Cutter, Die Selection  
Materials/Parts Inventory Mgmt. ▶

### Manufacturing Control

Purchasing/Receiving  
Shop Routing  
Methods & Standards  
In-process Inventory Mgmt.  
Short-term Scheduling  
Shop Order Follow System ▶

### Shop Floor Monitoring

Machine Load Monitoring  
Machine Performance Monitoring  
Man-time Monitoring  
Material Stores Monitoring  
Preventive Maintenance  
In-process Quality Testing ▶

### Process Automation

NC, DNC, CNC  
Adaptive Control  
Automatic Assembly  
Automatic Inspection  
Computerized Testing

Reprinted from CAD-CAM Technology, Spring 1982.

not nearly enough skilled NC programmers to go around, CAD/CAM vendors have turned to computer graphics and generic NC software to guide the engineer from part design to the generation of codes.

Additionally, specialized low-cost computer numerical control (CNC) microcomputers that internally store NC instructions are being used, rather than machines with traditional paper tape postprocessor interfaces. Still more recent developments use direct numerical control (DNC) capabilities whereby individual manufacturing units are connected to a single cpu that supplies instructions for all NC machines.

The newest CAD/CAM software developments enable NC instructions to be produced automatically from the CAD model without assistance from NC programmers knowledgeable in tool path generation procedures. Therefore, engineer/designers can now generate their own NC programs.

Industry expert John Krouse, editor of *Machine Design* magazine, foresees the eventual development of software that automatically produces NC instructions for generalized part shapes using "generative programming" techniques. In other words, says Krouse, the computer will "automatically recognize the solid model of the part, identify material to be removed from raw stock to produce the part, select the tools required, determine machining parameters such as feed rates and spindle speed, establish the proper sequence of work elements, and determine optimum tool paths to fabricate the part while avoiding tooling clamps and fixtures."

**Robotics.** The definition of industrial robots includes several types of mechanical devices—from simple axis-manipulators to extensive human analog machines. The Japa-

nese Industrial Robot Association (JIRA) defines six distinct categories of robots. The simplest are manual devices with a manipulator worked by an operator; the most complex are "intelligent" robots, which contain sensory perceptors (visual and/or tactile) that detect changes in working environments and employ automatic decision-making faculties to regulate operations. In general, all six categories of robots involve the concept of programmability and are best employed in the performance of material handling functions and repetitive tasks.

### NEW BUT IMPORTANT CONCEPT

Using robots in an integrated CIM environment is a relatively new concept but already an important factor in performing low-cost, flexible manufacturing operations (i.e., where the machines can be configured to perform a variety of functions on a family of parts). Although commercial CAD/CAM vendors offer databases to provide machine and tool information, they are just beginning to offer the capability of off-line programming of robots. Such programming is important because it enables robot simulation to allow for procedures testing without tying up or taking the work cell out of production. Additional software developments permit the CAD/CAM database to be used to check clearances and interferences of robotic components and assemblies; verify robot paths; and include information on robot, task, and work cell variables related to specific robotic tasks.

At present, there is no standard robot language. Industrial vendors are developing proprietary languages that enable robots to work interactively with a person (rather than being a blind slave) and allow for the auto-

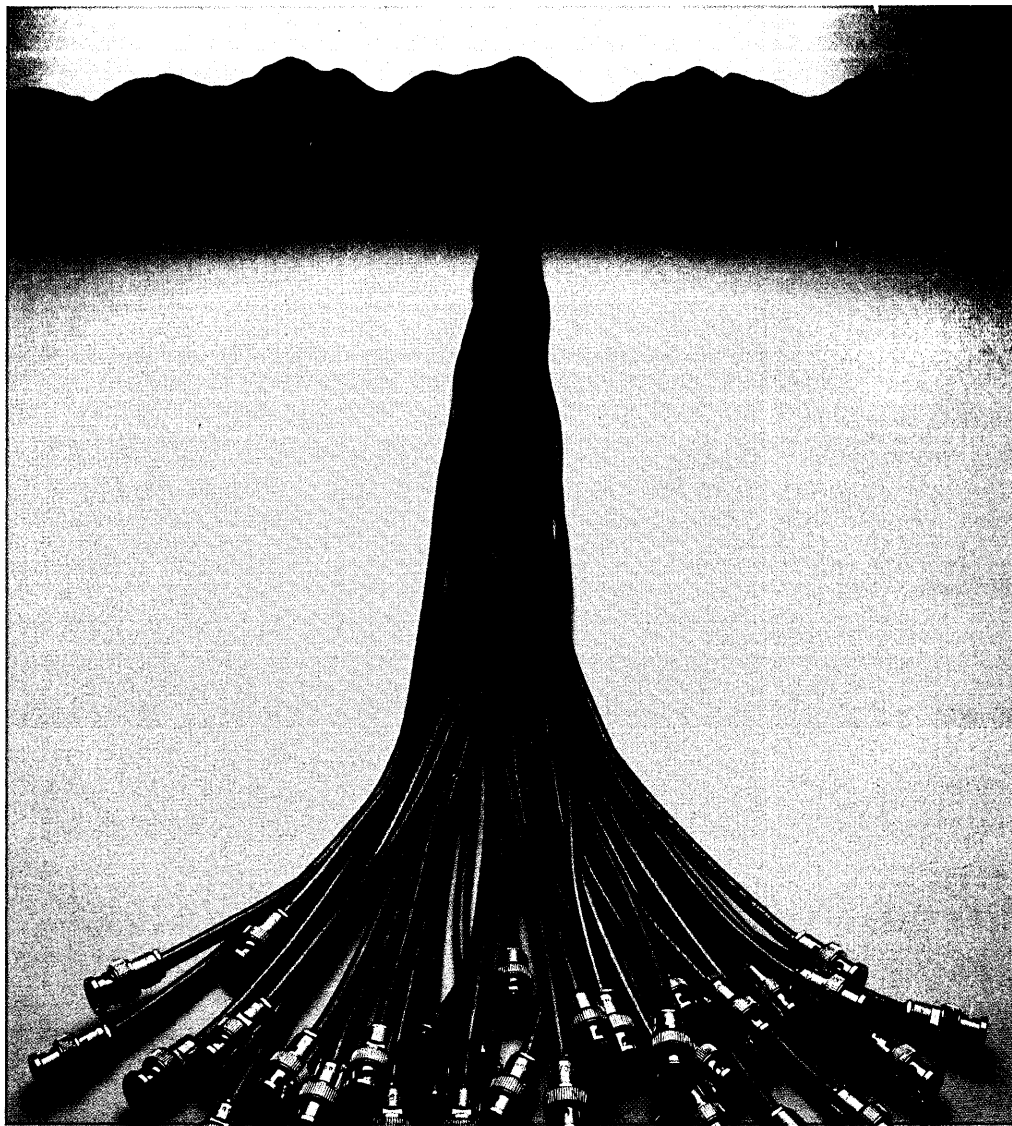

# Now you can add 31 IBM 3270 devices without adding 29 miles of cable.

Our new CMX Cable Multiplexer takes up to 32 inputs from an IBM 3274 Controller, combines them into a single signal, in a single cable, for demultiplexing up to 1500 meters away. With no performance degradation. So using an existing cable, you could add as many as 31 new terminals without pulling any new cable at all: at 1500 meters each, that's 29 miles of cable you don't need to find room for, install or manage.

Installation is easy, using existing RG-62A/U coaxial cable and BNC connectors. It's especially easy when you consider the alternative—pulling miles of new cable through already-crowded ducts.

Up to four cables can be run from the CMX, so you can support 3278, 3279 and 3287 devices on different floors, or in different directions, from one unit.

The CMX Cable Multiplexer system is available in 32-port, 24-port, 16-port and 8-port models. It is completely transparent to IBM user software and terminal operation and meets all type A interface and cabling specifications.

Another solution to your local communication problems from Ungermann-Bass, the Net/One™ company.

Please call the regional office nearest you for more information about the new CMX system: Santa Clara, CA, (408) 496-6464; Burlington, MA, (617) 273-5858; St. Louis, MO, (314) 434-1024; Dallas, TX, (214) 385-7090; Los Angeles, CA, (714) 553-1771.

**Ungermann-Bass**



CIRCLE 103 ON READER CARD

# CIM works best when subsystems are incorporated in a modular and phased manner.

FIG. 3

## GE'S CIM OPERATIONS

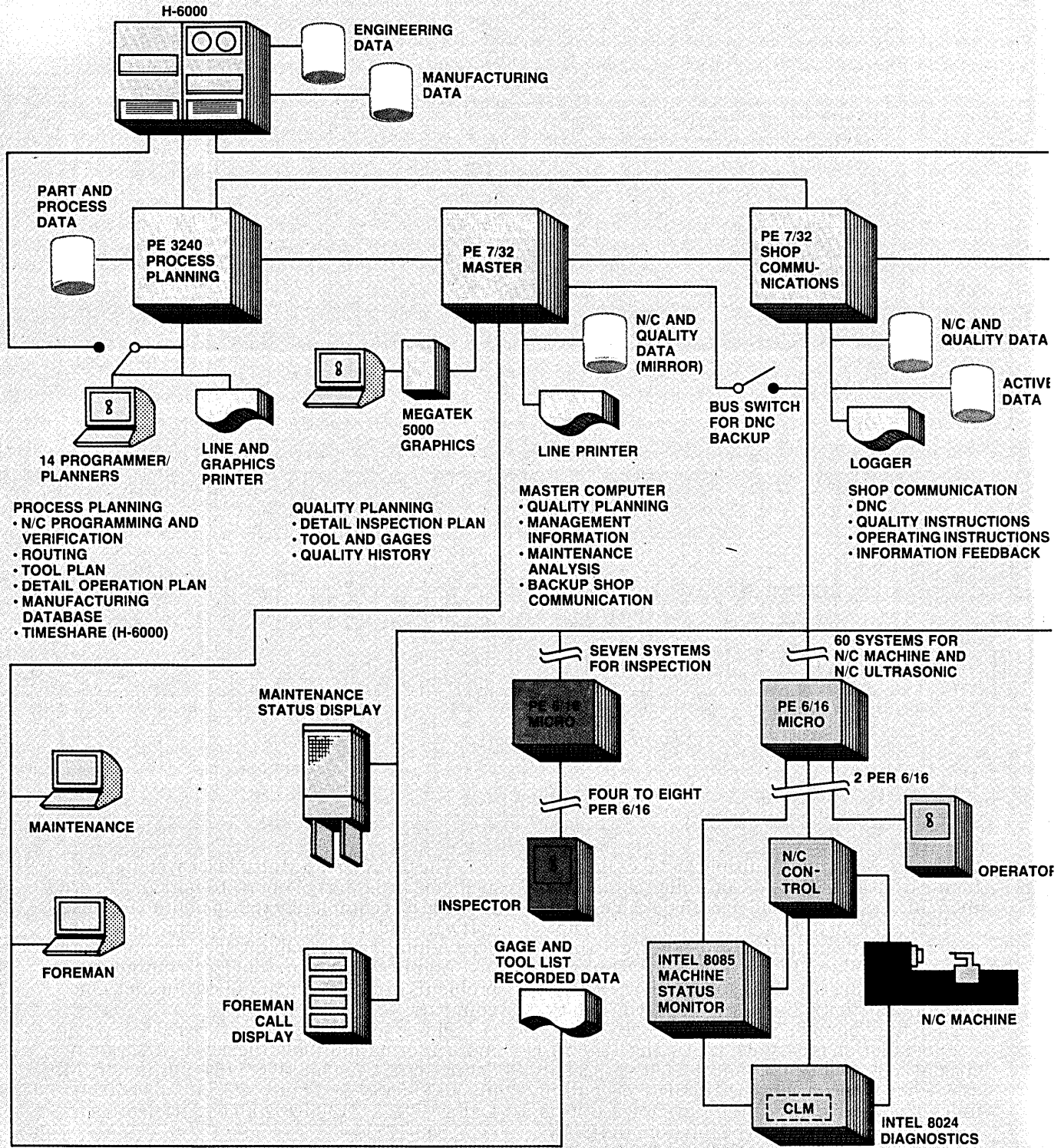
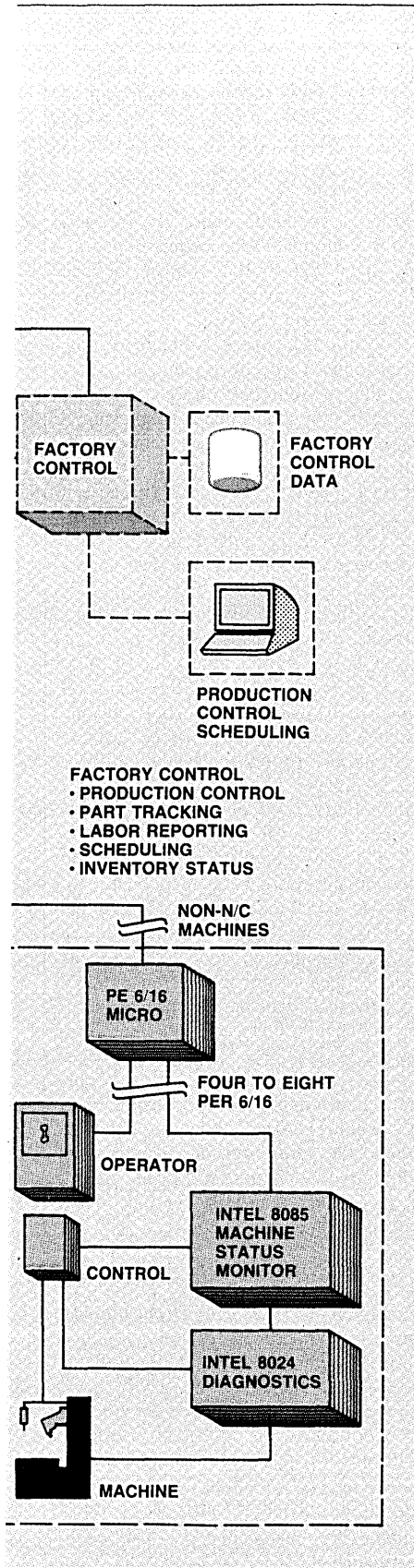

CHART BY PAUL GOODFRIEND



matic teaching and reprogramming of robots—currently the slowest and most error prone aspect in robotics.

*Process planning and group technology.* Process planning is concerned with the total manufacturing picture. Computer software that optimizes this process must take into account such factors as the status of the workpiece at each workstation as well as the routing of the part around a shop floor.

As a company manufactures its products, even in low-volume lots, there will inevitably be underlying similarities among the parts—despite the fact that these parts change over time. Recently, flexible manufacturing systems (FMS) have been designed based on these part similarities. CIM process planning systems are used to retrieve relevant part and process information using a technique called group technology whereby families of parts are organized, based on either shape similarity or common manufacturing operations.

Some CAD/CAM vendors actually enable users to store standard plans and their associated operational procedures for part fabrications for each part family. Users can customize by simply editing the generic part family to produce operational manufacturing codes for each new part as it is designed.

John Krouse foresees a time when the computer will “generate its own data, internal computations, and independent decision making. In these generative systems, process plans will be produced directly from the geometric (CAD/CAM) database with almost no human assistance.”

At the leading edge of the nascent CIM industry is Computervision Corp. (CV), Bedford, Mass. With 1982 revenues of \$325 million (about 23% of a \$1.4 billion market), CV is the largest vendor of turnkey CAD/CAM systems for product design and manufacturing processes including CAD, CAM, and computer aided engineering (CAE). The company recently announced a three-tiered strategy to develop products for: 1) the single-user/focused application environment incorporating intelligent workstations, standard operating systems, and local area networking; 2) the multi-user/multi-application 32-bit minicomputer environment; and 3) large-scale mainframe users needing enhanced database management capabilities. Traditionally a vertically integrated company (manufacturing its own hardware and software), CV has now entered into third-party agreements with both SUN Microsystems, Mountain View, Calif., and IBM to implement this strategy. The company also acquired several software firms to provide applications software support—including the Organization for Industrial Research Corp., Waltham, Mass., to provide group technology and process planning software for IBM 4300 series computers.

## CV AND NUMERIC CONTROL

CV supports interactive graphic NC machining. The programmer defines tool motion directly from the design database, which, in turn, is graphically displayed on a crt while the tool path is created. Design changes that might be necessary because of collisions are made in the database and reflected in all associated drawings and part information. Although a generic NC code generator is under development, specific code for various NC machines is generated by one of several hundred postprocessors sold by CV.

CV also supports off-line robotic programming, which means programmers create and verify programs without using the traditional “teach” method whereby robots are taken out of production during retraining cycles. The database includes models for describing robotic movements that are, in turn, graphically simulated. At present, CV can supply databases for six existing industrial robots from three manufacturers—Cincinnati Milacron, Cincinnati, Ohio; Unimation, Danbury, Conn.; and Automatrix, Burlington, Mass.

CV even supports a group technology program that allows parts with similar geometric features and manufacturing characteristics to be manually classified by code numbers. The code numbers are used to retrieve existing designs from the database for revision and customization. Added software facilitates generation of process plans (including graphics and text), rather than parts, and retrieval and formatting of similar plans resident in the database using group technology techniques.

And finally, CV supports tooling and fixture design software by performing shrink and bend analyses on geometric models and by interfacing CV equipment to coordinate-measurement machines. This allows input of part information to a common database from the actual part model, pattern, or prototype. The company has software that can unfold a three-dimensional design into corresponding flat patterns. This information is used for NC tool path generation for punch presses, flame cutters, saws, or laser cutters.

Engineers currently create products using a series of part drawings. The management of information for part drawings for a complex assembly, which can consist of thousands of such drawings, is currently a logistical nightmare for most CAD/CAM systems. For CIM to be effective, CAD/CAM vendors must develop both the increased storage requirements and software facilities to allow integration of all drawings for subassemblies and other components, via group technology procedures. Additionally, CAD/CAM databases must be integrated and linked to tradi-



## To be effective, CAD/CAM databases must be integrated and linked to traditional corporate dp functions.

### GRUMMAN'S ENGINEERING AND MANUFACTURING SYSTEM

The Grumman Aerospace Corporation of Bethpage, Long Island, has been earning its wings since the 1930s. Its latest wings are raising eyebrows in the aerospace industry: they sweep forward from the body of the plane. The computer made them do it.

"A forward swept wing design is part of a high-performance aircraft that offers vastly more efficient flying," says Bob Roemer, project director of Grumman's effort to produce a demonstration model of the X-29 jet fighter for the U.S. Air Force. If successful, Grumman will prove that the forward swept wings improve the X-29's maneuverability as the aircraft reaches the speed of sound while boosting fuel economy.

The X-29's wings and canards (small, stubby wings that give the plane added stability) were designed with the aid of Grumman's Engineering and Manufacturing System (GEMS), a CAD/CAM system. Grumman uses GEMS for designing, drafting, and manufacturing.

The company first used GEMS to design some parts for the F-14 jet fighter, and has since used the system to develop the special wings on the U.S. Space Shuttle.

That was during GEMS' embryonic stage, when the system could support only four CAD terminals. Now, six years later, GEMS has grown up. It currently comprises four mainframes supporting over 100 terminals. Grumman's GEMS system is based on IBM mainframes—one 3081, a 4341 group 2, and two 3083s. Hanging off these mainframe computers are 142 IBM 3250 terminals. These terminals are located throughout the company's 2½-mile facility, linked by an underground fiber-optic cable network. The GEMS managers proudly state that the system has a response time of 0.14 seconds with all 142 terminals on-line.

Stephen Petrovits, GEMS program manager, says the important thing about the system is the software, not the hardware. "There really wasn't much in the way of good software back in 1975," he recalls. "Those were the pioneer days of computer graphics."

Back then, Grumman purchased a copy of Lockheed's computer augmented design and manufacturing system (CADAM) to use as its basic geometry modeling package. To that, Grumman added several of its own programs.

Then, in 1982, Grumman purchased Dassault Aerospace's computer aided three-dimensional interactive application (CATIA). CATIA gave GEMS a 3-D design capability. Later, in 1982, Grumman added a numerical control software package to the growing GEMS system.

Today, Grumman has a design and manufacturing system that allows its designers and engineers to perform analytical, layout, drafting, and numerical control functions while simultaneously using a common database that is shared by the company's engineering and manufacturing departments.

"The beauty of the system," Petrovits says, "is that as the design changes are incorporated, the stored math models are kept up to date. And you can always get an idea of what an earlier configuration was like by backtracking."

The system provides many other benefits. Thomas J. Kelly, Grumman's vice president of technical operations, remembers the days when design and manufacturing were done by hand. That was the only way things could be done then, and it resulted in many ill-fitting parts. "It was very common to do a lot of shimming—filling in to make a piece fit just right," Kelly explains. "But now, with numerical control machines, the parts are usually right on the mark."

Kelly adds that GEMS has done more than just make parts fit right. He believes the system has saved the company 40% to 50% in tool design and NC programming costs, and about 25% in production. Overall, he calculates, GEMS has reduced the labor needed to perform certain jobs by 43%; in some cases, savings have ranged as high as 75%.

"Our lowest gain was in our first

application," Kelly remembers, "when we were learning the procedures and getting the people comfortable with the system. Then we had a productivity gain of 10% to 12%.

Such gains would make most accounting departments extremely pleased. But not Grumman's; the company had already spent \$26 million on GEMS since 1975, and top management wanted to see some bottom-line results.

"In this business, we have to show our customer (the government, in many cases) that the total cost of a product goes down even though our overhead goes up," Kelly explains. "The large capital investment in the GEMS program made our accountants shudder," he adds, "because it reduced our labor hours, which we can often charge to our customers, and at the same time raised our overhead, which we cannot always charge to our customers."

Although Kelly admits that the overhead will probably never decrease, he says the cost of production will.

One use of GEMS is the design of product dies, which used to be done one "baloney slice" at a time. Instead of stacking up slices to rough out a three-dimensional template, the system can produce smooth, curved surfaces directly from drawings done on terminals.

The system also saves time and money in the design and manufacture of tubing. A designer starts with his terminal in 3-D mode and designs, on the screen, a run of tubing through the planes and its different zones. Information in the system's shared database can be used to check for interference with other parts that may be in the way.

"Once the tubing design is complete," Petrovits says, "we run programs that check the raw stock specifications and calculate the springback and bend angles based on the geometry data. I can actually bend that tubing, or at least a graphic representation of it, in the computer."

—Charles Bruno

tional corporate data processing functions such as financial, forecasting, inventory, quality control, and other vital processes.

Steve Gondart of the CIM group at CV maintains that the manufacturing database will "ultimately be from 20 to 50 times larger than most current data processing databases" and be composed of "process plans, fixture and tooling design, NC programs, quality control and inspection programs, robot programs, and process programs."

Although CIM techniques will increase productivity, lower costs for materials, labor, and energy, and improve product quality, its implementation is not without problems. Because of its integrative nature, CIM technology must have a profound effect on a company's organization, structure, and labor relations. The current trend in American industry to defer long-term planning in favor of short-range profits is inhibiting CIM implementation. If these and other problems

can be overcome, CIM can help insure a role for U.S. manufacturing technology in an increasingly competitive international marketplace. \*

Eric Teicholz is president of Graphic Systems Inc., a Cambridge, Mass.-based CAD/CAM consulting and software development group. Mr. Teicholz edited *The CAD/CAM Handbook*, soon to be published by McGraw-Hill.



*New from Timeplex:*

# **A brawny, brainy system for building large distributed switching networks.**

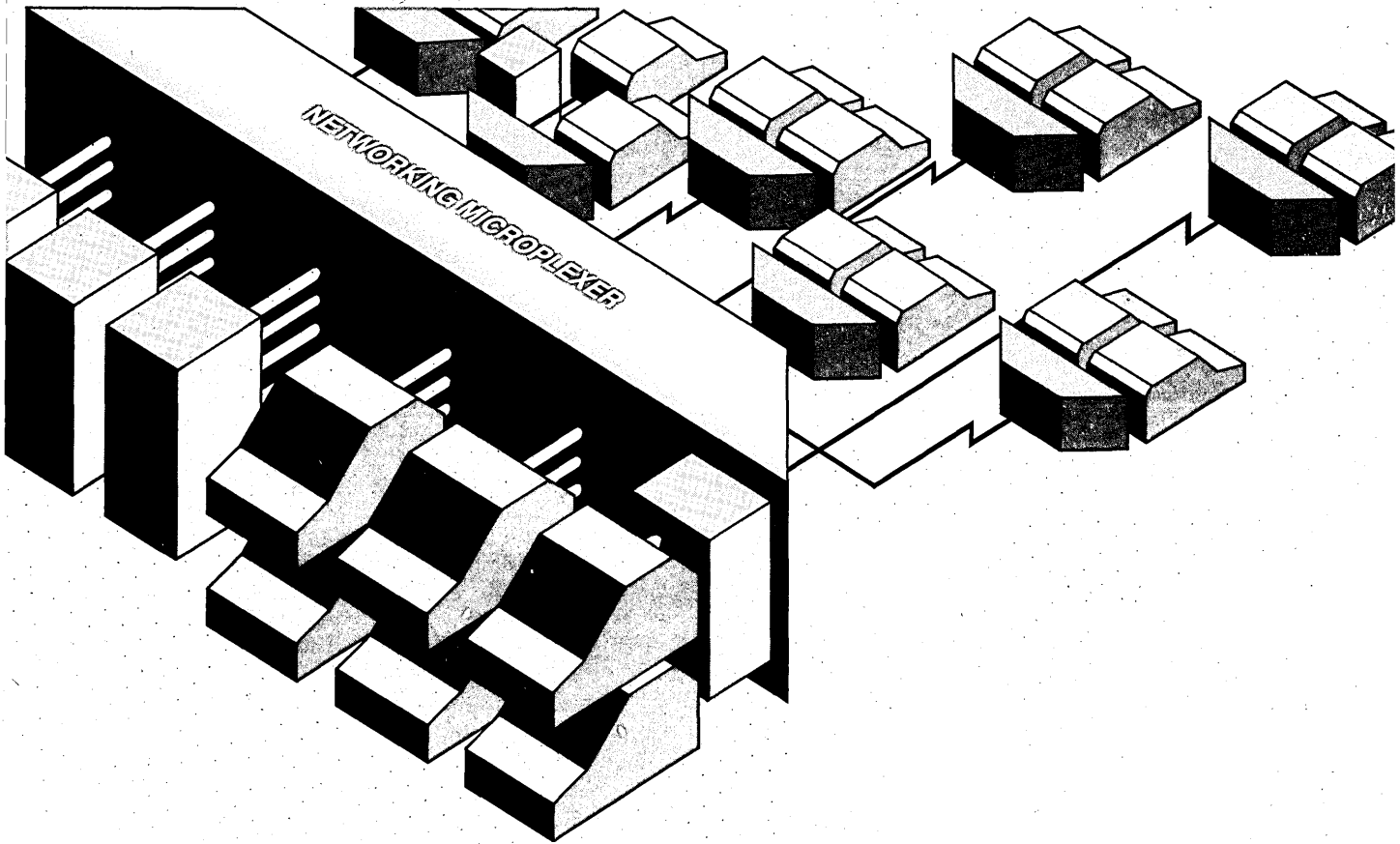

**The NETWORKING MICROPLEXER. Made to give you the muscle to efficiently run your multi-node, data switching network... with all control from a single location.**

Compatible with our SWITCHING MICROPLEXER family, the NETWORKING MICROPLEXER combines the flexibility of switching with the economy of statistical multiplexing.

**Large host-end channel capacity** provides numerous local ports at central site.

**Integral port contention and switching** permits more users to access a fewer number of ports.

**Stat muxing of both asynchronous and synchronous data** lets you use SDLC, BiSync, DDCMP and many other protocols.

**And more.** Fault-tolerant features to eliminate catastrophic failures, comprehensive diagnostics. We could go on. Because the advantages are as powerful as... the NETWORKING MICROPLEXER.

Write or call us today for more information:  
Timeplex, Inc./400 Chestnut Ridge Road  
Woodcliff Lake, N.J. 07675/Phone: 201-930-4600  
Attention: Corporate Communications

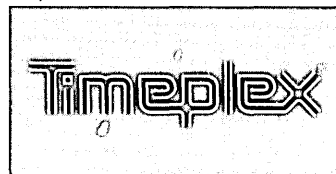

**The technology leader  
in data communications**

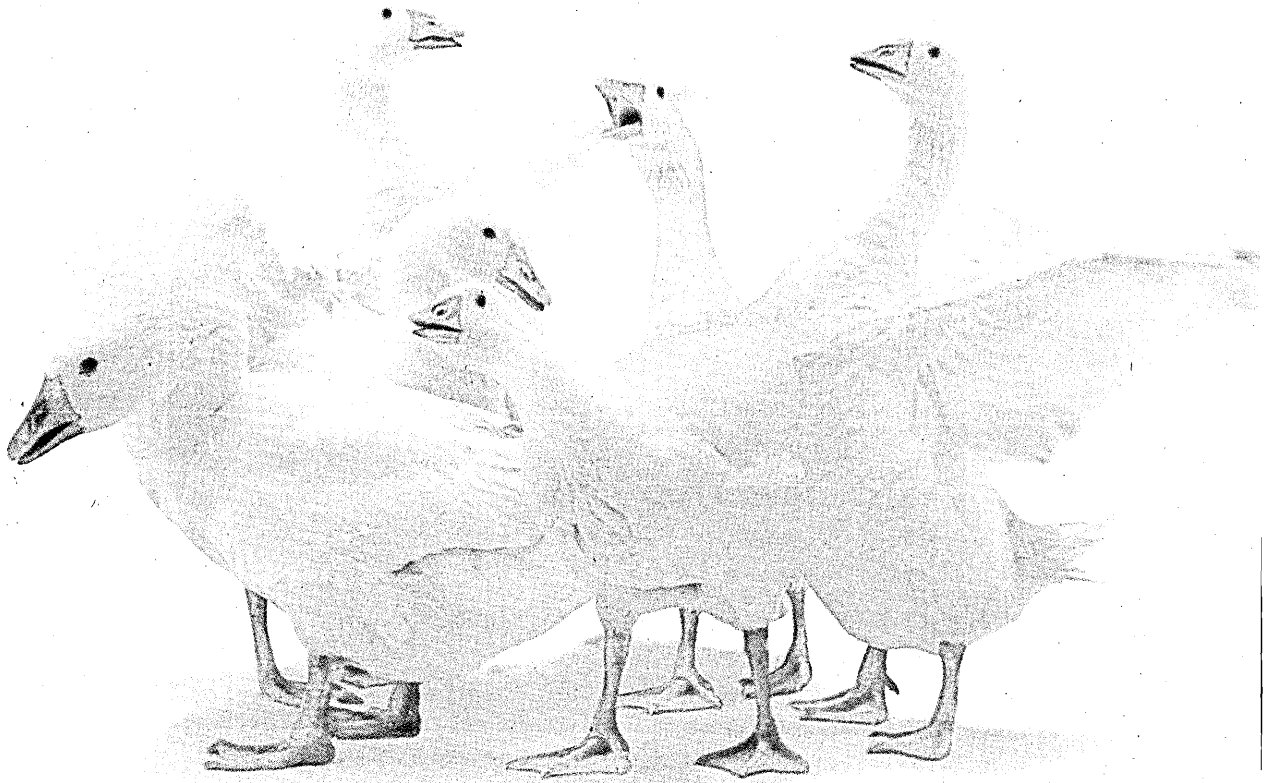

# While everyone else has been squawking about private networks, one company has been quietly building them.

Today, with dozens of new companies and hundreds of unproven products all promising to perform networking miracles, the noise level has become exceedingly loud.

And the job of finding the right company to build your network has become more confusing than ever.

Meet BBN Communications. In the midst of the noise and confusion, we've been quietly building networks for government agencies and major corporations around the world. In fact, we built the world's first packet-switched computer network back in 1969.

But what sets us apart even more than our experience is the way we work. Instead of the usual short-term "fixes," we're committed to providing long-term solutions. So before we design your network, our communications consultants will analyze your specific needs—present and future. And based on them, establish your optimum network configuration. Then we'll build your network. Of course, even after everything is working to your satisfaction, we'll still be around to help with your future needs.

## It takes more than computers to make a computer network.

Another thing that makes us different is that we manufacture a full line of our own proven networking hardware and software, not just a few isolated products. Including packet switches, terminal access



*Our communications processors are the most advanced available today.*

devices, and electronic mail systems. All of which simply means we can supply everything you need.

What's more, our entire product line is fully X.25 compatible and easily interfaces with public data networks.

But state-of-the-art technology is just the beginning. We also provide a network operations center so

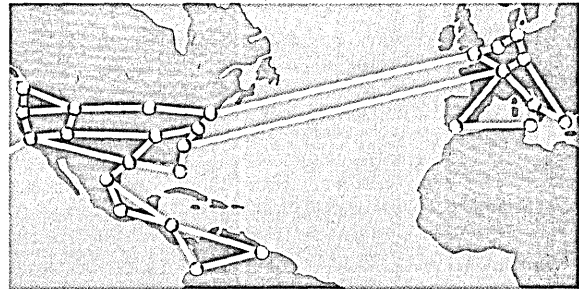

*Packet-switched networks built by BBN Communications link companies with offices around the world.*

you can monitor your entire network at a glance and control it almost as easily. We'll even run the center for you if you like. And to ensure maximum network reliability—and uptime—we offer round-the-clock field service by the most experienced communications engineers in the business.

Just because we're the networking leader, don't think for a minute that we're resting on our accomplishments. Our R and D effort is one of the largest in the industry, with major programs in protocol development, network control, and future network applications. And, of course, our customers receive the full benefits of every breakthrough we make.

## We're the networking leader.

Fifteen years ago, we pioneered packet-switching technology to build the Arpanet, the world's first packet-switched computer network. Today, Arpanet supports 10,000 users and over 300 different computers in the United States and Europe, and the technology we invented for it has become a cornerstone of the data communications industry.

As the networking leader, our customers include major financial, manufacturing, and industrial corporations from all over the world. Recently we've even been selected to build and run the U.S. Defense Department's major new computer network, the Defense Data Network.

So if you're tired of all the squawking, consider BBN Communications. We think it's about time you got your network, and some peace and quiet, too.

For a brochure on our complete networking capabilities, contact BBN Communications Corporation, 33 Moulton Street, Cambridge, MA 02238, (617) 497-2800.



**BBN Communications Corporation**

CIRCLE 105 ON READER CARD

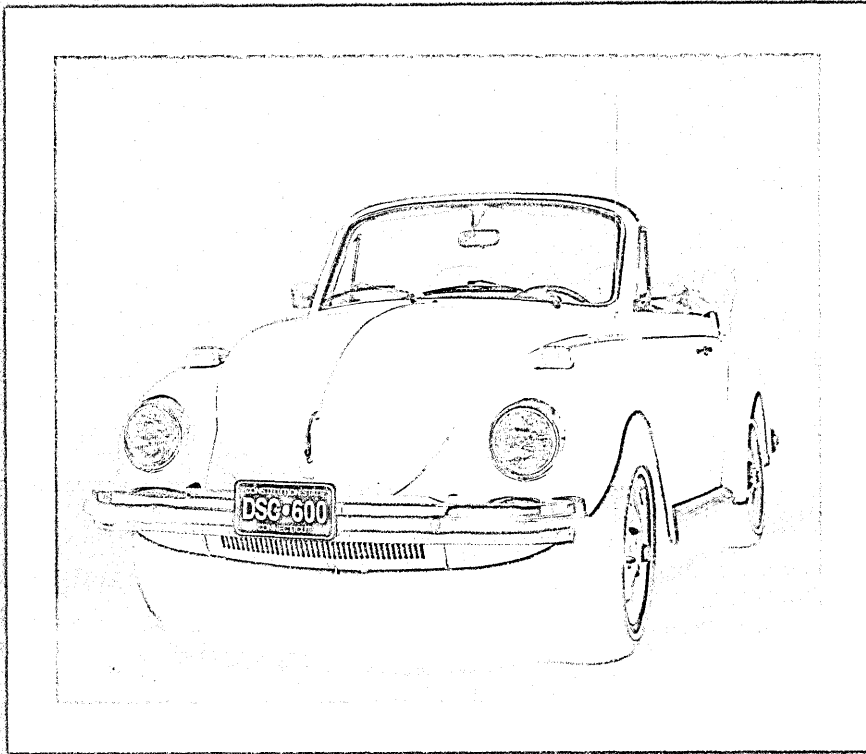

...if it were a car  
it would look like this!

Even if your switching requirements are modest you can now gain the benefits of peripheral matrix switching at an affordable price.

The Model 600 solid state switching and control matrix gives you all the advantages of the field-proven Data Switch technology in a compact, high performance, very reliable and very affordable switching and control system.

The Model 600 is your most efficient entry into the Data Switch family of Configuration Management Systems (CMS).

The Model 600 is a small price to pay for a truly "Fault Tolerant" data processing center...

"Bug" us a little—we'll show you how it works!

We Make Your Systems Fault Tolerant From End to End.

**DATA**  
**SWITCH**

444 WESTPORT AVENUE  
NORWALK, CONNECTICUT 06851  
203/847-9800 • TWX 710-468-3210

CIRCLE 106 ON READER CARD

**Tension between labor and management has been exacerbated by the recessions of the past 10 years and Japan's emergence.**

# LABOR RELATIONS IN THE AGE OF ROBOTICS

by Charles Bruno

Manufacturing technology, depending on whom you ask, is either the great hope of U.S. industry or a pernicious threat to the workforce. To management, manufacturing automation promises improved factory efficiency; to organized labor, it jeopardizes workers' livelihoods.

There's no question that robots, CAD/CAM, and other manufacturing automation techniques can replace people. And the unions, in this era of high unemployment, are trying harder than ever to help their rank and file stay on the job. Unions recognize that industry must automate in order to remain competitive and stay in business. But labor also wants to preserve jobs; if that is not possible, it wants companies to retrain displaced employees for new jobs it feels industry has an obligation to create. "Management has to consider the people aspect of manufacturing," says George Kohl, a research economist with the Communications Workers of America. "If you spend money on automation, the flip side is that computers can't do human things. There are production workers who've worked at factories for years. They have lots of knowledge to offer."

Management wants to improve productivity, spend less, and make more money. It believes that industrial progress, per se, creates jobs, and better ones at that. The way to achieve progress, the management theory goes, is technology. Neither unions nor the most conservative business managers have found alternatives to computing, robotics, and automated design systems.

The tension between labor and management has been further exacerbated by the recessions of the past 10 years, and the emergence of Japan as a major industrial force. The recessions reduced consumer spending, putting manufacturers in a profit squeeze, and leading to layoffs in many industries. Labor and management were put on the defensive. Those consumers who did spend

wanted quality and efficiency, particularly in the most expensive consumer product, the automobile. They found it, increasingly, in Japanese products.

The quality of Japanese products has been steadily improving for 20 years. Early on, Japanese manufacturers saw the potential benefits of factory automation, even though their labor costs were substantially less than those in other industrial countries. They took the long view, and so far it has paid off. Japanese industry has a 10-year headstart on American industry; it has learned how to make automation work.

For example, Japan's Nissan recently opened a 3.4 million-square-foot factory in Smyrna, Tenn., which houses three distinct automotive plants that use robots to apply paint, spot and arc weld, and even select tires

for the vehicles being assembled. The company claims its plans constitute the "most technically advanced automotive facility in the world."

At an average cost of \$60,000 for each of the 220 robots, Nissan has made a sizable commitment to automated assembly; the company feels that the robots will ultimately make a difference in quality as well as profits. In order to ensure the factory's success, Nissan also built a \$4 million training center and sent 383 supervisory personnel and technicians (the company calls all their production workers technicians) to Japan for extensive schooling. Technicians received up to 360 hours of training in welding, hydraulics, pneumatics, electrical, electronics, or other fields related to robotics.

Nissan's effort is its answer to the

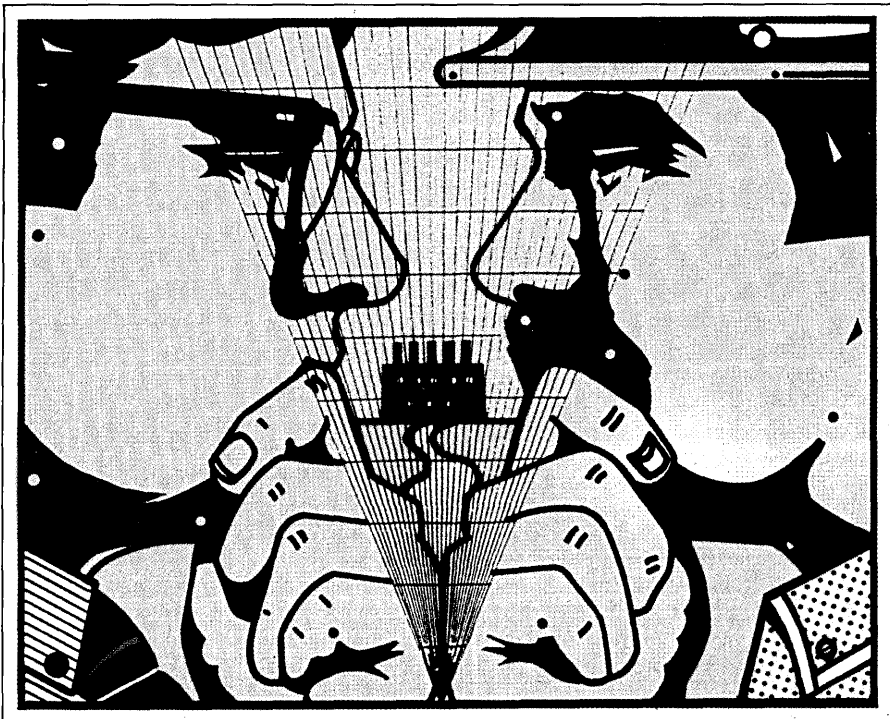

ILLUSTRATION BY CRIS SPOLLEN



## "The time to notify unions is when the corporation first considers automating."

problem of getting people and machines to work in harmony. "There's a problem with robots today," notes Emil Hassan, manager of Nissan's painting division. "The robot industry is far ahead of personnel who are qualified to work in less demanding situations. What we've done here is to try to balance the equation."

### HANDS-ON TRAINING GIVEN

The parent company helped too, by spending \$63 million on initial training of personnel for the American plant. A good chunk of that money was spent overseas. In Japan, American Nissan technicians worked in similar truck factories getting hands-on experience. The typical worker labored six to eight weeks in Japan, while supervisory personnel spent as long as 40 weeks in training abroad.

"It is a company's responsibility to fully train robot technicians. You just can't leave all repairs to the maintenance staff," claims Hassan. "You've got to let the technicians get their hands dirty, and to learn how to program, operate, and diagnose robots. Too many companies rely on specialists; we believe in the opposite. It should be that way from the start. If the employees understand the mechanics of their machines, they will understand how to operate them properly."

Maintenance technicians not only visited vendors, learning how to operate robots, but also tinkered with the machines. As a final test, the American maintenance technicians had to take apart and reassemble an entire robot.

Back at the American training center—which is equipped with duplicate plant equipment—technicians in training learn theory in classroom courses and then apply that knowledge before they ever begin working with robots on the factory floor.

In exporting its Japanese-style manufacturing and training to the States, Nissan serves as a good model for bringing automation to the assembly line and integrating human and automated labor. But critics maintain that the relationship between labor and management here and there is very different. East will simply not meet West when it comes to labor relations, so American companies and American unions will have to develop American-style labor agreements. Some progress has already been made, notably in the auto industry, but this is only a beginning.

The challenge, then, is in bringing together the talent in two camps that have spent years in adversarial behavior. There really is no alternative: manufacturers cannot eliminate their labor problems, no matter how many robots they buy; and unions will not be able to hold back the inevitable in-

### WHAT THE WORKERS WANT

Following is the Workers' Technology Bill of Rights of the International Association of Machinists & Aerospace Workers:

I. New technology should be used in a way that does not decrease jobs, but creates or maintains jobs and promotes community-wide and national full employment.

II. Unit cost savings and labor productivity gains resulting from the use of new technology shall be shared with the production workers at the local level and shall not be permitted to accrue solely for the gain of capital, management, and shareholders. Increased leisure time resulting from technology shall result in no loss of real income or decline in living standards.

III. Since the greater part of the local, state, and national tax revenues comes from taxes on labor, communities and the nation have the right to require employers to pay a robot tax, as a replacement tax, on all machinery, equipment, and production systems that displace workers and cause unemployment.

IV. New technology shall improve the conditions of work and shall enhance and expand the opportunities for knowledge, skills, and compensation of workers. Displaced workers shall not be penalized with loss of income and shall be entitled to training and retraining.

V. New technology shall be used to develop the U.S. industrial base, consistent with the full employment goal, before it is licensed or exported abroad.

VI. New technology shall be evaluated in terms of worker safety and health and shall not be destructive of the workplace environment, nor shall it be used at the same expense of the community's natural environment.

VII. Workers, through their trade unions and bargaining units, shall have an absolute right to participate in all phases of

management deliberations and decisions that lead or could lead to the introduction of new technology or the changing of the workplace system design, work processes or procedures for doing work, including the shutdown or transfer of work, capital, plant, and capital.

VIII. Workers shall have the right to monitor control room centers and control stations. The new technology shall not be used to monitor, measure, or otherwise control the work practices and the work standards of individual workers, at the point of work.

IX. Storage of an individual worker's personal data and information file by the employer shall be tightly controlled and the collection and/or release and dissemination of information with respect to race, religious or political activities and beliefs, records of physical and mental health, and mental disorders and treatments, records of arrests and felony charges or convictions, information concerning sexual preferences and conduct, information concerning internal and private family matters, and information regarding an individual's financial condition or credit worthiness shall not be permitted, except in rare instances related to health, and then only after a consultation with a family or union-appointed physician, psychiatrist, or member of the clergy. The right of the individual workers to inspect their own data file shall at all times be absolute and open to him or her.

X. When the new technology is employed in the production of military goods and services, workers, through their trade union and bargaining agent, have a right to bargain with management over the establishment of Alternative Production Committees, which shall design ways to adopt that technology to socially useful production and products in the civilian sector of the economy.

crease in factory automation with strikes or bargaining.

Some factory managers say the new manufacturing technologies may at first eliminate jobs, but that eventually, everybody will benefit. "In the short run, automation's going to hurt the unions," says Randy Hale of the National Association of Managers, an organization that represents management of 13,500 companies. "But in the long run, automation will increase employment because the increase in productivity and sales will translate into added jobs."

Not only will automation create more jobs, managers say, but it will also upgrade existing jobs. And, they say, management

will retrain employees to fill those new, improved jobs. "With automation, employees will not be in boring, repetitive jobs," says Hale. "Instead, they'll be retrained for a job at the other end of the spectrum."

As a result, they say, unions must allow management to introduce factory automation on its own terms. For example, some unions contend that management should tell them about plans to introduce factory automation months, even years, in advance; many managers say there is no need to do so. "If we were to do this," says Hale, "it would presuppose an impact and that there would be layoffs as well. In some cases, there will be no layoffs." Some factory managers say they

# How To Implement The Best New PC Decision Support Software With A Pair Of Scissors.

2345

YES. Tell me more about The New Context MBA and The Corporate MBA.  
 Have a Context representative call me.

Name \_\_\_\_\_

Title \_\_\_\_\_ Company \_\_\_\_\_

Address \_\_\_\_\_

City \_\_\_\_\_ State \_\_\_\_\_ Zip \_\_\_\_\_

Area Code \_\_\_\_\_ Phone Number \_\_\_\_\_

SEND TO: Context Management Systems, 23868 Hawthorne Blvd., Torrance, CA 90505.  
Or call us at 1-800-437-1513 (In CA, call 1-800 592-2527)

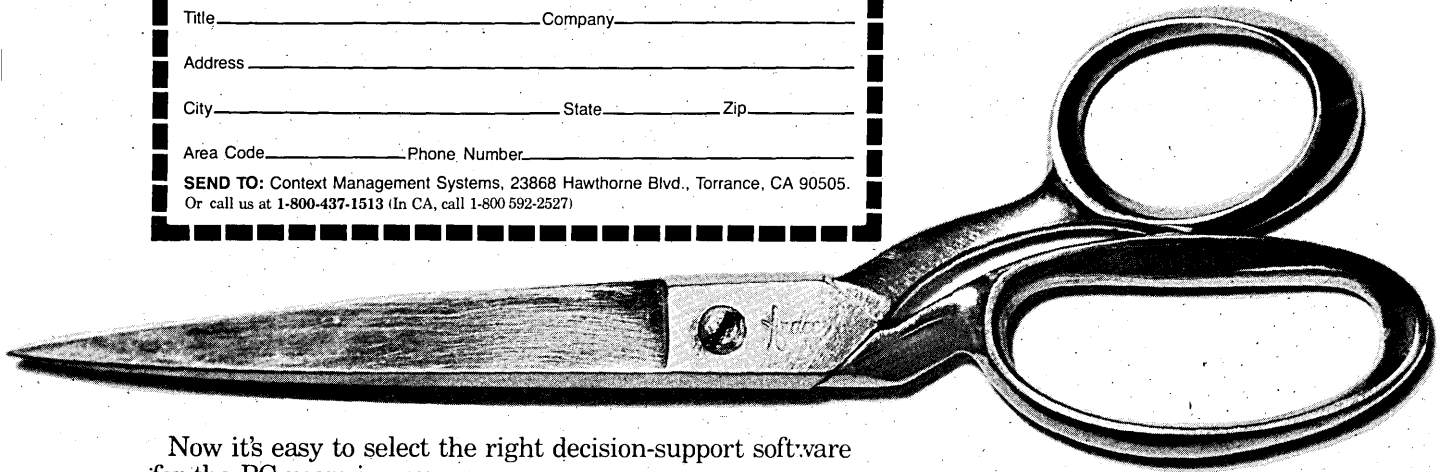

Now it's easy to select the right decision-support software for the PC users in your company.

The New Context MBA™ and The Corporate MBA™ both have all the functions PC users in your company need: Spreadsheet, Business Graphics, Database, Word Processing, Telecommunications, and Forms Creation.

They're all *integrated* in one software package. With advantages that'll make your life a whole lot easier.

Like full 3270 emulation. So *you* can connect their PCs to your Data Center network. For immediate, yet controlled, access to decision data. No more hand-holding or custom programming.

PC users in your company get the decision-support capability they need from a single, easy-to-learn package. And you get an easy way to plug one PC software package into the entire company.

Our Context 500™ support team builds a custom training and ongoing support program for your company, so *you* don't have to.

Now *your* job of supporting *our* software is as easy as picking up the phone.

So make it easy on yourself. Cut out, fill in, and send us this coupon. And cut out a lot of heartburn over which of many PC software packages to choose.

Now where did you put those scissors?

## Context

MANAGEMENT SYSTEMS

**Personal Computer Software For Business Decisions.**

The New Context MBA, The Corporate MBA, True Data Integration, Data Exchange Facility and Context 500 are trademarks of Context Management Systems, Inc.  
©Context Management Systems, Inc. 1984.

CIRCLE 108 ON READER CARD

# "No robot can replace the knowledge, born from experience, of a man who has worked in a factory for 20 years."

will retrain any of their employees who lose their jobs to robots, CAD/CAM systems, or other manufacturing technologies.

Another manager, Paul Guy, director of manufacturing and engineering systems at Ford Motor Co., says, "The time we notify unions depends largely on how long it takes to have manufacturing technology equipment delivered to our door. Sometimes it's four to five months, sometimes 10 to 12."

## CAUTIOUS APPROACH PREFERRED

Other managers advise taking a cautious approach to introducing new manufacturing technology. Ford's Paul Guy says the company consciously avoided using the term "robot" when it started bringing robots in. Ford management didn't want to frighten its employees, and it knew the word had fearful connotations. Instead, it referred to the mechanical arms as "productivity systems."

Ford also gives its employees a chance to be heard. It has formed a joint union-management council to encourage a dialog on factory automation.

In addition, managers of small companies may have a more difficult time negotiating with their employees when a factory is automated than managers of huge corporations. That's because small unions, or small parts of larger unions, are more likely to stage a walkout. Larger unions have typically chosen to negotiate.

Many unions say the benefits of manufacturing automation should be shared equally between labor and management. "The UAW is preparing to face the future," Tom Weekley, a union representative, said recently. "Automation will continue, but workers have to be prepared to share in the

benefits. . . . It shouldn't be one-sided."

One of organized labor's biggest complaints is that management doesn't give unions enough time to prepare for the effects of new manufacturing technology. "Management agrees this is an important issue," says George Poulin, vice president of the International Association of Machinists (IAM), "but when it comes down to notifying the union, management waits until two or three months before they plan layoffs."

Paul Guy, of Ford, agrees. "Most unions are concerned with surprise," he says, "and in the middle of a peak rush, if a set of robots shows up unexpectedly at the loading docks, a manufacturing manager is going to have a problem on his hands."

"The time to notify unions," says Poulin of the IAM, "is when the corporation first considers automating. That will give us ample time to meet our responsibilities—we have to plan within the community for workers to be assimilated into new jobs."

Poulin also says that, as far as manufacturing jobs go, the worst is yet to come. "We believe that manufacturing automation's greatest impact on jobs will come during the next two to four years," he says. "With all these companies committing to automation right now, it will be that long before the unions will feel the threat."

Other union leaders stress the impossibility of machines ever totally replacing humans in the factory. "You can spend a million dollars on automation, but it may not be as efficient as the human mind," says CWA's George Kohl. "There are things that humans can do that robots can't do. For instance, no robot can replace the knowledge, born from experience, of a man who has worked in a factory for 20 years."

Management's promise that factory automation will upgrade existing jobs is scoffed at by many union leaders. Instead, they believe the new technologies will create more low-level jobs. "The idea that automation creates higher-level jobs isn't quite true," says Kohl. "There was a Boston College study of aerospace workers at a factory that was installing machine-tool automation; the researchers found that only one out of every five employees was actually trained in a high-tech area, while the remaining workers wound up in low, service-area type jobs. There's going to be a disappearance of the middle-level job, and there's going to be a huge gulf between service-oriented jobs and high-tech jobs."

Management must learn to work with its employees, say many labor leaders. They suggest two basic changes. Manufacturing management should form joint labor-management discussion groups (as Ford, for one, has already done), where labor can express its ideas and make suggestions. Management should also assume responsibility (financial and otherwise) for retraining displaced employees, the labor leaders say, even if that means retraining laid-off employees to work in a new field (see box).

Another idea being discussed by organized labor is the four-day workweek. This, some union leaders say, will allow more people to retain their jobs in the face of increasing factory automation. Not surprisingly, manufacturing management has not welcomed this idea eagerly. Yet it seems to be a concept that is capturing the imagination of a growing number of unionists.

Despite labor and management's opposing views, cooperation is still possible. For example, while many companies and unions are squabbling, Ford Motor Co. and the United Auto Workers are trying to work together as Ford automates its factories. They have formed a joint council that meets at least once every fiscal quarter to discuss both Ford's plans for automation and the union's concerns.

Ford has also built a training center for retraining employees who have been displaced by manufacturing automation. In some cases, the displaced employees are trained to work in jobs outside the auto industry. Again, the emphasis is on labor and management working together; funding for the center is shared by Ford and the UAW.

Even in this age of robots, cooperation between people is still the most effective way to get things done. \*

Charles Bruno, an editor and reporter at *Technology News of America*, covers the American computer industry for foreign publications.

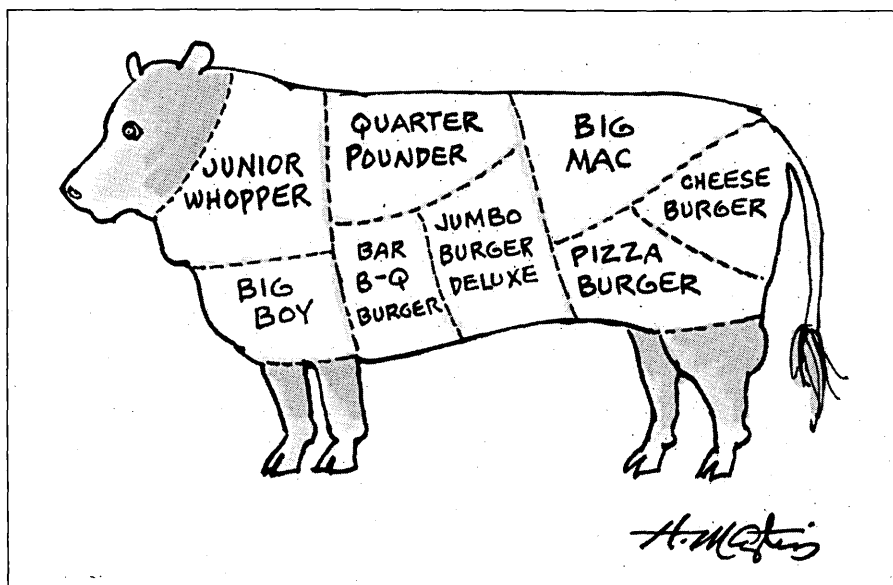

CARTOON BY HENRY MARTIN

# Finally a CICS query system that's as easy for the DP department as it is for the end user.

## Introducing ExecuTrieve.™

From the perspective of the DP professional, ExecuTrieve represents a dramatic breakthrough in query system efficiency.

**No disruption.** ExecuTrieve operates with your existing files in your CICS environment. It doesn't require costly system changes or any additional programming.

**Low overhead.** Through the use of our proprietary access method, users can browse or create complex reports with remarkably low I/O and CPU overhead.

**Easy to install.** ExecuTrieve can be installed and operational in as little as one afternoon.

Of course, efficiency is only half the story. ExecuTrieve makes as much sense for the end user as it does for you. Look at it from the other side.

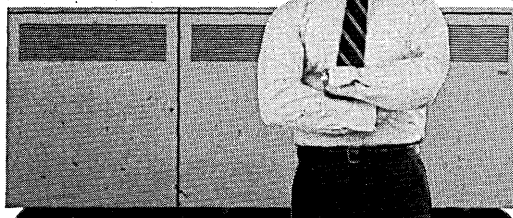

## Introducing ExecuTrieve.™

From the perspective of the end user, ExecuTrieve is a remarkably simple, but powerful query system.

**Easy to learn.** ExecuTrieve is a free-format fully on-line system using simple English syntax and requiring no computer sophistication. An editor even allows you to correct errors anywhere in the text.

**Quick response.** Our proprietary access method means quicker response to even the most complex queries. In fact, the more complex the query, the quicker the response.

**Complete reports.** ExecuTrieve has a report generator and graphic capability. So it's a snap for non-pros to develop effective reports.

Efficient for the professional. Easy for the end user. Any way you look at it, ExecuTrieve is a query system worthy of investigation. Call 800-526-0272 or write On-Line Software International.



ExecuTrieve™  
for CICS from

**ON-LINE  
SOFTWARE**

INTERNATIONAL

Fort Lee Executive Park  
Two Executive Drive, Fort Lee, NJ 07024  
(201) 592-0009, Toll Free (800) 526-0272

# Last year our fire protection systems kept the heat off a lot of business owners.

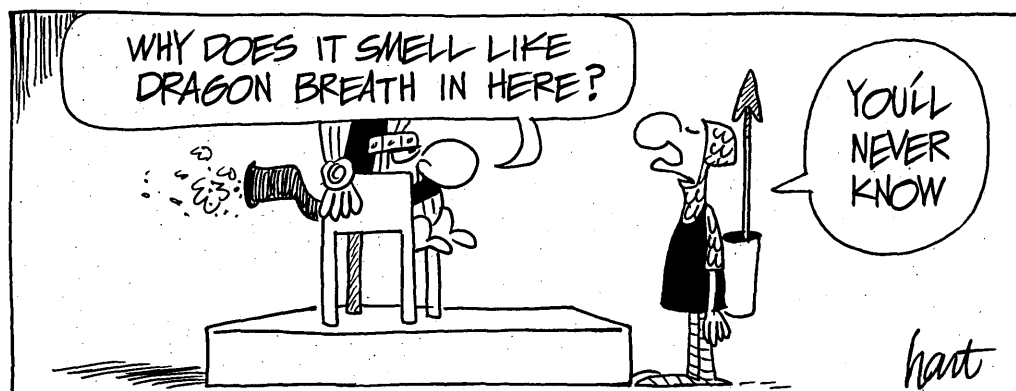
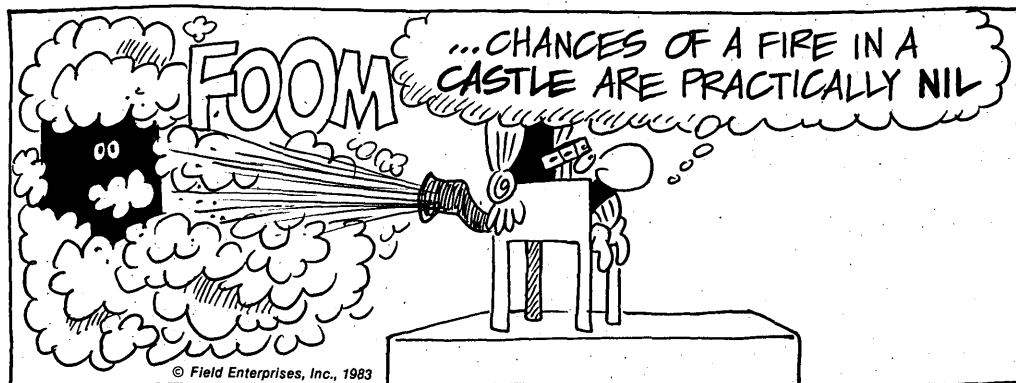

It's sheer wizardry the way Fenwal's suppression systems spot fire and snuff it out instantly. Our systems use the fastest way known of stopping fire, Halon 1301. It's perfectly clean and people-safe. That keeps downtime to an absolute minimum.

We've been building and perfecting our systems for more than 20 years. There are thousands installed around the world. Because Fenwal manufactures all its own major system components, you get a system with components built to work together and backed by single source responsibility.

Plus the attention of a *local* factory trained wizard who's knowledgeable in cost efficient system configuration.

Whatever you want to protect—valuable documents, computer rooms, communication centers, control rooms, switching rooms, anything at all that you can't afford to be without—we can do the job.

For the name of your local Fenwal wizard, look in the Yellow Pages under "Fire Protection," or contact the Castle at (617) 881-2000. Fenwal Incorporated, Ashland, MA 01721. A Division of Kidde, Inc.

# FENWAL®

CIRCLE 109 ON READER CARD



A tale of frustration, triumph, and word processing in the Paleolithic era.

# A LEXICOGRAPHER'S ADVENTURES IN COMPUTING

by Laurence Urdang

In all fields of endeavor, there are basically two classes of practitioners: those who have a genuine understanding of how and why things work, and those who have little if any notion of the principles involved. The first class is exemplified by the electrical engineer who knows a great deal about the generation and transmission of electricity; the second, by the naive individual who merely plugs a lamp into a wall receptacle and neither knows nor cares how or why the light goes on. The limit of the latter's sophistication may well be the ability to change a light bulb.

Computers are essentially extremely simple devices; to paraphrase "Paul Revere's Ride," binary (that is, digital) computers operate on the principle "one if by land, and none if by sea." (The only problem with such a code pattern is, of course, that if you are "on the opposite shore," you have no way of knowing, in the second instance, whether the British are coming by sea or if the signalman has simply lost his matches.)

The core of the digital computer consists of little more than a bank of such "flip-

flop" circuits, the on-off patterns of which are arbitrarily coded to patterns of information; it is the programmer's function to create the information coding patterns, generate the complex instructions that are required to operate the circuits, and translate the resulting patterns back into forms of information interpretable by human beings. That function has been greatly simplified by the creation of computer languages, and almost all computers today are prewired to accept and to perform operations under instruction employing one or more such languages.

The presentation of the foregoing to readers of DATAMATION may be regarded as akin to teaching a grandmother to suck eggs (though I must say that I never saw my grandmother suck eggs and can be reasonably sure that she was unaware of how to go about it.) Yet, a moment's reflection will likely confirm the observation that an increasing number of systems designers and programmers know very little about the principles of computer operation and, because their work is, in large measure, by rote, care very little about how or why a computer works as long as it performs the tasks they set it to do. For many

applications, such an attitude is acceptable, even though it has turned many computer professionals into mere bulb changers; but there is no gainsaying that among the ancillary results today is the unfortunate dearth of imagination going into the solving of major problems in information processing. The writing of programs for a new computer game may be ingenious, but it embraces a technology that is readily assimilated by a 12-year-old idiot-savant (perhaps even more readily than by a genuine computer expert, whose mind is more likely to be cluttered by all sorts of reasons why something *cannot* be done).

Although I was a bit late in becoming involved with computers, having approached them first in 1959, there seems to be a danger of my becoming a senior citizen in the field: just as almost two thirds of the earth's population today was born after the end of World War II, so nearly 95% of those currently engaged in computer work became involved in it since the early 1970s. I scarcely view myself as a "grand old man" of computers, but there are not many of us around today (like veterans of the Spanish-American War) who

ILLUSTRATIONS BY DAVID FISHER

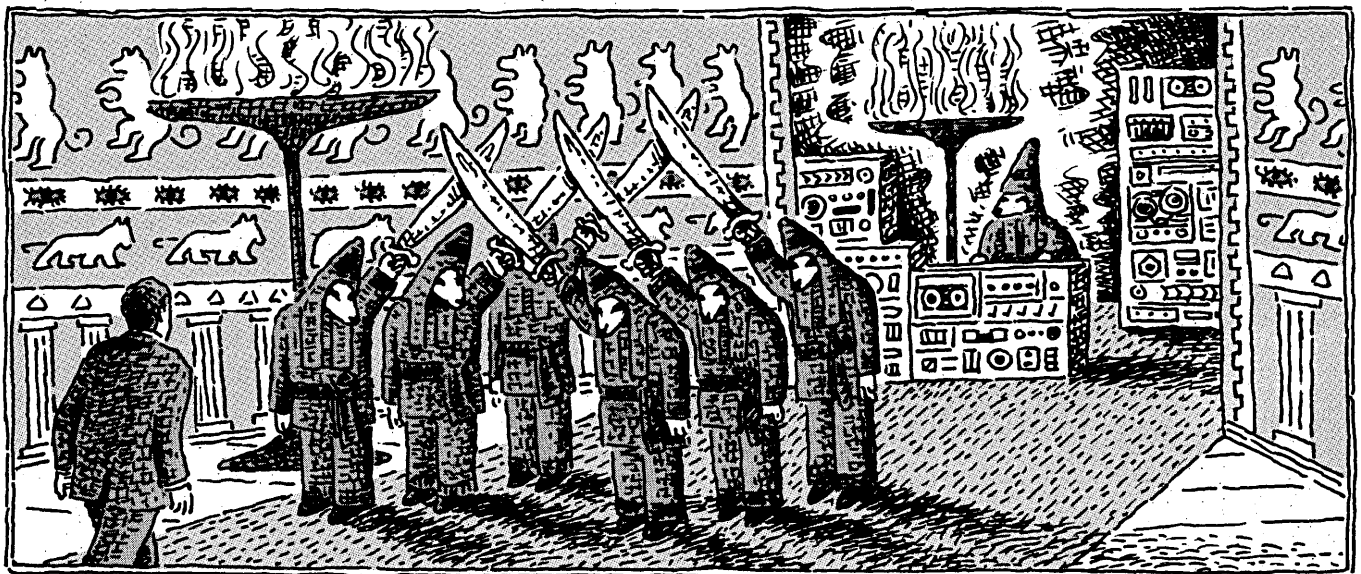

Introduction into the cabalistic rites of computer technology.

## A simple subroutine created a complete concordance of characters.

have been using computers as long as a quarter of a century.

### USING TAPE AS DATABANK

I clearly recall my first brush with computers: in 1959, I was working on a new dictionary for Random House, and it occurred to me that a computer would be ideal for the sorting and manipulation of the various kinds of data I was responsible for generating.

Moreover, the notion of having the entire text of the dictionary in machine-readable form appealed to me because it seemed logical that a tape of some sort, capable of driving an automatic typesetting device, could be generated. If the text could be generated in our own offices, proofread, and corrected there, and, with appropriate coding,

used to typeset the dictionary, then the information on the tape could serve as a databank, allowing me to access it for updating, extraction of certain (coded) categories of information, automatic abridgement, and other useful activities, not the least of which included a variety of analyses of the data that interested me as a linguist and, undoubtedly, would interest others as well.

In 1959, if you knew next to nothing about computers, there seemed to be only one thing to do: I phoned IBM and asked them to send over someone I could talk with. Cordially received, I was at once shunted over to the Service Bureau Corporation (SBC), an IBM subsidiary I had never heard of. As I recall, even though my office was only six or so blocks away, I had to visit them. But that, I thought, would be just as well, for it would

give me a chance to see a computer up close, the only one I had ever laid eyes on being the collection of boxes, resembling filing cabinets, displayed in the (then) headquarters building at 57th St. and Madison Ave. At SBC, I discovered that those boxes didn't look much different close up than they did a dozen feet away, through the plate glass.

I tried my best to explain what it was that I wished to do, and got nowhere: no one understood me. In looking back on the episode, I realize that the situation has changed little today, for, if one is thinking of hiring a computer company to do any sort of original work, it is still not easy to find people with sufficient imagination to address themselves to the task. It would appear that the profitability of programming, now as then, depends on the breadth of its applicability. A company that has developed, for example, a new program for processing the inventory of a manufacturer of machine parts (for which it has been well paid) finds it more profitable to sell what is, essentially, the same program to the company down the street that needs a method for keeping track of its inventory of drugs, or shoes, or men's underwear. That may be good business, but it severely narrows the availability of good computer programmers and of suitable computer programs.

In 1960, by the time we were ready to move toward a contract to hire a firm to do the necessary work, it had become clear to me that it was a lost cause to try to teach computer specialists, no matter how intelligent and receptive, enough about linguistics and lexicography to enable them to write the required software. The only alternative was for me to learn what I could about computers. There was very little to go on, as most of the information then available was of a relatively specialized nature. I talked a lot, especially to colleagues in the American Documentation Institute (since renamed the American Society for Information Sciences) and to a number of people I met who were working at IBM in Yorktown Heights and on research programs at Harvard, MIT, and elsewhere.

During the next few months I wrote a 34-page document setting forth what it was we had, what we wished to do with it, and what we hoped to end up with, and distributed it to about half a dozen companies I had dredged up during my research. (I later discovered that I had produced what was then known in the trade—which, even then, was enamored of abbreviations and acronyms—as an RFQ or RFP, better known to English speakers as a Request for Quotation or Request for Proposal.) In due course, after I spent many hours in briefing sessions devoted to explaining everything all over again to the prospective bidders, proposals (with quotations) arrived on my desk.



The road through new territory is not without hazards.

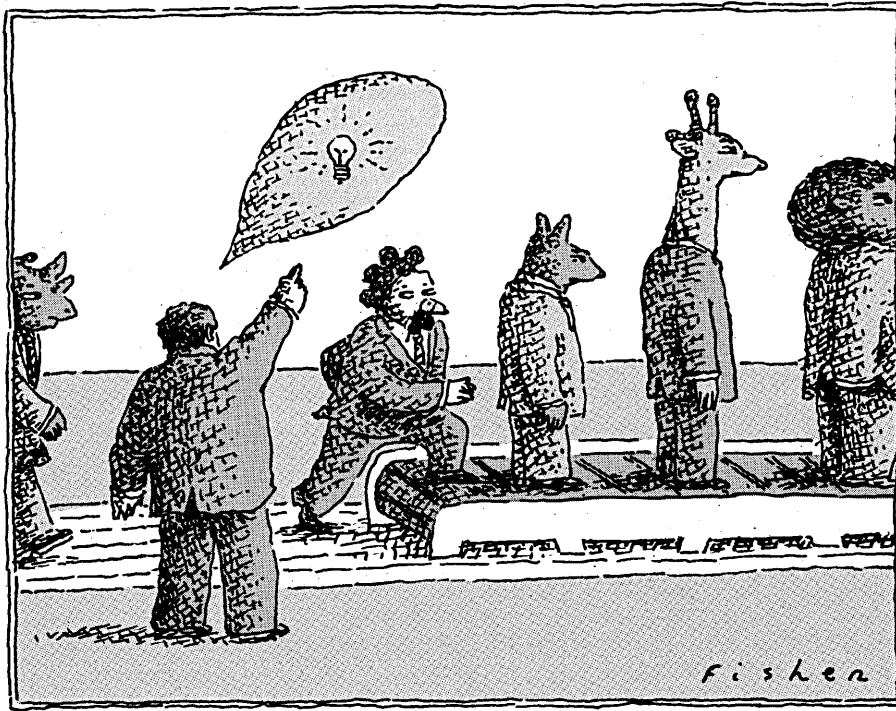

They refused, unanimously, to have anything to do with so harebrained an idea.

Eventually, a contract was let to an independent concern, Computer Applications Incorporated (CAI), a company with bright and eager specialists who impressed me not only because they seemed to know what they were about but because they were articulate and not loathe (or contemptuous of my ignorance) to let me learn. I was thus initiated into the cabalistic rites of the mysteries of computer technology. It is far from an exaggeration to say that as my tutorials were conducted by CAI, so my text became DATA-MATION.

### WORKABLE PROPOSALS SOUGHT

It would be unfair to dismiss all of the other bidders who responded to my RFQ without remarking on the resourcefulness of some of them. On the other hand, there were the inevitable companies who submitted what can best be characterized as peremptory responses: "We have the personnel and the equipment; just tell us exactly what you want and we'll do it on a time-and-materials basis." Such an approach may work in pursuing contracts with the federal government, but they carry little weight with me: I was seeking problem-solvers, and the proposals submitted, while I did not expect them to give away the arcana of the trade, had to demonstrate, at least, some ability to come to grips with the novelty of what we were trying to do.

The association between Random House and CAI was a happy one; in the long run, we got what we wanted; in the short run, both of us learned a lot.

But the road through new territory is not without hazards, and we encountered enough to vie with those met by Christian in *The Pilgrim's Progress*. First of all, there

was the question of how to get the data into machine-readable form. There were no word processors in existence at the time, and the only available technique for coding data was via punched cards; a device called the Uni-Typer supposedly enabled one to keyboard directly to mag tape, but by all accounts, its error factor was too high to make it worthwhile to use. We were dealing with a volume of data of some 65 million bits in all, which was a fairly large corpus of material for those days, and an error factor of 2% or 3% (between 1.3 million and 2 million bits) would have been unacceptable and a far greater percentage than what would result from supplying hardcopy to a compositor who would "keyboard" the text on a typesetting machine.

The solution we arrived at was to use a paper-tape-generating typewriter. We studied the Flexowriter, but decided on the Remington-Rand Synchrotape chiefly because it offered a few more keys and a black/red ribbon shift. In its standard version, it would have proved inadequate to the task set for it, but with the modifications we introduced, we were able to keyboard about 160 discrete characters (on 40 keys), which could be coded into 16 styles and sizes of type, with all of those available in capital and lowercase letters as well. Notwithstanding the versatility of modern word processors and their highly touted typographic keyboarding features, I have yet to see an electronic keyboard device capable of the wide range of typographic characters that we could create on the Synchrotape, which cost about \$2,500 for each custom-made machine. Of course, we had to print out our proof copies on the same machines that produced them, making use of the red/black ribbon shifts (which effectively de-

stroyed any possibility of using machine copies for duplicate proofs). At about 66 cpm, that was a relatively slow business. But the keyboarders were still able to keep pace with the editors and to keep the proofreaders well supplied, too.

As far as I know, the book we produced, the *Random House Dictionary of the English Language—The Unabridged Edition*, was the first to use computers extensively in its editorial preparation. The coding of different levels of information—mainly, entry word, pronunciation, definition(s), variant(s), etymology, run-in entry, illustration—and of more than 150 fields to which definitions were assigned—botany, chemistry, computer science, etc.—made it possible to prepare information for each level and in each field independently, thus ensuring better uniformity of treatment and far greater consistency among related pieces of information than had been achieved on other dictionaries. With all of the data appropriately coded, programs enabled the computer to sort all of the bits and pieces into dictionary order. Once that had been accomplished, it remained only to read through the entire dictionary to make certain of the continuity and integrity of the text.

### DATABASE EASILY ACCESSED

The marking of the definitions, for instance, allowed us to use programs to extract all of the definitions dealing with any given subject field; moreover, had we wished to, we could have extracted only those definitions in *Manège* that had *t* as the third letter in the main entry word, or all words in American slang that had the sound of *oi* in their pronunciation. In short, we had created a powerful database, consisting of a dictionary with about 260,000 entries, which we could access at will.

As I mentioned earlier, there were hazards, and, close to the completion of the entire project, as we neared the typesetting stage, we were advised by Random House's manufacturing department that no satisfactory automatic typesetting machine was to be found, anywhere in the world—this despite the fact that Messrs. Higonnet and Moyroud, inventors of the Photon, had developed a new version of the device that would accept magnetic tape and set type at speeds far greater than ever before. Hence, we were compelled to provide compositors with hardcopy from which to keyboard; in other words, the entire text would have to be keyboarded all over again, a truly daunting prospect and, in my opinion—especially in light of the existence of the new Photon—a thorough waste of time and money.

For those who may think that automatic typesetting has always existed, much

## The documentation provided with micros is execrable, so we produced our own.

like the wheel, allow me to destroy that illusion. In 1965, the only other machine capable of high-speed, graphic arts-quality composition from mag tape was the Videocomp (the American name for the Hell Digiset). My objection to the Videocomp was that it set oblique roman characters instead of true italics, a shortcoming that has since been modified. I also objected to the inherent inefficiency by which the Videocomp, in order to change styles of type, had to dump out of its memory the entire alphabet of the style it was setting and then read into its register the alphabet of the new style. In a complex work like a dictionary, where there may be an average of two and a half changes of type style in each line, the Videocomp would not be operating at its peak efficiency.

At the time, the conventional way of creating hardcopy from tape was to print it out. The chain printer had just become commercially available, and I investigated the feasibility of having a special chain made, chiefly to avoid the restrictions of the conventional printing devices, which offered only capital letters and a very limited choice of characters.

Another reason for avoiding conventional devices was that we would then be compelled to employ a large number of special codes to signal the introduction of a different style of type. Such an arrangement is extremely awkward and prone to proofreading error; for example, instead of showing italic type either as italic type, as one would expect to see in conventional typesetting, or as roman type underscored, we would have to resort to the introduction of a variety of codes and symbols preceding the characters to be set in italic. The usual coding characters were those that were on most typewriter-mode keyboards but were only rarely encountered in text, like @, %, /, \$, and so forth. That approach is still used in some hardcopy preparation; while it may be acceptable for relatively simple text, as in a novel, it is completely unreasonable for a dictionary with about two and a half style changes in each line. Besides, there are all those special phonetic characters in the pronunciations that must be accounted for, as well as the special accents and diacritics needed for French, German, Spanish, Italian, Greek, Latin, and other words that appear with great frequency in the etymologies. In short, the use of coding characters would have created a chaotic, virtually unreadable printout, and another solution had to be sought.

At about that time, General Dynamics was developing the Datatronix, though I do not think it had yet reached the market as a commercially viable product. The Datatronix was said to be capable of reading mag tape and of producing, on 35mm microfilm, a se-

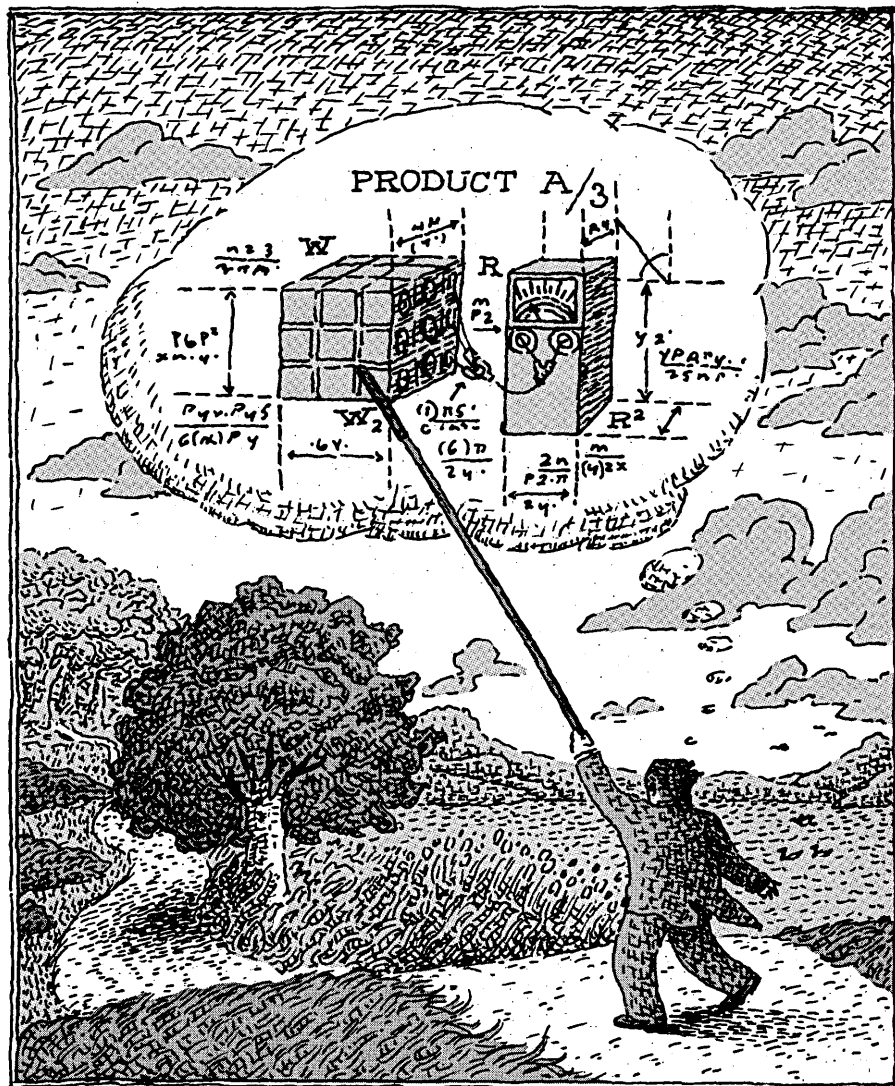

Alas, I still have no laboratory, and the device was never constructed.

ries of character images created by dot generation, by vector, or, in "typewriter" mode, by positioning an image from a 48-character matrix onto the face of a crt; when the face of the type was filled, a 35mm step-and-repeat camera, positioned above the (vertically mounted) crt, recorded the image, one frame at a time. I cannot recall the speed of character generation, but I do remember that when the machine was in operation, a full frame was generated about once every couple of seconds.

### SPECIAL MATRIX CREATED

One of the executives from CAI and I visited the General Dynamics plant in San Diego, examined the Datatronix, and ordered a crt containing a special matrix that I designed and had made to order. It consisted entirely of lowercase characters,

numerals, punctuation marks (including separate characters for single and double and open and closed quotation marks, and a few other symbols that would enable us to create hardcopy that conformed to the standard systems used by copy editors, compositors, and proofreaders to designate different type styles.

Because they were relatively rare, capital letters did not appear in the matrix; instead, they were "drawn" by using the vector-generating capacity of the Datatronix. The dot-generating feature was not used at all, chiefly because the fidelity of characters so created was too coarse when photographed to maintain the precise distinctions we required.

CAI, of course, had the onerous task of writing the formatting program needed to drive the Datatronix, which was somewhat

# New from Interactive Systems/3M:

## The first high-speed broadband local-area network that guards against data crashes.

If you've been thinking of investing in a contention network, consider this: How do you guard against data crashes during times of heavy system use?

Answer: You don't, because contention schemes simply don't provide any kind of data insurance.

Fortunately, there is a new type of network that *does* protect against data loss. It's called 3M Videodata® LAN/1. And it's the first intelligent broadband local-area network that's designed to get data through on time, no matter how much traffic is on the cable.

### Videodata® LAN/1: The efficiency of token-passing plus the proven flexibility and expandability of broadband.

Token-passing networks eliminate contention troubles and data crashes by passing an electronic "token" from terminal to terminal. When a terminal has to transmit, it grabs the token and sends data packets to the receiving device. Receipt is acknowledged and the token is automatically released to continue its rounds. Because the system assigns a network entry address to each user, everyone has an opportunity to send data during each token cycle.

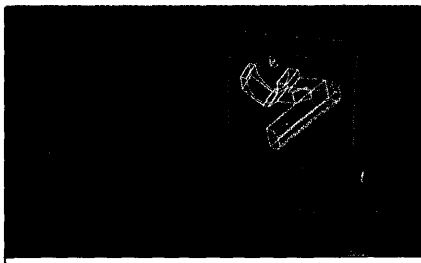

Because Videodata LAN/1 is a broadband system, dedicated channels can be used for full-motion video applications such as CAD/CAM and teleconferencing. These video signals are kept entirely separate from digital traffic on the network's token-passing channels.

So far, so good. But most token-passing networks are baseband systems, meaning that terminals must share a common channel as they would in a typical contention network. This can limit speed and capacity in some applications.

LAN/1 overcomes this possible limitation by combining token-passing with a proven *broadband*

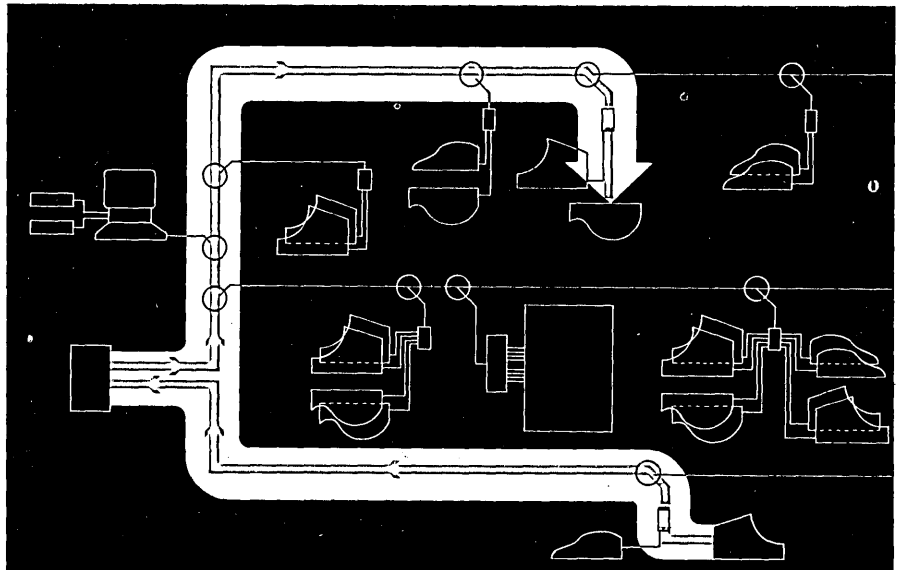

In the Videodata LAN/1 network, messages can be sent from any terminal to any other without going through the host processor. Network Interface Units (NIUs) connect digital devices to mechanical taps (shown as small circles) on the main coaxial cable. A Network Monitoring Unit, or NMU, keeps a statistical record of network performance.

technology that allows many channels to be put on a single cable. The payoff: higher channel speeds, ranging up to 2.5 MB/s over a maximum seven-mile radius, with terminal data rates of up to 19.2 KB/s. Plus a capacity of up to 10,000 devices to allow plenty of room for future expansion.

**Self-monitoring, with a printed record of network performance.** LAN/1 gives statistical proof of its own performance in printed form, thanks to a microcomputer-based Network Monitoring Unit (NMU). This unit, which also helps in routine maintenance and troubleshooting, may be used for remote monitoring as well.

### Separate channels for voice, video, and graphics. Plus the ability to work in point-to-point applications.

Because LAN/1 is a broadband network, channels can be set aside for real-time voice, video, and high-speed graphics. This can be done without compromising digital traffic capacity.

LAN/1's broadband design also permits flexibility in network architecture, so that it can be used in high-speed point-to-point applica-

tions which can't be served efficiently with contention systems.

Other benefits include full transparency, an automatic shut-off feature to keep any one terminal from capturing the token, and compatibility with both dumb and intelligent terminals. The list of features goes on and on.

For the full story on the new Videodata LAN/1 network from Interactive Systems/3M, call 800-328-1684 toll free. (In Minnesota, 800-792-1072.) Or mail the coupon.

Mail to: Interactive Systems/3M  
P.O. Box 33050 D-3  
3M Center  
St. Paul, MN 55133

- Please send details on your new Videodata LAN/1 intelligent network.
- Please have a representative call.

Name \_\_\_\_\_  
Title \_\_\_\_\_  
Company \_\_\_\_\_  
Phone ( ) \_\_\_\_\_  
Address \_\_\_\_\_  
City \_\_\_\_\_  
State \_\_\_\_\_ ZIP \_\_\_\_\_

3M hears you...

**3M**



# The printing business is one of the largest in the U.S. and offers an enormous market.

complicated by the decision to print each line on three passes (in order to make economic use of such characters as the hyphen). The company did an extraordinary job, and I well remember spending the better part of a night at a service bureau in downtown Manhattan listening to and watching the counter as each frame clicked by. In the course of that operation, we generated more than 21,000 frames of fully styled text. It was not till several years later that the term "computer output microfilm"—now usually known as COM—was applied to the technique.

The microfilm was then run through a Xerox Copy Flow machine, and we soon delivered to the typesetters a "typescript" that, stacked up, made a pile about 10 feet high. One interesting sidelight to all of this concerns the hot metal (Monotype) system used in the typesetting: even using an expanded matrix of about 320 characters, the Monotype was not capable of setting all of the 500-odd individual characters required for the dictionary. Ordinarily, in order to determine which characters were to be put into the matrix and which omitted (for later insertion, by hand, into the galley trays), someone had to count large quantities of characters in the text to arrive at reasonably good statistics. In our case that was unnecessary, for in the process of formatting the basic tape for the Datatronix, we included a simple subroutine that counted the occurrence of every single character in each style of type. We then printed out the list, with the frequency of each character, and presented it to the compositor, who merely put into the Monotype matrix the 320 most commonly occurring characters.

Although the failure to set the *Random House Dictionary* automatically was a terrible disappointment to me, I must acknowledge the courage of those executives at Random House who supported my application of computers to all other phases of the preparation of that book—Jess Stein, Tony Wimpfheimer, Bennett Cerf, and Donald Klopfer, who is rumored to have commented after one of the many meetings in which I did my best to explain what was going on, "I don't know if Larry is a genius or crazy." By this time, I imagine he has long since come to the conclusion that I am neither.

By the date of the Fall Joint Computer Conference of 1968, I had worked out various techniques for keyboarding text into machine-readable form; at that meeting I approached numerous hardware manufacturers' booths to say that I would be interested in a device that would enable one to type matter on a keyboard, record it on mag tape (disks were not yet available), and simultaneously display it on a crt in front of the operator. Without exception, the engineers and others with whom I spoke offered to sell me bits and

pieces of their equipment (crt, microswitch keyboards, etc.) but unanimously refused to have anything to do with so harebrained an idea as building me a prototype themselves. "Do it yourself in your lab," they advised, turning away to talk with a more lively customer when I explained that I had no lab. History has had its way with what everyone now calls word processors (and other keyboarding media), though as far as I can recall, it was at least five years before they were offered commercially.

## MACHINE-READABLE FORMAT

In 1969, I resigned from Random House to set up shop for myself, first to do consulting alone, then to engage in the preparation of dictionaries. The first major dictionary we undertook, starting in 1970, was eventually published as the *Collins English Dictionary*, a "college-sized" dictionary prepared from scratch for a Scottish publisher. Although the editorial systems for that work differed little from those employed on the *Random House Unabridged*, there were, naturally, quite a few refinements. The major changes were in the keyboarding of the text into machine-readable form.

Against my better judgment, we were persuaded to use an OCR. As the device was not as sophisticated as those now available, we employed a battery of typists who transcribed all text onto specially formatted sheets using IBM Selectrics and a Perry font ball. The system worked in principle, but from a practical standpoint it was an utter failure: the OCR was capable of an accuracy factor of only 95%, thus allowing for far too many errors. Frankly, an accuracy factor of 99% is inadequate in my opinion, for that translates into one error in every hundred characters: on a dictionary page containing, say, 10,000 characters, 1,000 typographical errors would be intolerable.

After a long struggle, we gave up the OCR route, though the satisfaction I derived from saying "I told you so" was, at best, ironic and, at worst, costly in time and money. The solution was to design a system close to the kind I had envisioned back in 1968.

We were carrying on the Collins project at our offices in Aylesbury, England, about 40 miles from London. Ventek, the British counterpart of Datapoint, was situated in Acton, a suburb of London, and its equipment, I felt, could be best adapted to our needs. Accordingly, we acquired a number of Ventek keyboards with screens and set about the arduous task of transcribing manuscript onto hard disk. Since that procedure is so well known today as to be second nature to anyone connected to the computer business, there is no point in describing it here. In the

end, the Collins dictionary was set automatically and has proved to be an outstanding success.

In subsequent years, between our offices in Aylesbury and in Essex, Conn., we have compiled, edited, written, and otherwise produced more than 100 dictionaries, encyclopedias, and other reference works, virtually all of them using computers for editorial preparation as well as for typesetting. We have developed techniques for automated indexing of works not inherently in alphabetical order, for making certain that all words used in the definitions in a general dictionary are themselves entries in the book, for making "universal" style changes where required, for fitting a given quantity of text into a required number of pages, for creating permuted indexes automatically, and so forth. While preparing *Suffixes and Other Word-Final Elements of English* for Gale Research Company, we sorted all of the suffixes so that they are alphabetized from the right (for people who don't know, for example, that the suffix -ology is, properly, -ogy), then sorted them from the left for the index.

In America, we do the systems design and commission others to do the programming and processing; in England, we have the facilities in-house to do the programming and processing. In some instances, as during our compilation of *Mosby's Medical & Nursing Dictionary*, our compositor, Alexander Typesetting in Indianapolis, maintained the text file on a PDP-11/70 and supplied us with a DEC terminal to enable us, in Connecticut, to make editorial and style changes and corrections directly into the file.

## MICROS BY THE DOZEN

When portable microcomputers became available, we purchased a dozen of them and provided them to the freelance editors who work for us in the U.S., the U.K., and elsewhere. Rather than type copy on typewriters, which must be re-keyboarded to transcribe it into machine-readable form, these editors now keyboard directly onto floppy disks, which they send us instead of typescript. The text is printed out in our offices, where it is edited and proofread; then corrected printouts are returned to the editors so they can update and revise their diskettes. Ultimately, those diskettes are sent to Indianapolis, where they are transcribed onto a mag tape, which is formatted for driving a Harris (Fototronic) 7400; the resulting proofs are sent to us, in fully made-up page format, for final checking and proofreading.

Lamentably, those who designed the keyboards for the microcomputers used the standard typewriter (Qwerty) layout. That, in itself, presents no problems, but the lack of

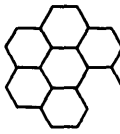

# Why Beehive's Latest Workstation Has The IBM World Buzzing.

## A Perfect Fit With 3270 Networks.

TOPPER™ is a programmable intelligent terminal with exceptional price/performance advantages over the IBM 3278 it emulates. On-line, TOPPER serves as a versatile telecommunications console and RJE station.

Here's a super networking tool, particularly when used with Beehive's CC76™ cluster controller. TOPPER fits into your network without any software changes including the capability to locally create, compile, and execute IBM mainframe compatible Level II COBOL applica-

tion programs. Extensive communications features also include asynch, bisynch, and SNA protocols.

## A Personal Automation System.

Off-line, TOPPER works like an advanced personal computer to boost your staff's productivity. User-defined function keys set up the system to suit the operator's special style.

TOPPER can run any CP/M™ based software and has two built-in floppy disk drives to handle programs and data. And with Beehive's unique, easy-to-use WSL™ (Work Station Language), information from the host can be used in local CP/M™ based processing.

## Built By the Terminal/System Architects.

TOPPER is a telecommunications console, a personal automation system, and a fine value. This exclusive productivity package is backed by a company that has specialized in terminals for 14 years, with satisfied customers in over 40 nations.

For details on our IBM TOPPER, contact: Beehive, 4910 Amelia Earhart Drive, Salt Lake City, Utah 84125. Toll Free Number: 1-800-453-9454.



**BEEHIVE**™.M.

### Sales Offices:

CALIFORNIA Costa Mesa 714/540-8404  
Sunnyvale 408/738-1560  
FLORIDA Altamonte Springs 305/788-9000  
ILLINOIS Arlington Heights 312/593-1565  
MASSACHUSETTS Woburn 617/933-0202  
MISSOURI Independence 816/356-4402  
NEW JERSEY Colonia 201/381-9883  
NORTH CAROLINA Greensboro 919/854-2694  
TEXAS Dallas 214/239-3330  
UTAH Salt Lake City 801/355-6000  
WASHINGTON, DC  
(VA) Falls Church 703/573-1261



CP/M is a trademark of Digital Research, Inc.

CIRCLE 111 ON READER CARD

# One stop shopping for VAX

No other supplier offers such a winning combination of products for VAX computers. Reliable? You bet! MTBF figures for our VAX products range from 40,000 to 85,250 hours. Add to that competitive pricing. And we're second to none in technical support, with third party service available as required.

For disk, tape and communications controllers, the Emulex lineup looks like this:

## Disk Products.

### FOR THE VAX UNIBUS...

SC12/V—Emulates DEC's RK711 controller combined with multiple RK07 drives on the VAX-11 Unibus.

SC21/V—Emulates DEC RM03 (80 MByte) and RM05 (300 MByte) storage subsystems. Includes Emulex VMS/VM software driver/diagnostic package.

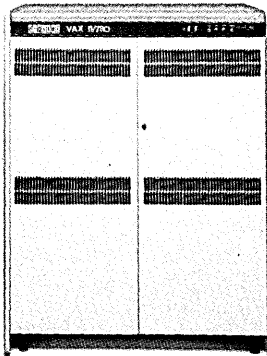

SC31—A low cost solution that allows you to install and operate large capacity disk drives on the Unibus of any VAX. Handles drives with high transfer rates of 1.8 MBytes per second in the 500 MByte range. Gives the same or greater storage capability than DEC Massbus installations at a fraction of the cost.

### FOR THE VAX-11/750...

SC750—This software-transparent, single-board controller allows you to add up to four large disk storage units (80 to 675 MBytes) directly to the internal CMI bus. The SC758 lets you add up to eight drives of storage off a single controller.

### FOR THE VAX-11/780...

V-Master/780—A mass storage adapter that houses one or two SC780 disk controllers, TC7000 tape controllers

or a combination thereof. Provides an interface and control through the Synchronous Bus Interface (SBI) of your VAX-11/780. Each SC780 disk controller supports up to four disk drives (80 to 675 MBytes). The SC788 is also available to fit in the V-Master/780 chassis and supports up to eight disk drives.

## Tape Products.

### FOR THE VAX UNIBUS...

TC11/V—Combines with any standard tape drive and the Emulex VMS/UT software driver/diagnostic package to emulate DEC's TM11/TU10 and provide reliable, economical tape storage on all VAX-11s.

TC12/V—Handles every industry-standard "Pertec" formatted half-inch tape transport, including conventional NRZ/PE start/stop and 1600/3200 bpi start/stop streaming tape drives. Provides software transparent emulation of DEC's TS11 subsystem on all VAX-11s.

DEC, VAX, Unibus, Massbus, RM03, RM05, RK711, RK07 and DMF-32 are trademarks of Digital Equipment Corporation.

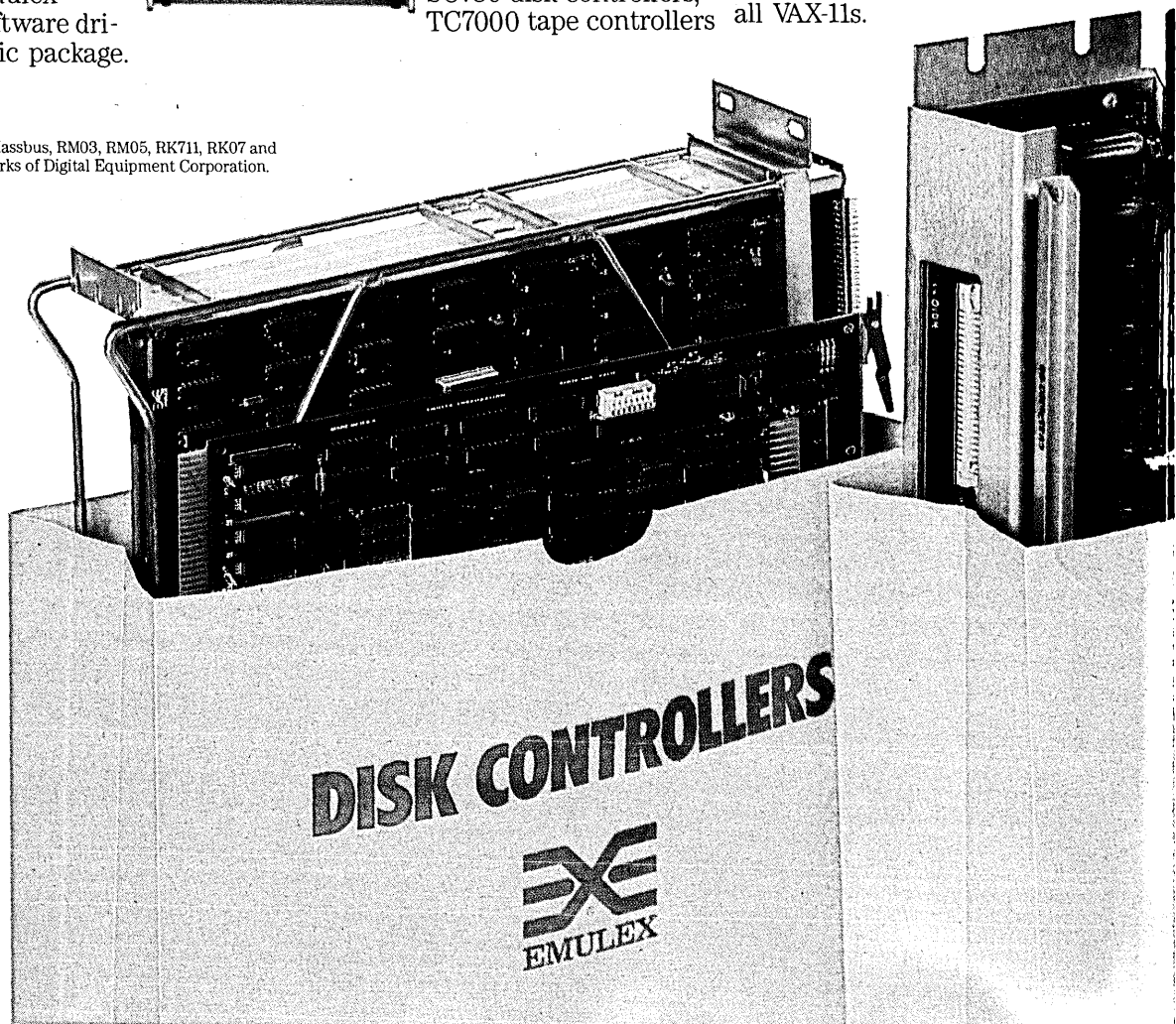

# Users? Emulex, of course!

FOR THE VAX-11/750...

TC7000—A single-board, software transparent controller that interfaces directly to the internal CMI to support 1-4 STC or 1-8 Pertec formatted type drives. Emulates DEC's TM03/TU77 with tape speeds up to 125 ips at 1600/6250 bpi. Supports both "old" and "new" GCR 6250 kinds of drives.

FOR THE VAX-11/780...

TC7000—The same board, with the flip of a switch, fits in the V-Master/780 chassis to provide transparent emulation of DEC's TM03/TU77 through the SBI. Supports 1-4 STC or 1-8 Pertec formatted type drives at tape speeds up to 125 ips; 1600/6250 bpi. Both "old" and "new" GCR 6250 technology is supported.

## Communications Products.

FOR UP TO 16 LINES—CS21 SERIES...

CS21/F—Emulates the asynchronous portion of the DMF-32 for use on VAX-11s. Is software transparent with VMS Version 3.0 and above. Handles 16 lines per controller.

Statcon 21—Statistical concentration through the combination of the proven CS21 multiplexer with special microprogramming and the CM22/EX local statistical port concentrator. Handles up to 16 remote lines per statistical concentrator, up to 32 lines per controller.

FOR 16 TO 128 LINES AND MORE—CS11/CS32 SERIES...

CS11/F—Emulates the asynchronous portion of the DMF-32 for use on VAX-11s. Is software and diagnostic transparent, and can handle 16, 32 or 48 lines per controller.

Statcon 11—Combines the proven CS11 multiplexer with special

microprogramming and one or more CM22/EX local statistical port concentrators.

CS32/F—A single-board communications controller that's totally software transparent to DEC's new DMF-32. One CS32 can handle up to 128 lines per controller board.

Statcon 32—Combines the CS32 multiplexer with special microprogramming and the CM22/EX local statistical port concentrator. A single CS32 controller board handles an amazing 256 remote and local lines in this statistical concentration mode.

For more information on Emulex products for VAX, call toll-free: (800) 854-7112. In California: (714) 662-5600. Or write Emulex Corporation, 3545 Harbor Blvd., P.O. Box 6725, Costa Mesa, CA 92626.



**The genuine alternative.**



CIRCLE 112 ON READER CARD

GSA Contract #: GS00K8401S5575

## For our applications, the most significant advances are being made in developing versatile DBMSs.

specially programmable keys required us to create certain codes to distinguish between open and close and single and double quotation marks, for example, as well as other tricks to take care of the differences between typewriter mode and typographic mode. Moreover, the "documentation" provided with the microcomputers is generally execrable. We therefore produced our own documentation, coupled with very simple instructions to enable editors to do the complete typographic styling of their output—italics, small capitals, boldface, etc., as well as the creation of any special characters or diacritical marks that might be required.

This procedure has worked well and has proved very economical. In our calculations, the basic cost of, say, an Osborne 1 micro is paid for after about 600,000 keystrokes have been keyboarded; for our books, which contain a large number of font codes, that is equivalent to fewer than 80,000 words. Other advantages are seen in the smaller number of errors cropping up in the initial keyboarding and in the time saved between the creation of the work and its ultimate publication. This latter factor is an important consideration to a publisher, for he may have a considerable amount of money tied up in a project, and reducing by as much as six months or a year the interval between the completion of editorial work and the day the book is out in the marketplace, earning back its investment, is nothing less than money in the bank.

Today, efforts seem to be concentrat-

ed on OCR. As far as I am concerned, that process at present carries little promise for original works, for the text must (at least) be typed. As for its application to text that is either typewritten or set in type, OCR would be a great boon were it virtually error-free—down to one error in 10,000 characters—and less expensive and faster. From my experience, those who extol the advantages of OCR are usually not speaking from direct involvement but from second-hand information, often from those who have a vested interest in its promotion.

For our applications, the most significant advances are being made in the development of versatile database management systems and of increased storage capacity for micros and minis, both at reasonable cost.

It is a pity that those who design the hardware continue to do so in a speculative vacuum, making assumptions based on ignorance rather than on genuine, sensitive market surveys. The printing business is one of the largest in the U.S. and offers an enormous market to those wise enough to cater to its needs. In principle, the innards of a computer can be readily adapted to accommodate the requirements of compositors, and it is shameful not only that most of the general purpose devices now available reflect no recognition of the needs of such a large segment of the market but that they seem to have been designed so that one might almost believe that access to them is deliberately being obstructed. The situation is becoming easier, compared with what it was a quarter century ago,

but there is much room for improvement.

It seems obligatory to a writer of this sort of harangue to offer some suggestions and predictions for the future. I am aware of—though, I hasten to add, not au courant with—the fifth generation computer plans under way in Japan. In the most general way, I have always felt that the main shortcoming of computers has been their inability to perform qualitative evaluation of the data they process so rapidly and efficiently. True, they do a reasonably good job of *simulating* evaluation of data, giving rise, among the naive, to the term "thinking machine." Yet they remain, at bottom, idiot devices.

### TOWARD A "THINKING MACHINE"

In the early 1960s, it occurred to me that a computer with digital storage and output but also with analog processing capabilities might provide a solution—or, at least, put us on the road to one. Aside from a brief flurry of activity in the late 1960s and early 1970s, these so-called hybrid computers seem to have been abandoned, presumably either because they failed to fulfill their promise or, more likely, because they are extremely difficult to program and operate.

I once had a plan to experiment with a simple cube structure consisting of 27 cells, with a meter between each pair of contiguous cells. Such a structure could readily be expanded by connecting each node to all of the other nodes, creating a network of some complexity. The information introduced to such a system at any given node would be measured analogically (as, say, voltage or amperage) and could be recorded and compared. There would be no problem about the uniformity of accuracy of metering devices, wire resistances, etc., since each system would be unique and self-adjusting; thus, each set of nodes would at finer levels of sensitivity be highly individualistic but at grosser levels would prove more or less uniform.

Alas, I have (still) no laboratory, and the device was never constructed. Nonetheless, I hold onto my—perhaps naive—conviction that therein lie some of the answers that all of us have to qualitative evaluation of data. It is an approach that is somewhat more sophisticated than that proposed by the Japanese, with their logical inferences, but we may in the future (in the sixth generation?) see a wedding of the two, if only to narrow and temper the choices of inferences. #

Laurence Urdang is president of Laurence Urdang Inc., an Essex, Conn., and Aylesbury, U.K.-based firm engaged in the research, compilation, and preparation of reference books, and a variety of consulting tasks.

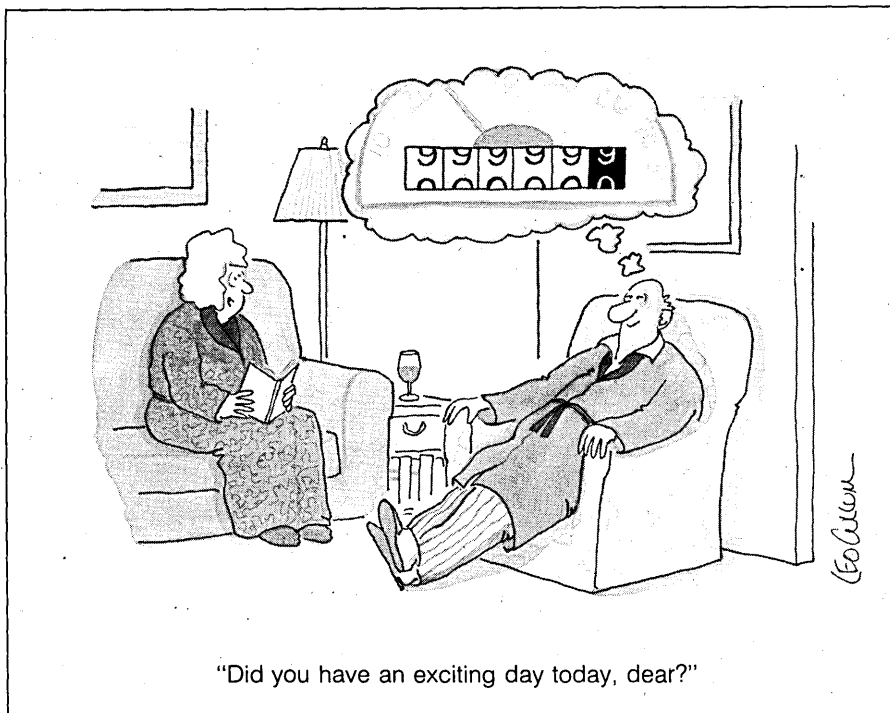



**NEW from  
THE MODEM LEADER**

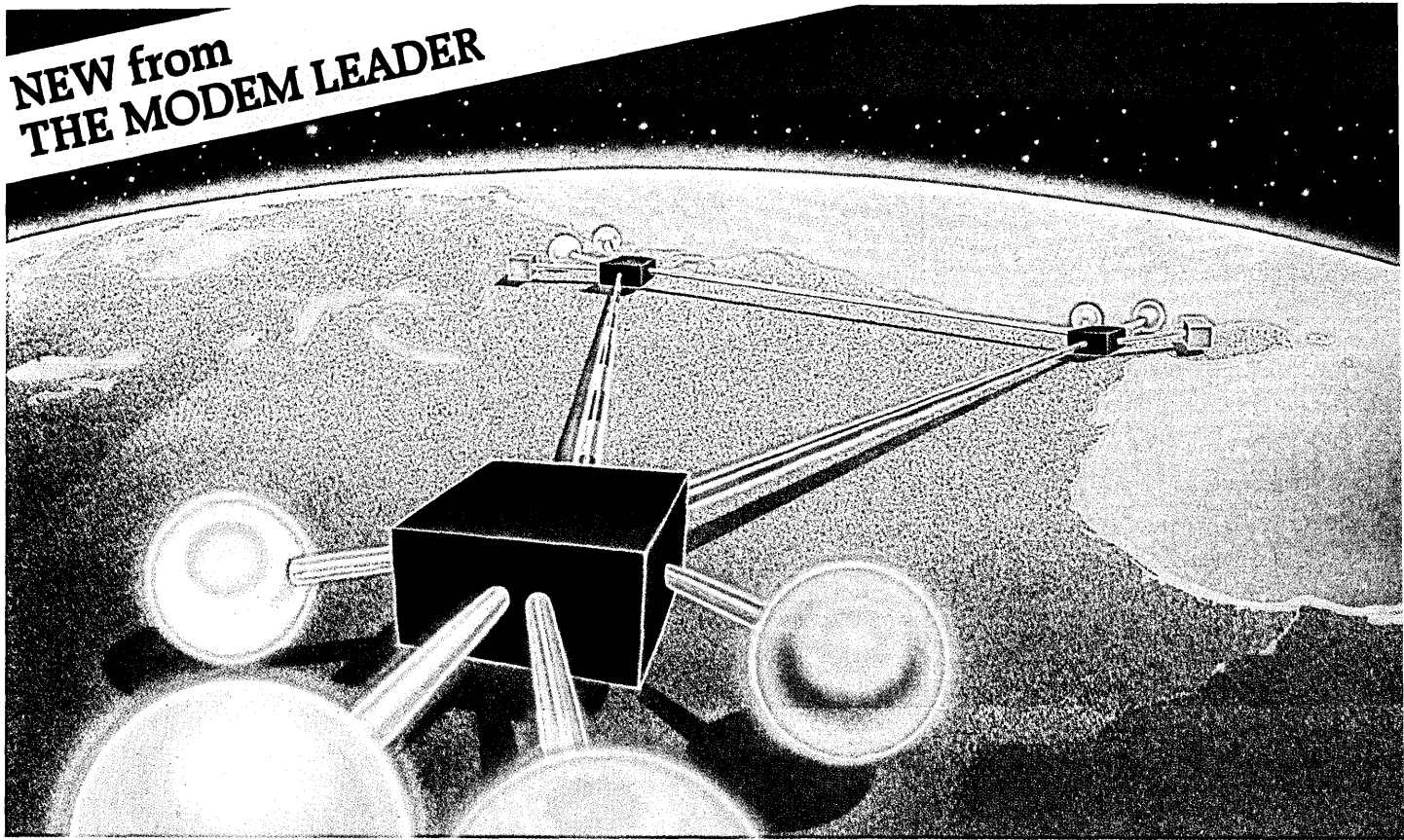

## Statistical Multiplexers From Paradyne

**Paradyne's series of Intelligent Networking Multiplexers is now a family of network solutions.** With User Switching and Auto Rerouting, hundreds, even thousands of your employees and customers can depend on your network.

**User Switching For Efficient Communications.** To be productive you need computer resources. User Switching provides a way for users to tap into the variety of your company's resources, regardless of where those computer resources are in the network. Paradyne's DCX multiplexers find the most efficient communications path to each computer.

**Auto Rerouting Means Increased Productivity.** Auto rerouting maintains the connection to the computer and insures user productivity in the face of degraded telco lines. When a link fails, DCX automatically looks for alternate routes in the network to reroute communications traffic, insuring continued productivity.

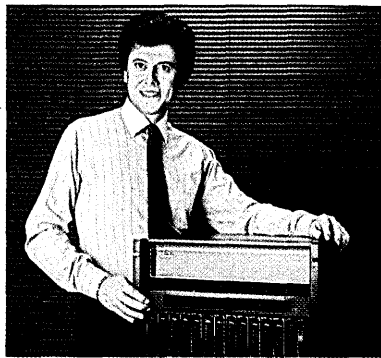

**Advanced Networking Diagnostics.** Paradyne offers the most advanced networking diagnostics in today's market. Both data and controls can be viewed to and from any channel in the network. Problems at a remote site can be isolated and diagnosed through DCX, quickly and easily.

**Productivity and Efficiency.** Another Paradyne systems solution. If you would like to know more about Paradyne's Series of Intelligent Networking Multiplexers call **1-800-482-3333**. We'll answer your questions and give you the location of the Paradyne sales office nearest you.

**DCX 815...**four or eight channels.  
**DCX 825...**four to 32 channels.  
**DCX 840...**240 channel data networking exchange. **DCX 850...**240 channel intelligent networking processor. **DCX 861...**four or eight channel statistical multiplexer with an integrated 9,600 bps modem. **DCX 871...**four to 32 channels with integrated 9,600 bps modem. And Paradyne's **NEW T1 Multiplexer...**combining the channel capacity of T1 facilities with the versatility and networking capabilities of the DCX product line.

*Meeting the  
Challenge of  
the 80's*

**paradyne**

Paradyne Corporation P.O. Box 1347  
8550 Ulmerton Road, Largo, FL 33540

CIRCLE 113 ON READER CARD

**Can your terminal  
talk with 3 different hosts  
and is it compatible with  
IBM, DEC, and Sperry?  
Alfaskop can. And is.**

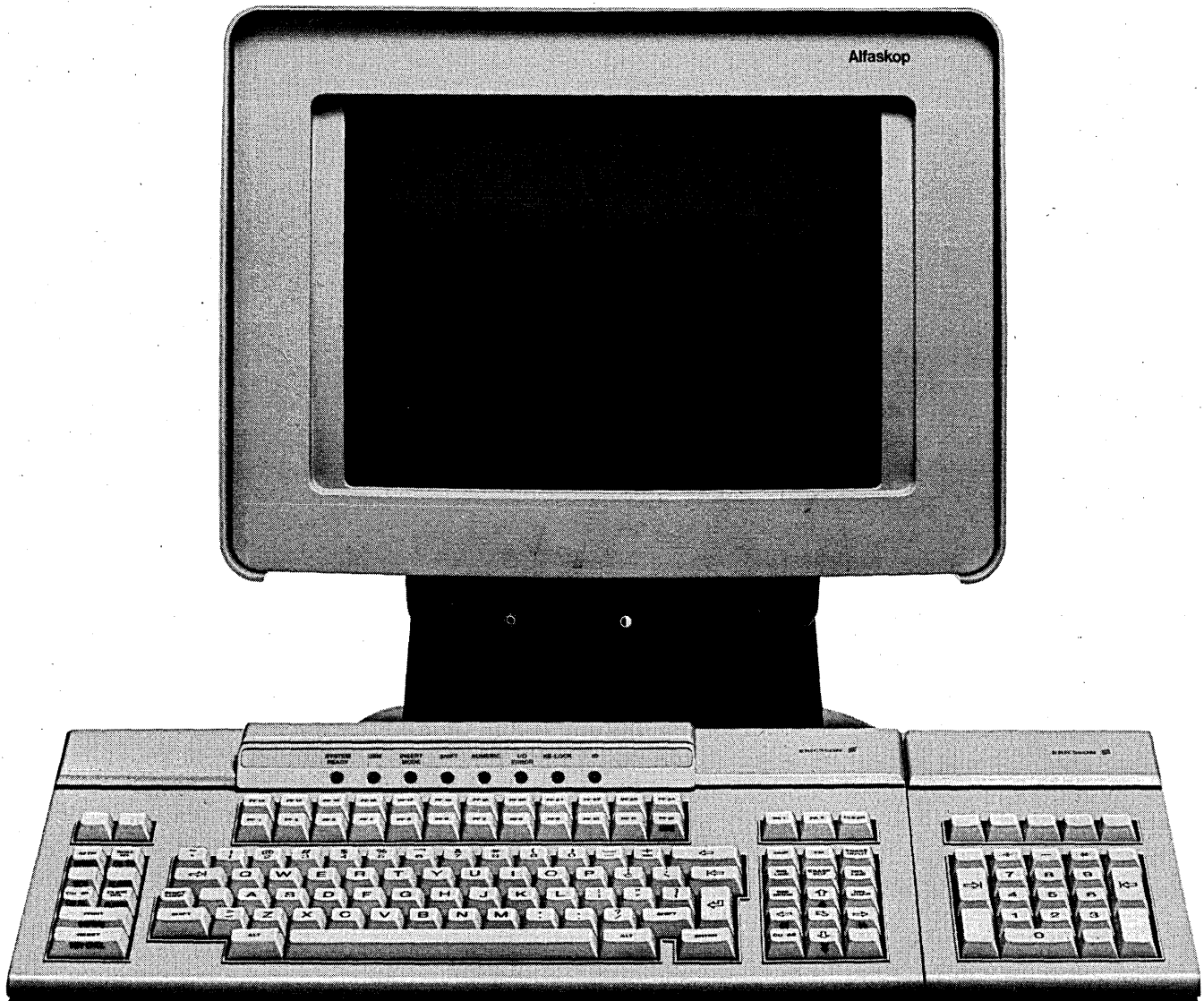

**ERICSSON** 

**Alfaskop.**  
**A simple solution to**  
**some costly problems.**  
**Call 1-800-331-1100**  
**and ask for operator 183,**  
**or mail the coupon.**

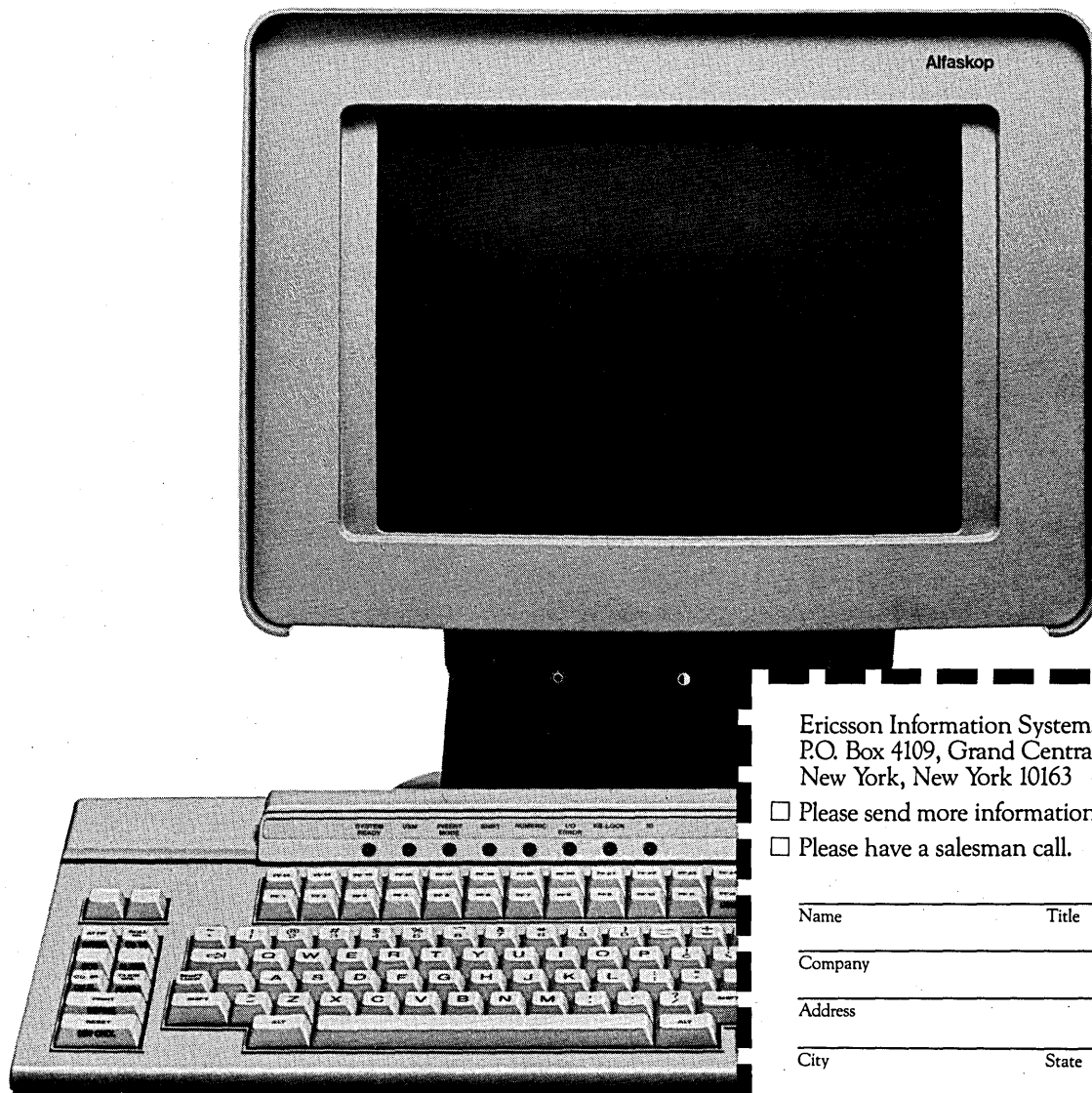

Ericsson Information Systems (Ericsson Alfaskop)  
P.O. Box 4109, Grand Central Station  
New York, New York 10163

- Please send more information on Alfaskop.
- Please have a salesman call.

Name \_\_\_\_\_ Title \_\_\_\_\_

Company \_\_\_\_\_

Address \_\_\_\_\_

City \_\_\_\_\_ State \_\_\_\_\_ Zip \_\_\_\_\_

Telephone 183 \_\_\_\_\_

**ERICSSON**



Three thousand users react to the pluses and minuses of 82 packages.

by Data Decisions

Is it easier to produce a good software product than to support one? Probably not, but for some reason applications software vendors are doing a better job providing users with the packages they need than with the backup they want, according to 3,376 users responding to a survey asking them to rate 82 mainframe and minicomputer software packages from 45 vendors. Although 73% of the users gave the packages an overall satisfaction rating of 6 or higher, on an ascending scale of 1 to 10, only 60% gave their vendors' service efforts equally high marks.

# APPLICATIONS SOFTWARE SURVEY



Why is this? The difference probably stems from two basic facts of computer software life: not every bug can be found, let alone fixed, before the package is first released, and, understanding how to use a package and conveying this information to others are two different things.

These factors are of special importance for this study, since applications packages are frequently used by nontechnical end users who may need more support than dp professionals. Indeed, a full 51% of those returning the questionnaires were end users, and most of this group did not depend on the dp department for access to the system.

The survey probed user impressions on package performance, vendor support, and value. To determine the dp environment, users identified the hardware and length of time the software package had been operating and provided a detailed profile of how they decided which packages to buy (see Methodology, p. 206).

For the sake of convenience, the 82 packages were divided into seven broad group headings: 21 general accounting packages, nine payroll packages, 15 general business packages, 20 banking and financial packages, four insurance packages, seven manufacturing packages, and six project

management packages. Deciding where a particular software product belonged was of necessity somewhat arbitrary; indeed, the general business category is a catchall for a variety of forecasting models, graphics packages; and other types of decision support applications. The main function of the group averages included in the report is to show how one type of product compares to another—it would not necessarily be valid to make direct product-to-product comparisons.

The specific ratings show users indicated that the average applications software package performed okay, but not spectacularly. On a scale of 1 to 10, with the highest



PHOTOGRAPHS BY STEVE COOPER



# Whether you're buying a car, a tomato, or a sofa, a customer always wants the best value.

number for a perfect performance, the average package scored a 6.6. Users rated performance from several viewpoints: efficiency of hardware utilization, level of program errors, and the amount of time for initial installation. (A graphic representation of the ratings of 80 packages follow—two were deleted because of space limitations.)

Of the seven package categories, general business programs commanded the highest performance ratings, averaging 6.7, followed by general accounting packages, with a 6.4. The more complex types of applications programs, such as manufacturing packages, project management, and payroll/personnel, had lower average scores. Indeed, the payroll/personnel group scored a significant one point below the norm, or 5.7.

## LOWER SUPPORT RATINGS

Since few if any users have consistently good things to say about the vendor support of software, perhaps it comes as no surprise that vendor support ratings were lower than the ratings for the packages themselves. Support ratings are a composite of user votes on three categories: responsiveness, training, documentation.

General accounting packages scored the highest level of any in terms of vendor support, 6.3, probably because these programs are older and more likely to have perfected training and documentation. Interestingly, two fields that have long experience with applications software, banking and insurance, indicated many problems with vendor support—the rating was 5.8 for each. General business programs received a 6.2 rating for support, and project management packages tallied a 6.1.

Little discernible difference in operational characteristics were noted by the users. Asked to rate the ability of programs to handle expanded processing volumes, recovery/backup capabilities, and security provisions, users gave the group a 6.4 score, with a narrow range depending on type of application—6.7 for general accounting packages to 6.2 for banking, general business, and manufacturing.

Ever wonder if other applications software packages had easier data entry? The bad news may be that few users think their packages are ideal. The average input/output rating—indicating level of satisfaction with data entry, output procedures, and ease of format change—was 6.1, with a narrow range from the established general accounting programs at 6.3 to the 5.7 for payroll.

Whether he is buying a car, a tomato, or a sofa, a customer always wants to get the best value for his dollar. Respondents rating their applications software indicated that their packages were a good value in most

cases; about a third considered them an excellent value, and only 4% of them a poor value. Value, in this survey as well as in real life, was defined as features and capabilities relative to cost.

An excellent value has two meanings, of course: most of the "excellent" ratings went to products with outstanding features at a price comparable to or lower than the competition, while about a third of the excellent ratings were voted because the packages provided good features and capabilities at a price substantially lower than the competition. In rating products considered good values, 40% of the users felt that if the product had good features at a price comparable to competitive packages, it was good.

A product that had outstanding features but was higher priced was rated good by 13% of the users. A few users, 4%, considered a product good if it didn't have many features but was cheap.

No one should ever accuse software salesmen of the tactics closely associated with used-car salesmen. Nine out of 10 users said that the package did what the vendor said it could, and eight out of 10 said their packages met or exceeded vendor promises regarding speed, performance, and efficiency. Overall, two thirds of the users said that the package met the vendor's promises.

The older and less complex applications more frequently met or exceeded vendor claims. Three quarters of the general business programs delivered what the salesmen said they would, but insurance packages and payroll and project management packages in general were only a 50-50 gamble. Two thirds of the banking package users felt that the packages and vendors delivered, along with 61% of the users of the manufacturing packages and 72% of the users of general accounting packages.

Users were also asked which of four types of vendor support services they used and how they rated those services on a 10 point scale. The services investigated were on-site, telephone hot line, on-line, and mail. Nearly nine out of 10 users (88%) reported using the vendor's telephone hot line support service; 62% used their vendor's on-site support and mail support service; and almost two in 10 used an on-line support service.

## SUPPORT SERVICE RATINGS

Support services ratings are reported only for packages that met a minimum reporting standard of 10 respondents. The average score for the 73 packages that met the standard for on-site support services was 6.6. These scores show little variation from group to group.

The average score for the 81 packages with telephone hot line support services was

6.2, with average scores ranging from a low of 5.8 for the payroll/personnel group to a high of 6.5 for the manufacturing, project/industrial management, and business/office administration groups.

The average score for the 17 packages that met the standard for on-line support services was 6.0. The average scores for packages in the seven groups range from a low of 5.5 for the business/office administration group to a high of 6.6 for the insurance group. Too few packages met the reporting standard to permit group averages to be calculated for the payroll/personnel, project/industrial management, and banking/financial groups.

The average score for the 72 packages that met the standard for mail support services was 5.7. The average scores for packages in the seven groups ranged from a low of 5.5 for the banking/financial and insurance groups to a high of 6.1 for the business/office administration group.

Users were asked to provide an overall rating for services based on the quality, speed, and usefulness of the vendor's response to product enhancement requests and the accessibility of support facilities; to the quality and currency of user documentation updates; and on the availability and quality of training.

The average package studied received an overall vendor/vendor-supplied services rating of superior from 11% of its users, a very good rating from 48%, an acceptable rating from 33%, and an inadequate rating from 6%. On the 10 point scale, the mean score was 6. Of the seven package groups, the average general accounting package received the highest overall vendor/vendor-supplied services score, 6.2, and the lowest score, 5.8; was shared by the average insurance and project/industrial management package.

Only 14% of the users of the average package report that they have evaluated alternative packages since their package was acquired. Of this group, 3% evaluated alternative packages offered by their computer vendor, and 11% evaluated alternatives from independent vendors.

Of the seven groups, users of the average business/office administration package were most likely to have evaluated alternative packages (24%), and users of the average general accounting package were least likely to have done so (only 7%).

Between these poles were insurance packages (21%), project/industrial management packages (17%), manufacturing packages (14%), payroll/personnel packages (13%), and banking/financial packages (11%).

Only one in seven users (14%) of the typical applications package reported that they

# 10,000 CICS Users Said There Had To Be A Better Way...

## We Gave Them **GENER/OL™**

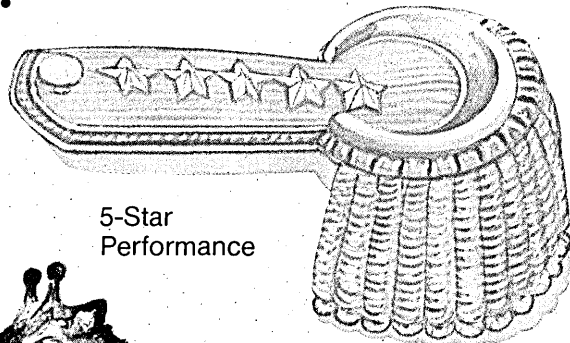

5-Star Performance

Greater Productivity

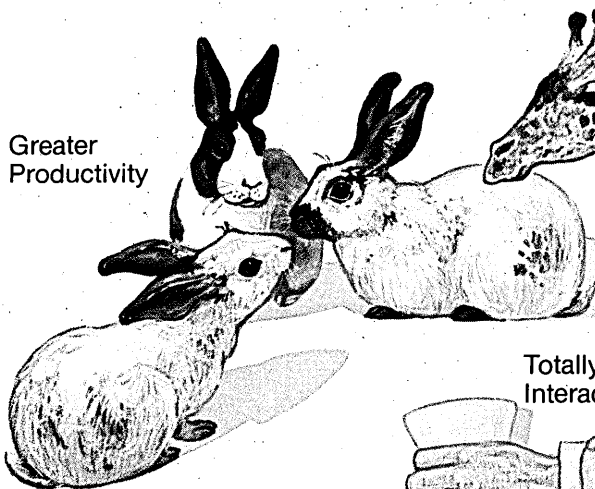

Totally Interactive

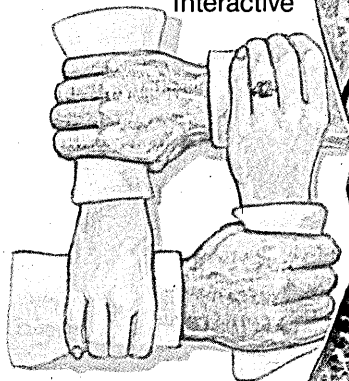

Completely On-Line

Resource Efficient

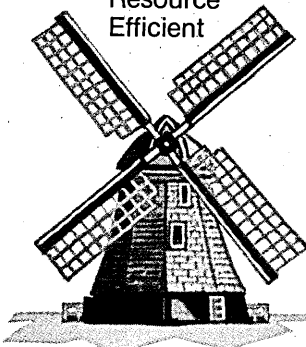

Feature for unique feature, GENER/OL is the leader in on-line CICS applications development. This 5-star performer channels on-line technology for maximum productivity, efficiency, and flexibility.

Complete with award-winning documentation and responsive support, GENER/OL offers uncommon software productivity in the Pansophic tradition.

Call us today for the performance of a lifetime!

No Other Product On The Market Compares

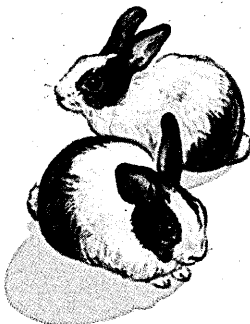

# PANSOPHIC®

(800) 323-7335

Pansophic Systems, Inc., 709 Enterprise Drive, Oak Brook, Illinois 60521. In Illinois, call (312) 986-6000.

CIRCLE 115 ON READER CARD

# HAVE YOU BEEN BLIND COMPUTER WITH THI

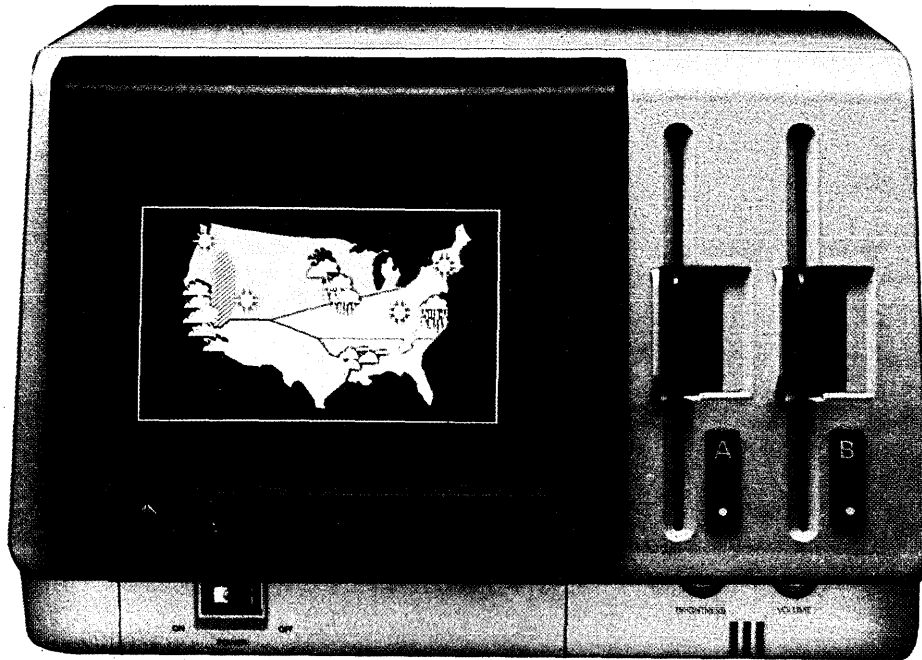

NEC's Advanced Personal Computer offers the sharpest color graphics of any personal computer.

Graphics are being used more and more by businesses every day. They give companies a clearer picture of their place in the market. They make for more effective presentations. And with slides and color trans-

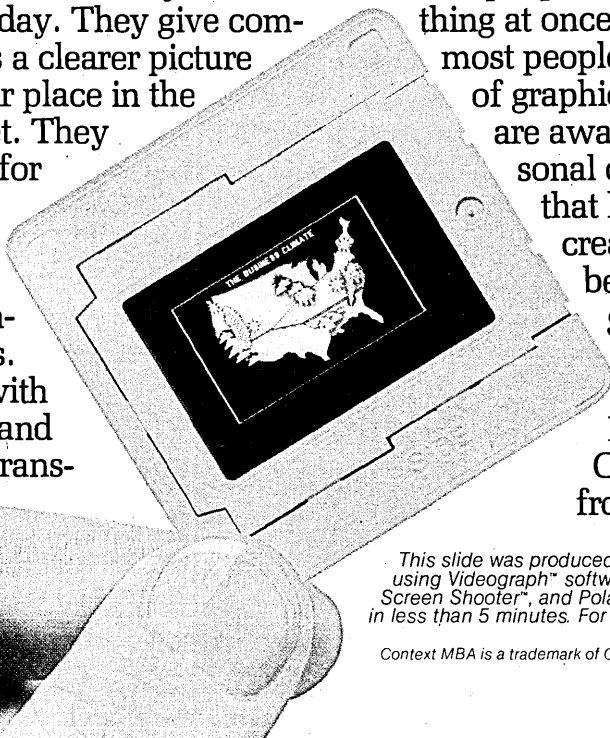

parencies, they can let a room full of people see the same thing at once. Although most people see the value of graphics, very few are aware of the personal computer that lets them create the best color graphics. It's the Advanced Personal Computer from NEC.

*This slide was produced from the screen using Videograph™ software, an inexpensive Screen Shooter™, and Polachrome™ 35mm film, in less than 5 minutes. For less than \$1.00!*

**NEC's Advanced Personal Computer offers the widest range of quality graphics.**

One reason the APC is better is that it lets you do more kinds of graphics than any other personal computer.

In fact, it gives you the kind of graphics you'd expect only from a much more expensive computer.

With the APC, you can produce color transparencies, color slides, or output to a variety of printers and plotter.

You can even do Compute Aided Design (CAD).

**Our screen is graphically better.**

Seeing is believing. And one look at our color screen will prove it's the best.

But it's no accident. It starts with the NEC 7220 graphics processor, the most advanced graphic chip available.

Then, unlike other PC's, the

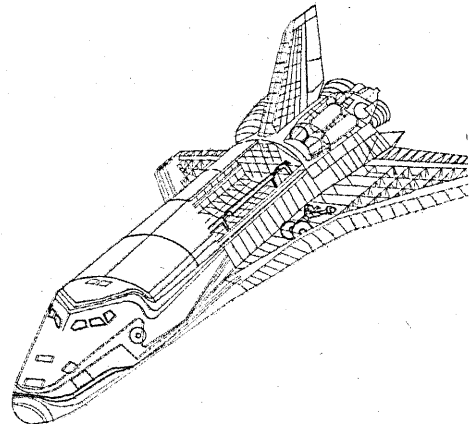

# TO THE PERSONAL BEST COLOR GRAPHICS?

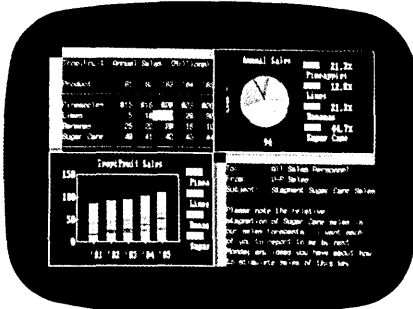
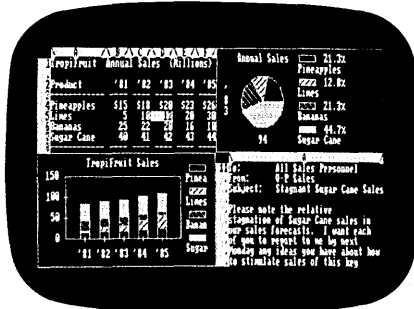

Context MBA™ runs in high resolution color on the APC. But it can only run in one color on the color monitor of the leading brand.

APC graphics option has its own dedicated memory, so there's never a tradeoff between color and resolution.

## Software will make you a big-time producer.

Better hardware alone isn't enough. You also need better software. And NEC provides that, too.

Take Graphplan™ for example. Graphplan can take spreadsheet format data and produce customized business graphics on paper. Instantly.

Graphwriter™ will let you produce professional color graphics in

over 20 different formats. Then turn them into transparencies or hard copies using the most popular pen plotters.

Videograph™ makes creating free-form color images for slide presentations easy and inexpensive.

Autocad™ lets architects, engineers and designers create sophisticated graphics and designs, then produce precise drawings with popular plotters.

This software combined with the APC hardware will give you the best graphics you can get on any personal computer.

## For the complete picture, call NEC.

For product literature on any of NEC's APC graphics capabilities, call 1-800-343-4419.



Designers can use Autocad™ to make the design process faster and easier.

In Massachusetts, call 1-617-264-8635.

And find out why more and more graphics users with vision are saying "NEC and me

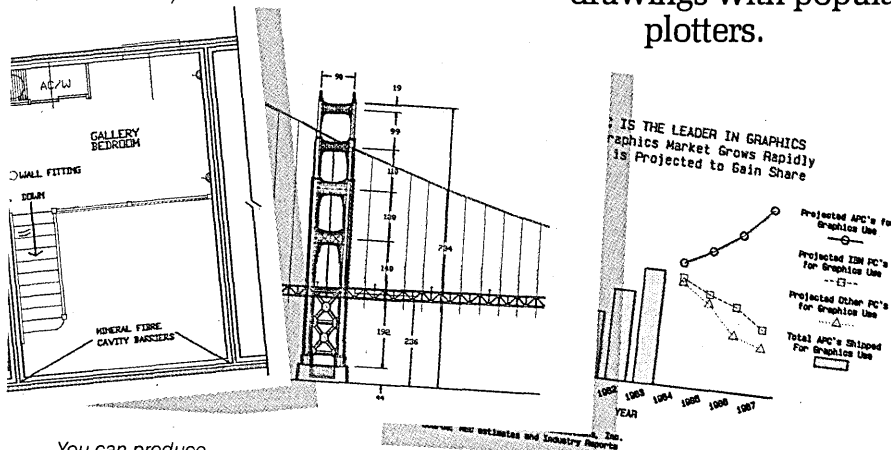

You can produce printed outputs like these with the APC.

# NEC AND ME

NEC Information Systems, Inc.  
1414 Mass. Ave.  
Boxborough, MA 01719



Screen Shooter is a trademark of NPC. Polachrome is a trademark of Polaroid. Videograph is a trademark of Xiphias. Autocad is a trademark of Auto Desk, Inc.

# No one should ever accuse software salesmen of used-car dealer tactics.

are actively considering replacing it. There are relatively small differences among the package groups, which range from 20% for project/industrial management packages to 9% for payroll/personnel packages.

Users who were thinking of replacing their packages were most likely doing so because they needed features that were not available in their current package (34%) or because they were upgrading or changing to an incompatible system (21%). Twelve percent of those thinking of replacing their packages were doing so because of slow execution speed, and 11% claimed that the upgrade/expansion capabilities offered for the current package were too expensive. A final 11% claimed their packages were just generally unsatisfactory.

To clarify how they made their purchasing decisions in the first place, users were asked to evaluate the influence of eight factors on their acquisition decisions. Specific features and capabilities emerged as the primary influence. Eighty-one percent of the users of the average packages studied—including at least 76% of the users in each of the seven package groups—said this factor had a major influence.

Productivity/ease of use ran a distant second (54%). Overall vendor presence or reputation in the industry, compatibility with existing software, and cost and/or time required to implement the package internally were each cited as major factors by more than three out of 10 users.

In contrast, uniqueness of the application was considered a major influence by only 26%, experience with other packages from the same vendor was a major influence for only 18%, and a consultant or third-party recommendation was considered a major influence by only 14%.

## OTHER PACKAGES EVALUATED

About three quarters of the respondents said that alternative packages were evaluated before they decided to acquire their package. Twenty percent evaluated an average of 1.5 alternatives available from their computer vendor, and 66% evaluated an average of 3.7 alternatives offered by independent vendors.

Among the seven groups, users of the average manufacturing package most likely evaluated an alternative package (86% did so), both from independent vendors (86%) and from their computer vendor (48%). Although users of the average business/office administration package are least likely to have evaluated alternative packages, the majority (63%) still did so.

As for the operating environment, the average package included in the survey had been installed for 37 months, with the banking/financial group package installed for the longest time, 45 months, and the manufacturing

group for the shortest, 28 months.

Sixty-one percent of the surveyed users indicated that to the best of their knowledge, they were using their package's latest version or release; one third indicated that a more current version had been released but was not being used; and 7% did not know which release they were using.

Package currency among the seven groups varied widely from a low of 47% for the average manufacturing package to a high of 72% for the average project/industrial management package. The latest versions were being used for 67% of the payroll/personnel packages, 64% of the insurance packages, 63% of the general business packages, 60% of the banking/financial packages, and 58% of the general accounting packages.

Two thirds of the packages studied run primarily on IBM computers. Only 6% run on the second most popular host, Digital Equipment. Following those two are Hewlett-Packard, 4%; Burroughs, 3%; and Wang, Amdahl, Honeywell, and Sperry, each with 2% of the packages. Texas Instruments, Intel, Data General, and Magnuson each host 1%, and computers from other unspecified vendors host the remaining 10%.

A breakdown of host vs. package-type figures shows that 70% to 80% of the general accounting, banking/financial, project/industrial management, and payroll/personnel groups run on IBM hosts. Conversely, only 50% of the general business packages, 44% of the insurance packages, and 31% of the manufacturing packages do so. In the manufacturing category, 33% run on Hewlett-Packard, 17% run on DEC, and 7% run on Data General systems.

The following bar charts summarize users' overall ratings of the 82 packages included in this survey. With each chart is the number of user responses, the percentage of users who judged their package and vendor support outstanding (giving overall ratings of 9 or 10 in each category), the percentage of users seeking to replace the package, and the percentage of this group citing unsatisfactory performance as the reason.

Despite the scope of this year's survey, like any survey it concentrates on a limited universe. Many excellent products were excluded because of our statistical criteria. Unfortunately, no survey can set absolute standards for evaluating a software package that would be relevant to a particular installation and end user. But it can give a starting point for discussions among dp managers, software suppliers, and the end users.

## Ratings Summaries

**GENERAL ACCOUNTING PACKAGES—**  
21 packages studied.

7.9—Disk Account Reconciliation

- 7.7—Timberline Systems MAC
- 7.5—Insight Software INSIGHT
- 7.4—Data Design Fixed Asset Accounting
- 7.3—Data Design Accounts Payable/Purchasing Control
- 7.2—Westinghouse IAI Financial Accounting; MSA General Ledger
- 7.0—MSA Fixed Assets
- 6.9—UCC Fortex CARMS; MSA Accounts Receivable; MSA Accounts Payable; ISA Accounting and Budget System
- 6.8—**Group Average**; McCormack & Dodge General Ledger Plus
- 6.6—ISA Cash Disbursement System
- 6.5—McCormack & Dodge Fixed Assets Plus
- 6.3—McCormack & Dodge Accounts Payable Plus; UCC Financial Control System
- 6.2—Software International Accounts Receivable; ISA Accounts Payable
- 6.1—Software International Accounts Payable
- 5.3—ISA General Ledger

**PAYROLL/PERSONNEL PACKAGES—**  
9 packages studied.

- 7.4—Integral Systems Payroll/Personnel
- 7.3—MSA Payroll Accounting System
- 7.1—MSA Personnel Management & Reporting System
- 7.0—MSA Human Resources System
- 6.4—**Group Average**
- 5.8—Cyborg Systems Payroll/Personnel
- 5.7—Westinghouse Payroll/Personnel
- 5.3—McCormack & Dodge Human Resources Plus; Information Sciences Human Resources System

**GENERAL BUSINESS PACKAGES—**  
15 packages studied.

- 8.0—MSA ALLTAX
- 7.8—Execucom IFPS
- 7.4—SPSS Batch System; List Processing Carrier Route Coding
- 7.3—Computer Associates CA-Autotab; ISSCO Tel-A-Graf
- 7.1—Aim Plus Aims Plus; ADR Empire
- 7.0—ISSCO Disspla; ISA Foresight
- 6.9—**Group Average**; ADR ETC
- 6.8—American Software Sales Forecasting
- 6.6—Xerox Business Management System
- 5.6—Interactive Management Financial Management System
- 5.5—MSA Forecasting and Modeling System

**BANKING & FINANCIAL PACKAGES—**  
20 packages studied.

- 7.8—UCC Super MICR
- 7.7—Bob White On-line Banking System
- 7.5—Stockholder Systems PEP
- 7.3—Weiland Software Demand/Deposit Credit Reserve
- 7.2—Stockholder Systems Corporate Shareholder System



# Perk up your Perkin-Elmer 3200 with DATARAM MEMORY

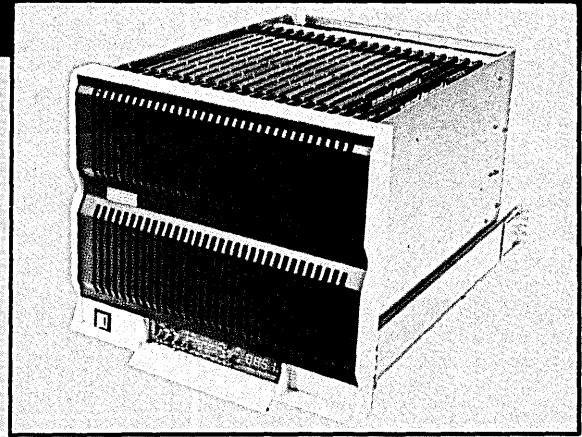
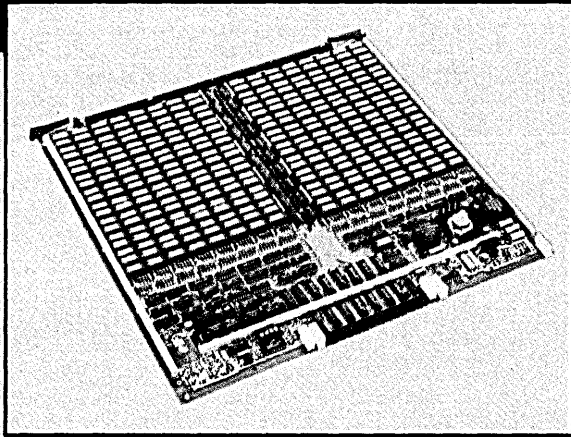

**From Dataram Corporation, the leader in Perkin-Elmer compatible memory, a wide range of memory products for your Perkin-Elmer 3200. 2.0 MB ADD-IN memory or 128 MB BULK SEMI peripheral storage. Only from Dataram. And available now!**

Dataram has shipped more ADD-IN memory than any other company in the world. Except Perkin-Elmer.

Our latest ADD-IN, the 2.0 MB Dataram DR-330 semiconductor ADD-IN memory, operates across the complete range of Perkin-Elmer 3200 Series — 3210, 3220, 3230, 3240 and 3250. Smaller capacities of 1.0 MB, 512 KB, and 256 KB are also available and all are compatible with Perkin-Elmer memory management and ECC. Sockets are standard and a spare on-board RAM is provided.

Best of all — we save you money. And at no sacrifice in quality. Every DR-330 is backed up by Dataram's standard one-year warranty.

Dataram's new BS-702, the industry's only high-performance BULK SEMI to interface to Perkin-Elmer's 3200 Series. With everything you need to get optimum performance from your 3200 system. Compact size — 32 MB in 15 $\frac{3}{4}$ ". The I/O driver required to support the BS-702. And the impressive capability to drive up to four 32 MB chassis...for a whopping capacity of 128 MB!

Solid-state speed enables the BULK SEMI to run at the full SELCH rate of 4.0 MB/sec. More than that, solid-state technology means high reliability, further enhanced by the BS-702's error correcting capability.

And when you talk about capability, you'll talk about the BS-702's unique dual-port operation that allows you to bring your image processing, array processing, or data acquisition input in on one port and off-load to your 3200 on the other.

## DATARAM

Dataram Corporation □ Princeton Road □ Cranbury, New Jersey 08512 □ (609) 799-0071 □ TWX: 510-685-2542

CIRCLE 117 ON READER CARD

- 7.1—Hogan Systems, The Umbrella System
- 6.9—Florida Software Direct Deposit Accounting
- 6.8—Remote Computing Savings and Loan System
- 6.7—UCC Customer Information System
- 6.6—**Group Average**; Florida Software Commercial Loan System
- 6.5—Florida Software Certificate of Deposit
- 6.4—Hogan Systems Integrated Deposits System; Citizens Automated Canton System/1990
- 6.3—Hogan Systems Prophet; Dyatron Pro-Trust
- 6.2—UCC Paperless Item Processing; Florida Software Mortgage Loan System
- 6.1—UCC Commercial Loan System
- 5.5—UCC Installment Loan System
- 4.9—Florida Software Financial Management System

**INSURANCE PACKAGES—**  
4 packages studied.

- 7.1—Logic Inc. Credit Life Administration
- 6.6—Insurennet Inc. Insurennet
- 6.5—**Group Average**
- 6.4—Pallm Inc. Pallm System
- 6.0—Informatics General Life-Comm

**MANUFACTURING PACKAGES—**  
7 packages studied.

- 7.3—Ask MANMAN
- 7.1—Comserv AMAPS
- 6.8—NCA Maxcim
- 6.7—Cincom MRPS
- 6.6—**Group Average**
- 6.5—MSA ARISTA Manufacturing System
- 5.8—Martin-Marietta MAS Manufacturing Control System
- 5.7—Automated Quill Mini-Miz/PAIS

**PROJECT & INDUSTRIAL MANAGEMENT PACKAGES—**  
6 packages studied.

- 7.3—Thomas Laguban Associates E-PICS
- 6.9—Boeing Executive/Information Services
- 6.8—AGS Management PAC Systems
- 6.3—**Group Average**
- 6.1—AGS Management SDM/70
- 5.4—AGS Management Project Control/70
- 5.4—MSA Inventory & Purchasing System

**REPORT AVAILABLE**

This survey is based on a forthcoming report in *Software*, a monthly updated information service available by subscription that covers systems and applications software for mainframes, minicomputers, and micros. Additional information is available from Data Decisions, 20 Brace Rd., Cherry Hill, NJ 08034. The telephone number is (609) 429-7100.

**AV. TOLERANCES FOR 68% CONFIDENCE LEVEL**

Sample Size	OVERALL SATISFACTION			SPECIFIC ATTRIBUTE RATINGS			
	6.0 or Under	7.0	8.0 or Higher	5.0 or Under			8.0 or Higher
<b>60 or more</b>	.20	.20	.15	.30	.30	.30	.25
<b>50-59</b>	.25	.25	.20	.30	.30	.30	.25
<b>40-49</b>	.30	.25	.25	.35	.30	.30	.25
<b>30-39</b>	.30	.30	.25	.35	.35	.30	.30
<b>15-29</b>	.40	.40	.35	.50	.50	.45	.40

As in all sample surveys, the numbers reported are estimates within a range of what would have been obtained if all user sites in the survey universe had been surveyed. The margins of sampling variation, or tolerances, for the ratings on overall satisfaction and specific attributes range from .2 to .5. This means that the chances are approximately two in three that a reported rating differs by no more than the indicated tolerance from the rating that would have been obtained if all eligible sites had been surveyed. For example, if a sample of 30 sites gives a software package an overall satisfaction rating of 7.0, the table indicates a tolerance of 0.30. Thus, the chances are two in three that the interval 6.70-7.30 includes the rating that would have been obtained had all eligible sites been surveyed.

**METHODOLOGY**

The objective of the survey, which was designed by Data Decisions and conducted by Beta Research Corp., Syosset, N.Y., was to collect data on the packages' operating environments and find out how respondents feel about the packages they use and the support they receive from vendors.

The universe for the survey consists of applications packages designated by International Computer Programs, Indianapolis, as having generated \$5 million or more in sales; 155 packages marketed by 92 companies were initially identified as having met this qualification.

On July 8, 1983, a registered letter was sent to each of these companies enlisting their cooperation. Each company was asked to supply a list of the 125 most recent customers who had had the package installed and running for at least six months as of July 1, 1983. For those packages with fewer than 125 qualified customers, the company was asked to supply its complete customer file. Companies were also asked to certify that the lists they submitted met these criteria and that they would make no effort to contact customers with regard to the survey. Respondents were also asked whether they were contacted by the vendor.

A minimum of two follow-up phone calls was made to each company in an effort to gain the maximum cooperation and to ensure that each had the opportunity to participate. About half, or 49 companies, responded, providing lists for 79 different applications packages, or 51% of the programs originally identified for inclusion in the sample.

Of the user lists submitted, five were for packages that were no longer marketed and one was for a package that also appeared on the ICP list under another name.

These packages were removed from the sample. Five more lists with fewer than 29 names, the minimum mailing sample, were also dropped. This left 68 packages with user lists provided by 39 companies.

To expand the number of ratable packages and increase the participation of leading packages as identified by the ICP list, Data Decisions obtained user lists from Computer Intelligence Corp., La Jolla, Calif., for 14 additional packages marketed by six companies. These additional lists brought the total survey universe to 82 packages from 45 companies.

**THE MAILING**

During the last week of September 1983, 6,265 questionnaires were sent to known users of the 82 packages. Questionnaires were addressed to the vendor's primary contact at each location; the contact was asked to give the questionnaire to someone who used the package if the contact was not personally a user. To encourage a prompt response, a \$1 incentive was included in the mailing. A second mailing in mid-October, without an incentive, was made to all nonrespondents.

A total of 3,323 questionnaires was returned; 95 were undeliverable by the postal service. To provide a minimum response rate of 40% and a minimum user base of 15 for each package, telephone interviews were conducted with nonrespondents. The questions asked in the telephone interviews were identical to those included in the mail survey. Fifty-three telephone interviews brought the total number of responses to 3,376, for an overall response rate of 55%. This figure includes 413 respondents who indicated that the package was not currently being used at the installation.

**Ratings Values**

10-9: Superior

8-6: Very Good

5-3: Acceptable

2-1: Inadequate

**Legend**

■ Specific Product Rating

□ Group Average Rating

**OVERALL SUMMARY**

**Average—All Packages • 82 packages**

**2,963 responses • 15% judged package and 11% judged vendor outstanding • 14% actively seeking to replace package, with 2% citing unsatisfactory performance as reason.**

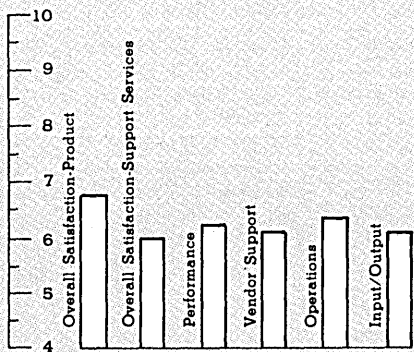

**GENERAL ACCOUNTING**

**ACCOUNTS PAYABLE—PURCHASING CONTROL • Data Design Associates, 1250 Oakmead Parkway, Suite 310, Sunnyvale, CA 94086 • 408-730-0100**

**51 responses • 24% judged package and 24% judged vendor outstanding • 12% actively seeking to replace package with 2% citing unsatisfactory performance as reason.**

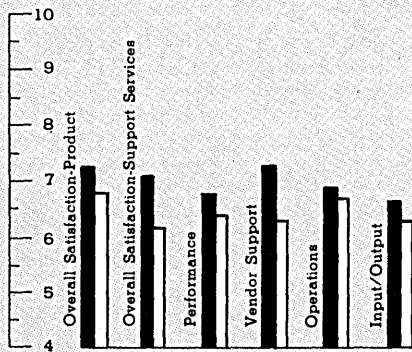

**FIXED ASSET ACCOUNTING • Data Design Associates, 1250 Oakmead Parkway, Suite 310, Sunnyvale, CA 94086 • 408-730-0100**

**53 responses • 36% judged package and 21% judged vendor outstanding • 2% actively seeking to replace package, with 2% citing unsatisfactory performance as reason.**

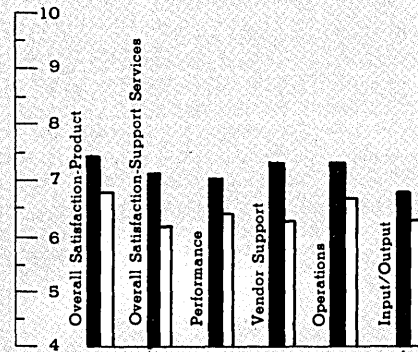

**ACCOUNT RECONCILIATION • Disc, Inc., 3837 Maylors Lane, Baltimore, MD 21208 • 301-486-0410**

**56 responses • 38% judged package and 13% judged vendor outstanding • 4% actively seeking to replace package, with 0% citing unsatisfactory performance as reason.**

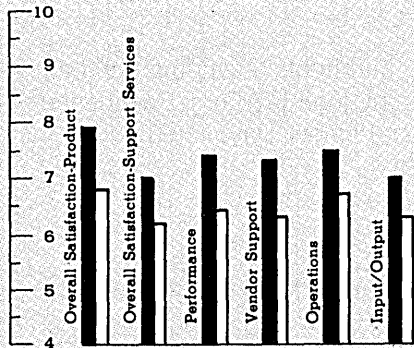

**ISA ACCOUNTING & BUDGETING SYSTEM • Information Systems of America, P.O. Box 47975, Atlanta, GA 30362 • 404-441-8800**

**35 responses • 11% judged package and 9% judged vendor outstanding • 9% actively seeking to replace package, with 0% citing unsatisfactory performance as reason.**

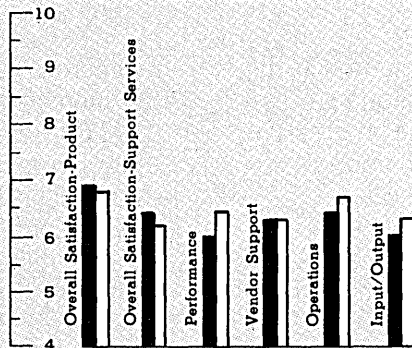

**ISA/CASH DISBURSEMENT SYSTEM • Information Systems of America, P.O. Box 47975, Atlanta, GA 30362 • 404-441-8800**

**47 responses • 11% judged package and 13% judged vendor outstanding • 6% actively seeking to replace package, with 0% citing unsatisfactory performance as reason.**

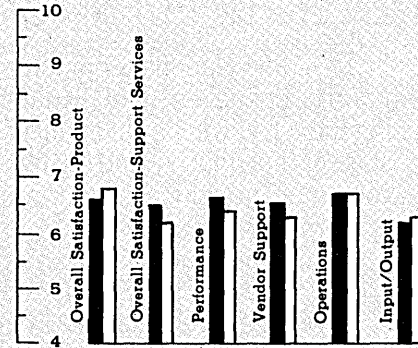

**ISA/ACCOUNTS PAYABLE • Information Systems of America, P.O. Box 47975, Atlanta, GA 30362 • 404-441-8800**

**24 responses • 13% judged package and 0% judged vendor outstanding • 38% actively seeking to replace package, with 13% citing unsatisfactory performance as reason.**

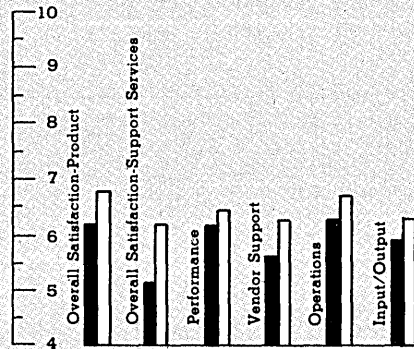

**ISA/GENERAL LEDGER • Information Systems of America, P.O. Box 47975, Atlanta, GA 30362 • 404-441-8800**

**24 responses • 0% judged package and 0% judged vendor outstanding • 50% actively seeking to replace package, with 13% citing unsatisfactory performance as reason.**

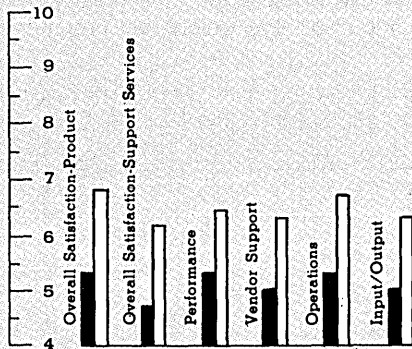

**INSIGHT • Insight Software Systems, One N. Broadway, Suite 901, White Plains, NY 10601 • 914-682-4910**

**27 responses • 19% judged package and 11% judged vendor outstanding • 0% actively seeking to replace package.**

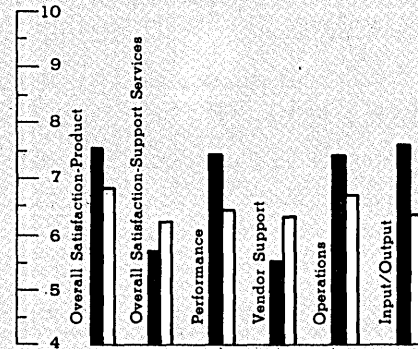



# 1984 National Computer Conference

July 9-12, 1984 — Convention Center — Las Vegas, Nevada

## E N H A N C I N G      C R E A T I V I T Y

The 1984 National Computer Conference, the premier annual event of the information processing industry, will be a portrait of the progressive state of the industry and the overall impact computers are having on our world.

### NCC '84 OFFERS YOU:

- An in-depth Conference Program, featuring over 90 technical sessions and 20 Professional Development Seminars.
- The opportunity to visit over 650 exhibits, and evaluate products and services in every major industry category.
- An introduction to the newest products and developments in the industry.

— Numerous other highlights, including the Keynote Session by John F. Akers, President of IBM Corporation; Pioneer Day; and the Film Forum.

Make plans now to experience the 1984 National Computer Conference!

For additional information, complete the coupon below and send to: NCC '84, AFIPS, 1899 Preston White Drive, Reston, VA, 22091.

Or, REGISTER TODAY via our toll-free number: 800-NCC-1984, using American Express, MasterCard, or VISA. (In Virginia, call 703-620-8955.)

Sponsored by: American Federation of Information Processing Societies, Inc.;  
Association for Computing Machinery; Data Processing Management Association;  
IEEE Computer Society; Society for Computer Simulation

FOR MORE INFORMATION, MAIL THIS COUPON TODAY.

Name _____	 Mail to: NCC '84 AFIPS 1899 Preston White Drive Reston, VA 22091
Title _____	
Company _____	
Address _____	
City _____ State _____ Zip _____	



# OXFORD JUST TAUGHT CICS to COBOL

## UFO/COBOL™ replaces Command Level COBOL with plain vanilla COBOL.

UFO/COBOL is the perfect answer to your procedural on-line programming needs. For the first time, all your COBOL programmers can now develop CICS applications without learning one word of new code. No longer will the lack of specialized Command Level programmers be a barrier to satisfying the growing demand for more on-line applications. Now your present staff can put their ANSI COBOL programming skills to work cutting your backlog of on-line applications... doing it faster, more efficiently, more automatically than ever before.

Without modifying your on-line environment or operating system, UFO/COBOL takes standard COBOL commands, and automatically translates them using a unique COBOL compiler into the language necessary for CICS program execution. Your ability to utilize the substantial benefits of the on-line

or modify screens without writing one line of code. You design the screen simply by positioning fields where you desire. Then COBOL data descriptions are *automatically* generated from the screen.

### UFO/COBOL makes prototyping easy.

By quickly defining a sequence of screens, you can prototype the final system... testing and modifying each screen before writing code. You can develop applications interactively with end-users, gaining all the efficiencies of their direct involvement.

### Developed by Oxford...#1 in CICS application development.

UFO/COBOL is a development of Oxford Software Corporation, the leading independent supplier of on-line application development software. With more than 1500 installations of UFO... the premier, 4th generation non-procedural approach to application development... no one knows more about the CICS application development environment than Oxford.

If you'd like to learn how you can dramatically add to your on-line development capabilities, using your present programming skills, call in the leader. Call Oxford today at (800) 631-1615.

#### An example of UFO/COBOL commands.

In COBOL	In Command level	In UFO/COBOL
DISPLAY (SCREEN-NAME)	EXEC CICS SEND MAP ('XDFHCMA') MAPONLY ERASE END-EXEC.	DISPLAY (SCREEN-NAME)
READ (FILE-NAME)	EXEC CICS READ DATASET ('FILE- NAME') INTO (FILE- NAME) RIDFLD (KEYNUM) END- EXEC.	READ (FILE-NAME)

environment increases enormously, while your programmers continue to write in a familiar and natural way.

### UFO/COBOL defines CICS 3270 screens on-line.

In addition to extending the capabilities of your programmers, you'll find that UFO/COBOL is a powerful new method to speed-up the CICS application process dramatically. Built into UFO/COBOL is an interactive screen painting facility that lets you design CICS 3270 screens on-line. UFO/PAINT allows you to build

 **OXFORD SOFTWARE CORPORATION**  
174 BOULEVARD/HASBROUCK HEIGHTS, NJ 07604/201 288-1515

I'd like to schedule a UFO/COBOL demo. Please call to set a date.

Please send me literature on UFO/COBOL.

Name \_\_\_\_\_

Title \_\_\_\_\_

Company \_\_\_\_\_

Address \_\_\_\_\_

City \_\_\_\_\_ State \_\_\_\_\_

Zip \_\_\_\_\_ Phone ( \_\_\_\_\_ ) \_\_\_\_\_ D/3/84



**Ratings Values**

10-9: Superior  
8-6: Very Good

5-3: Acceptable  
2-1: Inadequate

**Legend**

■ Specific Product Rating  
□ Group Average Rating

**ACCOUNTS PAYABLE** • Management Sciences America (MSA), 3445 Peachtree Road, NE, Atlanta, GA 30326 • 404-262-2376

54 responses • 17% judged package and 22% judged vendor outstanding • 13% actively seeking to replace package, with 0% citing unsatisfactory performance as reason.

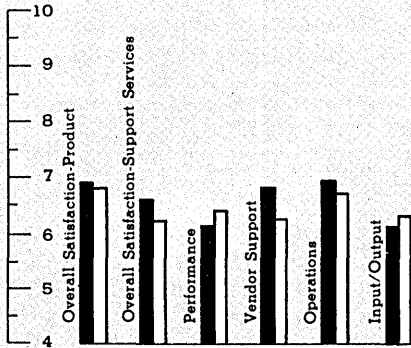

**ACCOUNTS RECEIVABLE** • Management Sciences America (MSA), 3445 Peachtree Road, NE, Atlanta, GA 30326 • 404-262-2376

55 responses • 11% judged package and 15% judged vendor outstanding • 9% actively seeking to replace package, with 0% citing unsatisfactory performance as reason.

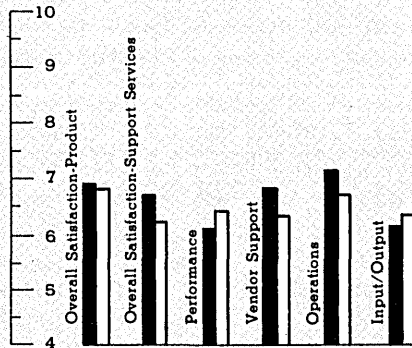

**FIXED ASSETS** • Management Sciences America (MSA), 3445 Peachtree Road, NE, Atlanta, GA 30326 • 404-262-2376

52 responses • 14% judged package and 15% judged vendor outstanding • 6% actively seeking to replace package, with 0% citing unsatisfactory performance as reason.

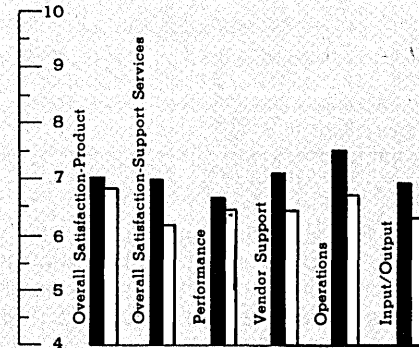

**GENERAL LEDGER/FICS** • Management Sciences America (MSA), 3445 Peachtree Road, NE, Atlanta, GA 30326 • 404-262-2376

64 responses • 20% judged package and 19% judged vendor outstanding • 3% actively seeking to replace package, with 0% citing unsatisfactory performance as reason.

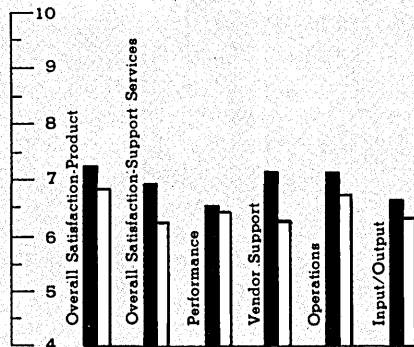

**ACCOUNTS PAYABLE PLUS** • McCormack & Dodge, 560 Hillside Avenue, Needham Heights, MA 02194 • 617-449-4012

38 responses • 5% judged package and 13% judged vendor outstanding • 5% actively seeking to replace package, with 0% citing unsatisfactory performance as reason.

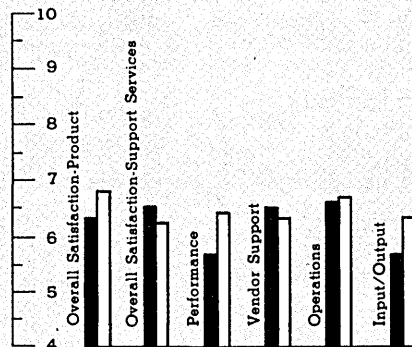

**FIXED ASSETS PLUS** • McCormack & Dodge, 560 Hillside Avenue, Needham Heights, MA 02194 • 617-449-4012

38 responses • 16% judged package and 11% judged vendor outstanding • 0% actively seeking to replace package.

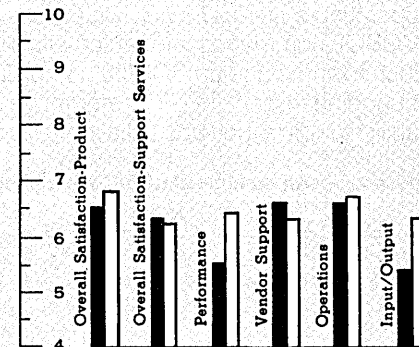

**GENERAL LEDGER PLUS** • McCormack & Dodge, 560 Hillside Avenue, Needham Heights, MA 02194 • 617-449-4012

54 responses • 19% judged package and 13% judged vendor outstanding • 4% actively seeking to replace package, with 0% citing unsatisfactory performance as reason.

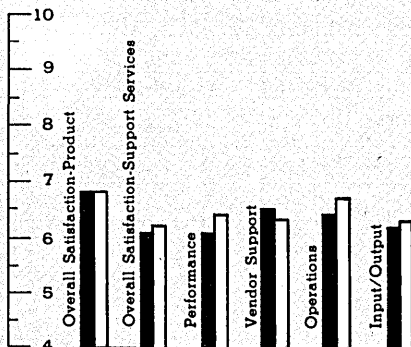

**ACCOUNTS PAYABLE** • Software International, One Technical Drive, Andover, MA 01810 • 617-685-1400

30 responses • 0% judged package and 0% judged vendor outstanding • 13% actively seeking to replace package, with 0% citing unsatisfactory performance as reason.

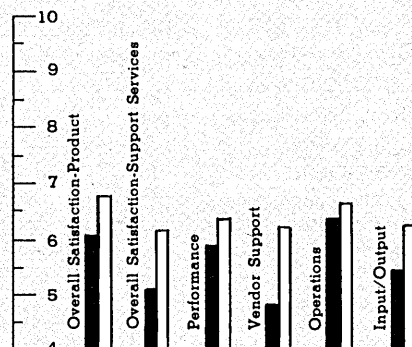

**ACCOUNTS RECEIVABLE** • Software International, One Technical Drive, Andover, MA 01810 • 617-685-1400

15 responses • 7% judged package and 7% judged vendor outstanding • 7% actively seeking to replace package, with 0% citing unsatisfactory performance as reason.

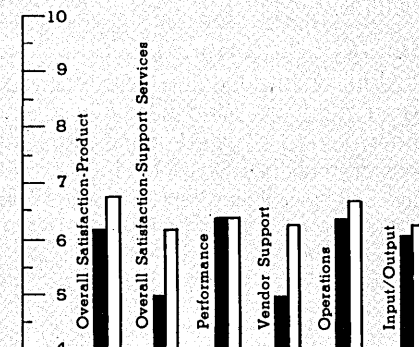



# Give your PC Big League Power!

## with Major League Graphics

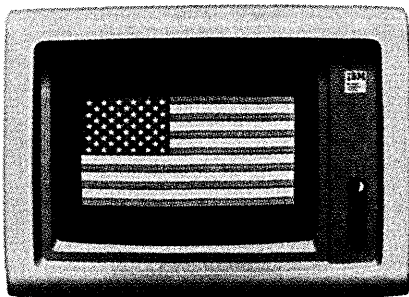

With the Forte-PJ™ 3278/79 Emulator/Adapter Board, your IBM PC\* or compatible system bats 1000 from both sides of the plate. You gain the speed and power of a coaxial cable-connected IBM 3278 display terminal while retaining all the functions of the Personal Computer. A single keyboard command moves you back and forth between DOS and terminal mode.

If your business game plan calls for color graphics, add the Forte-GRAPH™ 3279/SG3 Color Graphics Emulator/Adapter Option Board and unleash IBM's arsenal of S3G Programmed Symbols software (including GDDM™ and SAS/GRAPH™).

You'll have bar and pie charts, histograms and conceptual drawings at your fingertips, not to mention foreign language fonts, scientific notation and even your own custom-designed characters.

Whether you're working in color or monochrome, you can use PC spreadsheet programs and other packaged software to work with current data from your IBM host. Forte's automatic file transfer utility allows you to send, receive and store host files without ever leaving terminal emulation mode.

Forte provides all the hardware and software you need to emulate any full-function 3278 or 3279 terminal. In-

stallation is a snap: no host hardware or software modifications are necessary and only one slot is required.



**HOTLINE  
(800)  
233-3278**

If you're ready to play mainframe ball with your PC, you're ready for Forte.

# FORTE

**Forte Data Systems, Inc.**

1500 Norman Avenue • Santa Clara, CA 95050 • (408) 980-1750

## Your Micro-to-Mainframe Connection

\*Forte and all associated product names are trademarks of Forte Data Systems, Inc.  
\*IBM, IBM Personal Computer and IBM PC-XT are trademarks of IBM Corporation.

\*GDDM is a registered trademark of IBM Corp.  
\*SAS/GRAPH is a registered trademark of SAS

CIRCLE 119 ON READER CARD

**Ratings Values**

10-9: Superior  
8-6: Very Good

5-3: Acceptable  
2-1: Inadequate

**Legend**

■ Specific Product Rating  
□ Group Average Rating

**MANAGEMENT ACCOUNTING FOR CONSTRUCTION (MAC)** • Timberline Systems, 7180 S.W. Fir Loop, Portland, OR 97223 • 503-643-9461

46 responses • 44% judged package and 20% judged vendor outstanding • 0% actively seeking to replace package.

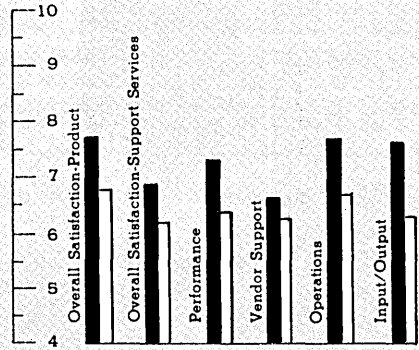

**FORTEX CARMS** • University Computing Co., UCC Tower, Exchange Park, Dallas, TX 75235 • 214-353-7846

45 responses • 18% judged package and 7% judged vendor outstanding • 7% actively seeking to replace package, with 0% citing unsatisfactory performance as reason.

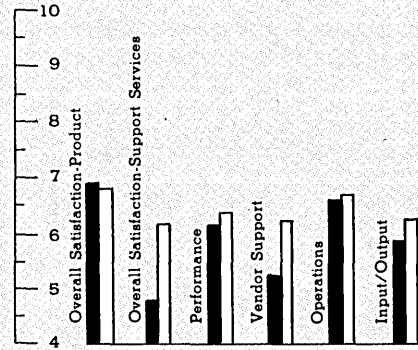

**UCC FINANCIAL CONTROL SYSTEM** • University Computing Co., UCC Tower, Exchange Park, Dallas, TX 75235 • 214-353-7846

41 responses • 12% judged package and 2% judged vendor outstanding • 7% actively seeking to replace package, with 0% citing unsatisfactory performance as reason.

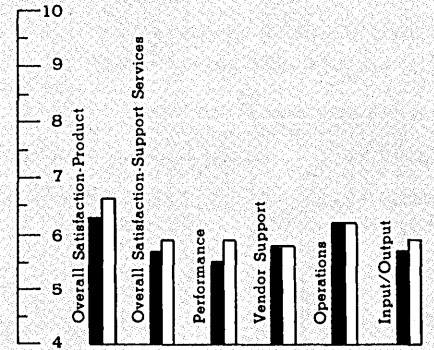

**IAI FINANCIAL ACCOUNTING** • Westinghouse Information Systems (formerly Information Assoc., Inc.), P.O. Box 30, Iowa City, IA 52244 • 319-354-9200

52 responses • 23% judged package and 4% judged vendor outstanding • 17% actively seeking to replace package, with 0% citing unsatisfactory performance as reason.

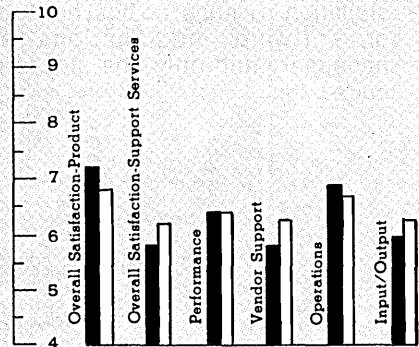

**PAYROLL/PERSONNEL** • Cyborg Systems, 2 North Riverside Plaza, Suite 2160, Chicago, IL 60606 • 312-454-1865

64 responses • 9% judged package and 8% judged vendor outstanding • 8% actively seeking to replace package, with 5% citing unsatisfactory performance as reason.

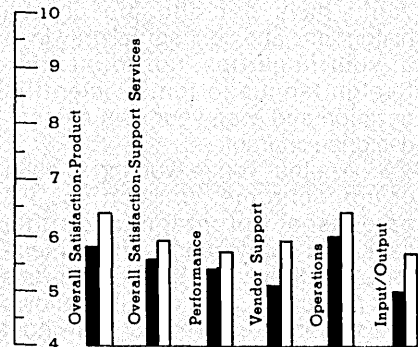

**HUMAN RESOURCES SYSTEM** • Information Sciences, 95 Chestnut Ridge Road, Montvale, NJ 07645 • 201-391-1600

29 responses • 0% judged package and 0% judged vendor outstanding • 21% actively seeking to replace package, with 4% citing unsatisfactory performance as reason.

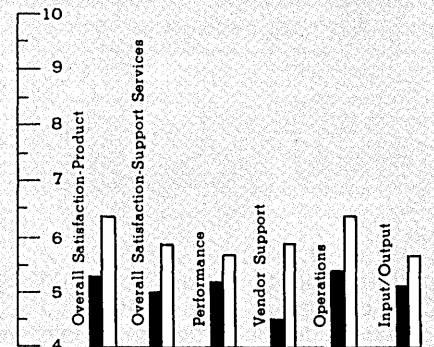

**PAYROLL/PERSONNEL** • Integral Systems, 165 Lennon Lane, Walnut Creek, CA 94598 • 415-939-3900

45 responses • 18% judged package and 13% judged vendor outstanding • 4% actively seeking to replace package, with 0% citing unsatisfactory performance as reason.

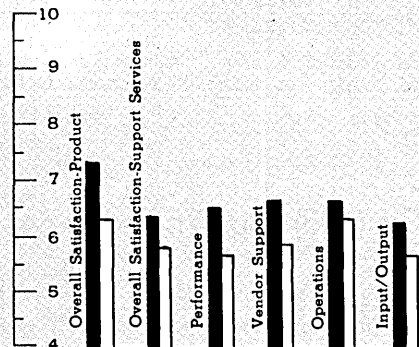

**HUMAN RESOURCES SYSTEM** • Management Sciences America (MSA), 3445 Peachtree Road, NE, Atlanta, GA 30326 • 404-262-2376

52 responses • 14% judged package and 17% judged vendor outstanding • 4% actively seeking to replace package, with 0% citing unsatisfactory performance as reason.

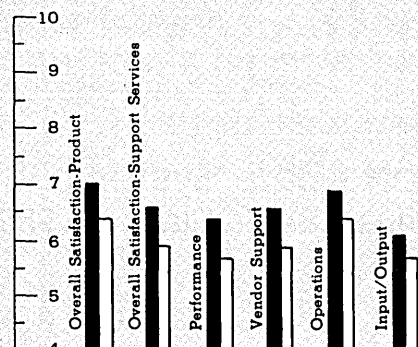

**PAYROLL/PERSONNEL** • Westinghouse Information Systems (formerly Information Assoc., Inc.), P.O. Box 30, Iowa City, IA 52244 • 319-354-9200

49 responses • 25% judged package and 27% judged vendor outstanding • 4% actively seeking to replace package, with 0% citing unsatisfactory performance as reason.

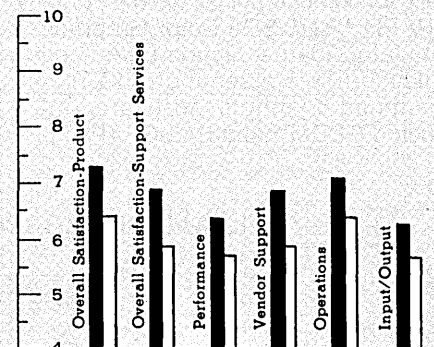

The New WY1000 Microcomputer

# BUILDING BLOCKS

Powerful, Affordable, Expandable.

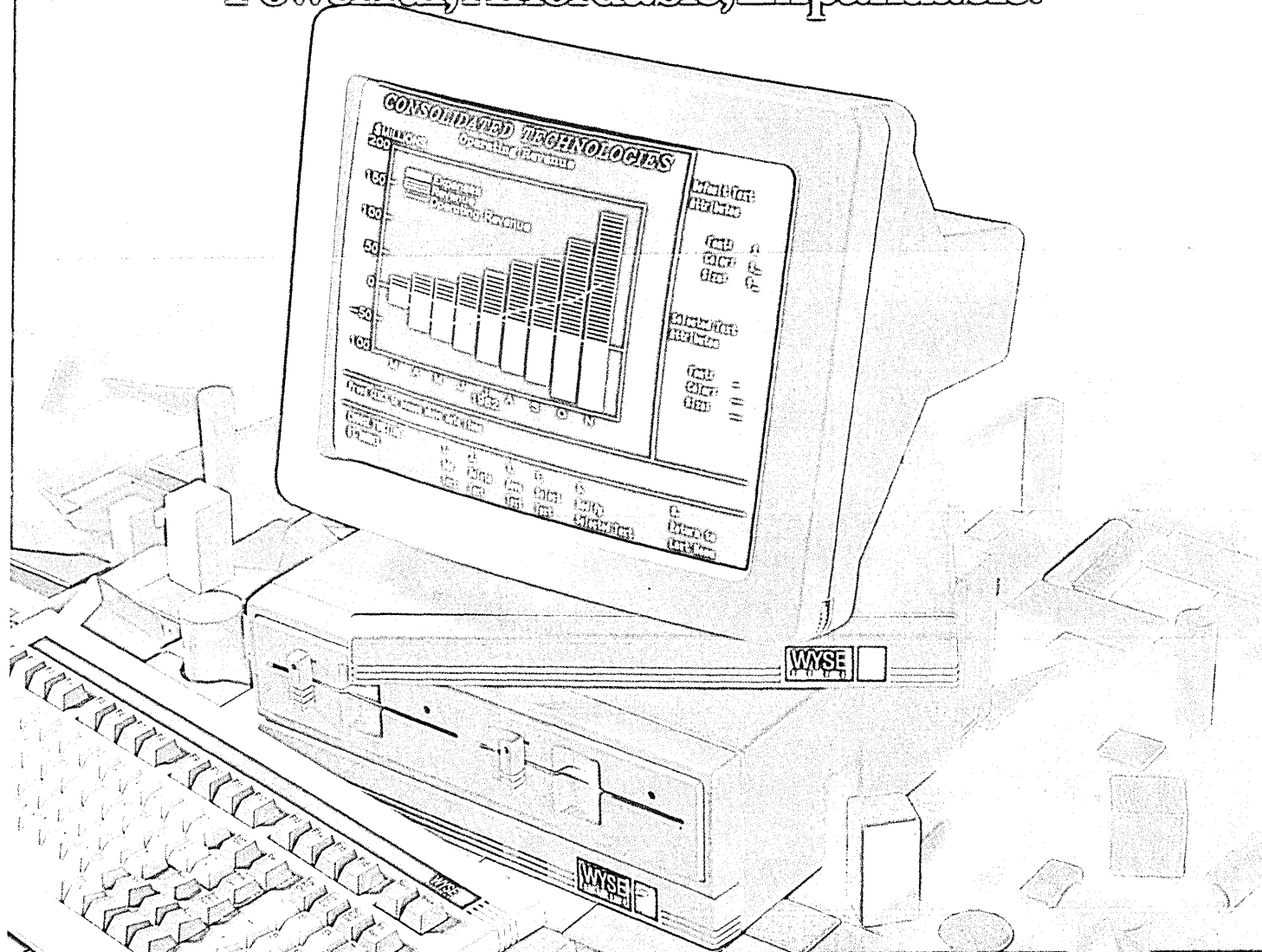

The WY1000 stacks up to be a lot of machine from a few simple pieces. By adding the WY1000 microcomputer to the good-looking, ergonomic WY50 display terminal, we created the most exciting concept in desktop workstations on the market today.

We also added sophisticated high resolution graphics, suitable for the most demanding applications.

Plus, we added color capability, when used with our color terminal.

And on top of that, we added a Winchester Disk Drive option providing an additional 10 megabytes of storage.

**FEATURES:**

- 80186 16 Bit 8 MHz Processor
- 128KB to 768KB RAM Memory
- Two Floppy Disk Drives (725 KB)
- Optional 10 MB Winchester Drive
- RS232 & RS422 Serial Ports
- Optional Graphics/Color Graphics
- Networking Capability
- CP/M™, MS-DOS™ Compatible
- Priced from only \$1995

Best of all, we priced the WY1000 from only \$1995. It all adds up to a system builder's dream.

For a complete brochure on the WY1000 contact Wyse Technology toll free at 800/421-1058.

## WYSE

Make the Wyse Decision.

WYSE TECHNOLOGY 3040 N. First St., San Jose, CA 95134, 408/946-3075, TLX 910-338-2251. Outside CA call toll-free, 800/421-1058, in So. CA 213/340-2013.



# 3270 Access

Expanding 3270 access to  
any terminal you have

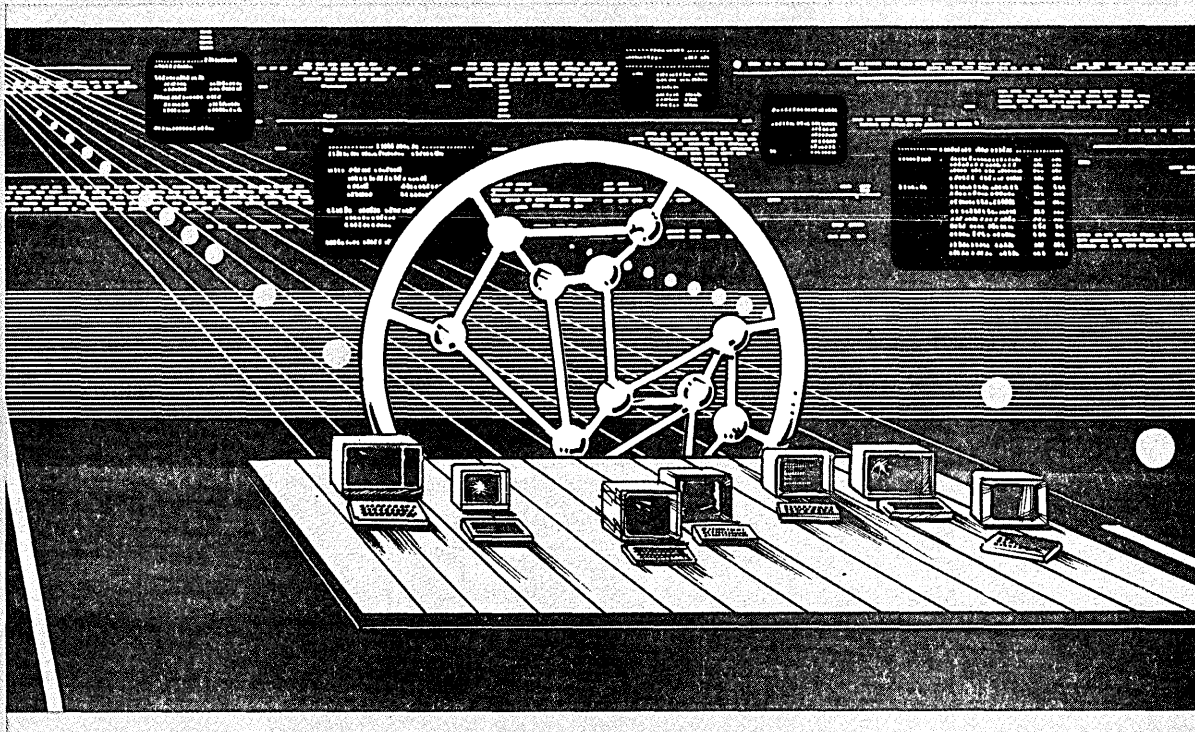

## **TYMNET** simplifies 3270 access.

All it takes is a terminal and a local call to the TYMNET public data network.

**We let you use the async terminals and personal computers you already have.**

We give 3270 terminals the versatility they need to access async services and independently access 3270 applications on one or more hosts.

There's no hardware or host software to buy. And TYMNET delivers price performance other data networks can't.

## What could be simpler?

For more information, call or write for TYMNET's "3270 Access" brochure.

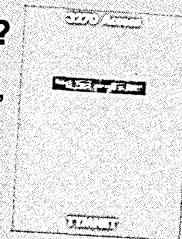

**TYMNET**, Inc.  
2710 Orchard Parkway  
San Jose, CA 95134  
(408) 946-4900



**Public and Private Data Networks**

# **TYMNET**<sup>®</sup>

A Tymshare Company

CIRCLE 121 ON READER CARD



**Ratings Values**

10-9: Superior  
8-6: Very Good  
5-3: Acceptable  
2-1: Inadequate

**Legend**

■ Specific Product Rating  
□ Group Average Rating

**PERSONNEL MANAGEMENT & REPORTING SYSTEM** • Management Sciences America (MSA), 3445 Peachtree Road, NE, Atlanta, GA 30326 • 404-262-2376

48 responses • 13% judged package and 15% judged vendor outstanding • 0% actively seeking to replace package.

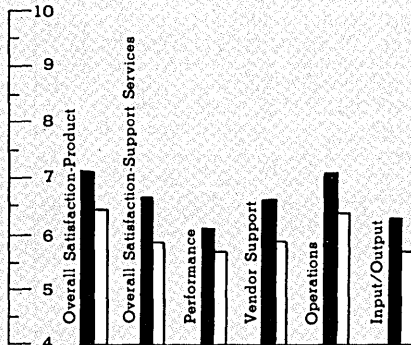

**HUMAN RESOURCES PLUS** • McCormack & Dodge, 560 Hillside Avenue, Needham Heights, MA 02194 • 617-449-4012

20 responses • 0% judged package and 10% judged vendor outstanding • 10% actively seeking to replace package, with 5% citing unsatisfactory performance as reason.

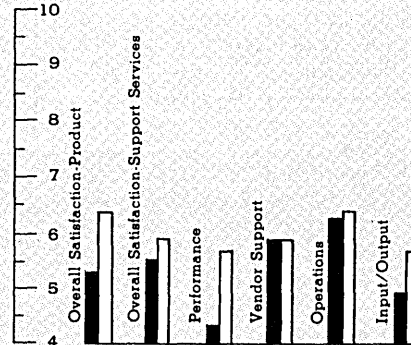

**PAYROLL/PERSONNEL** • Westinghouse Information Systems (formerly Information Assoc., Inc.), P.O. Box 30, Iowa City, IA 52244 • 319-354-9200

26 responses • 12% judged package and 0% judged vendor outstanding • 23% actively seeking to replace package, with 8% citing unsatisfactory performance as reason.

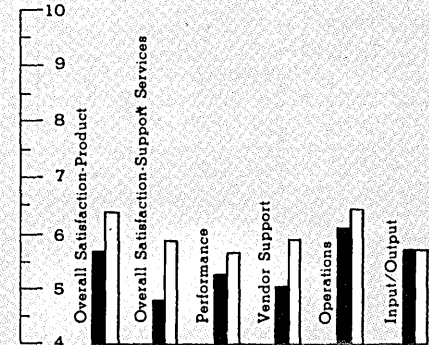

**GENERAL BUSINESS**

**AIMS PLUS** • AIMS Plus, Inc., 5000 E. Benwhite, Suite 200, Austin, TX 78741 • 512-385-0702

57 responses • 32% judged package and 14% judged vendor outstanding • 18% actively seeking to replace package, with 2% citing unsatisfactory performance as reason.

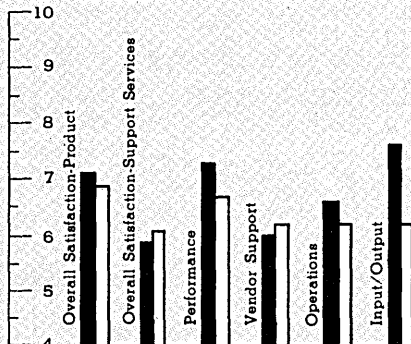

**SALES FORECASTING** • American Software Co., 443 E. Paces Ferry Road, Atlanta, GA 30305 • 404-261-4381

22 responses • 18% judged package and 9% judged vendor outstanding • 5% actively seeking to replace package, with 0% citing unsatisfactory performance as reason.

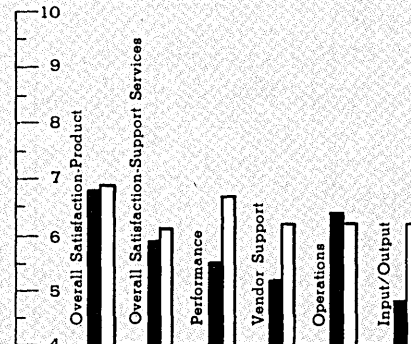

**ADR/ETC** • Applied Data Research, Inc., Rt. 206 and Orchard Rd., CN-8, Princeton, NJ 08540 • 201-874-9000

15 responses • 27% judged package and 20% judged vendor outstanding • 0% actively seeking to replace package.

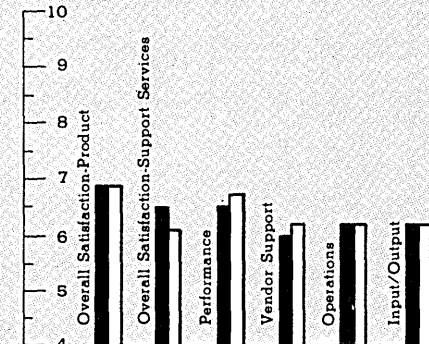

**EMPIRE** • Applied Data Research, Inc., Rt. 206 and Orchard Rd., CN-8, Princeton, NJ 08540 • 201-874-9000

18 responses • 28% judged package and 28% judged vendor outstanding • 17% actively seeking to replace package, with 0% citing unsatisfactory performance as reason.

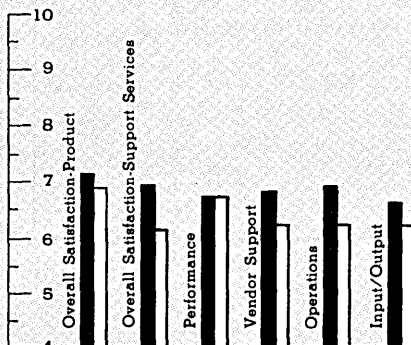

**CA-AUTOTAB** • Computer Associates International, 125 Jericho Turnpike, Jericho, NY 11753 • 516-333-6700

38 responses • 16% judged package and 0% judged vendor outstanding • 26% actively seeking to replace package, with 0% citing unsatisfactory performance as reason.

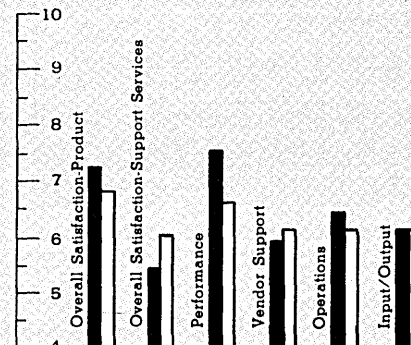

**IFPS** • Execucom Corporation, P.O. Box 9758, Austin, TX 78766 • 512-346-4980 • 800-531-5038

70 responses • 30% judged package and 17% judged vendor outstanding • 3% actively seeking to replace package, with 0% citing unsatisfactory performance as reason.

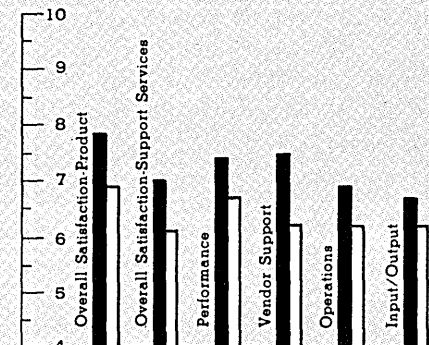

**A**t any moment it can happen: A power outage wipes out your computers, and when it does, you lose big—in time, money and in important data.

What's more, power fluctuations are not only a problem for computers, but for many other types of sensitive electronic equipment. Telecommunications systems,

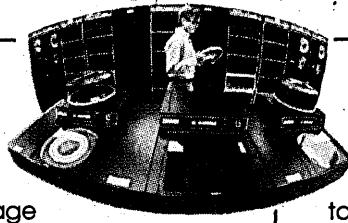

Available in models ranging from 400 VA to 25 kVA single-phase and 10 to 50 kVA three-phase, Elgar UPS feature full kVA load rating from 0.7 lagging to 0.9 leading P.F. All three-phase and single-phase units rated 15 kVA and higher include a full electronic static switch as a standard feature. Other models are available with the static switch as an option. Elgar can deliver the right

# *This sight strikes terror in the hearts of all computers.*

security equipment, process-control devices and laboratory instruments—

all rely on clean, continuous power.

Elgar has the solution—an Uninterruptible Power System (UPS) that provides total protection against out-of-the-ordinary power conditions for your AC line. In addition to blackout protection, an on-line UPS constantly filters the utility and regulates the output voltage, eliminating virtually

every power line problem without interruption or switching.

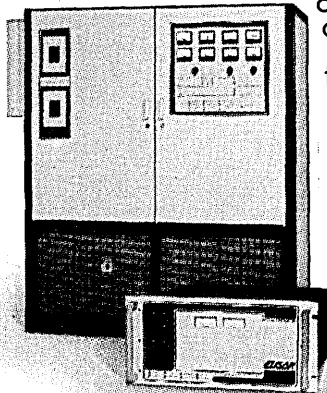

system for you—from the Mini-UPS, designed primarily for low power applications such as microprocessor-based

systems, data acquisition equipment and smaller microcomputers—to the large 50 kVA UPS employed with large data processing equipment or other sensitive systems.

To put it simply, when you order a UPS from Elgar, we'll deliver complete, continuous power from clean-up to back-up—and a much rarer commodity: peace of mind.

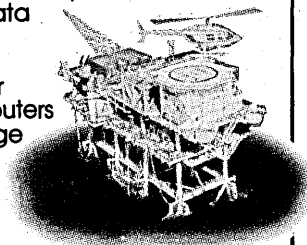

## **Powerful Solutions for Advanced Technology**

Call today for complete information:

**1-800-854-2213**

# **ELGAR**

An Onan/McGraw-Edison Company

8225 Mercury Court  
San Diego, California 92111  
Telephone (619) 565-1155  
TWX: 910-335-1246 Telex: 6834028

**Ratings Values**

10-9: Superior  
8-6: Very Good  
5-3: Acceptable  
2-1: Inadequate

**Legend**

■ Specific Product Rating  
□ Group Average Rating

**ISA/FORESIGHT** • Information Systems of America, P.O. Box 47975, Atlanta, GA 30362 • 404-441-8800

50 responses • 24% judged package and 10% judged vendor outstanding • 24% actively seeking to replace package, with 2% citing unsatisfactory performance as reason.

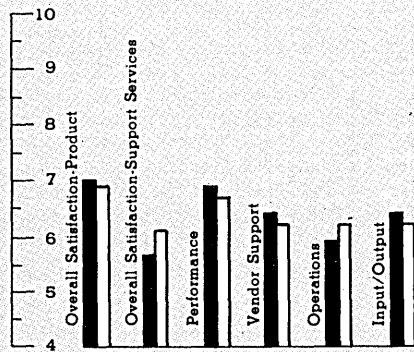

**FINANCIAL MANAGEMENT SYSTEM** • Interactive Management System, 375 Concord Avenue, Belmont, MA 02178 • 617-489-3550

28 responses • 0% judged package and 11% judged vendor outstanding • 32% actively seeking to replace package, with 0% citing unsatisfactory performance as reason.

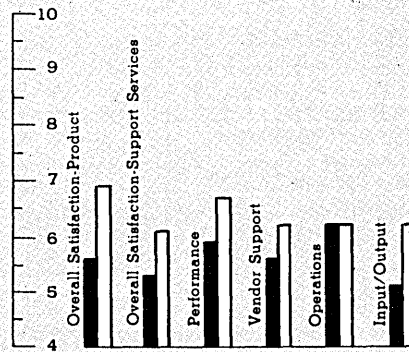

**DISSPLA** • ISSCO, 10505 Sorrento Valley Blvd., San Diego, CA 92121 • 619-452-0170

57 responses • 14% judged package and 7% judged vendor outstanding • 12% actively seeking to replace package, with 0% citing unsatisfactory performance as reason.

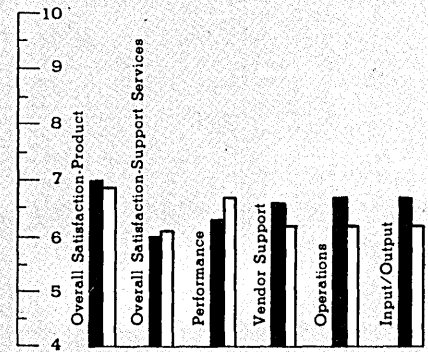

**TEL-A-GRAF** • ISSCO, 10505 Sorrento Valley Blvd., San Diego, CA 92121 • 619-452-0170

50 responses • 26% judged package and 20% judged vendor outstanding • 8% actively seeking to replace package, with 1% citing unsatisfactory performance as reason.

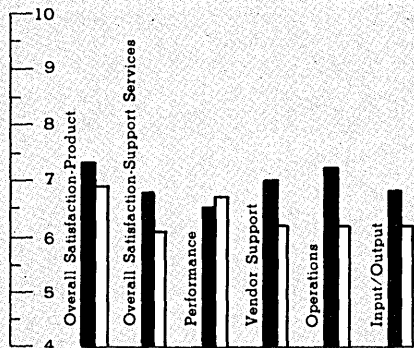

**CARRIER ROUTE CODING** • List Processing, Inc., 555 Waters Edge, Lombard, IL 60148 • 312-932-7000

52 responses • 17% judged package and 14% judged vendor outstanding • 10% actively seeking to replace package, with 0% citing unsatisfactory performance as reason.

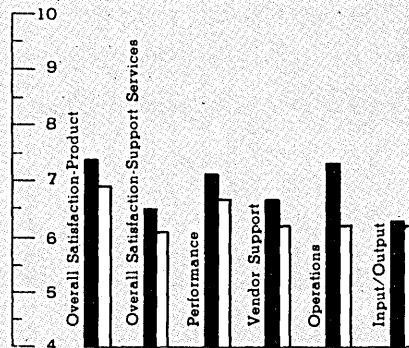

**ALLTAX** • Management Sciences America (MSA), 3445 Peachtree Road, NE, Atlanta, GA 30326 • 404-262-2376

54 responses • 43% judged package and 37% judged vendor outstanding • 20% actively seeking to replace package, with 2% citing unsatisfactory performance as reason.

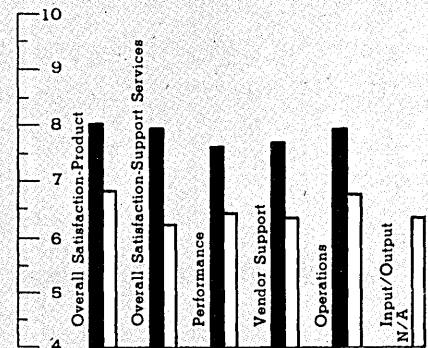

**FORECASTING & MODELING SYSTEM** • Management Sciences America (MSA), 3445 Peachtree Road, NE, Atlanta, GA 30326 • 404-262-2376

16 responses • 0% judged package and 6% judged vendor outstanding • 0% actively seeking to replace package.

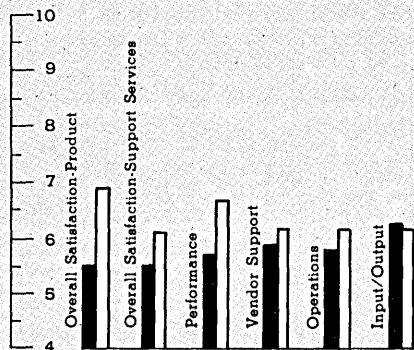

**SPSS BATCH SYSTEM** • SPSS, Inc., 444 N. Michigan Avenue, Chicago, IL 60611 • 312-329-2400

43 responses • 16% judged package and 9% judged vendor outstanding • 16% actively seeking to replace package, with 0% citing unsatisfactory performance as reason.

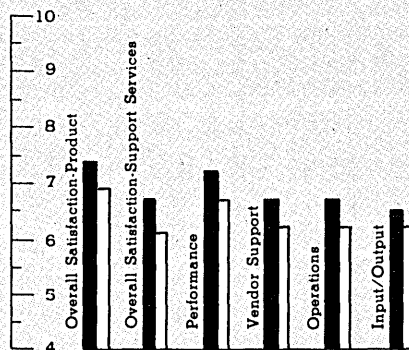

**BUSINESS MANAGEMENT SYSTEM** • Xerox Corporation, 5310 Beethoven Street, Los Angeles, CA 90066 • 213-306-4000

27 responses • 15% judged package and 7% judged vendor outstanding • 33% actively seeking to replace package, with 7% citing unsatisfactory performance as reason.

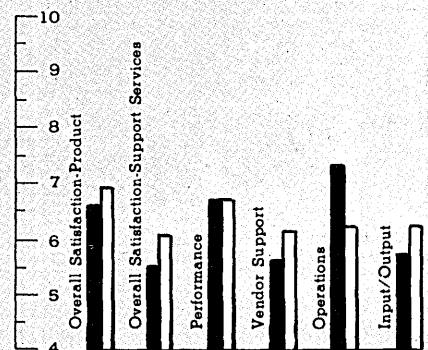

**Ratings Values**

10-9: Superior  
8-6: Very Good  
5-3: Acceptable  
2-1: Inadequate

**Legend**

■ Specific Product Rating  
□ Group Average Rating

**BANKING & FINANCIAL**

**ONLINE BANKING SYSTEM** • Bob White Computing, 830 Diane Lane, Naperville, IL 60540 • 312-887-1550

15 responses • 40% judged package and 20% judged vendor outstanding • 13% actively seeking to replace package, with 0% citing unsatisfactory performance as reason.

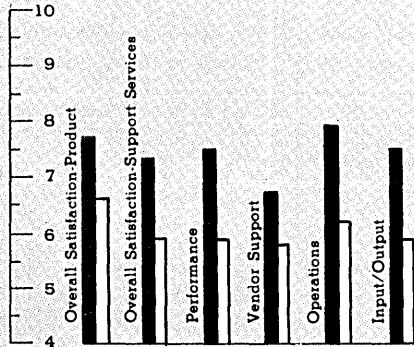

**CANTON SYSTEM/1990** • Citizens Automated Systems, 100 Central Plaza South, Canton, OH 44701 • 216-489-3740

18 responses • 17% judged package and 17% judged vendor outstanding • 22% actively seeking to replace package, with 6% citing unsatisfactory performance as reason.

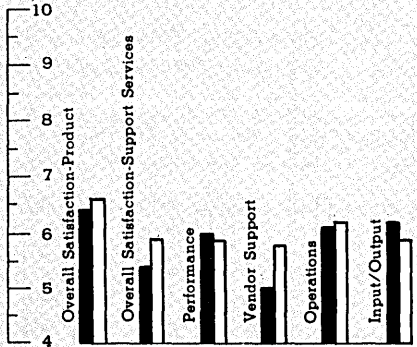

**PRO-TRUST** • Dyatron Corp., P.O. Box 235, Birmingham, AL 35201 • 205-956-7500

18 responses • 6% judged package and 6% judged vendor outstanding • 33% actively seeking to replace package, with 0% citing unsatisfactory performance as reason.

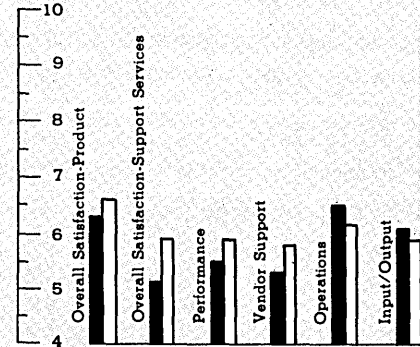

**FINANCIAL MANAGEMENT SYSTEM (FMS)** • Florida Software Services, P.O. Box 2269, Orlando, FL 32802 • 305-831-3001

15 responses • 0% judged package and 0% judged vendor outstanding • 27% actively seeking to replace package, with 20% citing unsatisfactory performance as reason.

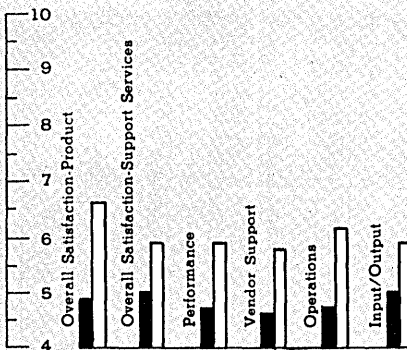

**DIRECT DEPOSIT ACCOUNTING (DDA)** • Florida Software Services, P.O. Box 2269, Orlando, FL 32802 • 305-831-3001

16 responses • 19% judged package and 13% judged vendor outstanding • 0% actively seeking to replace package.

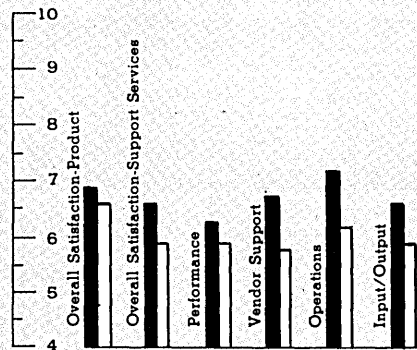

**CERTIFICATE OF DEPOSIT (CD)** • Florida Software Services, P.O. Box 2269, Orlando, FL 32802 • 305-831-3001

33 responses • 6% judged package and 9% judged vendor outstanding • 12% actively seeking to replace package, with 0% citing unsatisfactory performance as reason.

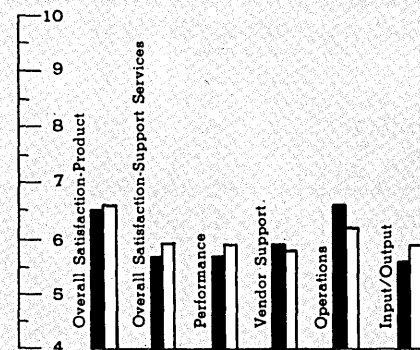

**MORTGAGE LOAN SYSTEM** • Florida Software Services, P.O. Box 2269, Orlando, FL 32802 • 305-831-3001

27 responses • 4% judged package and 4% judged vendor outstanding • 11% actively seeking to replace package, with 0% citing unsatisfactory performance as reason.

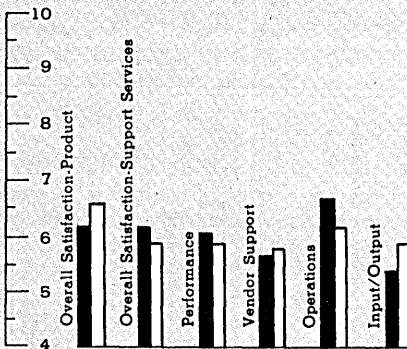

**COMMERCIAL LOAN SYSTEM** • Florida Software Services, P.O. Box 2269, Orlando, FL 32802 • 305-831-3001

35 responses • 6% judged package and 11% judged vendor outstanding • 9% actively seeking to replace package, with 0% citing unsatisfactory performance as reason.

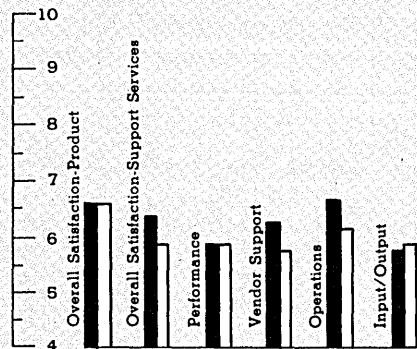

**INTEGRATED DEPOSITS SYSTEM** • Hogan Systems, 14951 Dallas Parkway, Suite 400, Dallas, TX 75240 • 214-386-0020

16 responses • 0% judged package and 0% judged vendor outstanding • 0% actively seeking to replace package.

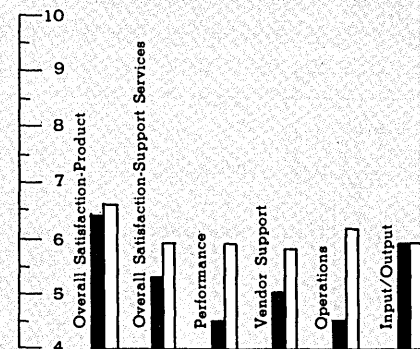



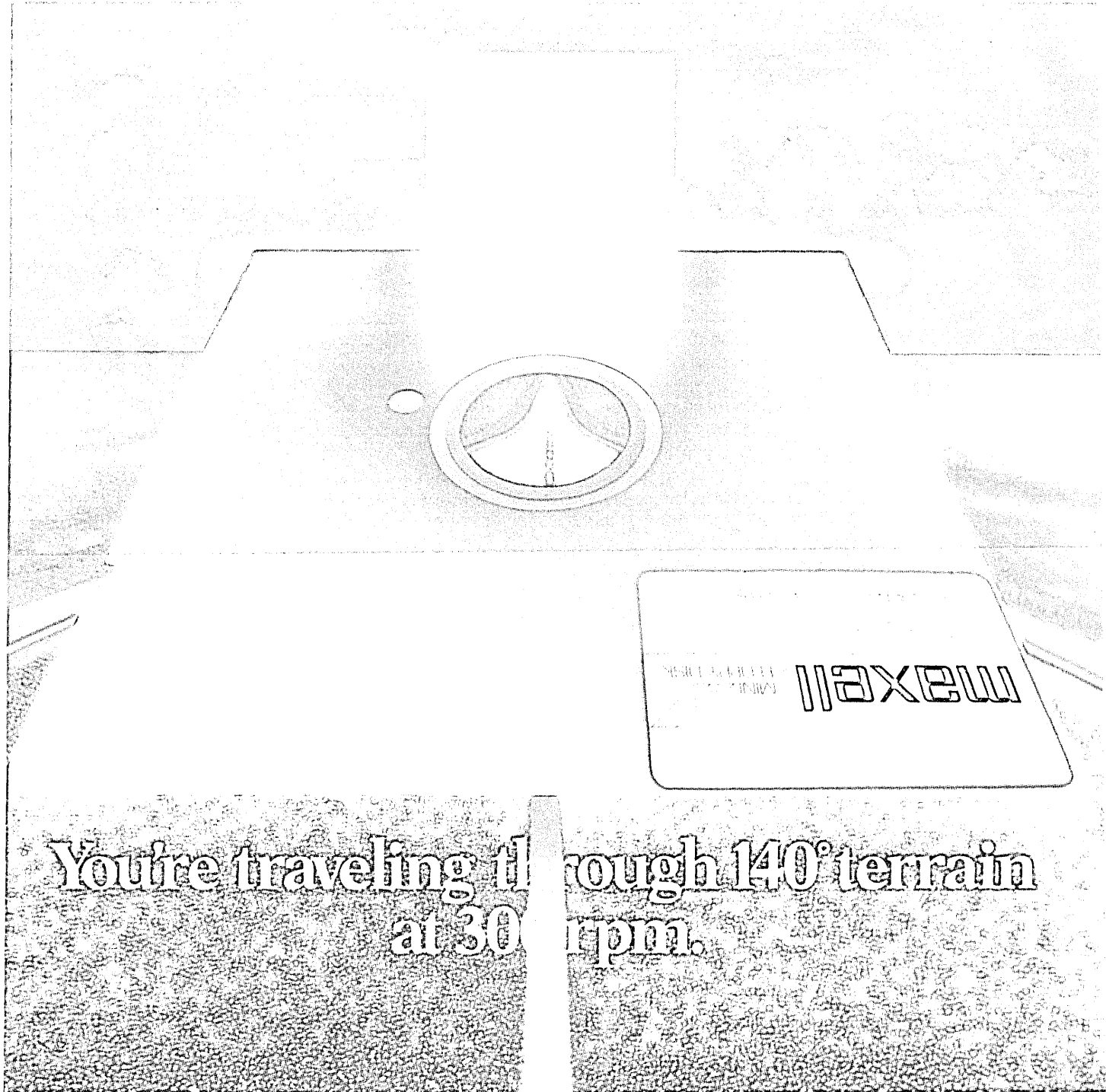

You're traveling through 140° terrain  
at 30 rpm.

**Only one disk guarantees safe passage through the torrid zone of drive heat. Maxell.**

A lifetime warranty. And manufacturing standards that make it almost unnecessary.

Consider this: Every time you take your disk for a little spin, you expose it to drive heat that can sidetrack data. Worse, take it to the point of no return. Maxell's unique jacket construction defies heat of 140°F. And keeps your information on track.

And Maxell runs clean. A unique process impregnates lubricants throughout the oxide layer. Extending media and head life. How good is Gold?

Maxell's the disk that many drive manufacturers trust to put new equipment through its paces. It's that bug-free.

So you can drive a bargain. But in accelerated tests, Maxell floppys lead the industry in error-free performance and durability. Proving that if you can't stand the heat you don't stand a chance.

maxell  
FLOPPY DISK

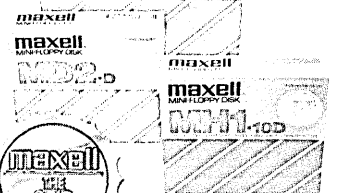

maxell®

IT'S WORTH IT.



**Ratings Values**

10-9: Superior  
8-6: Very Good

5-3: Acceptable  
2-1: Inadequate

**Legend**

■ Specific Product Rating  
□ Group Average Rating

**PROPHET** • Hogan Systems, 14951 Dallas Parkway, Suite 400, Dallas, TX 75240 • 214-386-0020

15 responses • 7% judged package and 0% judged vendor outstanding • 0% actively seeking to replace package.

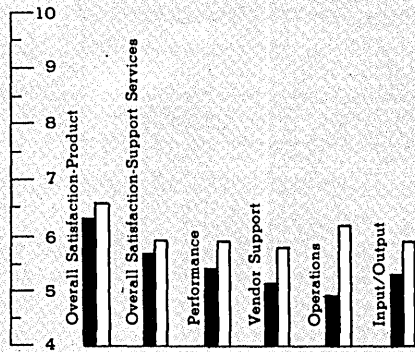

**THE UMBRELLA SYSTEM** • Hogan Systems, 14951 Dallas Parkway, Suite 400, Dallas, TX 75240 • 214-386-0020

19 responses • 21% judged package and 5% judged vendor outstanding • 0% actively seeking to replace package.

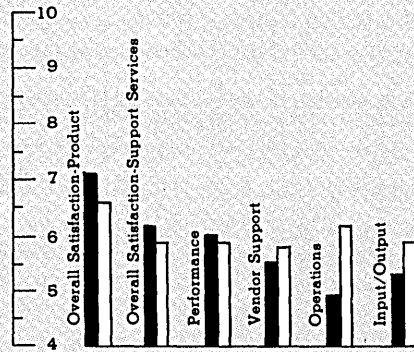

**SAVINGS & LOAN SYSTEM** • Remote Computing, 1076 E. Meadow Circle, Palo Alto, CA 94303 • 415-494-6111

38 responses • 18% judged package and 21% judged vendor outstanding • 40% actively seeking to replace package, with 0% citing unsatisfactory performance as reason.

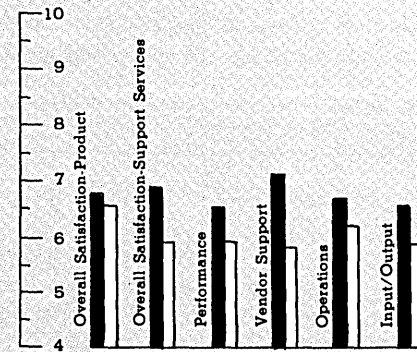

**PEP** • Stockholder Systems, 1965 N. Park Place, Atlanta, GA 30339 • 404-952-3387

54 responses • 20% judged package and 30% judged vendor outstanding • 11% actively seeking to replace package, with 0% citing unsatisfactory performance as reason.

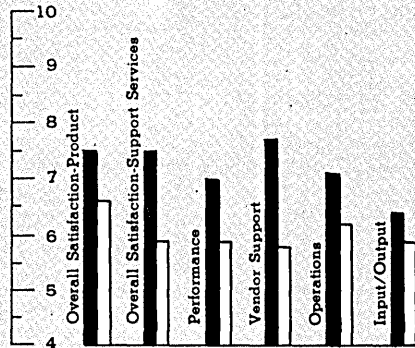

**CORPORATE SHAREHOLDER SYSTEM** • Stockholder Systems, 1965 N. Park Place, Atlanta, GA 30339 • 404-952-3387

47 responses • 21% judged package and 11% judged vendor outstanding • 23% actively seeking to replace package, with 2% citing unsatisfactory performance as reason.

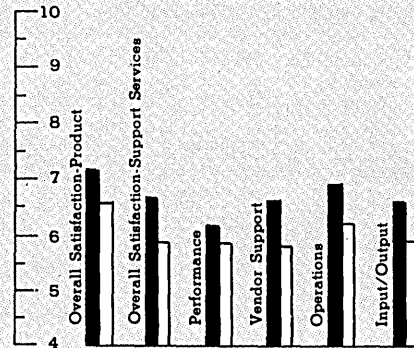

**UCC COMMERCIAL LOAN SYSTEM** • University Computing Co., UCC Tower, Exchange Park, Dallas, TX 75235 • 214-353-7846

23 responses • 4% judged package and 0% judged vendor outstanding • 26% actively seeking to replace package, with 0% citing unsatisfactory performance as reason.

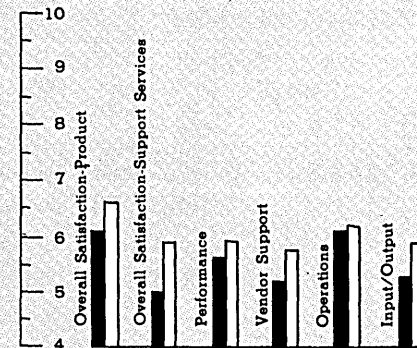

**UCC CUSTOMER INFORMATION SYSTEM** • University Computing Co., UCC Tower, Exchange Park, Dallas, TX 75235 • 214-353-7846

39 responses • 10% judged package and 3% judged vendor outstanding • 21% actively seeking to replace package, with 0% citing unsatisfactory performance as reason.

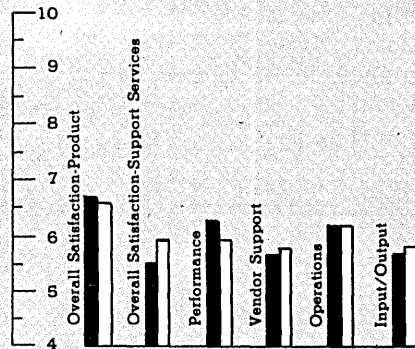

**UCC INSTALLMENT LOAN SYSTEM** • University Computing Co., UCC Tower, Exchange Park, Dallas, TX 75235 • 214-353-7846

41 responses • 5% judged package and 2% judged vendor outstanding • 27% actively seeking to replace package, with 5% citing unsatisfactory performance as reason.

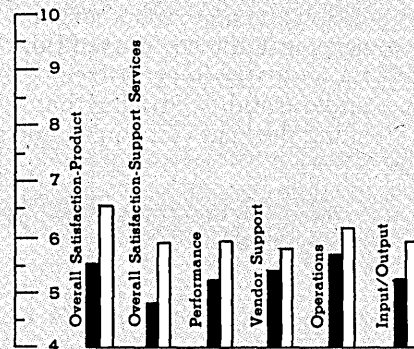

**UCC PAPERLESS ITEM PROCESSING (PIP)** • University Computing Co., UCC Tower, Exchange Park, Dallas, TX 75235 • 214-353-7846

55 responses • 11% judged package and 0% judged vendor outstanding • 27% actively seeking to replace package, with 5% citing unsatisfactory performance as reason.

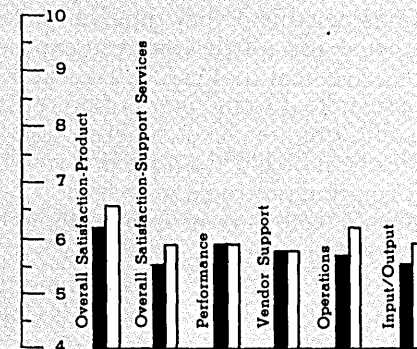



## THE NEW 924. THE TELEVIDEO SUCCESS STORY (cont'd.)

TeleVideo® has combined the best innovations in technology, design and quality of manufacturing to bring you superior terminals. Now with the new 924 we've built in comfort and productivity features that leave the other manufacturers behind.

For user comfort, the 924 has a tilt and swivel non-glare screen and DIN-standard low profile keyboard. 16 programmable, non-volatile function keys (shiftable to 32) turn often used instructions into one key commands. Extra display features include full screen editing, character and block graphics, plus 32 non-embedded visual attributes. The 924's logical attributes define protected and unprotected regions for accurate data entry.

If you don't need the full power of the 924, our 914 has all the design advantages of the 924 at less cost.

Whatever your application, nothing measures up to TeleVideo. And nothing succeeds like the 924!

Call us at (800) 538-8725 for more information. (In California call (408) 745-7760) or contact your nearest TeleVideo office:

California/Santa Ana .....	(714) 476-0244
California/Sunnyvale .....	(408) 745-7760
Georgia/Atlanta .....	(404) 447-1231
Illinois/Chicago .....	(312) 397-5400
Massachusetts/Boston .....	(617) 890-3282
New York/New York .....	(516) 496-4777
Texas/Dallas .....	(214) 258-6776
Central Europe (The Netherlands) .....	(31) 2503-35444
Northern Europe (United Kingdom) .....	(44) 9-905-6464
Southern Europe (France) .....	(33) 1-686-4412

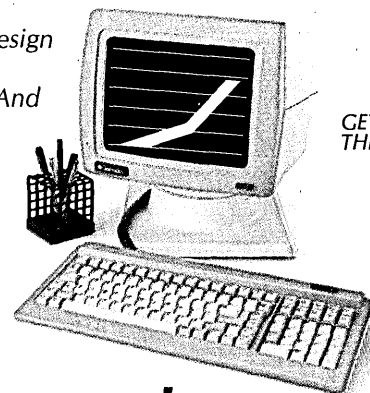

GET IN ON THE BOOM™

# TeleVideo® Terminals

TeleVideo Systems, Inc.

Service is available nationwide from General Electric Electronic Instrumentation and Computer Service Centers.

CIRCLE 124 ON READER CARD

# The fascinating tale behind the world's first\* laser video disc player with a semiconductor laser by Hitachi.

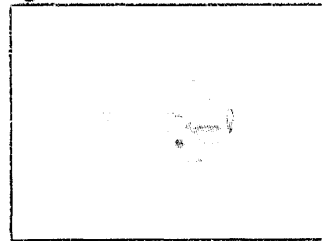

The advantages of the laser video disc are considerable. The same size as an LP record, the laser video disc can hold more information in less space than any other medium today. And that information is rapidly and selectively accessible. Combined with computer program capability, the varieties of interaction between the viewer and the medium are a distinguishing feature of the disc and player.

Until now, large bulky gas lasers were used to read the discs. The advantages of semiconductor lasers were not unknown, but they had serious problems. When the temperature fluctuated, so did the output power of the semiconductor laser. This resulted in noise and serious interference with quality laser disc reproduction. Hitachi's research team began a series of experiments to see if the problems could be solved.

Changes in the heat sink temperature resulted in considerable noise seen on the mirror feedback trace based on noise (modulating noise) and is represented by the clearly visible peaks.

Fig. 2 RIN (Relative Intensity Noise) at various temperatures

(a) Without HIF superimposition

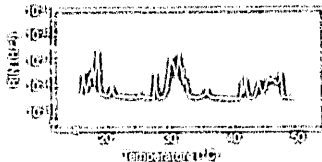

(b) With HIF superimposition

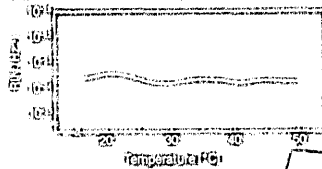

The line in Fig. 2(b) however, is remarkably straight. It represents measurements under the same conditions as for Fig. 2(a) but with a superimposed HIF (High Frequency) sinusoidal current. These experiments clearly show that noise can be virtually totally suppressed by HIF current superimposition.

This important breakthrough made a laser video disc player with a semiconductor laser a practical possibility. And Hitachi's technological expertise has made such a thing a reality. Other special features include an exceptionally durable motor, unusual design for rapid searching, ultrahigh speed random access and accurate tracking with a Hitachi-developed 3-directional actuator.

## Hitachi's 3-Directional Actuator

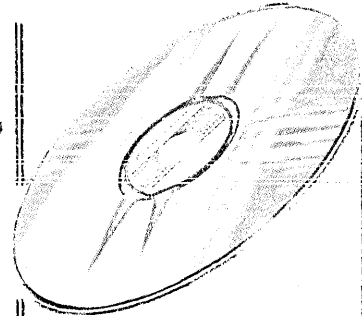
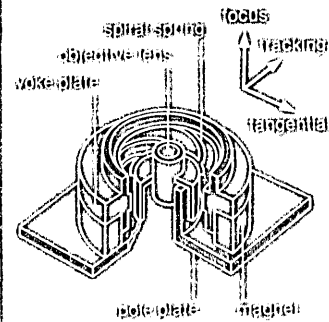

Application of this unique and powerful medium is barely beginning. For education, for training, for "living catalogs," and for computer visualizations, permitting amazing speed and flexibility, the laser video disc is unique. And Hitachi's laser video disc players permits the first to realize the medium's full potential with greater ease and convenience than has ever been possible before.

\* Specifically, the world's first mass-produced laser video disc player with a semiconductor laser (the LDP-1000) began September, 1982.

Fig. 1 Measuring Laser Noise

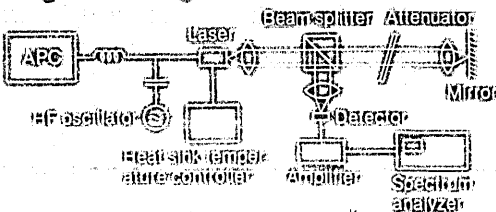

A special configuration to measure laser noise was used (see Fig. 1). An automatic power control circuit maintained a constant power output. A beam splitter deflected part of the output which was focused on a detector. Another part was focused on a mirror and an attenuator controlled the feedback light intensity.

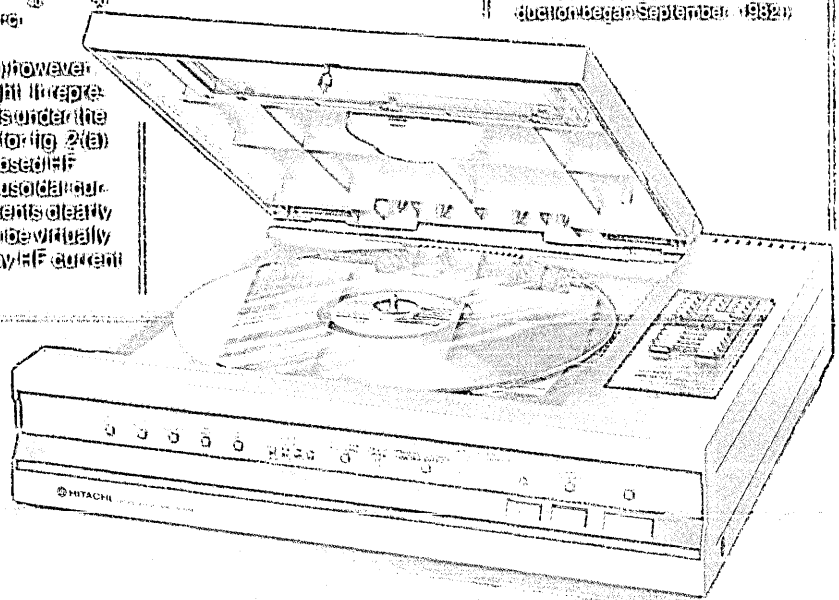

# HITACHI

A World Leader in Technology

Semiconductor  
Laser Video Disc Player  
FOR PROFESSIONAL USE

For details, Hitachi Sales Corp. of America  
Eastern Regional Office: Mt. D. Road, Whippany, NJ 07977, Phone (201) 962-6600  
Western Regional Office: Mt. D. Rd., Whippany, NJ 07977, Phone (201) 962-6600

CIRCLE 125 ON READER CARD

**Ratings Values**

10-9: Superior  
8-6: Very Good

5-3: Acceptable  
2-1: Inadequate

**Legend**

■ Specific Product Rating  
□ Group Average Rating

**UCC SUPER MICR** • University Computing Co., UCC Tower, Exchange Park, Dallas, TX 75235 • 214-353-7846

46 responses • 30% judged package and 13% judged vendor outstanding • 17% actively seeking to replace package, with 4% citing unsatisfactory performance as reason.

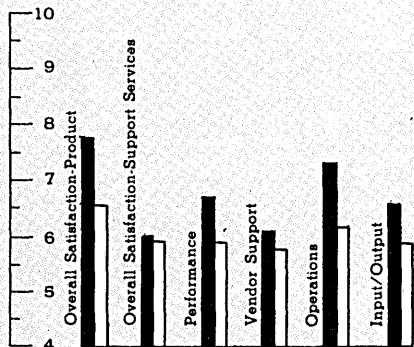

**DEMAND DEPOSIT/CREDIT RESERVE** • Weiland Software Group, 240 Fencel Lane, Hillside, IL 60162 • 312-449-2033

17 responses • 12% judged package and 0% judged vendor outstanding • 47% actively seeking to replace package, with 0% citing unsatisfactory performance as reason.

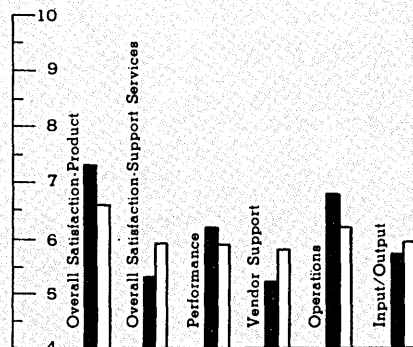

**INSURANCE**

**LIFE-COMM** • Informatics General Corp., 21031 Ventura Blvd., Suite 800, Woodland Hills, CA 91364 • 213-887-9040

38 responses • 0% judged package and 0% judged vendor outstanding • 13% actively seeking to replace package, with 5% citing unsatisfactory performance as reason.

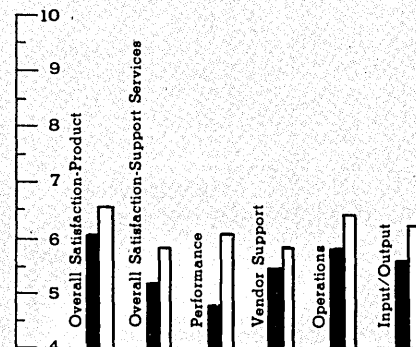

**INSURENET** • Insurenent, Inc., 1900 Powell Street, Emeryville, CA 94608 • 415-652-3771

33 responses • 15% judged package and 9% judged vendor outstanding • 27% actively seeking to replace package, with 3% citing unsatisfactory performance as reason.

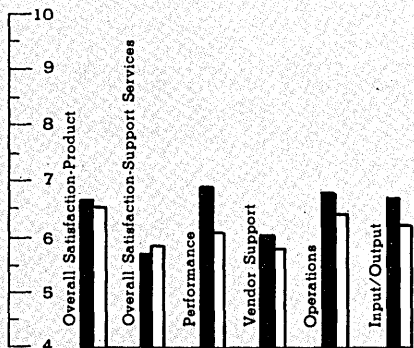

**CREDIT LIFE ADMINISTRATION** • Logic, Inc., 2720 Stemmens Freeway, 1100 Stemmens Tower South, Dallas TX 75207 • 214-630-6131

15 responses • 27% judged package and 13% judged vendor outstanding • 13% actively seeking to replace package, with 0% citing unsatisfactory performance as reason.

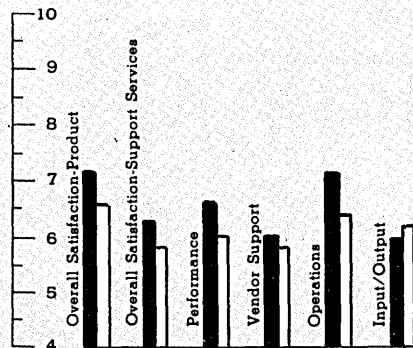

**PALLM SYSTEM** • PALLM, Inc., 2606 Fortune Circle, East Drive, Indianapolis, IN 46241 • 317-243-7591

44 responses • 9% judged package and 16% judged vendor outstanding • 16% actively seeking to replace package, with 0% citing unsatisfactory performance as reason.

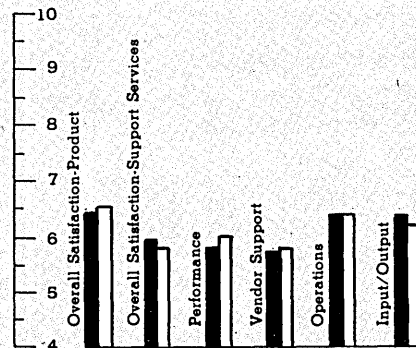

**MANUFACTURING**

**MANMAN** • Ask Computer Systems, 730 Distel Drive, Los Altos, CA 94022 • 415-969-4442

66 responses • 26% judged package and 14% judged vendor outstanding • 9% actively seeking to replace package, with 2% citing unsatisfactory performance as reason.

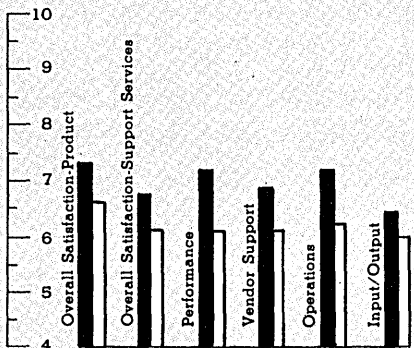

**MINI-MIZ/PAIS** • Automated Quill, Inc., 3501 S. Corona, Top Floor, Englewood, CO 80110 • 303-761-2722

18 responses • 6% judged package and 6% judged vendor outstanding • 22% actively seeking to replace package, with 11% citing unsatisfactory performance as reason.

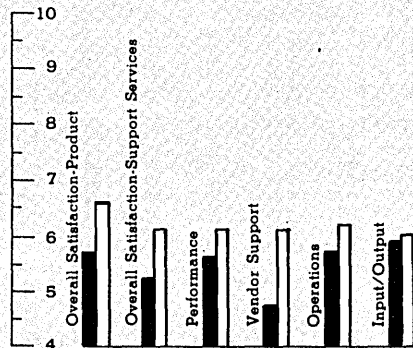

**MRPS** • Cincom Systems, Inc., 2300 Montana Avenue, Cincinnati, OH 45211 • 513-662-2300

16 responses • 13% judged package and 0% judged vendor outstanding • 19% actively seeking to replace package, with 0% citing unsatisfactory performance as reason.

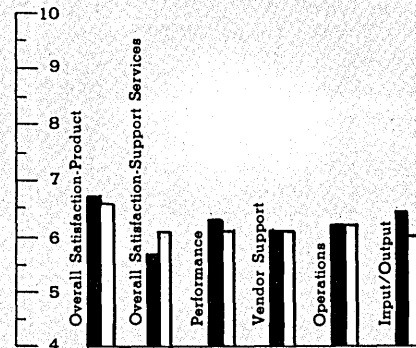



**Ratings Values**

10-9: Superior  
8-6: Very Good  
5-3: Acceptable  
2-1: Inadequate

**Legend**

■ Specific Product Rating  
□ Group Average Rating

**AMAPS** • Comserv, 3400 Comserv Drive, Eagan, MN 55122 • 612-681-7000

47 responses • 21% judged package and 13% judged vendor outstanding • 9% actively seeking to replace package, with 4% citing unsatisfactory performance as reason.

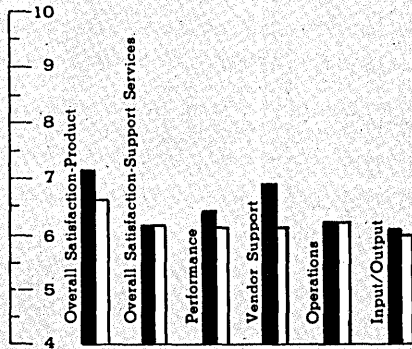

**ARISTA MANUFACTURING SYSTEM** • Management Sciences America (MSA), 3445 Peachtree Road, NE, Atlanta, GA 30326 • 404-262-2376

17 responses • 6% judged package and 12% judged vendor outstanding • 6% actively seeking to replace package, with 0% citing unsatisfactory performance as reason.

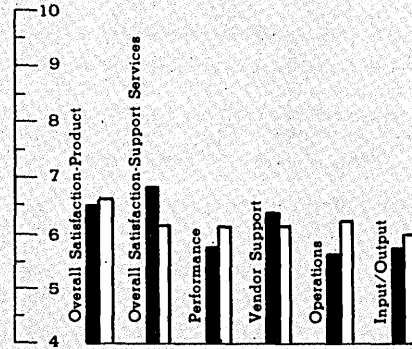

**MAS MANUFACTURING CONTROL SYSTEM** • Martin-Marietta Data Systems, 6303 Ivy Lane, Greenbelt, MD 20770 • 301-982-6500

22 responses • 0% judged package and 5% judged vendor outstanding • 5% actively seeking to replace package, with 5% citing unsatisfactory performance as reason.

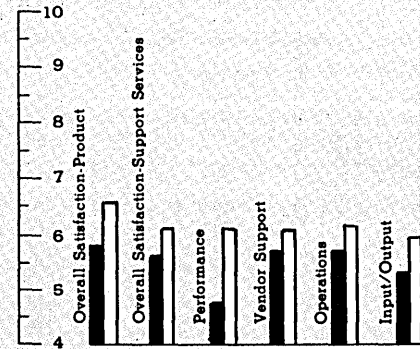

**PROJECT MANAGEMENT**

**MAXCIM** • NCA Corporation, 388 Oakmead Parkway, Sunnyvale, CA 94086 • 408-245-7990

41 responses • 15% judged package and 10% judged vendor outstanding • 22% actively seeking to replace package, with 3% citing unsatisfactory performance as reason.

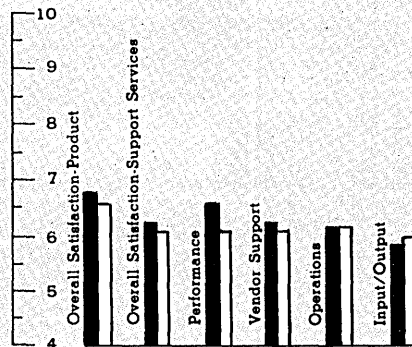

**PAC SYSTEMS** • AGS Management Systems, 320 Walnut Street, Philadelphia, PA 19106 • 215-922-7500

31 responses • 16% judged package and 16% judged vendor outstanding • 16% actively seeking to replace package, with 0% citing unsatisfactory performance as reason.

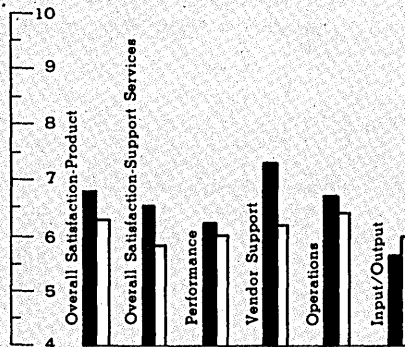

**PROJECT CONTROL/70** • AGS Management Systems, 320 Walnut Street, Philadelphia, PA 19106 • 215-922-7500

17 responses • 0% judged package and 12% judged vendor outstanding • 6% actively seeking to replace package, with 6% citing unsatisfactory performance as reason.

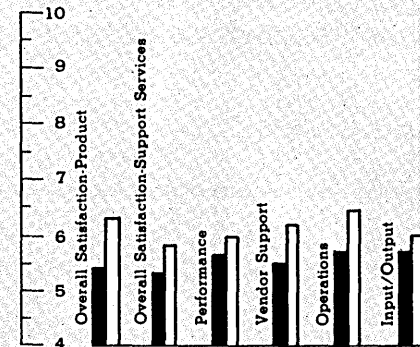

**SDM/70** • AGS Management Systems, 320 Walnut Street, Philadelphia, PA 19106 • 215-922-7500

16 responses • 13% judged package and 6% judged vendor outstanding • 6% actively seeking to replace package, with 0% citing unsatisfactory performance as reason.

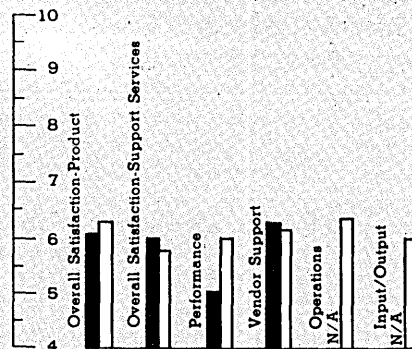

**EXECUTIVE/INFORMATION SERVICES (EIS)** • Boeing Computer Services, 7980 Gallows Court, Vienna, VA 22180 • 213-417-5010

17 responses • 18% judged package and 24% judged vendor outstanding • 65% actively seeking to replace package, with 0% citing unsatisfactory performance as reason.

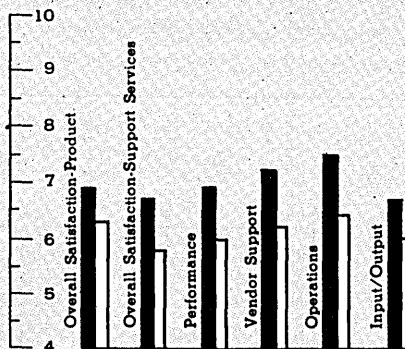

**INVENTORY & PURCHASING SYSTEM** • Management Sciences America (MSA), 3445 Peachtree Road, NE, Atlanta, GA 30326 • 404-262-2376

31 responses • 3% judged package and 10% judged vendor outstanding • 19% actively seeking to replace package, with 0% citing unsatisfactory performance as reason.

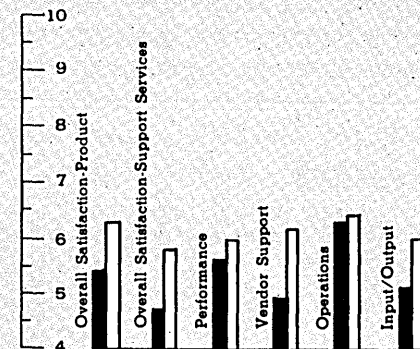



## EVERY INCH A SHOWMAN

The old warehouse has a market atmosphere, both convivial and unpretentious. Half the floor is strewn with desks that are heavily laden with paper, personal computers, and telephones. Behind each desk is somebody busily buying or selling this company's staple fare—used computers. Nearby, other employees are packaging and shipping an assortment of DECs, Fortunes, and IBMs—no longer “virginal,” but still highly prized.

The two sections are not partitioned or enclosed. Workers mingle freely and appear industrious and purposeful. Around them the walls are aglow with catchy reminders of what American Used Computer Corp. is all about. “In our job, the customer is king,” says one poster depicting him as a contented lion. The message of another is that “Happiness is a positive cash flow.” One suspects that the prompts are superfluous and, in any case, were long since committed to memory, later to emerge as conditioned reflexes.

All employees at this Boston-based concern perform with the coordination of a well-drilled platoon. And, in the center of the floor, screened inevitably by his beloved house plants, is the man chiefly responsible for this well-scripted scene: Adolf F. Monosson, known to all and sundry as Sonny.

From the license plate on his blue BMW (which reads USED) to the theatrical bow tie and red suspenders, Sonny Monosson is every inch the showman. His is the classic comic's face: chubby and cherubic, pliant and sensitive. Add his twinkling blue eyes, unfashionable crew cut, and round-shouldered stoop, and a vision of a bygone age of musical comedy and burlesque begins to emerge. But it's just a front, a mask.

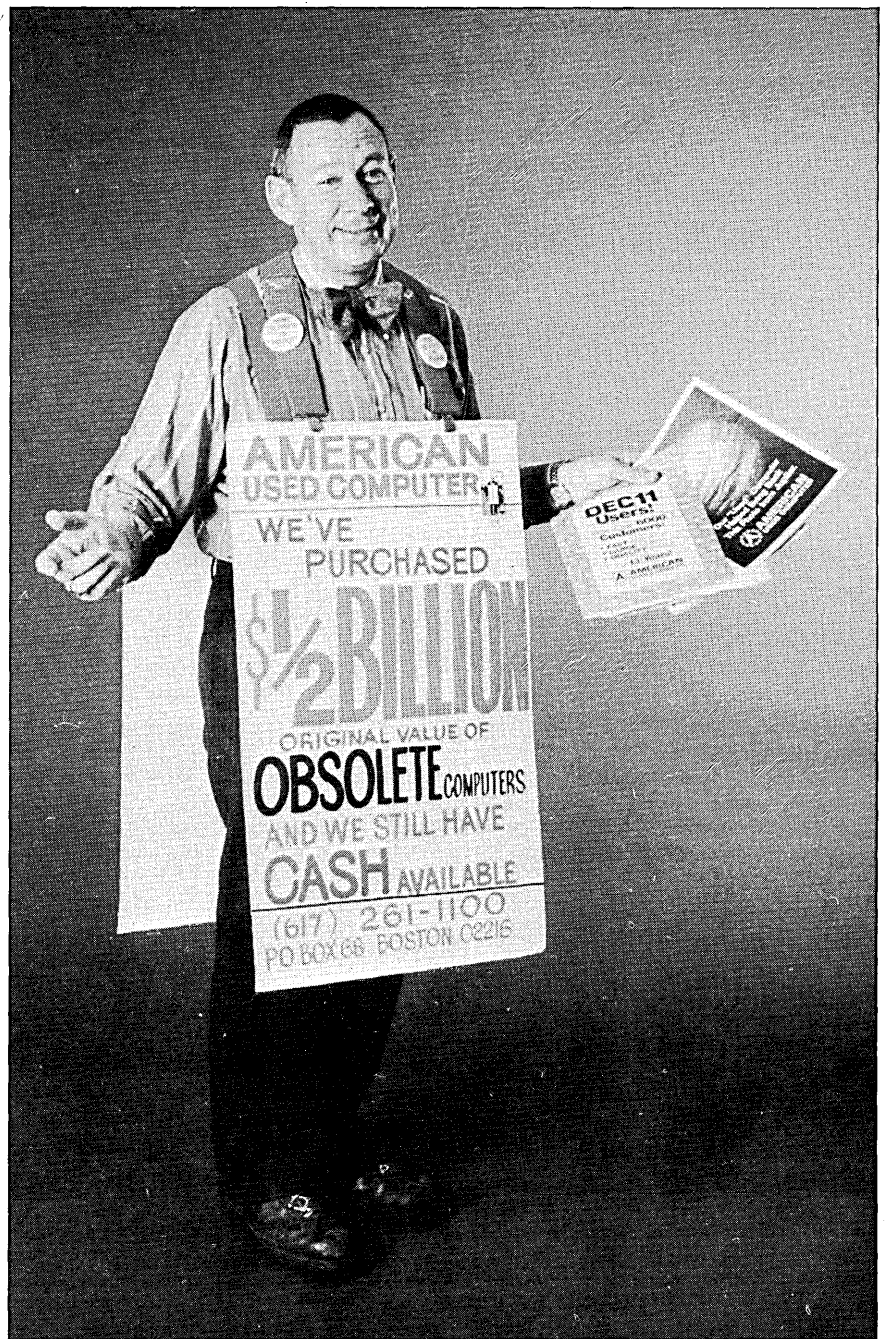

Sonny Monosson: “Happiness is a positive cash flow.”

## PEOPLE

As George Bernard Shaw put it: "When a thing is funny, search it for a hidden truth." In Monosson's case, the comic exterior hides a shrewd and analytical mind, and a keen observer of people.

Sonny's father, a progressive union leader, got into the habit of dragging his adolescent son into his labor negotiations. "I started to get interested in how people talk to each other," Monosson remembers, "and I became fascinated by their ability to say one thing and mean something entirely different." The experience led Sonny to a lifelong interest in semantics, the study of meaning, and proved invaluable when he later came to launch a string of risky but lucrative business ventures.

The first of these, Berkeley Finance Corp., specialized in lending millions of dollars at short notice to clients that the commercial banks wouldn't touch with a barge pole. Monosson lent to his clients on the basis of their accounts receivable or on inventory, something a bank couldn't do because a debt owed is not collateral. Sonny took the risk that his clients would be paid, and he lent to them at double the usual bank rates for doing so. He always had plenty of customers and "our fair share of duds, too," he says from behind a cheesy grin. "I learned from the failures that you have to understand exactly what the client thinks and means, the level of abstraction that his mind works on. Many times," he chuckles, "what he perceives doesn't exist, and you develop a feel for this. I've since made it a policy never to do business with people whose motivation I don't understand."

High risk was again a major factor when, in the late '60s, Monosson sold Berkeley and plowed his wealth into the fledgling used computer market. During the '70s his company spearheaded a boom that took the market from virtually nothing to a multibillion dollar industry supporting hundreds of dealers and brokers across the country. "There's always been an allure about this business, an aura of easy money. Part of the attraction is the low cost of entry. A telephone is all that is needed."

"But," Monosson adds, ominously, "947 companies have gone out of this business in little more than a decade. That's an annual turnover rate of more than 90 companies per year, or an annual turnover rate of almost 30%!"

"You come to realize that it's a service business. There's much more to it than just selling high-priced, obsolete junk. You have to take care of your customers."

Monosson appears to have prospered through a combination of sound instinctive business judgment—which he believes he inherited from his family—and the fruits of his own analytical mind. But as with many "cerebral" people there have been other factors that help offer stability in

the face of so much risk.

A quick glance around his sun-filled warehouse reveals that dollars aren't the only green things to grow easily under his touch. "All of my ventures since the '50s have begun by planting something," he says pointing to a monstrous dracaena bush that was first potted in 1956 when Berkeley was started. All his plants have flourished and add a lush, tropical contrast to the boxes and desks.

Unlike many other "thinkers," Monosson also indulges in a rigorous exercise program that, in addition to gardening outdoors, has included hiking, skiing, hockey, and squash. But more than anything else, the major stabilizing force has been his wife, Gloria, and his four daughters. Though Monosson exudes the easy assurance of the self-made man, "Much of it comes from being pampered by being the only male in a house full of females."

Employees will tell you that Monosson's family means more to him than anything else, and that he is devoted to them. But, by Monosson's own admission, he is not easy to live with. "Luckily for me, my wife was a doctor's daughter, and got used to her father being called out at all hours of the day and night." Sonny professes to a few inconvenient habits of his own. Like many successful or driven personalities, he seems to require little sleep. Though once an eight-hours-a-nighter like everyone else, he trained himself to get by on only four hours. Now, after a full working day among the potted plants and personal computer retreats, Monosson goes home for an evening meal before getting down to some of his most "productive" work between 10 p.m. and 2 a.m.

One recent focus for his efforts has been the autobiography that he's writing. Entitled *If You're Going to Live, You Might as Well Enjoy Yourself*, it's an anecdotal account of his life's twists and turns.

"Things look good right now," he says, casting a fatherly eye around an operation that now runs to hundreds of millions of dollars a year and caters to over 6,000 customers. "See that chubby guy over there?" he asks, peering around his jungle palms. "He's our top salesman. He earned himself around \$300,000 last year."

"That girl," he continues, swinging his finger in an arc, "was a typist with no sales experience. Many of them are like that. I train them, and now they're earning between \$80,000 and \$125,000 a year."

Sonny claims that much of his company's success has come from taking care of the little things. "We're likely to get a call at four on a Friday afternoon from some client desperate for a 16K memory for a PDP-10. We keep our people well into the night to prepare the paperwork and make sure the unit is on an airplane and at the user's site the next day."

"A typical example is the time a baggage terminal at Dallas went down because a module had failed in the PDP-11 controller. Baggage was backing up all over the place. It was a Saturday. And DEC couldn't help," chuckles Monosson. "One of our people went to the warehouse, pulled a module out of one of our existing machines, and an American Airlines employee came and picked it up."

"Our clients never forget the little things we do for them, and they often reward us with big contracts," he says.

Despite his current optimism, change is in the wind, and he could be ready to add a new twist to his autobiographical narrative. "The used computer business has topped out at around \$2.8 billion. From now on it will decline—maybe even precipitously. The technology is driving the price of new systems down so fast that used equipment will no longer be an attractive alternative." Monosson adds that used computers today often sell for less than 50% of new equipment prices.

He plans to gradually ease out of the used computer business and diversify into computer terminal leasing, used software, and publishing. A step in this direction is his three-year-old newsletter, *Monosson on DEC*, which, in the best Monosson tradition, capitalizes on more than 100 technical oems, 100 commercial oems, 50 terminal distributors, and numerous suppliers that he has conducted business with as the largest dealer in used DEC equipment. In fact, Monosson's information on DEC has seemed so trustworthy, say company insiders, that DEC believes it can be coming only from the highest levels of the company. Sonny's reply to this is "Rubbish!"

It's already clear from the newsletter's success that Sonny is using the same maxim of "the customer [in this case, the reader] is king." Already, another newsletter, possibly on plants, seems to be taking shape in Monosson's fertile brain. With his winning combination of being materially expansive and financially farsighted, could a new publishing empire be on the horizon?

Monosson acknowledges the thought with a sly wink, and releases another of his winsome smiles. Behind the vaudeville mask his mind is busily engaged once more: analyzing, probing for meaning . . . remembering. "It's funny," he says, "when I started my first business I had Gloria, two kids, and an apartment. You know, I never gave security a second thought, and it seems to me that risk has been a factor all of my life ever since."

You can sense the excitement growing in him once again, the restlessness. Perhaps that's the real charm of this man that everyone calls Sonny: his childlike openness and his eternal desire to press on and find a new game.

—R. Emmett Carlyle

# Computer Security

You know it's important,  
but you haven't had  
the time or the funds  
to implement it.

Here's an opportunity  
to get started...for just  
the price of a stamp.

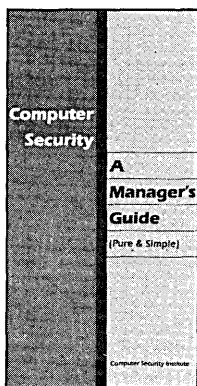

**Computer Security Institute**, Dept. DG-4  
43 Boston Post Road, Northborough, MA 01532  
(617) 845-5050

Please help us get our program moving. Send me a complimentary copy of Computer Security Institute's booklet, **Computer Security: A Manager's Guide (Pure & Simple)**. I am enclosing a self-addressed business-sized envelope with \$.37 postage affixed.

Name \_\_\_\_\_  
Title \_\_\_\_\_  
Organization \_\_\_\_\_  
Address \_\_\_\_\_  
City \_\_\_\_\_ State \_\_\_\_\_ Zip \_\_\_\_\_

# CUT YOUR COBOL TEST AND DEBUG TIME... AND YOUR COST!

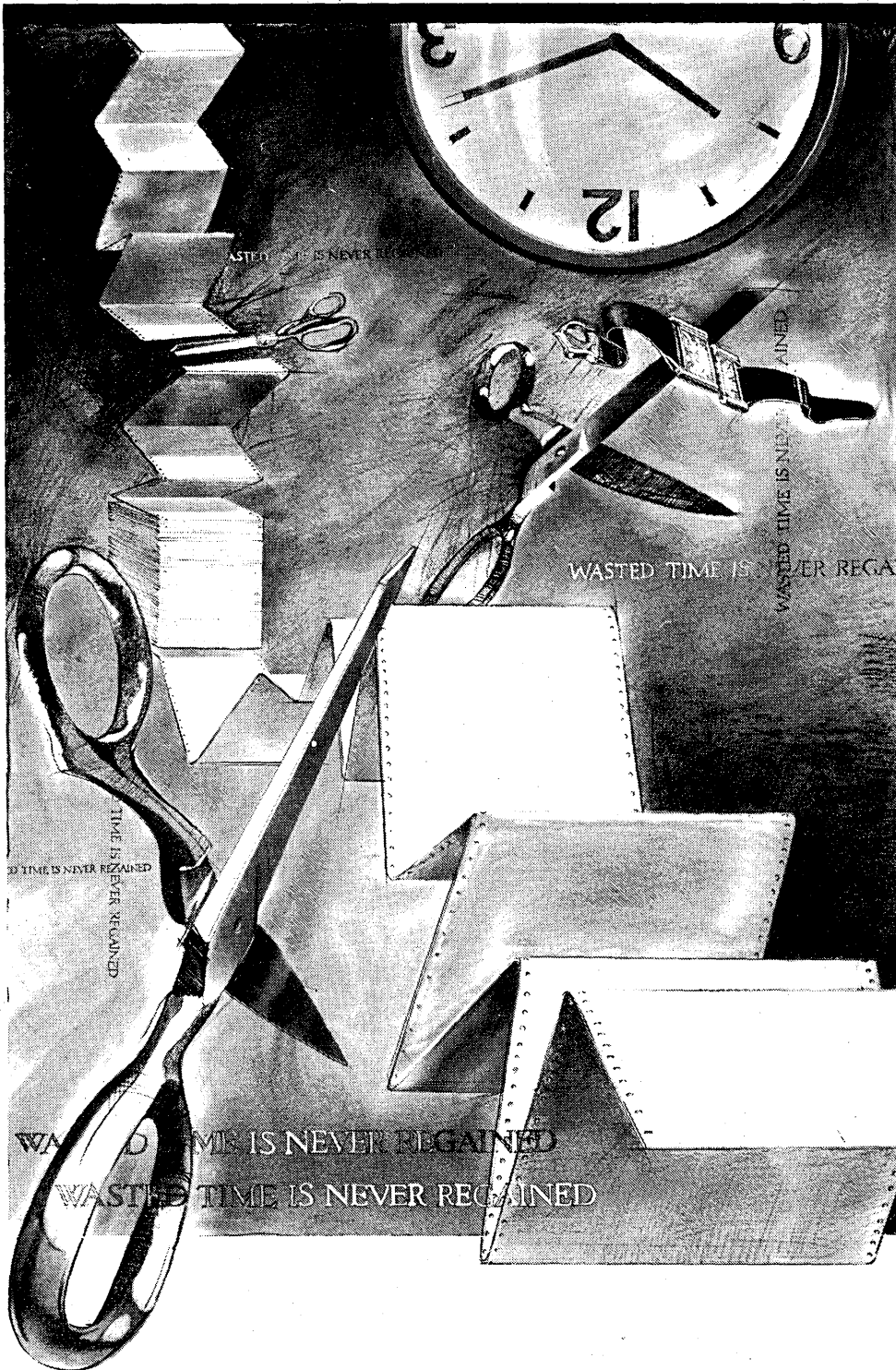

**X**PF/COBOL is the first full screen, interactive, SPF-like debugging tool on the market. It delivers a complete window into COBOL programs.

**XPF/COBOL enables the user to:**

- Watch the programs execute—forward or backward.
- Find and change COBOL data in COBOL format.
- Debug IMS programs.

**XPF/COBOL:**

- Slashes test and debug time.
- Increases programmer productivity
- Is easy to learn and easy to use.

**X**PF/COBOL can pay for itself in months.

**C**all your nearest Boole & Babbage sales office below, or send in the coupon for complete information and user references.

Send me information on XPF/COBOL.

Name \_\_\_\_\_

Title \_\_\_\_\_

Company \_\_\_\_\_

Address \_\_\_\_\_

Send to:  
Boole & Babbage  
510 Oakmead Pkwy.  
Sunnyvale, CA  
94086

**Boole & Babbage**

The Information Resource Management Company

6

Los Angeles, CA (213) 642-7560  
Sunnyvale, CA (408) 773-8811  
Atlanta, GA (404) 395-1264  
Chicago, IL (312) 629-8910  
St. Louis, MO (314) 434-5100  
Englewood Cliffs, NJ  
(201) 461-6006  
Dallas, TX (214) 385-8076  
McLean, VA (703) 448-9194

# HARDWARE

## OFF-LINE

The American proverb, "Look before you leap," apparently is not taught in France -- at least not where executives of Jeumont-Schneider are concerned. The French telecommunications and railroading giant recently held a press conference in New York's posh Helmsley Palace hotel to introduce its line of PBX equipment to the American market. The company admitted that its line of analog PBXs is, at best, "comparable" to similar products that have been on the market here for several years. Its service and support plan was "equal" to those proffered by American competitors, and its price "lower" than other similar equipment. Yet Henri Sulzer, president of the company's U.S. spin-off, J.S. of America, declined to quote any specific pricing information. While Jeumont-Schneider may not have had too much trouble selling 45,000 Jistel telecommunications systems in Europe, where the French government in particular looks kindly on French-made equipment, it certainly will not have the same success here. Entering the crowded and competitive PBX market with a small analog unit that is barely distinguishable from domestic products is hardly the way to make money. Sulzer and his colleagues seem to have jumped into America without the required foresight or marketing plan.

Compare Jeumont-Schneider's splashy but ill-equipped entry into the U.S. market with that of Fuji, the Japanese subsidiary of Fujitsu that recently introduced its uninterruptible power system into this country. The UPS is technically superior to the vast majority of domestic UPS products because it relies on transistors rather than on the conventional thyristors. The result is a much

lighter, cooler, and quieter UPS that can be installed in the computer room on a raised floor instead of in the basement on a concrete slab. The company chose a more subdued way of bringing the product into the U.S. market. Rather than set up an entire U.S. subsidiary just to assemble and market the product, as J.S. of America does, Fuji appointed Triad Power Systems of Dallas as its U.S. distributor. The arrangement saves Fuji the effort of setting up shop here and gives Triad, a recognized UPS vendor, a more competitive product without high R&D costs.

While Triad's switch from thyristor to transistor technology represents something of a revolutionary jump in an area of the industry that has not changed much in decades, the disk drive technology continues to evolve more gradually. Witness 3M's recent showing of its prototype "Keystone" disk media. The disks represent something of a cross between floppy and fixed disk drives, and are analogous to a drum in their construction: a rigid plastic substrate has raised rims at the outer perimeter and near the center holes; a flexible medium is then stretched and bonded to the rims. The resulting double-sided disk is still flexible, but it is held rigid by the plastic 10 mils below the disk. The prototype 5½-inch disks can hold 5MB of data, company executives say. The head flies above the flexible substrate as in rigid disk technology, but the medium's flexibility creates a dimple at the site of the head to help cast out debris that might otherwise cause read or write failures. 3M has shown the disk to several U.S. disk drive manufacturers, although none has yet said that it would build a disk drive for the Keystone disks. Production disks will be out this year.

## PLOTTER

The HP 7586B roll-feed drafting plotter is designed for multi-user, high-volume environments. It is designed to handle cut sheet media from A4/A through AO/E sizes and roll media from 10.5 in. to 36.2 in. wide by 150 feet long; media types include paper, vellum, double-matte polyester film, and tracing bond.

The plotter can draw frame to frame long-axis plots up to the length of the roll medium, by using a technique of plotting a series of 48-inch back-to-back plot segments. A built-in optical sensor enables the plotter to align each subsequent segment to the previously plotted segment.

The HP 7586B offers 21 character sets, an 18KB partitionable buffer, polygon area-fill instructions, downloadable character sets, and block-mode data transfer with the RS232C interface. Each of the character sets is available in three fonts. The character sets include Japanese Katakana and European characters, as well as mapping symbols, special centered symbols, and other symbols.

The plotter has an addressable resolution of 0.025 mm and a mechanical resolution of 0.003 mm. It plots at 24 inches per

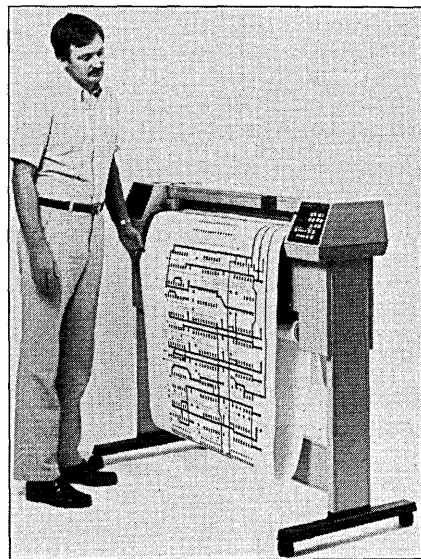



## HARDWARE

second with 4g acceleration. Fiber tip, drafting, and rolling ball pens are all accepted; the plotter automatically adjusts pen speed and force appropriately. An eight-pen carousel is provided to hold pens not in use. The plotter costs \$21,900. HEWLETT-PACKARD CO., Palo Alto, Calif.

**FOR DATA CIRCLE 301 ON READER CARD**

### COMMUNICATIONS SERVER

The CS/100 communications server is designed to link an Ethernet local area network to up to 10 devices using the RS232C interface. The product supports Xerox Network System high-level network protocols. It can act as a terminal server, a cluster controller, or a host front-end communications controller. It is fully compatible with the vendor's GS/1 Ethernet X.25 gateway and GS/3 Ethernet-to-Ethernet point to point gateway.

The CS/100 provides transparent interconnection of serial multivendor computer systems and peripheral devices over an Ethernet LAN by using packet switched virtual circuits in order to share data and resources. Connection is established

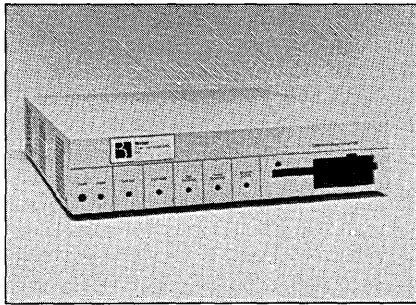

through a command interface that uses menus and help facilities. Connection requests use a logical name and executable single line command files constructed from any sequence of user interface commands. Network security is provided by an access control mechanism with password protection for specified ports.

The product provides network management functions such as collection of performance statistics, error logging, and port use. Multiple open virtual circuits per port are supported. The CS/100 uses a VLSI Ethernet chip and a multiple MC68000 microprocessor design that permits the transfer of up to 125 packets per second for interactive applications and 600KBps for file transfers. The product is priced between \$3,900 and \$4,900. BRIDGE COMMUNICATIONS INC., Cupertino, Calif.

**FOR DATA CIRCLE 302 ON READER CARD**

### SUPERMICROS

The Universe 68/35 and 68/67 supermicrocomputers are based on the MC68000 microprocessor running at 12.5MHz. They incorporate a 32-bit VERSAbus for I/O, 32-bit main memories, 32-bit disk channels, and a 32-bit, 4KB cache memory.

The 68/35 has a 5¼-inch Winchester disk drive with a formatted capacity of 35MB. Its 3MB main memory can support 64 users. It also uses an integral 8-inch double-sided, double density floppy disk drive for program loading and backup storage. The 68/67 uses an 8-inch Winchester disk drive with a formatted capacity of 64MB. A built-in 45MB streaming tape drive provides system backup. The model comes with 512KB

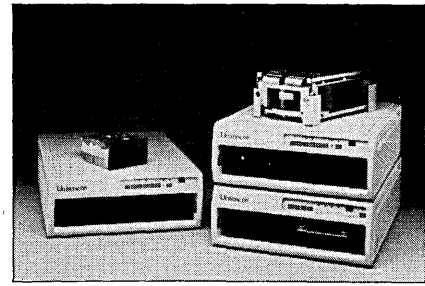

of main memory, which can be expanded to 5MB.

The 68/35, with a basic 512KB main memory, costs \$14,900. The 68/67, with the same main memory, costs \$24,900. The products are designed for transaction-oriented applications and for very large computational applications, the vendor says. The two supermicros run the UNOS real-time operating system and support the Unix operating system. CHARLES RIVER DATA SYSTEMS INC., Framingham, Mass.

**FOR DATA CIRCLE 303 ON READER CARD**

### DOT MATRIX PRINTER

The MT-440 multifunction serial dot matrix printer is designed for use in minicomputer and high-performance microcomputer applications. The printer runs at 400cps in draft mode and 100cps in a letter-quality mode. A bar code printing model is available, with a 270cps speed.

The printer has a tabbing feature that allows the printhead to travel at speeds of up to 650cps when bypassing blank portions of a line. Combined with vertical paper advance and printhead turnaround speed, the tabbing feature enables the printer to complete a page of single-spaced text in 10 seconds, the vendor says.

The printer uses a paired tractor paper handling system in which one set of tractors pulls paper from the rear feed opening into the printing area and another set pulls the paper from the printing area into the output bin. Bottom feed and friction feed for single sheet and letterhead printing is also provided as a standard feature.

The unit uses a 7 × 9 dot matrix for draft-quality print and an 18 × 40 matrix in the correspondence-quality mode. It can print at 10, 12, or 16.7 characters per inch, or in dot-addressable graphics. A sound-dampening lid keeps noise to 57db, the ven-

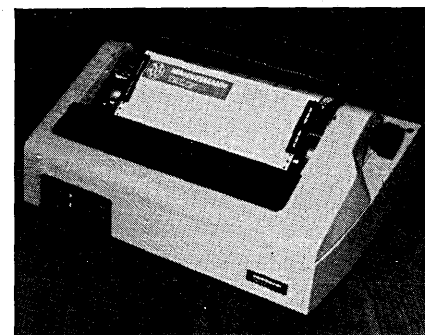

## HARDWARE SPOTLIGHT

### DATABASE COMPUTER

The DBC/1012 database computer system offers fault tolerance and the capability of handling trillion-byte databases. The product uses a parallel architecture that processes data asynchronously using up to 1,000 independent microprocessors. If one of these subsystems fails, another takes its place automatically. The microprocessors communicate with each other and with disk storage via the vendor's Ynet network.

Interfacing the DBC/1012 to the host mainframe is the interface processor (IFP), which translates host requests into internal commands and forwards them to the access module processors (AMPs) via Ynet. The IFP also coordinates responses in the reverse direction. When the AMPs receive the host requests, they perform the required data manipulation activities and send appropriate responses to the host via the IFP. Associated with each AMP is a disk storage unit. One section of disk space is allocated to the system area that is used primarily for resident system programs and tables. A second section is the primary data area that stores

the primary copy of data and is accessed under normal conditions. The third area is the fallback copy section that is accessed if the primary copy is unavailable.

The unit comes with a system console that can be connected to any IFP or AMP. It allows the operator to communicate with other processors over the Ynet. Both the IFP and the AMP use cpus consisting of the 8086 microprocessor and the 8087 numeric coprocessor. Memory modules for each cpu contain 2MB of RAM and ECC. Ynet memory contains 32KB of high-speed RAM to buffer message blocks.

Embedded software includes the Tequel query language for the definition and manipulation of data, the Iteq interactive query facility for nontechnical users, a relational database management system, and a library of access routines. The DBC/1012 costs \$480,000 for a basic system with six processors running the equivalent of 2.5 MIPS, 12MB of memory, 1.9GB of off-line storage, and software. Additional processors cost \$60,000 per MIPS.

**FOR DATA CIRCLE 300 ON READER CARD**

# Here's Why Precision Visuals Is Now The Leader In Graphics Software Tools!

## One Program Drives Many Devices

This single advantage can save you hundreds of hours of programming time. It enables you to use your hardware (both host computer and graphics devices) to its fullest. It protects your software investment against obsolescence and frees you from exclusive ties to hardware vendors.

Precision Visuals currently offers tailored interfaces for over 70 graphics devices from the leading graphics hardware companies, including: AED  BBN  Calcomp  Calcomp lookalikes  Chromatics  DEC  Digital Engineering  Envision  Hewlett-Packard  Houston Instruments  IBM  Lexidata  Logic Sciences  MAGI  Megatek  Printronix  Ramtek  Raster Technologies  Sanders  Selanar  Tektronix  Tektronix lookalikes  Trilog  Versatec  Visual Technology  Xerox  Zeta.

## They Run On Most Popular Computers

Including IBM, VAX, Hewlett-Packard, CDC, Prime, Honeywell, Data General, Cray, DEC PDP-11, Apollo, and many Unix-based micros.

Precision Visuals software tools require a surprisingly small amount of computer resources. Even on 16- or 32-bit micros they provide access to the capabilities of evolving graphics standards.

*"DI-3000 and GRAFMAKER have provided us with the graphics toolbox concept we had been looking for to service our timesharing customers. Resource management is critical in a timesharing environment, and we are especially impressed with the modest memory requirement and execution efficiency of both packages."*

Dr. Richard R. Socash, President  
Research Information Corporation  
Founder, TENTIME Timesharing Services

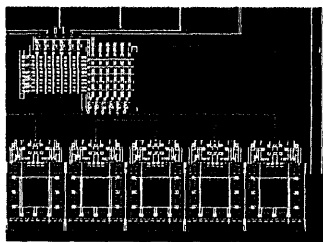

*Programmer-friendly tools  
for computer-aided design*

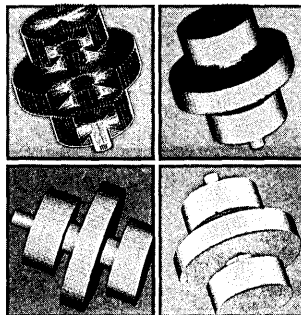

*Real world modeling  
using 3D and color*

## Rich Capabilities Mean Limitless Applications

Precision Visuals' software tools are the proven graphics standard in major industries including aerospace, energy, communications, engineering, government, and education . . . for applications such as computer-aided design, business graphics, process control, mapping, geological data analysis, and document layout. System integrators (OEMs) use them as the graphics nucleus in scientific/engineering systems and as the graphics component of data base management and financial modeling systems.

## The Best Support in the Business

DI-3000®, our basic tools package, is the preferred solution for your graphics development because we've learned what customers expect and need in support. Documentation is the key. Example intensive programming guides, quick

reference cards, and step-by-step tutorials get you through development and into production fast. We also support active international and regional user groups, and a telephone Helpline staffed by graphics software specialists. Our seminars and courses help get your graphics applications operating on time and within budget.

Find out how Precision Visuals' graphics software tools can open a new world of flexibility, economy, and standardization for your graphics applications. Call us at 303/530-9000.

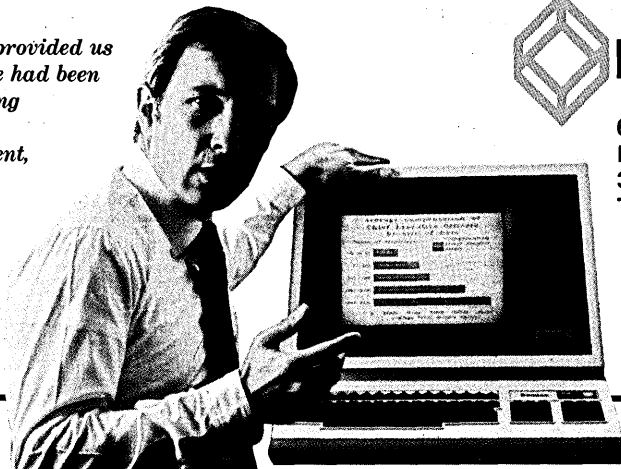

**Precision Visuals**

6260 Lookout Road  
Boulder, Colorado 80301 USA  
303/530-9000  
TELEX 45-0364/TWX 910-940-2500

CIRCLE 128 ON READER CARD

## HARDWARE

dor says. The MT-4401, which produces only draft-quality output, costs \$2,400. The MT-440L, which adds letter-quality capability, costs \$2,700. The MT-440D, which prints OCR and bar codes, costs \$3,000. MANNESMAN TALLY, Kent, Wash.

**FOR DATA CIRCLE 304 ON READER CARD**

### GRAPHICS CONTROLLER

The Graphcard 100 graphics controller implements Graphic Software Systems' GKS virtual device interface on the IBM Personal Computer or PC XT. Applications include Tektronix 4010 terminal emulation. The board runs existing IBM and third-party software by emulating and replacing IBM's monochrome and color graphics adapter boards. Standard features include serial and parallel printer ports and a serial modem port.

The unit uses the 80186 coprocessor to provide  $720 \times 352$  pixel resolution and variable intensity levels. It has a multitasking operating system to output text and graphics to dot matrix printers while other application functions are executing. The concurrent rasterization and application processing enable the supported printers to generate output at high resolutions in formats up to  $11 \times 14$  inches, the vendor says, eliminating low-resolution screen dumps.

The product comes with bindings for C, FORTRAN, Pascal, and 8088 assembly run time libraries, to allow programs written in those languages to call GKS functions for execution. The product supports Epson MX80/100 and FX80/100 printers, as well as IBM graphics printers, C. Itoh Prowriters, IDS P series printers, and Okidata 84, 92, 93, and 94 printers. Graphcard 100 costs \$1,250. CONCEPT TECHNOLOGIES INC., Portland, Ore.

**FOR DATA CIRCLE 305 ON READER CARD**

### SECURITY

The DCP4010 and DCP4015 data security units are designed to protect against unauthorized access to data transmitted over telephone lines and to eliminate transmission errors for users of asynchronous terminals. The devices are installed at each end of the data link. Typically, the DCP4010 originating unit is installed at the remote site between the terminal and the modem. The DCP4015 answering unit is installed at the central site between the host computer and the modem.

Each unit is programmed with a four-digit code. If the originating unit code does not match the answer unit code, the answer unit will not respond. The originating unit is programmed by the vendor through four thumbwheel switches, and the answer unit is programmed by the vendor with four DIP switches.

The units are designed to protect against transmission errors by performing a cyclic redundancy check on data in a tem-

porary buffer. When errors are present, the data is retransmitted and rechecked. The buffer is 16K and can protect a fully loaded 2,400bps line during a 50-second power outage, the vendor says. The units also have a buffer overflow capability in which an Xoff signal is transmitted when the buffer approaches capacity. The unit automatically permits transmission to resume when the buffer load is below 85% of capacity. The DCP4010 and DCP4015 cost \$750 each. DATATEL INC., Cherry Hill, N.J.

**FOR DATA CIRCLE 306 ON READER CARD**

### ENTRY MICRO

The B95 entry level microcomputer system uses modular packaging so that end users can install the product without support in basic configurations, the vendor says. The product is compatible with the vendor's terminal-based CMS systems, including the B96, B930, B1900, and CP9500. Typical uses for the system are budgetary accounting, inventory management, patient accounting, payroll, and asset management.

The B95 comes with a software package called Superstart, which presents the operator with a series of menus to guide the use of the system. The B95 consists of three basic units that in total weigh 22 pounds. These are the power supply unit, a processor module, and a storage module. An extra storage module is optional. The system runs on standard current.

Each of the modules is 14 inches tall and 7 inches wide, so that the system can operate in a standard office environment with no special cooling requirements. It can be used as a desktop system, freestanding, or on a shelf. The B95 comes with a maximum of 512KB of main memory and 28.8MB of disk storage. Both Winchester and floppy 5 $\frac{1}{4}$ -inch disk drives are supported. The system starts at \$18,400. BURROUGHS CORP., Detroit, Mich.

**FOR DATA CIRCLE 307 ON READER CARD**

### OPTICAL DISK

The model DC301 optical disk can store 1.5GB of data on a side or 2.6GB if both sides are used. The product records at a track density of 16,000 tpi and a bit density of 19,500 bpi. The disk's bit error rate is equivalent to that of magnetic disks, the

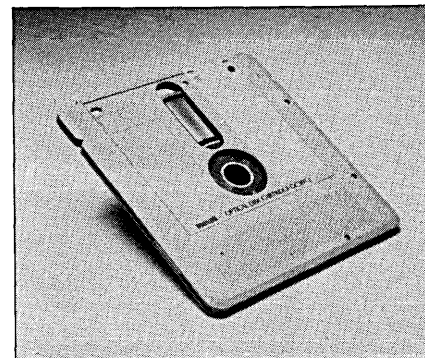

vendor says. Recording is done by sectors to facilitate random access.

The product is a joint development of Hitachi and this vendor. Shipments of the product are slated to begin next month, with the single-sided disk tagged at \$200 and the double-sided disk priced at \$300. The disk comes in a protective case which slides open when the disk enters a front-loading drive.

The disk can be used with Hitachi's Hitfile 60, an optical storage subsystem designed for document filing and mainframe archiving. The 12-inch disk can be used to store images as well as alphanumeric data. MAXELL CORP. OF AMERICA, Computer Products Div., Moonachie, N.J.

**FOR DATA CIRCLE 308 ON READER CARD**

### TERMINALS

All three models of the VT200 line of terminals include nonglare monitors with built-in tilt, reverse video, and character highlighting. The terminals use cursor-driven, menu-mode setup selection processes that



are available in English, German, or French. Each model has an automatic screen dimmer, 15 programmable function keys, a selective screen erase, an RS232C port, downline loadable character sets of 94 characters, and a multinational character set. All models are fully compatible with the vendor's previous VT100 models.

The VT220 is a two-piece monochrome text unit that can use white, green, or amber screens. The VT240 adds bit map graphics capabilities for business graphics applications. The monochrome terminal supports the vendor's REGIS instruction set and is compatible with Tektronix 4010/4014 protocols. The terminal is a three-piece assembly, with the system logic housed in the third unit.

The VT241 has the text and graphics features of the VT240 terminal, with the addition of a color display. The unit is a three-piece assembly with a 13-inch color display rather than the 12-inch monochrome monitor. It supports RGB output to color cameras or auxiliary monitors, and has an optional auto-dial, auto-answer internal modem. The VT220 costs \$1,300, the VT240 costs \$2,200, and the VT241 costs \$3,200. DIGITAL EQUIPMENT CORP., Maynard, Mass.

**FOR DATA CIRCLE 309 ON READER CARD**

# DIMENSION. THE MOST POWERFUL, MOST COMPATIBLE PERSONAL COMPUTER YOU CAN FIND YOU CAN FIND

Introducing the capability the world has been waiting for: a single personal computer able to handle Apple II™, IBM® PC™, TRS-80™, UNIX™ and CP/M™ based software.

The Dimension 68000 Professional Personal Computer does it all. It actually contains the microprocessors found in all of today's popular personal computers. And automatic innovation creates the environment that lets systems function merely by plugging in the software.

Add to this the incredible power of a 32 bit MC68000 microprocessor with up to 16 megabytes of random access memory.

Dimension. At about the same price as the IBM® PC, it's obviously the best value you can find. For more information ask your dealer or call us at (214) 630-2562 for the name of your nearest dealer.

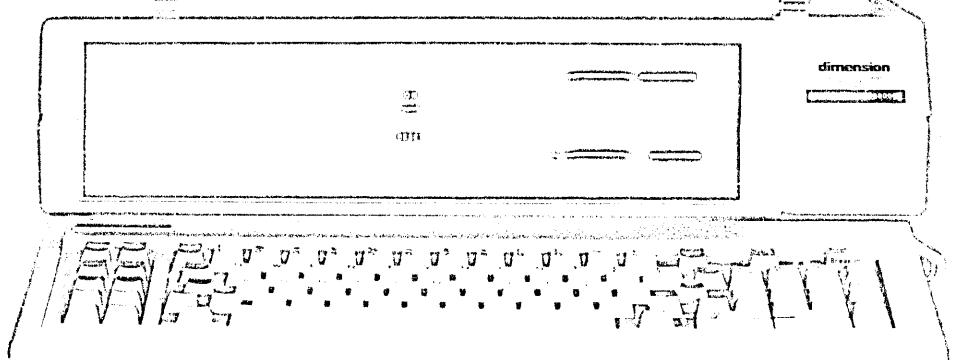
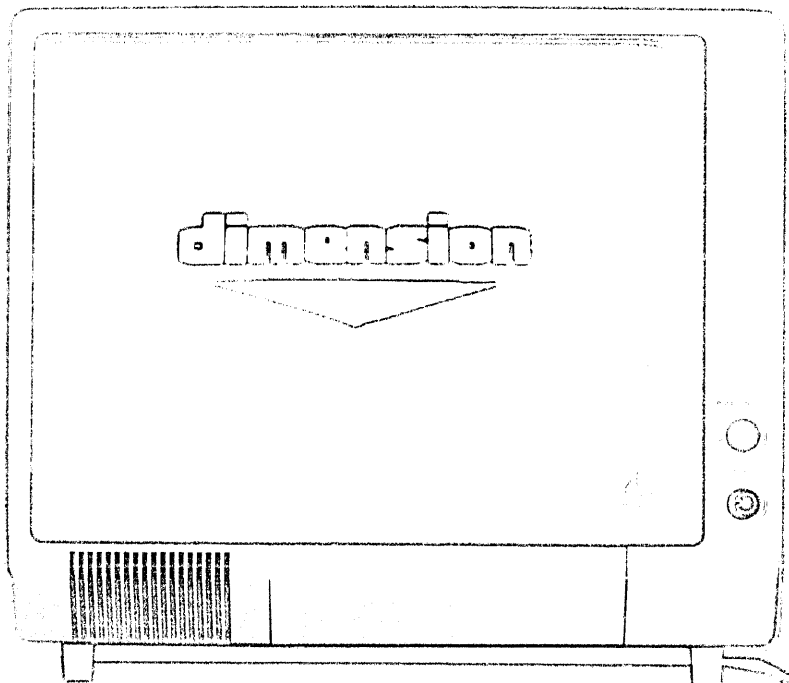

**dimension™**

**68000**

A product of  
Micro Craft Corporation  
4747 Irving Blvd., Suite 241  
Dallas, Texas 75247 © 1983

CIRCLE 129 ON READER CARD

Apple is a registered trademark of Apple Computer, Inc. IBM is a registered trademark of International Business Machines Corporation. TRS-80 is a registered trademark of Radio Shack, a Radio Corporation company. UNIX is a trademark of Bell Laboratories, Inc. CP/M is a registered trademark of Digital Research Corporation.

## HARDWARE

### POS MICRO

This personal retail computer is designed to combine a retail management POS system with a personal computer. The product consists of the vendor's personal computer with an electronically operated cash drawer and

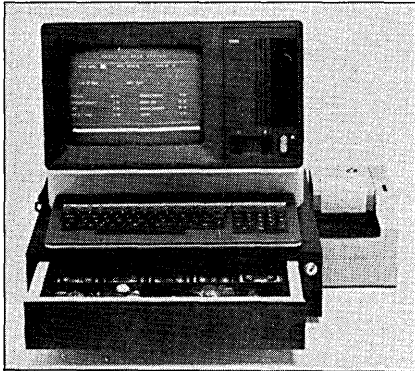

point-of-sale and inventory management software. Forty-column receipt/journal printers or 80-column report printers are also available for the machine.

The point-of-sale software provides sales invoicing or ticketing as well as sales reporting by salesperson and item. The unit guides salesclerks through each transaction. Nine function keys are designed to simplify transactions and reduce keying errors. The inventory management software can store 19 different facts about each of 32,000 unique inventory items. Inventory levels are automatically displayed and adjusted during each sale. An identification number verification is included to prevent unauthorized access, and a password protection scheme protects sensitive sales information.

Personal computing applications include word processing, electronic spreadsheets, general accounting, and database management. The system is available in two configurations, each of which has the personal computer with cash drawer, dual 8/16 bit processors, 256KB of RAM, operating system, and POS software. The first configuration also has a pair of 5¼-inch floppy disk drives, and costs \$5,000. The second has a single 5¼-inch floppy drive, a 10MB hard disk drive, and both POS and inventory management software. It costs \$7,900. NCR CORP., Dayton, Ohio.

**FOR DATA CIRCLE 310 ON READER CARD**

### UPS

The GPS-3K 120 series of on-line uninterruptible power systems is rated at 3,000 volt amps and is designed for use with most minicomputer-based systems. The unit can operate from a 120VAC 60Hz utility power line, with backup provided by sealed, maintenance-free batteries. In the event of a line disturbance or power failure, the UPS will provide power-conditioned, regulated, and continuous power to the load.

The product comes with two AC

voltmeters for monitoring input and output voltage, and an output ammeter to measure load current. Indicators are situated on the front control panel of the unit. An audible alarm is also provided to inform the user of changes in the operation status of the UPS. Options available include an RS232C port for communications with a computer, additional batteries (an 84VDC battery is standard), and a solid state bypass switch for supplying high temporary inrush currents. Users can select from models specified at 120, 208, 220, or 230 input and output voltages. Two models are also available for 50Hz current. GENERAL POWER SYSTEMS, Anaheim, Calif.

**FOR DATA CIRCLE 311 ON READER CARD**

### NETWORK CONCENTRATOR

The 4470 network concentrator is designed to allow users to communicate with private and public X.25 data networks and computer systems using SNA. SNA/SDLC users can gain access to host applications in a manner that treats the intervening X.25 network as transparent to both host and terminal.

A user-specified call-capable keyboard display can request a host on the network through menu selection. All logical units on the cluster controller serving that call-capable display are then connected to the requested host through a single virtual circuit. Other clusters served by the 4470 may be connected to the same host or to different hosts on the network. The support is available for single cluster lines or multi-drop lines.

A single 4470 can be connected to up to seven X.25 links. When multiple links are provided to a single network, the 4470 automatically loadshares calls over available links. Links may also be made to different networks. The product interfaces to the IBM NCP packet switching interface software in the host communications processor. It is fully compatible with NCPI release 2 or greater. AMDAHL CORP., Sunnyvale, Calif.

**FOR DATA CIRCLE 312 ON READER CARD**

### MAINFRAMES

The 1100/73 and 1100/74 multiprocessor mainframes use 64K chip technology for modular semiconductor storage. The machines are fully compatible with other models in the Series 1100 family. All the main storage in the 1100/73 and 74 models is contained in external cabinets, and is expandable to 32MB. Each external main storage unit has a memory capacity of from 4MB to 16MB. A high-speed buffer memory is also available.

Multiple cpus and input/output processors are housed in a single cabinet. The systems support common access to most system components in multiple cpu-I/O processor configurations; independent I/O processors; byte- and word-oriented I/O chan-

nels; system partitioning; and peripheral switching.

The 1100/73 cpu, with 4MB of main memory, costs \$1,052,710. The lease price for the same configuration on a five-year agreement is \$26,625 per month with a monthly maintenance fee of \$6,450. The 1100/74 model, with 4MB of main memory, costs \$1,322,180. The lease price is \$33,635 per month, with a monthly maintenance fee of \$8,360. The 1100/73 model supports the Attached Virtual Processor, which aids users in switching from the VS/9 operating system to the 1100/OS operating system. SPERRY COMPUTER SYSTEMS, Blue Bell, Pa.

**FOR DATA CIRCLE 313 ON READER CARD**

### INTERFACE SWITCHING

The Selecto-Switch is designed to eliminate the need for frequent plugging and unplugging of cables connecting peripherals such as printers, plotters, terminals, and modems to host computer systems. Units range from two-way to six-way switches.

The two-way switch can be used to connect a single peripheral to two host computers, or the reverse. The switch is available for both parallel and serial interfaces. It is compatible with most micros currently on the market.

The vendor also introduced the 9000 series distributed control unit, which acts as a port expansion and contention switch. With the unit, the common device (or computer) has access to all systems peripherals while occupying only one port. Once the unit is powered, it goes into a peripheral scanning mode. Any of the peripherals can contact the computer on a first come first served basis. Once contact has been established, all other peripherals are locked out until the connected device has completed the specified task. At that time, the computer will recognize the end of transmission and return the 9000 to scanning mode. GILTRONIX INC., Palo Alto, Calif.

**FOR DATA CIRCLE 314 ON READER CARD**

### MICROCOMPUTER

The model 1000 microcomputer is designed to handle application software for transaction processing of such devices as automated teller machines, retail consumer transaction terminals, automated fuel systems, and





**ONE LANGUAGE. ONE SOLUTION.**



## **THE KEY TO INFORMATION CENTER PRODUCTIVITY.**

In today's Information Center environment the #1 application development tool is Information Builders' FOCUS. No other product offers the productivity and full range of functions provided by FOCUS...all within one nonprocedural language!

FOCUS' powerful relational facilities enable you to quickly build new systems. You can create new files within minutes using simple English commands, as well as query and report from

existing files (VSAM, QSAM, IMS, IDMS, etc.) in your Information Center.

This increases programmer productivity by hundreds of percent, and allows end users to perform their own ad hoc queries, reports, financial modeling, graphics and statistical analysis after only a few hours familiarization.

And, there's PC/FOCUS too. It expands your PC into an Information Center with the same relational database, screen manager and data

analysis facilities found in mainframe FOCUS. Plus, it enables you to download, manipulate and/or upload data extracted from mainframe files and DB's, all with full FOCUS security.

The FOCUS system. The language that unlocks productivity in your Information Center. For details write to: Don Wszolek, Dept. M1, Information Builders, Inc., 1250 Broadway, New York, NY 10001.

## **INFORMATION BUILDERS, INC.**

New York: (212) 736-4433 • Washington, D.C.: (703) 276-9006 • St. Louis: (314) 434-7500 • Chicago: (312) 789-0515  
Dallas: (214) 659-9890 • Palo Alto: (415) 324-9014 • Los Angeles: (213) 615-0735 • Houston: (713) 952-0260

Dealer inquiries invited.

# Introducing the Whizzard<sup>®</sup> 3355. Now you can break the speed limit without paying the price.

**Whizzard 3355.** Meet the Whizzard 3355, the newest computer graphics system from Megatek. Up to 400 thousand vectors per second. The fastest high speed performance of any system in its price range, thanks to our Graphics Engine.<sup>™</sup> Upward software compatibility with every Whizzard. And a high resolution color raster display with 2D real-time dynamic transformations.

Now you can have the speed you want, and pay a lot less for it in the bargain.

The Whizzard 3355 is a full-function computer graphics system that cost-effectively supports your graphics applications. Especially in the areas of mechanical or electronic CAD, simulation, or command and control. And its RS232C interface, with its own 16-bit processor and up to 512 Kbyte dedicated local RAM, offloads the host computer and allows serial communications.

The Whizzard 3355's standard features include a 19" 1024<sup>2</sup> 60 Hz non-interlaced monitor, 16 simultaneously displayable colors out of a possible 4096, complex 2D graphics transformations (rotate, translate, continuous scale, and clip), and proprietary local processor with serial interface. You also get VT-100<sup>™</sup> emulation, an ergonomic keyboard, and a host of available options. Then there's graphics software. Megatek's WAND,<sup>™</sup> TEMPLATE<sup>®</sup> and a wide variety of third party application packages, too.

The Whizzard 3355. High-speed performance, and true cost-effectiveness.

That's Megateknology.

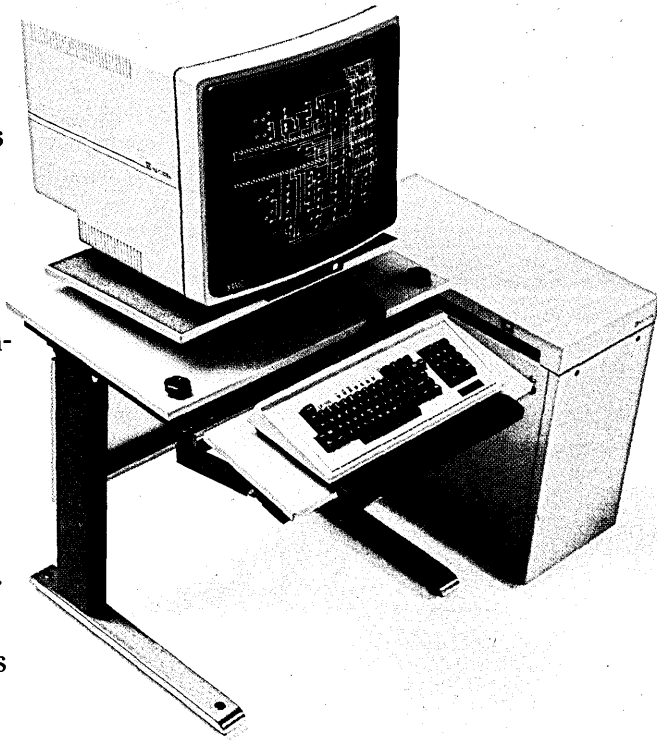

# That's Megateknology.<sup>™</sup>

**MEGATEK  
CORPORATION**  
A UNITED TELECOM COMPANY  
Making History out of State-of-the-Art

World Headquarters • 9605 Scranton Road • San Diego, California 92121 • 619/455-5590 • TWX: 910-337-1270  
European Headquarters • 34, avenue du Tribunal-Fédéral • CH-1005 Lausanne, Switzerland • Telephone: 41/21/20 70 55 • Telex: 25 037 mega ch

VT-100 is a trademark of Digital Equipment Corporation

CIRCLE 131 ON READER CARD

## HARDWARE

similar systems. It also provides office services software to support teller terminals, word processing, platform administration terminals, and environment, energy, and security functions.

The product is compatible with the vendor's current 9510 controller systems and will support all of the 9000 series terminals and networking protocols. It is based on two 80286 microprocessors—one for computation and the second for communications. The dual processor system comes with a megabyte of main memory and can be fitted with 5¼-inch floppy or Winchester disk drives.

The 1000 supports SNA/SDLC, BSC, NCR 751/279, and Burroughs Poll/Select protocols for communication with mainframes. Up to eight communication lines can be supported, with line speeds ranging from 1,200 to 19,200 bps. A compiler for C is also included to allow users to develop customized application software. Except for the monitor and keyboard, all components are housed in a single chassis. A bidirectional 100-cps printer is also available. DIEBOLD INC., Canton, Ohio.

**FOR DATA CIRCLE 315 ON READER CARD**

### PBX

The Omni SI private branch exchange can handle up to 256 voice and data ports and is designed to serve businesses employing from 30 to 200 workers. It supports all the terminal equipment, multiline telephones, integrated feature phones, and workstations supported by the larger Omni SII and SIII PBXs.

The unit uses a dual-bus architecture with a pulse-code modulation bus for voice and a packet bus for data. The data switching facility provides asynchronous data support up to 19.2Kbps over a transparent interface. An X.25 packet switch option is promised for future versions of the product. The product is available with custom-designed packages for the lodging and healthcare industries. In addition, centralized attendant service and automatic call distribution packages are available for high traffic call handling applications in banks, retail stores, and travel agencies. GTE BUSINESS COMMUNICATION SYSTEMS INC., Reston, Va.

**FOR DATA CIRCLE 316 ON READER CARD**

### FLOPPY DRIVE

The MegaDrive model 1722 provides an unformatted disk capacity of 3.2MB at 170 tracks per inch. The 5¼-inch floppy disk drive uses a closed loop positioning system to provide accurate on-track performance at that density. The drive can also read conventional 48tpi and 96tpi diskettes.

The closed loop positioning system is designed to adjust the drive automatically to distortions in the media that may be caused by heat or humidity. With a micro-

processor coupled with a stationary quad sensor and a mylar reference scale, the drive is able to sense track locations and guide the head to the intended track, eliminating some risks associated with high track densities. The closed loop system also allows the product to read isotropic and vertical media.

The drive does not require that imbedded servo tracks be written on the media, but instead uses media with a single reference track. The drive has a track-to-track access time of 3msec and a mean time between failures of 8,000 hours under typical usage. Average access time is 88msec. The drive is also compatible with existing 8-inch floppy controllers with an sr 850 interface. The 1722 costs \$500 in oem quantities. MPI, Chatsworth, Calif.

**FOR DATA CIRCLE 317 ON READER CARD**

### TWO PRINTERS

The LP 4120 tabletop laser printer can print 12 pages per minute. The 112-pound printer employs the vendor's LP controller 120, which has two 128-character internal fonts, in boldface ps and letter Gothic 15. The controller also permits use of two additional fonts, and provides the printer with overlay and portrait/landscape conversion capability. The printer also has a paper tray and a user-replaceable toner kit. The printer uses several interfaces to connect to word and data processing equipment.

The TP-X thermal printer can produce 100 cps in draft mode or 50 cps for correspondence quality. The 24-element printing head provides 180-dot-per-inch resolution. The 12-pound printer is designed for personal computing applications. It accepts 10-inch roll paper with a printing width of 8 inches. Sheets can be cut to any length along a 100-foot roll. Font density can be adjusted to suit various print-out needs. The printer uses either a thermal transfer on plain paper or a thermal dot print method on thermal-sensitive paper. The thermal transfer employs a thermal ribbon for longer lasting documents; the ribbon can print 155,000 characters. RICOH OF AMERICA, Fairfield, N.J.

**FOR DATA CIRCLE 318 ON READER CARD**

### VIDEO ADD-ONS

The AT-1 video attribute add-on circuit board is designed for use with the Kaypro II and Kaypro 4 portable computers. The board adds screen highlighting capabilities such as reverse video, reduced intensity, blinking, and reverse screen. It also enables multiple terminal emulation capability and screen to printer dumps. The terminal emulation capability allows the Kaypro to respond to Kaypro II, 4, and 10 codes, as well as those for the TeleVideo 925 and the IBM Personal Computer. The AT-1 costs \$150.

The vendor also introduced its GR-1 graphics upgrade for the Kaypro comput-

ers. It adds Epson printer-compatible graphics and screen dump character translation, and costs \$180. Custom graphics can be added as an extra-cost option. Both add-ons connect directly to the Kaypro's circuit board without modification to the computer. JFN INDUSTRIES, Los Angeles, Calif.

**FOR DATA CIRCLE 319 ON READER CARD**

### 256K MICRO

The M68 series dual cpu microcomputer uses four 256K dynamic RAM chips to provide a megabyte of main memory. Three memory boards, each with an additional megabyte of memory, are available as options. The system uses both the MC68000 10MHz microprocessor and the 8-bit Z80A microprocessor, and runs the CP/M-80 operating system. The product comes with language compilers for C, FORTRAN, COBOL, and APL, as well as the optional CP/M-68K operating system.

The system's large internal memory is intended to enhance the performance of the 68000 chip. The product is designed for use in corporate applications where data or programs will be transferred to mainframe computers. In particular, the vendor says, the unit is capable of supporting systems development applications in which the finished product can be uploaded to the mainframe for implementation.

The system comes with a 25 × 80 screen with 8 × 16 character cells. The monitor supports reverse video, blinking, and underlining, and generates eight colors. A color graphic display is also available with a 640 × 400 16-color resolution. Speakers, light pens, parallel printers, and GP-IB devices can be supported. A pair of 5¼-inch floppy disk drives and an RS232C interface are supplied with the product. SORD COMPUTER OF AMERICA INC., New York, N.Y.

**FOR DATA CIRCLE 320 ON READER CARD**

### CALLIGRAPHIC DISPLAY

The PS 300 color calligraphic display is a 19-inch monitor designed for use with the vendor's PS 300 family of computer graphics systems. It uses the same cabinetry as the PS 300 19-inch monochrome calligraphic display and the PS 300 19-inch color raster displays also available for the graphics systems.

The product is designed for use in real-time dynamic design and analysis. It supports a programmable selection of 1,800 colors for use in highlighting complex objects, segregating components, or discerning subobjects within a picture. It can produce 3-D line drawings using antialiasing to eliminate jagged raster lines. The display costs \$21,000. The monochrome version costs \$7,950. EVANS & SUTHERLAND COMPUTER CORP., Salt Lake City, Utah.

**FOR DATA CIRCLE 323 ON READER CARD**

—Michael Tyler



**NEW!**  
IBM PC and  
DEC PRO 350

## Statistical and Reporting Software

SPSS Inc. a leading producer of statistical software for over 15 years, with more than a half million manuals sold in 80 countries, is making micro waves with SPSS/PC and SPSS/Pro.™ Two powerful new statistical and reporting programs which were designed for the IBM Personal Computer and the DEC Professional 350.

### POWERFUL STATISTICS

- Crosstabulations
- Analysis of variance
- Multiple regression
- Over 25 integrated procedures

### TOTAL INTEGRATION

- File management of large or small data sets
- Input & output to popular PC programs
- Flexible data transformations

### CUSTOM DISPLAYS

- Automatic or custom reports
- Fully labeled tables
- Plots & graphs

### EASY TO LEARN

- Simple English commands
- Tutorial & demonstration diskette included
- Comprehensive documentation for all levels of users

**SPSS inc.**

444 N. Michigan Avenue  
Chicago, Illinois 60611  
(312) 329-2400

For the DEC Professional 350, and soon for the IBM PC with hard disk. To discover how SPSS can help you make waves, call us for the full story. (312) 329-2400.

SPSS, SPSS/PC and SPSS/Pro are trademarks of SPSS Inc. for its proprietary computer software. IBM PC is a trademark of IBM Corporation. DEC and DEC Professional are trademarks of Digital Equipment Corporation.

© Copyright 1983, SPSS Inc.

# SOFTWARE AND SERVICES

## UPDATES

Software piracy is unlike other kinds of computer crime in that the vast majority of perpetrators are not professionals intent on embezzling funds through one sort of scheme or another; rather, we are told, they are ordinary people like you and me, who see no more evil in giving a friend a copy of WordStar than in giving him a homemade copy of "The Sound of Music." (And most of us do not care what the federal courts have to say on the matter since the likelihood of being prosecuted is slim.) The prospect of seeing potential sales lost to such innocent piracy has brought many software vendors into court, but it also opened the floodgates for marketers of anti-piracy products. One such marketer, Export Software International, places a unique magnetic pattern onto each legitimate diskette that it will ship to a software publisher. It also provides the publisher with a program to scramble each copy of the software as it is produced; the program also includes the software needed to compare the hex code to the code listed in the program. When the user loads the program disk, the software is loaded into the machine only if the code listed in the program matches the code on the disk. Backups can be made, but can only be used by copying the program back onto the original diskette -- so users can't "lend" their backups to others for permanent use. The Scottish company says it can provide the service for \$1 per disk.

The Vault Corp., in Los Angeles, markets a similar service, called ProLok. It has extended the fingerprinting idea to electronically distributed software. Essentially, in order to purchase software electronically, a user must first buy a specially treated

diskette from the publisher. The software, including the code to compare fingerprints, can then be transmitted over the phone onto the treated diskette. The service is designed primarily for vendors of frequently updated software, since the same diskette can be used for each update of the software.

Electronic software distribution, meanwhile, has not met the enthusiastic reception many observers and participants thought it would. Yet Romox, a Campbell, Calif., electronic distributor, recently expanded its marketing test to include 20 department stores in Paris and four in Stockholm. The company will send software from its Campbell mainframe to the stores via Communication Telematique SA in France and OY Teledata AB in Sweden. The international marketing test is a clone of Romox's U.S. scheme, which provides software for several home computers.

Meanwhile, Digital Research has inked an agreement with Zilog and American Microsystems that will result in distribution of the Personal CP/M operating system on a microprocessor chip. The three Silicon Valley companies will work together, with DR providing technical support and the two semiconductor houses manufacturing, marketing, and distributing the resulting Z80-based chip. No word on when the chip will reach the market, however.

Apple's latest attempt to boost sales of its oft-troubled Apple III model is an electronic information service, which provides electronic mail among users, a directory of software available for the Apple III, software updates, a monthly newsletter from Apple, and a bulletin board. The service is available through CompuServe at its normal rates.

## INTEGRATION

CA-Executive provides business software for IBM Personal Computers; communications among PCs and mainframes, and a window manager. It includes database management, spreadsheet, word processing, editing, graphics, forms generation,

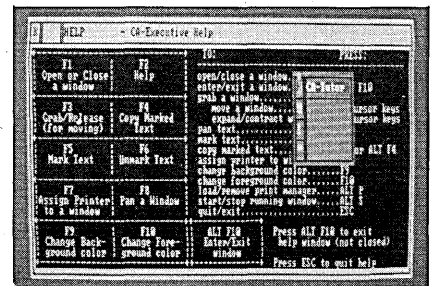

and mainframe linkage programs. Multiple programs can be displayed and processed concurrently through windows that can be made larger or smaller according to need.

Data can be retrieved, received, moved, manipulated, and transmitted from one window to another or between one PC and another, or to a mainframe.

The key component of the package is CA-Link, which operates in four modes to provide the communications capability. It provides an intelligent file transfer capability for access, retrieval, and storage to any file type on the mainframe. A 3270 terminal emulator provides access to any subset of the database controlled by CA-Universe when integrated with the mainframe CA-Universe DBMS, and it acts as a dial-up or synchronous dumb terminal to access external services.

Several of the remaining components are parts of the vendor's EasySeries, while the others are new with this release. The package is sold only through the vendor's mainframe software sales force. In small quantities, the CA-Executive set costs \$1,300 apiece; quantity discounts apply, with a maximum discount of 45% for more than 50 copies. COMPUTER ASSOCIATES INTERNATIONAL INC., Jericho, N.Y.

**FOR DATA CIRCLE 326 ON READER CARD**





## A few graphic words from our InterTest™ users:

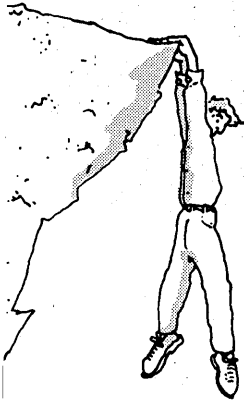

“Testing without InterTest is like climbing a mountain without a rope.”

Arthur R. Connal,  
Technical Services,  
The Home Insurance Co.

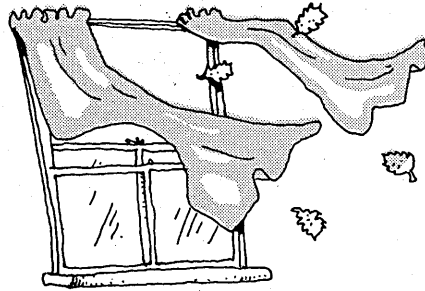

“Makes CICS debugging a breeze.”

Neil A. Wells,  
Manager Systems & Programming,  
Top Value Enterprises.

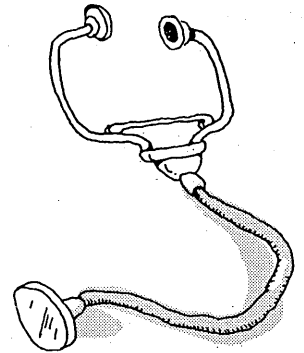

“It provides an invaluable diagnostic capability.”

Alan F. James,  
Systems Analyst/Systems,  
First Security Bank Of Utah.

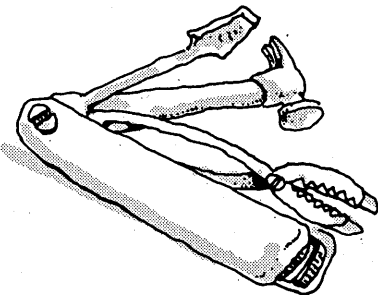

“Best tool on market to help CICS program development.”

Joseph C. Chen,  
Senior Project Leader,  
Briggs-Weaver.

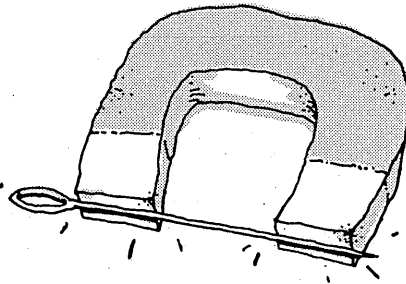

“Unmatched for finding a needle in a haystack.”

Charles C. Allan,  
Manager, Computer Operations,  
Carborundum Co.

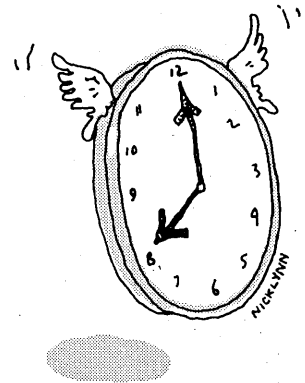

“Greatly speeded the debugging process up.”

Robert W. Belden,  
Technical Support Programmer,  
R.I. Hospital Trust National Bank.

A survey was recently sent to the users of InterTest software, the industry standard for CICS testing and debugging. As you can see, the comments speak for themselves.

Call today for more information or a copy of the survey results controlled, compiled and tabulated by one of the nation's leading public accounting firms. InterTest works hard for its 1,400 users. And On-Line Software International can prove it.

InterTest from  
**ON-LINE  
SOFTWARE**  
INTERNATIONAL

Two Executive Drive, Fort Lee, NJ 07024, (201) 592-0009 Toll Free (800) 526-0272

CIRCLE 133 ON READER CARD

## SOFTWARE & SERVICES

non-English speaking countries. The package costs \$5,000 plus installation. ARTHUR ANDERSEN & CO., Chicago, Ill.

**FOR DATA CIRCLE 330 ON READER CARD**

### LAP UTILITY

The LAPCOM utility program is designed to supplant the built-in Telcom application in the Radio Shack model 100 lap computer, which requires that users drop communications to the host in order to view other files, copy files, kill files, or determine remaining available memory space.

LAPCOM, using menus and function keys, permits the user to perform these local operations without disconnecting the communications link. Similarly, the file directory can be displayed; BASIC can be accessed for immediate commands; the computer's time can be displayed; and Xon, Xoff, and CTRL C commands can be sent with a single keystroke, without affecting the telecom link. The program also automatically calls and disconnects, uploads and downloads files, and directs output to the printer if one is attached. It is possible to display, store, and print text data as it is being downloaded.

Included with the program is an annotated source code listing to assist the user in customizing the program. The product costs \$40 and comes on a tape cassette with the user manual. POCKETINFO CORP., Beaverton, Ore.

**FOR DATA CIRCLE 331 ON READER CARD**

### WALLPAPER

The Blueprint series is a set of learning tools for microcomputer applications software and operating systems. It consists of a set of large posters designed to be tacked to a wall near the microcomputer. The charts, which measure about 24 by 36 inches and are printed in blue ink, are arranged to show the logical flow of a program, including the various keystroke commands and explanations of what each command does. The charts are designed to lead the user through the simpler commands at first and then the more complex tasks later.

Blueprints are currently available for WordStar/MailMerge, dBASE II, 1-2-3, SuperCalc, CP/M 2.2, and PC/DOS. The number of posters for each program varies, from two for PC/DOS to six for WordStar/MailMerge. The posters within a program set are arranged sequentially, so that novice users consult only the first sheet, while more advanced users may find the later sheets helpful as well. Each set, regardless of the number of posters in it, costs \$12.50. ONSET SERVICES, San Mateo, Calif.

**FOR DATA CIRCLE 332 ON READER CARD**

### MICRO-MAINFRAME LINK

ADR/PC Datacom is a relational information management facility that allows data sharing and control between an IBM Personal

Computer and an IBM mainframe. It provides the PC user with facilities to qualify, review, select, and transfer mainframe production data to the micro for use with a variety of existing PC application products.

Access to corporate data is provided through a link with the vendor's mainframe ADR/Datacom product. Both the micro and the mainframe systems use the same relational model and query language for all access and manipulations. The PC product can log events as they occur during an active session with the mainframe. One or more session profiles can be established for each user to designate line speed, parity, dialing instructions, screen colors, and definitions of program function keys.

Data downloaded from the mainframe can be stored in its standard ADR/Datacom format, in the DIF format, or in the Comma-Separated Values format. The product allows asynchronous connection to CICS or ADR/Datacom/DC in the mainframe environment. The initial release is available only for PC/DOS, although future releases will work in the VisiOn environment, the vendor says. ADR/PC Datacom requires a one-time mainframe product upgrade fee of \$13,500 for OS environments and \$12,000 for DOS environments. In addition, each copy of the micro programs costs \$500. APPLIED DATA RESEARCH INC., Princeton, N.J.

**FOR DATA CIRCLE 333 ON READER CARD**

### ELECTRONIC MAIL

The Informail proprietary electronic mail system is available to timesharing users of this vendor's data center. It provides each user with a mailbox to send and receive messages, and includes security measures to prevent users from reading mail destined for other mailboxes. The network is accessible throughout the continental U.S.

Informail may be used in either a prompt or command mode. On-line help is available in both modes to explain the function and syntax of any command. A directory function allows mail to be addressed to a user's name if the Informail ID is unknown. Even if the user does not supply the exact spelling, the software recognizes names of recipients by abbreviations, partial names, and phonetic spelling. When a perfect match is not found, the system presents the user with a list of similar names. The directory also contains information about organizational structure and allows a user to request the names of all employees reporting to a particular manager. It can also be used to create and store distribution lists.

Users can send existing files or create new messages using a create function that prompts the user for standard memo fields and for message text entry. Incoming mail may be directed to the terminal, printer, or disk. A list of both outgoing and incoming mail can be created, including subject, date and time sent, intended receiv-

er/sender, and information on whether the message has been read or canceled. Informail costs 5¢ per message and \$25 per hour connect charge for users who meet a standard monthly minimum of \$300 of mainframe processing on the vendor's service. INFORMATICS GENERAL CORP., Woodland Hills, Calif.

**FOR DATA CIRCLE 334 ON READER CARD**

### PERFORMANCE SIMULATION

The PSS performance simulation system allows VAX users to record one or more terminal sessions for the purpose of replaying them under any of three scenarios. The three scenarios are performance testing, application reliability, and security.

The package provides a transparent method of capturing the terminal input and output sessions. The input log may be edited as required and then replayed through the "pseudo" terminals, allowing large terminal or transaction loads to be performed without requiring significant manpower or terminal resources. During the playback, the output of the simulated terminal session is captured, providing a mechanized means of verifying an applications reliability by comparing the original output log to the playback output log. Input data is replayed at the time interval it was originally entered, to generate realistic performance measurement. The PSS command set allows users to perform peak volume tests as well.

The package can monitor and playback any terminal device that uses the VMS Terminal Class driver. DEC-layered products such as TDMS and FMS can be used with PSS. The package provides terminal and overall response time performance data. The package costs \$5,000 for VAX-11/780 systems, \$3,500 for VAX-11/750 systems, and \$2,000 for VAX-11/730 systems. Multiple cpu and educational discounts are available. ADVANCED SYSTEMS CONCEPTS INC., Hoboken, N.J.

**FOR DATA CIRCLE 335 ON READER CARD**

### 1-2-3 TEMPLATES

The Personal Tax Preparer and the Time and Billing packages are designed to work as Lotus 1-2-3 templates. The Personal Tax Preparer condenses 1-2-3 to seven single letter commands, and adds the save, print, and destroy commands. It enables users to prepare the 1040 form and Schedules A, B, C, D, E, G, SE, W, 2106 Employee Business Expense, and 5695 Energy Credit.

Users enter the appropriate data once, and a linking function carries the data to all required locations on supporting schedules and also back to 1040 form schedules. A list displays all of the forms and schedules in use. The program applies an internal tax table or schedule to calculate the tax automatically. The package will print directly on government forms and on blank paper for computer-generated forms.

XEROX

# Now Xerox offers the best of both worlds for the price of one.



**For the first time ever, you can get the most advanced Xerox manufacturing software, plus an IBM mainframe computer, in one complete, affordable system.**

The Xerox Turnkey Manufacturing System includes everything you need for dependable, comprehensive information management.

Yet, because it's an off-the-shelf system, you can get it fully installed at a price you never thought possible.

This new system has an advanced architecture that completely integrates manufacturing, financial and distribution applications, personal computing, information center software, decision support systems, a database manager and fourth-generation languages.

However, it's so simple to use, your

current personnel can develop their own applications and handle their own information needs without help. So there's no data processing staff to hire.

Which means you get fast, economical installation, plus immediate payback in improved productivity and management control. All with minimum overhead.

Xerox Computer Services technical experts, who thoroughly understand the manufacturing business, will help you with everything. From initial site planning, to telephone hotline support after you're up and running.

Of course, full documentation, training and software maintenance are also part of the package.

But best of all, as your business expands and it's time to move to a larger computer, you'll still be able to run the same software on any IBM mainframe, starting with the smallest 4300 series system up through the powerful 3084 model.

So if you're looking for better control over your operations, but are concerned about finding a system that really fits your requirements and budget, let us tell

you about our simple solution... the Xerox Turnkey Manufacturing System.

Call Ron Rich at (213) 306-4000, or mail in our coupon, and we'll send you complete information and pricing details.

**XEROX COMPUTER SERVICES**  
 c/o Ron Rich, 5310 Beethoven Street  
 Los Angeles, California 90066

Your ad was very timely. We're planning on buying a new system within  30 days  90 days  6 months  1 year.

- Have a sales rep call me immediately.
- Send me more detailed information.

Name/Title \_\_\_\_\_

Company \_\_\_\_\_

Street \_\_\_\_\_

City \_\_\_\_\_

State \_\_\_\_\_ Zip \_\_\_\_\_

Phone \_\_\_\_\_ D/03/84

Xerox® is a trademark of XEROX CORPORATION.  
 IBM® is a trademark of International Business Machines Corporation.

## SOFTWARE & SERVICES

(The 1040 form may not be substituted, according to federal guidelines.)

The Time and Billing package can accommodate 25 different people, each with different billing rates, on a disk. A total of 10,000 cases or clients can be maintained, with as many as 2,000 billing entries. The package shows numbers being entered, calculations as they are made, and interrelationships to other entries or to the bottom line.

The package is designed to guide users in estimating fees. Users can customize up to 30 abbreviated service codes to complement the 15 shorthand codes furnished with the package.

Both products retail for \$175 apiece. The vendor says that users need not know 1-2-3 thoroughly in order to use either package. PROFESSIONAL SOFTWARE TECHNOLOGY, Rockport, Mass.

**FOR DATA CIRCLE 336 ON READER CARD**

### CAD

The CADplan package for architects, draftsmen, and designers runs on the IBM Personal Computer. The program simulates a drafting environment, the vendor says.

The package is suited for two-dimensional design applications, such as floor plan layouts or designs for mechanical systems. It displays on the screen a grid identical to that on quadrille paper, and allows users to interact with the system using a mouse or a digitizing tablet. CADplan can perform zooms, pans, copies, moves, rotations, deletions, and undeletions. Options include the ability to pan around an object drawn on the screen for a global view and to zoom in or out of a particular area to check details. All the commands are displayed in a menu format.

The product has an optional database management system that keeps statistics on design components. A cost analysis facility allows planners to build a database of vendors, devise an office plan, and produce a bill of materials for chairs, desks, or bookcases. Users can place components on any of 65 layers using transparent screen overlays. A symbol library can be created and maintained for frequently used images. The product requires an IBM PC with 320KB of RAM and disk storage. It costs \$1,200, plus \$350 for the DBMS. PERSONAL CAD SYSTEMS INC., Los Gatos, Calif.

**FOR DATA CIRCLE 337 ON READER CARD**

### MICRO UNIX

Genix is a port of the Berkeley 4.1 bsd version of the Unix operating system that is intended for use in conjunction with the vendor's NS16000 microprocessor family. Some 200 utilities and special programs are included in the Genix package, including UUCP intersystem communications, source code control system, Nroff document preparation, Troff typesetter run-off documen-

tation facilities, and the vi screen editor. Genix supports the C shell, which allows utilization of several job control functions. The Genix C compiler is an optimized version of the Berkeley 4.1 bsd portable compiler.

Genix is designed to permit use of the demand paged virtual memory and floating point arithmetic functions of the NS16000. The multi-user, multitasking operating system includes an assembler, a loader, and a run-time support library. Each process runs in a protected linear address space of up to 16MB.

Minimum hardware requirements for the product include the NS16032 microprocessor, the NS16082 memory management unit, the NS16201 timing control unit, half a megabyte of main memory, 20MB of disk storage, and an RS232 communications port. The Genix operating system is available in source code form for oem adaptation for \$30,000, including 1,400 pages of documentation. NATIONAL SEMICONDUCTOR CORP., Santa Clara, Calif.

**FOR DATA CIRCLE 338 ON READER CARD**

### SECURITIES DATA

The Huttonline electronic information service is designed to allow clients to access the firm's computers for personal account data, investment information, and electronic mail. Available account information includes portfolio positions and market values, cash and margin balances, and open orders. The service also shows the client's transaction activity, such as interest and dividend income, buys and sells, interest expense, and deposits.

Research information, market comments, and other investment information are also available through the service. While clients can send and receive electronic mail to and from their account executives, they cannot place orders over the service. Huttonline prompts clients through a series of menus, although more sophisticated users can bypass the menus and employ direct commands.

Clients can access the service from anywhere in the U.S. with any 300-baud or 1200-baud pc, terminal, or word processor. Users must telephone the vendor's central mainframe over regular lines. All subscribers are charged \$25 initially and \$17 per month, which includes two hours of use. Additional usage is \$7.50 per hour. The service is available only from 6 a.m. to 12:30 a.m. EST. E.F. HUTTON & CO. INC., New York, N.Y.

**FOR DATA CIRCLE 339 ON READER CARD**

### LOGIC DESIGN

The CADroid logic design system is designed to perform all operations from schematic entry through prototype board layout and wire list generation. Function selection is provided through the use of menus

throughout the product. The system can be used with either a mouse or a keyboard for cursor positioning.

The package includes software for pan and zoom of images, as well as "rubberbanding" new images. It has a library of many standard integrated circuits, including the 74 and 74LS series and 10K and 100K ECL. Additional parts can be drawn, defined, and incorporated into the library.

CADroid produces a wire list that presents diagnostic messages indicating errors in fan-out, shorts, and missing connections. Autorouting and automatic component placement are provided. The point-to-point routed wire list generated by the system can be formatted for use by various wire wrap services. CADroid also produces a net list formatted for input to Scientific Calculations' SCICARDS system.

The package is written in C and runs under Unix on 68000-based micros or on VAX computers. It costs \$8,000, and represents the first software offering from this movie production company. LUCASFILM LTD., San Rafael, Calif.

**FOR DATA CIRCLE 340 ON READER CARD**

### CROSS REFERENCES

Probe is an interactive analysis system for the IBM System/38 that uses both object and source code analysis to provide cross referencing information. The analysis is performed in a batch subsystem, while the reports are provided on-line. The menu-driven product will display job stream explosions. It shows all control transfers from one program to another, including CALL, TFRCTL, QRY, DFU, and SBMJOB. All RPG, COBOL, and CL programs will be included. Flowcharts are also provided.

On-line database information includes record layouts for externally described files and RPG- and COBOL-program described files. Probe does field analysis and can display program usage of field information for internally and externally described files, permitting the user to know which programs are using a specified field.

Reference field analysis and physical file dependencies are also able to be displayed. File "where-used" displays and explosions are provided. Users can query file overrides, the reformat command, and database management commands. The package's command processor provides access for frequently used functions, as an alternative to the menu displays. The package costs \$1,000 and comes with a 50-page manual. ADVANCED SYSTEMS CONCEPTS, Wheeling, Ill.

**FOR DATA CIRCLE 341 ON READER CARD**

### TELEPHONE BILLING

The Autotas billing package allows a telephone answering bureau to track up to 50 types of services, setting minimum fees and two-step rates for each. The system





## GET THE WORD ABOUT TRANSACTION PROCESSING. IT'S IN THE BOOK.

In our free 82-page book, "SYNAPSE TRANSACTION PROCESSING. SYSTEM OVERVIEW." And it's a revelation. To nontechnical management, technical management, and staff alike.

It spells out how to accelerate development and minimize maintenance of high-performance, fault-tolerant, on-line transaction-processing systems.

It also discusses miracles: how to get dazzling performance from a Relational DBMS and how to expand a transaction-processing system on-

line and under power. It reveals how to provide fault tolerance without redundant hardware and without programming. How to use a system-wide dictionary to standardize and control all definitions and relationships. How to completely automate database integrity, concurrency and recovery.

It's all there. Chapter and verse. Even a comprehensive index.

To get your copy, simply mail the coupon or call us at (408) 946-3191.

And let there be enlightenment.

To: Synapse Computer Corporation,  
Corporate Communications Dept.  
801 Buckeye Court, Milpitas, CA 95035.

Please send me your free, 82-page bible on transaction processing.

Name \_\_\_\_\_

Title \_\_\_\_\_ Phone \_\_\_\_\_

Company \_\_\_\_\_

Address \_\_\_\_\_

City \_\_\_\_\_

State \_\_\_\_\_ Zip \_\_\_\_\_

**Synapse**  
Computer Corporation

**THINK AHEAD.**

Copyright © 1983 Synapse Computer Corporation.

CIRCLE 135 ON READER CARD

## SOFTWARE & SERVICES

keeps tabs on the most common charges automatically, while others can be tallied by the attendant with one keystroke. The package displays answer phrases and forwarding numbers, as well as other client information, on a crt screen for operators to use when answering phones. It also provides electronic message storage and hard-copy retrieval.

The package handles up to 992 client accounts, and produces invoices that can be mailed in standard window envelopes. The system tracks the minimum rate, a base rate, and an optional second rate after a set quantity has been exceeded, for up to 50 services. Eighteen billable items are automatically counted by the system, including the number of messages received, check-in calls, and customer pagings; changes of instruction and ring count; and bureau-definable services. Other service types can be defined and may be based on the automatically tallied items. Up to 32 customer profiles, each consisting of up to 20 services, can be developed. The package can produce trial balances based on hypothetical billing rates. It costs \$1,200. CANDELA ELECTRONICS, Sunnyvale, Calif.

**FOR DATA CIRCLE 342 ON READER CARD**

### COST ESTIMATES

Estimating 50 is designed for consulting engineers who frequently perform cost estimates. The program, which runs on the Wang 2200 series of computers, calculates unit costs and total cost summations for any job. The program has two main branches of operation: the "crew approach" and the "unit cost approach." Upon entering the appropriate data—description, crew, quantity, material, labor, and equipment—the program calculates and summarizes the total estimated job costs, and prints out a report. The package costs \$2,500, which includes the program and procedures, a user manual, and telephone support for a year. Additional yearly support costs \$250 per year. A version is promised for the Wang Professional Computer as well. H.M. LONG & ASSOCIATES INC., Tampa, Fla.

**FOR DATA CIRCLE 344 ON READER CARD**

### FILE MANAGEMENT

The Documax information management system for the Apple II computer system is designed to handle word processing, electronic mail, and other text files. The menu-driven program combines the functions of accessing, storing, and organizing the documents.

Files are searched at 15,000 words per minute. A full disk can be searched in about 1½ minutes. Needed information is specified using one or two phrases of up to 30 characters each, without using keyboards. Files can be scanned in quick succession, with the user stopping to browse through any file.

Documax contains a proprietary text compression scheme that doubles the capacity of any disk. Using Documax, an Apple II disk holds 60 pages of text. Compressed files may be restored to their original form using the program's recover function. Both the compress and recover functions work at the same 15,000 words per minute pace.

File directories can be sorted into as many as 10 subgroups. Subgroup directories can be arranged alphabetically. Files may be transferred to one disk from another, or can be deleted. Locked files cannot be deleted without first unlocking them. File names can be changed or added to any disk. Documax costs \$175, and requires 48KB of RAM. SIGNUM MICROSYSTEMS, Bloomfield, Conn.

**FOR DATA CIRCLE 343 ON READER CARD**

### OFFLOADING

PC/Viewcom provides offloading of host printing and automatic report distribution to microcomputers. Using CICS and IBM Personal Computers, users can route batch (JES or Power Spool files) reports or on-line transaction generated reports to personal computers or IBM 328x or 326x printers.

The product provides mainframe-type spooling functions, such as forward and backspacing printers in the event of a forms jam; report class type queueing; report purging; and user report directory displays. The mainframe data transfers are performed over a background asynchronous PC task; it is transparent to other applications concurrently executing on the PC.

PC/Viewcom can drive up to three printers per PC concurrently. Each printer may be printing different reports from the host. The product does not support CMS or TSO. It costs \$2,000. STARTECH SOFTWARE SYSTEMS INC., Woodside, N.Y.

**FOR DATA CIRCLE 346 ON READER CARD**

### FILE TRANSFER

The Microseek micro-to-mainframe communications package provides IBM PC and PC XT users with asynchronous communications capability to mainframe hosts. It includes file transfer, terminal emulation, a set of prepackaged log-on sequences for automatic connection to mainframe hosts, and the ability to automate repetitive PC/host tasks. A more advanced version, Microseek Plus, also has mainframe software for error correction and detection.

In file transfers, users can send either ASCII or binary files; many of the PC/DOS operating commands can be called from within Microseek for directory and file administration. The command-based system provides several help screens to assist users in learning how to send and receive files. Users can type Microseek commands one at a time or can build a macro file within Microseek.

The package comes with a set of sequence file structures, which are activated when Microseek commands are issued. Each sequence file contains the fundamental instructions that set up the communications environment and tell the PC how to interact with a host. Included are sequence files for interconnection with in-house MVS/TSO and VM/CMS systems, public information services, and timesharing services.

Additional sequence files can be developed to automate extracting information from database and transferring it to the PC, to develop customized distributed applications, to automate connections to other hosts, and to automate tasks that span several mainframe environments. The package runs on the IBM PC with 96KB of RAM and a disk drive. It requires an RS232 interface and an asynchronous board and a modem. Microseek costs \$200; Microseek Plus, with five copies of the PC software and the mainframe error checking software, costs \$3,500 plus a \$525 annual maintenance fee. COMSHARE INC., Ann Arbor, Mich.

**FOR DATA CIRCLE 345 ON READER CARD**

### VIRTUAL DISK

This virtual disk software permits RT-11 and RSX-11M/S-based real-time application programs running in standalone processors to share the disk resources of a host computer that is running other applications. The idea is to allow these operating systems to run at a remote site without physical disks but with the ability to use disk drives.

The program's power-up boot is performed automatically across the network, so that ROM-based satellite software is not needed. The satellite stations are linked to the host computer via a 1Mbps local network implemented with this vendor's Megalink processor-to-processor communications hardware. A data throughput of 600Kbps can be obtained in such a network, consisting of a PDP-11/23 host and three LSI-11/02 satellites.

Individual floppy disk drives at the satellite processor are replaced by files on the host disk, permitting the satellites to be located in harsh environments. Network operations are transparent to the satellite application programs, which continue to make standard I/O file requests. Up to 32 satellite processors can be accommodated with some degradation of host performance caused by the network activity.

Virtual disk sizes can be modified and can be of any size up to the size of the physical disk. The same file can be accessed by multiple satellites to prevent duplication of files and to facilitate backups. Prices range from \$2,000 for up to four satellites to \$10,000 for 32 satellites. COMPUTROL, Ridgefield, Conn.

**FOR DATA CIRCLE 347 ON READER CARD**  
—Michael Tyler

# THE NEWEST FEATURE ON THE 3000 FAMILY OF PRINTERS IS OUR NEW NAME.



GENICOM 3404

Our 3000 family of printers has an impressive list of features. But the most prominent new change on our printers is our new name.

Formerly the Data Communication Products Department of General Electric, we're now independently owned...and our new name is Genicom.

So the GE 3000 family is now the Genicom 3000 family. But while the name has changed, the product retains its established superiority.

The Genicom 3000 series of output printers still features speeds from 40 to over 400 cps. Single or dual mode printing. Type quality from EDP to NLQ. Multi-color printing. Graphics. Selectable type fonts, American craftsmanship and more.

Genicom 3000 printers will be as popular as ever with end users as well as OEM's, distributors, retailers and dealers...thanks to our list of outstanding features, plus the unique commonality advantages of several models all based on a single design.

And Genicom will also offer other products including our 2000 teleprinters and the soon to be introduced 4000 shuttle matrix printers. You'll find we have the same complete product line we had with GE.

Genicom. We have proven products, experienced personnel, established manufacturing facilities, a nationwide service network, plus a new commitment to excellence that stands behind our new name.

Genicom Corporation, One General Electric Drive, Dept. M311, Waynesboro, VA 22980. In Virginia, call 1-703-949-1170.

**GENICOM**

For the solution to your printing needs call  
**TOLL FREE 1-800-437-7468**

CIRCLE 136 ON READER CARD

# A BRILLIANT IDEA.

Your development center  
productivity will double  
under Hogan's Umbrella™  
—that's brilliant.

Imagine. A fully integrated development center system capable of upgrading and increasing output throughout the life cycle of both major and minor on-line and batch applications.

This completely automated approach to interactive development was critical in the development of our own highly successful line of applications software. That included design, management, programming, implementation, and maintenance of both on-line and batch applications. The Umbrella weathered well.

So well, in fact, users tell us that, "we beat our estimates by 50% on our very first major on-line application and that included our education time on the Umbrella."

There's a lot more the Hogan Umbrella can do. Just ask any Umbrella user...various combinations of DOS, VS, MVS, IMS, VSAM, CICS, IDMS. And ask Ed Lomax, Vice President, at (214) 386-0020. Make a brilliant decision today.

Send me more information on your UMBRELLA System.

Name: \_\_\_\_\_

Title: \_\_\_\_\_

Company: \_\_\_\_\_

Address: \_\_\_\_\_

City: \_\_\_\_\_ State: \_\_\_\_\_ ZIP: \_\_\_\_\_

Phone: \_\_\_\_\_

The logo for Hogan Systems, featuring a stylized sunburst icon to the left of the word "Hogan" in a bold, sans-serif font, with "SYSTEMS" in a smaller font below it.

TOMORROW'S SOFTWARE.  
HERE TODAY.

Corporate Headquarters: 5080 Spectrum Drive, Dallas, TX 75248 □ Atlanta, Boston, Chicago, Dallas, Detroit, Los Angeles, New York, London, Australia and New Zealand □ TELEX 203927 □ (NASDAQ Symbol: HOGN)

CIRCLE 137 ON READER CARD

# SOURCE DATA

## BOOKS

### **WORKRIGHTS** by Robert Ellis Smith

In a book entitled *Workrights*, you would expect a list of employee entitlements, a catalog of rights in the workplace. But there isn't any such list here, because we enjoy precious few liberties at work. The "rights of one citizen as against another" are not protected by our Constitution, according to an 1875 Supreme Court decision. While workers today have protection against hazardous work environments or sexual harassment, they are not much better off, according to *Workrights*, than were textile workers in nineteenth-century Lowell, Mass. They are still subjected to imperious and peremptory decisions at their place of work.

Robert Ellis Smith, the book's author, is a former staff member of the ACLU, a lawyer, and the publisher of a monthly newsletter, *Privacy Journal*. *Workrights* is a decidedly pro-employee effort, and a compelling one. Smith details 14 freedoms not recognized in private employment, and how these rights should be respected. It is clearly a book riding a hobbyhorse, but, after all, it is an important hobbyhorse. Nearly everybody has to work, and nearly everyone has had some contact with rights' violations at work.

Corporations exist not only to generate profit, but also to assert and consolidate control. With industrialization and its accompanying emphasis on time and regulation came the "regime of wages." It wasn't until 1890 that the Winchester Repeating Arms plant in New Haven began to insist that employees arrive at work on time. In order to maintain control, corporations will frequently strive to abrogate the independence of their employees, ostensibly in the interest of efficiency. "Most em-

ployees, at all levels," says industrial psychologist David Sirota in *Workrights*, "are treated like children or criminals."

Americans like to challenge authority, just as children or criminals often do. Workers' discontent, which Smith claims has been "seen essentially as a management problem confined to the workplace," is no longer a business concern alone. "In the 1980s, it must be seen as a broader social problem." Complaints of declining productivity or shoddy workmanship only relate to a small portion of this problem.

Smith attributes much of the employee disaffection to the "arbitrary tyranny of the workplace," which resulted from scientific management. This is a field that has taken a bad turn since the innocent days of F.W. Taylor or Frank Gilbreth. It now amounts to a faceless mechanization of decision making. Employees, Smith argues, are treated as objects to be manipulated for production purposes. "Instead of control appearing to flow from boss to workers," quotes Smith in *Workrights*, "control merges from the much more impersonal 'technology.'" Decisions are consequently driven by lifeless cost alone, or without any consideration of nonquantifiable factors. To view the management of humans strictly as a science, empirical and exact and capable of perfectibility, is to make for intolerable impositions on those humans.

The true organization man, in his devotion to his firm, must even betray the hearth, as Smith points out. There must be an absolute loyalty to profit and power. These corporate allegiances are threatened by families, and business demands its fealty in long hours away from home. There is little room in corporate Olympus for child-rearing or devoted husbanding. There might be some room for the incidental dalliance, or for business day Heros and Leanders like Bill Agee and Mary Cunningham.

Travel or transfers may affect the businessman's family, but the pot is sweetened with expense accounts, ponderous salaries, and imported chocolates on the pillow at night.

"They spend most of their time," writes Smith of the dedicated businessmen, "not in a den at home but in conference rooms at company headquarters and in partitioned hotel ballrooms with straight back chairs and crystal chandeliers." But work should be a condition for making a family possible, and not the other way around.

This is what the Catholic Church calls the error of economism. It is wrong, said Pope John Paul II in "On Work," written in 1981, to assume that "human work is solely an instrument of production, and that capital is the basis, efficient factor and purpose of production." When guided solely by efforts to maximize profits or control, business neglects the primacy of humans over things.

People should not suffer a lowering of their own dignity while enhancing the nobility of matter, which is what happens to many. Dignity can be preserved or restored by honoring rights in the workplace, according to Smith.

With a few notable exceptions, like NCR or Cyrus McCormick's reaper works, business has not traditionally cared too much about its workers' feelings or rights. It wasn't until Elton Mayo started tinkering around at the Hawthorne plant of the Western Electric Co. in 1924 that business gave any consideration to employees' feelings or attitudes. Even then, the main objectives were still to improve productivity and profits. Yet commerce complains vigorously of manacles. The English Ten Hour Act of 1847 was perceived as a critical erosion of capitalist authority, without which commerce would fall. Modern regulations of the workplace are viewed similarly, at least in the U.S. Before the federal Occupational



## SOURCE DATA

Safety & Health Administration (OSHA), there was little concern for dangerous work environments. Vacations, sick pay, shorter work days, even toilets and drinking water, were viewed in the past "like other fringe benefits . . . not gratuities, but the result of bottom-line business decisions."

Concern for workers' rights runs in cycles (the last notable epoch occurred after World War I). Smith attributes the current declining faith in corporations and work to the maturing baby boom generation. This has caused a move away from what he calls the "militarization of the corporation" (a World War II-inspired phenomenon). In the 1970s, Smith writes, "there was a declining confidence in all institutions, a tendency to question authority, less loyalty to one's work organization, less willingness to subordinate personal lives, less dedication to work."

Smith obviously dislikes the manner in which much of business is conducted. But there are a few clear violations that specifically gravel him. He doesn't like the way voluntary charitable contributions are elicited from employees, for one. Business people often sit on the United Way boards that determine which charities are worthy of funds. Smith writes of attempts by bureaucrats to exclude the NAACP Legal Defense Fund from the Combined Federal Campaign, the federal employees' United Way. And contributions to United Way are often something less than voluntary.

Smith doesn't like polygraphy, either. He cites Coors Brewery's lie detector test for job applicants (which asks, among other questions, if you had "ever done anything with your wife that could be considered immoral?") as a clear invasion of privacy and a violation of an employee's freedom in off-hours. Even worse is the prospect of genetic screening. Applicants with x-y chromosomes can forget about ever getting a job.

There is a promising trend, however, according to Smith. It is the challenge to terminations-at-will, which have been accepted as a matter of common law for over 100 years. This means dismissal could come at will for good cause, or for no cause at all. Dagwood Bumstead, private employee not under a collective-bargaining agreement, is always getting fired at will. Current court decisions tend to require just cause for dismissal. Unjust discharge suits are becoming popular with disgruntled former employees.

There is value in this book, but also a flaw that will prevent it from being appreciated: Smith's apparent conviction that businessmen are monsters. They cannot all be vampires: we see them daily on the street, and they have hands, organs, dimensions, senses, and passions. A. W. Clausen, former chairman of Bank of America, is a good reminder that businessmen need not

necessarily be greedy, power-crazed maniacs. Clausen offered to implement a voluntary disclosure code at his firm. Surely, here is an enlightened business leader who might agree with many of the points made in *Workrights*.

It is unfortunate that this book will pass unnoticed by many of those in a position to redress worker alienation. E. P. Dutton, New York (1983, 267 pp., \$15.95 hardcover, \$8.95 paperback).

—Leopold Froehlich

### WHITE COLLAR WASTE by Val Olson

Val Olson, a management consultant and productivity theorist with extensive experience in the insurance industry, has written a book based on a simple premise he calls the "4/8 theory." This premise states that the average white collar work unit performs at a 50% efficiency level. This should come as no surprise to the more cynical white collar worker. Some government workers might decry 50% as absurdly high. Mr. Olson has deduced this theory from his 20 years' experience in the field. Over the years he has measured the efficiency of various work units and found their average efficiency, prior to his program, ranged from 45% to 55%. Occasionally a unit was as low as 30%, but none was as high as 60%. While working with these groups he has found that under optimum conditions an increase in productivity of 40% to 50% is obtainable. From this he deduces his second premise, the "6/8 theory," which states that the highest efficiency achievable by humans is 75%. Only machines (and certain grim-faced IRS auditors) can approach 100% efficiency.

To attain the level proposed by the "6/8 theory" Olson introduces us to micro-measurement, macromasurement, FTES, and the "warning zone." In doing so he presents some extremely handsome but confusing graphics. By using his measurement devices and a back-to-basics philosophy, he demonstrates that startling increases in productivity can be obtained. To quote Olson, "In hundreds of installations I have been disappointed [only] four or five times with nondramatic results. The disappointments came in units with severe backlogs and an inexperienced work force." The results are spectacular, especially considering the target is a 50% improvement in productivity. The methods are simple and rely heavily on the process of measuring the time needed to complete a task, scheduling the workday, and continually monitoring results. The basic idea is not to work faster (which the author considers counterproductive), but more steadily through the day.

The book is straightforward, readable, and convincing. Many examples of productivity gains from the author's experience are related and present a good case for

his methods. The author relies on common sense, and occasional bits of his wry humor surface. He also comes up with some nice analogies such as "White collar waste is like vodka. You can't taste it, smell it, or see it, but it is nonetheless powerful." One wonders if he has ever thrown out a full bottle of vodka, thinking it was empty.

The book does have several shortcomings. *White Collar Waste* is mainly geared to clerical situations. When the author goes beyond the clerical level, to the professional he does so in a vague way, using dubious assumptions. The application of his methods to the nuclear physicist depends on the following statements: "The ditchdigger has a hole to dig that will take 30 minutes. The physicist has a formula to solve that will also take 30 minutes." In other words, the nuclear physicist performs tasks for which the completion time can be prospectively determined, much like a ditchdigger. Once all the times for the day's tasks are computed, our physicist fills out his schedule and becomes 50% more productive by closely monitoring his adherence to the schedule. Presumably, Einstein's schedule would have looked something like this:

10:37–11:15 Go to bank

11:15–12:05 Have brilliant flash of insight that will revolutionize the world of physics

12:05–12:37 Lunch

Imagine what 50% more productivity could have done in this case.

The whole subject of meetings is ignored. Not only does the author ignore the negative impact of meetings on productivity, he proposes more meetings, including daily morning meetings for supervisors. A conservative estimate of the time wasted in these meetings if six people attend is 67%, as usually one person is talking, one is listening, and the other four (if their eyes are open at this time of the day) are staring at their shoes, the ceiling, or the spot on the speaker's tie. If more than one person talks, the time wasted is 100%. The supervisors are in a hole already if they expect to achieve 75% efficiency for the day. For nonclerical personnel there are planning sessions and in-depth monitoring sessions. ("You mean to say, Dobbs, that you spent from 11:37 to 12:41 working on subtask (4) (a) (ii) and all you got done was this?") This book could be greatly improved by the addition of three new sections: how to avoid meetings; how to arrange to be called out of meetings; and why you should limit conference rooms to four uncomfortable chairs.

Another difficulty with *White Collar Waste* is its lack of independent confirmation. Most of the book is drawn solely from the author's experience. Therein lies his only evidence for the "4/8" and "6/8" premises. One must assume that as a consultant the areas he dealt with were problem

# micro/SPF™ educates micros so you don't have to re-educate programmers.

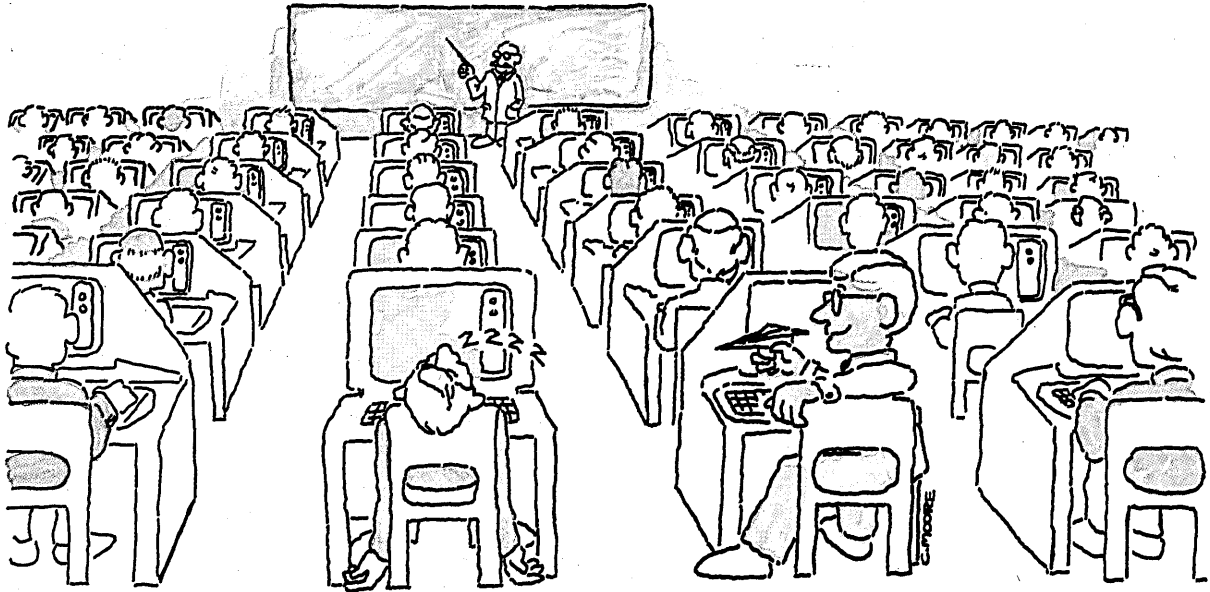

Are you considering microcomputers for programmers already familiar with SPF? Consider the time and effort you could save if re-educating programmers wasn't required.

Now it isn't.

micro/SPF™ is an advanced programming tool. It is designed to accommodate professional programmers familiar with SPF.

Re-education is not required.

What's more, micro/SPF™ is available for the IBM Personal Computer. Plus, other compatible 16-bit microcomputers.

And, future releases will include all extensions of the mainframe environment.

## Stop wasting valuable time re-educating experienced programmers.

More and more companies realize the potential value of using microcomputers to perform business functions. But the need for more sophisticated software, designed to satisfy experienced programmers, has become evident.

Seasoned professional programmers have

come to expect less from micros. Less performance. Less sophistication. And less flexibility.

Not anymore.

With micro/SPF™ experienced programmers can quickly and easily recognize the SPF emulation characteristics and operate more efficiently.

Also, they can make better use of their personal computing time.

Why?

Because the problems and frustrations typical of current microcomputer software are eliminated.

## micro/SPF™ emulates mainframe software on microcomputers.

micro/SPF™ executes under PC-DOS, MS-DOS and the family of Digital Research's CP/M-86 operating systems.

We've educated micros, so you don't have to re-educate your programmers.

To find out more about micro/SPF™ and other mainframe software tools, contact us. Also available through Digital Research, Inc.

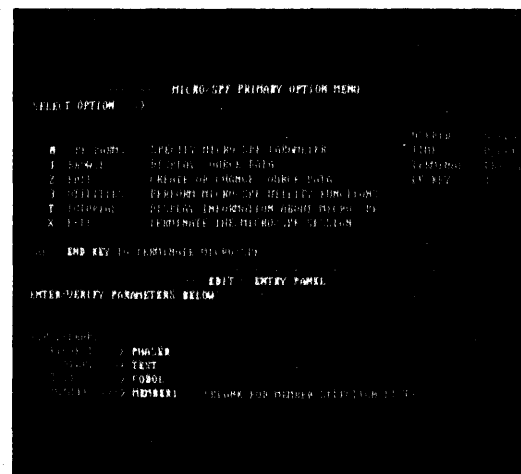

# PHASER

Mainframe Software for Micros

PHASER SYSTEMS, INC., 24 CALIFORNIA ST., SAN FRANCISCO, CA 94111 • 415-434-3990

PC-DOS and IBM are registered trademarks of International Business Machines Company. CP/M-86 is a registered trademark of Digital Research, Inc. MS-DOS is a registered trademark of Microsoft Corp.

CIRCLE 138 ON READER CARD

# NOW THERE'S HELP FOR MIS DIRECTORS FACING PERSONAL PROBLEMS.



## Presenting the Stratus Office Solution™ (SOS). It Will Integrate Your Collection of Information-hungry IBM PCs into a Fault Tolerant Office System.

Somehow the personal computer revolution has become your personal problem, hasn't it? They're lined up with their IBM PCs demanding access... access to the corporate data files ... access to shared data and hardware...

You need a solution right now and it has to be comprehensive and easy to understand. And if they're going to depend on it, it should be fault tolerant. What you need is the Stratus Office Solution (SOS).

### SOS Combines Comprehensive Software and Fault Tolerant Hardware

Stratus is the company that made its mark with its hardware-based fault tolerant super-mini. Now it is offering a turn-key software package built around this super-mini that is made to order for companies with an IBM host and from 20 to several thousand independent IBM PCs and/or 3270 and/or conventional terminals.

Here's a quick look at what you get with SOS (without having to write a single program):

- Controlled access to mainframe data

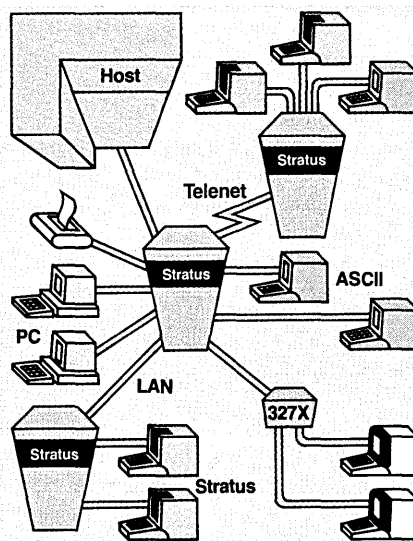

- Data exchange between IBM™ PCs
- Conversion to 1-2-3™ or VisiCalc™ formats
- Electronic mail at IBM PC, 3270, or ASCII terminals
- Word processing on IBM PCs using WordStar™ or MultiMate™

- Text conversion from WordStar and MultiMate
- Stratus word processing
- Shared access to Stratus printers and disks
- Calendar management at IBM PC, 3270, or ASCII terminals

SOS lets your collection of isolated PCs become part of an integrated office system. And unlike any other office system in the world, it is based on fault tolerant Stratus/32 hardware that provides continuous availability and transparent networking. Not only can you count on it to work well, you can count on it to always work.

Call Stratus today. Ask for Keith Johnson: 1-800-255-1515 or in Mass.: 1-617-653-1466. Turn those "personal" problems into personal success stories... and instant company assets.

**Stratus**  
CONTINUOUS PROCESSING™

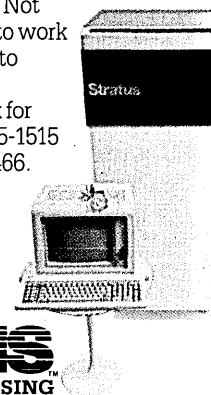

Stratus Office Solution and Continuous Processing are trademarks of Stratus Computer, Inc. IBM is a trademark of International Business Machines Corp. VisiCalc is a trademark of VisiCorp, Inc. 1-2-3 is a trademark of Lotus Development Corporation. WordStar is a trademark of MicroPro International. MultiMate is a trademark of SoftWord Systems, Inc.

## SOURCE DATA

areas. The same may apply to his recent experience. If so, this is like asking Michael DeBakey, "How many people suffer serious heart attacks?" He will reply, "Based on my 20 years of experience, all of them." Also absent are follow-up reports on the performance increases that are cited.

Although one example tracked improvement for 18 months, this was an exception. How long do these gains continue? Are they temporary responses to interest? Or are they long-term gains in productivity that will give your company the edge you need to successfully compete in the '80s and beyond?

In the '60s, Val Olson worked for a management consulting firm. In 1967 he went to work for an insurance company and started experimenting with his productivity theories. He produced astounding results. Based on his successes, he was charged in 1980 with installing his theories on a complex-wide basis. I decided to use Olson's concept of macromasurement to determine if these astounding gains in productivity had enabled his company to surpass other, similar insurance companies. Fifteen insurance companies of approximately the same size as Olson's were chosen. Results for the years 1978 through 1982 were compared. In asset growth the author's company was first. In premium growth it was fifth. In cumulative profits for the five-year period it was dead last. (The company did appear to have fairly low expense levels.)

Perhaps the conclusion to be drawn from the above is that there are no panaceas; not even 50% gains in productivity will solve all our problems. Despite the raft of books proclaiming their methods to be our salvation, on their own they can guarantee very little. Consider the traveling salesman who stops at the local factory, shiny new methods in hand, proclaiming, "I can increase your output of widgets by 100% overnight!" But the tired old owner in the stained canvas smock replies, "I ain't sold a widget in 50 years." Prentice-Hall Inc., Englewood Cliffs, N.J., (1983, 236 pp., \$16.50 hardcover, \$12.95 paperback).

—Eldon Smith

## REPORTS & REFERENCES

### IBM SOURCE SPOTS

A directory of software and support for IBM hardware is offered by Software Plus Inc. The guide includes over 700 organizations that provide software and support for the IBM 4300; 30xx; Series/1; Series/38, 36, 34, 23; the 5280; Displaywriter; and the PC. The contents of the directory are organized and cross-referenced by industry, application, and IBM region. The 500-page, soft-bound edition is updated every six months and costs \$160, with a \$25 discount if you send your check in with the order. For more information, contact Software Only, c/o

Nancy Baasch, Plaza Office Center, Route 73 & Fellowship Rd., Mt. Laurel, NJ 08054, (609) 235-3611.

Another directory with listings for IBM micro software is the *Software Guide for IBM Personal Computers & XT's*. This book totals 1,036 pages with product descriptions for over 2,950 programs from over 1,165 different vendors. Micro Information Publishers designed the book to help IBM PC owners locate and compare the functional value of any class of programs; in addition, the book gives contact and pricing information for all the products listed. People who purchase the book can use a toll-free number, provided by the company, to help locate hard-to-find software application programs, including those announced after the book went to press. In fact, at press time, there were 400 additional titles that the Software Location Service had available for further inquiries. The directory costs \$19.95 and is available from Micro-Information Publishing, 15420 Eagle Creek Ave., Prior Lake, MN 55372, (800) 328-7847 or (612) 447-6559. Add \$2 for postage and handling.

### 4GLS

By making computer power accessible to anyone, even those without extensive dp training, fourth generation languages may indeed shape all future dp developments. James Martin's "Fourth Generation Languages," volume 1, provides readers with an informed viewpoint of the field and includes chapters on such topics as What are 4GLs?, Categories of Languages, How are 4GLs Used?, Prototyping Languages, Dialogue Use in 4GLs, Examples of 4GL Mechanisms, Human Factors, Specification Languages, Semantic Disintegrity in Relation Operations, An Ideal Development for Commercial Dp, Section Criteria for 4GLs, and the Future Evolution of Languages. Additional volumes to this report providing a structured review of the leading products now available are developed. "Fourth Generation Languages" is a 250-page report and costs \$150. For more information, contact SAVANT, Suite 980, 1901 Avenue of the Stars, Century City, Los Angeles, CA 90067, (213) 277-0355.

### KEY OF C

The Hayden Book Company is offering a "practical sourcebook that shows you everything you need to know about programming in the C language." The publisher also claims the book will give you a clear understanding of this Bell Labs programming language whether you are a novice or an experienced programmer. The book contains over 90 sample programs with step-by-step explanations of all procedures involved. It also covers C essentials such as program looping, decision making, arrays, functions, structures, character strings, op-

eration on bits, and working with larger programs. Plus, the book includes a discussion of the language's most recent features, a comprehensive summary of the language, a list of commonly made programming mistakes, and the calling sequences for many of the functions in the Unix Standard C Library. The 384-page book by Stephen B. Kochan costs \$18.95. For more information, contact Hayden Book Co., 50 Essex St., Rochelle Park, NJ 07662, (201) 368-2202.

### SATELLITE COMMUNICATIONS

Lifetime Learning Publications has just published a book by Robert M. Gagliardi entitled *Satellite Communications*. The book is designed to help engineers and scientists understand these communications systems by learning the terminology, models, analysis procedures, and latest design directions of modern satellite links. The 474-page, hardcover book introduces the topic by stressing applications rather than detailed mathematical theory. It focuses on systems analysis and block diagram design as opposed to operational and hardware details or circuit description. The book attempts to present a unified approach to studying the satellite communication field. To order the \$39 book, contact Lifetime Learning Publications, 10 Davis Dr., Belmont, CA 94002, (415) 595-2350.

### NEW ENGLAND DIRECTORY

The Bradford Company has compiled and published a listing of 600 companies in New England that use computers and employ computer professionals. Listings contain demographic profiles of each company, including name, address, telephone number, major business, SIC codes, other locations, most recent fiscal sales, growth rate of fiscal sales, number of New England employees, and company officers. Dp department information includes hardware, software, and languages utilized, as well as databases employed, major applications implemented, and current staff size plus growth possibilities. Employee benefits and user hardware are also provided. While the book is designed for those seeking employment opportunities in New England, the company claims it is also a valuable resource tool for anyone selling computer products and services. The book sells for \$28.50. For more information, contact The Bradford Company, P.O. Box 256, Scituate, MA 02066, (617) 545-5750.

### CONTROLS FOR STRUCTURED SYSTEMS

Yourdon Press offers a book, *Building Controls Into Structured Systems* that details how to add internal controls into both new and existing systems. The publisher claims the book includes two practical tools that managers need to assure the accuracy, com-

## SOURCE DATA

pleteness, and security of a system's data. The first tool, based on a "decision tree" is used during analysis. It identifies appropriate controls for particular applications, in either structured or unstructured projects. The other is called Phase-Related Control and tells when to build each type of control. The 168-page book costs \$29 for hardcover and \$22 for the softcover edition. To order, contact Yourdon Press, 1133 Avenue of the Americas, New York, NY 10036-6748, (212) 391-2828. The company accepts Visa and MasterCard orders.

### MICRO GRAPHICS TECHNIQUES

A new book by Bruce Artwick, author of *Microcomputer Interfacing*, promises to show you how to build and program a low-cost, microcomputer-based graphics system. Published by Prentice-Hall Inc., *Applied Concepts in Microcomputer Graphics* details state-of-the-art and cost-effective computer and graphics hardware, high-performance graphics software, and tested display methods. The publisher also claims the book provides special techniques to help you reduce flickering, improve transformation-computation speed, speed up image generation, and boost software performance. The book is offered on a 15-day trial basis and costs \$27.95 plus postage and handling. The volume is 384 pages and includes 169 detailed tables, charts, and block diagrams. For ordering information, contact Prentice-Hall Inc., Book Distribution Center, Route 59 at Brook Hill Dr., West Nyack, NY 10995, (914) 358-8800.

### TIME AND TIME AGAIN . . .

QED Information Sciences Inc. has published a book to help show you how to achieve personal and career goals by managing your time effectively. Stewart L. Stokes, author of the book, provides a series of workshop exercises to help you develop the techniques of effective time and priority management. The publisher claims you can put time on your side with "action-oriented" steps such as combat strategies to battle universal time control problems; the 80/20 rule and how to apply it to your life; step-by-step advice on keeping a time log; a four-point method for changing self-defeating attitudes; five key communication difficulties and how to solve them; the 10 elements of implementing an action plan. The 142-page book costs \$14.95 (\$12.95 if pre-paid). To order, contact QED Information Sciences Inc., QED Plaza, P.O. Box 181, Wellesley, MA 02181, (800) 343-4848.

## PERIODICALS

### AI UPDATES

Artificial Intelligence Publications notes that AI is expected to generate \$9 billion in revenues by 1993, and that to meet Japan's fifth generation computer challenge, the

U.S. government estimates one federal agency alone could provide up to \$300 million in research funding over the next three years. To help you keep track of what's going on in the field, the company offers "The Artificial Intelligence Report," which is published 10 times a year. An annual subscription costs \$200 domestically and \$225 internationally. It is designed to keep readers abreast of new AI applications, companies, growth potential, AI research emerging from laboratories, U.S. and foreign AI R&D, AI applications in the military, and the social concerns of AI development. For more information, contact Artificial Intelligence Publications, 95 First St., Los Altos, CA 94022, (415) 949-2324.

## SEMINARS

### T-1 TECH

Timeplex is offering an educational seminar intended "to satisfy the current rising interest in 1.544 million bit per second digital transmission, known as T-1." The seminar will be taught by the company's network analysts, who have extensive experience in the field. Part of the presentation on transmission facilities will be given by AT&T Communications (formerly Long Lines). The three-day seminar will cover basic data communications and multiplexing concepts; T-1's background, description of facilities, guidance in analyzing equipment for T-1 applications; and case histories and a look at network topologies and tariff costs. The dates and locations of the course are: March 27-29, Tampa, Fla.; April 3-5, San Francisco, Calif.; April 24-26, Chicago, Ill.; May 15-17, Toronto, Canada; June 5-7, Boston, Mass.; and July 17-19, Washington, D.C. The price of the seminar is \$595, including handouts, reference materials, course notes, continental breakfast, lunch on Wednesday, and coffee breaks. For more information, contact William A. Flanagan, Timeplex Inc., 400 Chestnut Ridge Rd., Woodcliff Lake, NJ 07675, (201) 930-4600. In Canada, contact Timeplex Canada Inc., Unit 44, 90 Nolan Court, Markham, Ont. L3R 4L9 Canada, (416) 475-1961.

### COMPUTER LAW BRIEFING

Between the increasing use of computers and constant design changes in software and hardware, attorneys face quite a challenge in computer litigation, says the Practising Law Institute. In the Institute's view, the traditional legal concepts of trade secrets, copyright, antitrust, and misappropriation must be innovatively applied to disputes generated by high-tech industry. The Institute is offering a two-day seminar to attorneys who represent both users and vendors of computer hardware and software. Technical knowledge of computer operation is unnecessary, but familiarity with the

concepts of commercial law and litigation is helpful. The seminar costs \$375 and includes a course handbook. For those who cannot attend the course, the company sells the book for \$35. The seminar will be held at the New York Hilton, on March 19 and 20. For more information, contact Nancy B. Hinman, Practising Law Institute, 810 Seventh Ave., New York, NY 10019, (212) 765-5700.

### AMS ON THE FUTURE

The 65th International Conference of the Administrative Management Society will be held May 29 through June 1 at the Marriott Hotel in New Orleans. The event's theme is "Megatrends for Managers." The conference program will be headed by John Naisbitt, author of the book *Megatrends*. During a breakfast session on Thursday, May 31, Naisbitt will comment on the major trends that are reshaping society. Office automation consultant Amy Wohl will speak on trends in office systems integration; Dr. Morris Massey will explain how to boost career effectiveness; and there will be a panel discussion featuring three leading economists from the United States, Canada, and the United Kingdom. Over 20 sessions and workshops are scheduled for the three-day event, and each is open to all management professionals. Topics will include adapting to personal computers, integrity in management, investment policies for small business, employee assistance programs, voice processing, and the new office environment. The conference will be held in conjunction with the Gulf Coast Computer and Office Show, also at the Marriott. Registration fees are \$395 for non-AMS members and \$365 for members (fees without meal functions run \$295 and \$275 respectively). For more information, contact Conference Services, AMS, 2360 Maryland Rd., Willow Grove, PA 19090, (215) 659-4300.

### CONFERENCE RELOCATION

Because of a serious hotel fire, the IEEE-sponsored INFOCOM '84 Conference, previously scheduled for April 9-12 at the Cathedral Hill Hotel in San Francisco, will be relocated to the Hotel Meridien, 50 Third St. (opposite Moscone Center), San Francisco. The dates of the conference are the same. For more information, contact Judy Estrin, General Chairperson, Bridge Communications, 10401 Bubb Rd., Cupertino, CA 95014, (408) 446-2981.

### PC INTERFACING

The Virginia Polytechnic Institute and State University is offering its Personal Computer Interfacing Workshop. Participants will receive hands-on experience in scientific interfacing on the following computers: IBM PC; Apple; Radio Shack models 1, 3, 4, and 100; Commodore Vic 20 and 69; Sinclair



models 1500 and 2000; and the STD BUS systems. The course costs \$495 and will be held at the university on March 26-29. For more information, call or write Dr. Linda Leffel, C.E.C., Virginia Tech, Blacksburg, VA 24061, (703) 961-4848.

### AIIM FREEBIES

The Association for Information and Image Management (AIIM) is offering three free executive-level seminars in conjunction with its upcoming Conference and Exposition April 10-12 in Chicago. The briefings are entitled "The Competitive Edge," "Integrating Today's Technologies into the Information Center," and "Office Automation, 1990s." The seminars present general information and will offer the audience a comprehensive overview of office automation technology—present and future. The vital role information professionals play in bringing about the acceptance of office automation will also be stressed. The seminar will discuss how the tools and techniques currently available can represent immediate payback to the user organization in terms of increased productivity, value added, and cost-efficiency. The conference begins April 9 and runs through the 12th at the O'Hare Expo and Conference Center. For more information, contact Sue Wolk, Director of Conference and Exposition, AIIM, 1100 Wayne Ave., Silver Spring, MD 20910, (301) 587-8202.

### FINANCIAL PC INTEGRATION

"Financial Information Systems—Integrating Personal Computers" is the theme of a three-day conference to be held in Chicago March 14-16. Sponsored by the National Institute for Management Research, the conference will focus on the application of new computer hardware, software, communication approaches, and management techniques to successfully integrate PCs for use in financial information and management systems. Also planned is the examination of recent innovations, methods, and case studies. The fee for attending the conference is \$595 with discount rates for groups. For more information, contact Dept. PR, NIMR Seminars, P.O. Box 3727, Santa Monica, CA 90403, (213) 450-0500.

### COMPUTER INTEGRATED MANUFACTURING

Companies faced with international competition are turning to computer-controlled automation to help them survive. They may soon find they are faced with crucial challenges in managing their organizations. To help you understand the management implications in achieving computer integrated manufacturing (CIM), CAM-I's International Spring Seminar is directed to the concerns of senior management in advanced industrial companies. Speakers will cover such topics as CIM concepts and achievements; CIM

for special applications; database technology; data and software interfacing; management control of data; implementation stages; human factors and organizational change; company standards and manufacturing style. The seminar will be held May 8-10 in Montreux, Switzerland. Attendance fees are \$375 for members and \$475 for nonmembers. For more information, contact Rhonda Gerganess, Manager, Conference Services, CAM-I Inc., 611 Ryan Plaza Dr., Suite 1107, Arlington, TX 76011, (817) 860-1654. In Europe, contact Conference Manager, CAM-I Inc., Newfoundland House, Poole Quay, Poole, Dorset, England.

### IN-HOUSE TRAINING

A series of video courses is being marketed by Advanced Systems Inc. The series, a 10-course, 28-videotape library, covers computers in business and includes topics such as Computers in Business, Installing and Managing a Business Computer, Office Automation, Computer Graphics in Business, Programming Principles, Understanding a Database Management System, Implementing a Database Management System, The Manager's Introduction to Data Communications, Introduction to Networks, and Networking. The company offers more than 2,500 videotapes, micro-computer diskettes, audio cassettes, and associated course materials for internally administered training programs as well as computer assisted instructional programs. For more information about their offerings, contact Pat Sorrentino, Director, Product Marketing, Advanced Systems Inc., 2340 S. Arlington Heights Rd., Arlington Heights, IL 60005, (312) 981-4260.

### VENDOR LITERATURE

#### SPACE CASES

Spacesaver Corporation is offering its free brochure on the specifications of its line of high-density mobile storage systems for office, government, institutional and architectural markets. It also includes a description of Spacesaver's custom engineering and planning services, including its Computerized Space Efficiency Audit. SPACE-SAVER CORP., Ft. Atkinson, Wis.

**FOR DATA CIRCLE 350 ON READER CARD**

#### WHAT'S UP DOC?

A four-page brochure on Tech-Doc explains a computer-based reference system designed to improve engineering productivity and quality by reducing component research time and providing a broader range of options. The brochure also explains Micro-Index, a microcomputer-based indexing system that requires no prior computer experience to use. INACOM INTERNATIONAL, Denver, Colo.

**FOR DATA CIRCLE 351 ON READER CARD**

### I/O MODULES

The 1771 System of Universal Input/Output Modules for machine and process automation is described in a new 16-page, four-color brochure from Allen-Bradley Systems Division.

The brochure contains over 50 different discrete and intelligent I/O modules, all compatible with Allen Bradley's PLC-3 and PLC-2 family of programmable controllers. ALLEN-BRADLEY SYSTEMS DIVISION, Highland Heights, Ohio.

**FOR DATA CIRCLE 352 ON READER CARD**

### KNOW YOUR ONIONS

MICOM is offering a 12-page color brochure on its new Micro7400 Protocol Converter, a device that enables up to 12 asynchronous terminals (or PCs emulating terminals) to access IBM mainframes as if they were IBM's own 3270-class devices. Just try not to get hungry with all the epicurean illustrations. MICOM, Chatsworth, Calif.

**FOR DATA CIRCLE 353 ON READER CARD**

### KINETIC PCS

KineticSystems Corp. has published a six-page color brochure describing its new line of personal computer systems for data acquisition and process control. It describes the company's variety of choices for utilizing a versatile personal computer for both standalone and distributed control. KINETIC-SYSTEMS CORP., Lockport, Ill.

**FOR DATA CIRCLE 354 ON READER CARD**

### THIN FILM BROCHURE

The Egyptian jewelry-like beauty of Hybrid Systems resistor networks is displayed in the cover shot of its 12-page thin film brochure. Products in the catalog include chip resistors, chip networks, packaged networks, substrates with conductors, and substrates with resistors, all used by designers of hybrid microcircuits. HYBRID SYSTEMS CORP., Billerica, Mass.

**FOR DATA CIRCLE 355 ON READER CARD**

### PAY SAY

ADP is offering a brochure containing five case histories of dissimilar organizations that use its computerized payroll service. AUTOMATIC DATA PROCESSING INC., Roseland, N.J.

**FOR DATA CIRCLE 356 ON READER CARD**

### YOUR PLACE OR THEIRS?

Leeds & Northrup is offering its 24-page catalog outlining 34 instrument, electronics, and microprocessor training courses offered by the company's Technical Training Center. The guide includes a thorough description and outline of each course. These can be conducted at the vendor's center in Horsham, Pa., or "at your place" or "near your place." LEEDS & NORTHRUP CO., North Wales, Pa.

**FOR DATA CIRCLE 357 ON READER CARD**

# Get involved with drugs before your children do.

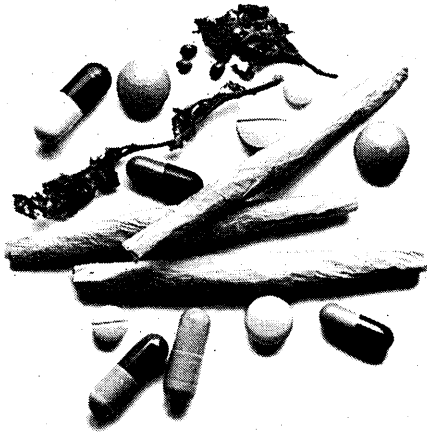

Sooner or later, someone's going to offer to turn your children on.

It could be their best friends.

And chances are, you won't be anywhere in sight.

So what can you do?

Obviously, the time to talk to your children about drugs is before they have to make a decision on their own.

Which means you have to learn something about drugs.

Learn the dangers. And learn to recognize the signs of drug use. Listlessness in your child. Sudden drop in school grades. Temper flare-ups and staying out late a lot.

Learn about peer pressure on a twelve-year-old. Then show them you understand how important their friends are to them. But also tell them that real friends won't insist they do drugs.

Check your own personal habits. You can't tell a child about the dangers of drugs with booze on your breath.

But it's through love and understanding that you can be the most effective. Threatening to tear their arms off just won't work.

You can get a lot more ideas from the booklet, "Parents: What You Can Do About Drug Abuse." Write: Get Involved, P.O. Box 1706, Rockville, Maryland 20850.

Remember, it doesn't always happen to someone else's kids.

After all, there are over 35 million drug users in America.

And they're all someone's children.

**Ad** A public service of this publication  
Council and the National Institute on Drug Abuse.

## ADVERTISERS' INDEX

Advanced Business Computing .....	39
AGS Management Services .....	7
Amacor .....	127
Ampex .....	64
Ansul .....	146
Artificial Intelligence Corp. ....	22
Ashton Tate .....	35
Ashton Tate .....	72
Ashton Tate .....	52
Ast Research .....	76
AT&T .....	20-21
AT&T Technologies .....	41-43
Avanti Communications Corp. ....	15
Battelle .....	165
BASF .....	224-10
BBN Communications Corp. ....	176-177
Beehive .....	191
Bell Telephone Mfg. Co. ....	224-13
Bell Telephone Mfg. Co. ....	224-15
Boole & Babbage .....	228
Bridge Communications .....	114
Cal Comp .....	149
Callan Data .....	225-7
Candle Corp .....	2
CAP Gemini DASD Inc. ....	94
Cebit .....	224-16
Cincom .....	50-51
C ltoh .....	53
Compaq .....	6-7
Comnet .....	40
Computer Corp of America .....	82-83
Computer Security .....	227
Context Management Systems .....	181
Corona Data .....	69
Cullinet .....	80
Danish Data Electronics .....	54-55
Datagraphix .....	117
Datapoint .....	274-275
Data Products .....	19
Dataram Corp. ....	205
Datastream .....	168
Data Switch .....	178
D&B Computing Services .....	265
Decision Data Compute Corp. ....	9
Develcon Electronics .....	122
Digital Communications Assoc .....	30-31
Digital Communications Assoc. Tac Div. ....	102-103
Digital Equipment Corp. ....	166-167
Dilog .....	225-11
Direct Inc .....	12
Dylakor .....	108
Dysan .....	143
Elgar .....	216
Emcom .....	163
Emulux .....	192-193
Ericsson Alfaskop .....	224-8-9
Ericsson Alfaskop .....	196-197
Ericsson Inc. ....	16-17
Ericsson Infosystems .....	224-5
Fenwall .....	184
Fibronics Intl Inc. ....	81
Forte Data Systems Inc. ....	211
Four Phase .....	144-145
General Datacom .....	109
Genicom .....	247
Genstar Rental Electronics .....	100
GE Vidio .....	24
Hitachi .....	222
Hogan Systems .....	248
Hughes Aircraft .....	262
IBM - Modems .....	156-157
Incomnet .....	225-2
Infotron .....	70-71
Information Builders .....	235
Intergrated Business Computers .....	225-13
Intergrated Technologies .....	142
Israel Export Institute .....	224-6

# DEC → TO IBM/SNA

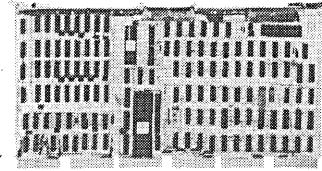

Now available...full SNA capability for your DEC computer! Comboard/SNA gives your terminals access to IBM interactive applications. Data can be transferred between systems transparently, all in the complete fully supported package, Comboard/SNA from Software Results.

Comboard/SNA is a proven and reliable, single-board, 256KB communications computer that plugs into your DEC Unibus. Teamed with Comboard software, the system is a cost-effective solution to troublesome SNA communications problems.

Comboard/SNA allows your DEC to emulate an IBM PU Type 2 communications node. You have a full gateway into your SNA without the trouble of passing through a secondary network.

For further information, fill in the coupon below or call Software Results... the leader in DEC to IBM communications.

## COMBOARD

Communications Results

NAME \_\_\_\_\_

COMPANY \_\_\_\_\_

ADDRESS \_\_\_\_\_

CITY, STATE, ZIP \_\_\_\_\_

Telephone \_\_\_\_\_

**SOFTWARE RESULTS CORPORATION**

Call Toll-free  
**1-800-SRC-DATA**  
(1-800-772-3282)

In Ohio call collect 1-614-267-2203

2887 Silver Drive, Columbus, Ohio 43211 • Telex: 467-495 SRC DATA CI

COMBOARD™ Software Results Corporation  
DEC UNIBUS™ Digital Equipment Corporation  
IBM, SNA™ International Business Machine Corp.

**CIRCLE 141 ON READERCARD**

MARCH 1984 261

JBM Electronics.....	127
Johnson Systems.....	125
Kel Inc.....	96
Kennedy.....	CV 2
Leading Edge.....	CV 3
M/A-Com Linkabit.....	92
Martin Marietta.....	164
Masstor.....	67
Mathmatica.....	47
Matrix Instruments.....	97
Maxell.....	219
McCormack & Dodge.....	49
McCormack & Dodge.....	141
MDS.....	10-11
Megatek.....	236
Memorex.....	89
Micom Systems Inc.....	1
Microcraft Corp.....	233
Modem Mart.....	112
Morino Assoc.....	113
MSA.....	99
MTTR.....	95
NEC.....	202-203
NEC.....	110-111
NCR.....	4
NCR.....	65
Nokia Data.....	224-2
Northern Telecom.....	106-107
Northern Telecom.....	128-129
Nova Graphics.....	225-5
Quality Micro Systems.....	59
Qume.....	155
Randomex.....	225-8
Raytheon Data Systems.....	118-119
RCA CVLIX.....	101
SAS.....	5
Software Corp. of America.....	130
Software Intl.....	26-27
Software Results.....	261
Source EDP.....	266-267
Sperry Corp.....	151
SPSS.....	238
Storage Technology.....	87
Stratus.....	252
Synapse.....	245
Tandberg Data.....	57
Tandem.....	131-133
Tandem.....	86
Tektronix - Information Display.....	76-75
Teletype.....	CV 4
Televideo.....	221
3M - Commercial Tape.....	105
3M - Interactive Systems.....	189
Timenet.....	216
Timeplex.....	175
Transfer Technology Institute.....	115
Trans Net Corp.....	112
Trax.....	78
TRT.....	62-63
TRT.....	224-7
UCC Systems.....	90-91
Ungermann-Bass.....	171
Universal Data Systems.....	25
US Postal Service.....	58
Value Computing.....	28
Ventel.....	138
Visual Computer Inc.....	36-37
VM Software.....	56
Wang.....	79
Wang.....	77
Wyse Technology.....	213
Xerox.....	243

See us at  
**INTERFACE '84**  
Las Vegas, March 12-15  
Booth #1720

# HUGHES

## DATA PROCESSING SPECIALISTS

If you feel that your capabilities in data processing exceed your current opportunity to use them, look into Hughes. C&DP — our Communications & Data Processing Group — supplies users with more comprehensive, higher quality support than most information processing services. And state-of-the-art equipment (including Amdahl 580's, Amdahl 470's, IBM 4341's, HP 3000's and Honeywell DPS 8/70's) means up-to-the-minute challenges for our DP people.

We have opportunities at our Long Beach, Fullerton or El Segundo, California facilities for professionals with appropriate degrees and/or experience in one of these areas:

### SYSTEMS PROGRAMMING

IMS candidates must possess knowledge of IMS Internals, SMP, SYSGENS and performance tuning; experience with ACF/VTAM, VSAM and Fast Path desirable.

HP 3000 candidates must possess knowledge of MPE operating systems architecture, be able to analyze system software and hardware failures, resolve operating restraints, manage utilities and support a communications network interface.

VM/CMS Systems Programmer to be part of a technical support team responsible for a network of distributed processors. Candidate must be able to perform VM/CMS SYSGENS and required software maintenance; experience with RSCS, PVM and communications desirable.

### TELECOMMUNICATIONS

Experience in the areas of Microwave network, Voice Data PBX, Voice Data network, Packet-switched Data network, Teletype network, and/or Facsimile relay in technical and/or administrative capacity required.

Teleprocessing Analyst with experience with modems, TDM and Statistical Multiplexers, and data-switching equipment; state-of-the-art test equipment and diagnostic procedures; X.25 networks including configuration, analysis, and

implementation; communications protocols including ASCII/TTY, IBM 3270, 2780, 3780, HASP, and HDLC; experience in development of specifications, schedules, documentation, and operational procedures.

### USER SUPPORT

Business User Services Information Center Consultants and Systems Specialists are needed to support Statistical Analysis, Graphics, and Information Control software packages. Consulting positions require FOCUS or SAS-SAS/GRAPH experience. Systems Specialists need extensive VM/CMS EXEC and/or MVS/TSO CLIST development experience, COBOL or Assembler experience desirable. Engineering computer services personnel are required in the areas of: LSI, CAD applications, consulting and software development, mechanical CAD applications (solids modeling) computer-aided thermal analysis, and FORTRAN programming under VM/CMS.

Distributed Data Processing and Customer Services User Consultant/Educators are needed to support VM and MVS systems. Knowledge of VM/CMS, TSO, OS/JCL, and programming languages (FORTRAN, PL1, IBM Assembler 1) desirable. Consulting and/or teaching experience beneficial.

### OPERATIONS

Systems coordinators with background in large-scale systems operation of MVS and JES2. Schedule and production controllers with thorough knowledge of JCL, COBOL, or JES2. Computer operators with HP 3000 experience.

Data Processing Security Administrators with experience in risk analysis, contingency planning, and access controls. Candidates must have a good technical understanding of large state-of-the-art data processing environments including telecommunications and office automation.

### BUSINESS APPLICATIONS

Several project leaders and many programmers, analysts, and designers are needed now to work on our on-line, distributed, or batch systems. The various applications to be developed include:

Personnel Systems — Payroll, medical claims, employee benefits.

Financial Systems — Accounts payable, labor collection, project control, work in process, accounts receivable.

Management Systems — Contract administration, library management, information retrieval.

Manufacturing Systems — Inventory control, product data management, spare parts, bill of material, material requirements planning.

Experience required in COBOL, TSO, OS/JCL.

Additional experience desired in IMS DB/DC, Panvalet, Structured Analysis and Design, FORTRAN, BASIC, PL1, IMAGE DBMS, QEDIT, VIEW3000 INQUIRE, VM/CMS, CICS, MARK IV, Dartmouth Time-sharing, Jackson Design and Structured Testing experience also desirable.

Positions also available for Quality Assurance, Testing, Analysis and Design Consulting.

Hughes has an environment where you can work toward your full potential as a professional, with ongoing growth leading to ongoing opportunity. Our benefits are also exceptional — all that you would expect from an industry leader, on top of a highly competitive salary structure.

For consideration, send your resume to: Hughes Aircraft Company, Employment 63 (D-3), P.O. Box 4275, Fullerton, CA 92634.

*Creating a new world with electronics*

**HUGHES**

HUGHES AIRCRAFT COMPANY

Proof of U.S. Citizenship Required  
Equal Opportunity Employer

## CORPORATE COMMUNICATIONS & DATA PROCESSING

Attention:  
Manufacturers, Distributors,  
and Dealers of Office Automation  
Products, Services, and Supplies

Go With  
The Proven One!

## Exhibit at 12th Annual Presentation



### Longest-Running, National Office Automation/ Information Systems Conference & Exposition

- Great Marketing Area—Chicago, second largest city, third largest metropolitan area.
- Fabulous Show Location—McCormick Place, one of the largest and best equipped exposition halls in the country.
- Powerful Attendee Promotion—Imaginative, hard-hitting national, regional, and local advertising, direct mail, and public relations campaigns designed to bring qualified attendees to your booth.
- Information-Packed Conference—Sponsored by the Association of Information Systems Professionals, a 16,000-member organization devoted to advancing the concept and practice of office automation and information systems.
- Experienced Show Management—Exposition managed by Prestige Expositions, Inc., trade show professionals with many years of experience in the management of NCC, INFO, Interface, Federal Computer Conference, and Computer Caravan.

Find out for yourself what the pros have known for years. Fill out and mail coupon today to receive no-obligation information on exhibiting at Syntopican XII.

Prestige Expositions, Inc.  
P.O. Box 424  
Hohokus, NJ 07423

Please supply information on exhibiting at Syntopican XII to be held July 19-21, 1984 at McCormick Place, Chicago.

NAME \_\_\_\_\_

TITLE \_\_\_\_\_

COMPANY \_\_\_\_\_

ADDRESS \_\_\_\_\_

CITY \_\_\_\_\_

STATE \_\_\_\_\_

ZIP \_\_\_\_\_

TELEPHONE ( ) \_\_\_\_\_

DTMN 0384



# OPPORTUNITY WITHOUT RISK.

**The biggest  
improvement in  
Savings Bonds in  
40 years.**

## New Variable Interest Rate.

Looking for an ideal investment? One with a variable interest rate? But one where rates can't drop below a certain level?

Well, there is one available to everyone, even if you have only \$25 to invest.

It's U.S. Savings Bonds. Now changed from a fixed to a variable interest rate, with no limit on how much you can earn.

## A Guaranteed Minimum.

Although interest rates will fluctuate, you're protected by a guaranteed minimum. And if you hold your Bond to maturity, you'll double your money. You may do even better.

Take another look at Savings Bonds. We did, and made them better.



**Take  
stock  
in America.**



A public service of this publication  
and The Advertising Council.

## Employment Scene

# ON THE JOB

### HIGHER AND HIRE

Job market analysts predict a good year in 1984. A nationwide survey by Fox-Morris Personnel Consultants, Philadelphia, Pa., shows a high-powered resurgence of professional-level hiring by U.S. companies is expected, with high-technology computer specialists at the top of the list.

The study also notes that the hiring freeze of the last two years "has been so deep that U.S. employers of every size in every industry group will be forced to re-staff aggressively as business rebounds."

The 1984 professional jobs forecast survey is the 10th annual such endeavor by Fox-Morris. The company claims the survey is a highly accurate job market barometer because of the company's bid-and-asked requirements of both employers and applicants.

Since business and personal computers are spreading like wildfire, Fox-Morris president Sanford L. Fox claims this "will continue to stimulate the corporate appetite for data processing specialists at every level." Fox also notes that programmers will be at the top of the hiring list with degreed software/systems engineers and analysts hot on their trail. 1984 demand is projected to soar 18.7% above '83 levels. Computer specialists will dominate the hiring plans of all industries in the Midwest, according to the survey; six out of every 10 new jobs will be computer-related.

In regard to engineering professionals, the study indicates that electrical/electronics engineers will be most in demand, followed by mechanical and industrial engineers. Design engineers will also be coveted, especially in the fields of CAD/CAM, robotics, telecommunications, research and development, quality assurance, and consumer products manufacturing.

Employment trends in the Southwest will veer away from oil and gas dependency toward high-tech engineering and

aerospace. Fox claims defense-related engineering jobs will multiply this year, particularly in aerospace, communications, and management consulting.

In the long run, demand will be greatest for engineers with two to six years of experience; employers consider such applicants to be ideal because of the combination of knowledge and reasonable salary expectations.

The survey claims that graduates with EE degrees will be most sought after at the entry level, followed by mechanical and industrial engineers.

While the demand for professionals will increase sharply this year, Fox-Morris claims salaries will rise only moderately, with an average range of 4% to 8%. The survey shows new engineering and mechanical engineers at a starting salary of around \$26,200 and \$25,370, respectively, with computer science graduates receiving about \$23,500. Young engineers and computer scientists in the two- to six-year experience category will pull in an average of \$29,150 to \$33,380, with higher-paying industry groups offering salaries close to \$40,000. Vice presidents of sales, engineering, finance, and human resources will command an average of \$65,000 to \$85,000, with top people getting over \$100,000.

For a more detailed look at Fox-Morris's survey, ask for the Fox-Morris Report by writing the company at 1500 Chestnut St., Philadelphia, PA 19102.

### ON THE ROAD AGAIN

More companies are offering job placement assistance to spouses when the primary wage earner moves to a new location. A survey by the Thomas Mangum Co., a Los Angeles-based management consulting firm, showed the number of women making the primary job move has grown too.

—Lauren D'Attilo

# Considering FOCUS?

## NOMAD2

# Should Be In The Picture!

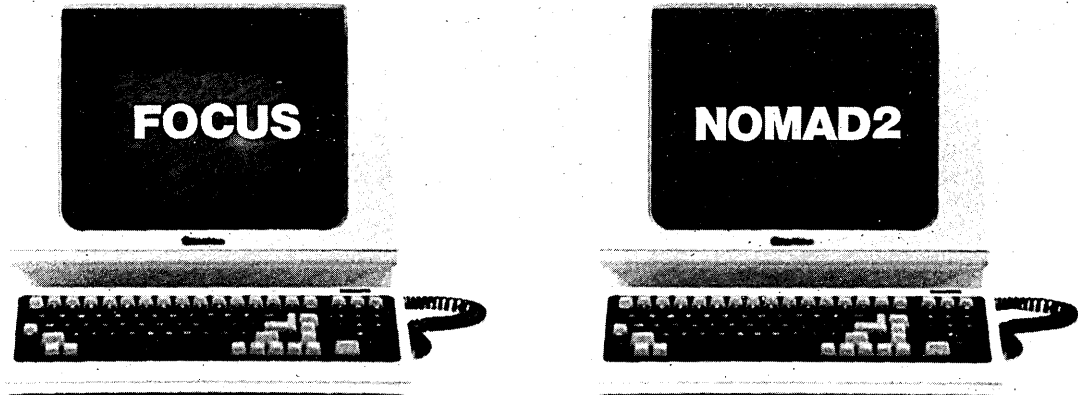

When NOMAD2 was first introduced to the marketplace, it changed forever the definition of what were known as 4th generation DBMS languages. Many followed, but none ever caught up because our development cycle never stopped and continues today.

Whether a comparison is made based on specific features, the scope of the product, or the sheer power it puts into the heart of an Information Center, NOMAD2 wins hands down.

Whether the issue is programmer productivity or end-user satisfaction the answer comes up NOMAD2.

Relational? Yes! English Commands? Yes! Interactive? Yes! Procedural? Yes! Modeling? Yes! Statistical Analysis? Yes! Multi-layers of Security? Yes! Graphics? Yes! Runs on VM? Yes! Runs on MVS/TSO? Yes!

If you're presently evaluating others, take a look at NOMAD2. We're confident of the outcome of that comparison.

### **NOMAD2... The Heart of the Information Center**

For more information write to:

Roger Cox  
D&B Computing Services  
187 Danbury Road  
Wilton, CT 06897

or call Roger Cox at (203) 762-2511

## **D&B Computing Services**

**DB** a company of  
The Dun & Bradstreet Corporation

\* NOMAD is a registered trademark of D&B Computing Services, Inc.

CIRCLE 144 ON READER CARD

**What are the  
cold, hard facts  
on computer salaries?**



# Find out in our new, free Salary Survey.

No doubt during 1983, you knew that many organizations took a hard line on awarding liberal salary increases.

Yet, on the other hand, did you know that salaries for *some* computer professionals soared right on through the uncertain business outlook?

Our 1984 Computer Salary Survey and Career Planning Guide will explain why many computer professionals are able to advance their careers more successfully than others:

- How some professionals—performing the same work and having a similar amount of experience—are earning significantly more than their peers.
- Why some professionals now earn as much as 25% more than they did last year.
- What emerging skills are most in demand and which positions command high salaries now and in the future.
- How size of firm and computer

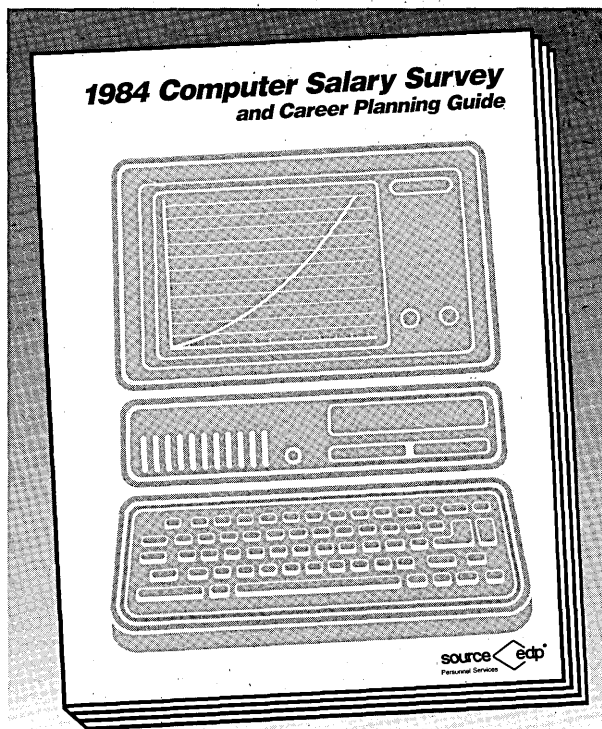

installation greatly affects compensation levels.

The new Survey is based on contacts with more than 44,000 computer professionals and 35,000 organizations. Not only are salary averages for fifty-eight positions reviewed (including ten new ones which we never before covered), but high and low compensation ranges are also covered.

Included are positions in programming, software, systems design, data base/data communications, Edp auditing, operations, computer sales, marketing, marketing support and management.

You owe it to yourself—especially if most of your career lies ahead—to call or write for your free copy today.

**source edp**  
Personnel Services

The world's largest recruiting firm devoted exclusively to the computer profession.

## Call Source™ today for your free copy

### Is your salary still frozen?

Call the Source Edp office nearest you for a free copy of our new 32-page report. We'll mail a copy to you in strict confidence, without obligation.

If unable to call, write:

**Source Edp  
Department D1  
P.O. Box 7100  
Mountain View, CA 94039**

When writing, please include your title.

#### United States:

<b>Alabama</b>	
Birmingham	205/322-8745
<b>Arizona</b>	
Phoenix	602/279-1010
Tucson	602/792-0375
<b>California</b>	
<b>Northern</b>	
Mountain View	415/969-4910
Sacramento	916/446-3470
San Francisco	415/434-2410
Walnut Creek	415/945-1910
<b>Southern</b>	
Fullerton	714/738-1313
Irvine	714/833-1730
Los Angeles/ Downtown	213/688-0041
Los Angeles/ South Bay	213/540-7500
Los Angeles/West	213/203-8111
San Diego	619/231-1900
San Fernando Valley	818/781-4800
<b>Colorado</b>	
Denver	303/773-3700

<b>Connecticut</b>	
Danbury	203/797-0590
Hartford	203/522-6590
New Haven	203/787-4595
Stamford	203/967-4888
Stratford	203/375-7240
<b>District of Columbia</b>	
Washington D.C.	202/293-9255
<b>Florida</b>	
Fort Lauderdale	305/491-0145
Jacksonville	904/356-1820
Miami	305/624-3536
<b>Georgia</b>	
Atlanta	
Downtown	404/588-9350
North	404/953-0200
<b>Illinois</b>	
Chicago/E. Loop	312/861-0770
Chicago/W. Loop	312/346-1280
Oak Brook	312/986-0422
Rolling Meadows	312/392-0244
<b>Indiana</b>	
Fort Wayne	219/432-7333
Indianapolis	317/631-2900
<b>Iowa</b>	
Des Moines	515/243-0191
<b>Kansas</b>	
Overland Park	913/888-8885
Wichita	316/688-1621
<b>Kentucky</b>	
Louisville	502/581-9900
<b>Louisiana</b>	
Baton Rouge	504/924-7183
New Orleans	504/561-6000
<b>Maryland</b>	
Baltimore	301/727-4050
Greenbelt	301/441-8700
Towson	301/321-7044
<b>Massachusetts</b>	
Boston	617/482-7613
Burlington	617/273-5160
Wellesley	617/237-3120
<b>Michigan</b>	
Detroit	313/259-7607
Grand Rapids	616/459-6539

Lansing	517/484-4561
Southfield	313/352-6520
Troy	313/362-0070
<b>Minnesota</b>	
Minneapolis	
West	612/544-3600
Downtown	612/332-6460
St. Paul	612/227-6100
<b>Missouri</b>	
Kansas City	816/474-3393
St. Louis	314/862-3800
<b>Nebraska</b>	
Omaha	402/346-0709
<b>New Hampshire</b>	
Nashua	603/880-4047
<b>New Jersey</b>	
Cherry Hill	609/482-2600
Edison	201/494-2800
Morristown	201/267-3222
Paramus	201/845-3900
Princeton	609/452-7277
Somerset	201/469-9444
Somerville	201/526-9658
<b>New Mexico</b>	
Albuquerque	505/247-4270
<b>New York</b>	
Albany	518/482-2035
Buffalo	716/835-9630
<b>New York City</b>	
Grand Central	212/557-8611
Penn Station	212/736-7445
Wall Street	212/962-8000
Rochester	716/263-2670
Syosset, L.I.	516/364-0900
Syracuse	315/422-2411
White Plains	914/683-9300
<b>North Carolina</b>	
Charlotte	704/552-6577
Greensboro	919/379-1155
Raleigh	919/847-7605
Winston-Salem	919/724-0630
<b>Ohio</b>	
Akron	216/535-1150
Cincinnati	513/769-5080
Cleveland	216/771-2070
Columbus	614/224-0660
Dayton	513/461-4660
Toledo	419/242-2601

<b>Oklahoma</b>	
Oklahoma City	405/722-7410
Tulsa	918/599-7700
<b>Oregon</b>	
Portland	503/223-6160
<b>Pennsylvania</b>	
King of Prussia	215/265-7250
Philadelphia	215/665-1717
Pittsburgh	412/261-6540
<b>Rhode Island</b>	
Providence	401/751-0065
<b>South Carolina</b>	
Columbia	803/256-7446
Greenville	803/271-7044
<b>Tennessee</b>	
Nashville	615/256-0625
<b>Texas</b>	
Austin	512/479-0720
Dallas	
Central	214/954-1100
North	214/387-1600
Fort Worth	817/338-9300
Houston	
Downtown	713/751-0100
Galleria/Post Oak	713/439-0550
San Antonio	512/342-9898
<b>Utah</b>	
Salt Lake City	801/966-3900
<b>Virginia</b>	
McLean	703/790-5610
<b>Washington</b>	
Seattle	206/454-6400
Spokane	509/838-7877
<b>Wisconsin</b>	
Green Bay	414/432-1184
Madison	608/251-0104
Milwaukee	414/277-0345
<b>Canada:</b>	
<b>Ontario</b>	
Toronto	
Don Mills	416/425-5730
Downtown	416/865-1125
Mississauga	416/848-3344



# The Marketplace... JOB MARKETPLACE

## ADVERTISERS' INDEX

### SOFTWARE SERVICES

Applied Information .....	269
Business Information Systems .....	269
Dataware, Inc. ....	269
Dataware, Inc. ....	269
Dataware, Inc. ....	269
Manufacturing EDP Consulting, Inc. ....	269
Mitchell & Gauthier Associates, Inc. ....	269

### DATA PROCESSING

Eastern States .....	268
----------------------	-----

### BUSINESS OPPORTUNITIES

Mincron .....	268
---------------	-----

### JOB MARKETPLACE

Foxfire Development Corp. ....	268
Hekimian Labs .....	268
Pacific Bell .....	268

## JOB MARKETPLACE

### MIS PROFESSIONALS

Hekimian Laboratories, a leading manufacturer of telecommunications instrumentation, is seeking Management Information Systems programming and operations professionals to staff a new computer center. Candidates should have experience with integrated manufacturing and accounting applications software. These positions require Bachelor's degrees or equivalent.

We offer an excellent benefits package including medical, dental and life insurance, and a retirement program. Qualified candidates should send confidential resume and salary history to Ed Coward, Personnel Administrator.

**HEKIMIAN LABORATORIES, INC.**  
9298 Gaither Road  
Gaithersburg, MD 20877  
EOE M/F

CIRCLE 500 ON READER CARD

### STAFF ANALYST

*Pacific Bell is facing an exciting future, with a new identity and new goals! Now you can be among the first to work in our exciting, new state-of-the-art center in San Diego.*

*As an integral part of our time-sharing organization, you will be responsible for systems software maintenance, systems gens and performance. You will also be involved with programming and some assembler utility routines. You will qualify if you have 2-3 years' VM/CMS systems programming experience. A BS or Computer Science degree would make you especially competitive, as would strong oral/analytical communication skills. This job may require some overtime and travel. One major highlight of this position is that you will have the professional freedom to work in an unsupervised, unstructured environment. Salaries for this position can range from mid to high thirties (depending on qualifications) and our benefits are outstanding.*

*Send your resume to Pacific Bell, Management Personnel, 1001 Wilshire Blvd., Suite 200, Dept. EG-17, Los Angeles, CA 90017. Relocation not provided. Principals only, please. We are an equal opportunity employer.*

**PACIFIC BELL**

CIRCLE 501 ON READER CARD

## BUSINESS OPPORTUNITIES

### EQUITY+

We are looking for accomplished, highly motivated professionals now contemplating a business start-up. Individuals whose prime asset is communicative ability and experience in MIS management or software-related sales. We offer five years of software services growth experience and leadership identity in an established, yet continually expanding IBM marketplace. Our training, administrative support and marketing tools are providing our nationwide associate branch owners with accelerated equity growth, plus six-figure earnings. There is no investment fee. To learn more, please write in confidence with a summary of your professional experience.

Box MBWD 4120  
261 Madison Avenue  
New York, N.Y. 10016

CIRCLE 503 ON READER CARD

## DATA PROCESSING

### WANTED.

**Unique data bases for videotex provider.**

Howard Blankman  
Incorporated,  
76 North Broadway,  
Hicksville, N.Y. 11801

CIRCLE 502 ON READER CARD

## Engineering

### R&D ENGINEERS

We are recruiting personnel for a high level R&D facility which develops new microcomputer technology for a major East Coast computer manufacturer. The following positions are available immediately:

**PRODUCT DEVELOPMENT MANAGER**-must have considerable knowledge and experience of both hardware and software design and development. Must be familiar with the microcomputer industry and have experience with coordinating the activities of a staff of engineers in an aggressive R&D environment.

**SENIOR MICROCOMPUTER PROGRAMMERS**-must have 10-15 years of in-depth experience with Z80's, 8086's, etc. and with heavy emphasis on operating systems such as CP/M, MS DOS.

**FIRMWARE PROGRAMMER**-Must be familiar with V80 and 8086 Assembly language. Hardware experience very desirable.

**CORPORATE DP MANAGER**-15-20 years experience with DEC systems, with special emphasis on VAX.

**SR. MICROPROCESSOR LOGIC DESIGNER**-must have 5-10 years experience with microprocessors and digital design; assembly language programming experience desirable.

**SOFTWARE COORDINATOR**-Will assist software vendors in implementing application program; extensive experience in writing application programs required. These six positions will be filled immediately and additional positions are available for: ANALOG AND DIGITAL TECHNICIANS and ELECTRONIC DRAFTSMEN.

### HILTON HEAD ISLAND

Our R&D facilities are located in this world famous resort where you'll enjoy golf, tennis, boating, deep sea fishing and miles and miles of some of the most beautiful and secluded beaches on the East Coast. In addition to a modern, well-appointed facility, you'll appreciate the island's excellent schools, active social life and yearround temperate climate. You will receive the best compensation package in the industry, and be an active participant in developing new computer concepts and technology. **RESPOND NOW!** For prompt consideration, call (803) 842-2511, or submit a resume, including salary history and salary requirements to:

Donald Reed  
Support Services Manager  
FOXFIRE DEVELOPMENT CORP.  
The Professional Bldg., S-300; Hilton Head Island, SC 29928  
All inquiries will be held in the strictest confidence. EOE M/F.

CIRCLE 504 ON READER CARD



**PDP-11 & VAX Software**

EasyEntry  
Quick form design  
and data entry system

AIS-PLI  
ANSI Subset G  
PL/I Compiler

BURCOM-11  
PDP-11/Burroughs  
Communications System

1-800-334-5510

**applied information systems**

500 Eastowne, #207  
Chapel Hill, NC 27514  
(919) 942-7801

CIRCLE 506 ON READER CARD

**IBM S/34/36/38**

**COBOL**

- General Ledger
- Accounts Receivable
- Accounts Payable
- Payroll/Personnel
- Inventory Management
- Manufacturing Systems

• MFG/EDP IS A VALUE ADDED REMARKETER FOR THE IBM S/36 •

**MFG/EDP**

P.O. BOX 54, BUFFALO, N.Y. 14213  
716 - 885 - 1772

CIRCLE 507 ON READER CARD

**PL/1 TO COBOL**

Dataware's Software Translator automatically converts from IBM PL/1 to ANS COBOL (DOS or OS). The Translator is capable of handling IBM OS or DOS (48 or 60 character set) source programs as input.

For more information on this translator or the others listed below, please write or call today.

- EASYCODER/TRAN to COBOL
- BAL/ALC to COBOL
- AUTOCODER/SPS to COBOL
- COBOL to COBOL

The Conversion Software People  
**Dataware, Inc.**  
2565 Elmwood Avenue  
Buffalo, New York 14217  
(716) 876-8722 • TELEX: 91519

CIRCLE 508 ON READER CARD

**AUTOCODER/SPS to COBOL**

Dataware's software translator automatically converts a high percentage of SPS/1400 Autocoder source code to ANS COBOL (DOS or OS).

The Translator converts from:

- IBM 1401
- IBM 1401 SPS
- IBM 1440
- IBM 1410
- IBM 7010

can be mixed in a single source program.

For more information, call or write today.

The Conversion Software People  
**Dataware, Inc.**  
2565 Elmwood Avenue  
Buffalo, New York 14217  
(716) 876-8722 • TELEX: 91519

CIRCLE 509 ON READER CARD

**Dataware Software Translators**

**RPG to COBOL**

Converts RPG and RPG II programs to the industry standard ANS COBOL (DOS or OS). The translator achieves an extremely high percentage of automatic conversion (approaching 100%) of the source code.

**RPG to PL/1**

Converts RPG and RPG II programs to an optimized PL/1 (DOS or OS). The translator achieves an extremely high percentage of automatic conversion (approaching 100%) of the source code.

For more information, call or write today.

The Conversion Software People  
**Dataware, Inc.**  
2565 Elmwood Avenue  
Buffalo, New York 14217  
(716) 876-8722 • TELEX: 91519

CIRCLE 510 ON READER CARD

**CICS USERS**  
**Screens MadeEasy**

**BMS MAPS WITHOUT PROGRAMMING**

**ONLINE SCREEN DESIGN**

**AUTOMATIC**  
BMS CODE  
COPYBOOKS  
DOCUMENTATION  
PROTOTYPING

**ALL 3270 FEATURES**

*Business Information Systems, Inc.*  
3442 Stellhorn Road  
Fort Wayne, Indiana 46815  
219/485-9671

CIRCLE 511 ON READER CARD

**ACSL Advanced Continuous Simulation Language**

ASCL is a continuous system simulation language based on FORTRAN and designed to help the engineer or scientist mathematically model and analyze the behavior of systems described by time dependent non-linear ordinary differential equations.

**AVAILABLE ON**  
Control Data  
Cray  
IBM  
Gould SEL  
Univac  
DEC 10 / 20 / VAX  
Prime  
Perkin-Elmer  
Harris  
Apollo

**STANDARD FEATURES**  
No limit on program size  
Efficient model execution  
FORTRAN compatible  
User selectable  
Integration methods  
Interactive and batch graphics  
Interactive analysis of model

**NEW FEATURES**  
DISCRETE modeling section for digital controllers  
Eigenvalue, Eigenvalue and Steady State Analysis  
State Event system handles discontinuities

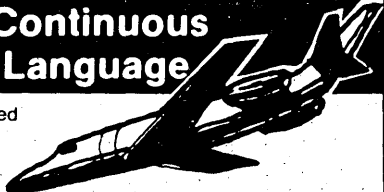

**Mitchell & Gauthier Assoc.**  
290 Baker Avenue  
Concord, MA 01742 • 617/369-5115 • Telex: 951572

CIRCLE 512 ON READER CARD

## ADVERTISING OFFICES

Advertising Sales Manager:

**William J. McGuire**  
New York, NY 10022  
875 Third Ave.  
(212) 605-9715

Marketing Services Manager:

**Kathleen A. Murray**  
New York, NY 10022  
875 Third Ave.  
(212) 605-9723

Eastern District Managers:

**Francie Bolger, John M. Gleason**  
New York, NY 10022  
875 Third Ave.  
(212) 605-9400

New England District Managers:

**Jack Orth, John M. Gleason**  
Newton, MA 02159  
181 Wells Ave.  
(617) 964-3730

Mid-Atlantic District Mgr.:

**Patricia Joseph**  
Plymouth Meeting, PA 19462  
Plymouth Plaza, Suite 201  
(215) 825-4410

Southern District Managers:

**Michael W. Andrea**  
4 Executive Park Drive N.E.  
Suite 1205  
Atlanta, GA 30329  
(404) 633-5112

**Warren A. Tibbetts**

West Palm Beach, FL 33406  
7621 West Lake Dr., Lake Clark Shores  
(305) 964-6298

Midwest District Mgr.:

**Joseph P. Gleason**  
Chicago, IL 60601  
3 Illinois Center Building, 303 East Wacker Dr.  
(312) 938-2926

Western District Managers:

**William M. Wilshire**  
Irvine, CA 92715  
2061 Business Center Dr., Suite 111  
(714) 476-2511

**Robert J. Rielly**

Los Angeles, CA 90035  
1801 S. La Cienega Blvd.  
(213) 559-5111

**James E. Filiatrault, Janet Engelbrecht**

Mountain View, CA 94043  
2680 Bayshore Frontage Rd., Suite 401  
(415) 965-8222

U.K., Scandinavia, Benelux,  
Director - European Operations

**Martin Sutcliffe, Robert Saidel**  
Technical Publishing Co.  
130 Jermyn Street, London, SW1 4UJ, England  
Tel: 01-839-3916, Telex: 914911

France, Spain

**Vivian James**

Germany, Austria, E. Europe:

**Robert S. Gibson**  
Technical Publishing  
6000 Frankfurt 60  
Scheidswaldstr 41, West Germany  
Tel: (611) 439625, Telex: 4170039TP

Italy:

**Luigi Rancati**  
Rancati Advertising  
San Felice Torre 5  
20090 Segrate, Milano, Italy  
Tel: 2-7531445,  
Telex: 311010

Switzerland:

**Andre Lehmann**  
ALAS AG  
Business-Centre  
Schoegrund 1  
CH 6343 Rotkreuz, Switzerland  
Tel: (42) 642964, Telex: 864958

Japan:

**Shigeru Kobayashi**  
Japan Advertising Communications, Inc.  
New Ginza Building, 3-13 Ginza 7-chome  
Chuo-ku, Tokyo 104, Japan  
Tel: (03) 571-8748, Telex: J22745

**John K. Abely**, President

**Robert L. Dickson**, Exec Vice President

**John R. Emery**, Senior Vice President

**Walter M. Harrington**, Vice President/Finance  
and Administration

**Tim Burkholder**, Senior Vice President

**Technical Publishing**

a company of  
The Dun & Bradstreet Corporation

# Heart disease or stroke can cheat you out of the best years of your life.

Those are the years shared with people you love. And when a loved one is gone, everything changes. You can't imagine the loss, unless it happens to you. Last year, nearly one million Americans died of heart disease and stroke — 200,000 of them before retirement age.

The American Heart Association is fighting to reduce early death and disability from heart disease and stroke with research, professional and public education, and community service programs.

But more needs to be done.

You can help us save young lives by sending your dollars today to your local Heart Association, listed in your telephone directory.

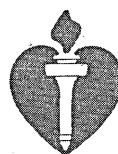
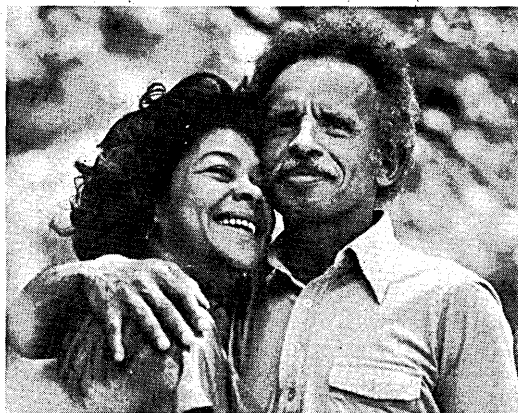

**American Heart Association**

WE'RE FIGHTING FOR YOUR LIFE

# VIAVAX

Hyatt Regency Chicago 16-18 April, 1984

## WORDS INTO ACTION

### The interactive conference for the interactive technology.

**TALK**

- your ideas are important, voice them loud and clear at the Talkshops featuring 16 topics throughout the conference.
- the informal program presents plenty of opportunity to exchange views and news with colleagues from all corners of the industry.

**SEE**

- a system in action. There'll be running commentary as operators set up and activate a newsroom system.
- the latest videotex and teletext equipment and services at the concurrent exhibition. There'll be product launches and lots to try.

**HEAR**

- the most influential and innovative people in the videotex and teletext industry as they present papers at this three day event.
- whether the money is ready, willing and waiting for the winners - Wall Street speaks out at a special plenary session.

VU84 125.3

**onLine**

The world's most important events on the  
business impact of high technology.

For further information call (212) 279 8890 - or clip  
your business card to this advertisement and return to:-  
London Online Inc., Suite 1190, 2 Penn Plaza,  
New York, NY 10121

VU84 125.3



Videotex '84, Chicago is organized in cooperation with  
the United States Videotex Industry Association.

An exchange of readers' ideas and experiences. Your contributions are invited.

# READERS' FORUM

## DBA'S LAST LINE OF DEFENSE

The life of a database administrator is an endless series of compromises. You're supposed to bring about a database—a central pool of business data shared by all—in a world of conflicting goals. Now if everyone's goals matched yours the job would be simple. As it is, some are opposed, most are skewed, and virtually none are congruent. You must compromise at every turn.

Since you've no choice, you're better off yielding on issues that can be rectified later and standing firm on those that cannot be undone. Redundant standalone files, for example, could someday be merged. Inconsistent data names are permanent.

Skewed goals compel compromise. Every organization you deal with has different goals:

Dp operations traditionally has physical custody of the data. Consequently, your involvement in setting, auditing, and enforcing data security procedures is fated to overlap dp turf.

Tech support ensures machine efficiency, but the DBMS (database management system) itself introduces overhead, such as subschemata, PSBs, DBDs, and element lists. These will ultimately make applications easier to change, but don't expect tech support to sympathize with this.

Systems and programming has the final word on application design. It's true that some otherwise sound designs make files unshareable and can't be allowed in a database shop. But more design effort isn't always the answer. When you come down to it, there really is no answer to S&P's eternal dilemma, "Do you want it right or do you want it Friday?" and your involvement may just muddy the water.

DBAs tend to think that users share data peacefully with one another, rather like some utopian setting, where "from each according to his ability, to each according to his need" is the rule. In reality, the typical first-line user manager just wants to get his own unit's job done. While not implacably hostile to the idea of file sharing, he's not going to leap joyously about at the thought of someone else handling his vendor file.

Don't get the wrong idea. These goals aren't in conflict in the sense that they contradict one another. They don't. Then again, they aren't identical either. They're just skewed enough to give a ring of truth to the complaint: "DBA is meddling in my business again." You must, if you're to get the job done.

Don't expect higher management to give DBA the authority to command compliance; there are two reasons why this can't happen. First, DBA is a technical specialty. It is a staff role, not a line role. If DBA held formal authority over the MIS/dp triplet (S&P, tech support, and dp operations), it would be plunged so deeply into management that it would lose its ability to perform the technical

role. Second, the whole idea of file sharing is far too vulnerable to implement by force. It can be sabotaged, subconsciously perhaps, unless freely supported by most decision makers.

Face it. The only way to get results is to persuade everyone that the database approach is a good idea. You'll sometimes fail; life is like that. So, what do you do when forced to compromise?

Rank your objectives and negotiate from one to the next. Rank your goals into a series of steps. On the offensive, try to sell just the next one up. As a defensive maneuver, fall back to the next lower one. Thus, defeats are seldom final (you can always work your way up one notch next time), and victories are modest enough to be palatable to everyone.

You should have a sharply focused view of your priorities, though. Say you're striving for a companywide integrated database: rank your goals in an order that reflects how they depend on each other. To reach shared files, for instance, you must already have standard data contents, but to get standard data contents, you first need standard data formats.

The following are four major goal stages, starting at the top:

- Shared files—the final goal;
- Standard data contents—the issue of centralization;
- Standard formats—hidden disagreements revealed;
- Standard names—the last line of defense.

Shared files. All applications should use the same vendor file. The elimination of redundant standalone files is your final goal. If you truly have compliance with the three less-important goals, this one simply depends on trust. Do your users trust one another enough to accept the idea of others sharing the same data? If so, you're done. If not, all you can do is run a lot of interfile matchings and tough it out until attitudes change.

Actually, the worst problem you're likely to face in dealing with this issue is lack of true agreement at the next lower level. Your users cannot even discuss file sharing until you've reached standard data contents. Acme Office Products Inc. is vendor number 863. In accounting, purchasing, quality control, and receiving, in stockroom Kardex files, and at remote sites and sales offices everywhere, everybody agrees: Acme is 863. This concept, easy to grasp, is incredibly hard to sell.

Why? Because somewhere in each department is the Keeper Of The Files. When that unit does business with a new vendor, the KOTF is the one who looks in The Book of Unassigned Vendor Numbers and, with the solemnity of ritual, Assigns A Number.

When you stroll in with the idea of all departments using the same number to identify the same vendor, every KOTF will instantly recognize the awful truth—you're proposing to put them out of business. If you have your way, they can no longer assign numbers on their own. When a new vendor appears, the unit's KOTF must either check with some central file before assigning a number or accept a centrally assigned number. Either way, he or she must now "check with headquarters" before doing the job. Volumes have been written about centralized control versus decentralized deci-

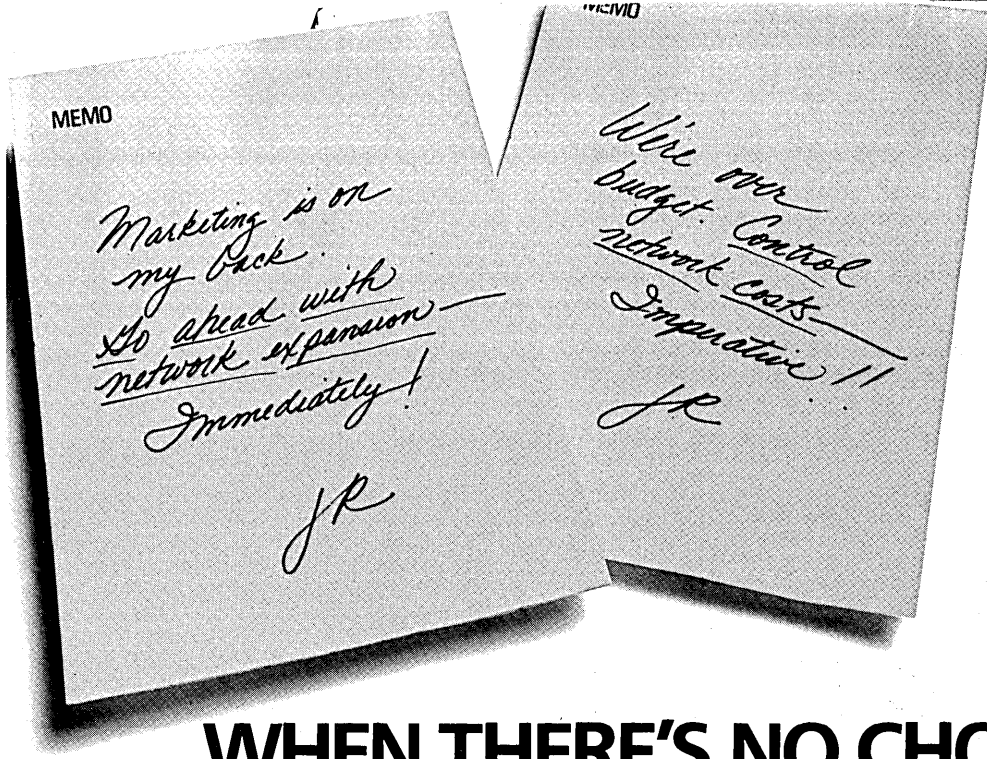

## WHEN THERE'S NO CHOOSING, CHOOSE ICOT.

More personal computers. More workstations. More remote locations.

Everyone seems to be demanding *more* of your 3270 network. And management says, "Do it—but do it for less."

It's a tough spot to be in, unless you know about ICOT's Virtual Terminal System™ protocol converters. In place in your network, they deliver the compatibility everyone wants and the economy and flexibility you need.

You can make inexpensive asynchronous terminals and printers compatible with your BSC or SNA/SDLC net-

work. A single terminal can access multiple applications and multiple hosts. And personal computers can be included easily in your network. All without expensive software modifications.

You have the flexibility of either dial-up or leased-line communications, letting you choose the option that's least expensive for your situation. Plus the option of adding ICOT's value-enhanced 3270 lookalike terminals.

It can all be done easily. Economically. With a built-in flexibility that makes future expansion fast and simple.

And when you use ICOT's protocol converters, we back them up with our expert installation, service and engineering support.

Now you don't have to choose between expansion and economy. Just choose ICOT. To find out more about the ICOT Virtual Terminal System, call or write:

ICOT Corporation  
830 Maude Avenue, P.O. Box 7248  
Mountain View, CA 94039  
(415) 964-4635  
TWX 910-379-6479

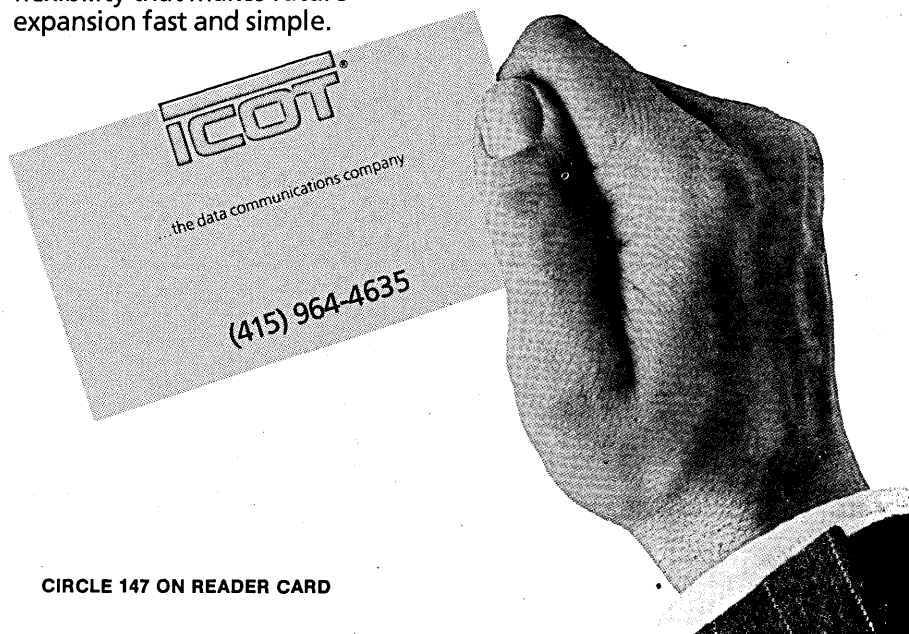



# WHEN YOUR DATAPOINT 8600 TALKS...

The DATAPOINT 8600 multifunction workstation gives your business all the advantages of an advanced processor while keeping in touch with your existing computer equipment, because it can communicate with most mainframe computers as well as with other DATAPOINT systems.

Communications is the cornerstone of the revolution DATAPOINT sparked seven years ago with the introduction of ARC™ (Attached Resource Computer®), the

original local area network. Today ARC is the most thoroughly proven local area network in existence, bringing distributed processing and desktop computing to offices around the world.

## READERS' FORUM

sion making and suddenly, you're hurled into the middle of the controversy.

Before long, one of the brighter KOTFs will suggest that they divide the range of possible ID numbers among themselves. That way, they can claim to share the same file while actually keeping their authority intact. This would create multiple records for the same vendor, making a face-saving charade of the original idea. Sometimes, such tactics are necessary. Use this one if you must, but recognize it for what it is: a cosmetic covering for an unresolved conflict.

Your success at this level depends mainly on your firm's centralization-decentralization climate. If it's not hospitable to the idea now, be patient because fashions change. Meanwhile, make sure that, at least, you have standard formats. The company's standard is that "vendor-num" is composed of three numerals. While 087 and 938 are valid vendor numbers (the formats are valid, though they may not represent active vendors), IBM, A83, and 12-645-76 are not. All the organization's units must reach a consensus on what the data will look like.

The curious thing about this issue is that it's usually the first one to reveal serious underlying disagreements among users. You'll hammer out a verbal agreement to share files, only to see it vanish when you propose a standard format for the key data. This step is essential; it's senseless to shoot for higher goals without it.

Conversely, this goal is doomed from the start if you don't have standard names. At least, let's all call it vendor-num. Let us agree that vendor-code, corp-id, and the like are forbidden in documentation and discussions as well as in computer programs. Every S&P development team and every user should refer to any given piece of data in the same way.

Oddly enough, the strongest resistance to naming standards seems to come from within MIS. Any programmer or project manager can marshal dozens of reasons why the word number should be abbreviated num and not nbr (or vice versa). Generally, this happens because nobody wants to think about all the programs they'd have to change in order to conform. Everyone would rather see the other group change. Also, many computer programmers sincerely believe theirs is the last stronghold of individual artistic creativity in a cold technological world. Standards? Forget it.

But that's the one thing you cannot do. All the higher issues can be compromised by dropping back a notch. This one can't be. Once divergent names take effect, they're virtually impossible to eradicate. Access methods and record layouts can be changed. But names, once they're written into programs and procedures and accepted into the company's vernacular, are there for keeps. Having fallen back this far, you can yield no more. For without agreed-upon naming standards, the rest of the goals and the database are hopeless.

—Frank Sweet  
Jacksonville, Florida

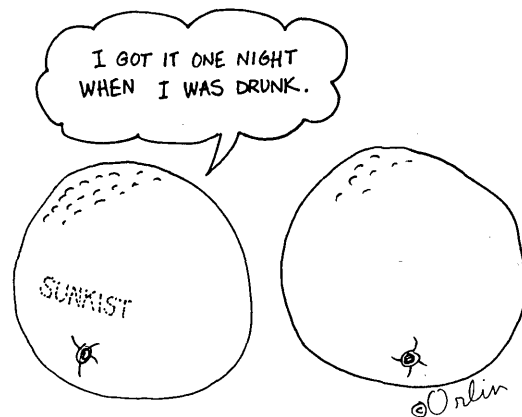

# ANSI PRANCE

(On Your Feet)

A new COBOL flies,  
A source of elation.  
Everyone rise,  
For a standard ovation.

—Edmund Conti  
Summit, New Jersey

# HOLD THE PICKLES, HOLD THE LETTUCE

Almost without exception, data processing exists as a service organization to users. This perception of dp is ingrained throughout business—from lower level users to upper management. But few question exactly what is meant by a service organization, even though there are vastly different kinds of service.

If we move out of the dp arena, it's easier to understand the different types of services. At one extreme are the very individualized services of a tailor, valet, butler, or gardener. They are all very costly, and nonessential to most individuals.

At the other extreme are public services such as law enforcement, garbage service, electric utility, and air traffic control. These are mandatory, relatively inexpensive, and essential to the general well-being of society.

We all know that a butler would never think of telling his employer to wash the dishes, but a traffic policeman quite naturally dictates when to cross the street. Therefore, individualized services are in a request mode while public services are in a command mode.

How do the two types of service postures apply to data processing? Whether it is right or wrong, dp is cast in the role of an individualized service. In some cases this role is proper, but in many, it is not. This explains some of the difficulties in managing data processing today.

How did dp end up as an individualized service in the first place? The role can be traced back to the roots of the organization. In the earliest days, it was dp's mission to establish itself as a viable function within the company. Because the initial moves toward automation met with user resistance, dp adapted a stance of very customized, individualized service, which set the tone of the user-dp relationship for years to come.

After being lured into the world of automation this way, users expected the relationship to remain the same. This role has never changed, even though the environments of dp and users have undergone drastic changes, such as growth in technology, volume of processing, the total number of dp service users, and the backlog of systems maintenance.

In today's dp world, the biggest problem is coping with the ever-mounting backlog of user requests. The relationship should rightfully be one of public service, but the old expectations still hold.

For example, consider a user who wants to run batch-type processing in an on-line environment. His work will greatly disrupt the on-line system response time for all users. In this case, it is dp's role to protect the system from abuse. But by doing so, the user ends up feeling dp is unresponsive to his needs, because dp will not give him what he wants (with good reason). Ultimately, dp's reputation is tarnished.

## ...YOUR MAINFRAME LISTENS.

And the 8600 processor is a vital part of the DATAPOINT approach to local area network communications. It features integrated data processing, word processing, electronic mail, data communications, financial spreadsheet software, system operations, and mainframe communications in one desktop unit. When the 8600 is linked to your other computer equipment via an ARC local area network, it becomes part of a system that can expand as far and

as fast as your business expands.

If your business is ready to join the revolution, talk to our worldwide sales and service force about the 8600. It could put a spark of the revolution in your office.

Call 1-800-334-1122 toll-free for a demonstration. M101  
Or send this coupon to: DATAPOINT Corporation,  
9725 Datapoint Drive, T-47, San Antonio, Texas 78284

Name \_\_\_\_\_ Title \_\_\_\_\_  
Company \_\_\_\_\_  
Address \_\_\_\_\_  
City \_\_\_\_\_ State \_\_\_\_\_ Zip \_\_\_\_\_  
Telephone \_\_\_\_\_

 **DATAPOINT**  
We sparked the revolution.

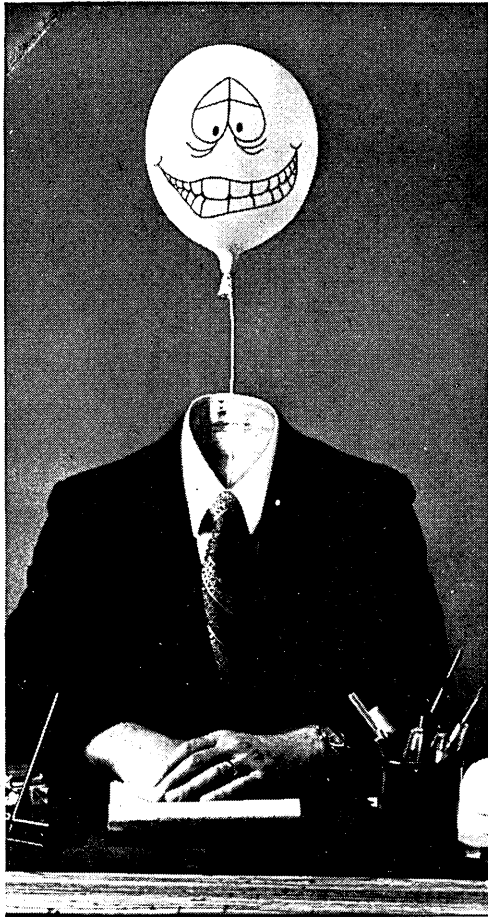

## High Blood Pressure?

Only your doctor can tell. Like more than 10 million other Americans, you could have high blood pressure and not know it until it leads to stroke, heart or kidney failure. It has no special symptoms and often gives no warning. But your doctor can detect high blood pressure (he may call it hypertension) and usually control it. So see your doctor . . . and follow his orders.

**Give Heart Fund**  
American Heart Association 

*Contributed by the Publisher*

## READERS' FORUM

Other times, systems that should be integrated are not because of rivalry and competition at the user level. In these instances, two or more user departments are using the same data, and accomplishing the same function, but are nevertheless divided. When they are automated, their systems should be combined to save on the expenses of development, maintenance, processing, and more. But for political reasons, the users won't allow this integration. If data processing tries to influence management to adopt the integration proposal, dp is usually "put in its place" by the user.

The reality of dp as a public service coupled with the widespread perception of it as an individualized service may explain the current clamor for user friendliness. In actuality, user-friendly software has existed for quite a while (e.g., MARK IV, GIS), but only recently became popular. When the user takes control with such software, he can at last obtain individualized service, even if it comes in a do-it-yourself mode. But the benefits of the public service role are lost as dp gives up control.

It has been suggested that this passing of control is the first step toward rebirth of the dp function—only this time under the user's management.

If in fact the user is entering Nolan's first stage of dp, as seems to be happening, there are a few questions that must be asked: Is the user any better equipped to manage dp? Is he going to repeat the same mistakes that dp has lived through and, with any luck, learned from? And is this a proper course? If not, what is the ultimate price that must be paid?

Dp's public service role covers at least the following areas:

- creation, maintenance, and protection of the on-line environment,
- creation, maintenance, and protection of the integrated environment,
- long-term hardware and software planning,
- security and disaster planning, and implementation of those plans,
- protection of shared data and shared data definitions,
- long-term strategic planning to meet the corporation's dp needs,
- control of dp expenditures, and
- network planning and control.

The focal point is the difference between operational and decision support systems. The operational environment requires the public service role while the decision support environment is most closely aligned with the individualized services role. The difficulties arise when the roles are matched with the wrong environments.

The entire analogy breaks down when we have to figure out who foots the bill; if individualized service is desired, then the price is high, and must be paid by the person receiving the service. In the traditional dp-user relationship, not only does the user expect individualized service, he also expects dp to pay for it. The user gets the best of both worlds—no wonder dp managers feel pressured.

Part of the problem is that this inaccurate concept of dp's role has spread throughout the organization. Certainly the user wants individualized services; who doesn't? Even upper management and dp accept the notion that the dp-user relationship should be individualized, though often it is not in the organization's best interests.

Most management (dp and otherwise) simply shrugs its shoulders and accepts the relationship without question. It is a mark of maturity in a still infant industry to move from individualized to public service as the environment changes.

—William H. Inmon  
Denver, Colorado

If you'd like to share your opinions, gripes, or experiences with other readers, send them to the Forum Editor, DATAMATION, 875 Third Ave., New York, NY 10022. We welcome essays, poems, humorous pieces, or short stories.

# THE DAY THE IBM® PC BECAME OBSOLETE

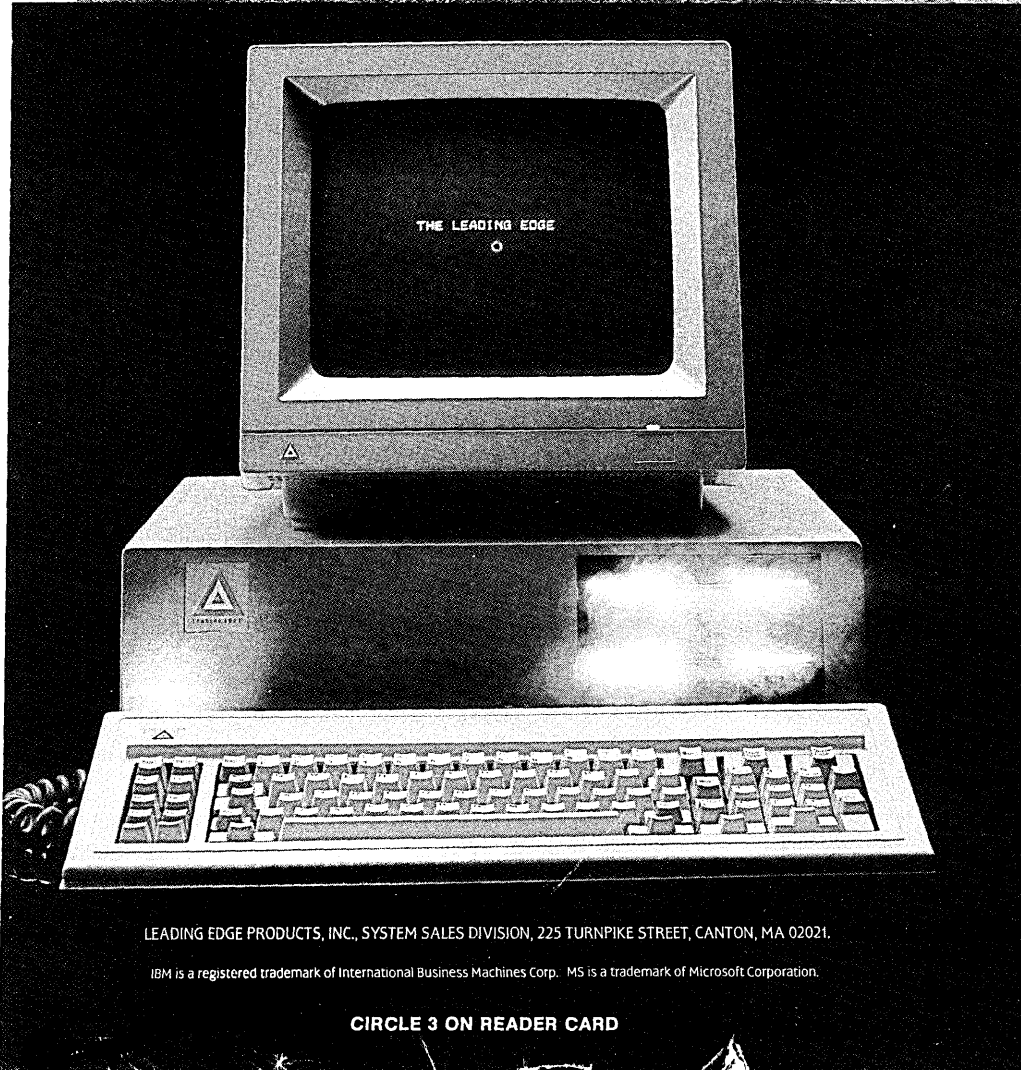

It was a Monday in the autumn of '83:

The day they announced the Leading Edge® PC—a personal computer that's just plain better than the IBM® PC, at just about half the price.

The Leading Edge PC is faster (by more than 50%), more powerful, more flexible and more dependable (for example, our disk drives have a "mean time between failures" of 20,000 hours, versus an 8,000-hour MTBF for theirs). It's compatible with just about all the software and peripherals that the IBM is.

And unlike IBM's, ours comes complete with a high-resolution monitor, controller, seven expansion slots, serial port, parallel port, a time-of-day clock, double the standard memory (128K vs. 64K) plus hundreds of dollars worth of software to get you up and running immediately including MS™-DOS version 1.25, GWBasic, and Leading Edge Word Processing™ (the most powerful w.p. program ever created to run on an IBM-type personal computer). In short, the basic package comes to you complete and ready to work.

With IBM, on the other hand, you get charged extra for everything. Even for the PC DOS disk that makes it run (an extra \$40) ... and \$170 just for the time of day (a calendar/clock that's standard with Leading Edge). In short, the basic package comes to you as a very expensive paperweight.

It's this simple: The Leading Edge Personal Computer is the first and only serious alternative to the IBM PC ... and at only \$2895 for the Leading Edge PC ...

Get serious.

Now at 500 Leading Edge Dealers across the country. For the one nearest you, call toll free 1-800-343-6833. In Mass., call collect (617) 828-8150.

LEADING EDGE PRODUCTS, INC., SYSTEM SALES DIVISION, 225 TURNPIKE STREET, CANTON, MA 02021.

IBM is a registered trademark of International Business Machines Corp. MS is a trademark of Microsoft Corporation.

CIRCLE 3 ON READER CARD





# INTRODUCING YOUR WINDOW TO THE FUTURE.

The highly sophisticated 5620 asynchronous terminal is indicative of what you'll be working with in the future, as well as what you can expect from Teletype Corporation. It's a low-cost, dot-mapped, UNIX\*-based terminal that offers a good value in switched or point-to-point private line environments.

What's most impressive about the 5620 is its unique capability to divide the display into multiple "windows" of varying sizes. Our electronic red "Mouse" lets you

easily create and control the windows. And because the host views each window as a separate terminal, several functions can be in process on the

5620 at once. For example, a programmer can work on one program while one or more are compiling and the terminal is receiving and displaying electronic mail. You can also download the 5620, and run programs independent of the host.

While the 5620 is a programmer's dream, it's also a valuable

business tool. It can be used to compare and contrast multiple business situations or cases simultaneously; to develop one case while one or more are being executed; or to examine two sets of files from more than one data base side by side.

You'll enjoy extremely high resolution no matter how much you put on the screen. The dot-mapped display boasts 100 dots per inch resolution on a 15 inch diagonal monitor. You can address a dot anywhere on the screen, which gives you full graphics capabilities. Line drawings and tracings can be made with the "Mouse."

Although the 5620 is complex, it's not difficult to operate. You can use the "Mouse" to control terminal functions through a series of user-friendly menus. There's also a full complement of ergonomic features like a low-profile keyboard that's light enough to rest in your lap, a high resolution screen with brightness control, and a special faceplate to reduce glare.

Of course, you can count on our established nationwide service organization for prompt service.

If you want to know what the future holds, take a look at our 5620. Its windows make it easy to see what's in store for Teletype Corporation and you. For more information, write Teletype Corporation, 5555 Touhy Ave., Dept. 3223-A, Skokie, IL 60077. Or call 1 800 323-1229, Extension 604.

\*UNIX is a trademark of Bell Telephone Laboratories, Inc.  
"Teletype" is a registered trademark and service mark of Teletype Corporation.

## TELETYPE: VALUE SETS US APART.

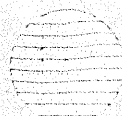

**AT&T**  
Teletype Corporation

CIRCLE 1 ON READER CARD