

# DATA MATION<sup>®</sup>

1957

77

1977

January

## THE YEAR AHEAD



This year you will

Also, touch-sensitive displays, what data base isn't, system/3 to system/360, and cobol to mark IV...

# World Travelers

Kennedy tape recording equipment—it's the finest in the world, and that's why it's in use around the world. Kennedy recorders are monitoring and recording airport traffic and arrivals in Holland, solar activity to determine the Earth's weather, in Switzerland, gasoline usage at stations in Sweden, banking systems for up-dating payments and billing in Japan, computerized read outs in India, utility power distribution to industry in England and telephone usage analysis, toll ticketing, message switching control and automatic program load for virtually every country with a telephone service.

These are only a few of the countries and applications where Kennedy products are solving problems.

Asynchronous tape drives, vacuum column tape drives and a complete line of cartridge recorders are available for any application.

To service Kennedy products, there is a European service center and parts depot to handle factory warranties, repairs and parts stocking. If you're an OEM doing business in Europe, that's something to think about.

Kennedy tape products—they're the finest in the world. If you're thinking international, think

**KENNEDY CO.**

B.O.W. WOODBURY RD., ALTADENA, CALIF. 91001  
(213) 788-0853

## KENNEDY • QUALITY • COUNT ON IT

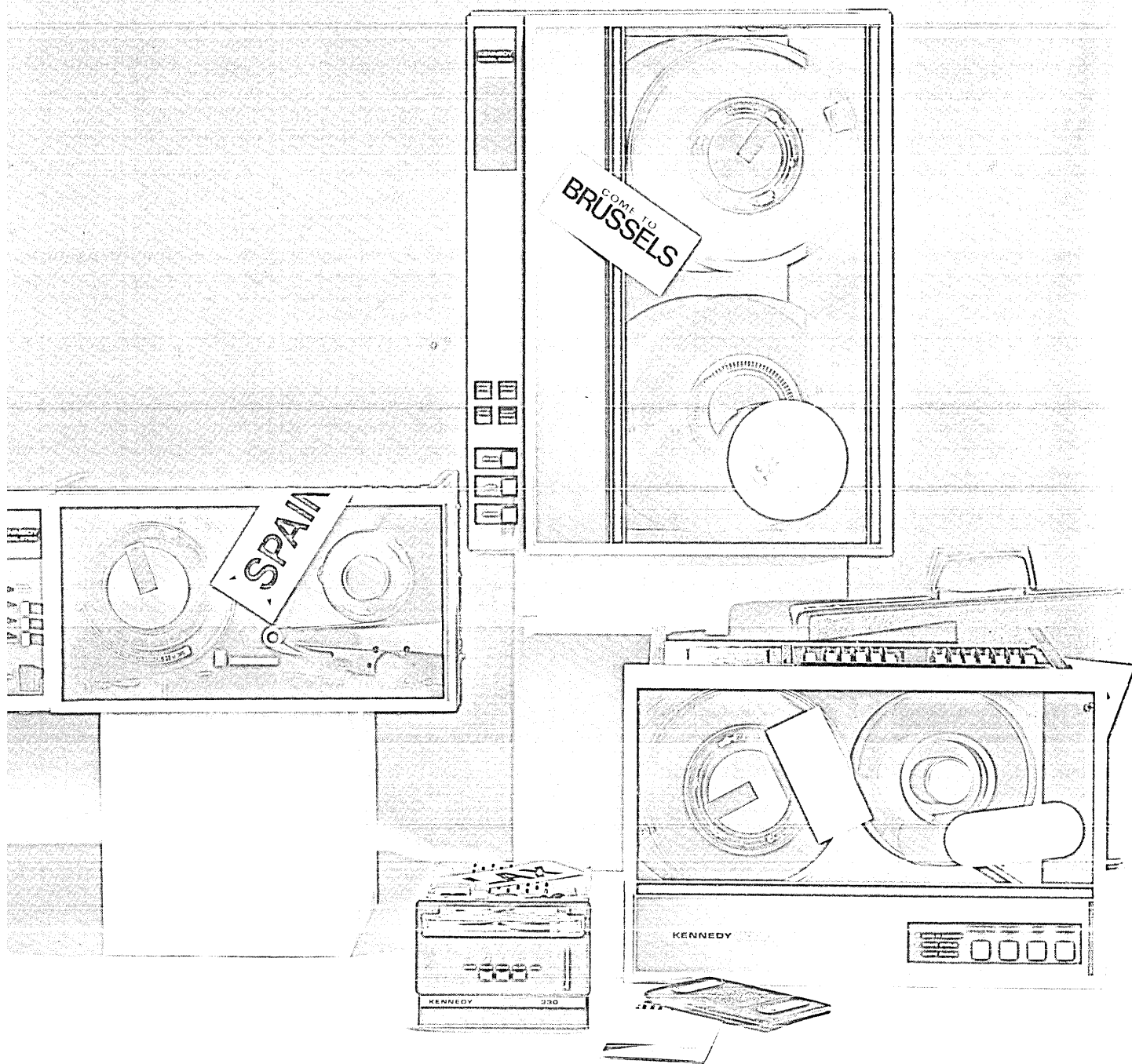

CIRCLE 1 ON READER CARD

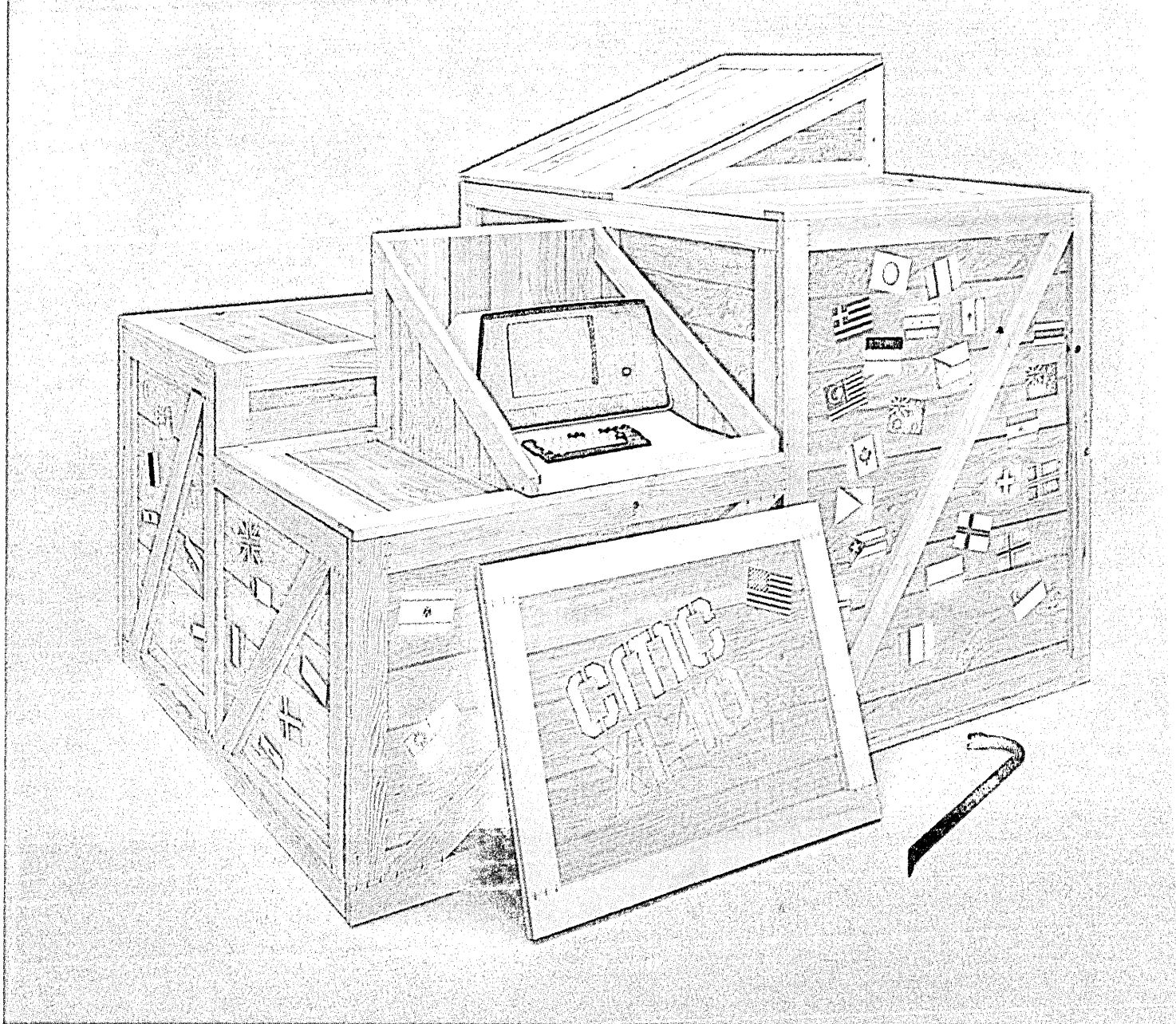

## 'The DREAM Machine

CMC introduces the all new XL40  
Distributed KeyProcessing System.

**Blending Data Retrieval, Entry And Management**, the XL40 combines the newest distributed processing and data entry technology with an exceptional file retrieval capability. *Distributed KeyProcessing* means data is entered, validated, and managed at the source—where it originates—by people who really know what the information represents. Distributed KeyProcessing reduces your data processing costs by detecting and correcting errors before they reach the mainframe, providing local pre-processing, and optimizing the management of your organization's data.

**First in a family** of CMC Distributed KeyProcessing Systems, the XL40 is available with one to seven keystations in a choice of keypunch-style keyboard or typewriter style with numeric pad, and features expandable disk capacity from 4.4 to 35.2 megabytes. Using a variety of industry-standard protocols, including HASP workstation, the XL40 communicates with your mainframe wherever it's located.

CIRCLE 4 ON READER CARD

**Your software dreams come true** with a fully compatible subset of ANSI COBOL and XL/OS, an automatic and dynamic multi-task operating system specially designed for the XL family. XL/OS provides disk and memory allocation, ensures data and system integrity, and controls all system resources. The XL40's information retrieval package, COSAM (COBOL Shared Access Method) features indexed files which you can retrieve and update on the spot, ensuring instantaneous response at the source.

**Don't just dream about it**, call or write today for our brochure on the XL40 Distributed KeyProcessing System, The DREAM Machine for Data Retrieval, Entry And Management. With the XL40, just as with dreams... the possibilities are unlimited.

KeyProcessing is a trademark of



**a division of Pertec Computer Corporation**

12910 Culver Boulevard, P.O. Box 92300, Los Angeles, CA 90009  
Telephone (213) 822-9914, TWX (910) 343-6451

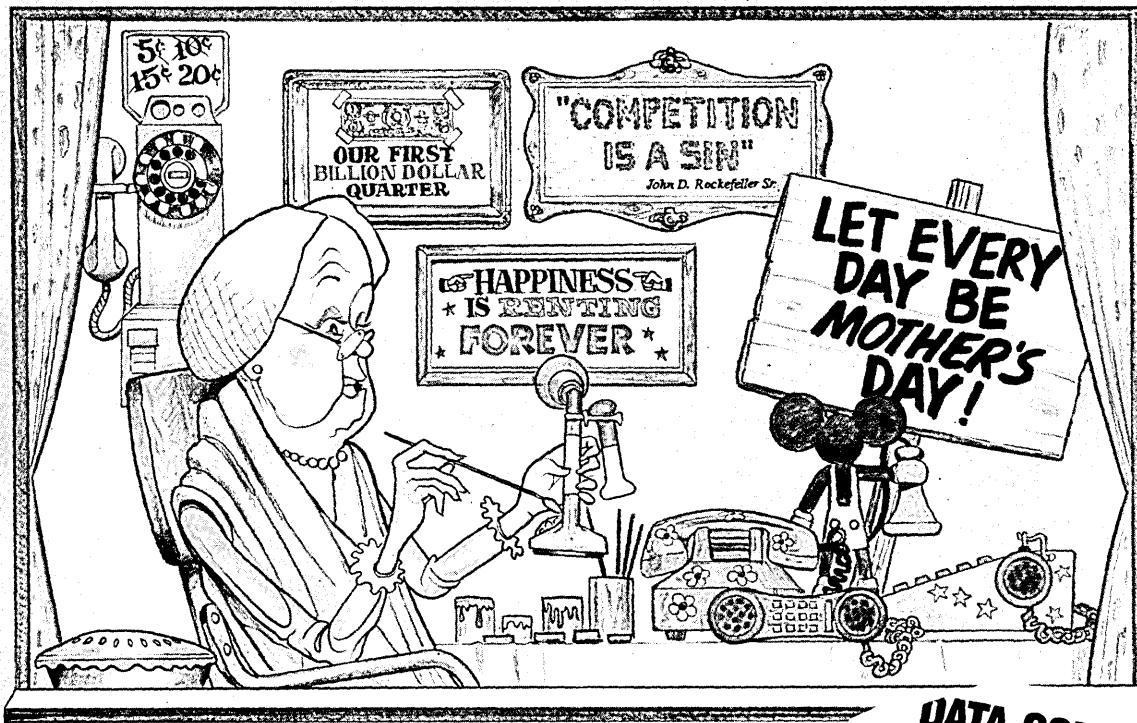

**Dear Ma:**  
**While you've been painting telephones and calling on Congress ...guess what Vadic's been doing?**

This clipping tells the story. Vadic has come up with more low and medium speed modem "firsts" than anyone — both for OEM's and end-users.

A prime example. Almost 4 years ago Vadic invented a full duplex 1200 bps modem that operates beautifully on either dial-up or 2-wire leased lines. Today, over ten thousand VA3400's are in use at over 1000 companies.

We increased the speed of our CRT's and other 120 cps terminals by four times when we replaced your 103's with VA3400's. And it took just a few minutes to change computer port speed.

You can't beat Vadic for service, either. General Electric installs and maintains Vadic modems at over 50 locations nationwide. And Vadic backs this up with 5 regional on-line diagnostic centers.

Better send for Vadic's 30 page brochure, Ma. It'll give you some young ideas.

Your independent thinking son,

*Alexander Graham Jr.*

PS: Vadic has shipped over 125,000 modems to date.

**DATA COMM NEWS**  
**VADIC "Firsts"**

- 1969** — Vadic designs complete OEM line of low cost Bell compatible 300 & 1200 bps modem modules & PC boards for terminal & computer systems manufacturers.
- 1970** — Vadic adds IBM & CCITT compatible modems.
- 1971** — For end-users, Vadic introduces 16 channel system where up to 16 modems & auto dialers can be freely intermixed in 7" high chassis.
- 1972** — Vadic adds powerful displays & diagnostics, including EIA interface status lights, and local/remote loopback, making it simple to pinpoint problems on any part of a complex data communications system.
- 1973** — Vadic announces world's first full duplex 1200 bps modem that works on dial-up or two wire leased lines. Called "the most significant advance in modem design in years".
- 1974** — Vadic designs system which permits 60 modems to share a single automatic dialer. Vadic introduces 2400 bps modem.
- 1975** — General Electric now installs, leases & services Vadic modems at 50-plus service centers in US. 100,000th modem shipped by Vadic.
- 1976** — Vadic is first modem manufacturer to obtain certification for direct connection to switched network in California eliminating need for Bell DAA.



Member of IDCMA

THE VADIC CORPORATION  
 505 E. Middlefield Rd., Mountain View, CA 94043  
 Tel: (415) 965-1620 TWX: 910-379-6567

Write or phone for your **FREE** Ma Bell Poster... suitable for framing.  
 CIRCLE 65 ON READER CARD

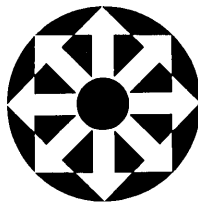

# 1957 DATAMATION<sup>®</sup> 1977

This issue 128,000 copies

VOLUME 23 NUMBER 1

JANUARY 1977

## FEATURES

- 46 THE OUTLOOK FOR DP BUSINESS AND TECHNOLOGY IN 1977  
Frederic G. Withington. A \$30 billion year, and bubble memories too.

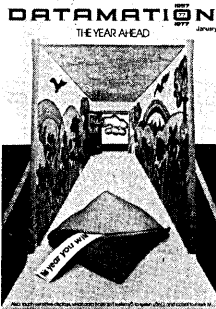

- 49 OUR CHANGING INDUSTRY  
Edward W. Pullen and Robert G. Simko. As the "data processing" industry becomes the "information systems" industry, its scope, end users, and professionals will change too.

- 56 COMPUTER WISHLIST  
Angeline Pantages. Industry figures reflect on what the industry could try to do, if computers could really "fix" anything.

- 63 EFT IN 1988  
Oliver J. DeSofi. It couldn't happen this way, right?

- 70 TOUCHING DATA  
James K. Johnson. Let your fingers do the walking . . . and talking.

- 85 WHAT DATA BASE ISN'T  
Daniel S. Appleton. For starters, it isn't an integrated set of application systems.

- 97 CONVERTING FROM THE SYSTEM/3 TO THE SYSTEM/360  
Tom Teresi. There are big benefits of being in IBM's mainstream.

- 111 FROM COBOL TO MARK IV  
Jim Flynn and Dick Kimber. Most of the problems were in "unlearning" the old ways.

- 129 THE PROGRAMMER'S NEW CODES  
Jack L. Ludwig. The weavers worked with interpretive mnemonic calls and multi-threaded macros unusually fine.

- 200 THE FORUM  
John Beidler. Saying the last rites for flowcharts.

## NEWS IN PERSPECTIVE

**EDUCATION**  
Time-sharing is giving way to standalone computers in some education applications. Effects of computer assisted education are studied in Los Angeles.

**MINICOMPUTERS**  
DEC's growth leaves gaps for competition to fill.

**PEOPLE**  
John Backus of Fortran fame now would unclog the "von Neumann bottleneck."

**TECHNOLOGY**  
Man and his machine: The relationship becomes crucial and more complicated.

**RAILROADS**  
Bar codes fall short of promised results.

**COMMUNICATIONS**  
Second bite at the apple for Bell foes?

**FINANCIAL**  
Amdahl given high marks from NCSS in seminar for financial analysts.

**STATE & LOCAL GOVERNMENT**  
Not so great expectations.

**SOCIAL CONCERNS**  
Reminiscences and predictions.

**INTERNATIONAL**  
CII-HB offerings overlap as Level 66's join Level 64's. Unisys—a final convergence of Honeywell systems by '82.

**BENCHMARKS**  
Computer Automation strikes back; Microcomputer move; Terminal sale; The algorithm; Mass storage marketing; Amdahl user group; Amdahl in Germany; German acquisition; Crowding but not overcrowded.

## DEPARTMENTS

- 11 LETTERS  
Reader dialogues on cost of living, dp in communist countries, urban transit, & a note on "personal comments."

- 16 LOOK AHEAD

- 21 PEOPLE  
Joseph T. Verdesca: he likes his work; E. Z. Million: a problem of credibility; Daniel Duke: he's selling solutions; others in new posts.

- 26 CALENDAR

- 28 SOURCE DATA  
Brandon/Segelstein book on dp contracts reviewed, plus the New Year's crop of reports, vendor lit, courses.

- 172 HARDWARE  
Cado Systems' add-ons for the Teletype Dataspeed 40 are just what Bell would have liked to bring to market.

- 184 SOFTWARE  
Privacy compliance, and language conversions for RPG to PL/1, FORTRAN IV to PL/1, Univac FORTRAN IV to IBM . . .

- 192 MARKETPLACE

- 197 ADVERTISERS' INDEX  
About the Cover  
It looks like a bright pathway leading into the year ahead. Our design/construction and the illustrations elsewhere in this issue are by SUSAN ANSON: Joan Lesser/Etcetera.

# Model 204

Database Management  
Software System

Model 204 is a proven database management software system offering multi-key access with rapid response, flexibility in data organization and safeguards for the privacy and integrity of data. A full complement of options is available, including on-line and batch update, a simple yet powerful user language, an interface to programming languages and a utility for file conversion.

Computer Corporation of America

575 Technology Square  
Cambridge, Massachusetts 02139  
(617) 491-3670

CIRCLE 104 ON READER CARD

## LOVE at first BYTE

If you have  
your own computer, or if you're  
into computers at all, have we got  
a magazine for you!

**BYTE** A magazine for and about the state of the art of personal computing. Written by pros and hobbyists who know the ropes. Edited by Carl Helmers, who knows what personal computer users need to know. Written so everyone from the neophyte to the mastermind can understand and enjoy it. Month-after-informative-month, a continuous flow of pioneering articles, practical applications, source listings and detailed articles like . . .

- Machine Readable Printed Programs
- Voice Outputs • Golf Handicapping • Games
- Programmed Music • Computer Languages
- Small Business Applications • Bio-Rhythms
- Home Automation • Weather Forecasting
- Text Editing and Systems Programming
- Plus, many, many more . . .

**Rush this coupon today! Charge on BankAmericard or Master Charge. If you can't wait, call directly: (603) 924-7217. Ask for Subscription Department.**

Subscribe to **BYTE** right now. Only \$12 for one full year's subscription of 12 big issues. Two years for \$22 . . . save \$2.00! A three-year subscription is only \$30. Save \$6.00! When you get your first issue read it from cover-to-cover. If it's what you expected, honor our invoice. If not, write "CANCEL" across invoice and send it back. You won't be bothered again. Subscribe today.



### BYTE Peterborough, NH 03458

Please enter my subscription to **BYTE** . . .

- \$12 One Year     \$22 Two Years  
 \$30 Three Years

- Bill me.  
 Enclosed is my check for \$ \_\_\_\_\_  
 Bill BankAmericard  
 Bill Master Charge

Credit Card #

Credit Card Expiration Date

Name (Please Print) \_\_\_\_\_

Address \_\_\_\_\_

City \_\_\_\_\_

State \_\_\_\_\_ Zip \_\_\_\_\_ D-1/77

CIRCLE 91 ON READER CARD

## DATAMATION.

### EDITORIAL STAFF

<b>Editor</b>	John L. Kirkley
<b>Articles Editor</b>	Richard A. McLaughlin
<b>International Editor</b>	Angeline Pantages
<b>European Editor</b>	Nancy Foy
<b>Products Editor</b>	Michael Cashman
<b>Department Editor</b>	Laura Semonian
<b>Reprint Editor</b>	Pat Minford
<b>News Editor</b>	Tom McCusker
<b>Bureau Managers</b>	
<b>San Francisco</b>	Edward K. Yasaki
<b>Los Angeles</b>	Edith D. Myers
<b>Greenwich</b>	Angeline Pantages
<b>New York</b>	Laton McCartney
<b>Washington, D.C.</b>	Linda J. Flato
<b>Boston</b>	Vin McLellan
<b>Correspondents</b>	
<b>Minneapolis</b>	James K. Johnson
<b>Southwest</b>	Robert F. Alexander
<b>Australia</b>	Ken McGregor
<b>Editorial Advisor</b>	Robert L. Patrick
<b>Technical Advisor</b>	Lowell Amdahl
<b>Contributing Editors</b>	Paul Armer, Howard Bromberg, Phillip H. Dorn, Louis B. Marienthal, Carl Reynolds, F. G. Withington, William Helgason, John M. Eger

### EDITORIAL OFFICES

**Headquarters:** 1801 S. La Cienega Blvd., Los Angeles, CA 90035. Phone (213) 559-5111. **Eastern:** 35 Mason St., Greenwich, CT 06830, (203) 661-5400. 420 Lexington Ave., New York, N.Y. 10017, (212) 682-7760. 134 Mt. Auburn St., Cambridge, Mass. 02138, (617) 354-2125. 6605 Burlingame Pl., Springfield, VA 22152, (703) 569-3383. **Southwestern:** 2711 Cedar Springs, Dallas, TX 75201. (214) 744-0161. **Western:** 2680 Bayshore Frontage Rd., Suite 401, Mountain View, CA 94043, (415) 965-8222. **Foreign:** 8 Pellerin Rd., London N. 16; (01) 249-1177; 24 Stafford Road, Artarmon, Sydney, NSW 2064, Australia, 41-5748.

### GRAPHIC DESIGN & PRODUCTION

<b>Art &amp; Production Director</b>	Cleve Marie Boutell
<b>Advertising Production Manager</b>	Marilee Pitman
<b>Production Assistant</b>	Alberta R. Martin

### CIRCULATION

35 Mason Street, Greenwich, CT 06830  
**Circulation Manager** Suzanne A. Ryan  
**Marketing Research Manager** Deborah Dwelley  
**Publisher** James M. Morris  
**Assistant Publisher** F. Douglas De Carlo  
Circulation audited by Business Publications Audit 

Member  American Business Press, Inc.



**DATAMATION** is published monthly on or about the first day of every month by Technical Publishing Company, 1301 South Grove Ave., Barrington, Illinois 60010; Arthur L. Rice, Jr., Chairman of the Board; James B. Tafel, President; Gardner F. Landon, Executive Vice President. Executive, Circulation and Advertising offices, 35 Mason Street, Greenwich, CT 06830, (203) 661-5400. Editorial offices, 1801 S. La Cienega Blvd., Los Angeles, CA 90035. Published at Chicago, Ill.

**DATAMATION** is circulated without charge by name and title to certain qualified individuals in the United States and Canada who are employed by companies involved with automatic information handling equipment. Available to others by subscription at the rate of \$24. Reduced rate for qualified students, \$14. Foreign subscriptions \$40, Japan and Australia \$55. Sole agent for all subscriptions outside the U.S.A. and Canada is J. B. Tratsart, Ltd. 154 A Greenford Road, Harrow, Middlesex HA13QT, England. No subscription agency is authorized by us to solicit or take orders for subscriptions. Controlled circulations paid at Columbus, OH and Form 3579 to be sent to Technical Publishing Company, P.O. Box 2000, Greenwich, CT 06830. © Copyright 1977 Technical Publishing Company. ® "Datamation" registered trademark of Technical Publishing Company. Microfilm copies of **DATAMATION** may be obtained from University Microfilms, A Xerox Company, 300 No. Zeeb Road, Ann Arbor, Michigan 48106. Printed by Beslow Associates, Inc.

DATAMATION

# The future has a way of becoming the present.

In 1970, distributed data processing was a visionary concept. Someday corporations wouldn't have to push vast volumes of data through a central computer to supply the daily information needed for corporate planning and control. Someday there'd be enough electronic intelligence at each plant and office to permit both source data editing and fast, cost-efficient local processing of such local tasks as order entry, invoicing and inventory control. Someday...

**Distributed Processing Today.** In 1977, hundreds of distributed processing networks are serving American corporations in such industries as retailing, transportation, manufacturing, wholesale distribution, banking, insurance, stockbrokerage and medical services. In implementing distributed processing, these companies have learned that optimal performance requires remote display/processing systems flexible enough to be precisely scaled to the needs of each individual site.

**Clustered Displays.** The most flexible remote site system for distributed processing has proven to be the clustered display, an idea pioneered in

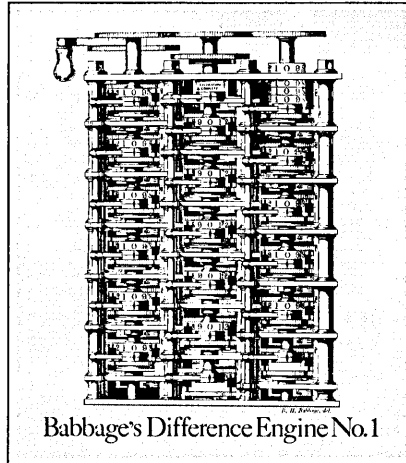

Babbage's Difference Engine No. 1

1970 by Four-Phase Systems. At each site, a cluster of keyboard/video terminals share a single processor ... and terminals can easily be added or removed to suit the site's functional requirements and transaction volume. Four-Phase Systems has built and installed more clustered display processing systems than any other manufacturer.

**Orderly Growth Path.** The flexibility offered by the clustered display concept is an important component of Four-Phase Systems' orderly growth path plan for the implementation of distributed processing. When a network evolves along an orderly growth path, each increment of growth is triggered by economic benefits proven in the previous

increment. This unusually cost-efficient way to implement a network is made possible by the unique hierarchy of equipment developed for distributed processing by Four-Phase Systems.

**Four-Phase Systems.** Who uses Four-Phase equipment today? More than 500 major organizations. Including ten airlines. Thirty insurance companies. Forty banks. Fifty government agencies. And more than a hundred of America's leading manufacturing corporations.

Why has Four-Phase succeeded in the hotly competitive world of business data processing? A primary reason is the fact that the Four-Phase product line was designed from scratch for its intended application ... not "assembled" from commercially available electronic logic components. Of all the business computer manufacturers in America, only two have always designed and produced the integrated circuits which are the brains of their products ... Four-Phase and IBM.

For further information, contact Four-Phase Systems 19333 Vallco Parkway Cupertino, California 95014 408-255-0900.

## Four-Phase Systems®

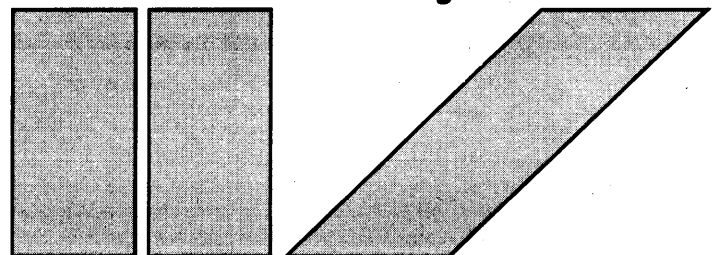

To anticipate and diagnose system failures . . . analog or digital

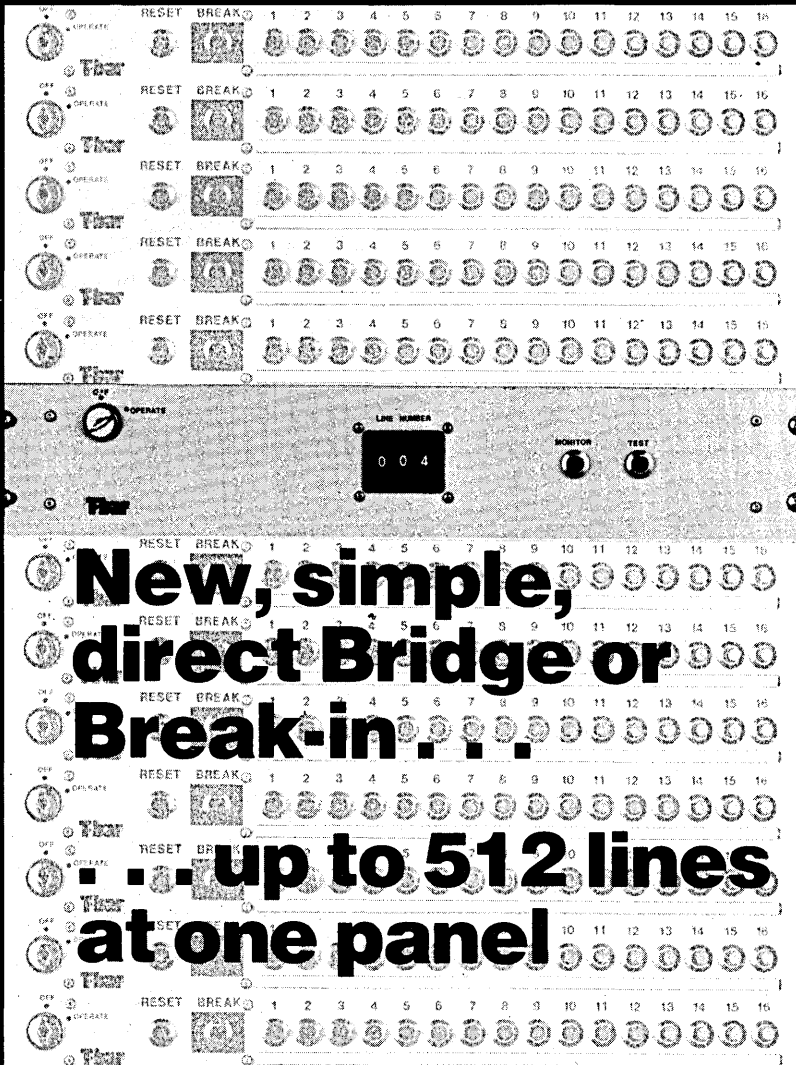

**New, simple,  
direct Bridge or  
Break-in . . .  
up to 512 lines  
at one panel**

# MASS ACCESS SWITCHING SYSTEM

Write or phone today for complete details on T-BAR's new MASS® Multiple Access Switching System.

**T-bar** INCORPORATED

INSTRUMENTATION and CONTROL DIVISION  
141 Danbury Road, Wilton, CT 06897  
Telephone: 203/762-8351 • TWX: 710/479-3216

See us at Booth No. 605, Federal DP Expo, Washington, DC, Feb. 8, 9.

CIRCLE 115 ON READER CARD

## Looking Back in DATAMATION.

*In October, DATAMATION will celebrate its 20th anniversary. The magazine has been around the dp industry nearly as long as there has been an industry, so its back issues are a goldmine—and sometimes a graveyard—of interesting facts and folklore.*

**19 years ago**

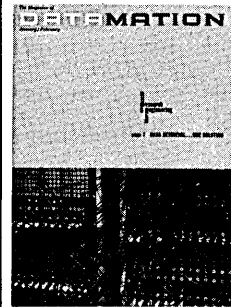

The January 1958 cover featured the Searching Selector from Western Reserve Univ., a sort of kludge for doing data correlation; its patch panel now clearly marks it

as from an earlier era. Some exciting news of the day was of the first deliveries of IBM's 305 RAMAC and 608 machines. The RAMAC boasted a 50 million digit memory, using 50 discs "whirling on a vertical shaft"—clearly the state of the art at the time. The 608 was billed as having "over 3,000 transistors but without a single vacuum tube."

Meanwhile, Bendix's Computer Div. announced the construction of its 100th G-15 computer. Said Maurice Horrell, the company's manager, "In the electronic computer manufacturing business, such a milestone compares with the one millionth automobile pulled off an assembly line in Detroit."

**10 years ago**

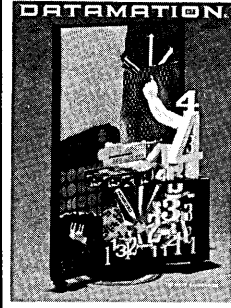

The kick-off news item in January 1967 reported GE's losses in computers, pegging them at \$400 million. "Meanwhile," the story said, "the company continues

to believe that a good GE-trained manager can manage anything, leaves the information systems division in the hands of management relatively new to the costly mysteries of the computer biz."

Another news item speculated that the FCC investigation of service bureaus could end up by putting AT&T into the dp field . . . proving that the more things change, the more they stay the same.

✱

DATAMATION



# See the sensational characters on Omron's wide, brighter screen.

At least CRT terminals built around displays that's big and bright enough to read by the most overworked eyes in the house.

Every Omron 8000 Series CRT terminal offers a superwide 16" screen with bold, beautiful characters 7 X 9 dot matrix upper case and numerals 7 X 7 dot matrix lower case and italics. It's also a comfortable, readable, bold, ear- and eye-saving terminal. The gentle rear view is sleek. With your feet and your operators standing upright, the screen is more visible.

Omron's CRT terminals are designed to make life easier for your operators by resisting slow motion.

Two real life tests show that Omron terminals have a conservatively rated 8,000 hours between failures compared to the 2,000 hour MTBF that many companies regard as acceptable.

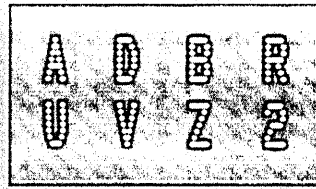

Bright, big characters on Omron's wide screen.

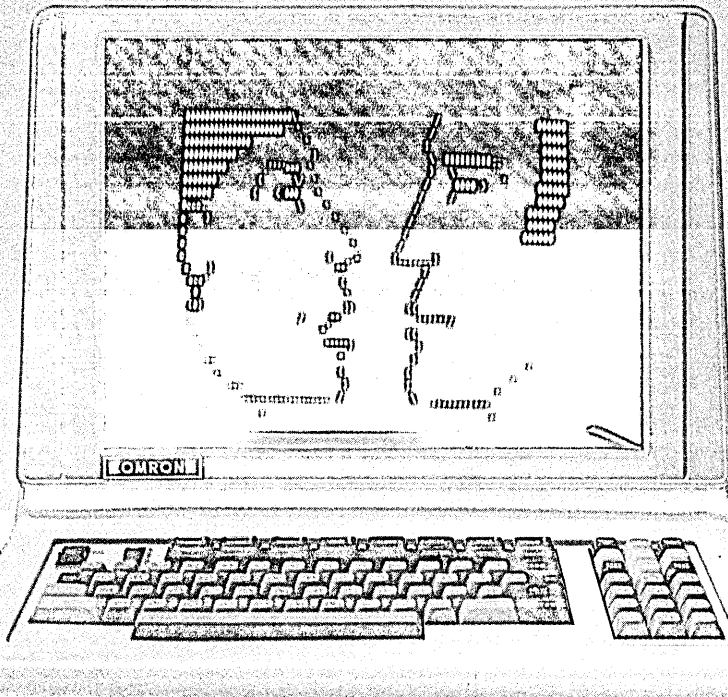

Lasting service from a world leader.

In a business where an alarming number of companies come and go, it's reassuring to know that Omron has been making and selling quality electronic components since 1935. We'll still be here tomorrow, selling and servicing new Omron CRT terminals to a discriminating and ever-increasing audience.

Mail the coupon today for complete information on Omron's wide screen line.



Omron Corporation of America  
Information Products Division  
432 Toyoma Drive  
Sunnyvale, CA 94086  
Telephone (408) 731-0840

CIRCLE 64 ON READER CARD

Omron Corporation of America, Information Products Division  
432 Toyoma Drive Sunnyvale, CA 94086  
Please send full information on Omron's 8000 Series CRT Terminals.

Name \_\_\_\_\_  
 Name of Company \_\_\_\_\_  
 Address \_\_\_\_\_  
 City \_\_\_\_\_ State \_\_\_\_\_  
 Zip \_\_\_\_\_

# Introducing the user-microprogrammable ADM-2.

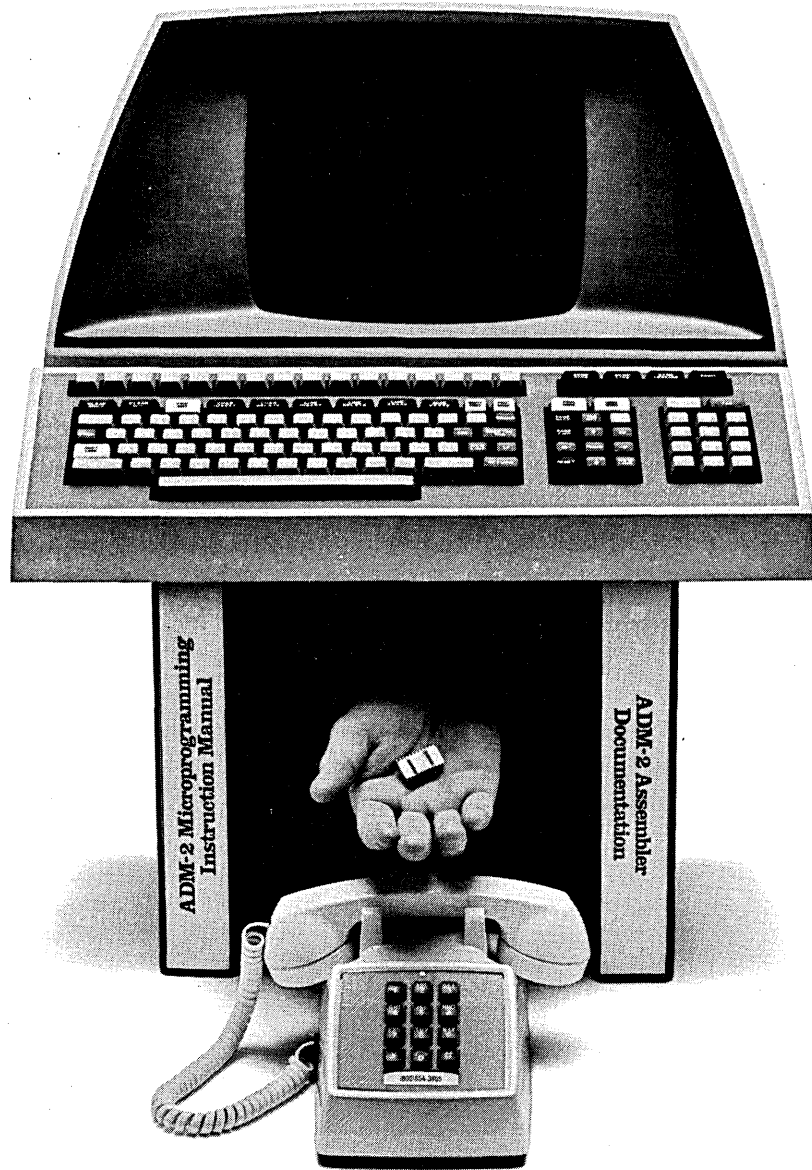

**And  
everything you need  
to do it to it.**

## How the doing gets done.

There's no sense in making a terminal user-microprogrammable — not if it takes a first-rate wizard to do the actual micro-programming.

With that in mind, we've enhanced the ADM-2. To take all the mystery out of the task. And to make user-microprogramming simple, quick, and cost-effective.

To help, there's a brand-new ADM-2 Microprogramming Instruction Manual. Complete with charts, graphs, and step-by-step instructions. Everything you need to know about tailoring your own PROM and the ADM-2's 32 functions to fit your unique applications.

There's a new assembler, too. Special software we've created to save you costly hours of program development time.

And finally, a toll-free "hotline" to Lear Siegler. Because, sooner or later, you may have a technical question or two. Or want assistance with a special program.

When that happens, you've got us "all ears" at: 800-854-3805. Or, in California only: (714) 774-1010.

## Smarter terminal. Smarter buy.

The new ADM-2 gives users and OEM's all the smart features they're looking for.

Like full editing facilities and 16 function keys. Detachable keyboard. Both upper and lower case. 24 lines and 1920 characters on a 12" diagonal screen. Special numeric keypad. Protected data. Dual intensity. Up to 8 screen status indicators. Eight selectable data rates from 110 to 9600 baud. Four transmission keys. Keyboard lock. Easy system interface.

But we also leave your options open.

For example, our ADM-2 Modular with detachable keyboard features a separate electronics package and 9" or 15" screen. And your choice of office or optional walnut exteriors.

## The new ADM-1A. A little knowledge isn't half bad.

Now our ADM-1 is even smarter. Because we've added a numeric keypad to its standard keyboard.

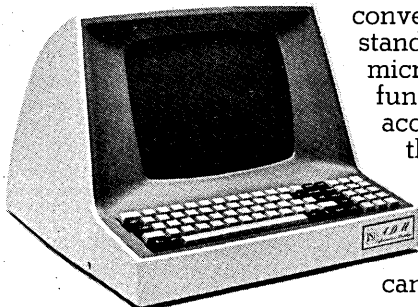

And the convenience of 32 standard, factory-microprogrammed functions. All accessible through the numeric keypad.

Naturally, you can still pick and

choose from a wide range of ADM-1 options.

That way, it's more systems-adaptable and just as smart as you want it to be.

Fitting right into your particular operation in price, as well as in performance.

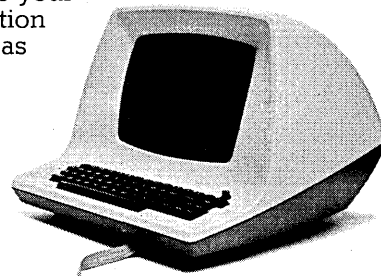

## The new ADM-3A. From the sublime to the dumb.

With all the excitement over the new ADM-2, maybe you didn't notice that the good ol' "Dumb Terminal" terminal has been "fortified," too. Direct Cursor Addressing is now standard.

You still get all the other basic features. Like a 12-line display and full 12-inch diagonal screen.

Plus your choice of options like upper and lower case and 24-inch display with 1920 characters. Even a special plug-in numeric keypad. All available at very reasonable prices.

Of course, our Dumb Terminal is compatible with smarter terminals and related peripheral equipment.

## 10,000 new users can't be all dumb.

Sometimes our growth is even a little hard for us to believe.

The fact is,

**10,000**

we've delivered over 10,000 terminals in the last seven months. Some smarter than others. But all

with the same brand of built-in reliability that keeps smart new users coming in.

And old ones coming back.



**Lear Siegler "hotline":  
800-854-3805**

® In California only: (714) 774-1010.

Lear Siegler, Inc. / E.I.D., Data Products

LSI Sales Offices: Boston, (617) 423-1510; New York, (212) 594-6762; Philadelphia, (215) 742-4440; Chicago, (312) 325-1164; Washington, D.C., (703) 573-9696; Houston, (713) 444-8887; San Jose, CA, (408) 258-3718; Anaheim, CA, (714) 774-1010.

# "We'll sell you the best, lowest priced 132-column printer available anywhere."

Bob Howard, President, Centronics

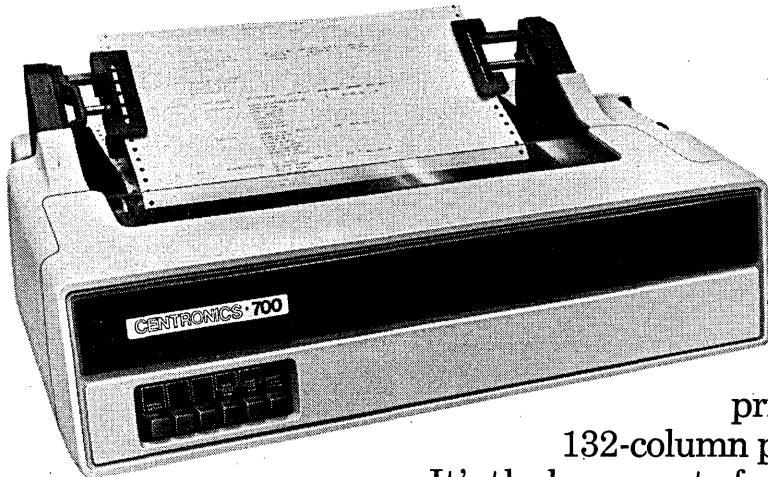

But the low initial price for the Centronics 700 Series 132-column printer isn't the whole story. It's the lower cost of ownership based on the 700's inherent reliability and simplified construction.

The 700's unique modular construction using four different modules — printing, electronics, forms handling and keyboard — and less moving parts mean easier maintenance, lower cost and a smaller spares inventory.

Write for the full details of this tremendous offer . . . and information on the rest of the printers and teleprinters in the new Centronics 700 Series.

**Centronics means more than low price.**

And more than hardware. It's the widest range of models, features, options

- Financially strong
- Proven delivery response
- Over 70,000 printers installed
- 109 world-wide sales/service locations
- Stringent quality control
- Advanced R&D and manufacturing
- Long-term spare parts availability
- Customizing for specific needs.

## **CENTRONICS® IS PRINTERS**

Centronics Data Computer Corp., Hudson, N.H. 03051, Tel. (603) 883-0111, Twx. 710-228-6505, Tlx. 94-3404; Eastern Region: (617) 272-8545 (MA); Central Region: (513) 294-0070, Twx. 810-459-1784 (OH); Western Region: (714) 979-6650, Twx. 910-595-1925 (CA) Centronics Data Computer (Canada) Ltd., Ontario, Tel. (603) 883-0111; Twx. 710-228-6505; Centronics Data Computer (UK) Ltd., Cheam, Surrey, England, Tel. 643 0821-4, Tlx. 851 945756; Centronics Data Computer, GmbH, 6 Frankfurt/Main., West Germany, Tel. 663321/22, Tlx. 841 413224; Centronics of Puerto Rico, Dorado, Puerto Rico, Tel. (809) 796-1881. Tlx. 3859349

# letters

## Cost of living vs. prices

In the recent "DP Salary Survey" (November 1976, p. 61) an attempt was made to "eliminate geography"; indeed, a rather long section of the article was devoted to this effort. In the third paragraph of the section you state, "The CPI attempts to show how much more or less it costs to live in one city than another." It does no such thing!

Your misunderstanding of the CPI has led you to use it incorrectly and renders all your efforts to "eliminate geography" useless. In using the CPI the way you did, you in fact committed two errors; one error was minor and understandable, the other egregious.

First of all, the Consumer Price Index is exactly what it says it is: a price index, not a cost of living index. The CPI is a measure of the average change in price of goods and services customarily purchased by families of wage earners and clerical workers living in cities of the United States. It covers, then, only a limited market basket of goods and services, it does not cover the total expenditures that might be required to maintain a given level of utility or satisfaction (i.e. standard of living).

Your really serious error was to use the CPI for regional comparisons. The CPI simply does not measure differences in the cost of living or even price levels between cities. Since the CPI only measures changes in price levels, a higher index number for one region doesn't necessarily mean that prices are higher there than in another region with a lower index value. All that the higher index value means is that prices have risen faster in that region than in the other region since the base period.

RONALD E. FERGUSON  
*Vice President*

*General Reinsurance Corporation  
Greenwich, Connecticut*

P.S. The Bureau of Labor Statistics does, from time to time, produce some studies that could be used to measure cost of living levels among major metropolitan regions in the country.

Egregious? Bad maybe. Or even dumb. But egregious?

Actually, Mr. Ferguson has hit upon the source of the problem in his postscript. Along with the CPI figures, the Bureau of Labor Statistics produces tables which rate major metropolitan areas based on "Indexes of Comparative Costs Based on a (Lower/Intermediate/Higher) Budget for a 4-Person Family." We used the total

budget index figures for the "Lower" budget family, thinking that one would represent a good base for a no-frills "standard of existence" in those cities.

The CPI numbers themselves measure the change in prices from year to year compared to some starting year (usually 1967) as 100. Those indexes, as one might guess, are all over 100 now—prices haven't gone down in recent years. Our indexes (which we should have called BLS indexes or something) are based on a comparison with the average for U.S. cities as 100. So although their identification was egregiously erroneous, they serve the purpose we intended.

## Saga of the Spectra

As the man who was primarily responsible for the RCA decision to be "360 compatible" in the Spectra 70 systems, I'd like to add a few words to those of Michael Cashman in the article on IteI and their version of compatibility (November 1976, p. 136).

Mr. Cashman states that "RCA's two major mistakes were in not offering software compatible systems . . . and at not enough of a price difference to make enough customers switch brands."

RCA, having no customer base at the beginning, made most of its sales to people who were previously IBM customers. Normally, we caught them at the time when they were shifting from



a smaller to a larger system, or from one computer generation to another, and were faced with a reprogramming task in any case—even within the IBM product line.

We saw in the 360 announcement a strategy of IBM to make it so easy (superficially, at least) for the customer to move up within the IBM product line that opportunities previously available to us would in the future be denied. Hence, a system uniquely RCA engineered in all its hardware aspects that spoke the same 144 instruction language of the 360 series.

Why not plan to use the IBM systems software at the time? Because all of the design decisions had to be made within a few months after the 360 announcement and the necessary information about the IBM equipment and software simply wasn't available, perhaps not

even within IBM, and certainly not to RCA. This was, you will remember, in the year 1964. We did achieve an acceptably high degree of compatibility at the user program level, as conversions both ways subsequently confirmed. That was our primary objective for marketing purposes. Moreover, we had about a 35-40% performance advantage, at the same price, at approximately the same time. Maybe someone else could have done better, but they didn't.

The RCA engineers did an astounding job, going from specifications to an all new technology operating prototype in one year, and to factory production for customers one year later, a total span of 24 months. A complete new family of equipment, with several processors, controls and a large number of new peripherals, all done on an annual budget of \$15 million for hardware and software. To my knowledge this accomplishment has never been equaled in the history of the computer industry and probably never will be. Moreover, of that \$15 million budget a substantial fraction was required for the on-going technical support of older hardware and software products.

Finally, a brief tribute to myself. The compatibility decision has since been embraced by many, including the English, Germans, Japanese and the Russians. I was not without honor, even in my own country. The management that presided over the declining fortunes of the RCA computer business never questioned the Spectra 70 decision. All hail to Spectra 70, a helluva fine product.

E. S. MCCOLLISTER  
*Director, Market Development  
International Group  
Burroughs Corporation  
Detroit, Michigan*

## Professional name-callers

I just finished reading the Letters section of DATAMATION.

Have you noted the personal comments that seem to accompany letters that come in which are opposed to, or that differ from, the viewpoint expressed by someone else? We are supposed to be professionals in our chosen field of endeavor with all of the standards of ethics and behavior that go with this word.

If I may be permitted to quote, out of context, some remarks from the letters printed in the October 1976 issue, this is what we read.

In one letter, people were referred to as "garbage."

In others, "Speakers were misguided."

"Work done by \_\_\_\_\_ is irrelevant."

"I am astounded by the monumental ego and lack of perception shown by the author."

# letters

"The writer of the \_\_\_\_\_ shows no more knowledge about what is wrong with the computer field than the man in the street."

"I think he is wasting his breath."

As so-called professionals, can't we disagree without getting personal? There are many ways to state different or opposing viewpoints without first attacking the person with whom one disagrees, aren't there?

We deal with lawyers and CPA's in our business environment, and I have never heard or seen one of these people hit out at another of their kind in any personal manner. I have seen lawyers present opposing cases, and when it was all over they shook hands. I have seen a CPA firm come in and fix up a set of books that were messed up by incompetents. No remarks were made about the predecessors. The CPA's just did their jobs and let the results speak for themselves.

Can't we simply write our own position on some issue and indicate an agreement or disagreement with other people's points of view and leave the personal remarks out of it? I surely hope so, because, in my opinion, we won't be truly "professional" until we do.

If you publish this letter, someone will surely write in that I am being too sensitive. This is a personal remark again, isn't it?

WILLIAM A. DELANEY, PRESIDENT  
*Analysis & Computer Systems, Inc.*  
*Burlington, Massachusetts*

## The "dangers" of TM

Mr. Sauer's enthusiastic letter (November 1976, p. 8), belies the very real dangers of TM, whether applied in business or in personal life. His statement that TM is "nothing metaphysical" is wrong. TM is in fact a deeply metaphysical process leading ultimately to a world view at complete odds with modern Western culture and business. Those who seriously promote TM stress only the initial "effectiveness benefits" that some TM initiates experience; they conceal TM's basic pantheistic nature and potentially disastrous personal consequences.

For an alternate view, I recommend the 25¢ booklet "TM" by David Hadron, InterVarsity Press, Downers Grove, Illinois 60515.

LYLE H. KELLY  
*Senior Systems Analyst*  
*Management Systems Division*  
*Procter & Gamble Company*  
*Cincinnati, Ohio*

(Ed. note: Complete title of the book-

let Mr. Kelly refers to is "Transcendental Meditation: A Christian View," InterVarsity Press is the book publishing division of Inter-Varsity Christian Fellowship, a student movement.)

## No simple solution

In reference to David Black's excellent article "Converting to a Mini" (October 1976, p. 79), it was mentioned that program size limit problems due to addressing limitations may be solved by utilizing paging techniques. Trying to page large COBOL programs and achieve acceptable throughput, in a real world environment, is like trying to reinvent the wheel with an octagon. Neither gives satisfactory results.

Although paged programs that are infrequently run or do not page extensively should not affect throughput significantly, large scale paging is an indication that either a different processor is required, or systems rewritten to maximize a mini's architecture. Neither is a simple solution.

RON R. LEBLANC  
*Data Processing Manager*  
*Clinton County Legislature*  
*Plattsburgh, New York*

## A policy decision

Although I agree with Frank Wagner's concept (November 1976, p. 86) of decentralized computing, I believe he has overlooked several important considerations. Just as hardware costs have decreased for small computers, the larger machines have also come down in price. The problem with many centralized computer facilities is that management has not passed on these savings to its users either in the form of lower costs or increased capacity. As Mr. Wagner states, central facilities are usually run to optimize hardware costs rather than human costs and hence operate like a bottled-up superhighway. Simply increasing the availability of the computer would make a dramatic change in the service level to its users. This can be solved by a policy decision that would be no more difficult to make than the decision to decentralize using minicomputers.

More important, I believe, is the concept of decentralizing the centralized facility so that the user can control his own destiny. The "modern" centralized facility can provide a decentralized service today! Time sharing service companies have been offering this capability to their users since 1968. There is no reason that all computer users cannot enjoy this service. The user can make his or her own decisions about how to solve his or her own problems—whether to use a standard programming language or a software package, whether the program is

to run interactively or in a batch mode, and on and on.

There are also drawbacks to committing to a small decentralized mini-computer installation. Several have been mentioned, including the current availability of software. But even when this is rectified the quantity and diversity of the software that a given mini installation can maintain will always be a problem and the centralized facility will probably always be one step ahead of the mini in this area. If the user's needs are simple, then a mini will be the answer. But if there is complexity and diversity, both of which may evolve over time, then the ability to address the user's changing requirements is important. For example, a newly introduced mini is set up to solve the user's accounting needs. But now he wants management planning aids. He must start the search for a package to do financial planning. The next logical step is to tie this to his accounting system. If the financial planning package can not be run on the mini, he is in trouble. Next the user would like to see graphical output from this planning process but cannot justify the cost of purchasing a quality plotter. Again he must go elsewhere. The end result is that each small group of users is doing software and installation management instead of leaving this to one centralized group of "professionals."

The well run centralized facility will provide many alternatives that suit the user's needs best, even when his needs change. I disagree with Mr. Wagner's statement that the computer "is not all things to all men." It is at its best when it can be. Only then can the user feel confident that his choice today will be applicable to tomorrow's problems.

Mr. Wagner contradicts himself when he states that generalized operating systems are often so complex they are unusable and later states that good operating systems provide conveniences for the programmer. The fault lies with the particular operating system chosen. A generalized operating system can do more for more people and still be simple to use. The centralized facility should also provide for operational conveniences that the user should not worry about such as data backup, redundancy of hardware elements, and servicing of the equipment.

I am not a diehard supporter of the large mainframe, but we should all be aware that decentralized computing is not limited to the mini and is available today. A well run centralized installation can provide a cost effective decentralized service.

HAROLD FEINLEIB  
*Vice President Systems Products*  
*National CSS, Inc.*  
*Norwalk, Connecticut*

\*

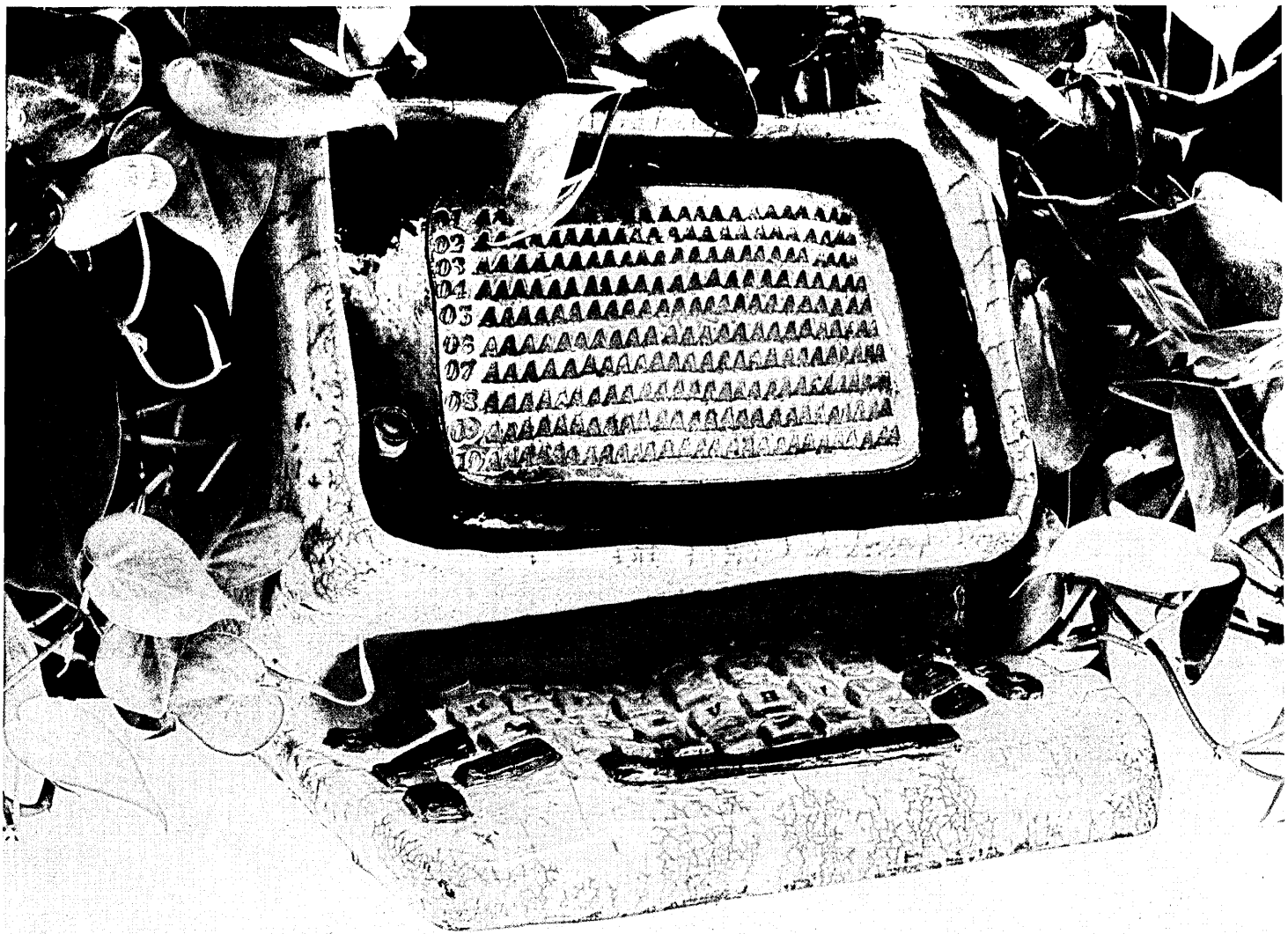

# You're outgrowing your 3270. Now what?

Things really bloomed when you first put your 3270 on line. But now your system's growing like a jungle.

Your phone lines or your mainframe go down...so your 3270 just sits idle.

And when everything is working, your lines jam up and your mainframe bogs down...so your 3270 works a lot more slowly than you'd expect.

Errors keep cropping up, but your 3270 can't weed them out.

And you'd like to keep a small data base at your terminal...but your 3270 can't handle that.

Solution? Add or replace with the Sanders 8170.

The Sanders 8170 is completely compatible with the 3270. Emulates it 100%, without requiring debugging or new software. Costs less, too.

As you grow, Sanders enhancements keep your 8170 growing by

distributing the processing...without wiping out your software investment.

When your phone lines are clogged or down, Sanders Queued Transaction Handling stores your data locally until your mainframe becomes available.

Operator errors? Sanders Local Validation and Arithmetics catch errors on the spot. Sanders Local File

Reference lets you see names or descriptions whenever you enter an account number.

Sanders Local Format Storage speeds up your operation by eliminating the transmission of lengthy formats. Sanders Automated Keystrokes give you multi-key entry from a single key depression. And Sanders Formatted Local Print lets you select, rearrange, and print data without host intervention.

Sanders 8170, The Intelligent Answer. Immediately available, so you can replant before you get lost in the jungle.

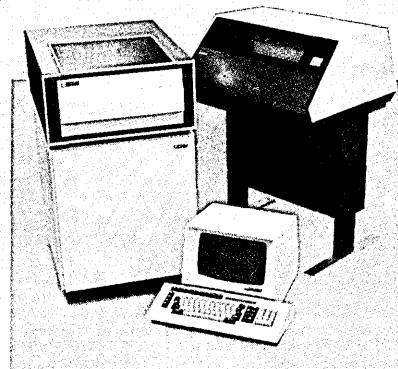

**SANDERS**  
DATA SYSTEMS GROUP

Sanders Associates, Inc.

CIRCLE 81 ON READER CARD

Home Office: Daniel Webster Highway South, Nashua, New Hampshire 03061 (603) 885-6685 • Sales Offices: California (415) 692-2485; (213) 641-4613 • Colorado (303) 771-4380 • Connecticut (203) 246-7289 • Florida (305) 592-7424 • Georgia (404) 451-8815 • Illinois (217) 529-0221; (312) 693-2087 • Louisiana (504) 887-7904 • Massachusetts (617) 899-9061 • Michigan (313) 649-3660 • Minnesota (612) 854-5695 • Missouri (314) 647-1111 • New Jersey (201) 636-0722; (609) 665-3350 • New York (212) 489-7750 • North Carolina (704) 527-2642 • Ohio (216) 888-7300 • Oklahoma (405) 235-1421 • Pennsylvania (412) 563-3313 • Texas (713) 681-5821; (214) 233-0691 • Virginia (804) 270-0602; (703) 920-5204 • Washington (206) 363-3930 • Wisconsin (414) 543-6240 • International Subsidiaries: Germany [Frankfurt] 67 80 39 • UK [London] (01) 499-9452; [Manchester] (061) 228-3565 • International Distributors: Australia [North Ryde NSW] 888-8111 • Denmark [Copenhagen] 14.63.04 • Italy [Milan] 34.44.59 • Japan [Tokyo] 543-7611 • New Zealand [Lower Hutt] 664-149 • Venezuela [Caracas] 781-8888

\*Trademark of Sanders Associates, Inc.



# Your mother does not like to be interrupted when she's busy.

It's too bad your big computer has such a busy schedule. But that's the way your mother was meant to work.

That steady job stream has been very carefully planned out to make the most of your mother's time.

Which, unfortunately, has made it tough for your mother to handle things that don't fit into the schedule. Things like demand reports, online data entry and unplanned jobs.

But that doesn't mean you can't do the unexpected. All you have to do is get your big computer a little help. A computer that can do the jobs your mother can't handle.

A Data General commercial ECLIPSE computer.

The commercial ECLIPSE computer is smaller than the big computers you may be used to using. But it has the things big computers have.

A commercial instruction set that even has an EDIT function, for example. And large memory configurations.

This computer also has incredibly easy-to-use interactive data entry/access software called Idea that speeds program development and use. And speeds use of business-oriented files maintained by our INFOS data management system with multilevel keyed access.

The COBOL that's available with the commercial ECLIPSE computer is the highest level implementation of ANSI '74 COBOL standards.

It's a complete language system that comes with features like an interactive debugger, and an integrated SORT/MERGE. Plus it also includes an IBM-compatible RPG II and real-time FORTRAN.

Most important, this computer has a communications ability that lets you interface to your big computer. For example, when talking to an IBM system, the ECLIPSE computer can emulate 3780/2780 and HASP procedures. Or just be itself.

And wherever you put this computer, you can plan on it doing more than one thing at a time. Up to 16 Idea applications and remote job entry concurrently, for example.

Or one Idea application using up to 16 terminals while a COBOL program processes previously entered data. Or simultaneous program development and communications.

It's all from a major computer manufacturer, Data General. Which means you get full software support, a range of system and field engineering services, financing alternatives, compatible peripherals and much more.

Write for more information.

That way, your mother will be able to work the way she was meant to.

And you won't have to interrupt her when she's busy.

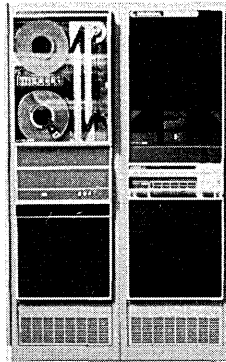

COMMERCIAL ECLIPSE COMPUTERS: BECAUSE YOUR MOTHER NEEDS A LITTLE HELP

## Data General

ECLIPSE is a registered trademark of Data General Corporation. INFOS is a trademark of Data General Corporation.

• Data General, Route 9, Southboro, Mass. 01772, (617) 485-9100. Data General (Canada) Ltd., Ontario. Data General Europe, 15 Rue Le Sueur, Paris 75116, France. Data General Australia, Melbourne (03) 82-1361/Sydney (02) 908-1366.

CIRCLE 48 ON READER CARD



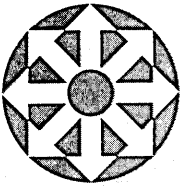

# LOOK AHEAD

## SOFTWARE VENDOR LISTS FOR PEACHTREE

IBM will provide Series/1 purchasers with a list of software vendors for system and application programs. Although there has been some confusion both in the industry and among the IBM sales force on the mechanics of the process, some of the large independent software houses have carefully been considering the market possibilities. IBM previously offered software vendor lists on both the System 32 and System/3.

William Acker, the president of Advanced System Associates, a large software house in Wellesley, Mass., said he doesn't think this is going to be a "price sensitive business." On a straight performance basis, he notes, "many people don't think Series/1 is so great a deal--and that tells me that customers who go to IBM for Series/1 will be willing to spend luxury money.

"The money in that work might be larger than most people expect," Acker said. And if IBM holds to its intention of selling almost exclusively in multi unit packages, the software demands of a Series/1 user might well be beyond the capability of the one and two-man software houses who provided the bulk of the program support for the System 32 and System/3. Such work might prove attractive to larger firms. And Acker who kept out of the System 32 business because it "didn't seem worth our while," says he's interested in the Series/1 software opportunities.

## DPD MAY RECOMMEND BUT GSD WILL SELL

IBM is beginning to clear the confusion over who will sell the Series/1 minicomputer. There had been talk of a joint sales force from the General Systems Div. in Atlanta and IBM's Data Processing Div. in White Plains. This led to uncertainties because the DPD traditionally provided full systems support. Although the two divisions will be working "in conjunction" on Series/1 sales, explained a patient GSD spokesman, the new minicomputer will remain a GSD product. "DPD may recommend it, but GSD sells it," he said. "GSD will come in at the invitation of DPD to sell Series/1 to particular customers."

IBM has targeted large volume users as the Series/1 market, but with the software limitations and IBM's no-discount policy, prestige, international service and reliability may become the key selling factors.

## IBM TO OFFER NETWORK ORIENTED RELEASE OF DOS/V5

Forced migration to OS/V5 has long been IBM's strategy with DOS/V5 users--obviously because of the cost of supporting multiple operating systems. But if current reports are true, IBM is giving in to the diehard DOS users. In release 34 of DOS/V5, they'll get important capabilities they've lacked, particularly for handling large networks. Coming from developers in West Germany, this version will contain features such as the use of "multiple transient areas," console spooling, and a facility that allows more devices per partition through the supervisor--all improving teleprocessing performance.

## MORE FOE THAN FRIEND

As AT&T draws up fresh battle plans for the new 95th Congress, a key question for Bell strategists in the Senate still centers around which side, if any, Sen. Ernest F. Hollings will choose to champion in the upcoming telecommunications debate. Rumored to be the front-running contender to replace retired Sen. John O. Pastore as chairman of the Senate Communications Subcommittee, the South Carolina democrat has been ardently courted by Ma Bell in an attempt to win support for their heavily lobbied Consumer Communications Reform Act.

But Ma Bell's wooing may be to no avail. A Senate veteran for 11 years, the former South Carolina governor seems more of a foe than a friend to the zealous anti-competitive AT&Ters. In a letter last April to major Bell Bill booster Frank S. Barnes Jr., president of the U.S. Independent Telephone Assn., Hollings debunked the "technical harm and economic injuries" that Bell contends will result from unfettered and selective competition.

These claims, he argued, have "never been proven before either the Federal Communications Commission or the courts. Prudence and fairness," he advised, "would therefore counsel against accepting the drastic measures proposed" by the AT&T sponsored legislation without "clear and convincing evidence that such predictions are in fact real consequences of competition."

## WHAT'S IN A TRANSACTION?

IBM believes data processing is involved--at least when it comes to AT&T's Transaction

# LOOK AHEAD

Network Service (Aug. '76 p. 105). At least one IBMer does. And he believes the FCC should stop it.

Wallace C. Doud, an IBM vice president, testified before a hearing of the National Commission on Electronic Fund Transfers held last month in San Francisco that "serious questions with respect to policy and regulations of the FCC are raised when regulated common carriers supply EFT systems." He more specifically said "The Transaction Network Service (TNS) currently being offered in several states by AT&T performs data processing functions along with transmission."

## WHAT'S NEXT FOR THE MAG STRIPE?

Magnetic stripe technology is highly suspect in terms of security but also is widely used. Everybody is trying to get into the act with ideas to make it fraud-proof. Early on, Addressograph-Multigraph had what seemed to be a good answer, embedding the stripes with reflective particles. It worked but hasn't been marketed yet, presumably because it hasn't proven economically feasible.

Now there are two more technologies promised. One is a water mark on the stripe which is expected from EMI Technology, Danbury, Conn. and the other is a technology from Japan which would enable color to be imprinted over the mag-stripe which would have the additional advantage to plastic-holders of making it possible to have-say-a Master Charge on one side and a BankAmericard on the other. All this plus security!

## CITIBANK IN TIMESHARING

Despite strong objections from the Assn. of Data Processing Service Organizations (Adapso), Citibank has jumped into the time-sharing business in a big way, offering bulk time at what it claims to be half the going commercial rate in an effort to sign up "Fortune 500" companies, correspondent banks and other users. Already the giant bank, which will provide financial packages as well as time and will offer national service through Telenet or another packet switched network, has several major customers on its Digital Equipment Corp. Model 20. "And we've got a long line of prospects," says bank assistant vp Alan L. Summers. "The response has been fabulous."

Pressing for public hearings into the Citibank move, Adapso president Jerome Dreyer contends the bank is employing "predatory pricing practices" in order to bring in business in other non dp areas. "This will adversely affect every major time-sharing firm that markets to the financial area" he asserts. Several time-sharing companies like ADP Network Services which serves about 100 banks, report they are assessing the Citibank move extremely closely. Ironically ADP acquired Citibank's payroll computer service business a year ago.

The bank maintains prices are structured so that it can realize a significant profit from the operation and are not designed to serve as so-called "loss leaders." Dreyer indicates litigation against Citibank is a possibility.

## CATAMORE LAWYER TOM CHRISTO STRIKES AGAIN

Lawyer Tom Christo, who made his mark with the Catamore case with IBM (Aug. '75 p. 57) closed out 1976 with a bang. His legal battle with Honeywell on behalf of Colorado Blue Cross (Jan. '76 p. 17) was settled out of court for undisclosed terms. Honeywell sued Blue Cross for \$36 million and was countersued for \$39 million over a big system contract.

While that case closed, Christo filed another suit against Honeywell for Porter Paint Corp., Louisville, Ky. This one charges, among other things, antitrust violations due to Honeywell's policy that charges second users for software previously provided bundled with Honeywell systems. That is the second case involving this controversial policy. The first was brought by Integrated Computer Services in New York and settled out of court last year. Since settling out of court seems to be Honeywell policy, perhaps that's how the Porter Paint case will go.

Finally, Christo was waiting for a decision on his petition for a rehearing in the Catamore Case. A few months ago, the appeals court set aside the jury decision in favor of Catamore and called for a retrial. The petition was made, and in an unprecedented move, the court asked IBM to respond to Christo's petition--a harbinger that the court may rehear the arguments, have a new hearing, or draw up a new opinion. (IBM responded in December and the indefatigable Christo filed a motion to strike it for mis-citing the record). The decision is due now.

Asked hypothetically if he would consider running the Justice Dept. case against IBM

(Continued on Page 168)

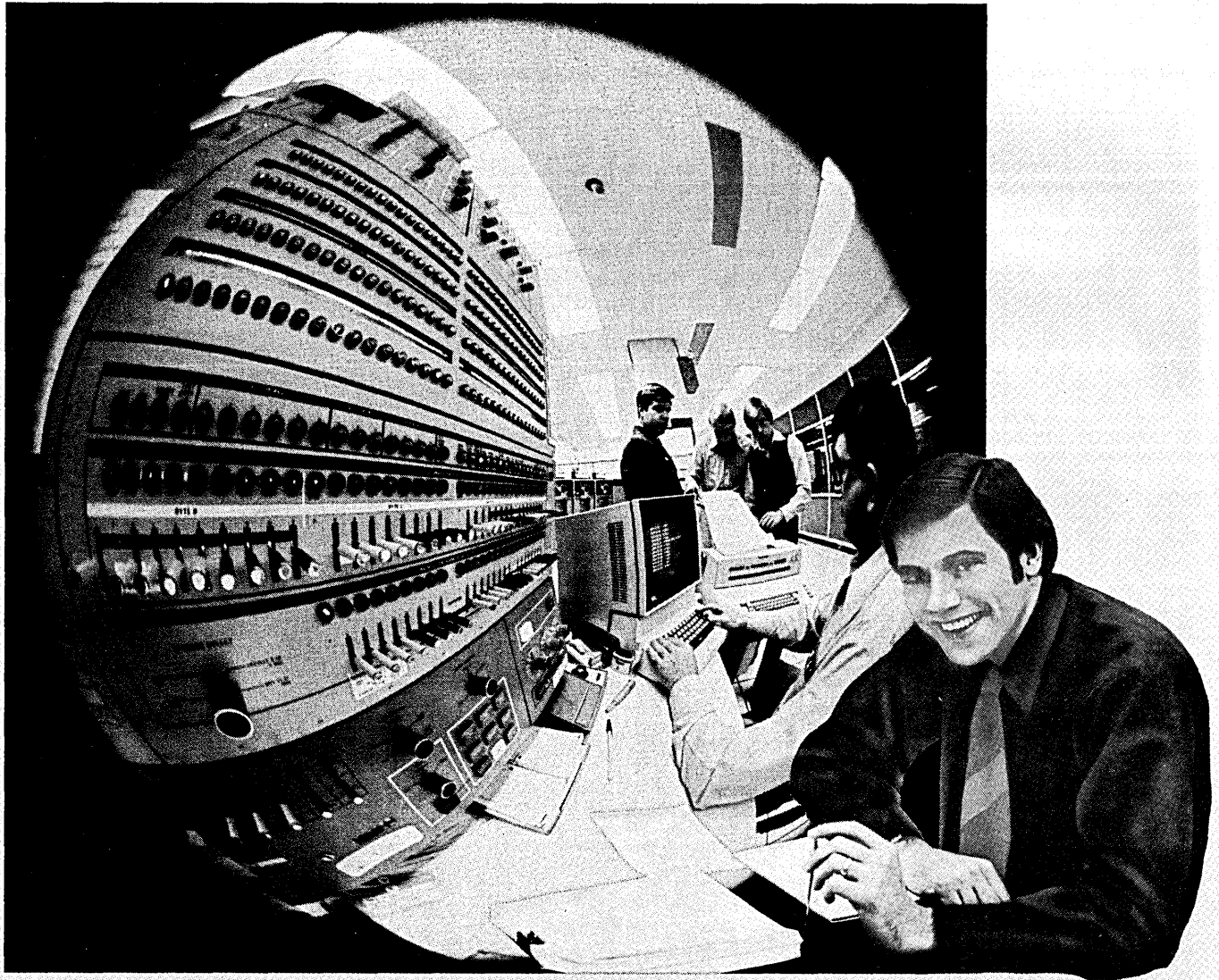

# “MARK IV® has been everything it was billed to be...”

A testimonial by Jack Moran, Corporate DP Manager, Butler Manufacturing Company,\* Kansas City, MO.

“If I had to select the one thing I like best about MARK IV, it would be the obvious productivity improvement we’ve enjoyed. Today we’re doing everything we were doing in 1970 when our programming staff was 40% larger.

“We have a 370/145 running five to six thousand jobs a month, three shifts a day, with a large teleprocessing requirement. The primary payoff we were after was in manufacturing applications, including order entry, order processing, and material and inventory control, as well as spin-offs in accounts receivable, sales analysis and general accounting. The majority of these systems, representing about 75% of our total processing load, are now in MARK IV.

“An important part of the MARK IV selection process was an evaluation of Informatics as a supplier. How competent were their support personnel? How timely and well-tested were their product updates? How effective were their educational offerings? In all these areas we evaluated Informatics to be superior to their competition.”

**WHAT IS MARK IV? MARK IV is the most versatile and widely used software product in the world for application implementation, data management and information processing.** Six powerful models (with prices from \$12,000) are in use on IBM 360/370, Univac 70/90, Sie-CIRCLE 26 ON READER CARD

mens 4004 and Amdahl 470 computers at over 1,000 installations in 43 countries. Programs in MARK IV require only about one-tenth the statements of Cobol, and users report 60% to 90% cost and time reductions on most MARK IV applications. Send the coupon today for detailed information.

**informatics inc. Software Products**

*\*Butler Manufacturing Company is the leader in the pre-engineered buildings industry.*

Informatics Inc., Software Products, Dept. D,  
21050 Vanowen St., Canoga Park, Calif. 91304

Name \_\_\_\_\_ Title \_\_\_\_\_

Dept. \_\_\_\_\_ Computer \_\_\_\_\_

Firm \_\_\_\_\_

Address \_\_\_\_\_ Phone \_\_\_\_\_

City \_\_\_\_\_ State/Province \_\_\_\_\_ Zip \_\_\_\_\_

# INTRODUCING THE ONLY SENSIBLE ALTERNATIVE TO THE IBM-370.

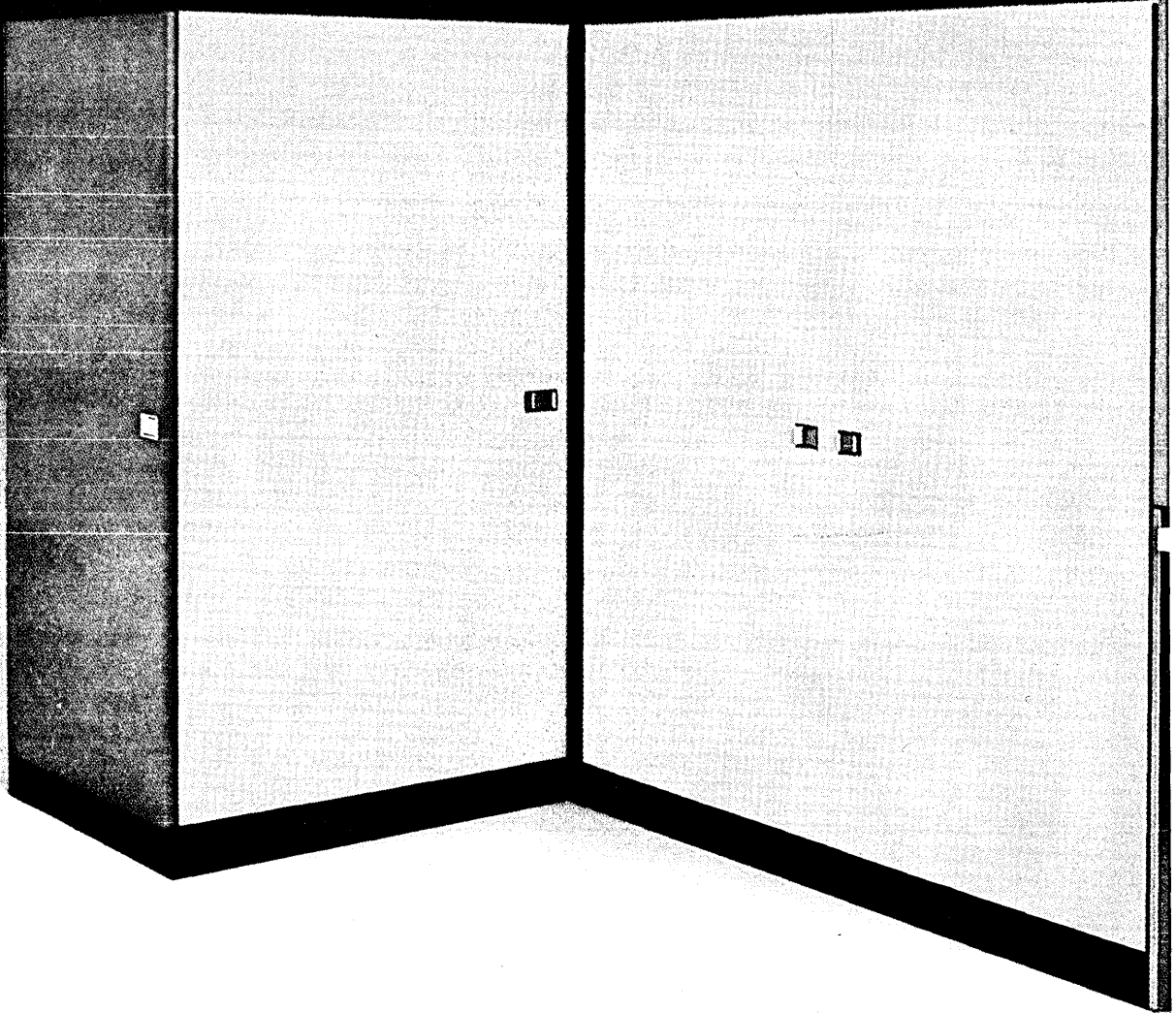

It wasn't easy, but we did it.  
We took IBM's best concepts —  
and improved them.

The result is the all-Intel Advanced  
System. The computer system that  
not only gives you everything its IBM  
counterpart does (in some cases,

even more), but gives it to you at  
an enormous savings. A savings so  
significant that it makes the  
Advanced System the absolute  
number one price performer on  
the market today.

Still, we couldn't have done it  
alone. Not without the dramatic  
advances made by the semi-  
conductor industry. Advances  
that allowed us to build a more

# ITEL'S ADVANCED SYSTEM.™



reliable, more powerful CPU using about half the components of its IBM counterpart. Which means our Advanced System runs approximately 10 degrees cooler, increasing the reliability of its integrated circuits.

Moreover, the Advanced System comes complete (including a 180 cps printer, not shown). No optional "special features" that wind up costing almost as much as the original system itself.

To prevent obsolescence (and

protect your investment), all of our Advanced System models can be upgraded as the situation demands.

It's this kind of all-out creative effort that has put us right up there with IBM. Not only in total computer capability. But in systems and software. In computer peripherals. In field engineering. In financial packaging.

When it comes to experience and reputation, it's either us. Or IBM.

And when it comes to price/performance, there's only our Advanced System. ITEL. The only sensible alternative.

**ITEL**  
CORPORATION

Data Products Group  
One Embarcadero Center  
San Francisco, California 94111  
Telephone (415) 983-0000



Wherever it's said, however it's spelled,  
**Informatics®** fulfills the promise  
of the computer...universally!

*Informatics...the word is synonymous throughout the world with the ultimate in modern data processing. In the United States and many other countries it means the people, products and services of Informatics Inc. One of Informatics' many products...ACCOUNTING IV®, a family of software modules for financial applications, includes Accounts Payable, Accounts Receivable, General Ledger and Financial Reporting, and Standard Product Cost modules, all in ANS Cobol for a completely integrated accounting system. Informatics Inc., the world's leading independent software supplier, with over 2,000 installations in 42 countries...helping to fulfill the computer's promise.*

SOFTWARE PRODUCTS  
PROFESSIONAL SERVICES  
INFORMATION PROCESSING SERVICES

**informatics inc.**

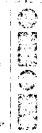

Corporate Offices/21031 Ventura Boulevard/Woodland Hills, California 91364/(213) 887-9040/Telex 69-8473

® Informatics and ACCOUNTING IV are U.S. registered service marks and trademarks of Informatics Inc.  
CIRCLE 40 ON READER CARD

---

---

# people

---

---

## Finding The Total Pie

Marketing data processing services requires a presidential viewpoint. That is, the need to see each client company's overall operations through the eyes of its chief executive. And this is what makes dp services both work and play for Joseph T. Verdesca, president of Computer Dimensions, Inc. of Dallas, Texas.

"I do very little in terms of physical relaxation," said Verdesca. "My business is my relaxation. I like my work. I enjoy the involvement, the people, the customers."

In his business, Verdesca supplies comprehensive dp services, including a nationwide data communications network, to the automotive industry, financial institutions and insurance companies. And like the artisans of early civilizations, Verdesca finds satisfaction in conceiving and fabricating a complete product for each customer. In fact, this artisan-type desire for thorough, integral creation first directed Verdesca to the data services industry.

As a tactical instructor in the Air Force during the middle 1950s, Verdesca relished the life of a peacetime military officer. He had entered the military through the Reserve Officers Training Corp after graduating from UCLA. "I thought seriously about staying in the military as a career," he said. "I really enjoyed the life, but there were not many opportunities to advance with achievement."

So in 1957 Verdesca left the service to study his options. After earning his M.B.A. from the Harvard Graduate School of Business, "I considered three general industries, those of aerospace, data processing and motion pictures," Verdesca continued. "I excluded most aerospace and data processing companies as being too highly structured. In any of these jobs it appeared as if you could only see a small piece of the total pie. It looked similar to a factory job where you only work on one piece of the final product. But then the movie industry was just too unstructured."

He finally settled on an aerospace career in a company with what appeared to be a growth opportunity. "I thought, 'Now I can really move,'" he said. "So they gave me a desk and I started ordering shock absorbers. And

I ordered big shocks and little shocks and medium shocks. And fat shocks and skinny shocks until I knew this wasn't for me. I could just never get my arms around an entire project."

Then in IBM's Service Bureau Corp., Verdesca saw the chance of at least getting a view of the total pie. This view was of SBC's customers. "It was almost like being the president of each company the minute you walked in the door," said Verdesca of marketing SBC's dp services. "Of course you're never as intimately involved as the president, but you do get more of a perspective of his company's needs and



JOSEPH T. VERDESCA  
"I like my work"

problems than if you were, say, just selling him a computer itself."

Verdesca worked for the IBM subsidiary for eight years. He advanced with achievement to where Thomas Watson Jr., then IBM board chairman, interviewed Verdesca as a candidate for an extensive training program for potential high-level corporate executives. The purpose was to expose rising man-

agers to the company's overall operations. "I was really flattered," said Verdesca. "We flew to his home in Maine in his private jet. In fact, he piloted it himself. Then during my interview I asked Mr. Watson some questions about the future of data services in the corporation. He indicated the company was shifting its emphasis more towards hardware and encouraged me to transfer to that division."

But since Verdesca now preferred the challenges of data services he opted to look elsewhere for a future. Elsewhere emerged during 1967 as an invitation to buy into a struggling data processing services corporation in Dallas—Management Data Services, a subsidiary of Core Laboratories. After investigating the firm's then current condition and future potential, Verdesca agreed. He moved from Chicago to Dallas to form Computer Dimensions, Inc.

Following several years of aggressive ventures, including going public in 1969 and acquiring several dp services firms in Detroit and Los Angeles, Verdesca's company left its last net losses to 1972. The firm now shows growing profits each year, and at this writing its purchase by ITEL was imminent.

As CDI president, Verdesca has learned some of the vital ingredients for surviving and prospering in the dp services industry: adequate capital resources, viable services for a narrowly defined market, a lot of small accounts, perseverance and good luck.

Verdesca said he never regrets moving to Dallas and CDI. "I really love Dallas; I have since coming here in 1967. I now almost consider myself a native Texan and I like to address my friends in Chicago by 'Howdy Partner.'" And as for his job as CDI president he said: "I never thought it was the wrong move. IBM did phase out its services and finally sold the Service Bureau Corporation several years ago. And I really like the data services end better."

## Grass Grows Faster in New York

Trial of the Justice Dept.'s case against IBM was going so slowly, it frequently was characterized as like watching grass grow. "I thought an even better characterization would be like watching Astro Turf grow," says E. Z. Million, an Oklahoma computer consultant who has been assisting the Justice Dept. for a year and who is among those credited with accelerating the pace of the government's case against IBM.

The trial, which began in May 1975, is in its 19th month. It began at a snail's pace as early witnesses spent up to two weeks on the stand and the government's schedule slipped two

months for every month that the case continued. "It was as if the government, in trying to establish that IBM had sinned, was doing so by listing every sin they ever committed," says Million. "It was my contention that we slay the dragon and then get on with relief," he adds.

Million, a 36-year-old former IBM systems engineer, is the principal technical consultant to the trial staff. But he feels his real job was to orient the trial staff's thinking towards the computer industry's viewpoint, "rather than that of six theoretical economists," who were the government's key consultants. Trial evidence discussed

## people

what had happened in the '60s and Million felt that much of this would be irrelevant when applied to what was happening in the '70s and what would happen in the '80s. The key, he felt, was for the government to accelerate the testimony and then get on with determining what kind of relief it wanted.

The pace has quickened in recent months. The trial now lasts five hours a day for five days, instead of four hours for four days. Eight-hundred transcript pages are being ground out a week, compared with 500 previously. The



E. Z. MILLION  
A problem of credibility

government has trimmed the number of witnesses it will call and the time they spend testifying has declined from two weeks or more to, in some cases, an hour. Its case will be wrapped up by next May, well ahead of schedule.

Million, who received his B.S. in mathematics in 1961 and his M. Eng. in Computer Science in 1964 from the Univ. of Oklahoma, has been an independent consultant in Norman, Okla. since 1972, specializing in dp work. He was assigned to the Air Force before that as a Presidential Interchange Executive and more recently worked with the Federal Communications Commission as a consultant on an RFP for advanced computer systems. He's been in the computer field since 1958 as a student at Oklahoma (which, he notes, was the beneficiary of a 60% IBM educational discount—a point in the case—in 1958). He was a systems engineer with IBM for two years in Oklahoma City, and later a professor at Oklahoma City Univ.

With the Justice Dept.'s antitrust division in New York, Million has been working full time since December

1975, but will go on a part-time basis early in 1977, probably returning full time when IBM begins to present its case. He likes his work as "an opportunity to influence the direction of the computer industry for a long time."

Million is a fourth generation Oklahoman, although he was born in Idaho where his father was teaching law at the time. His name causes some problems with credibility, he admits, remembering a case in a college fraternity house when he had to place long distance telephone calls through an op-

erator—"asking her to charge somebody named E. Z. Million." E. Z. stands for Elmer Zen (the latter name being an abbreviation for his mother's name, ZennaBelle Clark), "but I've always been called E. Z. or 'Easy'." His father also is Elmer but goes by the name of "Bud." Then there was a grand uncle who died recently. His first name was Tennyson (for Alfred Lord). "He went through life called 'Ten Million,' so I guess I can bear being called E. Z. Million."

## He's Selling Solutions

Daniel Duke is an accountant who broke his pencil and is making it with minicomputer peripherals instead.

His new company, Source One in El Segundo, Calif., formed in November, did \$100,000 in business in its first 30 days of existence. The computer industry, says Duke, has created a problem for the end user of minicomputers. He is selling solutions to this problem in the form of a wide variety of minicomputer peripherals, hardware integration, and service. The three-man firm, due to grow to four this month, includes two former Sirvess Inc. employees whose specialty is maintenance.

"I hated accounting," says the affable Duke who isn't quite sure why he ever got into it except that "It put me through school." He worked in a variety of accounting jobs during the seven years he attended Wayne State Univ. at night to obtain an accounting degree. After college he went to work as controller for Mohawk Lumber and Hardware in Detroit. "Then I broke my pencil."

He'd decided selling was attractive to him. A friend who worked for Com-Share got him a job with the time-sharing firm for which he headed up offices in New York, Boston, Detroit and St. Louis. From Com-Share he joined Leasco as eastern regional sales manager for time-sharing. In both these jobs he was primarily involved with software.

He made the switch to hardware when he joined Digi Data Corp., Jessup, Md., manufacturer of tape drives for minicomputers. Digi Data sent Duke to the West Coast in late 1975 to open a West Coast office. From that time until he left Digi Data to form Source One last November, he took the Maryland firm's West Coast sales from \$170,000 a year to \$100,000 per month.

It was while selling for Digi Data that he saw the end user problems he thinks Source One can solve. Duke emphasizes that his company is selling hardware and service, each with

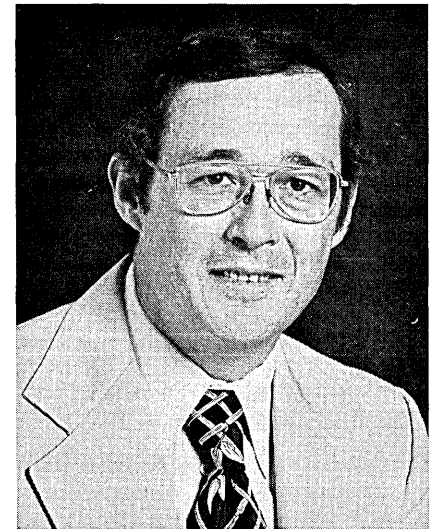

DANIEL DUKE  
... a broken pencil

or without the other. They don't get involved with software and count systems houses and software firms as among their potential customers. Duke says his goal is to have offices in 12 key cities, each with a sales manager and a service manager and "as many technicians as we can afford." He expects to open up "in a minimum of four cities" within the next eight months.

Among the things Duke considers unique about his firm is the fact that it offers trade-in allowances. Among its many offerings, Duke's company includes a controller and disc combination for Digital Equipment Corp.'s LSI 11 V03 microprocessor based system which DEC offers with a floppy disc which limits its capacity. For users who want to go the controller and disc route via Source One there is something they can do with their floppies. They can trade them in.

Duke says service is the real key to his business—the kind of hand holding manufacturers can't provide to end users. He also likes to offer each customer a variety of possible solutions to his problems. \*





## Who could give you more to count on than 3M?

What you see here are products representing our full line of Scotch® brand magnetic data recording products, including computer tape, disk packs, data modules, disk cartridges, diskettes, data cartridges and digital cassettes. Each is carefully designed and engineered to meet the specific requirements of the data system it serves. Yet all of these products share one important advantage: the long experience and skill of the people behind them.

They're made and backed by a team of more than 1000 special people: research experts, production specialists, and sales and service technicians. The 3M Clan. The people who pioneered and perfected the first commercial

computer tape in 1953. People who have led the industry ever since with innovations and improvements. People who are dedicated to providing you with the best in data recording products and service.

Now, we're making all of these products more widely available than ever before. From leading data products suppliers who have joined our clan.

For more information, write:  
Data Recording Products  
Division, 3M Company,  
P.O. Box 33255,  
St. Paul, MN  
55133.



## Count on the clan.

January, 1977

CIRCLE 53 ON READER CARD

**3M**  
COMPANY

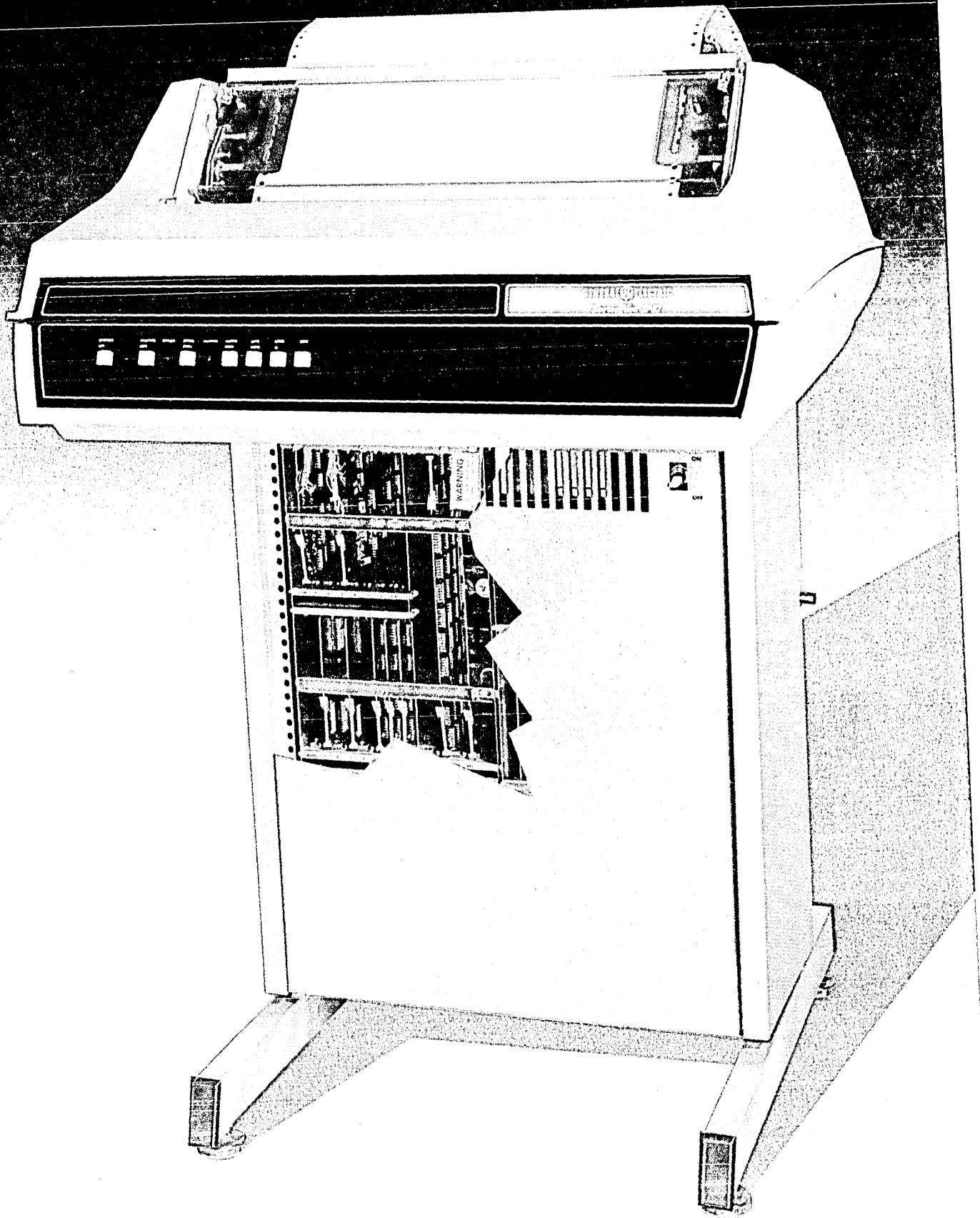

IBM 8000  
Data Processing System

WARNING



# With GE's TermiNet<sup>®</sup> 9600 Communication Controller you can emulate IBM 2780, 3780 and Univac DCT-1000 remote print stations

If you've been waiting for a fast, versatile and efficient remote print station at an affordable price, wait no more. By interfacing the TermiNet 9600 Communication Controller option with one of General Electric's line printers, you have in one small package, not only emulations for popular remote print stations, but added features like:

- A variety of printer speeds to match your network capacity up to 340 lines per minute
- Throughput that can be upgraded as your workload increases
- Improvements in throughput

and cost without changing central site software

And the best part is that you can have this kind of application flexibility. This kind of network efficiency. This kind of high performance in a price range you can justify.

## for under \$500 per month\*

Write General Electric Company, TermiNet 794-18, Waynesboro, Virginia 22980.

For your special kind of needs-A special kind of printer

GENERAL  ELECTRIC

\*Annual lease rate including maintenance — selling price under \$10,000.

---

---

# calendar

---

---

## FEBRUARY

**NIPS Commercial Users Group Meeting, Feb. 3-4**, Washington, D.C. The users of National Military Command Information Processing System will sponsor a forum for presentations of applications using NIPS, to include new developments, enhancements, and teleprocessing applications. The unique fact about this system is that it is a *free* general purpose data management system, developed in the late '50s by IBM under contract to the Dept. of Defense. The system, for use on any machine from 360/40 (using OS) on up, has on-line interactive capabilities attractive to government, industrial, and business. Contact: Carolyn Shamlin, 1860 Lincoln St., Suite 700, Denver, Colo. 80203 (303) 893-5200, ext. 320.

**Western Workshop and Exhibits, Int'l. Security Conference, Feb. 6-9**, Los Angeles. "Electronic Invasion: Computer Protection" is one of 40 subjects to be covered during this series of computer security seminars and workshops. New products to be exhibited include CCTV surveillance equipment, protective glazing and enclosures, access controls, and anti-theft devices. Admission to exhibits is free; individual general sessions are \$20. For information on other programs and charges contact the International Security Conference, 2639 S. La Cienega Blvd., Los Angeles, Calif. 90034 (213) 836-5000.

**5th Annual Midwest Digital Equipment Exhibit, Feb. 10-11**, Hopkins, Minn. This year's exposition features more than 50 displays by manufacturers of computer terminals, data communications equipment, peripherals, data acquisition and digital test instruments. In addition, a two hour seminar on microprocessors will be held each day. There is no fee for attendance. Contact: Clarence K. Peterson, (612) 331-6433.

**Minicomputers: The Applications Explosion, Feb. 14-16**, San Francisco. This conference, sponsored by the American Institute of Industrial Engineers, will present successful minicomputer application experience and "lessons learned" by users in overviews and case study workshops. Presentations will be followed by panel discussions involving user executives and conference attendees: Fee: \$295, teams \$195. Information on this and two other AIEE-sponsored events, "Distributed Data Processing," Feb. 1-4, New York, and "Life Cycle Management for ADP Systems," Feb. 7-9, Washington, D.C., can be obtained from Dept. DTM, AIEE Seminars, P.O. Box 3727, Santa Monica, Calif. 90403 (213) 450-0500.

**Winter Meeting, ADCIS, Feb. 22-24**, Newark, Del. The Assn. for the Development of Computer-Based Instructional Systems will provide a forum for presentation of papers and project reports in areas of general interest. All levels of the education area will be represented. Preregistration by Feb. 10 is requested. Fee: \$15, member; \$20, nonmember; an additional \$13 is required for the dinner/theater event. Contact: Joan Hayes, Computer Center, Western Washington State College, Bellingham, Wash. 98225 (206) 676-3360.

## MARCH

**NEPCON '77 WEST, March 1-3**, Anaheim, Calif. The National Electronic Packaging and Production Conference, in conjunction with the International Microelectronics Conference, will attract an audience of 30,000 engineers. More than 800 booths will have exhibits of printed and multilayer circuits and microelectronic devices, and the conference program provides open forums on a variety of topics. Fee: \$15, one day; \$25, two days; \$30, three days (includes admission to the exhibits); \$5, exhibits only. Contact ISCM, 222 W. Adams St., Chicago, Ill. 60606 (312) 263-4866.

**Computer Law Assn., March 9**, Washington, D.C. This meeting will focus on the new U.S. Copyright Act, which will go into effect Jan. 1, 1978. How this legislation affects proprietary rights in computer software and data bases will be considered. The meeting, open to the public, includes lunch; proceedings can also be obtained. For further information contact Ronald Winkler, Suite 800, 1666 K Street, N.W., Washington, D.C. 20006 (202) 872-7800.

**DataComm 77 Conference and Exposition, March 9-11**, Washington, D.C. More than 42 sessions—a mixture of tutorials and workshops—will focus on the theme "Be Where the Action Is." The program will deal with federal, state, and local governmental agencies in regard to data communications, as well as sessions on planning, implementing, and managing datacomm for business and industry. A special "Town Meeting" with officials from the Federal Communications Commission is planned for March 10. Fee: \$95; three or more persons from the same company, \$50. Single day registration is \$50 and \$25, respectively. Contact: DataComm 77, 60 Austin St., Newtonville, Mass. 02160 (800) 225-3232.

**4th Annual Computer Architecture Symposium, March 23-25**, College Park, Md. The IEEE Computer Society and the ACM cosponsor this meeting, which will feature presentation of papers on current technology and theory of computer architecture. Topics will include microcomputer systems architecture, hardware/firmware interactions, I/O architecture, high speed computers, multiprocessors, measurement and evaluation, and networks. Fee: \$50, member; \$60, nonmember; add \$10 for registration at the door; \$25, students. Contact: Dr. Bruce Wald, Communications Science Div., Naval Research Lab., 4555 Overlook Ave., Washington, D.C. 20390 (202) 767-2903.

## CALL FOR PAPERS

**International Conference on Parallel Processing, Aug. 23-26**, Bellaire, Mich. Authors are invited to submit papers describing recent advances on all aspects of parallel/distributed processing. These may include logic circuits, architectures, interconnections, networks, modeling and simulation techniques, and other aspects of the topic. Deadline for papers is March 15. Four copies of a 100-word abstract and a 1,000 word summary should be sent to Prof. J. L. Baer, Dept. of Computer Science, Univ. of Washington, Seattle, Wash. 98195 (206) 543-9344.

**3rd International Conference on Very Large Data Bases, Oct. 6-8**, Tokyo. April 15 is the deadline for submission of papers relevant to data base design, data base system architecture, data base system analysis and evaluation, and large scale data base applications. Five copies of each full paper should be sent to Prof. Alan Merten, School of Business Administration, Univ. of Michigan, Ann Arbor, Mich. 48109.



## Now small users can have the big benefits of in-house computer output microfilm.

### AutoCOM

You probably thought it took a huge volume to justify your own in-house computer output microfilm system. Well, it did. Until Datagraphix introduced AutoCOM, the fully automated computer information management system designed expressly for the volume—and budgets—of smaller users.

Set up and ready to go in one day, AutoCOM hardware can be used by just about anyone. And it's compatible with data tapes from virtually any computer.

The self-contained recorder and film processor converts tapes into cut, dry microfiche at the touch of a button. The companion AutoFICHE Duplicator copies the masters at the rate of up

to 450 per hour. And you get the superb reproduction and reliability that's made Datagraphix the leading name in COM for three decades.

So if you're going outside for microfiche, compare the big benefits of an in-house AutoCOM system. It's quick, confidential and convenient. And if you're not yet using COM, the outstanding price/performance ratio of AutoCOM means it can pay for itself in what you'll save on paper, time and storage.

Use the coupon to get all the details. You don't have to be a big user to get the big benefits of your own in-house AutoCOM.

Stromberg Datagraphix, Inc.;  
P.O. Box 82449: Dept.-D  
San Diego, CA 92138;  
Phone (714) 291-9960

*Please send me details on in-house  
COM with AutoCOM*

Name \_\_\_\_\_

Company \_\_\_\_\_

Address \_\_\_\_\_

City \_\_\_\_\_ State \_\_\_\_\_

Zip \_\_\_\_\_ Phone \_\_\_\_\_

# Datagraphix®

A General Dynamics Subsidiary

# source data

SOURCE DATA provides information on books, courses, references, reports, periodicals, and vendor publications.

books

## What To Know Before You Sign Data Processing Contracts: Structure, Contents, and Negotiation

by Dick H. Brandon and Sidney Segelstein  
Van Nostrand Reinhold Co.,  
New York, N.Y., 1976  
465 pp. \$34.50

Company executives frequently spend less time and effort negotiating the acquisition of a major computer system than they do bargaining for the purchase of the family car. The disparity is due to a variety of factors, but in far too many instances the user's inadequate negotiating effort results from a serious lack of knowledge—the executives involved do not even know where to begin or, worse, they are not aware that meaningful negotiations and substantive concessions are even possible. Surprisingly, their lawyers are often

Inadequate knowledge no longer need be a valid reason for poor performance in computer negotiations.

equally unable to cope with the specialized aspects of computer agreements, even though they are quite capable of providing sound counsel in other areas.

Thanks to Dick Brandon and Sidney Segelstein, inadequate knowledge no longer need be a valid reason for poor performance in computer negotiations. They have authored an excellent book that should be required reading for anyone involved in negotiating the acquisition or disposition of computer hardware, software, or services.

As the authors admit, the book is designed as a two-part "cookbook." Although the first part of the text is devoted to an explanation of various legal and philosophical aspects of computer contracts, the book's major value is a lengthy compendium of sample contractual provisions and clauses that

might be used in preparing an addendum to a vendor's standard form computer contract.

Unlike other books in this growing field, the Brandon-Segelstein volume should be useful to a wide variety of individuals involved in the computer acquisition process. The introductory material offers a good legal background for executives with sound data processing or financial experience but little or no legal training. The sample provisions also provide these executives with a wealth of substantive ammunition for use in preparing a "wish list" of negotiating goals. At the same time, the preliminary text offers the user's attorney general information about the special features of various types of computer contracts. The book's 255 sample clauses then provide the lawyer with specific ideas on what issues to cover and how to prepare the desired contractual provisions.

Each sample clause is accompanied by supplemental information that generally explains the intent, scope, and purpose of the provision, the types of contracts in which the clause is usually found, and, where applicable, the standard clause offered by the computer vendor. Comments, fall-back alternatives, and possible remedies are provided for some provisions and cross-references are included for a variety of related clauses.

Perhaps the most unusual information included for each clause is the author's "risk rating": a four-point scale that indicates the relative importance of each provision from "key" to "limited or no quantifiable benefit." Although some clauses deemed to be generally unimportant by the authors may be critical in a particular acquisition, the risk rating offers a useful method of quickly assessing the provisions likely to be most valuable in a given setting. (The value of the clauses alone becomes apparent when the reader realizes that the authors have listed 15 provisions as "key" and another 84 as "important.")

Valuable as it may be, the book has its limitations. As Brandon and Segelstein admit, the volume is primarily a reference book designed to be used with caution and with the advice and assistance of legal counsel. As many new attorneys have learned from experience, sample legal forms can be as dangerous as they can be helpful. The authors' provisions are no exception. The clauses are *not* optimized, nor are they designed to meet *any* user's spe-

cific needs. They must be tailored to a particular transaction by someone who understands the legal and business risks involved. Moreover, the comprehensive collection of provisions is weak in the areas of financing alternatives, third party leasing, and broker/dealer transactions.

At least one of the authors' basic premises is also open to question or, at least, explanation. Brandon and Segelstein assert that a good computer contract should be negotiated with the idea that it will never be seen again. This position is sound to the extent that it points up that thorough negotiations cause a full airing of all relevant issues, thereby eliminating surprises and matters "not covered in the contract." Under this view, once a complete agreement is reached, the only thing left is for the parties to perform their respective obligations under the contract. Since the contract is a highly complex document, the true success of the installation will be largely governed by the good will and technical cooperation of the parties involved. As Brandon and Segelstein explain, if the contract must be referenced to enforce the relationship between the vendor and user, it may be too late to have a successful installation.

The problems with this line of reasoning are two-fold.

In the first place, a good data processing contract should be an ongoing working document. Effective contract

... a good data processing contract should be an ongoing working document.

administration begins during contract negotiations when contract compliance "windows" are built in, status meetings are predetermined, and problem response times are established. Even when both parties are truly dealing in good faith, compliance with contractual requirements should be monitored throughout the life of the system. Irrespective of good faith, detailed contractual provisions can be misinterpreted or even forgotten over time. Leaving the contract in a desk drawer is simply asking for trouble.

The second major danger in the authors' point about not referencing the contract is that it may cause users to accept a one-sided or incomplete agreement. One of the more popular ploys in computer marketing is the old "we don't have to put that in the contract, you can trust me" ploy. Even if the salesman's story is true at the time the contract is being negotiated, it may not be correct at some time in the future. Computer companies, like people, do not always deal in good faith. If a point is worth negotiating, it is worth

being made part of the written agreement. Simply put, if the vendor's "concession" is not part of the formal contract, it is probably not part of the deal.

Notwithstanding its minor shortcomings, *Data Processing Contracts* is the best single text available for everyone involved in negotiating the acquisition or disposition of computer equipment and related items. Admittedly, the book does not tell the reader how to negotiate or how to alter the sample clauses to fit particular needs. Moreover, in an actual transaction the volume must be heavily supplemented with legal, financial, and negotiating expertise. But the book was not designed to be the final word on computer negotiations. Indeed, in some ways the book might be considered only the beginning—a comprehensive reference work prepared to enable a competent user to achieve the key goal of maximum contractual protection at minimum cost. In any event, no company should acquire a computer, or allow its attorneys to negotiate a computer contract, without a copy of this book.

—Joseph Auer  
—Charles Edison Harris

Mr. Auer is president of International Computer Negotiations, Inc., Winter Park, Florida. He has authored numerous articles on various aspects of computer negotiations.

Mr. Harris currently serves as Vice President, legal affairs and Secretary of Sun Banks of Florida, Inc., a registered bank holding company headquartered in Orlando. His prior experience includes a private law practice and service as an Assistant Professor of Law at the Univ. of Florida's Holland Law Center.

### Proceedings, Interagency ADP Planning Conference

National Technical Information Service, U.S. Dept. of Commerce, 5285 Port Royal Rd., Springfield, Va. 22161 (ask for PB 252-943).  
259 pp. \$9 (paperback)  
\$3 (microfiche)

The Interagency Automated Data Processing Planning Conference, held Feb. 22-24, 1976, in Warrenton, Va. (and known in Federalese as IAC/ADP) brings together top drawer computing managers in the federal establishment. If anything, it is a pleasant surprise to find that the representatives of the civilian agencies dominate the program and the attendee list.

To those not in the government, some peculiar remarks pop out. The representative from the General Accounting Office notes glumly that the trend to in-house services in big corporations suggests that the use of outside vendors should be limited. A few hours

later the representative from the Federal Procurement Policy Office suggests that things should be done outside except when the national interest is involved.

The speaker from the Office of Management and Budget mistakenly compares federal spending on dp to corporate spending; somehow one has the feeling that taking percentages of the federal budget is not the same as taking percentages of corporate annual sales. We are flattered to see that he used DATAMATION's statistics, but suggest that a better base for governmental dp spending is dollars/1,000 of population served.

There is a heavy concentration on the apparently disturbing problem of millions of unused cpu hours. Nobody appeared to understand that throughput is more important, that sometimes one must give up a bit of efficiency for effectiveness in doing the user's job. If they are all as worried as they seem to be about processing time, we wonder if the government will ever install a small business system which they can turn off at quitting time and forget until the next morning.

Six parallel issue sessions were held and since these attendees are generally the top dp policymakers in their agencies, the groupings of thought are interesting to consider. On the matter of

# Our line.

# source data

Centralization, they strongly endorsed centralized procurement beginning at \$1 million and up, and made a powerful case for shortening General Services Administration's procurement cycle. With *Legislative* relationships, the group saw no need for additional dp legislation but rather felt that a clarification of GSA's role under the Brooks Bill is needed.

The *MIS* group endorsed the idea of a compendium of information systems to further identify sources of experience within the government. The *Personnel Management* group seemed to feel that a formalized certification program might be useful.

The *Public/Private Sector* group seemed to worry about all the items that bother any dp manager, writing specifications for systems, avoiding vendor lock-ins, and accurately costing in-house operations. The *Sharing* group was mostly concerned with finding ways to promote package sharing, and, so far as can be seen, to beat the software houses out of multi-user fees.

For those outside the government, these proceedings (published by Automated Data and Telecommunications Service, General Services Administration) are interesting proof that things

really are different in Washington. For those inside government, they represent a valuable record of what top dp management is considering for the future.

—Philip H. Dorn  
Mr. Dorn, a Datamation contributing editor, is an industry consultant.

## BOOK BRIEFS . . .

**Minicomputers and Microprocessors: A Tutorial**  
IEEE Computer Society, 5855 Naples Plaza, Suite 301, Long Beach, Calif. 90803 (1976)  
281 pp. \$12 (\$9, members) paperback

This compendium of technical papers comprehensively addresses the changing mini and micro computer fields, describing improvements in equipment and technology as well as the changing techniques for system design and implementation. Contributors include designers and developers from major companies who discuss microprogramming, minicomputer architectures, microprocessors, mini and micro computer systems development, and interfacing and peripherals.

**Let's Talk LISP**  
by Laurent Siklössy  
Prentice-Hall, 1976  
237 pp. \$11.95

LISP is a List Processing programming language employed on a variety of computers for use in research requiring

nonnumeric computation; the first system was implemented at Massachusetts Inst. of Technology in the early sixties. This readable, often amusing, text presents a complete and careful introduction to the language in the first seven chapters (a condensation is included for the experienced programmer), and in the later portions, emphasizes more advanced features of LISP.

**Computing Careers for Deaf People**  
Steven L. Jamison, ed.  
Assn. for Computing Machinery, 1976  
(Order prepaid from ACM Order Dept., P.O. Box 12105, Church St. Station, New York, N.Y. 10249.)  
123 pp. \$9 (\$6.75 for ACM or SIGCAPH members), paperback

These are the proceedings of a conference held in Washington, D.C. in April 1975 to explore the challenges and opportunities for deaf people in the field of computing, sponsored by the ACM special interest group on computers and the physically handicapped. Papers cover educational opportunities, special programs, on-the-job problems and solutions, and employment success factors.

**Data Base Management Systems**  
by Leo J. Cohen  
Q.E.D. Information Sciences, Inc.  
141 Linden St., Wellesley, Mass. 02181 (1976)  
\$43, prepaid; \$49, billed later, paperback.

Analyzing and describing five data base systems, IMS/VS, TOTAL, ADABAS,

### CFI 1316 Series Disk Packs

The beginning of the line. Proven and field-tested. Designed for use with IBM 2311, Singer System 10 and CDC equipment, among others. CIRCLE 93 ON READER CARD

### CFI 3336 Series Disk Packs

Largest product in the line, in both size and storage capacity. First disk pack to use servo track control. Available in two versions: Model 1—100 megabytes; Model 11—200 megabytes. Configurations available for CDC, Honeywell, NCR, DEC and Data General, among others. CIRCLE 94 ON READER CARD

### CFI 2316 Series Disk Packs

The most versatile product in the line. Available in many different sector configurations, data densities and track densities. Compatible with all major disk drives, including the Univac 8440. CIRCLE 95 ON READER CARD





System 2000 and IDMS by definition and illustration, this 8½ x 11 inch book provides an overview of different approaches that result in different data base systems products. Choosing a package is a complex task, and the goals and objectives of the application must be clear. To assist in this, the book includes a guide to selection and operation of a team to choose the package, and a glossary of terms to clarify the jargon of the various systems.

**Proceedings, 13th Annual Design Automation Conference**  
 IEEE Computer Society, 5855 Naples Plaza, Suite 301, Long Beach, Calif. 90803 (1976)  
 501 pp. (paperback) \$15, members; \$20, nonmembers

The ACM and IEEE were joint sponsors of this conference held June 28-30



#### All About Software

With the thousands of software packages on the market, ranging in cost from less than \$50 to more than \$100,000, a prospective buyer has an

obligation to do some comparison shopping before purchasing. In the December 1976 issue, DATAMATION published the results of the second annual joint survey, with Datapro Research Corp., of software package users who rated 250 software packages in seven categories: overall satisfaction, throughput/efficiency, ease of installation, ease of use, documentation, vendor technical support, and training (if applicable). Reprints of this valuable 18-page survey, complete with honor roll listings and vendor index, are now

**Computer Applications in Management**  
 John R. Birkle and Ronald Yearsley, eds.  
 Halsted Press, 1976  
 191 pp. \$13.95

Since computers themselves don't manage companies or departments, but are capable of organizing and producing vast amounts of information, it seems basic that managers understand how to use the computer most effectively. This book features contributions

available. DATAMATION, Los Angeles, Calif.  
 FOR COPY CIRCLE 201 ON READER CARD

from practicing managers who use data processing as a tool, and should be helpful to any manager in the control and application of the company's resources.

**JCL and Advanced FORTRAN Programming**  
 by H. A. Ramden  
 American Elsevier Publ. Co., Inc.,  
 52 Vanderbilt Ave., New York, N.Y.  
 10017 (1976)  
 169 pp. \$18.95 (paperback)

This text is filled with examples of problems faced by students, scientists, researchers, and the "non-professional" user, who are using the computer as a tool. Special attention is given to input/output; additionally, JCL for IBM 360/370, FORTRAN subroutine calls and FORTRAN error tracing and handling, and the use of Cal Comp compatible plotter routines are discussed.

available. DATAMATION, Los Angeles, Calif.

FOR COPY CIRCLE 201 ON READER CARD

**MCS-40 Manual Updated**  
 The third edition of the MCS-40 *Microcomputer System User's* manual has recently been published. The 305-page manual offers a comprehensive description of the MCS-40 system, which consists of the 4040 cpu and associated components, the new 4269 programmable keyboard display device and the 4265 programmable general purpose

#### CFI Trident Disk Packs/Storage Module

The newest products in the line. Uses 3336-TI particle-oriented disk. Available for use with all Trident-type drives having storage capacities of 25, 50 and 80 megabytes. Also available in storage module configurations for CDC and Hewlett/Packard type drives. CIRCLE 96 ON READER CARD



#### CFI 5440 and 2315 Series' Disk Cartridges

The most popular products in the line. CFI Memories is the world's largest supplier of disk cartridges. We make them in every version, compatible with every computer and peripheral manufacturer. They're available in 100 TPI, 200 TPI and 400 TPI densities. CIRCLE 97 ON READER CARD

## source data

i/o device. The manual contains a data sheet section and an applications chapter with notes on using the 4269, 4265 and 5101 256 x 4-bit CMOS static RAM. Price: Price: \$5. INTEL CORP., Literature Dept., 3065 Bowers Ave., Santa Clara, Calif. 95051.

### Sourcebook for Data Bases

A 1973 survey on computer-readable bibliographic data bases was so well received that the American Society for Information Science has initiated an update service with this report, *Computer-Readable Bibliographic Data Bases—A Directory and Data Sourcebook*. This hefty, imposing directory is packaged in an 8½ x 11 inch bright red three-ring binder. The volume contains 814 pages of information and data on 301 bibliographic and related data bases produced in the U.S. and Europe. Five appendices are included—a subject category index, name/acronym/synonym index, producer index, processor index, and a data element list.

The well-organized directory is arranged for easy reference. One-year subscription prices are \$54.40, ASIS members; \$61.20, ASIS affiliates, and \$68, nonmembers. Updated (replaced)

ment) pages and additional pages will be sent at six-month intervals. Prepaid orders go to AMERICAN SOCIETY FOR INFORMATION SCIENCE, P.O. Box 19448, Washington, D.C. 20036.

### Datamation Subject Index

The 1976 DATAMATION subject index for Vol. 22, Nos. 1-12 is now available without charge to our readers. The index contains references to feature articles, news stories, conference reports, Editor's Readout, the Forum, Look Ahead, People, and book reviews. DATAMATION, Los Angeles, Calif.

FOR COPY CIRCLE 215 ON READER CARD

### DPMA Publications

Data Processing Management Assn. is offering two publications to systems professionals, one a guide to computer selection and the second the proceedings on an industry workshop. *A Guide to Successful Computer System Selection* is a 36-page paperback featuring five sections: Organization of Computer Acquisition, Systems Evaluation, Financial Considerations, Legal Considerations, and Single Versus Multivendor Systems. It is volume no. 4 in the DPMA management reference series; prices are \$5.95 for DPMA members, \$6.95, nonmembers.

The DPMA Education Foundation held a workshop on information systems education last April in Chicago

which was attended by senior managers of information system activities in industry and government, and by university representatives. The 68-page proceedings include a statement on current technology, opportunities for industry/academic interaction, and the panel discussion "What Industry Needs," including comments from the attendees. Copies are \$7.50, DPMA members, and \$8.50, nonmembers. Order from DPMA International, 505 Busse Hwy., Park Ridge, Ill. 60068.

## Vendor literature

### Computer Services Directory

A 42-page directory of data banks, commercial service bureaus, and colleges and universities that provide dial-up access to their computer facilities over the Telenet network is offered by this vendor. More than 40 organizations devoted to interactive computing and information retrieval services are cross-referenced by application specialties, programming languages and data base offerings. The directory provides information on how to use the listings, and the alphabetical list of subscribers

### CFI Data Module

The most technically advanced product in the line. First to incorporate heads and carriage into the module. Available in three models. Model 35—35 million bytes, Model 70—70 million bytes, Model 70F—70 million bytes with fixed heads for rapid paging. CIRCLE 98 ON READER CARD

### CFI Abraxas Diskettes

The first of our flexible-media line. We offer them both one-sided and two-sided and with various hard sector configurations. The entire recording surface of every diskette is certified 100% error-free. Compatible with IBM 3740 and other diskette drives. CIRCLE 99 ON READER CARD

### CFI Abraxas V Digital Cassettes

A complete line of cassettes in various grades. Designed for use with most digital recording and word processing equipment. CIRCLE 100 ON READER CARD

### CFI Abraxas Computer Tape

A top-of-the-line tape line. Available in most lengths and configurations and various reel sizes. Tested for use at 1600 BPI and 6250 BPI. CIRCLE 101 ON READER CARD



## source data

includes a description of the organization's services and facilities, computers utilized, and areas of specialization. TELENET COMMUNICATIONS CORP., Washington, D.C.

FOR COPY CIRCLE 202 ON READER CARD

### Communications Catalog

Data communications products are described in this 8-page illustrated catalog. In addition to information on the Supermux Intelligent Time Division Multiplexer, the catalog describes conventional multiplexers for mixed synchronous and asynchronous communications on both DDS (digital data service) and analog facilities. This vendor's equipment may be configured for point-to-point, multi-drop, drop and insert and many other network requirements, and facilities may be a mix of voice grade, wideband and DDS. INFOTRON SYSTEMS CORP., Pennsauken, N.J.

FOR COPY CIRCLE 203 ON READER CARD

### Third Party Maintenance

An illustrated color brochure describes the third party maintenance services available from Western Union Telegraph Co. The company's field maintenance organization currently

covers 50,000 teletypewriter and cathode ray tube terminals for end users, terminal manufacturers, and oem/systems companies. Sample problems and their possible solutions are described, and a directory to service and training centers in the contiguous 48 states is included. WESTERN UNION TELEGRAPH CO., Upper Saddle River, N.J.

FOR COPY CIRCLE 204 ON READER CARD

### Financial Aid

A 4-page brochure describes an on-line budget management system for financial planning and control, FIPABS, designed for use on INFONET, this vendor's remote computing service. The system has three modules, which can be used together or separately: planning and data preparation, consolidation of data, and performance reporting and analysis. FIPABS is based on FLARES, an English-like financial language. The features seem useful for medium to large sized corporations, including multinational companies dealing in several currencies. COMPUTER SCIENCES CORP., Los Angeles, Calif.

FOR COPY CIRCLE 205 ON READER CARD

### MUMPS Is Spreading

A handy pocket guide for the users of the MUMPS medical and business applications language has been published

by the users' group, which notes that the number of institutions using the language is growing at the rate of 80% per year. The guide includes descriptions of all the commands, operators, functions, and other capabilities of standard MUMPS, along with examples of their use. The standard was developed from a dozen MUMPS dialects, under sponsorship of the National Bureau of Standards and the U.S. Dept. of Health, Education, and Welfare. MUMPS USERS' GROUP, St. Louis, Mo.

FOR COPY CIRCLE 207 ON READER CARD

### Communications System

Users of distributed data processing networks frequently require simultaneous batch communications and data entry capability, where entry volume is relatively small and the output volume ranges from small to large. This 6-page brochure describes the Model 77 communications system that offers a variety of configurations to suit many data entry, processing, and communications needs. The system uses IBM's 3780 binary synchronous protocol, with SDLC available early this year. DATA 100 CORP., Minnetonka, Minn.

FOR COPY CIRCLE 208 ON READER CARD

### Minicomputer Products

Accessories, supplies, and connectors for users of DEC, DGC, HP and other

### CFI Abraxas III Disk Cartridge Cleaner-Verifier

To help maintain our line. Completely portable and self-contained unit cleans and mechanically tests both front and top loading cartridges. Prevents costly head crashes and reduces or eliminates soft errors caused by damaged or dirty disk cartridges.

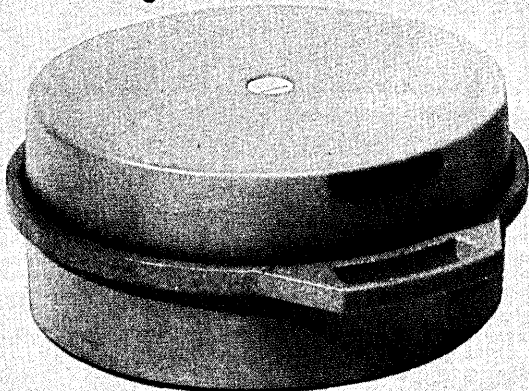

CIRCLE 102 ON READER CARD

### CFI Abraxas IV Magnetic Tape Cleaner

Keeps our tape line clean. Safe and effective. Removes contamination which can seriously affect the operational capabilities of magnetic tape. CIRCLE 103 ON READER CARD



## source data

minicomputer systems are described in this product catalog. Suitable for 8½ x 11 inch three ring binders, the pre-punched 24-page catalog offers data storage folders and files, racks, cabinets, cassettes, disc cartridges, tapes, junction panels, and a variety of other products for minicomputer users. **MINI-COMPUTER ACCESSORIES**, Palo Alto, Calif.

FOR COPY CIRCLE 206 ON READER CARD

### CMOS-Backed Memory

The value of handheld programmable calculators seems to increase with new problems and new applications. *Getting the Most from Continuous Memory* is a 4 x 6 inch booklet that describes effective use of continuous memory, sample applications, and a short discussion of CMOS (complementary metal oxide semiconductor) technology that is the backbone of this memory. And interestingly enough, sometimes as many as 20% of the programs solve 80% of the common problems. This vendor's 8-page booklet is designed for the HP-25C calculator. **HEWLETT-PACKARD CO.**, Palo Alto, Calif.

FOR COPY CIRCLE 209 ON READER CARD

### HP 1000 Computer Series

The HP 1000 Computer Systems are designed for computation, instrumentation and operations management applications in a multiprogramming environment. Planned for oem systems houses and for manufacturers with computer-applications experience, the systems can also be linked in a network of other HP computer systems, and are able to communicate with IBM 360 and 370 batch-oriented computers. The HP 1000 family can be tailor-made for initial needs, with the capability of expansion in building block stages for future growth. The series is described in a 12-page color brochure, *HP 1000 Computer Systems* with photos, figures, and detailed text highlighting the features and configurations available. **HEWLETT-PACKARD CO.**, Palo Alto, Calif.

FOR COPY CIRCLE 210 ON READER CARD

### Printer/Plotter Supplies

An illustrated 20-page booklet, *Electrographic Supplies*, helps users of electrostatic printers or plotters to specify, order, store, and safely handle electrographic supplies. The 5 x 8 inch booklet answers questions about papers and toners, suggests the type and quantity of supplies to order, and gives detailed specifications on supplies designed to

enhance performance and reliability of the equipment. Drawings, tables and graphs illustrate specifications, relationship of usage levels to order size, and recommended procedures. Tables are also included for standard, wide and super-wide plotters. **VERSATEC**, Santa Clara, Calif.

FOR COPY CIRCLE 211 ON READER CARD

### Microfilm Cameras

An illustrated flyer describes two microfilm cartridge cameras that can handle standard size sheets (up to 12" wide) as well as larger documents such as computer printouts or accounting ledger sheets (up to 15¾" wide). The 3M 3400 and 3401 cameras feature cartridge loading and automatic threading. The rotary cameras place the new industry standard blip mark under each image which allows easy retrieval of any image. Other features note that the 16mm format holds 100 feet of microfilm, and that one film cartridge can hold 3,000 letter size documents. **3M COMPANY**, St. Paul, Minn.

FOR COPY CIRCLE 212 ON READER CARD

### Noise Abatement

The fight against noise pollution continues with the recent introduction of a quiet numeric printer, the Gulston NP-7. A 4-page illustrated catalog gives

### We take your business personally

We have made a major commitment to R&D and to the continuous refinement of the manufacturing process. We will continue to develop technologically advanced products for both the end-user and OEM.

We have also made a major commitment to a nationwide network of independent representatives. The men who sell and service our line have proven themselves to be the best in their field. That's why they represent CFI. They work hard to earn your business by giving you the kind of personal attention and professional service you just can't get any place else.

A nearby CFI representative is waiting to show you how you can get all the care and quality we put into our products and all the personal attention you could ever want at prices your accountant will appreciate. And that's really the bottom line.

Call us toll-free for the name of your local representative, 800/854-3290. Or write: CFI Memories, Inc., 305 Crescent Way, Anaheim, CA 92801.

## CFI memories, inc.



complete specifications and details of the NP-7, which has no print wheels, ratchets, or solenoids. The only moving part in this printer is a permanent magnet motor which advances the paper roll. The numeric printer provides seven columns of numbers, or six columns with a plus/minus sign, and is complete with electronics for interfacing to all popular digital panel meters. GULTON INDUSTRIES INC., East Greenwich, Rhode Island.

FOR COPY CIRCLE 213 ON READER CARD

## courses

### Systems Analysis

*Systems Analysis Workshop*, a 5-day course presented by Brandon Systems Institute is scheduled for six cities in the next six months. The workshop is designed as a "front-end" to the systems development activities of organizations designing data base, on-line, and distributed processing systems. Dates and places are Washington, D.C. (Jan. 24-28), New York (Feb. 14-18), Atlanta (March 7-11), Chicago (April 18-22), Philadelphia (May 16-20), and Kansas City (June 13-17). Price \$650. BRANDON SYSTEMS INSTI-

TUTE, 4720 Montgomery Lane, Bethesda, Md. 20014.

### Crime Prevention

A 3-day seminar on *EDP Auditing: Concepts and Techniques* will focus on security measures to thwart computer-related fraud and embezzlement. The course will explain the role of the dp auditor in planning new systems projects, discuss how to perform a dp audit, and how to select the proper audit retrieval system. Workshops will provide an opportunity for "hands-on" experience. The course is scheduled for Dallas (Feb. 16-18), Toronto (March 16-18), and Chicago (April 13-15). Price: \$540 (\$470 AMA member); team fees available. AMERICAN MANAGEMENT ASSNS., 135 W. 50th St., New York, N.Y. 10020.

### Take Home a Micro

A 3-day course, *Hands-on Microprocessor Short Course with Take Home Microcomputer*, is scheduled for nine cities during February and March. A Wince Micro module, including a 6800 microprocessor chip, clock, ROM, RAM, serial and parallel I/O, is given to each attendee. The course covers microprocessor hardware, software, firmware, and economics. Locations include Boston, Chicago, Dayton, Huntsville, Los Angeles, St. Petersburg

Beach, Palo Alto, Philadelphia, and Washington, D.C. Price: \$495. WINTEK CORP., 902 N. 9th St., Lafayette, Ind. 47904.

## periodicals

### Roundup in Big D

While this may not qualify as a forever-going publication, the NCC Roundup will be issued from now through June with all the information that's needed for the 1977 National Computer Conference. Sponsored by the American Federation of Information Processing Societies (AFIPS), the conference will be held June 13-16 in Dallas. In order to answer the million and one questions from prospective exhibitors, attendees, panelists, the press, etc., AFIPS decided to issue this complimentary bi-monthly newsletter to anyone who asks for it. Subscribers will receive the first issue, September/October 1976, as well as November/December 1976, January/February, and April/May. For your copies contact AFIPS, 210 Summit Ave., Montvale, N.J. 07645, call (201) 391-9810, or circle the reader service number below.

FOR COPY CIRCLE 214 ON READER CARD

\*

# Your line.

## 800/854-3290

### (In California 714/776-8571)

CFImemories, inc.

# INTRODUCING RAMIS II

## How to choose a comprehensive Data Base System

RAMIS II is more than an enhancement of a proven software product. It's the next generation.

RAMIS II offers for the first time the complete integration of two important new software technologies—non-procedural languages and data base management.

Data base management means that both application programs and data files are independent of changes to the environment. It provides better control and utilization of the data and easier access to it.

Non-procedural languages allow you to tell the computer directly what to do, rather than how to do it. And you tell the computer what you want—in *English*—using normal business vocabulary rather than specialized computer jargon.

Because RAMIS II is the only system that combines the simplicity of non-procedural languages with the full range of data base management capabilities, EDP staff and management alike no longer waste time attempting to keep pace with environmental changes.

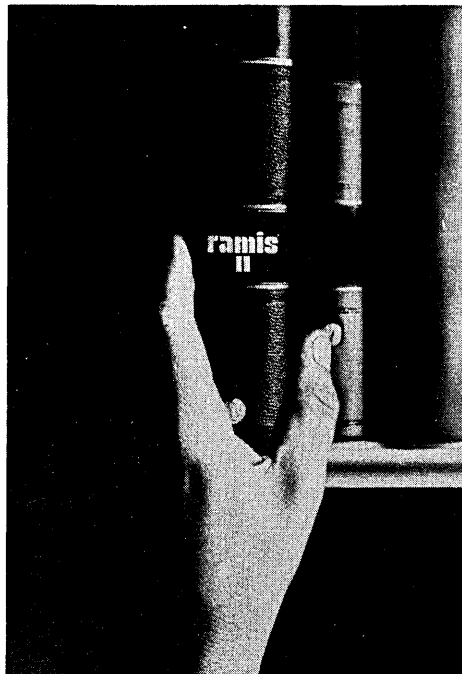

RAMIS II is now creating new systems in a fraction of the time required by traditional programming methods. And RAMIS II users, freed from routine maintenance tasks, can now direct their talents to crucial problems they never had time to address before.

RAMIS II is alone in its class. No other system approaches its capabilities. To find out why, send the coupon, or call Mark Berkowitz, Vice President, U.S. Operations at (609) 799-2600.

**ramis**

Mathematica Products Group  
P.O. Box 2392, Princeton, N.J. 08540

Please send me information on RAMIS II.

Name \_\_\_\_\_

Title \_\_\_\_\_

Company \_\_\_\_\_

Address \_\_\_\_\_

City \_\_\_\_\_ State \_\_\_\_\_ Zip \_\_\_\_\_

Phone \_\_\_\_\_

DM 1/77



THE JAMES MARTIN WORLD SEMINAR



## THE DESIGN, MANAGEMENT AND FUTURE OF DISTRIBUTED PROCESSING, DATA BASE, TELEPROCESSING, and NETWORK SYSTEMS

7-11 March	SAN FRANCISCO	Hotel Mark Hopkins
14-18 March	HOUSTON	Houston Oaks Hotel
25-29 April	AMSTERDAM	Hotel Okura
9-13 May	TORONTO	Hyatt Regency Hotel

These seminars are part of the 1977 James Martin World Tour Programme  
which will also include:

TOKYO	MELBOURNE	SINGAPORE	DELHI	TEHRAN
LONDON	RIO DE JANEIRO	BOSTON	CHICAGO	LOS ANGELES

For full details telephone:-

203 227 6778 - in the U.S.A.

0253-403016 - in Europe

403 429 5921 - in Canada

or complete the following coupon or write AIRMAIL to:-  
ABAQUEST, 221 St. Anne's Road, Blackpool, FY4 2BL, U.K.

Please send me full details of the James Martin Seminar in.....

Name..... Organisation.....

Address .....



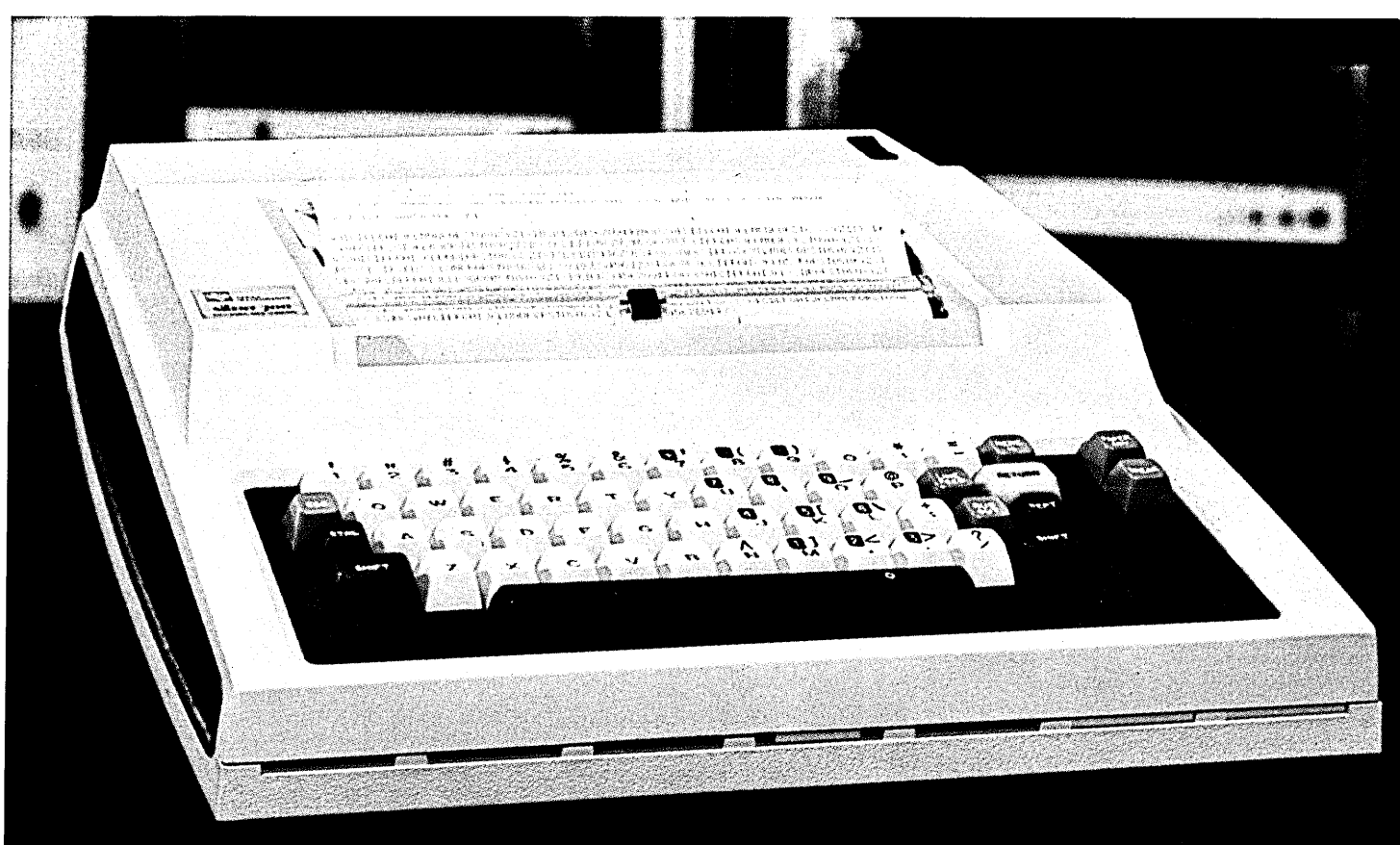

## 743 KSR terminal... \$1,395. Uncompromising *Silent 700* quality... at an unprecedented price.

The new *Silent 700*® Model 743 KSR data terminal is the lowest priced 30-cps printer terminal available today. And, true to its heritage, it combines all the popular *Silent 700* performance features... speed, reliability and quietness.

In fact, its speed and reliability are enhanced. Now there's true 30-cps throughput, because incoming data is buffered. Reliability is improved because its microprocessor logic means fewer circuit boards and components. This application of the latest design technology not only adds up to enhanced reliability but reduces size and weight as well.

As for quietness, the 743 KSR is virtually silent, as its name implies. Its non-impact electronic printing eliminates the disturbing noise associated with conventional impact printers.

At \$1395\* quantity one, the 743 KSR is another TI price/performance value leader... whatever your application: console I/O for software development, keyboard terminal for inquiry response, data entry, interactive remote computing, or a message network terminal.

OEM prices go below \$1000\* in large quantities; and attractive lease rates also are avail-

able. All *Silent 700* terminals are backed by TI's comprehensive worldwide maintenance and support services.

For more information on the 743 KSR and other *Silent 700* terminals, contact the nearest TI office listed below or contact Texas Instruments Incorporated, Digital Systems Division, P.O. Box 1444, Houston, Texas 77001. Or, phone Terminal Marketing at (713) 494-5115, extension 2126.



**TEXAS INSTRUMENTS**  
INCORPORATED

\*U.S. Domestic Prices

# TEXAS INSTRUMENTS.

Arlington, VA (703) 527-2800 • Atlanta, GA (404) 458-7791 • Boston, MA (617) 890-7400 • Charlotte, NC (704) 333-1519 • Chicago, IL (312) 671-0300 • Clark, NJ (201) 574-9800 • Cleveland, OH (216) 464-2990 • Costa Mesa, CA (714) 540-7311 • Dallas, TX (214) 238-5318 • Dayton, OH (513) 253-6128 • Denver, CO (303) 751-1780 • Detroit, MI (313) 353-0830 • El Segundo, CA (213) 973-2571 • Ft. Lauderdale, FL (305) 733-3300 • Hamden, CT (203) 281-0074 • Houston, TX (713) 494-5115 • Indianapolis, IN (317) 248-8555 • Milwaukee, WI (414) 475-1690 • Minneapolis, MN (612) 835-5711 • Mobile, AL (205) 471-1435 • New York, NY (212) 682-1690 • Orlando, FL (305) 644-3535 • Philadelphia, PA (215) 628-3434 • Phoenix, AZ (602) 249-1313 • Pittsburgh, PA (412) 771-8550 • Rochester, NY (716) 461-1800 • San Francisco, CA (415) 392-0229 • Seattle, WA (206) 455-1711 • St. Louis, MO (314) 569-0801 • Sunnyvale, CA (408) 732-1840 • Amstelveen, Holland 020/473 391 • Bedford, England 0234-67466 • Beirut, Lebanon 452010 • Brussels, Belgium 733.96.24 • Cheshire, England 061-442-8448 • Copenhagen, Denmark 01/91 74.00 • Essen, Germany 0201/20916 • Frankfurt, Germany 0611/39/90/61 • Freising, Germany 08161/801 • Helsinki, Finland 90-408 300 • Madrid, Spain 675 2162 • Milan, Italy 02.688.8051 • Montreal, Canada (514) 353-0830 • Munich, Germany 089/32.50.11 • Nice, France (93) 20.01.01 • Osaka, Japan 06-304-9300 • Oslo, Norway 02-68.94.87 • Paris, France (1) 630-2343 • Rome, Italy 839.4792 • Slough, England 0753-33411 • Stockholm, Sweden 08/235480 • Sydney, Australia 831-2555 • Tokyo, Japan (03) 402-6181 • Toronto, Canada (313) 353-0830

# We're hungrier than IBM.

You've seen this kind of competitive spirit before in American business.

Avis versus Hertz.

Volkswagen versus Detroit.

And now, Wang versus IBM.

Sure, IBM is big. But big doesn't mean better.

Wang won't sell you a small computer in excess of your needs. Wang actually designs a system to answer your problem.

Which is why our systems are ingeniously simple to operate.

In short, we'll do more for you than IBM. Make sure Wang is on the

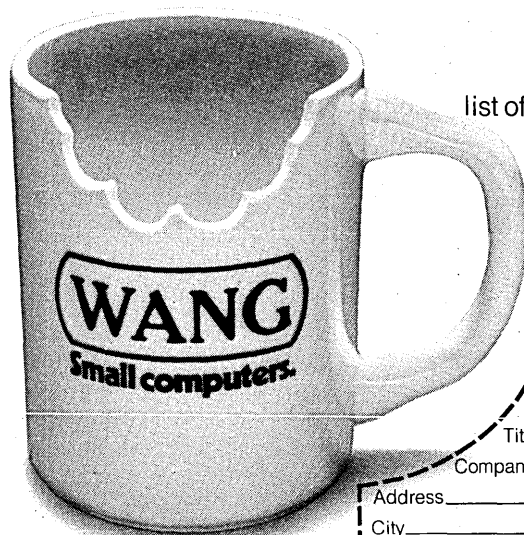

list of manufacturers you talk to for stand-alone or distributed processing. Write: Wang Laboratories Inc., One Industrial Ave., Lowell; Mass. 01851. Or call (617) 851-4111. We've yet to bite off more than we can chew.

I'd like to know just how much hungrier Wang can be.

Name \_\_\_\_\_

Title \_\_\_\_\_

Company \_\_\_\_\_

Address \_\_\_\_\_

City \_\_\_\_\_ State \_\_\_\_\_

Zip \_\_\_\_\_ Tel. \_\_\_\_\_ DP58/D17

But you don't have to pay for them till you're ready to use them. With Raytheon, you can grow from a plug-compatible 3270 replacement to a full distributed data processing system without changing hardware.

And, Raytheon's PTS-100 System costs about 40% less than the system it replaces.

Now, look at the extra capabilities you get without spending more money:

- Local format storage to cut communication costs to your central processor.
- Local print without intervention of central processor. That cuts communication costs further.
- Disc backup so if your central processor goes down your terminals can keep working.
- Mixed screen sizes. Mixed keyboards. 300 lpm printer. 300 cpm card reader. So you can do things you never thought possible.

Finally — and still without changing our original Raytheon hardware — you can upgrade to a full PTS-1200 Distributed Data Processing System. Now look at your capabilities:

- Multiprogramming/Multitasking Operating System.
- Batch communications while your terminals are simultaneously emulating 3270's.

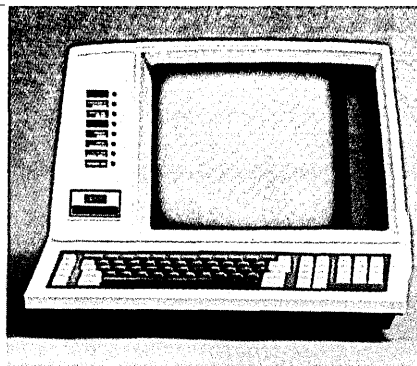

- High-level, terminal-oriented language.
- Powerful indexed data base support.

Add it up. You have an open-ended system. Raytheon reliability. Raytheon field service. Flexible financing — tailored to your needs. And, the ability to upgrade without changing hardware.

So if you're looking for a 3270 replacement you can grow with, call your local Raytheon Sales Office. Or, write Raytheon Data Systems, Dept. 101, 1415 Boston-Providence Turnpike, Norwood, MA 02062. Even better, talk to our Sales Support Manager.

Telephone 800-225-9874 toll-free (inside Mass., call 762-6700).  
Grow with us.

INTELLIGENT TERMINALS, MINICOMPUTERS AND TELECOMMUNICATIONS SYSTEMS

## RAYTHEON DATA SYSTEMS



Sales Offices:

ATLANTA  
(404) 321-3064  
CHICAGO  
(312) 674-4420  
DALLAS  
(214) 231-6391  
DENVER  
(303) 770-6241

DETROIT  
(313) 358-3990  
HARTFORD  
(203) 243-2939  
HOUSTON  
(713) 771-5851  
LOS ANGELES  
(213) 770-4240

MIAMI  
(305) 592-3884  
NEW YORK CITY  
(212) 661-2790  
PHILADELPHIA  
(609) 662-4326  
PITTSBURGH  
(412) 281-2117

SAN FRANCISCO  
(415) 692-4640  
SEATTLE  
(206) 453-0650  
TULSA  
(918) 663-7852  
WASHINGTON, D.C.  
(703) 979-6100

# WE'RE GOING TO GIVE YOU FEATURES YOU PROBABLY WON'T USE FOR ANOTHER FIVE YEARS.





**A lot of computers  
offer multi-level batch  
processing, or RJE,  
or realtime, or  
interactive timesharing.**

**But only Harris  
offers all of it,  
concurrently.**

Only Harris delivers multi-use concurrency. Our high performance S100 and S200 packaged systems, combined with our responsive VULCAN operating system delivers simultaneous compute services to each user. As well as simultaneous individual user access to the system.

The S220, shown here, is packaged around the most powerful CPU in the industry. Dozens of benchmarks, including Whetstone, prove the S100/S200 series superior performance. The S220 is one of 6 packaged systems available today, starting at \$85,000. All operate with COBOL, FORTRAN, BASIC, RPG II, FORGO, SNOBOL,

and extended BASIC. And all 6 in the series deliver multiple RJE, multi-level batch processing, multiple interactive timesharing, and real-time processing...all at the same time. If your need is distributed processing, time-sharing, data base management, or any kind of multi-use concurrency, benchmark the S100/S200 packaged systems.

Only Harris gives it all to you, concurrently. Write Harris Computer Systems, 1200 Gateway Drive, Fort Lauderdale, Florida 33309. Europe: Techmation N.V., Gebouw 105/106 Schiphol-Oost, Netherlands.

**HARRIS**

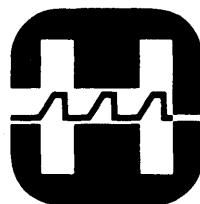

**COMMUNICATIONS AND  
INFORMATION HANDLING**

# Ask CONTROL DATA to supply Monolithic Memory for your IBM 370... get reliability you can bank on at half the price.

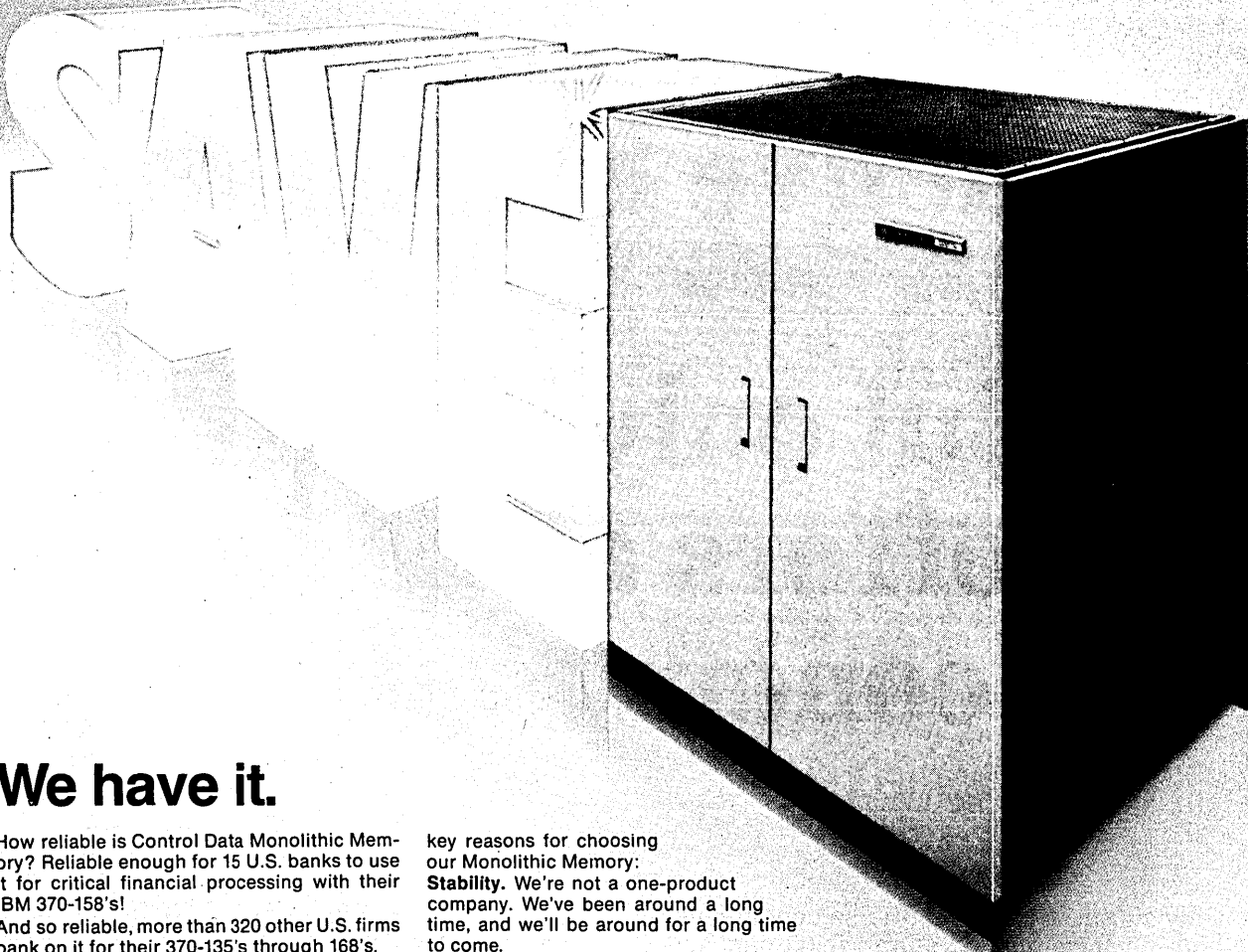

## We have it.

How reliable is Control Data Monolithic Memory? Reliable enough for 15 U.S. banks to use it for critical financial processing with their IBM 370-158's!

And so reliable, more than 320 other U.S. firms bank on it for their 370-135's through 168's.

We've installed more than 450 Monolithic Memories already to help IBM-370 users cut processing costs. And our users are our best proof that CDC Monolithic Memories work.

If you'd like to talk to some of these users, just ask our Peripherals Representative. He'll supply references! He'll also point out other

key reasons for choosing our Monolithic Memory:

**Stability.** We're not a one-product company. We've been around a long time, and we'll be around for a long time to come.

**Single-source responsibility.** We can provide plug-compatible, cost-effective CDC disk memory, mass storage, and other peripherals. You place total responsibility in a single vendor.

If you want 370 memory capacity at half the price or double the capacity at the same price

...if you want to save \$40K to more than \$500K ...ask us about CDC Monolithic Memory.

And ask us about the users who have proved it works. Call your local Control Data Marketing Office or mail the coupon today.

Mr. James Kuntuzos, Sales Manager, Peripheral Product Sales, Control Data Corporation,  
P.O. Box 1980, Twin Cities Airport, St. Paul, MN 55111, Dept. D-116.

Please have a Control Data Marketing Representative supply further information about your Monolithic Memory.

Name \_\_\_\_\_ Title \_\_\_\_\_

Company \_\_\_\_\_ Area Code \_\_\_\_\_ Phone \_\_\_\_\_

Address \_\_\_\_\_

City \_\_\_\_\_ State \_\_\_\_\_ Zip \_\_\_\_\_

Ask Our Peripherals People



# Editor's Readout

John L. Kirkley, Editor

## Our 1977 Wish List

Well, so much for 1976.

For the minicomputer manufacturers, for IBM, NCR, CDC, Burroughs and Univac, in fact for most of the companies in our industry, it was a year of growth and profit. For a few, like Datran, it was the end of the road.

But it's a new year and we firmly believe in the wisdom of Satchel Paige when he said, "Don't look back. Somethin' might be gaining on you."

In this issue we're looking ahead. Withington, Pullen and Simko gaze into their clouded crystal balls to extrapolate industry trends. On page 56 you'll find the responses of industry leaders from around the world to the question: "What is the greatest contribution you hope the computer industry can make to the well-being of the world we live in." Replies range from the visionary to the pragmatic.

In this column you'll find some rather less altruistic, shorter range wishes—a collection of wistful odds and ends that we hope will come true this year.

For instance, we hope that Carter administration policy decisions will recognize the importance of data processing here and throughout the world, especially when confronting such thorny problems as exports, balance of trade, antitrust, and privacy. Over on the legislative side, wouldn't it be nice if the Bell bill died the death it so richly deserves? At the same time we wish the FCC success with its latest industry inquiry and hope for a clear definition of the roles of the common carriers and the dp vendors, a clarification which will promote free and unfettered competition in the data communications field.

All of us (except the lawyers) will benefit from an end to that wearisome case slogging along in New York's Foley Square. Hopefully the Justice Department and IBM can reach a settlement that is not only a boon to the industry but also makes IBM more comprehensible to the outside world when it comes to organizational structure, standards, interfaces, shipments, and dollar volumes. Perhaps then we might see a new crop of eager investors, pockets stuffed with equity capital, ready to fund an equally eager new crop of industry entrepreneurs.

In addition to new firms entering the industry, we'd like to see the mini manufacturers flex their newly acquired 32-bit muscle and move strongly into the end user market, offering top quality maintenance, service and software support.

Speaking of software, let's get rid of the current crop of software acronyms (all the vendors are culpable, but IBM is the worst offender with its alphabet soup of SNA, VSI, CICS, IMS and the like). New names should be easy to understand, easy to remember and functionally descriptive.

This is the year we'd like to see all software unbundled, including systems software. In addition to a visible price tag we think the user also ought to know precisely what he's paying for. For example, he should be able to write a contract with the vendor spelling out the type and duration of software support he will receive. Before signing on the dotted line, he should be able to functionally compare the performance of one vendor's offering against another's. We hope too that before 1977 is over, some enterprising engineer will design the equivalent of an automotive diagnostic machine so the dp manager can determine just how well his software is performing *in situ*.

Will 1977 be the year of an I/O channel interface standard? If it is we devoutly hope it's a standard that doesn't tie us to yesterday's technology. X.25, the CCITT user interface packet switching standard is gathering momentum; hopefully the vendors will give it their unqualified blessing.

A few other odds and ends that need tidying up this year: legislation at the federal and state level clearing the air with regard to branch banking; fewer conferences with more innovative content (seems like the same old faces with the same canned pitch are endlessly plying the circuit); and less talk by the user groups and the academic societies about getting together and some real action.

And finally, right to die legislation for the 1401.

So there you have our wish list—fragmentary, incomplete, and hopelessly optimistic. You probably have wishes of your own . . . we'd like to hear them.

But if, as we suspect, very few of our wishes and your wishes come true, we can only offer some timely advice for survival in 1977.

- Keep the juices flowing by jangling around gently as you move.
- Avoid fried foods which angry up the blood.
- If your stomach disputes you, lie down and pacify it with cooling thoughts.
- Avoid running at all times.

Satchel knows best.

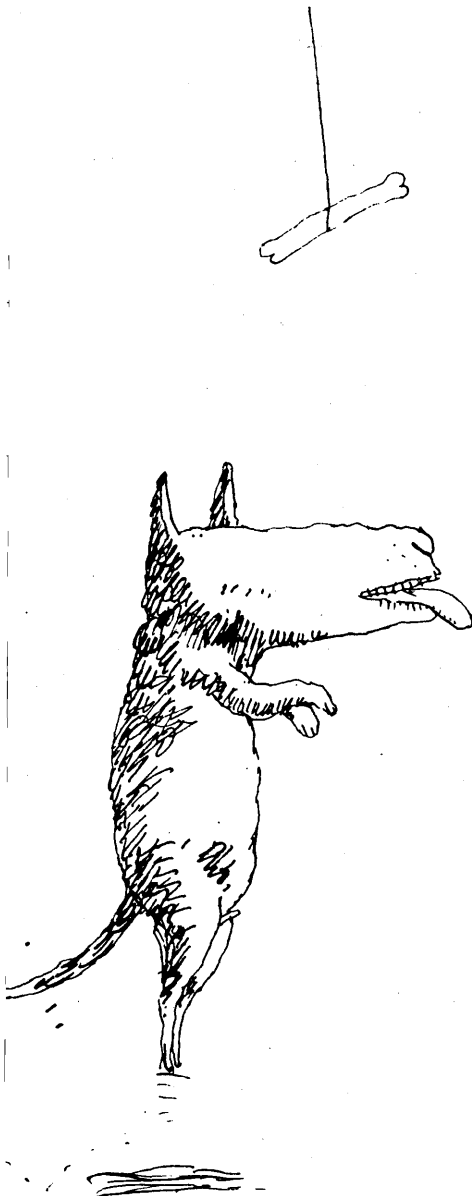

© R. J. Lee 1976

# The Outlook for DP Business

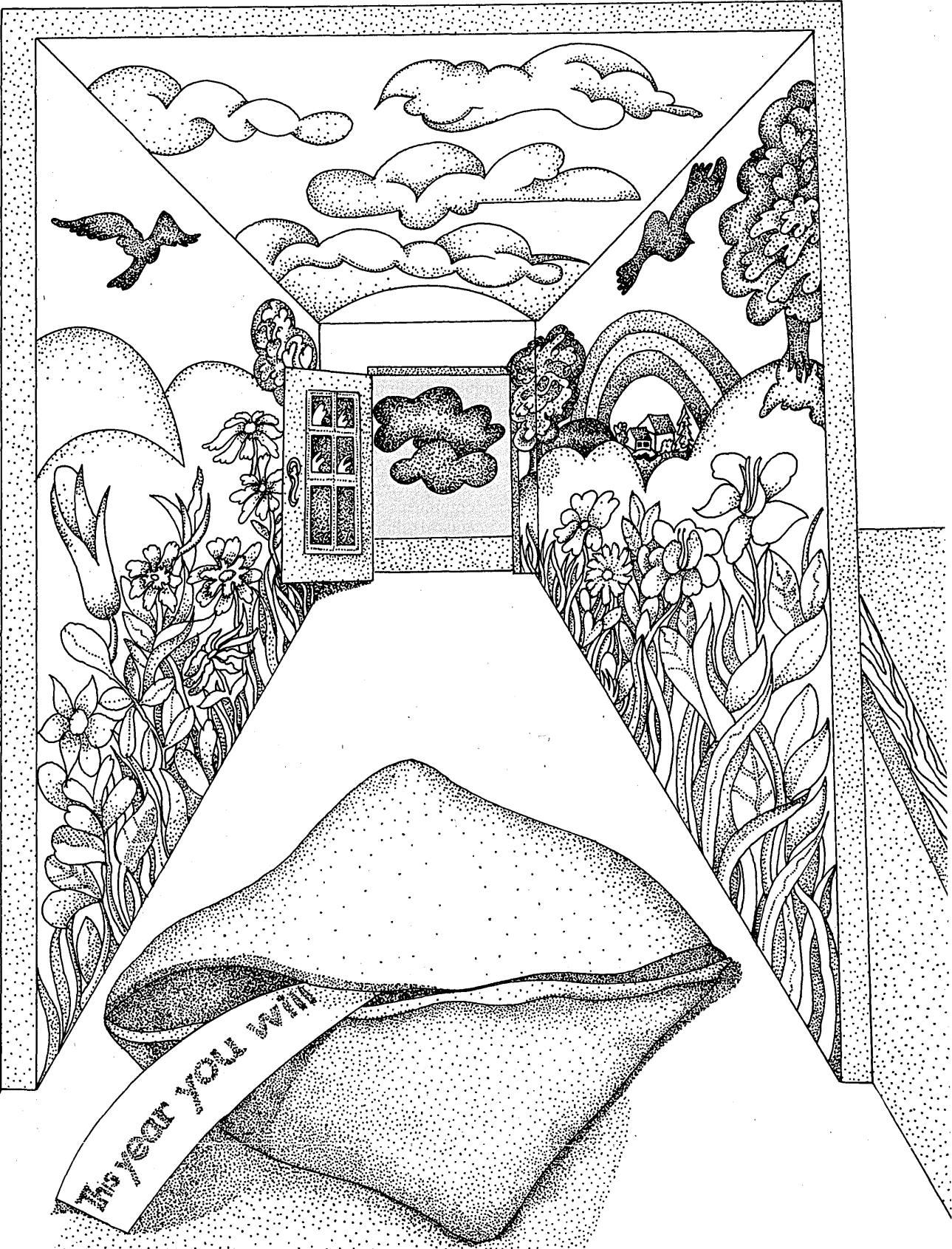

*Suzanne Carson*



# and Technology in 1977

by Frederic G. Withington, Contributing Editor

1977 promises to be a great year. Users will finally get to use some of the much talked about new technologies, and vendors will see near peak revenues.

## The Business Outlook

1977 should be a good year for the data processing industry. Revenues of U.S.-based vendors in our industry may exceed \$30 billion for the first time, and profit margins should be better for many. This should be true even if the economy is somewhat queasy; orders placed by users in 1976 (and unlikely to be cancelled short of economic catastrophe) virtually guarantee it.

The major factor will be a wave of shipments of the new mid-range computers. IBM's models 138 and 148 will lead the parade in volume: the demand for them is clearly great (early delivery dates are worth substantial premiums to leasing companies). The Burroughs 800 series, the NCR Criteria and the Univac 90/80 will also be in full volume all year.

Shipments of small systems, both for standalone and network applications, will also be substantially up from 1976. The Burroughs B80 will be in volume shipment all year, and the IBM System/32, Honeywell Series 6, 61 and 62, and Univac 90/30 should all increase their volumes over 1976.

The picture in giant systems is less clear. The demand for them was impressively demonstrated in 1976, with users accepting very large numbers of existing machines (IBM 158 and 168, Univac 1100s, Honeywell level 66s) and of a few new ones (Amdahl 470 V/6). Will demand be temporarily saturated in 1977? Will major new IBM giant computer announcements occur (as the rumors say) that will impact shipments of existing models? Maybe. In any case, it is probably safe to bet that the insatiable appetite of giant systems for more peripherals (mainly memory and discs) will continue. Regardless of giant mainframe delivery activity, then, peripheral shipments to existing systems (more profitable to the manufacturers) should suffice to at least hold the overall shipment level constant.

Minicomputers will be up again (what else is new?). DEC's delivery times for some models exceed one year, and the other major suppliers also report excellent backlogs. Competition is growing steadily more intense as IBM has followed Honeywell into the arena. The only questions are how

big the improvement in volume and revenue will be, and whether this can go on forever.

Manufacturers of all classes of computers have been revamping their manufacturing processes and taking advantage of higher levels of circuit integration. Some (like Burroughs and NCR) have done this throughout their product lines. Others (like IBM) have only done this with memories so far, but memory manufacturing cost is equal to or greater than that of CPU's. Some of the resulting economy is passed on to the users, and some is kept to increase profit margins; both parties, vendors and users, should benefit in 1977. Now, if the manufacturers could only do the same thing with the costs of their systems programs (development, support and usage), the millennium would really arrive.

Terminals and specialized I/O devices will also be on the uptrend. Some new technologies are beginning to have market impact, as noted below. More important, the multi-year plans of many users to implement transaction processing networks are continuing, and as the last recession showed, the result is network expansion in both good times and bad.

The safest forecast is that the inexorable growth of the software and services businesses will continue in 1977. Never dramatic in any one year but never faltering, improvements in the versatility and cost-effectiveness of software packages and service bureau offerings are continuing so that (when contrasted to the increased cost of in-house development) they attract more and more customers. Accelerating this trend is the "creeping unbundling" of the system vendors, slowly moving more of their systems programs into the revenue-producing category.

All in all, it looks like a good year for the industry as a whole. Products are changing (as noted below) and are generally becoming more software-intensive. Not all vendors will benefit from this trend, but most surely will.

## The Technology Outlook

It's always difficult to forecast the exact time and manner in which a new technology will appear. Still, it's clear

that certain technologies will be more talked about than others in 1977, that new products incorporating them will attract the greatest interest, and that some longer-range technology trends will become more clearly established. Divided roughly into four classes, the following appear likely to be the major technology trends for 1977.

### Systems and software

"Automatic file subsystems" may begin to appear in 1977. Performing the housekeeping functions associated with the access method in a standard manner (but not the much more diverse logical functions of the data base manager), and managing the hierarchy of file storage devices in a manner transparent to the user, they promise substantial labor savings. IBM seems to be taking the lead in this area: first with its 3850 mass storage device and the concept of file volumes located in the hierarchy heuristically, recently with its JES2 release 4 "Selectable Unit" that seems to be integrating VSAM and JES functions—and which (as a Selectable Unit) can conceivably be implanted in a separate file processor.

Large minicomputers will strain upward in functionality. Many users would like to implement distributed networks for excellent reasons, but they would like to at least retain the present level of systems program capability that the large general purpose systems have struggled so hard to achieve. Users are often disappointed with the systems programs available on the minicomputers, and some abandon the attempt to use them as a result. Minicomputer manufacturers will be trying vigorously to close the gap, using fresh approaches; it will be interesting to watch their progress.

One of the fresh approaches that will apparently be used increasingly is the virtual machine concept, with both simple, single-purpose monitors for the various modes of use and earlier operating systems co-existing independently under the VM arbiter. The approach is inefficient in its use of machine cycles, but these become less and less expensive, and the functionality of available VM's continues to improve (as with the VM/370 implementation for IBM's model 158 Attached Processor).

All software vendors will work diligently to produce more successful ap-

## TRENDS IN 1977

plication packages. However, experience over 20 years makes it hard to believe that sudden, overall improvements are likely; the gradual business growth referred to above is more probable. More general potential may lie in the idea of improving the ease of programming to a point where users can do much of their own after at most a few hours of training. Terms like "interactive," "parametric," "descriptive" and "program generator" are applied tools designed to make this possible. Evolution of the query languages associated with data base management systems is one of the interesting lines of progress in this direction; so are some of the minicomputer programming tools.

### Components

As noted above, we seem to be in a period of re-implementation of existing computer lines using more advanced electronics. Burroughs has re-implemented (and extended) its 700 series in the 800s, using current-mode logic. NCR's Criterion, Honeywell's Level 66 models, and IBM's memories are other examples. (Can IBM cpu's be far behind?) Further re-implementations are likely to appear soon.

Magnetic bubble technology should appear soon in commercial products. Its characteristics suggest that large memories for general purpose computers may not be the first products using bubbles; terminals, word processing systems, or portable computers appear more likely to be first.

Microprocessors will continue to show up in surprising places. We already have the first automobile containing a micro. Several types of consumer appliances already contain them, and more will. TV sets are beginning to incorporate solid-state tuners which are similar to microprocessors; what additional capabilities will soon be added at almost no cost? Calculators (the sets already have ten-key pads)? Games? APL capability? Terminal functions?

Digital watches are interesting, too; they diverge from straight time-keeping to include calculators and personal calendars. Maybe microprocessors are still a little large to strap on a wrist, but what can be done with a desk clock? It might be said that these speculations have little to do with data processing, but what is data processing anyway?

### Peripheral equipment

Non-impact imaging technologies are entering the marketplace at an accelerating rate. Ink-jet and electrostatic technologies, in particular, can be applied to printing and plotting in new

ways—not only offering higher speed and (in some cases) better cost effectiveness, but also unprecedented graphic and multicolor capabilities. The flow of new products is increasing, especially now that IBM has blessed both technologies, and users will find new things to do with them. Very likely, large vendors who are not now heavily in data processing but see themselves as strong in imaging will soon be competing more heavily.

Interactive display and graphic input technologies are also going to accelerate. The use of small digitizers as flexible input media, interactive plasma panels, scanners for input of micro-image material, and similar techniques are all appearing in the context of particular applications; these will grow, leading to intensified vendor efforts.

We may be on the brink of a product breakthrough in personal identification technology also. Both signature dynamics and voiceprint identification offer promise, and there is sufficient demand to spur vendor investment. It's particularly hard to forecast any breakthrough, however, much less its timing; this is a long shot.

### Office products

This product category may be outside the traditional data processing framework, but it certainly will not remain so (see "Stages of Growth," October 1976, p. 46). Anyway, during the coming few years, many of the most interesting technology innovations will be appearing in these products.

Word processing systems will evolve both upward and downward very rapidly. We will soon see integrated publishing systems in which the material is in a single system from the beginning of the process to the end. Word processors will soon develop both intrinsic communications capability (why mail the paper when you can print it for the first time on the receiving machine?) and data processing capability (DEC's 310W can already have both word processing and dp personalities). Electronics will also invade the conventional typewriter soon, perhaps in the form of a line buffer and display that will permit a line to be justified and corrected before being typed on the paper.

Digital facsimile devices will improve rapidly. The microprocessor is well suited to performing bandwidth compression by digitizing a scanned line and transmitting only change-of-shade data. The ink-jet printer is well suited to reconstituting a noise-free line at the receiving end, whether the material be characters or graphics. Coupling these technology potentials with the deterioration of mail service leads to a forecast of rapid product introduction and market growth.

Finally, the line between calculators,

portable computers and intelligent terminals will soon disappear (if, indeed, it still exists). All three products are steadily adding functions because of the low cost of electronics. Many clever new products are certain to appear.

### And more

A number of major technologies have been omitted from this list, including large computer architecture, mass storage devices, programming languages, and data base management systems. These are omitted either because no dramatic change appears to impend or because progress in the area is intrinsically evolutionary. Concentration here on novel technology tends to mask the fact that a year's-worth of evolution in an area of major importance such as data base management systems can be more significant to the industry than a breakthrough in the technology of a less significant area. Also, the 1977 business outlook for these main-line products is much better than that for the more novel ones.

In summary, the business outlook for existing products looks good for 1977, and the mix will be leavened by at least some of the above new technologies, which will lead to future business growth. We are still in a growth industry. \*

*For more of a feel for which direction that growth will likely take, see "Our Changing Industry," for the directions we wish it would go see "Computer Wishlist," and for one direction we hope it doesn't take, "EFT in 1988," all of which follow in this issue.*

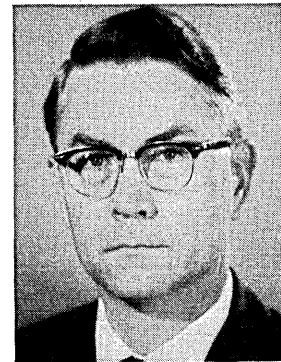

At Arthur D. Little, Inc. since 1960, Mr. Withington has performed many studies for users and vendors of data processing equipment and services. He is in charge of that firm's data processing industry analysis and forecasting activities. Prior to joining Arthur D. Little, Mr. Withington was eastern regional manager of technical services for the Burroughs Corporation, and before that he managed a programming group at the National Security Agency.

He has been one of Datamation's contributing editors for seven years.

# Our Changing Industry

by Edward W. Pullen and Robert G. Simko

The growth of existing markets, the development of new ones, and the surge of technical innovations are causing changes in our industry which will in turn cause changes in our business organizations and in ourselves.

The computer industry's horizons are broadening. As a direct result of the interaction of existing markets and available technology, the "data processing systems" business is being replaced by the "information systems" business. The change represents significant new opportunities for suppliers of computer equipment and services, plus significant new demands on the computer professional.

As an example of how this is happening, the acceptance of distributed processing is becoming a significant contributor to the extension of computer products and services for new applications in offices and plants as well as, eventually, in home information processing. "Information Systems" are emerging which incorporate many new aspects of the business communication process, while both computer manufacturers like IBM and business equipment makers like Xerox dip deeply into the design stages of new products for the "new" industry. This trend, or increased acceptance, is in turn greatly broadening the duties of dp management.

And while this information systems business is taking off, conventional dp business is reaching toward maturity in its applications. That doesn't mean it is dying or drying up, however.

## Where the market is going

The rate of increase in dp spending did take a slight dip in 1975 in reaction to recessionary pressures. A good part of this dip can be shown to have come from the substitution of lower priced third party equipment for the computer manufacturers' components (disc, memory, and even cpu's), plus reductions in staff salary levels. The picture was mixed, though. Some industries, caught in midstream implementation of point-of-sale, funds transfer, and environmental control systems, continued these new efforts without a pause. In other industries, the need for businesses to have more and faster information to remain competitive provided the driving force for the installation of small business systems by many first time dp users.

The big picture is beginning to look even brighter, too. Total dp spending from 1976 through 1980, exclusive of office automation, is forecast to increase at a rate of 15.5% per year. Admittedly, a slowdown is forecast for the 1979-1980 period as a reaction to an expected general economic turnaround, but the slowdown shouldn't hurt too much. Its effects, combined with the maturing of the POS, small business system, and EFTS markets, will hold down overall growth from 1980-1983 to "only" 14.2%, and that's not bad.

Dp spending patterns for selected industries ("selected" because they collectively accounted for 53% of all dp spending in the U.S. in 1975) are shown in Table 1. These same industries also represent major teleprocess-

FORECAST OF EDP SPENDING

Industry	EDP Spending (\$ Billions)			Average Annual Growth %
	1975	1976	1980	1975-80
Discrete Manufacturing	\$ 5.04B	\$ 5.90B	\$ 9.77B	14.2%
Process Manufacturing	3.79	4.42	6.99	13.0%
Wholesale	.57	.69	1.18	15.7%
Retail	1.81	2.29	5.42	24.5%
Banking	2.82	3.43	6.14	16.8%
Other Industries*	12.41	14.42	22.79	12.9%
Total	\$26.44B	\$31.15B	\$52.29B	14.6%

\*Agribusiness, construction, transportation, utilities, insurance, medical services, education, state-local-Federal government, computer services, business services, travel and recreation, etc.

Table 1.

## CHANGING

ing action areas over the next five years. Then, around 1983, those other industries which are expected to lag in implementing teleprocessing systems—including construction, agribusiness, education, motor freight, small utilities, and travel/recreation—will begin to dominate the marketplace.

There is also presently a related heavy swing in progress to network oriented data processing. This represents the mainstream of dp management activity today, and will continue to do so throughout the forecast period. But look at the nodes of these networks. At some point there is still usually a "mother" computer acting as the ultimate consolidation point and resting place of the business management data. This is typically the corporate (or divisional) computer center with its large general purpose system(s).

Three factors seem to be highlighting the accelerated trend to distributed processing. These are: (1) the number of users going on-line; (2) the growth rate of intelligent terminal product shipments; and (3) the total number of systems supporting data communications networks. Parts (1) and (3) of that can best be addressed by looking at how many firms operate on-line systems. In 1975, some 9,500 did; by 1980, the number should be 23,000 (from a universe of about 42,000 potential user firms).

Point (2) is best addressed by Table 2. Some background is necessary first, however. Over all user industries, shipments of dp products and applications hardware to U.S. users are expected to increase at a rate of 9.6% annually through 1980, slowing to a rate of 8.4% over the period 1979-1983. (This is based on an "if sold" valuation of hardware shipped, and amounts to a total "if sold" increase for hardware installed from \$11.9 billion in 1975 to \$18.2 billion by 1980 and to \$23.2 billion by 1983. Table 2 depicts the markets of major activity, showing that the action is most certainly in products which distribute data processing and storage capabilities to the ultimate user community.

Partly because of this growth rate, the move to teleprocessing oriented systems is reaching its maturity. By 1980, shipments to users of teleprocessing based computing systems will amount to \$11 billion (including \$3.5 billion for time-sharing firms) compared with only \$6.6 billion in shipments of batch hardware.

Equipment shipments (shipments of the components of products and applications systems) track product/appli-

cation shipments with identical growth rates. The highlights of equipment activity are shown in Table 3, and once again illustrate the overall trend to distribution of computer processing power, data storage and I/O peripheral capacity.

Through it all, hardware price trends are, without exception, expected to be downward. Major contributing factors are:

- decreased cost of semiconductor components and storage peripherals
  - shipment of fewer terminals in typical configurations
  - separate pricing of software components
  - decreased cost of product testing
- In general, a decrease of 4% per year is expected due to the reduced costs of components and manufacturing.

In the end-user market, the trend is to decreasing hardware prices while increasing the total "cost of possession." Translated, that means while hardware is going down in price, increases in the following items more than compensate for the decline:

- software
- maintenance
- warranties
- communications
- training
- direct customer service

## The competition

Hardware price/performance and reliability should be relatively the same between suppliers. The most important degrees of competitive freedom therefore will be:

- software availability and pricing
- maintenance pricing and conditions
- warranty conditions
- customer service

IBM, Burroughs, NCR, and Xerox have a distinct edge in software and service. The minicomputer suppliers such as DEC, Data General, Litton, and Datapoint have a great deal to accomplish to remain competitive in the long run. Application specialists such as Data Pathing, TRW, Docutel, the process control system suppliers, and the machine tool and test control product suppliers have, in general, established excellent reputations for knowledge and responsiveness. Their major problem will be one of growing and continuing to maintain their current quality image. Suppliers of text processing systems, with the exceptions of Xerox and IBM, have yet to establish a capability for handling the systems support for their products. This alone will be a major deciding factor of survival in this application area.

To aid in analyzing the competitive forces in the information systems ap-

SELECTED END USER PRODUCT/APPLICATION SHIPMENTS

Product/Application	U.S. Shipments (\$ Billions)			Average Annual Growth %
	1975	1976	1980	1975-80
<b>General Purpose Products</b>				
Small business systems (1)	1.94 B	2.11 B	2.53 B	5.5%
Large gp systems (2)	4.85	5.23	5.93	4.1%
Single crt terminals (3)	.40	.56	.64	10.0%
Multi-crt terminals (3)	.32	.42	.61	14.9%
Teleprinters (3)	.32	.39	.44	6.2%
Document entry	.13	.20	.32	19.6%
Add-on peripherals	.83	1.05	2.18	21.3%
<b>Applications Oriented</b>				
Point of Sale systems	.25 B	.33 B	.40 B	9.9%
POS terminals	.27	.49	.70	21.0%
Graphics terminals	.14	.16	.24	11.4%
Consumer EFTS	.13	.16	.28	16.6%
Tool and test control	.15	.20	.44	24.0%

(1) Renting in the range of \$200 to \$4,000/month

(2) Rental greater than \$4,000/month

(3) Products facing heavy pressures on prices

Note that the category "add-on peripherals" has one of the highest growth rates. This covers the addition and/or upgrade of higher capacity peripherals. The two subareas of most activity will be: data storage (primarily disc storage), and I/O (primarily printer and display devices).

Table 2.

SELECTED COMPUTER EQUIPMENT SHIPMENTS

Equipment	U.S. Shipments (\$ Billions)			Average Annual Growth %
	1975	1976	1980	1975-80
General purpose cpu	\$1.86 B	\$1.91 B	\$3.68 B	14.6%
Small business cpu	.43	.56	.61	7.2%
Mini-cpu	.28	.32	.24	-3.0%
Micro-cpu	.07	.14	.56	51.6%
Add-on memory	.48	.63	1.09	17.8%
Disc storage	2.73	3.48	5.05	13.1%
Tape storage	.80	.86	.74	-1.5%
Printers	.94	1.08	1.20	5.0%
Card I/O	.48	.51	.63	5.6%

Table 3.

plications area, we have organized companies into a number of groups which share similar product positions and exhibit a common approach to the marketplace. These groups, in themselves, actually represent competitive forces. While members of the group compete primarily with each other on an individual basis, they also are adopting strategies specifically designed to compete against outsiders. These groups are defined as:

- Large general purpose systems suppliers—This group is composed of the six surviving full line systems manufacturers.
- Minicomputer manufacturers and

ucts and services; and (3) Competitive capabilities—competitive processing-oriented products.

Fig. 1 illustrates the relative market shares of total dp revenues held by U.S. companies, on a worldwide basis. IBM controls some 47% of this total. Six firms—the large general purpose system makers—control 73% of the total market. The balance is divided as illustrated among the other groups of competitors. The first four groups represent some 88% of all U.S. based data processing revenues. The last group is composed primarily of oem's, plug compatible device manufacturers, and media suppliers. The role of these

“traditional” dp, there is a great deal of room for growth in the “information systems” industry. For example, each office employee is currently supported by some \$6,000 to \$7,000 in capital equipment, whereas each factory employee is supported by \$25,000 to \$30,000 in equipment. Opportunities for productivity improvements in the office and in business communications abound, and a host of companies are entering the market. Examples of such companies include:

- Burroughs—The company is building its capabilities through acquisition. This includes Redactron (word processing systems) and Graphic Sciences (facsimile). Also, the B80 could provide a basis for an integrated electronics telephone system and business data processor.

- Datapoint—Integration of data entry, small business data processing, and an electronic telephone system has been achieved in the company's recently announced “Infoswitch.” This is a very significant departure from Datapoint's intelligent terminal business.

- Exxon—Looking to information systems in the future, Exxon has taken positions in Bydec (communications equipment); Periphonics (voice recognition and synthesis), and Zilog (microcomputers).

- IBM—The IBM WP32, its European manufactured PBX, the SNA networking concept, and satellite communications services are all there.

- Xerox—The firm is executing a well-planned acquisition program. Its family now includes Diablo Systems (small discs and teleprinters), Versatec (impactless line printers), and Daconics (multi-station text processing systems). These components, together with the Xerox 9200 computer controlled copier and the telecopier facsimile product line, form the basic building blocks of an information system.

How soon and where will it all happen? In a recent survey conducted by Gnostic Concepts among “Fortune 1000” companies, some 63% of the respondents were found to be favorably disposed to the trend of distributed information processing, while only 26% were firmly opposed. The results also show that order entry and fulfillment applications are receiving the most attention, becoming a focal point for integrating communications with data and text processing. Organizational integration of office, communications, and dp services is already taking place to support such applications.

#### The changing organization

So, now that we possess the technology, and the costs are on their way down, let's look at some of the end user

FIGURE 9.1  
EDP PRODUCTS AND SERVICES REVENUES FOR US COMPANIES

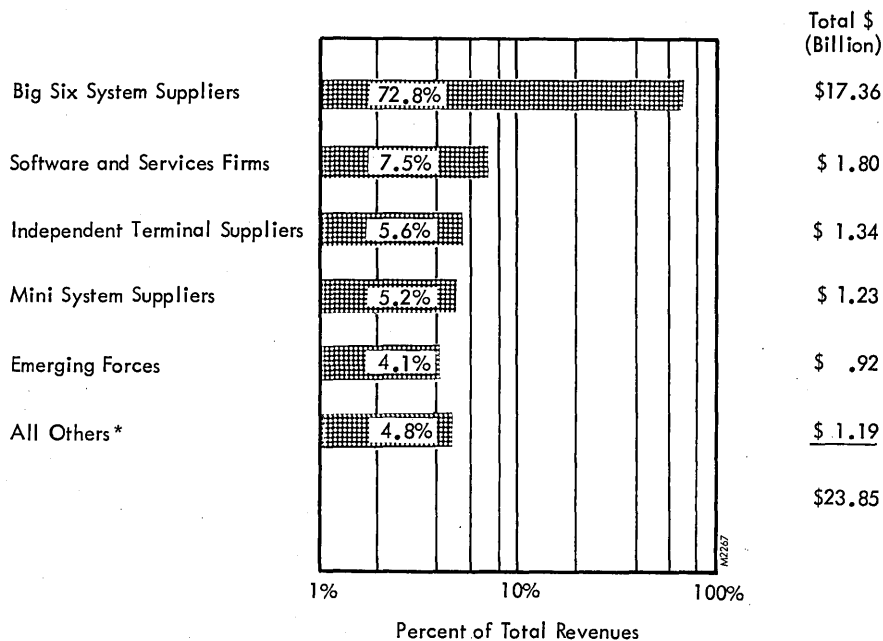

Fig. 1 \* Includes OEM and PCM firms such as Ampex, Centronics, Data Products, EM&M, General Instrument, Recognition Equipment, Telex and others.

small systems suppliers—This includes DEC, other mini manufacturers, and small business systems houses.

- Independent terminal suppliers—This group includes firms whose basic dp hardware business is in terminal products.

- Emerging forces—Key firms which do not belong to any of the previous groups, but have both the inclination and resources to become major competitive forces in the distributed processing market.

Companies in each group share, in general, a particular position in and perspective of the marketplace which affects their product offerings and competitive strategies. Each group must be considered in terms of the following factors: (1) Group characteristics—the environment and attitudes which these firms share; (2) Market share—group and individual share of the total market for dp prod-

ucts and services; and (3) Competitive capabilities—competitive processing-oriented products. They will, in general, continue to act as equipment suppliers to the firms included in the previous groups.

#### An information systems industry

Although measured in \$ billions, dp—at least as we have always considered it—is a small part of the total economy. Its best fortunes may come where it can anticipate the direction of growth of the bigger system and get there first.

The U.S. economy is becoming increasingly service oriented, in terms both of employment and contributions to the Gross National Product. It is estimated that office expenditures will range between \$450 and \$475 billion this year. Traditional dp will account for a mere \$30 to \$32 billion of this total.

Yet if there is little prospect for

## WHERE THE TECHNOLOGY IS GOING

Computer system architecture is evolving steadily under the pressure of significant emerging factors, including recent breakthroughs in semiconductor technology, the development of new communication facilities, and a greater penetration of on-line applications.

The first major consequence of this evolution is the dissemination of processing power throughout the system; the functions that can be isolated from the mainstream of the application are performed locally by a processor attached to the remote device. This has the effect of unloading the host computer, reducing the communication cost, and offering local availability of computing capability.

The second main impact is in the

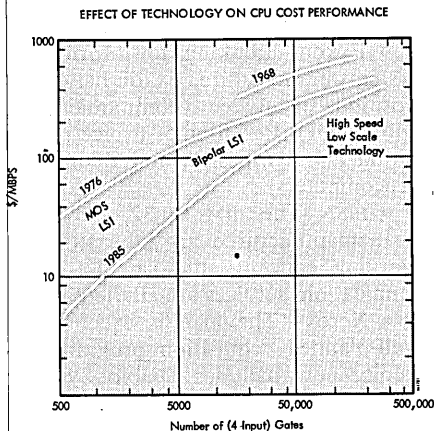

Fig. 2

design of the processor itself which could be built more economically by using inexpensive chips as components. Clusters of microprocessors and miniprocessors represent a challenge to the medium and large processor.

The traditional way of designing, constructing, and using computers is slowly but drastically changing. This is the result of technological advances, evolution in communications, and the requirements of new applications.

Computing power was once a scarce and expensive commodity that could be justified only if used to its fullest extent: economy of scale was the principal factor in determining the investment for a computer with the underlying assumption that performance was growing more rapidly than cost. The breakthrough in large scale integrated circuit technology in recent years has brought about a revision of that perspective since computing power—as an element of a

system—has now become the cheapest component, especially with the introduction of a wide range of microprocessors. There is a bottom limit as to what a microprocessor can cost, but the prospect of having available, at a low price, either faster microprocessor elements or arrays of such elements, stresses the importance of the architecture of future systems. Similar advances are occurring in memory technology that will also reflect on the way processing elements and memory will interface and interact.

The power of a computer—as measured by its throughput—is often equated with that of the central processor. In this respect, power characteristics are very much dependent on the technology used to implement the central processing unit, and short of having ways to run the system simultaneously over separate processors, is limited by that technology. To be sure, the idea of assembling processors in some fashion to increase power is not new. However, various arrangements lead to different characteristics, the most important of which relates to the programmability of the system for general purpose use.

Processor cost does not vary linearly with processor performance. As illustrated in Figs. 2 and 3, LSI technology is most significant as it affects

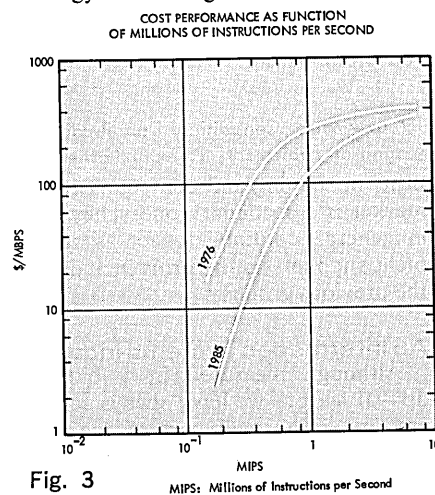

Fig. 3

the low end of the spectrum of computing power. Circuits are now available that cost under \$100 per MBPS (million bits per second throughput), which are expected to sell for under \$10 for the same throughput within ten years. At the same time the cost performance of the large cpu's (above 50,000 gates) will remain relatively unchanged. Overall, the cost of low throughput circuits has

dropped, and will continue to drop more dramatically than that of higher power, which favors the attempt to use several of these low performance circuits to build a central processor.

The profile of the cost performance characteristics of processors is evolving in a way that suggests that manufacturing costs of processors will be reduced significantly as a result of the integration of multiple processors into one system.

For use in a general purpose environment, a multiple cpu architecture, built from LSI processors, brings manufacturing costs down but operating system software costs up. An analysis of these two cost components shows there are break-even points where the required throughput of the machine is large enough to warrant more than one low cost processing element, and at the same time the expected number of machines sold is high enough to spread the cost of software development. The equation should also take into account the fact that applications systems (where the required throughput is not too large) have a better market penetration—in number of systems sold—than large machines, illustrated for example by the fast increase of small business machines. Multiple cpu architecture will replace medium and large machines and is more economically justified when the application does not require full general purpose executive software. The rapid progress of semiconductor technology will impact the break-even points as microprocessors eliminate minicomputers through improved cost performance characteristics. This, coupled with increased software costs—somewhat lessened by the experience gained in and the utilization of efficient programming techniques—will displace the economic threshold of multiple processor systems toward a greater number of systems to be sold.

Memory technology will also play a significant role in terms of its relevance in a computer system and its use in meeting application requirements. Three main parameters must be assessed and compared:

- Access time to the on-line information (in response to a request originated from the cpu). A variety of technology exists that covers the spectrum from  $10^{-8}$  seconds to a few seconds.
- Maximum memory capacity as a single addressable storage unit. Typically there is a direct relation between capacity and access time: large capacity yields long access time.
- Cost of storage and cost of access to an element of the memory

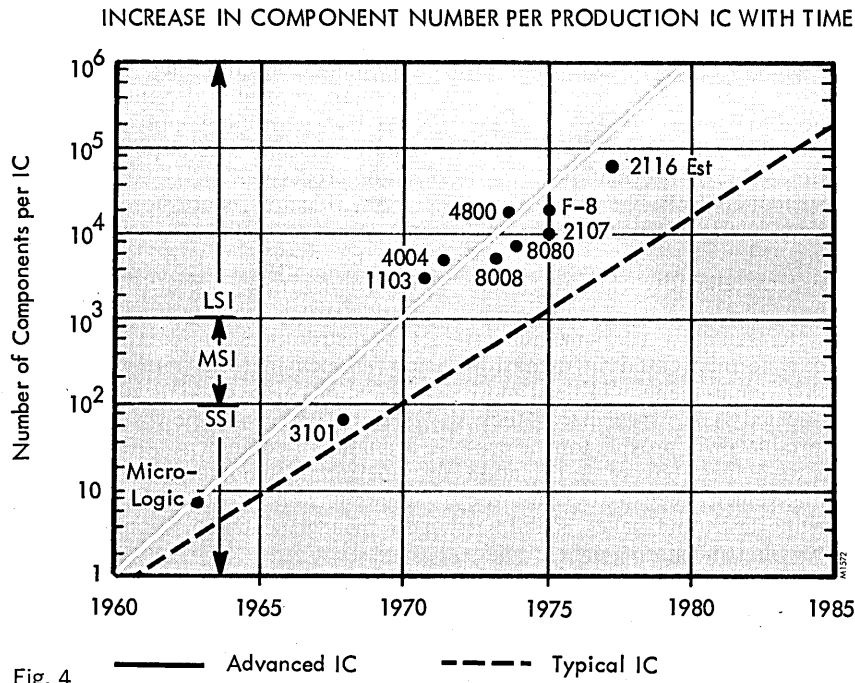

Fig. 4

TRENDS OF SYSTEM COST FOR CHANNEL km AND CHANNEL CAPACITY

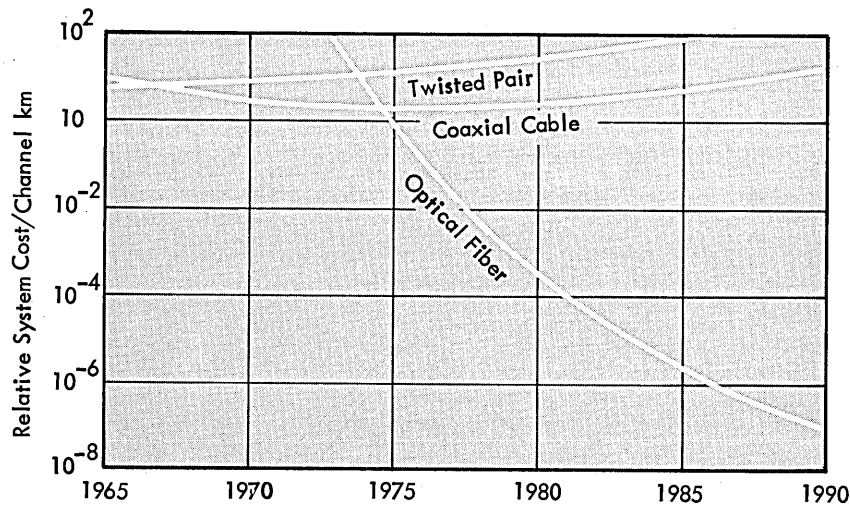

Fig. 5a

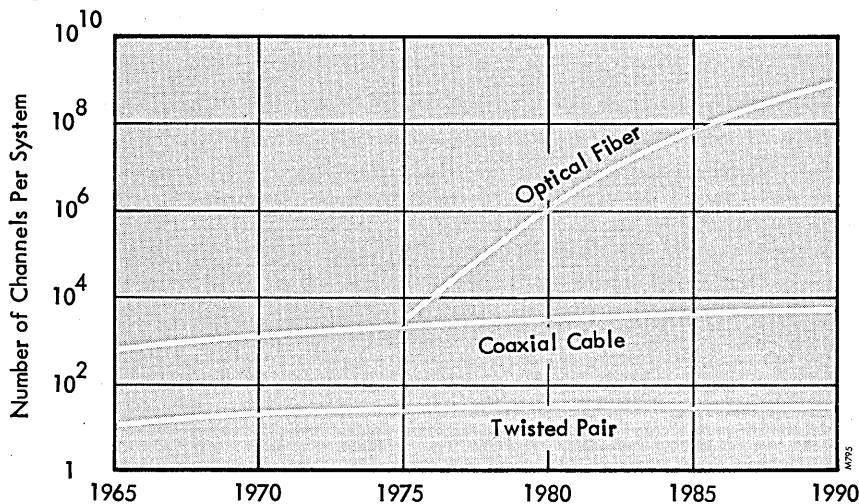

Fig. 5b

data.

Emerging technologies (electron beam, charge coupled devices, bubble memories) now fill the gap that previously existed between fast rotating devices (drum, fixed head disc) and core memory. In turn, the access time determines the number of transactions capable of being sustained by an application.

Advances in solid state technology are making the proliferation of information systems possible. Improvements in semiconductor processing have been and will continue to be the major factors in the progress of semiconductor circuit and system design. Key improvements include lower processing defect density, smaller line widths, and tighter device parameter spreads. Cost/performance improvements at the chip level are the direct result of:

- increase in wafer size
- decrease in wafer dislocation and circuit defect density
- increase in circuit complexity
- decrease in circuit component dimensions
- increase in circuit performance
- decrease in power consumption
- advances in lithography
- packaging technology advances

The average number of components (transistors, diodes, resistors) per advanced IC has doubled every year as shown in Fig. 4. This trend will continue over the next several years. By 1980, the most advanced circuits will contain the equivalent of 1 million components.

Independent of the technology, a rapid evolution is taking place in the communication area. This is highlighted by the fact that in the immediate future, until fiber communication becomes commercially available for long haul traffic, the cost of communication is bound to go up. This cost increase is projected to be substantial enough to promote cost reduction measures such as time division multiplexing of line use, packet switching, or local processing.

The progress achieved in the development of practical optical communications systems since the beginning of the '70s has been staggering. Short communications links are in field trials and several specialized applications for which fiber optics are ideal are in various experimental stages. Fig. 5 illustrates the cost trends for fiber optics relative to current alternatives. This will have an important impact on the costs of local communication loops required to connect office stations to a satellite network. \*

# CHANGING

driving forces which are creating the demand. In essence, the major driving forces behind the demand for such products and services is the "time value of information" to management, shown in Fig. 6 and in Table 4.

The data collected and stored within an organization can be considered an inventory of inputs for decision making and/or status reporting. Like any inventory, these items lose value with time. In fact, operational data is a highly perishable quantity relative to its value for decision making. Not all data in this inventory is of the same value. For example, a ranking can be assigned:

- Class A data—time critical, used for operational and tactical decision making
- Class B data—status information, used for communicating the state of the organization
- Class C data—archival data,

processing and data storage are an important part of the conceptual design of the corporate information management plan. Key considerations include:

- need to know
- communication costs
- time value of information
- span of control
- time constant for organizational response
- system reliability (hardware and networks)
- system stability (organizational).

More sophisticated information handling requirements will need more sophisticated and specialized tools. New products will provide for the evolution of a hierarchy of information handling vehicles, which are optimized to specific tasks and have capabilities of processing and storing data at many levels. There is a realization that an application is not a monolithic task, but many tightly or loosely coupled interrelating tasks. Distributed processing is moving computing power

and data storage capabilities physically closer to the ultimate user, at the task level. Examples are found in POS, factory data collection, text processing, inventory control, order entry, production line scheduling, process control, data entry, and general purpose transaction processing.

As critical parts are stored closer to the production lines, so will critical data be stored closer to decision making points. In essence, it is data distribution that is creating the demand for the distribution of data processing power such that the time value of information can be maximized.

Data processing power is already available in equipment other than terminals, minicomputer systems, or other products normally under control of dp management. This equipment includes:

- text processors
- personal computers (IBM 5100, Wang 1100)
- digital numerical control processors

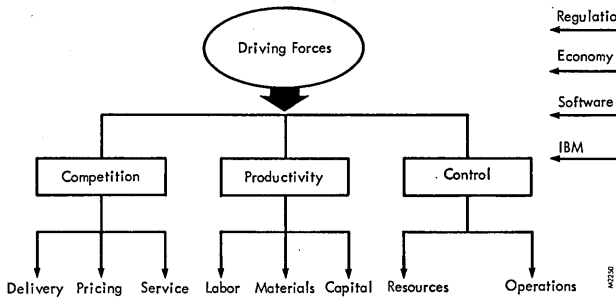

Fig. 6

stored to meet contingency or historical reporting requirements.

More Class A data is being collected, stored, and made available for faster decision making. While general purpose computers worked well for Class B and C data processing needs, the round-trip pipeline to a corporate computer center for Class A data is too long relative to the time value of that data. Class A data is of increasing importance in maintaining control. This is forcing dp management to accept distributed processing systems, and will require executive management to invest heavily in even more sophisticated information management systems.

An emerging information management configuration is illustrated in Fig. 7. Note that this will be the rule, not the exception, in the '80s. To deal with this environment, companies will need to develop some very different concepts and skills. Dp management will be joined, or eclipsed by: a corporate communications architect/administrator, an information inventory/resource manager, and a corporate teleprocessing/communications manager.

Note that levels of information pro-

FORCES AFFECTING THE VALUE OF INFORMATION

Business Trends	Impact on Information			
	More	Better	Faster	Less Costly
Inflation				•
Shortages		•		•
Government Impact	•		•	
Geographic Expansion		•	•	
Competition	•		•	
Management Sophistication	•	•	•	•
International Markets	•		•	

Table 4.

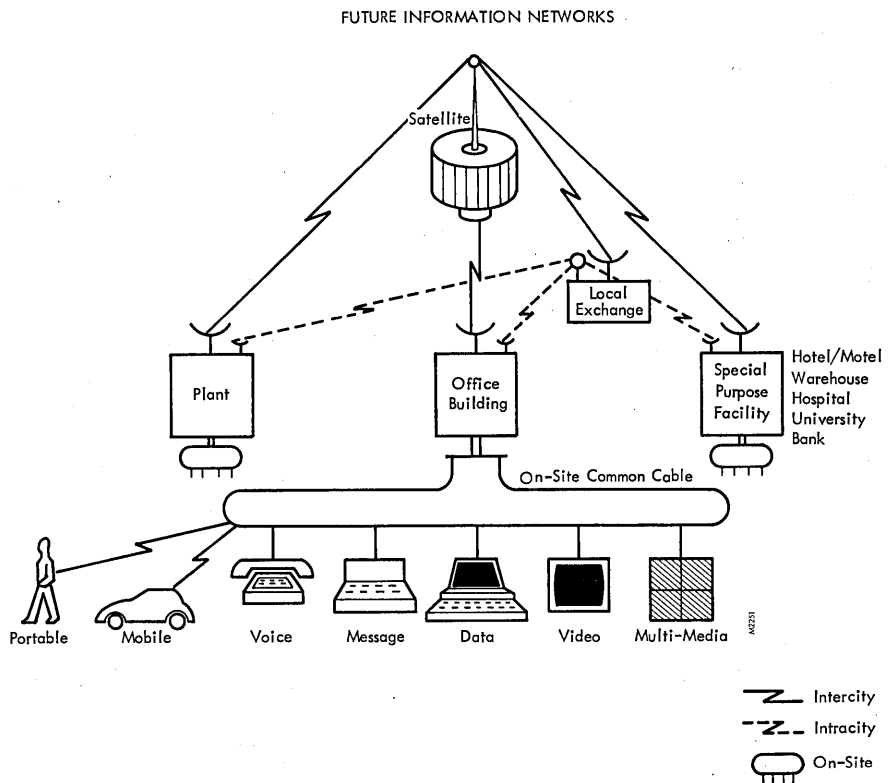

Fig. 7



- electronic PBX
- processor based replicating and duplicating equipment (such as the Xerox 9200)
- digital facsimile transmitter
- facilities monitoring systems.

All of this equipment—again generally not under the control of dp management—has substantial spare processing capability which could conceivably be tapped to satisfy information needs in a more timely fashion.

Distribution of data processing capabilities will have two basic impacts on a company: First, there will be staff reductions in clericals and support personnel as a result of transaction automation. Second, there will be an increase in requirements for dp professionals. Direct data entry, per se, will be the responsibility of the operating units. Transaction processing loops will be significantly shortened by the use of microprocessors and low cost/volume storage capabilities at point of entry.

### Demands on the dp professional

The changes in the organization will put some new demands on dp professionals. Dp management desires control of data processing and communication facilities relative to their selection, operation, integration, and prioritization.

Executive management desires control of data flow relative to enforcement of corporate policies, measurement of corporate and management performance, and maximizing corporate benefits while minimizing costs.

Obviously, these are not conflicting nor irreconcilable objectives. Rather, the latter require a different set of management skills (less technical and supervisory, more conceptual and coordinated) to optimize the information processing function in the firm.

The profile of dp professionals will be changing to stress the following:

- minicomputer programming experience
- telecommunications network experience
- industrial engineering background or training
- systems analysis experience and capabilities
- user training skills.

In addition, dp professionals will spend more time in the field at user sites. General management in manufacturing plants and department stores will have their own analysts/programmers assigned to their locations. This staff may be limited to one or two, but the capability will be locally authorized and controlled.

One of the major impacts of sophisticated information system implementation will be on training techniques. The local availability of the processing capability can be used to implement case studies or bring management game techniques into the training process. Decision making can be tested in a more extensive manner with rapid feedback (fire drills). Carried to an extreme level, the distributed information system can be used as a testing tool in the selection of personnel for a specific management assignment. Strict enforcement of equal opportunity employment and advancement may, in fact, accelerate such applications.

The greatest change will occur in firms that merge their administrative, communication, and data processing services into a single operating unit. Fig. 8 identifies the potential organization of such an information services administration group. There is increased recognition of the role of the data processing executive in the company. At least one major financial institution and several retailers are planning to elevate the data processing executive to membership on the board of directors. [And others have. See No-

vember 1976, p. 72, "The Managers Move Up." . . . ed.]

The "information systems" business is beginning to take off as the "data processing systems" business reaches maturity. The market potential in this emerging industry is expected to grow at an annual rate exceeding 20% over the next ten years, and is estimated to reach a level of \$82 billion by 1985. Key to this growth is the extension of data processing equipment and techniques to the individual work station, and into many aspects of day-to-day business communications. Data processing management, in turn, will be charged with the responsibilities of designing, maintaining, and operating these significantly more sophisticated systems. \*

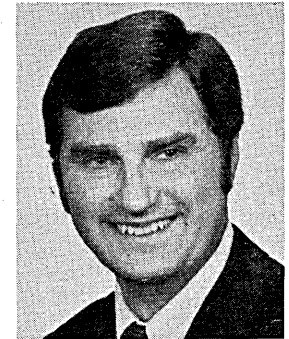

Mr. Pullen is presently the director of the systems industry program at Gnostic Concepts. From a start as a software manager for on-line products at Control Data Corp., he moved to his present post after stops as director of on-line product development for Standard & Poor's, manager of systems development for Memorex, director of the computer services program for Quantum Science Corp., and director of marketing for Remote Computing Corp.

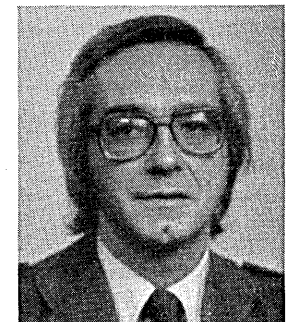

Vice president of Gnostic Concepts, Inc., Mr. Simko has had over 17 years experience in the electronics industry. His positions, prior to the founding of Gnostics, included terms as marketing manager for Quantum Science Corp. and for Fairchild Camera & Instruments, as vp of marketing for Atlantic Semiconductor, and as a salesman of semiconductor products for Texas Instruments.

ORGANIZATION CHART OF INFORMATION SERVICES DEPARTMENT

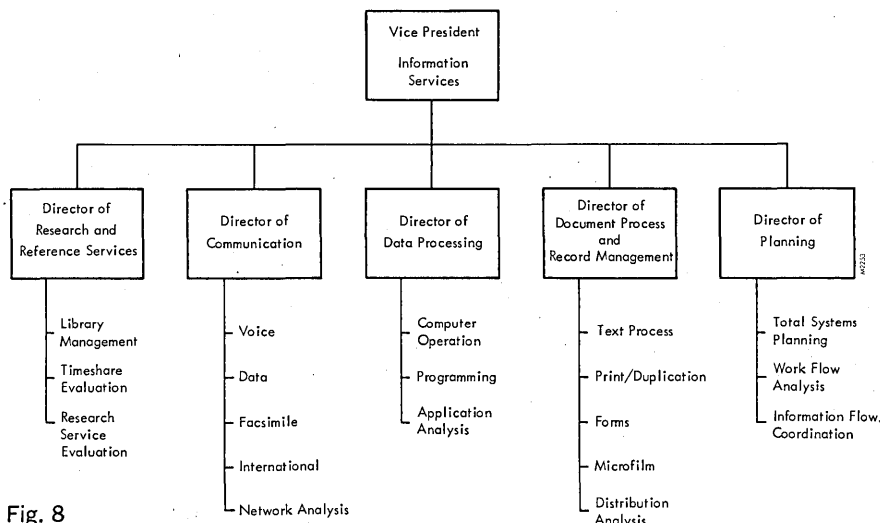

Fig. 8

# Computer Wishlist

by Angeline Pantages, Associate Editor

What is the greatest contribution the computer could make to the well-being of the world we live in?

One evening this winter, a group of our friends—a kind of international round-table including a Dane, an Australian, and Americans of highly mixed origins—heatedly discussed what computers should and shouldn't do, had and hadn't done. Organized crime was no doubt the biggest user, we laughed. Was payroll processing the greatest contribution, we asked cynically? What about getting to the moon? . . . A quote flashed through my mind: "How like you man, so wantonly perverse, De-feated here, you seek the universe," (Irwin T. White, "Rags of Reason").

But, we all wondered, where was the dream, here, now and for tomorrow? Had the visionaries of earlier years gone into hiding? Nagged by the questions, we set out in search of answers, asking dozens of industry figures around the world:

What is the greatest contribution you hope the computer industry will make to the well-being of the world we live in?

Computer scientists, educators, executives, users, and consultants wrote back. They told us about the industry's ills and then they spilled out the ills the industry could help correct. Here are a few of the responses.

"Sharing was never the Viking way; tyrannizing the world with their special way of life was. We, as members of the data processing community, could contribute more by dropping our Viking manners and sharing with others the computer and potential for human progress—lest we too go down in history having contributed only a few runes, some bloodthirsty raids, and 'skool.'" Flemming J. Jensen, The Copenhagen Group, Copenhagen, Denmark.

Dr. Richard Tanaka, president of



Illustration by SUSAN ANSON, Joan Lesser/Ercetera

the International Federation of Information Processing Societies, put his finger on what has shaped these "manners": "A decade ago, it was easier to foresee how computer technology might help shape a better world. Our hopes were higher, our optimism less bounded, our confidence was less shaken. Since then, events—mainly political and economic—have reminded us of the limitations of even as powerful a tool as the computer. While the technology continues to improve, and the means become more available, the imagination and resolve to use them seem to be diminishing. Perhaps in becoming a mature industry, the computer field has also become content to define only limited goals for itself.

"My hope for the computer industry is that it will once again recognize the profound effect it can have on solving the basic problem of our society and set out to do so."

Some respondents have good ideas, good hopes for what must be done. If they are not all new, they bear repeating while they remain unfulfilled. The themes of these wishes revolve around:

*The individual—mind, spirit.* "I would wish that hardware and software technology would keep converging until the computer turns out to be not only a logical power amplifier, but also an intellectual power amplifier—or why not a moral power amplifier?" Dr. Charles Corge, Vice President, Cercle des Utilisateurs de Matériels CII, Le Chesnay, France.

*Man in relation to man.* "I hope that the development of computers will increase the thinking power of the people to such an extent that they will become clever enough to realize how stupid it is to have so many weapons and borders on this small green planet." Prof. Dr. Blagovest Sendov, Computer Scientist and Rector of Sofia University, Bulgaria.

*Man and machine.* "Let the computer be attending to the man and not the man to the computer. Why this wish? Due to the difference of wages between rich and poor countries, when a computer takes the place of 10 clerical workers (in the U.S.), it takes the place of about 120 in Tunisia and 580 in Dahomey, for the same cost. Implementing equipment too quickly in a poor country leads to unemployment and undervalued currency . . . overburdening the poorest.

"It is, of course, easier and quicker to build up machines rather than train people. And it is expensive to conceive machines that take into account the man who is trying to use them . . . (The problem is that) research on logical principles underlying data processing organization is not being developed

as rapidly as techniques and technologies. The subject of edp teaching is not well enough expanded.

"To realize my wish, it would be necessary to carry out studies about these data processing principles, to develop the training of all classes of persons concerned with the use of computers, to thoroughly analyze man-machine dialogue, and finally to introduce the new tools carefully." Jean Dominique Warnier, Manager, Data Processing Logic Section, CII-Honeywell Bull, Paris, France.

*Man and his environment.* "In this time (the main problem) is the correct use and distribution of world resources in order to obtain a more balanced development, both natural and human. It is not a simple task. It requires a radically critical re-thinking not only of the use of computers, but also of many aspects of human activity, especially in the business world." Carlo Peretti, Managing Director, Honeywell Information Systems Italia, Milan, Italy.

*Technological solutions.* "Our society today is faced with an increasing number of critical problems. In the fields of education, medical care, energy, pollution control, cost controls, transportation, postal service, etc., conditions worsen each year. Conventional approaches to solving these problems are not working. Gradually living standards must come down unless more productive solutions can truly be found. A careful look at the basic requirements of each of these fields reveals that a major factor in each is the need to communicate with other people.

---

Every Man Shift for All the Rest, and Let No Man Take Care for Himself.

—*The Tempest*, William Shakespeare

---

"The ability to produce a media to communicate is increasing in our field at geometric rates. Unlike any other area, the cost is coming down in the same geometric rates as the capability is rising. It will be economically and technically possible to link homes, offices, hospitals, schools, government services, private services together with a broadband communication capability. I know of no other area today which offers such an enormous potential for the increased productivity needed to solve major problems.

"The need to take advantage of this capability may become a requirement rather than just an opportunity.

"My wish for the future is that our industry will respond and make this communications capability available to our country. A serious consideration of the real issues makes a potential

competitive battle between even large companies as IBM and AT&T trivial." Sam Harvey, Management Council, Haddonfield, N.J.

*The excerpts that follow take up these themes, adding variations that are significant to the author's political environment, business viewpoint, or sheer imagination. (We take the liberty of adding quotations from authorities outside the field.)*

"I feel confident that over the next quarter century, computers will lose that 'aloofness' from everyday life they had in the past and still have partly today. What I mean is a world in which the computers are no longer a tool for specialists only, no longer a tool even physically segregated in an environment that recalls science fiction stories. I expect computers to be scattered around in all places where we usually live—not only in offices and factories, but even at home . . . accessed by everybody for business, social needs, and leisure time." Dr. Marisa Bellisario, Director of Planning, Olivetti & C., S.P.A., Ivrea, Italy.

*For another writer, that dispersal of computer power would give individuals "enough information, and consequently the means they do not have today to manage their own lives. If the State does not interfere to keep for itself the power which comes from the availability of computers, I foresee . . . the advent of independent 'isoinformed' groups (i.e. having the same level of information) recovering the freedom to act and cooperate, which was taken away some decades ago by centralizing governments. This would be a step towards a new independence of small communities (town, companies, associations)." Robert Guillaumot, President, Inforama, Paris, France.*

*To achieve that dissemination of information, it follows that industry must: "Lower the cost of communication tenfold on a global scale by 1985. It is my hope that we will ultimately dispense with private customized networks for each application and substitute public networks into which terminals or a computer plug in directly. These universal networks will possess the requisite intelligence to recognize a large variety of signals and to deliver the messages in the most cost-effective way possible. The networks will drastically simplify the burdensome and expensive improvisations we use today. . . ." Paul Strassman, Director, Administration and Information Systems, Xerox Corp., Stamford, Conn.*

*If men are to communicate across boundaries: "I wish that we could come up with a pocket-size bilingual translator that would help people who don't understand each other's languages talk to each other. The device would have a speaker and pronounce*

in the other language the translation of the words and phrases that were entered into it. . . . With every pocket translator, there should be a warning that the device has certain limitations, that it does not substitute for good will, that it cannot translate subtle shades of meaning. . . .

"To me, languages are a formidable barrier to international, interpersonal communications, a necessary condition for understanding and cooperation between people from different cultures. So I wish we could have a machine that would help us get over that barrier." Robert Forest, Forest & Eyer, Sparta, N.J.

---

If one man offers you democracy and another offers you a bag of grain, at what stage of starvation will you prefer the grain to the vote?

—Nobel Prize for Literature acceptance speech, 1950, Bertrand Russell

---

"The computer's greatest potential contribution in the last quarter century is directly related to society's greatest identifiable requirement—the more efficient distribution of natural and processed resources to more adequately supply man's fundamental and basic needs. These prime needs included food, housing, education, and health services.

"Computer systems . . . will contribute to the management of food growth as well as to the design of more efficient food distribution systems. They will provide for optimal utilization of the earth's natural resources, as well as plan the most efficient balance of food consumption to provide for maximum nutrition. They will aid in the search for new food sources as well as maximizing the yields from each arable acre. . . ." John Butler, Vice President and General Manager, Univac European Division, London, England.

*For each worthy application, there is software needed.* "Lower the cost of application software development fivefold by 1985. I would like to see a structured application definition process which would automate most of the time-consuming process of user specification preparation, application documentation generation, program definition, and program testing. . . . This new development system would be a large, comprehensive computerized procedure that would standardize the systems analysis and programming methodology so as to make it an industrial process rather than an artisan creation." Paul Strassman, Xerox Corp.

"The remarkable growth of the computer systems industry is due pri-

## WISHLIST

marily to two factors: The industry has given its customers substantially more in benefits than it has charged for its equipment and services. Each year it has developed new ways to improve the cost performance of its products. The greatest contribution . . . is to continue doing those two things well. When we do so, productivity is increased and the public benefits—in both an economic sense and social sense. . . .

"As only one example, today's microprocessor-driven terminals are dramatically improving the speed and accuracy of transaction processing in retail stores, in banks and thrift institutions, and in factories, hospitals, schools, and government offices. . . ." William Anderson, Chairman, NCR Corp., Dayton, Ohio.

*Whatever has been done, for the user there is more to be done.* "I would like to see: (1.) a universal standard for the interface of transaction applications similar in broad concept to the CODASYL recommendations for data base . . . (2.) a universal standard for

hardware interfacing. This would give the long suffering user the ability to weigh-up prices and services rather than trying to balance extravagant claims for total hardware systems . . . (3.) the "house brick" mass random access medium (or LEGO brick even better) which I can add to the hardware system in much the same way as a child builds a wall, and consign the reels of tape, disc packs, and drums to the museum." Philip Fellows, Director, Management Services, Vickers Engineering, Newcastle, England.

The power of science has no known limits. We were told that faith could move mountains, but no one believed it; we are now told that the atomic bomb can remove mountains and everyone believes it.

—*Impact of Science on Society*, 1951,  
Bertrand Russell.

"In the civilized Western world, societies are built on our respect for a compliance with codes of ethics and bodies of laws that have evolved over

the last 2,000 years. It is my hope that the computer can contribute to greater understanding of our laws and assist in bringing greater justice and peace . . . by making possible better and faster judicial processes. . . ." Isaac Auerbach, President, Auerbach Publishers, Pennsauken, N.J.

"If our world is to survive, man must behave rationally toward 'Spaceship Earth' and toward his fellow human beings. The computer can be an instrument of rationality by bringing information to decision-making. . . ." Paul Armer, consultant on social implications of computers, Menlo Park, Calif.

"Regardless of whether one wishes the computer to remove the dull work from our daily lives (for which rational and human systems are simply necessary); or looks at the steadily multiplying efforts of an ever increasing number of professional programmers; or whether one is of the opinion that standardization is a little known concept in the computer industry; or whether one wants tools for measuring how effectively his systems devices and applications packages are being used; it all comes down to cost-effective computing systems." Dr. C. J. M. Aarts, Director, Sciences Faculty, Katholieke Universiteit, Nijmegen, Netherlands.

If to do were as easy as to know what were good to do, chapels had been churches and poor men's cottages princes' palaces.

—*The Merchant of Venice*,  
William Shakespeare.

"The greatest contribution . . . is to contribute more. For example, all of us in the industry agree that a large amount of the available computing power is unused. Could not we smaller organizations . . . make some of our unused resource available to worthwhile research or social projects which . . . simply cannot afford to purchase the necessary facilities? It could be that the free computerization of routine administrative tasks for some voluntary charitable organization could free their workers to concentrate . . . on more productive functions.

"On a large scale there are national and multinational corporations, governments and governmental agencies. Could not they deploy a small part of their under-utilized capability, their manpower highly skilled in operational research, modelling, statistics, systems analysis and programming, their data transmission facilities—to speed research into the total environment . . . ?" William Smith, Manager, Saint Andrew Computers Ltd., Edinburgh, Scotland.

*Couldn't they? Couldn't we?* ❄



"Have you noticed that as these things work faster and faster, we finish our day's work earlier and earlier?"

© DATAMATION ®

# If you're designing a system to run NonStop™—

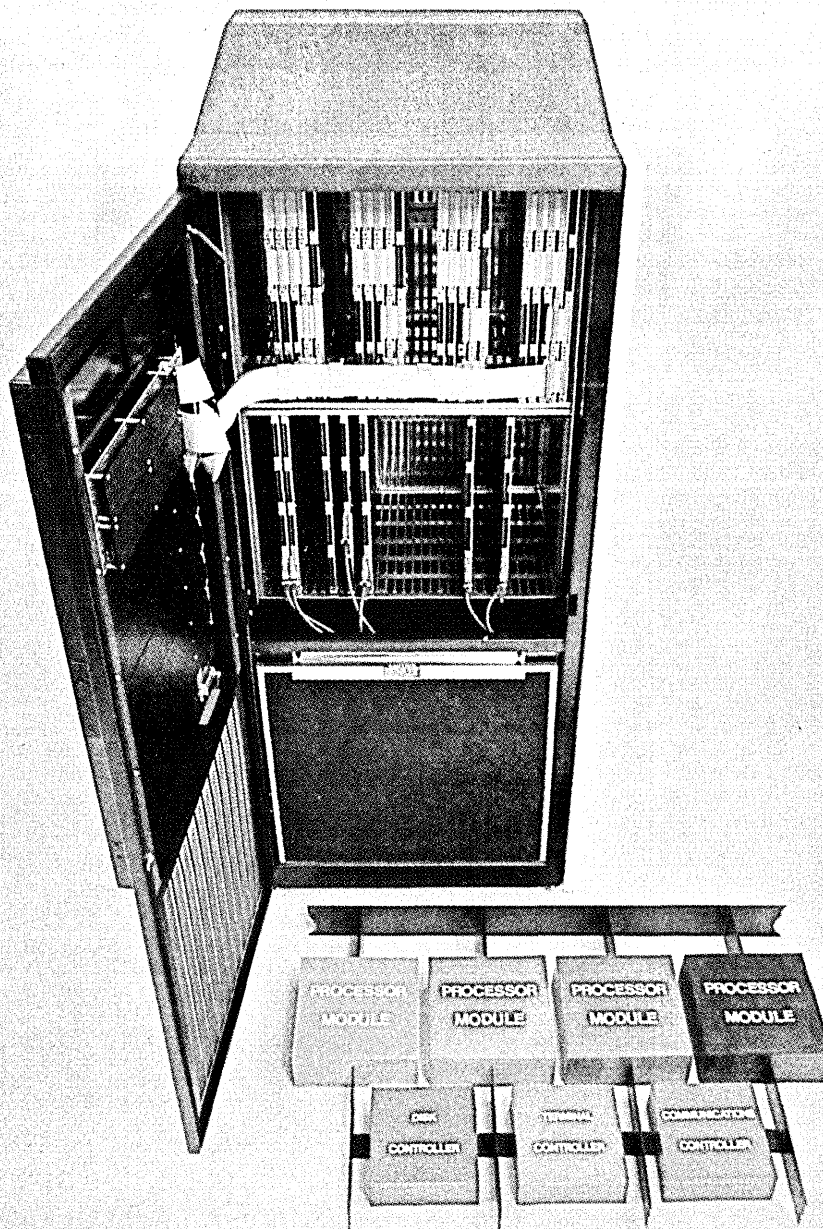

## stop!

### **Don't Tie Your Terminals To A Single Processor System—Give Your Customers Tandem NonStop™ Performance!**

The Tandem 16 is a true multiple processor system that won't shut down with component failure. Any failure that occurs can be repaired without shutting down the system; and, a failure in one module will not contaminate data in another module or cause deterioration in the data base.

The diagram illustrates Tandem modularity and how multiple processors can be added to increase capacity as needs grow. Existing hardware and software are retained, and additional processors can be added without interrupting system operation!

Banks, distributors, credit card processors, transportation companies—anyone needing uninterrupted on-line transaction processing will be delighted with the Tandem 16 NonStop system performance and economy. Someday, all on-line transaction processing will be handled by multiple processor systems that won't shut down! Someday is today! Tandem is doing it right now, with multiple processor systems starting under \$80,000. Tandem Computers, Inc., 20605 Valley Green Drive, Cupertino, Ca 96014, or Tandem Computers, Inc., GmbH Bernerstrasse 50A Frankfurt 56, Germany.

Call Sam Wiegand, VP Marketing, at 800-538-9360 for more information about the computer that won't shut down!

# TANDEM

CIRCLE 63 ON READER CARD

# 1-(800)55

**CALL THIS  
NUMBER AND FIND  
OUT HOW MORE  
THAN 1,500  
UCC INSTALLED  
SYSTEMS HAVE  
SOLVED PROBLEMS  
WORLDWIDE.**

**TAPE MANAGEMENT:** UCC ONE's 500 installations represent over 75% of all installed OS tape management systems. UCC ONE manages your tapes and protects valuable data from loss or destruction. It provides real-time tape status. Eliminates costly, handwritten records and the expensive mistakes they breed. Gives you better control and greater efficiency. Circle 5

**DOS UNDER OS:** UCC TWO lets you continue to use your DOS programs—without reprogramming—while you convert to OS. You plan the conversion or consolidation to fit your work schedule, instead of the other way around. You can consolidate your DOS operation into your OS/VS environment today. Or, you can spread the conversion—and the costs—over months. UCC TWO is the best path to OS and our 500 installed systems prove it. Circle 6

**DISK MANAGEMENT SYSTEM:** UCC THREE/ADAM solves the problem of disk fragmentation and inefficient DASD space usage. Based on user specifications, it automatically scratches unneeded, unused and invalid data sets. Or it

# 27-3250

will migrate the data sets to tape, based upon any combination of criteria — such as usage frequency, size and retention period. Then, UCC THREE keeps the problem from recurring by controlling data set allocation. Fragmentation and the need to periodically compress packs is reduced. Accurate reports on your current space utilization are produced. Circle 7

## **PDS SPACE MANAGEMENT:**

UCC SIX is the only software package that eliminates PDS compression — because it automatically inventories and controls PDS disk space. It spells the end for ABENDS and “dump and restore” operations caused by exhausted PDS disk space. You even save money on your disk investment, too. Circle 9

## **IMS DATA DICTIONARY/**

**MANAGER:** UCC TEN accounts for two out of every three IMS data dictionaries in use today. You can put your finger on the information you need — quickly and precisely. You can manage and control your data base environment. Now, at last, you can get the benefits you expected from IMS. Circle 24

## **RESTART MANAGEMENT:**

UCC FIFTEEN lets you restart at the proper job step — instead of at the beginning. The OS catalog is corrected, unnecessary direct access

data sets are deleted, and GDG biases are properly altered for the rerun. Automatically — so manual errors in restarting and rerunning are eliminated. Circle 131

**FINANCIAL SOFTWARE:** The UCC General Ledger/Financial Control System is the most advanced and complete system of its type. Full general ledger accounting. Budgeting. Cost allocation and profit center reporting. Optionally generates over 100 standard reports. Plus, it has an easy-to-use report writer that the Accounting Department can use — with a minimum of EDP assistance. Circle 132

**SUPPORT:** It takes more than code to make a good software product. It takes dependable, long-term maintenance and support of those products. Users of over 1,500 installed systems will tell you that is what UCC delivers.

# **UCC**

USA: P. O. Box 47911 — Dallas, Texas 75247  
Canada: 101 Duncan Mill Road — Don Mills, Ontario M3B1Z3  
Europe: 1258 London Road — London, U.K. SW16 4EG

We're helping  
the computer to do  
more of the work.

# WHEN IT'S FINALLY ON THE SCREEN, YOU DESERVE FAST HARD COPY.

Could's electrostatic printer/plotter is the fastest graphic hard copy peripheral available today for your Tektronix 4000 Series interactive graphic terminal. You get permanent graphics direct from the

terminal in as little as 4 seconds, regardless of image complexity. In an on-line CPU configuration, you can plot at up to 3.25 paper in./sec. and print at up to 1600 lines per minute.

Yet Could's hard copy still possesses exceptional resolution and extremely high contrast. Only Could offers you both unmatched speed and unsurpassed image quality.

And Could lets you select a 0° or 90° image orientation at will. In 90° mode, images are enlarged

up to 72%. You are able to select 1024 or 2048 point sampling and high or low speed graphic operation, letting you optimize image size, resolution and speed.

As with all Could systems, your software is all-Could. You never need worry about third party variables.

Could images don't deteriorate. The system requires no warm-up. Could paper costs a fraction of silver paper. Up to 2 interfaces are accommodated in the plotter, allowing you to use it with up to 8 Tektronix terminals or 4 terminals and a minicomputer, or 2 mini-computer CPUs.

Your CRT work deserves the best hard copy you can get. You get it from Could.

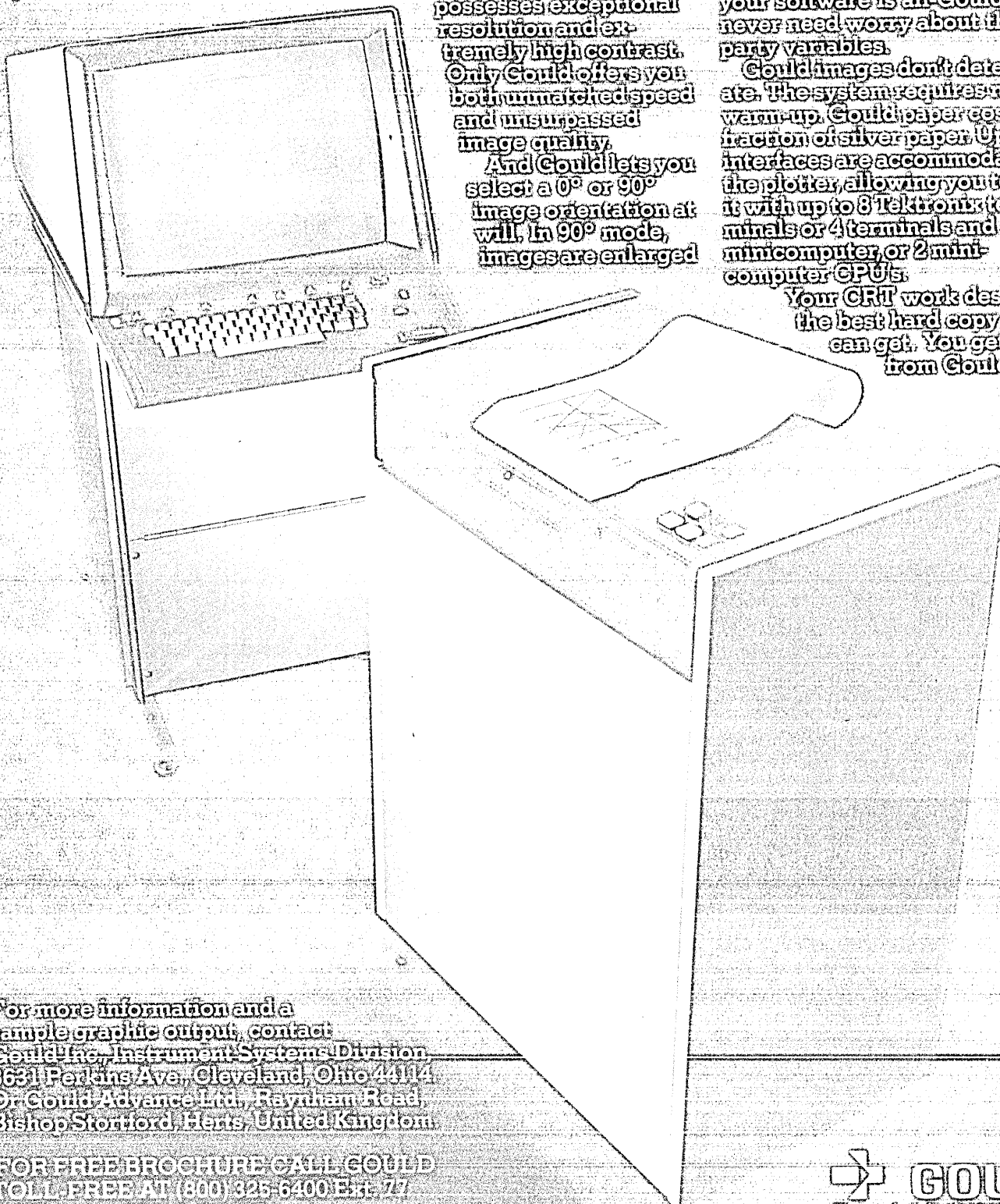

For more information and a sample graphic output, contact  
Could Inc., Instrument Systems Division  
3631 Perkins Ave., Cleveland, Ohio 44114  
Or Could Advance Ltd., Raynham Road,  
Bishop Cleeve, Leics, United Kingdom.

FOR FREE BROCHURE CALL GOULD  
TOLL FREE AT (800) 625-6400 EXT. 777  
In Missouri (303) 342-6600

 **GOULD**  
The product development company



# EFT In 1988

It all started in 1977 as a simple government attack on inflation.

Let's assume that Congress is doing the planning for us and that our representatives legislate into existence a nationwide electronic funds transfer system.

Advance the clock to November 1988 and briefly review the events of the previous 12 years to see the results of instituting such a system. In January 1977, a newly elected President and Congress went into action. By the Fall of 1977 much talk was generated regarding an Income Maintenance Program. After the economy had recovered from the Recession which followed the energy crisis of 1973, the Gross National Product moved upwards again. First, the GNP rose at a good rate, but soon it settled at a level of 3.8% per year. Inflation also was growing, but at a rate of 8% per year.

This inflation impacted more heavily those items dependent on oil. By late 1978 gas prices broke the psychological barrier of \$1.00 per gallon, which affected transportation. Plastic and synthetic fibers had increased in price by 350% since 1973 and impacted a long list of household items plus clothing. The cost of fertilizer moved upwards each year and directly impacted the cost of our groceries and meat products.

In general, while income increased considerably for some Americans, the number of people classified as poverty cases reached a level of 25% of the total population. There was no question in anybody's mind—at least in the minds of those 25% of our population—that something had to be done.

As always, our politicians had the answer: an income maintenance program providing people a minimum income.

How would it be financed? A tax was imposed on people whose weight exceeded standard weight table figures by 10 pounds. This tax was known as the Food Allocation Tax (FAT). It was

intended to achieve these benefits:

(1) To lower food consumption so that our nation could increase its food exports to overcome the large balance of payments deficit incurred as a result of our substantial oil imports. And (2) to create a healthier population, thereby reducing the tax burden required to support the National Health Care Program.

In October of 1979, the President signed into legislation the now famous Compensation Distribution Act. It was this legislation which finally guaranteed each American a minimum income tied to the cost of living index.

## Direct deposits

The U.S. Postal Service was designated to set up the system, and soon recipients received their payments through electronic transfers directly into the bank accounts, using the EFT system.

Social Security, welfare and supplemental Social Security were added. Soon, National Health Care payments were incorporated.

By the middle of 1980, point-of-sale terminals were widespread. And in early 1981, a truly nationwide system was in place. A very large segment of our population purchased all goods through their debit or asset cards.

As we entered the decade of the '80s, Postal Service personnel responsible for this system found an ever increasing number of people collecting a guaranteed minimum income. And the suspicion grew that more and more people were not reporting their income honestly.

*These thoughts were first presented at the recent Info 76 conference in Chicago, where the author suggested that we'll never see a nationwide Electronic Funds Transfer System. With tongue in cheek he tells why here.*

## New ID proposed

It became quite obvious that a new method of identification was needed. The Internal Revenue Service recommended that the Social Security Number be used, since its tax records were kept in this fashion. The Social Security Administration objected. Unfortunately the director of Internal Revenue couldn't be dissuaded and in November of 1981, the Social Security Number became the sole identifier.

In September of 1982, Congress gave Postal Service personnel the tools for better control by passing a new law—the All Income Reporting Act, which mandated that all payments of \$5 or more by anyone to anyone had to be made through an EFTS terminal.

The Postal Service computer experts were asked to develop a system which would greatly improve their ability to catch tax evaders. The system became known as Tax Evader Real-Time Appraisal Program (TRAP). It was implemented in May of 1983. (By the way, it was at this point that people began referring to EFTS as "everybody's federal tax system.")

As we entered 1984, many payments continued to go to people who were in fact ineligible. The IRS was really getting tough. Audits were widespread because the IRS contended that all these people were tax evaders. The number of court cases grew steadily. There was one consolation, however. It finally became obvious that the former director of Internal Revenue was responsible for the situation that had arisen, since he had paid no attention to the warning about the use of Social Security Numbers. Undeniably there were many duplicate numbers and multiple card holders.

## 22-digit ID

A crash program was mounted. In early 1985, the conversion to a new 22

## EFT IN 1988

digit ID number started. Its design made it unique. It could even be used worldwide.

With the implementation of the new national ID system, Postal Service and IRS personnel were happy that a system had finally been developed which made it easy to find all evaders. (At this point, the collection of all census data was added to the system. The combination of the new ID number and the touchtone telephone, which everybody had by then, made this a feasible adjunct. Data for the first mid-decade census was obtained through this method.)

As Congress watched the constant addition of new modules to the EFT system, fear began to mount concerning the consequences of a major system failure. A Postal Service computer technician was requested to express his expert opinion with regard to this possibility. Without hesitation, he stated that the chances of a major system failure were one in one million.

With those odds, no one worried.

In late 1985, the system had finally settled down and the personnel of different government agencies found some time to review the mass of new data that was available through the system. In early 1986, statistical runs revealed some strange patterns. Grocery purchases by self-employed persons—such as barbershop owners, carpenters, doctors, etc.—followed different patterns

than those of salaried employees. The former group showed unusually low increases, while the salaried category was growing at a very steep rate.

Teams of experts were brought in to analyze this data, but they couldn't figure out what these findings could be attributed to.

### Barbershop incident

By coincidence, the director of Internal Revenue was sitting in a barber-shop waiting for a haircut when the fellow ahead of him got up and handed the barber a bag and walked out. As the director was having his hair cut, he got into a conversation with the barber and asked him about the bag. The barber laughed and said, "Don't you know about the merchandise exchange scheme to bypass the EFT system and save on taxes? It's commonly referred to as MESS—for Merchandise Exchange Savings Scheme."

The barber's comment triggered an investigation into this MESS. It was found to be very widespread.

The postal service and IRS didn't lose any time. They immediately established new parameters for audits. In essence, all given expenditures were analyzed against average expenditure patterns for this particular income category. Anyone falling outside certain established ranges was subject to audit. For example, if one family spent more in groceries than others of the same size and income, this family would be under suspicion for being part of the Merchandise Exchange Savings Scheme. Conversely, people

who spent very little in this category were pegged for audits on the basis that they were receivers in the merchandise exchange approach.

After several embarrassing court cases, Congress finally excluded liquor purchases from the system to assuage abstainers who protested vehemently that under-consumption of liquor was being looked upon as a criminal act by the IRS, since abstainers always fell outside the established pattern.

An edict went out to stop the "MESS." This called for a new program which appropriately was called "STOP," for Sensible Transaction Observation Program.

It did the trick.

The merchandise exchange scheme was wiped out in 1987. Everything was running very smoothly with the single large exception of several court decisions in connection with damage suits brought against certain computer specialists for gross errors committed in earlier years. These found their ways through the appeals courts to the U.S. Supreme Court.

### Unthinkable happens

On Nov. 9, 1988 the unthinkable happened and major systems failure occurred. The Postal Service computer expert who had said that the chances of a large systems failure was one in one million had retired only nine days ago. He was in a boat somewhere in the Gulf of Mexico and couldn't be reached. To avoid panic, the President addressed the nation and introduced the CIA director, a Ms. Trust. The director announced that there was no cause for alarm.

Since 1978, the CIA had been concerned that an enemy power could cause tremendous damage to the welfare of this country if the then simple system were put out of commission. Therefore, the CIA, whom no one would ever suspect of being involved in any domestic eavesdropping system, became the logical choice for the establishment of two backup systems.

All data was transferred to one of these systems and within six hours, the whole complex was back in operation. The years of strategic planning, pre-planning, and contingency planning, and post, post planning reviews had really paid off.

Well, I notice a tremendous relief on your part. You probably never thought the government capable of planning so meticulously. Or would you call this planning? I'm sure you well know that the series of events I have described could never happen. Right? \*

—Oliver J. DeSofi

Mr. DeSofi is the vice president of the data processing division of National Bank of North America.

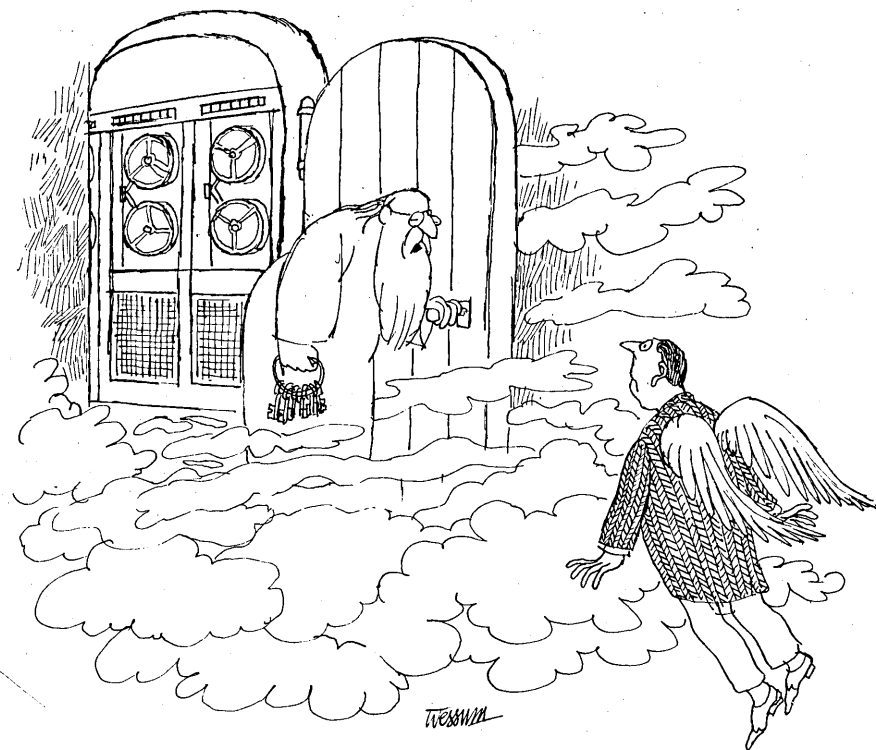

"Sorry, but I'll have to check on you. What is your Social Security number?"

© DATAMATION ®

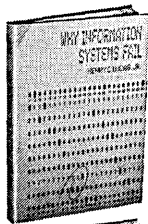

767/130  
**WHY INFORMATION SYSTEMS FAIL**  
by H. C. Lucas, Jr.  
Pub. price, \$11.00  
Club price, \$8.95

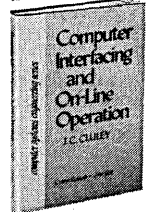

767/017  
**COMPUTER INTERFACING AND ON-LINE OPERATION**  
by J. C. Cluley  
Pub. price, \$14.50  
Club price, \$12.35



768/528  
**DATA PROCESSING SYSTEMS ANALYSIS AND DESIGN**  
by R. J. Condon  
Pub. price, \$13.50  
Club price, \$10.75



766/479  
**THE U.S. COMPUTER INDUSTRY: A Study of Market Power**  
by G. W. Brock  
Pub. price, \$15.00  
Club price, \$12.50

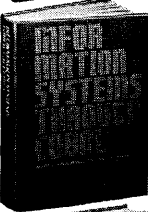

497/672  
**INFORMATION SYSTEMS THROUGH COBOL**  
by A. S. Philippakis and L. I. Kazmier  
Pub. price, \$12.95  
Club price, \$9.95

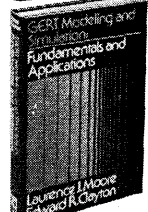

768/870  
**GERT MODELING AND SIMULATION: Fundamentals and Applications**  
by L. J. Moore and E. R. Clayton  
Pub. price, \$15.95  
Club price, \$13.25

## Introductory offer to new members of the COMPUTER PROFESSIONALS' BOOK CLUB

any one of these great professional books for only **\$1.00** values up to \$29.95

Special \$1.00 bonus book comes to you with your first club selection

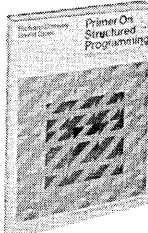

768/79X  
**PRIMER ON STRUCTURED PROGRAMMING: USING PL/I, PL/C, AND PL/CT**  
by Richard Conway and David Gries  
Pub. price, \$8.95  
Club price, \$7.50



767/203  
**DATA PROCESSING MANAGEMENT: Methods and Standards**  
by D. H. Brandon, A. D. Palley, and A. M. O'Reilly  
Pub. price, \$29.95  
Club price, \$21.50

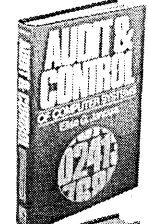

768/269  
**AUDIT AND CONTROL OF COMPUTER SYSTEMS**  
by E. G. Jancura  
Pub. price, \$13.95  
Club price, \$11.75

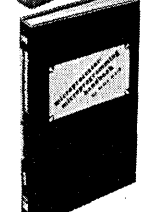

768/749  
**MICROPROCESSOR/MICRO-PROGRAMMING HANDBOOK**  
by B. Ward  
Pub. price \$9.95  
Club price, \$8.45



768/714  
**APPLYING DATA STRUCTURES**  
by T. G. Lewis and M. Z. Smith  
Pub. price, \$15.95  
Club price, \$12.25

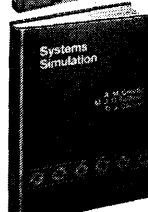

766/053  
**SYSTEMS SIMULATION: Methods and Applications**  
by A. M. Colella, M. J. O'Sullivan and D. J. Carlino  
Pub. price, \$16.00  
Club price, \$12.95

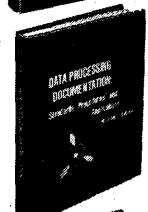

767/092  
**DATA PROCESSING DOCUMENTATION: Standards, Procedures, and Applications**  
by W. L. Harper  
Pub. price, \$22.95  
Club price, \$17.50

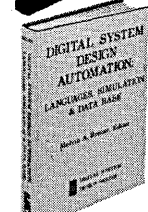

768/498  
**DIGITAL SYSTEM DESIGN AUTOMATION: Languages, Simulation, and Data Base**  
by Melvin A. Breuer  
Pub. price, \$18.95  
Club price, \$15.95

### save time and money by joining McGraw-Hill's new **COMPUTER PROFESSIONALS' BOOK CLUB**



**T**his new professional club is designed to meet your day-to-day on-the-job needs by providing practical books in your field on a regular basis at below publisher prices. If you're missing out on important technical literature—if today's high cost of reading curbs the growth of your library—here's the solution to your problem.

The Computer Professionals' Book Club was organized for you, to provide an economical reading program that cannot fail to be of value. Administered by the McGraw-Hill Book Company, all books are chosen by qualified editors and consultants. Their understanding of the standards and values of the literature in your field guarantees the appropriateness of the selections.

**How the Club operates:** Every month you receive free of charge *The Computer Professionals' Book Club Bulletin*. This announces and describes the Club's featured book of the month as well as alternate selections available at special members' prices. If you want to examine the Club's feature of the month, you do nothing. If you prefer one of the alternate selections—or if you want no book at all—you notify the Club by returning the card enclosed with each *Bulletin*.

As a Club Member, you agree only to the purchase of four books (including your first selection) over a two-year period. Considering the many books published annually, there will surely be at least four you would want to own anyway. By joining the club, you save both money and the trouble of searching for the best books.

### MAIL THIS COUPON TODAY

COMPUTER PROFESSIONALS/Book Club  
P.O. Box 582 Princeton Road, Hightstown, New Jersey 08520

Please enroll me as a member and send me the two books indicated. I am to receive the bonus book at the introductory price of \$1.00 plus my first selection, plus tax, postage and handling. If not completely satisfied, I may return the books within 10 days and request that my membership be cancelled. If I keep the books, I agree to take a minimum of three additional books during the next two years at special Club prices (guaranteed 15% discount, often more). I will receive the Club Bulletin 12 times a year. If I want to examine the featured selection, I need take no action. It will be shipped automatically. If, however, I want an alternate selection—or no book at all—I simply notify the Club by returning the convenient card always enclosed. I will always have a minimum of ten days in which to return the card and you will credit my account fully, including postage, if this is not the case. Membership in the Club is continuous but cancellable by me at any time after the four-book purchase requirement has been filled. This order subject to acceptance by McGraw-Hill. Orders from outside the continental U.S. must be prepaid. All prices subject to change without notice. Offer good for new members only.

Write Code # of \$1.00 bonus book selection here  Write Code # of first selection here

NAME

ADDRESS

CITY

STATE  ZIP

**EXTRA SAVINGS:** Remit in full with your order, plus any local and state tax, and McGraw-Hill will pay all postage and handling charges. **P39180**

# Introducing three new mini's that think like mainframes.

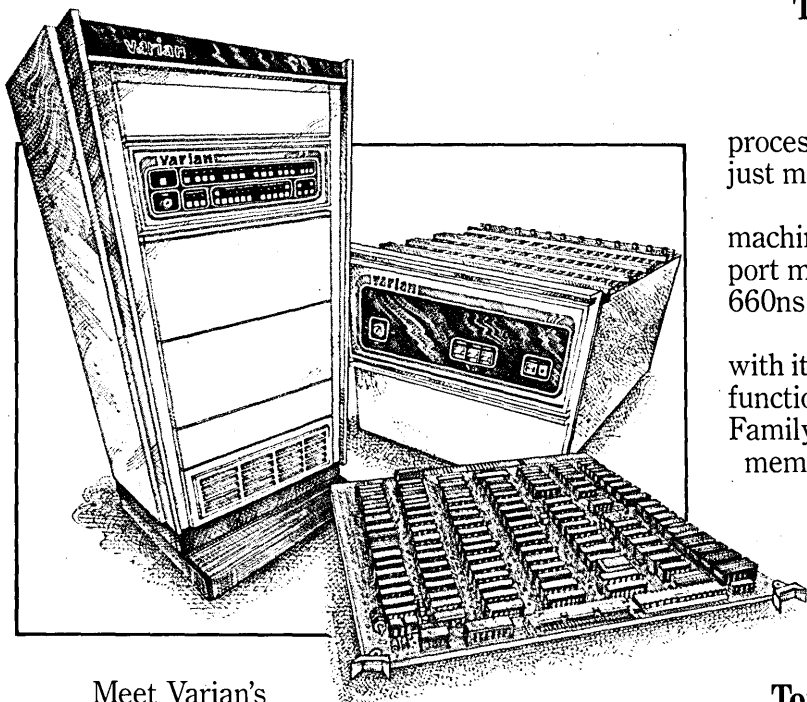

Meet Varian's new V77 Family of high-performance minicomputers.

Three distinctive new models. All fast. Each powerful. A family trio most mainframes can relate to. For help with almost any scientific, industrial, or data communications application.

The V77 Family delivers all the speed and performance you expect from Varian. Plus the unexpected, too. In the form of total family compatibility and shared memory capabilities. Up *and* down the family tree. For complete open-ended flexibility. In capacity and price.

## **The world's first mainframe-on-a-board. Our new V77-200.**

Quite frankly, the new V77-200 delivers more computing power than any other computer-on-a-board you can buy. Handling up to 32K/16-bit words of 660ns MOS memory.

Big machine features include a fully micro-programmed architecture, an 8-register CPU, a 32-bit arithmetic capability, powerful set of 187

instructions, hardware multiply/divide, direct memory access, programmed I/O, real-time clock, and a teletype/CRT controller.

There's big machine performance, too. Example: multiplication functions handled in 4.9 microseconds — divide in just 8.

The new V77-200 means more cost-effective computing in many scientific, instrument control, or data communications environments.

## **The in-between that's a go-between. Our new V77-400.**

If yours is a multiprocessing or distributed processing network application, our new V77-400 just might be "the tie that binds."

Because on top of all its standard big machine features, there's an incredibly flexible dual port memory. (With up to 256K/16-bit words of 660ns MOS memory in a single, standard chassis.)

The V77-400's dual port memory, working with its unique direct memory access system, functions as a bridge when linked to other V77 Family computers in closely coupled, shared memory multiprocessor arrangements.

An optional Writable Control Store is also available. Letting you expand the V77-400's instruction set to further improve the speed of both programming and program execution.

## **Top-of-the-line performance for almost any application. Our new V77-600.**

Varian's new V77-600 sets new standards for all would-be high-performance mini's.

First, with a long list of standard big machine features. Second, with up to 1024K/16-bit words of 660ns MOS memory. And third, with a host of performance enhancing options. Including Writable Control Store, a floating point processor, and special scientific and commercial firmware.

For the ultimate in performance enhancement, an optional high-speed cache memory is also offered — cutting the V77-600's average execution time in half.

## **How our mini's speak fluent mainframe.**

You won't waste any time or money training our new V77 Family how to communicate with your mainframe. Or developing your own control programs.

Because all V77 Family members utilize Varian's VORTEX (or VORTEX II) operating

system — two of the world's best real-time systems.

Both systems permit concurrent job execution by allocating priorities. And help tailor other subsystems to fit scientific to commercial, real-time to batch, and stand-alone to data communications environments.

TOTAL, a highly efficient, network-type data base management system, is now available as a VORTEX II subsystem.

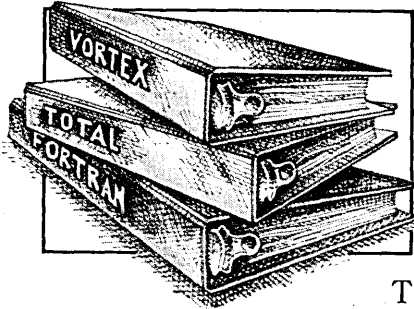

Usually found on only larger computers, TOTAL allows you to define and access your data base with powerful, high-level language processors like COBOL, FOR-

TRAN IV Level G, and RPG-II. Opening the door to large libraries of already developed applications programs.

### The benefits of a well-structured family.

Our new V77 Family represents more than just a continuing commitment to total hardware and software compatibility. Because it's a commitment to solving basic price/performance needs on several different levels.

For those needing more computing power, there's a V77 that's an affordable, high-performance solution.

For those wanting less wasted overhead, there's a less expensive, high-performance alternative.

Plus an attractive new V77 discount plan designed to give even modest-volume OEM buyers a big break.

Finally, for those with special multiprocessing or distributed data processing requirements, there's an entire V77 Family. Specifically engineered to work well

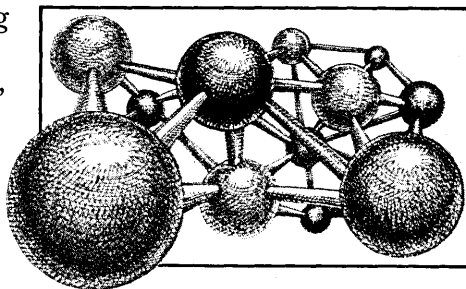

together — through shared memories, intercomputer I/O bus lines, and shared communications channels — as new cost-effective replacements for typical "patchwork" systems.

### Varian. A commitment to innovation.

Varian Data Machines has played a significant role in the evolution of digital minicomputers for almost a decade now.

Consistently producing innovations not only meaningful to the industry, but to the end-user as well. A look at just the last five years tells the story...

In 1972, VDM developed the first minicomputer operating system with all the multi-task and file handling capabilities of a large computer.

A year later, VDM created the first microprogrammed minicomputer with a 65-bit Writable Control Store.

In 1975, two VDM firsts: a minicomputer with a data base management system equivalent to those for large computers, and, the first 64K word semiconductor memory package on a single board.

Today, it's the whole new V77 Family. Well-structured and ready. Breaking new ground in terms of Varian size, compatibility, and price/performance. Three new mini's that really do think like mainframes.

For additional V77 Family planning literature, contact any of the 38 Varian offices listed below, or Varian Data Machines, 2722 Michelson Drive, P.O. Box C-19504, Irvine, California 92713, (714) 833-2400. In Europe, contact Varian Associates Ltd., Molesey Road, Walton-on-Thames, Surrey, England, Telephone 28971.

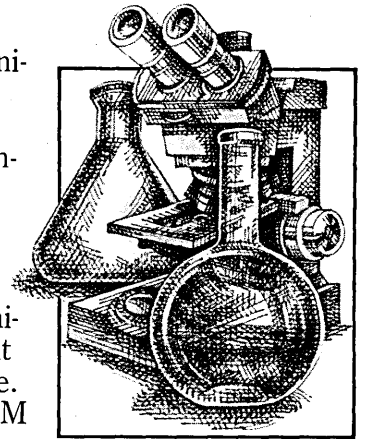

Mini's that think like mainframes.

U.S. OFFICES: Los Angeles (213) 598-4438, San Diego (714) 276-9462, San Francisco (408) 736-5630, Seattle (206) 641-4500, Denver (303) 770-2151, Dallas (214) 231-5145, Houston (713) 781-0105, St. Louis (314) 739-6433, Chicago (312) 692-7184, Detroit (313) 645-9950, Cleveland (216) 238-6960, Orlando (305) 299-1592, Atlanta (404) 252-0047, Washington, D.C. (301) 773-6670, Philadelphia (215) 643-2355, New York City (212) 325-5248, Rochester (716) 586-3273, Boston (617) 890-6072. INTERNATIONAL OFFICES: Brussels (02) 4662000, Darmstadt (06151) 86386, Munchen (089) 8126093, Bensberg (02204) 61066, Amsterdam (020) 15 94 10, Stockholm (08) 820030, Zug (042) 23 25 75, Surrey 093 22 28971, Toronto (416) 457-4130, Montreal (514) 332-2840, Vancouver (604) 736-5621, Ottawa (613) 224-6521, Calgary (403) 276-4456, Melbourne 560-7133, Sydney 43-0673, Sao Paulo (011) 240-3449, Singapore 2352602, Tokyo 403-7101, New Zealand 697-099, Taipei 559082.

# Touching Data

by James K. Johnson, *Midwestern Editor*

Playing touch and go with a terminal can bring reports, projections, survey research, and other information to your fingertips.

Several years ago management information systems were expected to make dramatic increases possible in the speed and efficiency of high level decision making. According to some prognosticators, every manager's office in important corporations would soon have a terminal providing ready access to vital information in every area of operations.

It hasn't quite worked out that way, and the real potential of management information systems is still largely unrealized. At the same time, the amount of information needed to make vital decisions affecting profit and loss has increased with the growing size and complexity of American business.

One of the most important reasons for the slow acceptance of MIS is the "user interface problem." This problem was largely ignored in the euphoria surrounding the early development of MIS technology. However, today we recognize that simplified access to the computer is essential for the widespread use of MIS.

The fundamental problem is getting managers to use the systems; and among businessmen in particular, there is a reluctance to use a keyboard to interface the system. While it is fairly easy to set up programs to retrieve information, it has been very difficult to construct retrieval programs and procedures that are easy to use. Some systems have required an entire book instructing managers on use of the system.

To overcome this deterrent, Red Owl stores, a large Minneapolis based wholesale and retail food and drug chain, is using touch screen terminals to facilitate access to the computer. This is thought to be the first use of touch screen technology in a business MIS system, and the first use of touch screens for any application in the retail field.

Red Owl was plagued by an inadequate data reporting system at a time when the need for information was increasing due to the size and complexity of the company's operations. Faced with this need for more and better information, two alternatives were possible: either develop countless special programs for report generation, or install an interactive system that would enable management to obtain access to all important company information.

A vital factor was the lack of prior

experience with computers and keyboard entry by Red Owl officials. While dp professionals had no qualms about sitting down to a keyboard, general managers without dp experience were reluctant to do so.

The new touch screen system at Red Owl enables the manager to obtain and manipulate information without having to operate a conventional keyboard. It makes it easy for a manager with little or no previous exposure to computers to get and use data for his own purposes. At the same time it takes the shroud of mystery away from computers, a very important factor in the retail field where managers are generally less computer oriented than in other more technical industries.

## What it is

The system at Red Owl consists of a touch screen adaptation affixed over a CDC 211S crt terminal with the keyboard removed (the touch screen performs the function of the keyboard). The terminal communicates with an IBM 360/50 with 512KB of memory, running under DOS, with ten 2314 disc drives. The approximate cost for the crt is \$2,000 and \$1,000 for the touch screen adaptation. However, it took three man-years for system software development and another man-year for the retrieval and projection software portion of the system. The total estimated software cost was about \$80,000.

The project was begun in 1972. Information Dialogues Inc. of Minne-

apolis developed the touch screen adaptation for Red Owl, on what was considered to be an experimental project. (Information Dialogues now produces these adaptations on a limited scale.) The project, after general software development, became operational in late 1973 for corporate planning, and the retrieval and projection portion was operational in early 1974.

There are currently three such systems in use at Red Owl: in the corporate food division's retail operations and financial planning section; in the industrial engineering section; and in the development area, where phone surveys, market research, and other test applications are performed. However, the company, which is located in the Upper Midwest (North and South Dakota, Iowa, Minnesota, Wisconsin, Upper Michigan) and has 380 food stores and 71 "Snyder Drug Stores," plans to provide such systems to its drug subsidiaries and to its district managers for budgeting, information retrieval, and forecasting.

The Red Owl system is used on two levels: one for information retrieval where the touch screen is used simply to get information in and out of the computer. The other is in forecasting and projection.

## How the dialogue works

In both applications, Red Owl managers carry out a dialogue with the terminal. To understand something about the dialogue technique, it is helpful to think of a multiple choice



Fig. 1. The touch screen system in use at the Red Owl chain of food and drug stores is very easy to use, as illustrated by Orville MacDonald, assistant vice president for retail operations. This system is a distinct advantage to managers who do not wish to perform programming or data entry tasks, much less spend the time learning how to do them.

examination. The user is given a question and asked to choose from a variety of answers. For example, in a simple retrieval application the user may be asked:

DO YOU WANT TO WORK WITH A SINGLE STORE OR WITH A GROUP OF STORES?

At the same time he is given a choice of two responses:

WITH A SINGLE STORE  
WITH A GROUP OF STORES

The user indicates his answer by touching the screen at the point where his desired response appears.

The system then returns with the followup questions:

DO YOU WANT THE STORE INFORMATION TO BE TAKEN FROM THE MASTER FILE OR FROM ONE OF THE STORAGE FILES?  
WHICH DIVISION IS THE STORE IN?  
WHICH DISTRICT IS THE STORE IN?  
SELECT THE STORE

When the store has been selected the system asks a different sort of question:

WHAT DO YOU WANT TO DO WITH THIS DATA?

The user is given three choices:

RETRIEVE DATA  
PRINT DATA

#### PROJECT RAW DATA

The dialogue continues as the user defines the time period he would like shown (months, quarters, years, or special periods) and the precise report needed. The user selects the report he needs and leaves the system, indicating his termination of use by touching the screen again. Although the process may sound fairly tedious, most information tasks take less than a minute to perform with the screen.

#### The applications

The system is also used for developing projections, using the Red Owl operating statement as a data base. The statement includes sales figures, gross profit figures, gross profit margins, sales mix changes, as well as store level expenses such as salaries, check losses, utilities, direct store income, and allocated expenses including warehousing, trucking, and administrative costs. In

addition, new data can be displayed by touching numbers shown on the screen.

(To assure that confidential information is not available to everyone, the user must identify himself by means of a code. Users without a personal access code are kept from accessing private data.)

The system can be used to forecast changes in the operating statement based on past levels of sales, profits, and expenses. It is also used in acquisition evaluation to forecast sales and profits expected from the acquired company, taking into account various levels of expenses incurred by the acquisition.

Still another application is the automation of nonmanagerial functions. For example, in a market research use of the touch screen, a phone survey is taken to gain information about consumer awareness and recognition of

## The System's Components

The Red Owl use of touch screens is one of the latest developments in a technology which had its first major application in 1965 when it was used in a developmental air traffic control system in England. Later in the 1960s, Control Data began a project to develop touch screens and related software for use in medical systems applications with the CDC 1700 computer system. (This system was first installed at Promise Laboratories, now a part of the Univ. of Vermont, where it was used by patients, nurses, and physicians for medical record keeping and other purposes.)

#### The screen

The Red Owl terminals consist of an 8" by 10" screen equipped with touch pads. The screen is divided vertically into right and left halves. Each half is overlaid with several  $\frac{3}{8}$  x 5-inch touch sensitive horizontal strips, each separated by a narrow gap. (The strips are made of a clear adhesive plastic overlaying a transparent metallic sheet.)

Next to the terminal is a small box which sends an oscillating current into each strip. When the strip is touched, the flow of electrons across the strip is altered. This change in the oscillating frequency on the pad is detected by the system, and a signal is relayed to the computer. An audio "beep" confirms that contact has been made.

Since the user can touch the strip at any point along its length, the system does not require a great deal of precision.

There are a number of other technologies employed in design of touch screens. Some employ photocells in

an x-y grid. Others use surface waves with echo pulse timers, strain gauges on the display screen, acoustical waves, radio waves, and cross wires. Touch pad terminals were chosen for Red Owl's application since the technology is proven, having been in use for about 10 years.

Other devices such as light pens or joysticks could have been used in conjunction with the display terminal. However, each involves a piece of hardware between the computer and the user. The touch screen is simpler and eliminates the need for training on a separate tool.

#### The language

A control language, together with its compiler, object code interpreter,

and supporting system routines, makes up another component of the system. The language is used by the system designer—not the user—and is intended solely for controlling dialogues. A set of control language instructions is associated with each response available to the user, just as would be required for interpreting and processing commands input through any other medium.

#### The data structure

A data structure, (the frame) organized around a block of information makes up the last component. Frames contain the data to be displayed, their format, control language instructions to be executed, and/or information to be processed.

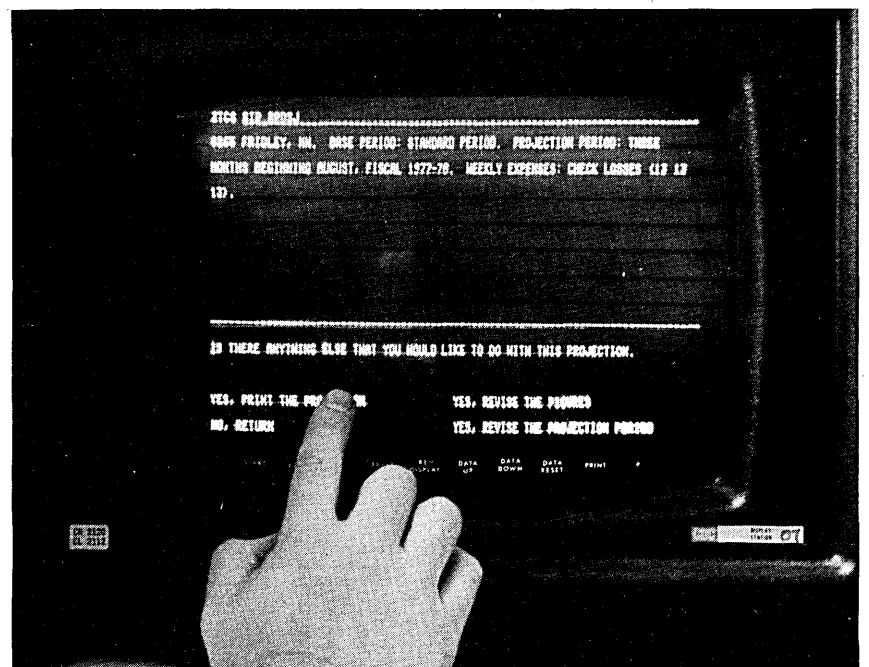

## TOUCHING DATA

Red Owl in specific market areas. People who live in the target market area are called and asked questions about what they think of local grocery stores, including Red Owl.

Questions the telephone operator asks are put on the screen. For instance, the system may display the following question: What supermarkets come to mind when I mention these factors? Operators read the question and the list of possible responses on the phone. Answers are touched on the screen and recorded by the computer. At the end of the week, the data is summarized for the marketing department.

The dialogue approach required extensive new program development; however, the programming technique is fairly simple. To program a typical dialogue, a rough list of questions to be included is written by the programmer. A terminal equipped with both touch screen and keyboard is used to type the first few questions, the associated answers, and some controls to link the questions together. Once a small part of the dialogue has been entered, the programmer tests it using the touch screen, sees whether the questions are properly linked, carefully worded, and if there is a smooth and consistent stream of thought flowing through them.

Often a manager will be brought in at this early stage to examine the questions for clarity. Questions can be easily perfected on the touch screen, and any changes are made immediately. When the programmer is satisfied with the first part of the dialogue, he types in another part and repeats the process. Because of this close relationship between manager and programmer in constructing dialogues, management is assured that it gets the information needed.

### Factors in acceptance

The primary premise of the touch screen approach is that key entry of input data is not an appropriate or desirable task for management personnel. Of course some management officials simply do not know how to use a keyboard and have no desire to learn. The speed and simplicity of the touch screen makes the system simple and even enjoyable for the user.

A second factor in acceptance of the touch screen is the dialogue technique. Since the system guides the user toward the information he seeks by the question and answer process, the user is inclined to view the system as a partner in his problem solving function. This feeling is enhanced by the lack of a mechanical interface in the

form of key entry device between the manager and the computer.

The combination of these two factors makes possible the use of the system without any prior training. Since it is almost entirely self explanatory to someone familiar with the data being retrieved, users are drawn to the system without any of the reluctance or fear of failure associated with a keyboard.

Still a third factor in acceptance of the system is that the user need not be concerned about the technical aspects of how the system works. His mind is free to concentrate on the problem without being concerned about operating the hardware. The manager is able to give his undivided attention to the task and not be distracted by the mechanics of the system.

Clearly the benefits of the touch screen are great, but what of the disadvantages? There are two, both relating to the system's use for projections. The first, and most important, is data entry. In its present configuration, the user must enter information by touching the screen as it displays a series of numbers. The user touches the numbers representing the additional data which are then accepted by the system. The process is tedious and time consuming. In the future, the system will be connected with a calculator to facilitate rapid entry of large amounts of data.

The second difficulty with projections, shared by all management information systems, is the vast number of variables involved in forecasting business trends. For example, the computer may have sales growth and profit performance data on a day-by-day basis over a period of several years. However, it may have no information to reflect, for example, that the thoroughfare in front of the store is to be modified from two lanes to a single lane, thus making entry to the store's parking lot exceedingly difficult. As one of the managers says, "the system can tell us that if nothing changes, we will see a specific result. However, there are certain kinds of changes which we can't anticipate and program for, and these must be dealt with on a subjective and individual basis."

However, in light of the system's obvious advantages, such difficulties are relatively minor. The important benefits are in allowing increasing numbers of managers to solve the user interface problem. From the manager's point of view, it broadens his capabilities without imposing new and burdensome technical requirements. And it dispels the "mysteries" and fear of data processing for yet another large segment of the managerial group, thus domesticating the computer one step further. \*



You Can Order The  
Intecolor® 8001  
Through These Authorized  
Sales Representatives

**TENNESSEE**  
**FLORIDA**  
**ALABAMA**  
**MISSISSIPPI**  
**GEORGIA**  
**NORTH CAROLINA**  
**SOUTH CAROLINA**

Col-Ins-Co., Inc.  
800/327-6600

**ALASKA**  
Contact ISC direct  
**ARIZONA**  
The Thorson Company  
Phoenix  
602/956-5300

**ARKANSAS**  
**TEXAS**

**LOUISIANA**  
Data Marketing  
Assocs., Inc.  
Houston  
713/780-2511

**NEVADA**  
**CALIFORNIA**  
The Thorson Company  
Los Angeles  
213/476-1241

**UTAH**  
**WYOMING**  
**COLORADO**  
The Thorson Company  
Denver  
303/759-0809

**NEW JERSEY**  
**CONNECTICUT**  
**NEW YORK**

Bartlett Assocs., Inc.  
White Plains  
914/949-6476

**DISTRICT OF COLUMBIA**  
**MARYLAND**  
**DELAWARE**  
**VIRGINIA**

Bartlett Assocs., Inc.  
Bethesda  
301/656-3061

**HAWAII**  
Contact ISC direct

**MONTANA**  
**OREGON**  
**IDAHO**  
**WASHINGTON**

The Thorson Company  
Bellevue  
206/455-9180

**ILLINOIS**  
**WISCONSIN**  
**INDIANA**

Bexdata LTD  
Munster  
312/221-1411

**MINNESOTA**  
**NORTH DAKOTA**  
**NEBRASKA**  
**SOUTH DAKOTA**  
**IOWA**

Bexdata LTD  
Edina  
612/835-5220

**KANSAS**  
**MISSOURI**  
Bexdata LTD  
St. Louis  
314/872-3357

**KENTUCKY**  
**OHIO**

WKM Assocs., Inc.  
Cleveland  
216/267-0445

**NEW HAMPSHIRE**  
**RHODE ISLAND**

**MAINE**  
**VERMONT**  
**MASSACHUSETTS**  
Bartlett Assocs., Inc.  
Framingham  
617/879-7530

**MICHIGAN**  
WKM Assocs., Inc.  
Madison Hts.  
313/588-2300

**NEW MEXICO**  
The Thorson Company  
Albuquerque  
505/265-5655

**OKLAHOMA**  
Data Marketing  
Assocs., Inc.  
Norman  
405/364-8320

**PENNSYLVANIA**  
Bartlett Assocs., Inc.  
Wayne  
215/688-7325

WKM Assocs., Inc.  
Pittsburgh  
412/892-2953

**TENNESSEE (KNOXVILLE ONLY)**  
McCain Electric  
Equipment Co.  
Knoxville  
615/584-8411

**WEST VIRGINIA**  
(See Pittsburgh, Pa.)

**EUROPE**  
Techexport, Inc.  
Cambridge, Ma.  
617/661-9424

**AUSTRALIA**  
Anderson Digital  
Electronics  
Victoria, Austl.  
03/543-2077

**CANADA**  
Louis Albert  
Assocs., Inc.  
Ottawa  
613/737-5941

Consolidated  
Cybernetics  
Control LTD.  
Montreal  
514/934-0000

**JAPAN**  
Munzig International  
Japan, Inc.  
Tokyo, Japan  
586-2701

Or contact us  
direct

**Intelligent Systems Corp®**  
5965 Peachtree  
Corners East  
Norcross, Georgia  
30071

Telephone  
404/449-5961



# The Intecolor® 8001

It's an 8-Color Intelligent CRT for \$1995.\*  
Or a Micro Computer for an additional \$1495.  
The choice is yours.

## A \$1995 8-Color CRT. Complete.

When we say complete, we mean complete. The **Intecolor 8001** has 8080 CPU, 4K RAM Refresh, Selectable Baud Rate to 9600, Keyboard, RS232 I/O, and ASCII Character Set. All in one package. It's a complete stand-alone system which features our unique **Intecolor 8001 NINE SECTOR CONVERGENCE SYSTEM** for minimum set-up time and exceptional stability. Three to five minutes is all it takes for outstanding color registration.

## The \$1495 Micro Computer Package.

You just give us the word and we'll convert the **Intecolor 8001** into a stand-alone micro computer with BASIC, Roll, Insert/Delete, Additional 8K RAM Work Space, Graphics Mode with 160X192 Elements, Background Color, Lower Case ASCII, 48 Line X 80 Characters/Line, and 2X Character Height. Plus additional features which make your **Intecolor** personal computer the best buy in the industry.

## Which System Is Right For You?

The **Intecolor 8001** CRT is a smart, inexpensive way to upgrade the CRT's in your present system from black and white to color. And color has definite sales advantages. Like more efficient man-machine

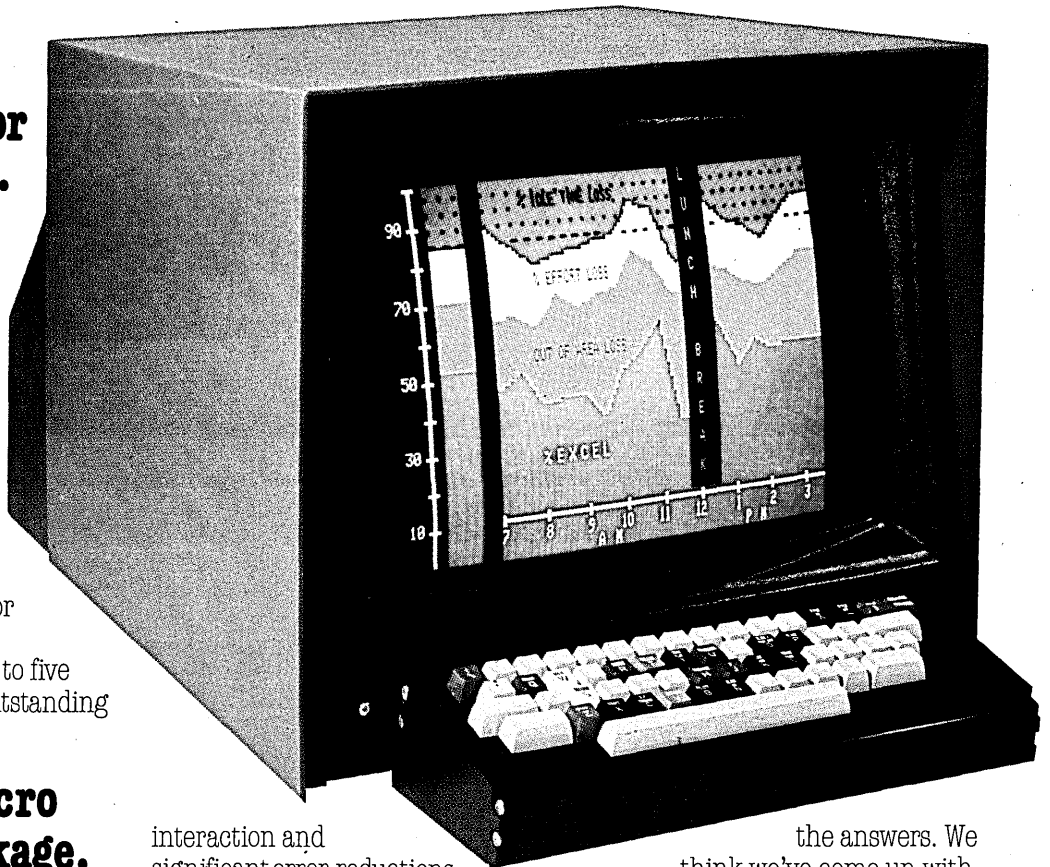

interaction and significant error reductions in data entry and recognition. The **Intecolor 8001** CRT can also be used or marketed as a complete stand-alone micro computer system with computation or control capabilities. It might even replace your whole system!

Whatever your needs, market or application — Process Control, Medical, Credit Checking, Order Entry, Financial Analysis, Research and Development, or for your own personal computer — you won't find a more usable terminal, color or black and white.

## Write Or Call For More Information

We know you're going to have some more questions, and we've got

the answers. We think we've come up with a CRT and computer package that's hard to beat. And one thing for sure. The **Intecolor 8001** is by far your best buy today in a color CRT micro computer or intelligent terminal. Make us prove it to you with a demonstration by one of our authorized representatives. Or call us direct and talk to an applications engineer.



## Intelligent Systems Corp.®

5965 Peachtree Corners East  
Norcross, Georgia 30071  
Telephone (404) 449-5961

\*Quantity 100 Price.  
Unit Price \$2,495. Domestic USA Prices



## **DECSYSTEM-20.** **It took a minicomputer company** **to offer hardware this economical.**

Not just anybody could have come out with a DECSYSTEM-20.

Because the DECSYSTEM-20 is the world's first general purpose computer to bridge the gap between big-system power and small-system price.

And that means the company that came up with it had to have a lot of experience in both big and small computers. And there is only one company that does.

Digital Equipment Corporation.

To create a DECSYSTEM-20, we took the same approach to computing that's made us the number one company in minicomputers.

That approach says that a com-

puter must first of all be affordable—giving you the most popular computer for the least amount of money.

With the DECSYSTEM-20, this approach meant giving you big system capability at a total system cost of under \$10,000 a month.

Our approach to minicomputers also said that a computer must be approachable. Meaning easy to install. Easy to use. And small in size.

With the DECSYSTEM-20, this approach meant giving you a full-scale general purpose system that installs like a dedicated mini. A sophisticated machine that

needs no operating staff and can be run interactively by just about anyone. All in a package that takes up about a fraction of the space required by other machines of similar performance.

But, to create a DECSYSTEM-20, we also took the same approach to computing that's made us the leader in large-scale interactive systems for the last eleven years.

That approach says a computer should offer you the kind of powerful software that will give you not simply everything you expect in a big system, but everything you need.

With the DECSYSTEM-20 this



# DECSYSTEM-20.

## It took a large-scale computer company to offer software this powerful.

approach meant giving you a system with: Powerful, reliable multi-stream batch. Interactive capability to run up to 64 concurrent jobs. Complete higher-level languages including FORTRAN, COBOL, APL, BASIC PLUS, ALGOL, IQL, and CPL. A true demand paged operating system with large user address space for fast throughput. Six megabytes I/O bandwidth. Six megawords per second. ECL logic. A Data Base Management System. A Business Instruction Set. High system availability. Ease of conversion. Its own front-end mini for diagnostics and to run the peripherals.

Up to 1.2 million bytes of core memory. And up to 1.4 billion bytes of high-speed, on-line disc storage.

All of which is how the DECSYSTEM-20 combines the best of the big systems with the best of the small.

DECSYSTEM-20.  
It had to be Digital's.

**digital**

LARGE COMPUTER GROUP

**Bridging the gap.**

- Please send more information on the DECSYSTEM-20.
- Please have a sales engineer contact me.

NAME \_\_\_\_\_

TITLE \_\_\_\_\_

COMPANY \_\_\_\_\_

ADDRESS \_\_\_\_\_

CITY \_\_\_\_\_

STATE \_\_\_\_\_ ZIP \_\_\_\_\_

TELEPHONE \_\_\_\_\_

Send to: Digital Equipment Corporation,  
Large Computer Group, 200 Forest St.,  
Marlborough, MA 01752.  
Tel. 617-481-9511 ext. 6885.

DS

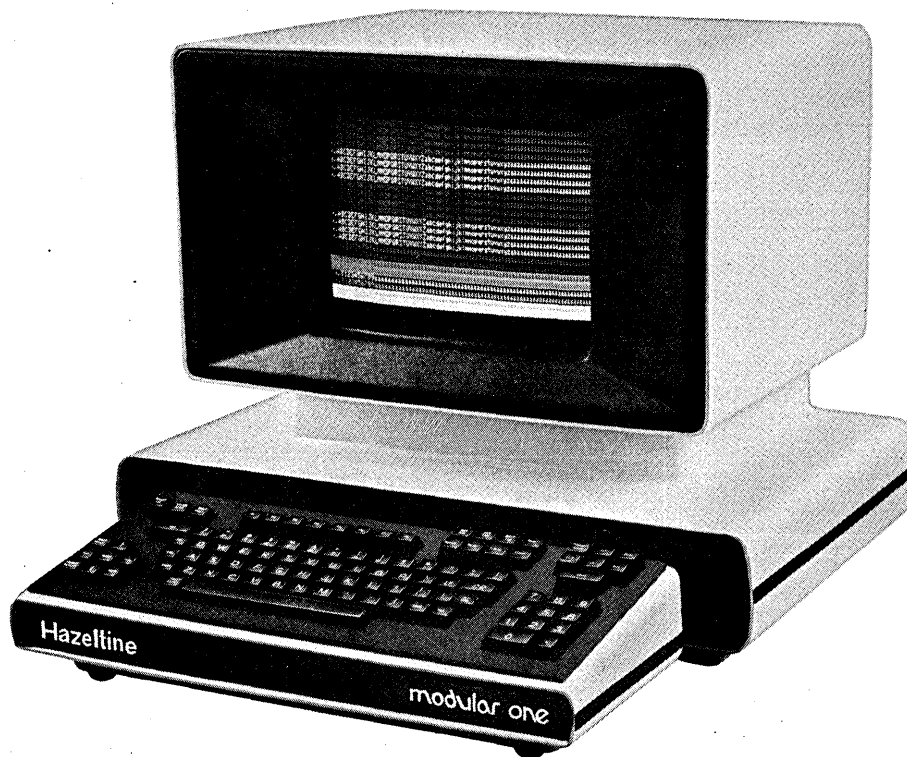

Every category of equipment  
has its acknowledged leader.

In video display terminals,  
the manufacturer is Hazeltine.

And the product is Modular One.



Hazeltine Corporation, Computer Terminal Equipment, Greenlawn, New York 11740 (516) 549-8800 Telex 96-1435

EAST: N.Y. (212) 586-1970 □ Conn. (203) 875-6429 □ Boston (617) 429-4009 □ Phila. (215) 676-4348 □ Wash., D.C. (703) 979-5500 □ Rochester (716) 254-2479.  
MIDWEST: Chicago (312) 986-1414 □ Columbus (614) 864-4714 □ Detroit (313) 559-8223.

SOUTH: Atlanta (404) 434-8444 □ Houston (713) 783-1760 □ Orlando (305) 628-0132.

WEST: San Mateo (S.F.) (415) 574-4800 □ L.A. (213) 553-1811 □ Denver (303) 770-6330 □ Seattle (206) 242-0505.

CANADA: MISCOE Data Communications Equipment Services, Ltd. □ Toronto (416) 678-7354 □ Montreal (514) 631-4381

□ Vancouver, B.C. (604) 731-0714 □ Calgary (403) 264-8237.

ENGLAND: Hazeltine Ltd. 01-948-3111 Telex (851)-928572. GERMANY: Hazeltine GmbH 0611-590748 Telex (841)-416924.

FOR WORLDWIDE SALES INFORMATION CALL: (516) 549-8800.

### IMSAI 8080: THE COMPLETE COMPUTER SYSTEM

- Computer with 16K bytes of memory, 8-level interrupt and interval clock
- 2 floppy disk drives with intelligent interface/controller
- 300 LPM printer
- 24-line by 80-column CRT with keyboard
- Programmer's front panel and software
- All peripherals interfaced

**\$10,608 UNIT PRICE\***

*\*Quantity discounts available.*

### IMSAI 8080: THE COMPLETE DEVELOPMENT SYSTEM

- Computer with 16K bytes of memory, 8-level interrupt and interval clock
- 2 floppy disk drives with intelligent interface/controller
- 2 serial I/O RS232 or TTY ports
- Chassis with 22 card slots
- Power supply, programmer's front panel and software

**\$5,856 UNIT PRICE\***

*\*Unassembled \$4,444. Quantity discounts available.*

*\*Prices: USA Domestic*

# The IMSAI 8080 Floppy Disk System. It's more than you'd expect for much less.

The IMSAI 8080 Intelligent Floppy Disk System. For the money, there's no development system like it: it's easier to use, more powerful, modular and versatile than anything on the market. And the tickets prove it.

The IMSAI 8080 computer is powerful, accommodating up to 64K bytes of MOS write-protect memory. It's fast, with 500 nanoseconds total memory access time and 2 microseconds minimum instruction time.

The IMSAI 8080 is modular and highly versatile. It can accommodate up to 22 boards. And there's no restriction on mix of memory and I/O interface boards.

The IMSAI 8080 can be configured for just about any application. We offer a variety of memories (RAM and EPROM), I/O interfaces (parallel, serial asynchronous and synchronous RS232C, TTY), peripherals (disks, printers, tape

cassette, CRT's), and multiprocessing capability.

And if you're an OEM, you'll like the way the IMSAI 8080 is put together. Switches are large and rugged, and the front panel, with hexadecimal and octal notation, has an extra eight program controlled LED's.

The intelligent floppy disk interface/controller has its own processor and firmware. It provides sophisticated control of the

floppy disk system with DMA and automatic retry. And this economical interface/controller can handle up to four drives. Each disk stores up to 243K bytes using the IBM 3740 format and has an average access time of 330 milliseconds.

You can immediately develop your own application software using DOS, assembler, text editor and debugger. In addition, extended BASIC and FORTRAN, both integrated with DOS, will soon be available.

The IMSAI 8080 Intelligent Floppy Disk System. Never before could you get so much for so little. For an IMSAI 8080 catalog describing options, peripherals, software, specifications and prices, write or call IMSAI.

Dealer inquiries invited.



European Distributor  
Harper Industry Products, Ltd.  
6079 Sprendlingen 2  
West Germany

## IMSAI

IMSAI Manufacturing Corporation  
14860 Wicks Blvd.  
San Leandro, CA 94577  
(415) 483-2093  
TWX 910-366 7287

Dept. D-1

# Join the great computer roundup

1977 National Computer Conference — June 13-16, Dallas

There's a world of data processing information waiting for you at the 1977 National Computer Conference — a Texas-sized roundup and the first NCC ever held in the dynamic Southwest. More than 100 sessions will explore the technology of computing, management issues, the uses of computing, and the individual in the computer age. The exhibit program promises to be the largest ever with more than 250 organizations occupying over 1,000 booths.

All this and more . . . all in the spacious Dallas Convention Center in the heart of the business and cultural hub for the Southwest, only two-to-three hours' air travel time from any of the nation's major computer centers. Included will be a

number of innovative "firsts" — a national programming contest, a two-day program on personal computing, a Personal Computing Fair, plus special exhibits of products geared to the computer hobbyist.

Other highlights will include: professional development seminars; special program areas on such topics as energy, petrochemicals, retail sales, health care, and career development; plus more than 5,000 exhibitor representatives on hand to discuss your data processing needs.

The '77 NCC brings it all together at

the year's largest roundup for computer specialists and data processing users. To assist you in your planning, the NCC offers the *Everything Card* providing advance full-conference registrants with savings and other benefits; a deluxe red-

carpet travel service; and a complimentary subscription to *NCC Roundup*—a fact-filled newsletter covering all NCC activities and events.

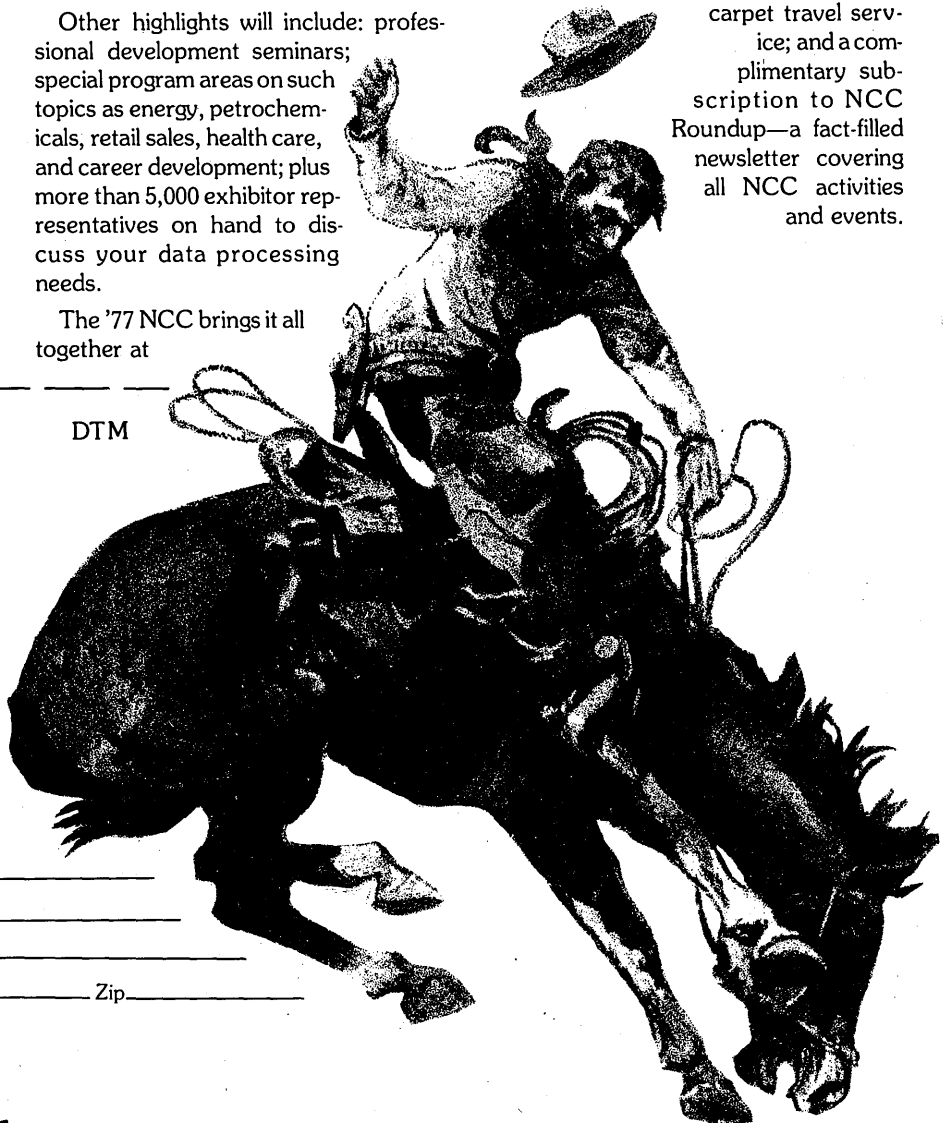

## '77 NCC,

c/o AFIPS, 210 Summit Ave.,  
Montvale, N.J. 07645  
Telephone: 201/391-9810

DTM

- Yes, send me my *Everything Card*. I've enclosed \$60 covering the '77 NCC program and exhibits plus preregistration benefits.
- Please send me all the facts about the '77 NCC including future issues of *NCC Roundup*.
- My company is interested in exhibiting at the '77 NCC.

Name \_\_\_\_\_

Company \_\_\_\_\_

Street \_\_\_\_\_

City \_\_\_\_\_ State \_\_\_\_\_ Zip \_\_\_\_\_

**'77NCC...**  
**The Great**  
**Computer Roundup**

# HEWLETT-PACKARD

# COMPUTER ADVANCES

APL—"A Programming Language"—is as straightforward as its name. Created by Kenneth Iverson in 1962, APL is a general purpose programming language, rich in primary functions and operators. APL uses powerful shorthand notation to express complex calculations concisely and logically, and to operate on groups of numbers or data as easily as on sin-

gle ones. With these characteristics, APL is well-suited to scientific, engineering, and business applications such as statistical and financial analysis, forecasting, modeling or simulation—areas where numeric processing and data manipulation are needed.

The Hewlett-Packard 3000 Series II, a price-performance leader in small general purpose computers,

has now added an enriched version of APL to its language repertoire. And in conjunction, HP has designed a CRT terminal especially for APL—the HP 2641A Display Station. These innovations fill a gap that has long frustrated potential APL users: until now, full APL capability has not been available on a small general purpose computer. 

## APL NOW AVAILABLE ON A SMALL GENERAL PURPOSE COMPUTER

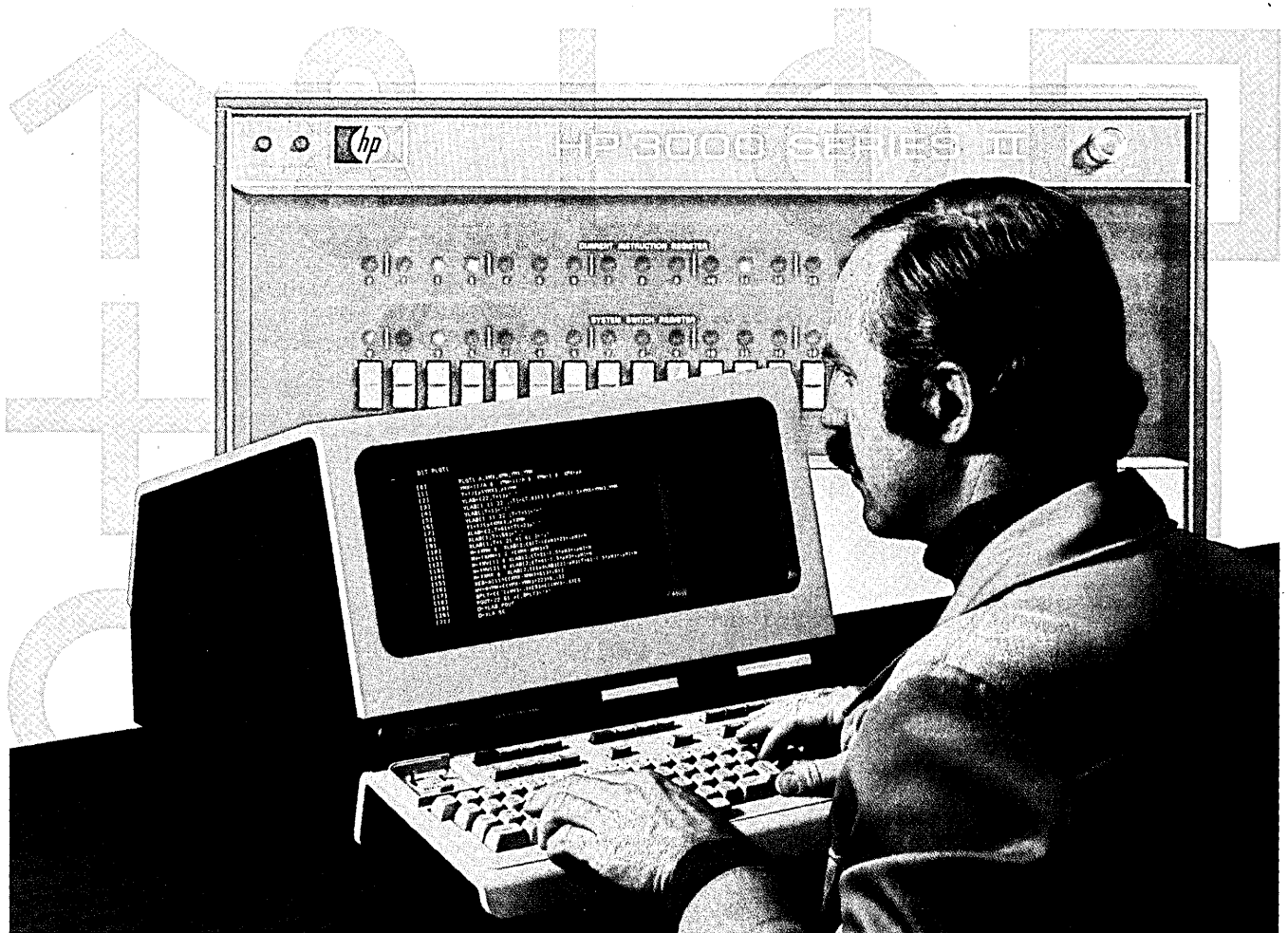

# APL\3000 FROM HEWLETT-PACKARD

## ALL THE POWER OF APL ON A LOW COST COMPUTER

APL programmers are the only programming language users who hold an annual conference to forward the use of their language. APL's loyal followers tell you—using APL is addictive.

APL is responsive to the way people like to work; you can begin programming before a problem is entirely worked out. As a "try it and see" language, APL's interactivity and immediacy let the program respond flexibly as the problem is worked through. APL does not commit the programmer to specified dimensions, parameters, and types.

Sadly, the use of APL has been limited to a small group of people because, until now, APL has been available only on large expensive machines, through service bureaus, or in limited capability versions on programmable calculators. The demand for APL access has been steadily growing.

**"Enriched" APL\3000.** Hewlett-Packard's new APL\3000 software for the first time puts big APL capability on a small, low-cost, general purpose computer. APL\3000 is a new technology APL employing firmware-assisted virtual workspace and dynamic incremental compiler techniques.

Powerful APL capability on a small computer may revolutionize the availability of the language. Insurance actuaries, computer science educators, finance managers, engineers, research scientists, marketing researchers—in fact anyone who needs to express complex calculations in a concise manner—can now employ the power of APL\3000 to solve their problems.

**Production APL.** APL\3000 is the first dynamically compiled version of APL. Its compiler is both incremental and heuristic. The first time it is run, APL\3000 quickly compiles statement by statement i.e. incrementally. Subsequent executions recompile selectively only those statements that have been affected by a programmer's change. All other statements skip the interpretive level and directly execute with the speed of compiled code. The compiler is also heuristic. New compilations may produce more flexible code and lessen the need for future recompiles. The result, is faster execution of frequently run and stable production type programs.

**"Infinite" Workspace.** Present day APL enthusiasts are often discouraged by traditional fixed workspace\* sizes that limit the amount of code they can write or the data they can store.

In search of more workspace, users are forced to develop complicated algorithms to manage the interchange of data between their workspace and a storage file system. Beyond this real annoyance, fixed workspace violates a basic philosophy of APL—that of direct operation on the data.

An APL\3000 innovation—"virtual workspace" eliminates this problem. Workspace is limited only by the amount of on-line storage on the system. As code is needed and used, it is brought from disc into main memory. APL\3000 is infinitely more usable with this close-to-infinite workspace. Microcoding the "virtual workspace" scheme results in faster execution and considerably less overhead.

**Advanced Editor**—In lieu of the standard APL  $\nabla$ -del Editor, Hewlett-Packard has a fuller and more advanced editor built right into the system. The editor's English word commands can be abbreviated for ease of use and allow powerful text, as well as function editing. There is even a command for undoing an edit change. Anyone who has made a drastic mistake in editing will appreciate "UNDO" which allows recovery from an editing error and avoids the series of complex recovery edits typical of most Editors today.

**APLGOL.** In certain cases, such as production environments, program code needs to be easily read

and maintained. APLGOL—an extension of APL\3000—allows you to write APL so that the program flow is readable. APLGOL produces programs with the conciseness of APL and the control of structured programming concepts.

The conventional semantics of APL remain; APLGOL key word constructs, such as IF THEN ELSE, WHILE, CASE, provide interstatement control, structure, and program flow.

The 3000 Series II treats APL\3000 as a standard language subsystem. Any of the 3000's other languages (FORTRAN, COBOL, RPG, BASIC and SPL) can be used concurrently with APL in batch or interactive modes, since APL is a subsystem of the HP 3000, the full resources of the computer are available to non-APL users as well.

APL\3000 software and firmware can be purchased for \$15,000. APL models of 3000 Series II general purpose computer systems, which make it all possible, cost \$155,400 to \$350,000 (domestic U.S. prices only, maintenance not included).

For more information on how you can acquire the resource of APL from Hewlett-Packard, circle A on the reply card. 

\*In APL vernacular, workspace is an area where a user can operate on and store such things as defined variables (data) and user defined functions.

### SORTING A SET OF NUMBERS

BASIC	FORTRAN	APL
10 DIM X (100), Y(100)	DIMENSION X(100), Y(100)	X $\square$ $\diamond$ X( $\uparrow$ X)
20 READ N	READ (5,10) N, (X(I), I=1, N)	
30 FOR I=1 to N	10 FORMAT (15, (E15.2))	
40 READ X (I)	DO 9 I=1, N	
50 NEXT I	A=X (I)	
60 FOR I=1 to N	L=1	
70 LET A=X (I)	DO 8 J=1, N	
80 LET L=1	LF (A-X(J)) 8, 8, 7	
90 FOR J=1 to N	7 A=X (J)	
100 IF AL=X(J) THEN 130	L=J	
110 LET A=X(J)	8 CONTINUE	
120 LET L=J	Y (I)=A	
130 NEXT 5	9 X(L)=100000.	
140 LET Y(I)=A	WRITE (6,20) (Y(I), I=1, N)	
150 LET X(L)=100000	20 FORMAT (E15.2)	
160 PRINT Y(I)	END	
170 NEXT I		
180 DATA		
— —		
XXXEND		

The simplicity of APL is clear—try a comparative program in several languages.



# THE 2641A DISPLAY STATION FROM HEWLETT-PACKARD

## A TERMINAL TO COMPLIMENT APL

Key to the secret of APL's expanded capability is a distinctive set of APL characters. Each one symbolizes a powerful operation. For example, invoking the APL Greek character iota  $\iota$ , and a number N, will produce all intergers from one to the number indicated. After an input of  $\iota$  15, the system will respond with 1,2,3,4,5,6,7,8,9,10,11,12,13,14,15. IOTA is a typical example of the ability of APL's shorthand to save a programmer's input time and to shorten the verbage needed to express complex mathematics.

To interact with APL, users need a terminal which can express these special APL characters. Hewlett-Packard designed the 2641A to compliment the power and elegance of the APL language. The 2641A APL Display Station is a member of the 2640 family of HP terminals that pioneered internal mini-cartridge mass storage and that offers features such as self-test and "soft keys". The 2641A has these family features, plus a versatile keyboard labeled with both the APL and standard ASCII characters.

Designers of the 2641A thoroughly canvassed existing APL users to produce the most widely used set of APL characters. The 2641A supports a full 128 APL character set, a 64 character overstrike set and a 64 character Roman set. These sets represent the special symbols used on IBM and Burrough's systems, and most symbols used by time-share bureaus supporting APL.

Overstruck characters, an APL innovation, are a combination of two existing characters and are produced by striking one key, backspacing, and striking a second key.

For example,

1. O (shift O)
2. "backspace"
3. | (shift M)

produces  $\Phi$ —a special overstruck character. The concept of overstrike expands the number of unique APL operators available to users. Without the high resolution display of the 2640 family, overstrike characters can be difficult to read. The 2641A assures crisp, clear characters.

Creating standard overstrike APL characters is a bit more complicated than a normal single key input. Innovations of the 2641A minimize the possibility of making an overstrike error. A set of all valid overstrike characters are stored in the 2641A's internal memory. After a user inputs an overstrike character, a search and compare with the existing set in memory assures that the character is

indeed valid. If so, verification is immediate for the character is moved from memory to be clearly displayed on the screen. If not, a special "OUT" character is displayed indicating an invalid overstrike was made.

The input order of overstruck characters is simplified with another 2641A innovation. The user can create successive overstrikes conveniently in any order and be assured that the correct character will reach the system. This feature applies also to overstrikes created when backspacing from the current line to the previous line.

Certain characteristics of the 2641A are family related. The pressing of the self test key immediately and simply indicates whether a unit is ready to operate. With pop-in, pop-out modularity of printed circuit assemblies, service and repairs are simple and fast. Optional mini-cartridges provide storage that allows the user to develop programs on the pocket size cartridge or prepare data off-line, then transmit it later to the computer in

batch form. Special-function user-defined "soft keys" can be programmed to execute up to an 80 character sequence with a single keystroke. For example, a complete log-on sequence can be transmitted to the CPU using only one "soft key". Off screen storage of up to 12K bytes allows users to store large blocks of data, and edit at leisure with the assist of scrolling and paging features.

The full compliment of display enhancements (inverse video, blinking, half-bright, etc.) are standard, and the optional line drawing set allows the creation of readable forms with visual prompts. The terminal operates at up to 9600 baud with optional polling and multidrop.

The 2641A, at \$4100 (\$5700 with mini-cartridges) sets a new price/performance standard for APL terminals (domestic U.S. prices only).

For further information on the 2641A circle B on the handy reply card. 

```

>LIST ALL
[ 0 ] E SALESTAT R;LABEL;NAMES;C
[ 1 ] LABEL+4 Sp 'SHOES HATS PANTS BOOTS '
[ 2 ] NAMES+ ' JONES SMITH WALL HARRI
[ 3 ] 'COMMISSION'
[ 4 ] NAMES
[ 5 ] C+.062x0FR-E
[ 6 ] LABEL,FB 2FC
[ 7 ] 'TOTAL ',FB 2F+FC
[ 8 ] 'PROFITS'
[ 9 ] NAMES
[ 10 ] LABEL,FB 2FR-E-C
[ 11 ] 'TOTAL ',FB 2F+FR-E-C
[ 12 ] 'GRAND PROFIT TOTAL',FB 2F+FR-E-C
>END
EXPENSES SALESTAT REVENUES
COMMISSION

```

The intricate APL characters of a typical business program appear crisp, clean and clear on the high resolution screen of the 2641A.

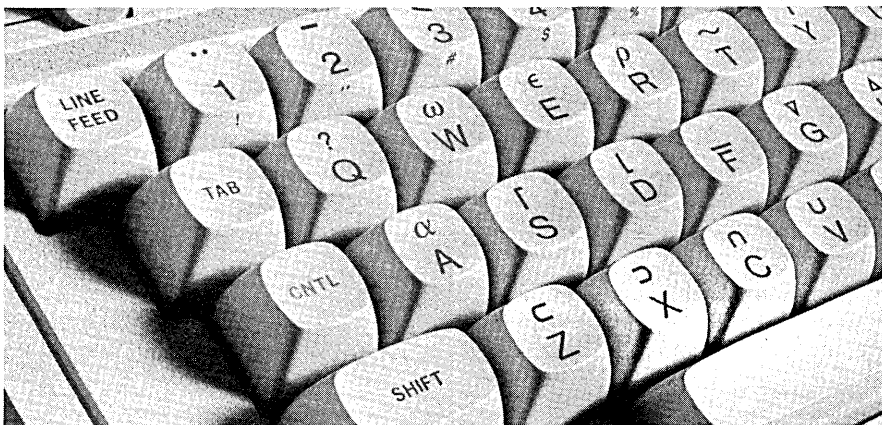

The versatile keyboard of the 2641A Display Station carries both APL and full ASCII character sets. Each key is "double injection molded" to wear and wear.

# BEGINNING COURSE IN APL AND HEWLETT-PACKARD SYSTEM PASS TESTS AT YALE UNIVERSITY

"There's a faster way for students to learn computer programming," claims Alan Perlis, director of the Computer Science Department of Yale University.

Here, in a curriculum considered a radical departure, APL, one of the most sophisticated programming languages in common use, is being taught to beginning students.

The system that is the key to the new curriculum is a Hewlett-Packard 3000 Series II general purpose computer system with APL\3000 software. The system also represents a departure since it is the first small, economical computer system totally conversant in APL.

**Students advance three times faster.** By studying APL, a kind of shorthand in which complex data manipulations can be described in single statements, the Yale students are advancing three times faster in programming skills and general understanding of EDP than with more conventional programming languages," says Perlis.

For several reasons, it was fitting that Yale became the test site for HP's new APL\3000.

First, the department has itself been highly interested in promoting the development of APL programming languages on small computers. Second, the university is an excellent place to give the new system the kind of diversified shakedown that few other environments could provide. And finally, it seems mildly appropriate that the first complete small computer APL software package be introduced at one of the first colleges in the New World.



The Computer Science Department at Yale University, under the direction of Professor Alan Perlis, is the test site for the first small, economical computer system with a complete APL software. According to Perlis, the Hewlett-Packard APL 3000 is "fully equivalent" to the APL on large mainframes.

"At Yale, or any other multifaceted university, the situation is much different from a commercial environment," explains Perlis. "We have no standard set of problems, which once running well, complete the job. We are constantly solving unusual problems, attempting new things, and pushing the state of the art of the languages in use here."

**APL's rich idioms.** According to Perlis, there are many advantages to teaching APL to the students besides the faster advancement APL makes possible.

"APL permits each student to program a solution to a problem in a more personal way. This contradicts the 'mechanical view' that there is only one approach. Here, we consider programming as a creative and literary technique in which the students learn to express themselves by taking advantage of the language's rich idiomatic structure," explains Perlis.

One benefit of APL, says Perlis, is that the students "compose at a level several steps higher than with other languages, providing an avenue for growth early in the learning process. Later on, programs that would be extremely complicated and lengthy in other languages become much easier to create, comprehend and handle."

As an example, one student assignment might be a word processing task in which a list of article titles must have their small words eliminated and the remaining key words used to arrange the titles in alphabetical order.

"This would be an immense program in BASIC or FORTRAN," says Perlis. "With APL, it takes about seven to ten lines. In many cases there is a 10:1 ratio between the number of FORTRAN statements and APL statements."

In another assignment, students might be asked to sum a series of numbers. In FORTRAN, the process would take several steps because iterative loops are necessary. These cumbersome loops are never a problem with APL because they don't exist.

"HP's version of APL is fully equivalent to the APL we have on our IBM system. It is not limited or abbreviated in any manner," says Perlis.

**HP system shared with graduate school.** While Professor Perlis' undergraduate classes are working out APL functions, Professor John

Bassler's students in the School of Organization and Management are simultaneously using decision-free programs and linear programming techniques written in BASIC to evaluate alternative courses of action and to analyze large numbers of variables.

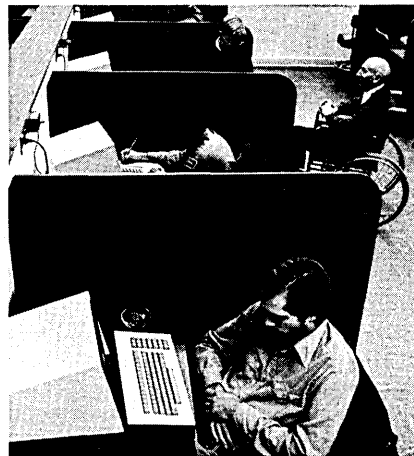

**Students at Yale are challenged by assignments such as to condense entire programs into "one-liners." The sophistication and conciseness of APL make this possible.**

#### Distributed cluster approach.

The HP 3000 computer system which has a 512K byte main memory and 60 megabytes of disc storage is one of several smaller computers on the Yale campus. This is in keeping with the "cluster" approach which the Yale department of Computer Sciences advocates.

"The advantages of having several smaller systems instead of relying solely on a single large one are many," he says. "The two clusters allow us more flexibility to try out something new; we are not locked economically into one large system; further clusters can be added with modest investment, and a secured computer area is not necessary."

The test of the HP APL\3000 system thus far has gone extremely well, reports Perlis. Used almost continuously, the system's reliability has been excellent and operation has been very stable after a small number of initial bugs were eliminated. For the students of APL, that has meant little time has been lost in their rapid advancement.

"When the APL-taught students are introduced to FORTRAN later on in the course," says Perlis, "the often-heard comment is: 'Why would anyone...'"

HEWLETT  PACKARD

Sales and service from 172 offices in 65 countries.  
1501 Page Mill Road, Palo Alto, California 94304

# What Data Base Isn't

by Daniel S. Appleton

The data base environment cannot be reached one application at a time; it requires a whole new orientation.

There can be little doubt left that the future of business data processing lies in the direction of data base technologies and concepts. To many operations and data processing managers, "data base" has come to be the light at the end of a long, dark tunnel. But the tools and technologies of "data base" are not, in themselves, enough to create a working data base environment. Indeed, some major philosophical and managerial changes must be made before we can be sure that that light at the end of the tunnel is not a train.

It seems that we have become so obsessed with figuring out what data base is (what data base administrators do, or what type of data base management system to buy) that we forget the real roots of the concept. These roots do not lie in computer hardware and software technology. In a very real sense, "data base" is a catch phrase which describes the type of dp environment most managers thought they were going to get when they decided to lease their first computer: an automated pool of accurate and timely data which could be easily and economically drawn upon to satisfy, on demand, the information requirements of management's decision problems.

In place of data base, management got individual computer *applications*, leading to separate and uncoordinated files of increasingly inaccurate and untimely information which are difficult and expensive to manipulate, which support primarily static, routine information requirements, and which actually inhibit changes in management decision-making processes.

Few would disagree that this is a fair description of the typical business data processing environment. In fact, much time, money and brain power has been spent to explain why such an environment exists. Typical rationalizations include: lack of top management interest, poor user involvement, the insatiable desire of dp personnel to build technical monuments, management failure to learn how to use the computer, inability of users and dp professionals to develop a common language,

poor planning and project control, going too far too fast, and misapplication of computer technology (hardware and software).

## The "application systems syndrome"

Even though these problems are very real, they are only by-products of a much more fundamental fallacy in the logic businesses use to automate. This fallacy is the applications approach, itself. I do not mean to indict any particular computer application; actually, some are very good. What we should attack is the logic which leads companies to approach automation using the application psychology.

At the very foundation of the "application systems syndrome" is the belief that the computer does not "control" information; it receives, stores, processes and reports information. Most application systems are intended to be information filing systems. In fact, it seems that the more the computer is required to "control" information, the more complex the application systems become and the greater the risk of failure.

We information experts (and that includes management) know a great deal more about filing information than we do about controlling it. And though we readily admit this, we doggedly refuse to draw a clear-cut distinc-

---

We know a great deal more about filing information than we do about controlling it.

---

tion between the two. The failure to do so is one of the primary reasons that the large majority of our attempts to build information control systems fall far short of the intended mark, and why the frustration in both dp and business management is growing at such an alarming rate.

An information control system is *not* a large, complex, super-sophisticated information filing system. It is a tool for making decisions in the highly complex, probabilistic business envi-

ronment. And yet, our concept of what the characteristics of that tool are, and of how we should go about building and managing such a tool, derive specifically from a tradition that says that filing and control are one and the same. We see this tradition manifested in the application systems syndrome, that is, in the development process used for building business systems, in the way we train our information experts, in the design philosophies behind computer hardware and software, and in almost every other facet of our business. In fact, the tradition is so much a part of our day-to-day lives that it is self-perpetuating.

Application systems are not control systems; they are filing systems. Designed to satisfy specific, usually carefully defined, output requirements (such as Payroll, Accounts Payable, Bills of Material, MRP, etc.) each application is set up with its own special information input and information storage controls. These filing systems are developed for individual managers and departments, thus reflecting the organizational structure of the company and the information requirements of its decision problems at a given point in time. They also reflect individual management styles, good or bad, of the managers and analysts who build them.

Changes in organization, management philosophy or style, or decision problems tend to have significant impacts on application systems because they redefine information needs. Indeed, any environmental change, be it political, administrative, economic, social, psychological, or whatever which may affect system output requirements (and most changes do affect information needs) will have significant impacts on the total automated application systems structure of the company. Why? Because an application systems structure, including all of its input controls, computer processes and procedures, hardware, software, security, and computer files, is by definition geared to satisfy specific, pre-determined information needs. If these in-

## DATA BASE ISN'T

formation needs change, we reset to zero.

Most companies depend on their data processing departments to keep their computer applications under control. These data processing departments begin as organizations intended to develop computer applications. Gradually, as the systems are developed one by one, the orientation of a

**An application system is, by definition, geared to satisfy specific, predetermined information needs.**

dp department changes to one of maintenance. In a sense, each application of the computer becomes a data processing product line. Since each product line is composed of many parts (represented by computer files and programs) generally grouped by function (input, storage and output), a department with 10 product lines will be performing 30 separate functions using any number of programs and files. Each of these 30 basic functions could

well represent different computer hardware or software technologies, with logic developed by different personnel. The problem would not be so difficult if the 10 product lines were all separate and distinct, but rarely is this the case. Usually, after computer applications are independently developed, they are "integrated," for reasons of expediency, cost or simplicity. Thus, the thirty basic functions are not performed independently. More often they are highly-dependent on one another.

Companies which adopt the application systems approach are usually disposed to let their data processing environment "evolve." This evolution tends to follow the path of least resistance, and as a result automation finds itself driven by emotional acceptance rather than logical orchestration. Managers who want computer reports will generally get them. The price they pay for output is that they must put data into the computer. Rarely will a department manager agree to put data into the computer just because someone else wants to take it out. Few managers trust the integrity of each other's data anyway. Most would prefer to read reports from someone else's system, se-

lect the data they want, and put it into their own systems.

### The old assumptions are wrong

This is the data processing environment created by using the applications approach to developing computer systems. The approach is marked by several basic assumptions made consciously or subconsciously by management at the outset of data processing programs. These assumptions include:

1. Systems will be built for individual managers, not for the company as a whole.
2. Data processing input, storage and processing techniques will be geared to specific output needs.
3. The data processing environment will service managers who want computers, i.e., it will evolve along the "path of least resistance."
4. Investments for computer hardware, software and personnel will be based on current demand for computer applications and will be increased as that demand increases.
5. Automated systems will work manually before they can be computerized.
6. The data processing department will have no responsibility for system or data integrity beyond writing programs that work.
7. Justifications for data processing services will be based on cost trade-offs (most often personnel reductions), application by application, rather than company plans to improve overall efficiency or productivity.

One thing is for sure: the most dynamic need in business is the need for information. Does it stand to reason, therefore, that certain of these needs should be frozen in time and encased in a computer application? Further, is this concept of filing and control compatible with the real problems of management information? Applications tend to control information needs, often to the relief, but certainly not the benefit, of management. Should we not

**The data base approach requires a complete psychological reorientation.**

be automating to control the ability to respond efficiently and cost effectively to changing information needs? Is this not the better concept of information control? It is the whole purpose behind the data base approach to automation.

The alternative to the applications systems approach is the data base approach. The problem with using it, however, is that it tends to violate all of the basic premises on which companies have traditionally constructed automated management systems. In a very real sense it requires a complete psy-

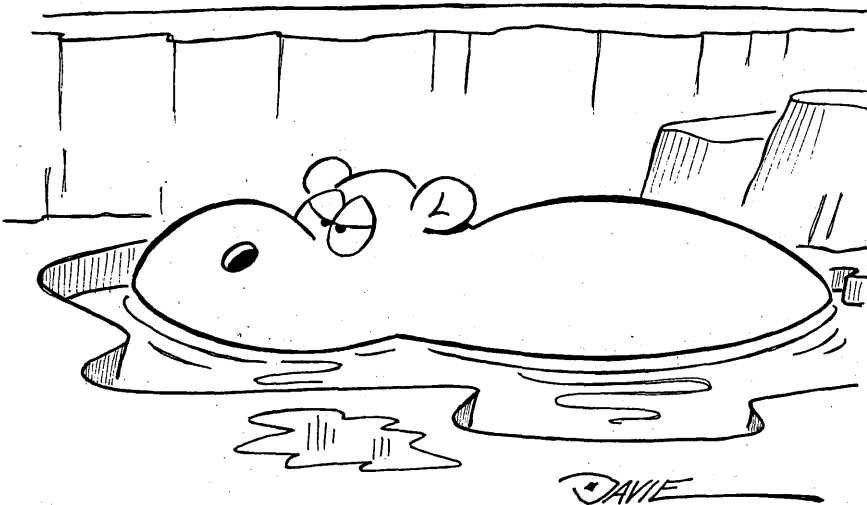
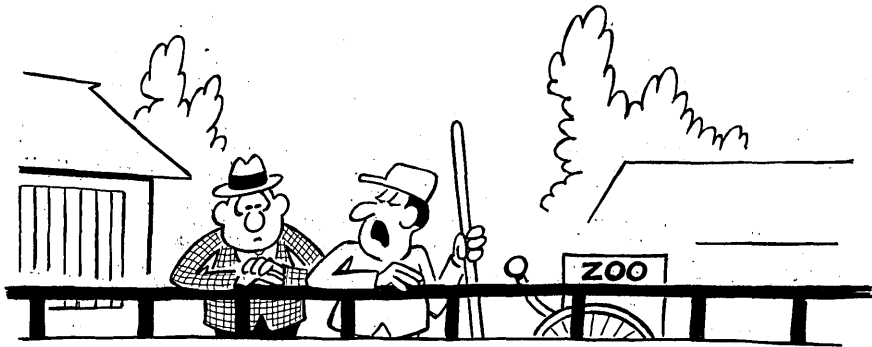

"We got him from Disneyland. He was there three years before they found out he wasn't automated."

© DATAMATION ©

chological reorientation to computerization, not just for management, but for data processing folks as well. Even today, many companies attempt to employ the data base systems approach without making this psychological change. They feel that the employment of tools typically associated with data base concepts—data base administrators, data base management systems, data dictionaries—and modular programming will naturally result in a data base environment. But, all too often they find that these tools, employed using conventional attitudes and strategies, do not automatically solve their data processing dilemma.

To clear the air about what data bases are, it should be understood that the phrase "data base" does not refer to the physical structure of computer

---

**A data base is a logical construct, not necessarily a physical one.**

---

files. A data base is a logical construct, not necessarily a physical one. This logical structure is built on a foundation which defines a "system" as "a procedure which develops and provides input to a computer or receives and uses output from a computer." This definition is somewhat different from that used in the applications environment. The concept of a "system" in that environment is "the organization of computer input, storage, processing and output needed to satisfy a specific management information requirement."

This distinction between application systems and data base systems is crucial. An application system is, in the final analysis, an *information model*. Like any other model it is designed to produce specific output; and to produce this output, it requires specific input. This model is structured on certain basic assumptions about the decision making processes in a business, and in order for it to continue working properly, certain strict parameters regarding both information and the decision making processes must be adhered to by the business. The model is constructed to serve current information needs, and its purpose is to bring order to informational chaos by regulating information flow and content.

The information model has been found to have many shortcomings as an aid to business decision making, not the least of which involve high cost, low efficiency, and lack of flexibility. And these problems draw management's attention toward data base concepts.

Data bases do not store information as information. They store data which can be used to generate information. They are, in effect, *data models* of a business. Data base "systems," unlike

application systems, either provide data to the computer or take it out, not both. Also unlike application systems, they are oblivious to how data, or information, is stored and processed.

Data base development generally follows a path different from applications development. Rather than automating function by function, following the path of least management resistance, data base development concentrates first on identifying what "base data" should be stored on the computer.

The only way this can be accomplished practically is by starting with the idea that a company has one and only one basic overall work structure. This work structure encompasses all functional activities performed from the time a demand for resources comes into existence until that demand is satisfied, including marketing, production and accounting activities. The work structure, as contrasted with the organizational structure, is a horizontal, network structure, which has as its primary objective the efficient and cost-effective movement of work within and among organizations.

Accordingly, it is this structure which defines and controls the basic data used to run the company. Though information demands are created by both structures—work and organization—the data supply needed to satisfy those demands exists only in the work structure. The cost and efficiency questions which eventually lead to storage of parts of this data on a computer can only be answered appropriately in terms of the cost and efficiency of doing business.

#### **"Input," "process," and "output" are independent**

Data base development is performed in a data base management environment organized around three basic control systems: 1) a data base input control system, 2) a data base output control system, and 3) a data base storage and processing control system. These three management systems provide a new set of ground rules for automation, and the ground rules require that the concept of individual computer applications, each with its own input, storage and output, be abandoned.

Data base management systems which collect and manage input to a data base have as their primary purpose the maintenance of data quality and integrity. They are not concerned with the ultimate use of the data. They are constructed to capture data at its source, regardless of whether that source will ever see the data in the form of output. They provide input techniques, edits, audits, security and diagnostic controls intended to optimize data quality, integrity and cost.

The data base input control system, once established, undergoes few changes because it is not directly subordinated to the company organization structure or individual management prerogatives. If it is properly constructed, it will be affected only by the requirements for more or less data of higher or lower quality, or by changes in technology which would make data input more efficient or economical.

The data base output control system operates completely differently from the input system, as it is subordinated to both company organization structure and specific management prerogatives. Data base systems which receive and use output are the most dynamic systems in the company because they answer questions developed for management decision-making needs. Changes in these needs can be affected by almost anything, including personalities, management styles, economics, politics, changes in functional responsibilities, and so on. Thus, the output control system must be geared primarily to support the dynamic world of output demand.

Rarely, in a properly developed base, should changes in output requirements cause changes in the data base input control system. Why? Because, the information required to satisfy 80-90% of management's decision-making needs is, in most companies, developed

---

**Management's information needs rest on only 400-800 elements of data.**

---

from combining, arranging, analyzing, sorting and reporting some subset of between 400-800 basic elements of data. From 400 elements of data, some 10<sup>869</sup> different demands for output can be supported.

In addition to the generalized input and output systems, a data base will be supported by a storage and processing control system. This system manages the data base itself, receiving data from the input control system and passing it, on demand, to the output system. The processing and control system is an independent data base management system with built-in capabilities for controlling backup, recovery, data availability, security, computer efficiency, and so on. It is generally controlled by an individual called a Data Base Administrator.

The processing system controls the data base's physical structure. This structure is not static. It must respond to needs for optimizing efficiency and cost effectiveness. Nor is the control system completely free from data redundancy. Redundant data is purposefully used to improve computing efficiency and reduce processing time and costs. The processor employs data base

**SALE**

**SALE**

**SALE**

**SALE**

**SALE**

**SALE**

**SALE**

**SALE**

**SALE**

**SALE**

**SALE**

**SALE**

# Give your proprietary software the repetitive edge.

The BTI 4000 Interactive Timesharing System was designed to keep your proprietary software proprietary. And enable you to sell it again and again, and again ...

On our system *you* totally control the software source code—even when you sell a turnkey system. Yet management, operating and library functions are controlled by the *system owner*.

You don't give up your software; he doesn't give up his system.

## Your software stays soft and accessible.

Other computer systems offer some degree of software security through microprogramming. But using "firmware" takes away your flexibility in changing or modifying programs.

The BTI 4000's unique operating system allows the software vendor to alter or even remove software over the phone—independently of the system owner. So you can support software from *your* office.

Now you can safely make software sales demonstrations. You can insure additional reimbursement for multiple installations. You can even

offer attractive term payment arrangements, instead of steep up-front total payments.

In short, with our system it's easier to make sales. And to make more sales repeat sales.

## There's even more.

Source code security is just one of the plusses. Other advantages the 4000 offers include:

Hierarchical account organization. 26 independent account groups can be run as separate businesses, allowing "sub-letting" of portions of the system to different companies or departments. All activity is recorded by account—even use of individual programs and files.

Remote system control.

The system and master account managers have the power to access the system from any terminal to create new accounts, modify time and storage limits, change passwords, provide or remove access to programs and files, or check user activity.

Software mobility.

Software can be moved on, off, or within the system, without shutting down.

BASIC-X. Feature for feature, you won't find a better extension of BASIC.

Inter-system communication. Optional ports can be added to communicate with other systems, in any asynchronous protocol.

And lots more.

All for \$35,950—more or less.

There isn't another timesharing computer on the market that'll give you this much power and flexibility with 7.5 megabyte capacity and 8 ports for this small a price. \$35,950—and that's for a single unit. You can pay a lot less, in quantity. Of course, we have larger configurations too.

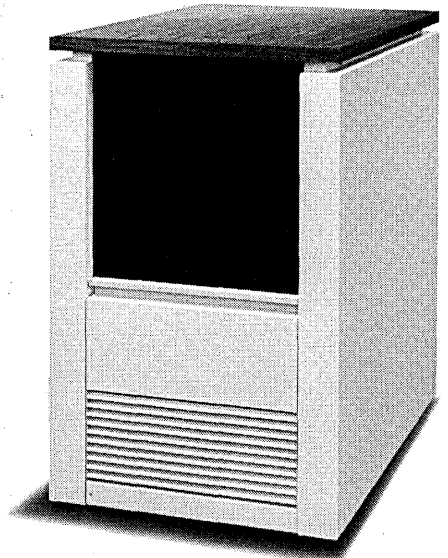

Call or write for complete details on the 4000 models and all their features.

The BTI 4000 helps you make sale after sale after sale.



**Basic Timesharing Inc.**

Home office: 870 West Maude Avenue, Sunnyvale, California 94086. Sales offices: East: Cherry Hill, New Jersey (609) 795-2334; Southeast: Atlanta, Georgia (404) 433-0900; Midwest: Minneapolis, Minnesota (612) 854-1122; West: Sunnyvale, California (408) 733-1122

## DATA BASE ISN'T

management software to maintain data independence and to provide maximum control over the physical structure of the data base.

The storage and processing system reflects the basic work structure of the company. It represents internal departmental functions and recognizes the logical interrelationships between departments. Its view of the company is the one which recognizes all the intricacies of how work flows from department to department in terms of basic activities and tasks. Yet in a very real sense, the processing and control system ignores departmental boundaries, concentrating instead on tracking the logical relationships among work tasks and their related costs and schedules.

While an application systems environment can be adequately supported by a data processing department which just writes computer programs, key-punches computer input, runs the computer, and decollates and distributes computer reports, the data base systems environment requires something more. A conventional data processing department performs a basically clerical role in support of many individual computer applications while under the db environment it must have a company-wide responsibility for

managing data base input, data base output, and data base storage and processing activities. While the responsibilities of this new kind of dp department may appear to be simpler than those of a conventional dp department, this is definitely not the case. Some functions like computer operations, keypunching and programming may overlap, but rarely will the technologies involved be the same, nor will there be compatibility in the overall skills or internal controls required within the departments.

Perhaps the most important difference between the roles of the "old" and "new" data processing departments stems from the simple fact that

**An MIS department must play an active role in determining how a company can be most productively managed.**

in the data base systems environment, functional management does not have direct control over storage and processing. It manages systems which provide input data, and it creates a demand for output, but it is up to the dp department to provide the capabilities to cross the bridge between input and output. To do so, "DP" (which often gets the new title of "MIS" at this stage) must have a staff which understands as much about the business as it does

about data processing. Why? Because an MIS department functioning in a data base systems environment *must play an active, supportive role in determining how a company can be most productively managed.*

Regular data processing departments are rarely staffed to perform this role, nor are they looked to for management guidance. They are generally passive, service organizations. As a result, they cannot function effectively in the environment which data base management creates, nor can they be called upon by management to develop that environment. The skills and basic understanding just do not exist.

Data base development, for example, will rarely follow the same course as traditional application development. It will *not* start with the general accounting systems because these systems are all "summary" systems. True data base development must start with the "base" data in the company. This data is always found at the lowest level of resource scheduling and costing. But here companies are most complex, most functionally diverse, and most inconsistent. Here, too, are vast quantities of data which must be correlated and managed properly, and which must be combined, summarized and extended for *both* financial and operational management.

The political, economic, business,

# The computer data visualizer

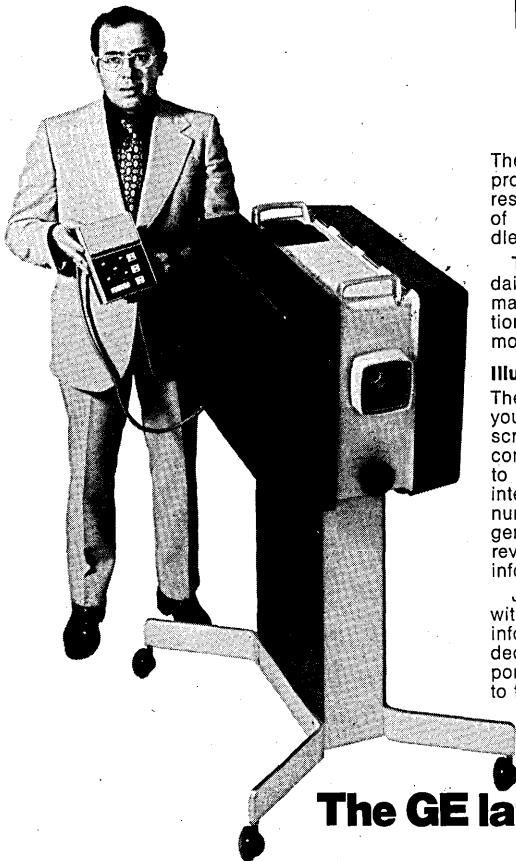

The ever growing use of data processing is providing an important planning and analysis resource for executives in a broad spectrum of business: from bankers, to bakers, to candlestick makers.

The computer's expanding involvement with daily operations produces a wealth of information that often requires frequent presentation to groups of six, sixty, or six hundred or more people.

### Illustrate your data bank

The most valued and versatile component in your information system could be the large screen color television projector . . . the incomparable General Electric PJ5000. Coupled to your computer facilities through suitable interface equipment, it can project Alpha-numeric data, graphic displays and computer generated images, in real time, for instant review and analysis. In addition, it can project information from all standard video sources.

Just visualize a 2 to 20 foot wide TV screen with fast breaking investment data, or sales information for immediate discussion and decision, being presented in color. Or corporate strategy ideas being immediately fed to the computer and their likely consequences projected as "war game" conclusions in TV graphs and charts.

All the advantages of utilizing computer data bank information as a decision making resource are greatly magnified by the use of large screen TV projection. The GE PJ5000 is designed to deliver a dependable professional performance with ease of operation. The GE exclusive single gun, single optical path system projects bright, natural color pictures with inherent color registration, on large screens for front or rear projection.

The PJ5000 is easily transportable and ready to move from your board room, to any other location, and it operates from standard 120v/20 amp appliance outlets. Its compact, self-contained Control unit can be removed from the projector, for remote set-up and operating control, with the addition of an accessory control cable.

The PJ5000 solid-state, high brightness, color video projector is engineered for excellent picture quality and power efficiency, with ease of operation, maintenance and service.

To find out more on how to present your data in a dynamic new light, call (315) 456-2562 or 456-2533 today, or write to:

Video Display Equipment Operation  
General Electric Company  
Electronics Park, 6-206  
Syracuse, New York 13201

**The GE large screen color TV projector... PJ5000**

GENERAL  ELECTRIC



# "OMR..."



## ...for decentralized data collection ...as accurate as verified keypunch

Yes, as accurate as verified keypunch . . . and source data used directly, so there are no delays or errors in entering data. Plus . . . a series of powerful off-line edits (on-line too!) mean a "smart OMR" and improved quality of computer reports.

With a Bourns Optical Mark Reader, you get a really good deal. You get faster turnaround on input data with source data entry. You spend less because OMR data entry preparation is just one step. You improve accuracy of data entry because OMR intelligence comes before your computer.

What else? Well, how about an entire company dedicated to solving your problems. From application, card design, programming, and field service to the guys and gals at the factory, we have a whole bunch of people just waiting to do their best for you.

For the latest in "smart OMR's," why not call today? It might make your life a little less complicated. Bourns, Inc. — Management Systems Division  
12155 Magnolia Avenue, Riverside, CA 92503  
Phone: 714 781-5437



CIRCLE 28 ON READER CARD

## DATA BASE ISN'T

management and computer skills needed to successfully and properly construct a data base rarely exist in a conventional data processing department. They must be built in by management. And once they are built in, management must back up its intent by establishing the authority and responsibility, both functional and financial, needed by the department to establish and manage a data base systems environment.

A company which intends to develop an efficient and cost-effective data base environment must be prepared to adopt and implement the following general guidelines:

1. The data base must be built for the whole company, not for individual managers.
2. Data base development must follow a logical, well orchestrated plan, not the path of least resistance.
3. Data processing must be intended to improve overall productivity by supplying accurate information based on management needs, not justified through cost reductions based on personnel replacement.
4. Management must concentrate primarily on identifying the information it needs to manage.

5. MIS must control what is stored on the computer and how.
6. Company input responsibilities should be established and funded separate from output needs.
7. MIS must be given increased responsibility for input control and data integrity and accordingly, authority for defining and obtaining required input.
8. Investments in hardware, software and personnel must be based on the needs of the data base control systems, not on requirements for specific applications.

Many of these guidelines appear to be heresy, and from the perspective of the applications approach, they are. They define new roles for MIS and functional management in relation to the computer. They define new responsibilities and authorities for both. And, they require a major psychological re-orientation. However, without them "data base" is unobtainable; it is a myth. As long as it is a myth, companies will continue to suffer from the computer, rather than obtain the benefits which logic and experience tell us are there.

Data base is the future. Any company which intends to grow and prosper must, sometime during the next 5-10 years, move away from application systems toward data base systems. To do so it will have to commit itself

financially and functionally to a path of migration to data base. This will be a major commitment, not to be taken lightly. It will require a whole new philosophy about what role computers, systems, and data processing personnel really play in company management. But more than anything else, it will require a positive and aggressive program to change attitudes and ideas in both functional and data processing management. \*

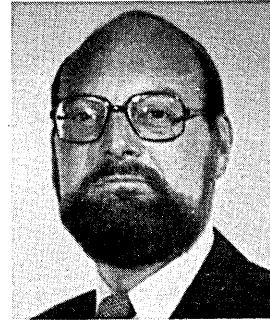

Mr. Appleton is director of management information systems for the Byron Jackson Pump Division of Borg Warner Corporation. Previously, he was the manager of systems development for Litton Ship Systems, a manufacturing systems consultant and an operations research analyst for the Assistant Secretary of Defense (Comptroller) and the Westinghouse Airbrake Corporation.

## MEET OUR COOL HAND LUKE

THE LOW COST PERFORATED PAPER TAPE READER WITH THE COOLEST, MOST EFFICIENT MOTOR IN TOWN

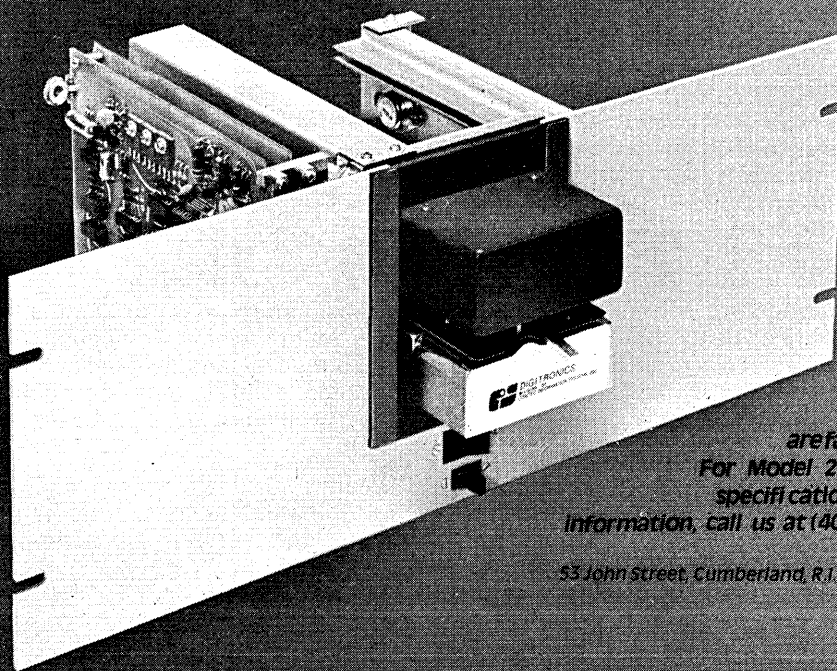

Paper tape readers may look alike, even perform the same basic functions. Comtec's Model 2100 gives you something extra: a unique power conservation system which reduces motor operating temperature by 30°C or more. Which means longer life, increased efficiency, more for your dollar investment. This photoelectric read station with its high-speed tape drive system is available in three versions: unidirectional, bidirectional and transport. Polarity of control inputs are factory wired to customer specifications.

For Model 2100 catalog specifications or more information, call us at (401) 724-8500. Or write to:

**COMTEC**  
INFORMATION SYSTEMS, INC.

53 John Street, Cumberland, R.I. 02864 Phone 401-724-8500/TWX 710-387-1171



# The Powerhouse Plugs.

They really boost the performance of your IBM 3270.

The "plugs", of course, are attached to our famous Genesis One G77™ Display Terminal and G-Series Printer. The units which have proven to be most compatible with the IBM 3271/3272 Model 2 Controllers, the System/3 and the 3790.

You expect our peripherals to cost less than their IBM counterparts. And they do.

But price isn't the only important reason why our units are breaking sales-records everywhere.

Just as important are all our extra features that squeeze so much extra performance out of your IBM systems.

Here are some of them:

**G77 Terminal:** Flicker-free Display. Two LSI Memories. Home Key. Repeat Key. Automatic Variable Initialization. Blinking Cursor. True Upper & Lower Case. Numeric Lock. Audible Alarm. Key Lock. 15-Key Numeric Pad. Light Pen. Badge Reader.

**G-Series Printer:** Super Speed (3 Models: 88, 120, 165 CPS). Vertical Forms Control. Adjustable Forms Tractors. Audible Alarm. Automatic Motor Control.

Our peripherals have *proven* their plug-in compatibility, reliability and super-performance in hundreds and hundreds of installations. Send in the coupon and let us prove

it to you. Genesis One® equipment is sold and serviced in Canada, Western Europe and Australia by MAI International Corporation.



**GENESIS ONE** an MAI company  
COMPUTER CORPORATION

300 East 44th Street, New York, N.Y. 10017

- Send me your literature. 1-2-1  
 Phone me to set up a demonstration. (Phone No.) \_\_\_\_\_

Name \_\_\_\_\_

Title \_\_\_\_\_

Company \_\_\_\_\_

Address \_\_\_\_\_

City \_\_\_\_\_ State \_\_\_\_\_ Zip \_\_\_\_\_



# For those who'd rather travel light, The Xerox Executive Printout.

People accept big, clumsy, hard-to-read printouts because they think they have to. That's the way computers print, isn't it?

You know better. With a Xerox 1200 you can give them what they didn't know they could have—letter-size reports as easy to read as the text on this page.

The 1200 is a lot faster than your clattery old line printers. Works either on or off line.

Overlays let you print forms and data at the same time, so there's no

longer any need for preprinted forms.

Keep some line printers for yourself if you like, but give your reading public a surprise present:

Executive Printouts.

For information on the 1200 Computer Printing System, call (213) 679-4511, Ext. 2409, or write Xerox, Dept. A1-15, 701 Aviation Blvd., El Segundo, CA 90245.

## XEROX

# THE DATACORP DIFFERENCE

## We make COM live up to its potential.

**M**ost COM hardware is just pure promise – until you apply the programs and training to make it a winning system. Our business isn't making the hardware. It's making the hardware work.

**O**ur solutions are proven because we've been there before. We've got over 2000 customers... many had problems similar to yours. We've solved them all – and we can solve yours

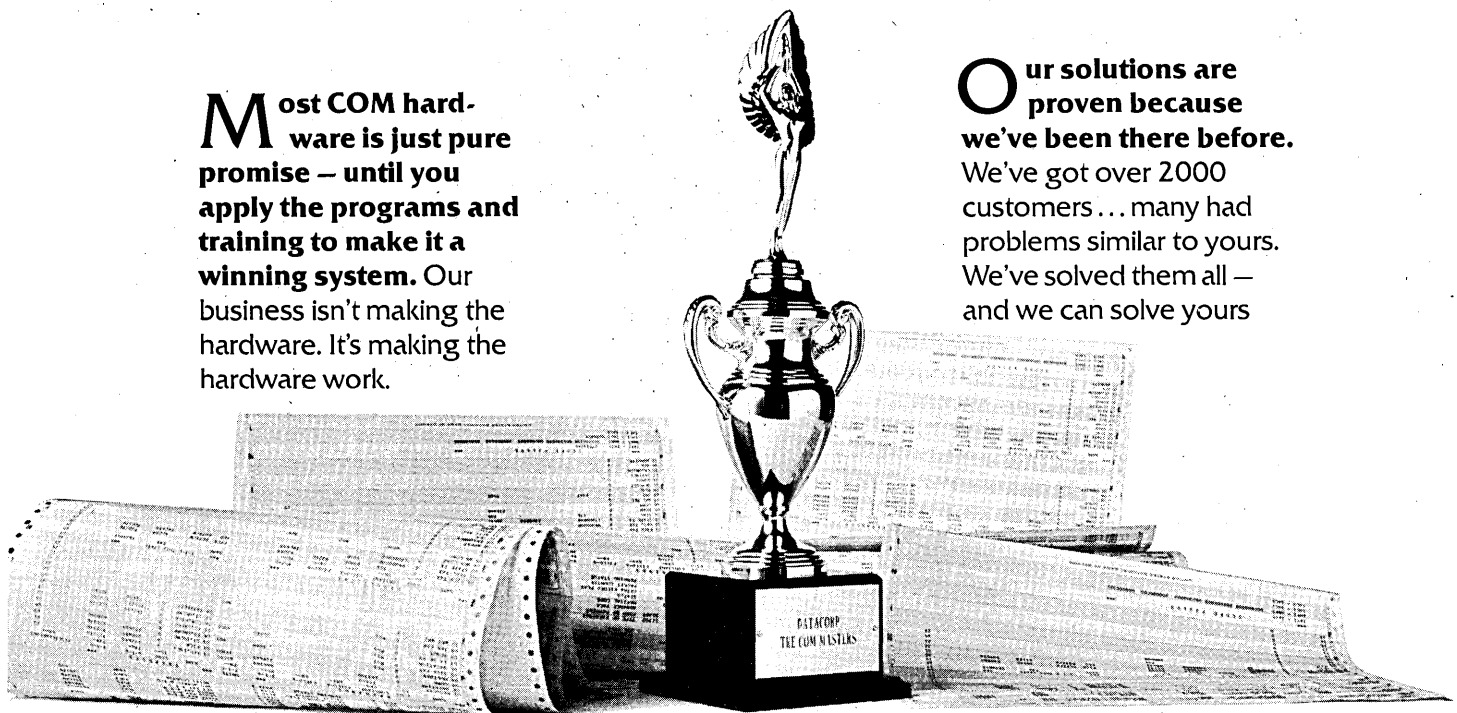

**T**hat's our only business. As the world's biggest user of COM, with 35 service bureaus, we're specialists at designing COM systems for outside service and in-house installations tailor-made to every customer.

**O**ur edge is our expertise in systems analysis and design. It's our 500 software packages to meet your specific needs. We not only offer a complete training program for your personnel, we insist on it. And as your business grows, we're right there to provide proven solutions to new application and expansion problems.

with the expertise that has made us the international masters of COM.

**Y**our COM can be a winner... after we've done the groundwork. Get off to a great start. Write Robert Ocon, vice president, Datacorp, P.O. Box 3460, Portland, OR 97208, or call 800-547-4264.

## DATACORP

# Converting From the System/3 to the System/360

by Tom Teresi

---

The move yielded better performance, lower cost, increased productivity, and the reassurance that the conversion would "stick" through many future upgrades.

---

Our company recently converted from an IBM System/3 Model 10 to a System/360 Model 30, a step that many would consider to be "backwards." Why did we exchange a seven year old computer for a machine that will be a teenager next spring (the 360 line was announced April 7, 1964)? The answer, simply, is increased throughput for less money. In truth, we received many benefits in addition to increased price/performance, including:

- a significant reduction in operating hours—reducing operator cost;
- the ability to have a "hot" partition for the programmers—increasing their productivity;
- full reader and printer spooling in two batch partitions using GRASP;
- the ability to choose vendors and products, rather than being forced to rely on one vendor. (This is especially important since IBM 360 DOS computers spawned a host of plug-compatible hardware and software at particularly attractive prices.)

Our firm is a service bureau, with major applications in label processing and general accounting. Because of our recent growth, we found we needed performance improvements in nearly every area of our computer operation. In particular, we needed faster tapes for our large sequential files,

faster printing, more disc, more core, one or more extra partitions, and spooling.

## The "more logical" choices

We evaluated the other logical (some would say "more logical") choices for upgrading from the System/3 Model 10, including the System/3 Models 12 and 15, and the System/370 Model 115. In all cases we found more throughput was made available to us, but at a significantly higher cost.

The System/3 Model 12 had several drawbacks. It has a core limit of 64K, for example; this small increase over the Model 10's 48K would not enable us to do much more work, even with the dual programming feature of the bigger machine. Additionally, the 12 allows the use of the 3340 direct access storage facility, but has a maximum disc capacity of 91.9MB; though this was nearly ten times our present capacity, it was not adequate to support our near term growth projections.

The Model 15, top of the System/3 line, was also rejected for several reasons. The first was excessive cost. A Model 15 configuration comparable to the 360/30 we finally chose would have cost about \$9,100/month, nearly twice the 30's cost.

Second, the 15 has a maximum tape speed of 80KB. The 360's tapes are 125% faster and 82% less costly. Also, although the disc transfer rate of the

15 is very fast (885KB), any work involving both disc and tape would often run only at the speed of the tape drive (in many cases, a computer is only as fast as its slowest peripheral).

Third, the Model 15 has limited growth potential. Once we outgrew it, we realized that we would be faced with another even bigger conversion. Also, we doubted that the System/3 architecture, even at the Model 15 level, could match the performance of either a 360/30 or a 370/115 with DOS multiprogramming.

The System/370 Model 115, on the other hand, represented a costly jump into the DOS/VS world. Although it was technologically attractive, we rejected it because: (1) Again, excess cost. The 115 was configured at over \$11,000/month. (2) There would be no choice of vendors, none of the plug-compatibles available for the 360. (3) There would be no improvement in RPG II; the DOS/VS RPG II is the DOS RPG II compiler. And partly because of that, (4) there would be no special advantage, as a result of the switch, for the applications programmer. Finally, (5) our shop has thus far developed no need for virtual storage.

Instead of any of those, we chose the 360/30 to solve all our throughput constraints at once. An added advantage was that this conversion will be our "last." Now that we are running under DOS, we may install a 360/40,

(Continued on page 102)

# chart your own course in data communications.

Harnessing computer and communications technologies...powers the way to more productive operations. Our fifth national conference INTERFACE '77 is the critical event for putting you on the right course in data communications. For beginners, our DATACOMM school emphasizes decision-making rather than technical details. More experienced computer or communications users have networking and management workshops plus product and service updates describing how to create, expand and optimize approaches. Datacomm sophisticates choose highlight sessions and technology workshops addressing the latest advances. And for everyone, applications workshops concentrate on key areas such as EFTS, electronic mail, distributed computing, time-sharing approaches, and more.

175 such pro's will show you the way to data communications productivity.

1  
70  
super  
sessions

2  
175  
knowledgeable  
speakers

3  
100's of  
products  
shown

4  
over 5,000  
differend  
share  
experiences

5  
creative  
solutions  
for your  
operations

6  
exciting  
Atlanta  
awaits

**Ralph Berglund**  
Data Communications Consultant

**Bernard Strassburg**, Communications Consultant  
Former Chief FCC Common Carrier Bureau

**Dr. Dixon R. Doll**, President  
DMW Telecommunications Cor

**Dr. Howard Frank**, President  
Network Analysis Corp.

**John Eger**, Former Acting Director  
White House Office of Telecommunications Policy

**Dr. Leonard Kleinrock**, Professor  
Professor Computer Science, UCLA

**Howard Cravis, Sr.** Telecomm Staff  
Arthur D. Little, Inc.

**The  
Critical  
Event**

**CALL TOLL FREE (800) 225-4620** For instant registration  
or additional information  
Within Massachusetts, call Collect (617) 879-4502

**DATA COMMUNICATIONS  
INTERFACE '77**  
Atlanta Georgia  
March 28-30, 1977  
Co-Sponsored by  
**DATAMATION** Magazine



**CONFERENCE REGISTRATION** Special "team rate" discounts are applicable when you register 3 or more persons from the same location of your organization.

<b>Registration Fee</b>	<b>3 Full Days</b>	<b>Single Day</b>
1st and 2nd attendees, each	\$95	\$50
3rd and more attendees each	\$50	\$25

use a separate coupon for each member of your organization, make copies for additional registrants.

Name \_\_\_\_\_  
Title \_\_\_\_\_  
Organization \_\_\_\_\_  
No. and Street \_\_\_\_\_  
City \_\_\_\_\_  
State \_\_\_\_\_ Zip \_\_\_\_\_  
Telephone ( ) \_\_\_\_\_

**CONFERENCE REGISTRATION  
HOTEL RESERVATION COUPON**  
Mail today to  
**INTERFACE '77**  
160 Speen Street  
Frammingham, MA 01701

- Please check the entry that describes the end product service of your organization your location
- Banking
  - Insurance
  - Securities
  - Business Services
  - Service Industries
  - Wholesaling
  - Transportation
  - Retailing
  - Manufacturing
  - Process Industries
  - Power Utilities
  - Law Enforcement
  - Education
  - Health Care
  - Government
  - Manufacturing (Data Communications or Computer Related)
  - Communications Utility

CHOICE HOTEL	Single	Double	Suite
Atlanta Hilton*	29-55	30-60	94 UP
Atlanta International	22-27	27-35	85 UP
Holiday Inn Downtown	24-27	33-36	70 UP
Atlanta American	25-29	29-35	60 UP
Hyatt Regency	30-45	38-53	—
Sheraton Biltmore	26-30	32-38	85 UP
Peachtree Plaza	33-46	43-56	100 UP

My registration check is enclosed and payable to  
**DataComm Interface, Inc. for \$ \_\_\_\_\_**

Please bill me    Send additional information

*In the event of cancellation, registration fee will be refunded if notice is received prior to March 1, 1977. If received after March 1, 1977, fee will be applied toward registration for INTERFACE '78.*

Estimated Arrival: Date \_\_\_\_\_ Time \_\_\_\_\_ Departure: Date \_\_\_\_\_ Time \_\_\_\_\_



# If you make top-quality data terminals, here are four reasons to use Setchell Carlson CRT display modules in your system.

**Reliability:** Our data displays are outstanding solid-state designs with critically matched magnetics to optimize the performance levels and dependability demanded by your customers. We use the most advanced engineering and production techniques to assure consistency of performance. No data display is built with more deliberate attention to quality and reliability.

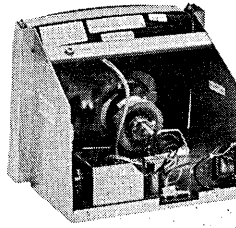

**Delivery:** We have been in the display electronics business long enough to know about rush orders. If you need it yesterday — we'll try to get it to you yesterday.

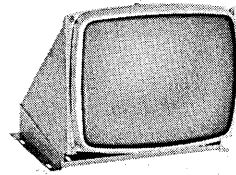

**Experience:** We've built thousands of displays for many of the major manufacturers in the country. Perhaps we already have a unit that would meet your requirements. With slight modifications. It would be less costly than starting from scratch. If you need a new, special package — we'll produce it for you, in the configuration you want, at minimal expense.

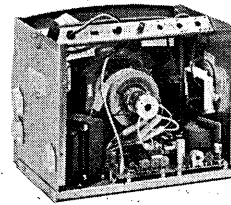

**Cooperation:** If you're developing a new data terminal, we will be glad to cooperate with your terminal design engineers in reviewing your exact specifications and developing the most economical display possible. And quickly! Whatever you need, we have the experience and talent to design it. And improve it.

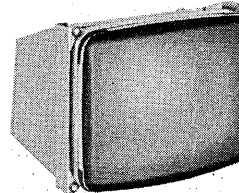

But don't take our word. See for yourself by contacting us today.

You'll come up with your own reasons for using Setchell Carlson CRT display modules.

**SC ELECTRONICS, INC.**  
A SUBSIDIARY OF AUDIOTRONICS CORPORATION  
530 5th AVE. N.W. NEW BRIGHTON, MN. 55112 (612) 633-3131

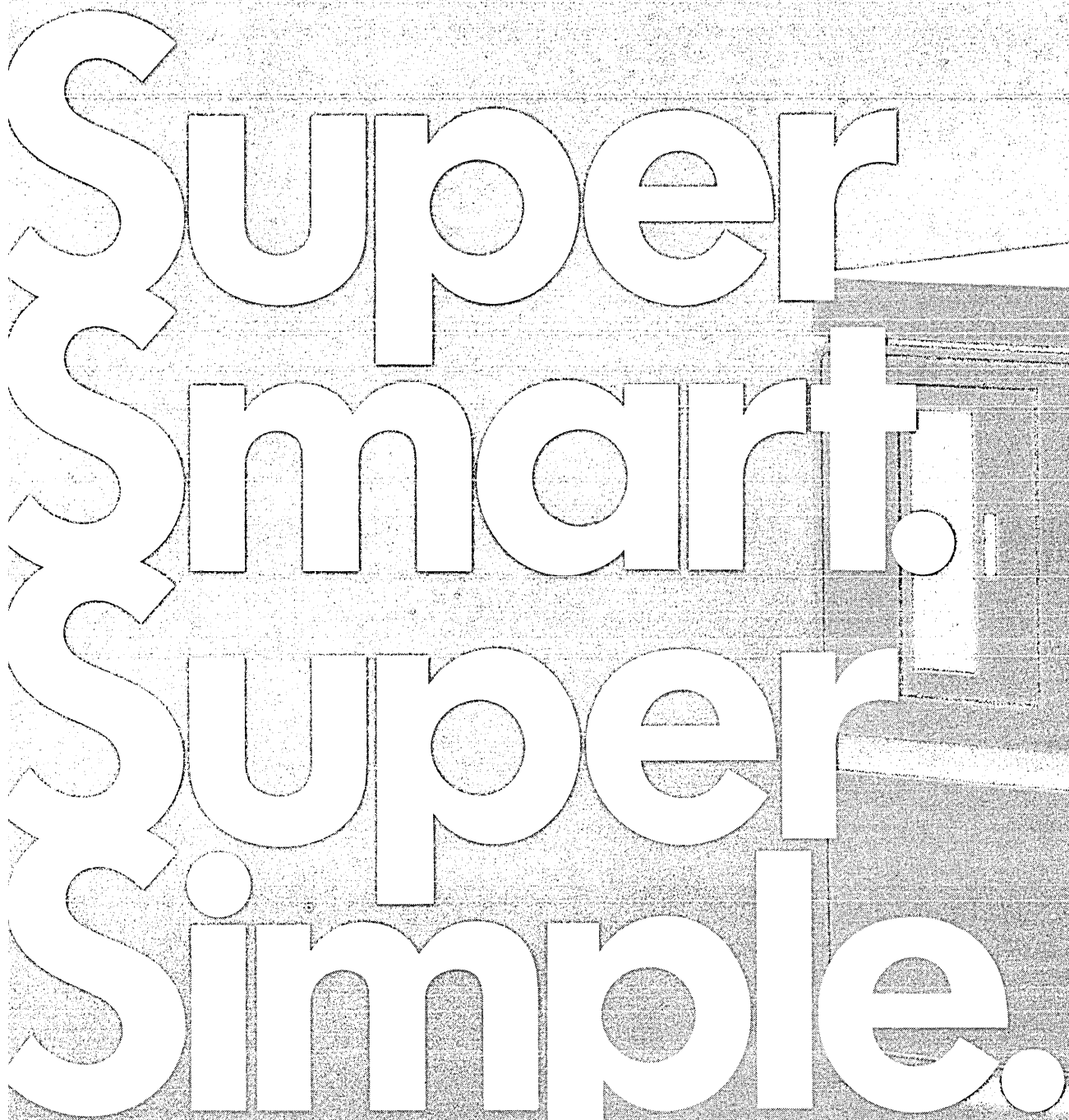

# Super Smart. Super Simple.

Together for the first time in ADDS New System 70.

How smart is smart? The answer is simple.

ADDS new System 70 is a powerhouse that can SEARCH, VERIFY, COPY, SEND, RECEIVE, and PRINT the day you plug it in. It's all pre-programmed on dual microprocessors. That's smart.

And simple. Because to get System 70 to SEARCH, all an operator has to enter is the word SEARCH. We call it TCL; our Terminal Command Language. You'll call it EASY.

Smart is simple in more ways than one. Sometimes you want to take advantage of automatic data entry functions like arithmetic extensions, must-fill fields or check digit calculations. With System 70 you customize forms yourself, right on the display; without assembly or debugging of complicated programs. It's that simple.

And smart. System 70 is IBM 3780 or teletypewriter compatible. It has single or dual

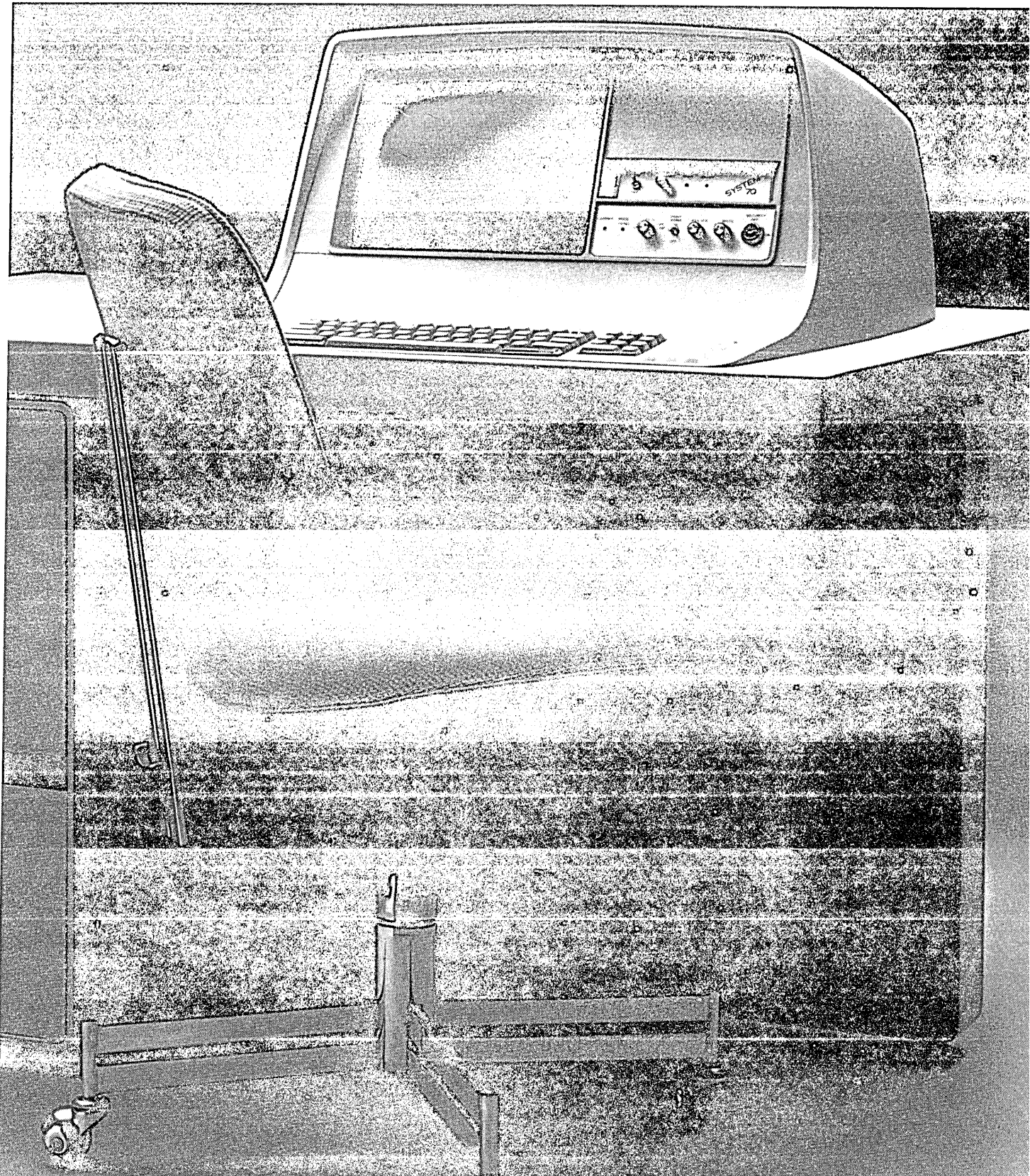

diskette drives which are IBM 3740 compatible. And our line of optional printers can put it all on paper at a reserved 30 characters-per second up to a snappy 300 lines-per-minute.

What does all this power cost? Practically peanuts. System 70 is under \$7,000 in moderate quantities. ADDS System 70.

Smart and Simple together mean more power to you.

**ADDS** Applied Digital Data Systems Inc.  
100 Marcus Blvd.  
Hauppauge, N.Y. 11787 (516) 231-5400

Please send more information about System 70:

Name \_\_\_\_\_  
Firm \_\_\_\_\_ Title \_\_\_\_\_  
Address \_\_\_\_\_  
City \_\_\_\_\_ State \_\_\_\_\_  
Phone \_\_\_\_\_

# CONVERTING

50, 65, 370/135, 145, or even a 158 without any change to our programs, files, or JCL. Also, these larger computers can be "plugged in" without one day of dual rental.

## Making the switch

We invested about one man-year in the conversion. We approached the change with the idea of limiting the

tation had to be updated, too, and all the files converted.

We studied the following IBM manuals to establish our conversion plans:

- Moving from System/3 to dos/vs (gc33-5389)
- IBM S/3 RPG II to IBM S/360 or S/370 dos Conversion (sc21-5066)
- S/3 RPG II to S/370 RPG II Conversion Aid (GB21-1389)

We found that the S/3 and DOS RPG's are somewhat different because of the

and the staff was further trained with "hands on" experience at 360/370 user installations. IBM supplied some of this time since the card reader and punch were being rented from IBM (no-charge test time is available for most on-order machines).

The DOS system software was generated at a 360 user site. The latest (and last) release of DOS (26.2) was massaged to meet our configuration. RPG II was ordered from IBM and installed on the SYSRES pack.

The conversion program was installed on our System/3. This program punched out the converted source decks which were recompiled on a DOS machine. This first recompile identified items not converted by the IBM program. The programs were fixed but not recompiled until the 360 was installed, thus saving outside test time.

Programmers and operators spent considerable time putting together new JCL run decks and preparing one-shot 5444 disc to tape to 2314 disc utilities. It should be noted here that JCL at first sight is scary compared with OCL. However, the use of DOS standard assignments, standard labels and GRASP procedures simplifies this conversion task. Also, the Autoreport sort feature of DOS RPG II was very helpful in converting unordered ISAM load programs to ordered (sorted by key) load programs—a DOS requirement. This feature thus saved us from writing numerous stand alone sorts.

Table 1 shows some of the measurable results of the "backwards" transition we made. We feel we made the right choice, acquiring a substantial increase in power and function for less money than we had been spending. Would we do it again? Absolutely! We took the road less traveled by—and yes, it has made all the difference. \* \*

## What Was Gained in the Conversion

Item		S/3 Model 10	S/360 Model 30	Increase
Core	Size	48K	128K	167% more
	Vendor	IBM & BST	IBM & FABRI-TEK	
Disc	Type	5444	23142	1681% more 976% faster
	Vendor	IBM	CDC	
	Drives	2 + 2	3 (double density)	
	Total Capacity	9,830,400 Bytes	175,056,000 Bytes	
	Avg. Access Time	269 msec	25 msec	
Tape	Transfer Rate	199KB	312KB	157% faster
	Type	3410-1	4862 (1 x 3)	
	Vendor	IBM	TELEX	
	Drives	3	3	
Printer	Transfer Rate	20KB	180KB	800% faster
	Type	1403-2	23221-21	
	Vendor	IBM	CDC	
Cost	Speed	600lpm	1200lpm	100% faster
		\$5,434/month	\$4,999/month*	

\*Included in the \$4,999 figure is all chargeable software: RPG II, the GRASP spooler, and a relocating loader (ANYPLACE). An

equivalent purchase price for the configuration would be in the neighborhood of \$110,000.

Table 1.

overlap in dual computer rental as much as possible. This dual rental cost over \$200 per calendar day and luckily was limited to just 21 days.

Moving from a System/3 to a System/360 requires about the same effort as going to a 370, and just about the same steps. In our case, we had over 600 RPG II programs plus numerous sorts and utilities to switch over.

A major task was in changing the System/3 OCL run decks to System/360 JCL. That meant all the documen-

differences in data management between the two operating systems, and therefore purchased the conversion aid (a Field Developed Program) from IBM for \$400. It proved very useful in converting source decks.

The equipment procured from the various vendors arrived within 60 days from the date of contract signing. During this two month period, a half-day class was held each week for the programmers and operators. IBM DOS was thoroughly taught during these classes

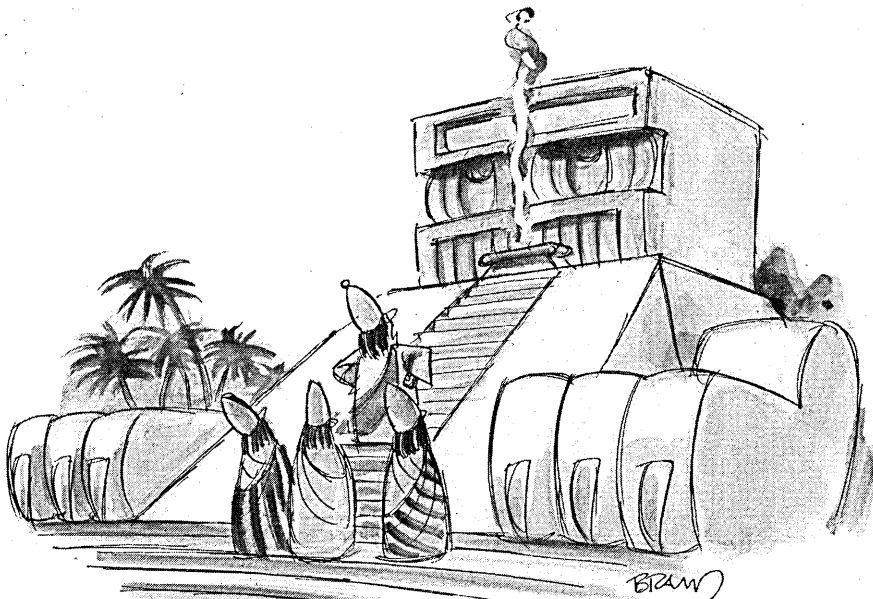

"We're trading you in for another model, Mighty One."

© DATAMATION ®

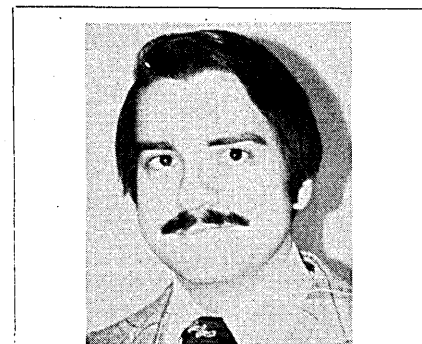

Mr. Teresi is the president of Advance Computer Systems Company, a consulting firm and service bureau located in Minneapolis. He is also the president of the Minnesota DOS Users Group. His previous positions were with IBM (systems engineer), Indianhead Truck Line (manager of MIS), and Arthur Young & Company (senior consultant).

# ECONOMY PACK



Before you buy a PDP 11/05,  
11/34 or 11/45,  
or an Eclipse\* or Nova\* system...

Check the new Interdata Pack/16 and Pack/32 Packaged Systems. They're easier to use and cost less.

Pack/16 includes a 16-bit Model 6/16 CPU with 64KB memory. Pack/32 has a 32-bit Model 7/32 with 128KB memory.

**Easier to use.** We install each Pack as a totally integrated hardware and software system. It's ready to run immediately. Each system includes a CPU with 10MB disc, 400 CPM card reader, 200 LPM line printer and Carousel 30 terminal. Plus complete software based on the Interdata multi-tasking operating system and extended FORTRAN.

**Cost less.** Judge for yourself: Pack/16 costs \$33,500. Pack/32 costs \$43,500. Prices include installation and 90-day full service warranty. And, we deliver in 30 days.

Find out what's behind our great price, write or call today for all the details . . . or your delivery date.



**INTERDATA®**

Interdata, Inc.  
Subsidiary of PERKIN-ELMER  
Oceanport, N.J. 07757

\*Nova and Eclipse are registered trademarks of Data General Corporation.

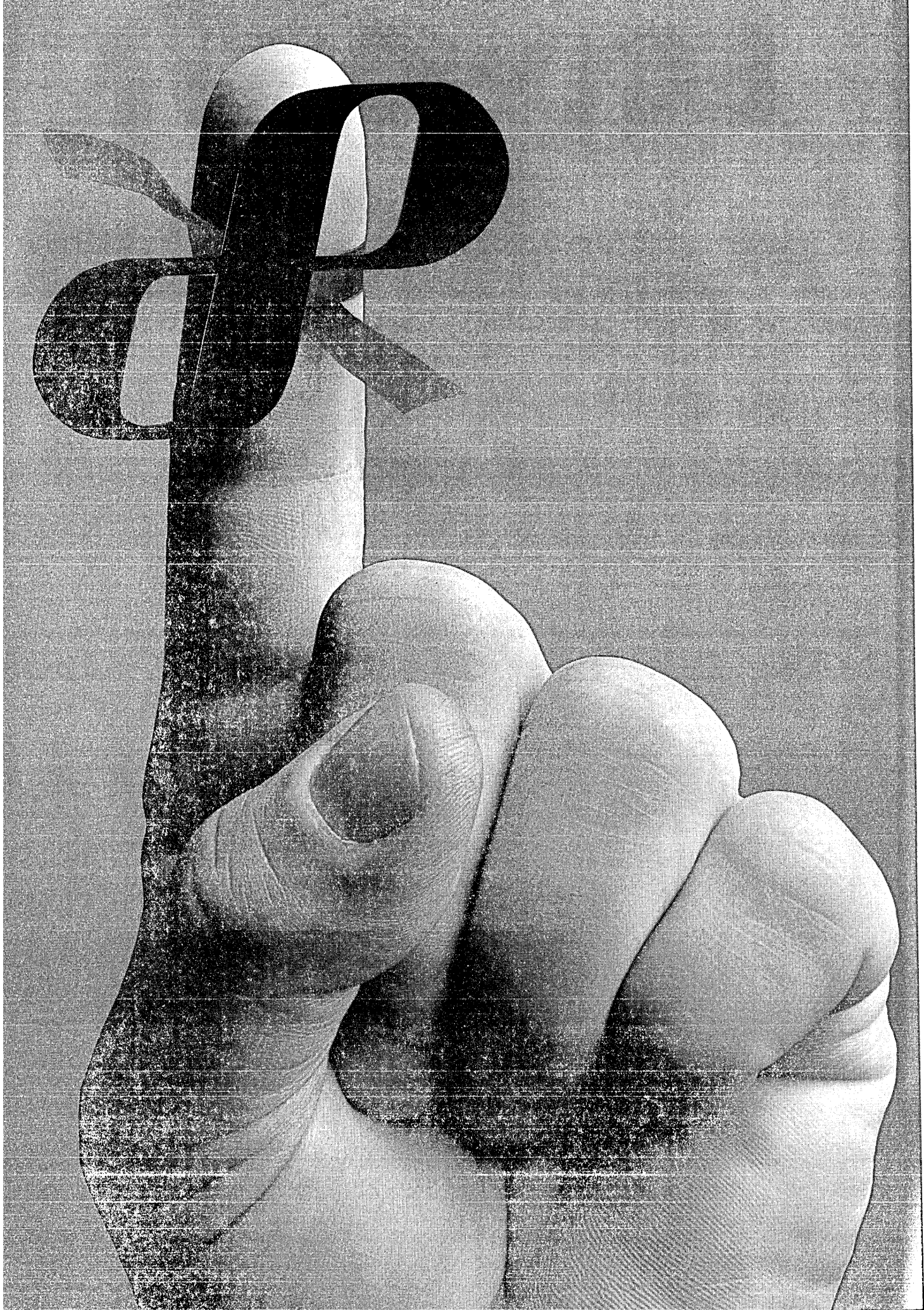

# Forget it.

If a line of line printers gave you dependable, economical operation and remarkably clear print quality, you could plug one into your system and forget it.

Dataproducts is that line.

Our 2200 family of Line Printers is worth remembering.

## Forget the 2290.

If you want a cost efficient 900-LPM printer designed to meet the requirements of the new high-performance minicomputer based systems, remember to specify the Dataproducts 2290.

Then plug it into your systems.

And forget it.

## Forget the 2260.

If you want high-quality medium speed impact printing (600 LPM), ideally suited for small computer systems and terminals, you want our 2260.

Specify it by name.

Plug it into your systems.

And forget it.

## Forget the 2230.

If you want the industry standard low-to-medium speed (300 LPM) printer with the lowest life-cycle cost of any printer in its range, specify the Dataproducts 2230.

Plug it into your systems.

And forget it.

## Forget family squabbles.

Every member of the 2200 family of Line Printers is interface compatible.

Up and down the line.

And every member offers the patented Mark IV hammer, with its life expectancy of over 4 billion impacts.

And every member of the family can print in 16 languages.



## We support our family.

You can't forget our printers unless you can count on complete aftersales support.

Count on it.

In spares, maintained for Dataproducts customers world-wide, with a new spares depot soon to be open in Europe.

In technical support, with liaison engineers

ready to help solve all printer problems.

And with printer training and complete instruction to the component level.

## The family biography.

There's much more.

Inside information, specs and key options for every family member.

Plus the 2200 family relatives like our Tempest Printers (300, 600 & 900 LPM), the 2470 (1200 LPM), the 2550 (1500 LPM) and the 2910 (Military printer).

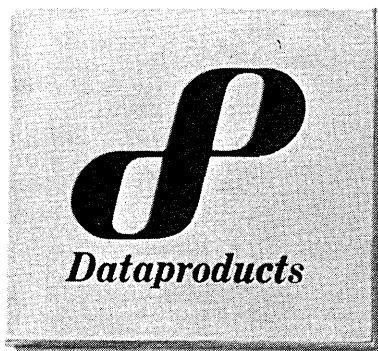

Whichever member of the family interests you, call or write for complete information.

But don't forget to remember.

N. American Sales Hq: 6219 De Soto Ave., Woodland Hills, Ca. 91365, Tel: (213) 887-8451, Telex: 69-8492.  
European Sales Hq: Darmstaedter Landstrasse 199, Frankfurt, W. Germany, Tel: 681-034, Telex: 841-416344.

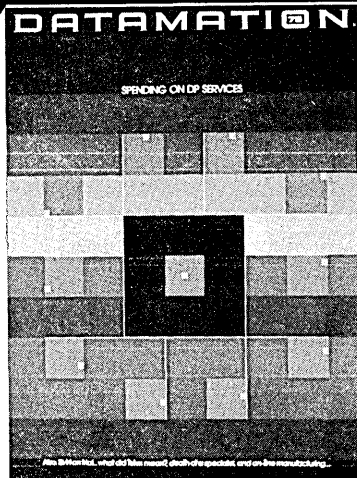

## When target selling is the aim of business, Technical Publishing Company supplies the market.

No one zeroes in on specialized industrial markets like Technical Publishing Company. Besides *Datamation*, "Technical" publishes six other national business/professional magazines: *Consulting Engineer*, *Plant Engineering*, *Pollution Engineering*, *Power Engineering*, *Purchasing World* and *Research/Development*. Each one is recognized as a prime source for technical and business information. Each one enables business to aim its selling message to a specialized audience. This targeting concept has been so successful, in fact, that last year six of our seven publications were among the top 100 specialized business magazines in advertising revenues.

Technical Publishing Company further helps business with its annual *Plant Engineering Directory and Specifications Catalog*, industry's prime reference source for product information, plus services such as specialized product postcards, mailing list rental and market research.

In addition, our TPC Training Systems provide an innovative, economical method for training maintenance craftsmen for industry, and DBI Books, Inc., (formerly Digest Books, Inc.) serves the consumer leisure market with over 55 titles devoted to sports, hobbies and crafts.

Technical Publishing Company is a growth company targeted to growth fields. We are publicly-owned and our stock is traded over-the-counter. For information on any of our properties or the company, write James B. Tafel, President and Chief Executive Officer.



**Technical Publishing Company**  
1301 South Grove Avenue  
Barrington, Illinois 60010



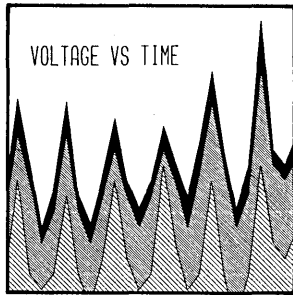
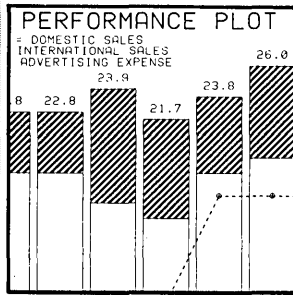

鉛地金=東京  
同=大阪  
アンチモニー=東京  
同=大阪  
すず地金=東京  
同=大阪  
ニッケル地金=東京  
同=大阪  
アルミ(99.7%)=東京  
同(同)=大阪  
同(再生,99%)=東京

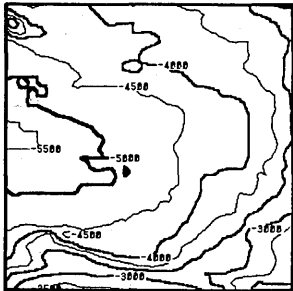

DIMENSION L(40),DX  
DATA SAME/9999./,LN  
CALL MODE(2,35,0,0,  
CALL MODE(3,18,3,-  
T UP DASHED LINES  
CALL MODE(10,FLOAT  
AW DASHED LINES  
CALL DRAW(DX,DY,2,  
T LINE WIDTH TO 8  
CALL MODE(6,8,,SAME

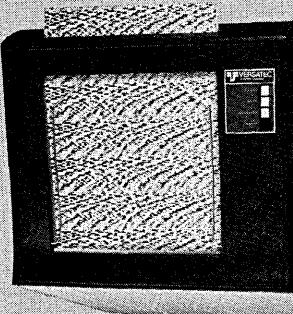

# Don't print. Write.

Versatec printer/plotters don't print. They write. And that difference means more useful, reliable, quiet output from your minicomputer.

While impact printers hammer ink on paper with a limited font, Versatec electrostatics write anything—alphanumerics in any size, style or language, graphics ranging from simple bar charts and line drawings to complex maps and geophysical plots. They give you words and pictures simultaneously without changing hardware or reducing speed.

Here is a way to compact pages of printout into a single graph. A way to isolate variables you might never see in print. A way to visualize data for better presentation.

And you can depend on continuing output. Writing is electronic, not mechanical. No impact. No type wear. No alignment problems. No vibration. And no noise. Just quiet reliability measured in thousands of hours.

Worried about plotting software? Don't be. New Versaplot/PPEP adapts your existing pen plotter graphic programs to electrostatic plotting. No software? Then use new Versaplot EPS. Its easy-to-use utility subroutines let you program graphics with simple instructions and as little as 16K bytes of core. For zero programming overhead, use the optional Versatec CRT controller or video interface. It transfers images directly from CRT to hard copy without program intervention.

Versatec has the optimum writer for your application. Thirty-six plotters and printer/plotters (more models than all competitors combined) offer the widest range of speeds, formats and resolution. Interfacing is simple with on-line controllers to match popular computers, CRTs or video sources.

With over 5,000 units installed, Versatec outsells other electrostatic units two to one. Find out why. Check our readers' service number for general information. Better yet, fill out the coupon for specific application data.



Versatec  
2805 Bowers Avenue  
Santa Clara, California 95051  
(408) 988-2800

Please send literature:

- Electrostatic Printers & Plotters
- Wide Plotters (Formats: 22", 24", 36", 42", 72")
- Hard copy direct from CRT
- Versaplot software
- The 360/370 plotting system

Please send samples:

- Print samples
- Plot samples

computer model and operating system

application

name

telephone

organization

address

city, state & zip

# There is only one OEM

1.

A Wangco Autoload Tape Drive...from Wangco's broad, high quality line of tension arm, vacuum column, and autoload models. Select speeds of 12½, 25, 37½, 45, and 75 ips, 7 or 9 track NRZI, phase-encoded or dual density format and reels of 7", 8½", and 10". Design features include IBM compatible head guide spacing, high efficiency tape cleaning, tri-level read threshold, and plug compatibility with other major industry suppliers' tape drives. The ruggedized Mod 12 shown below is especially suited for large computer mainframe system integration.

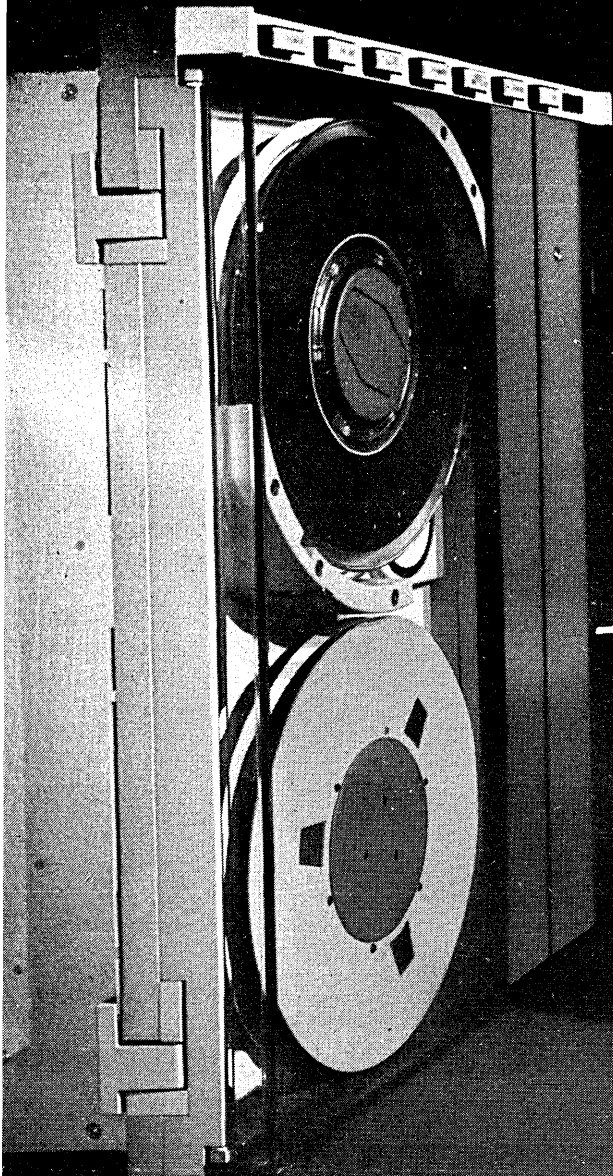

1.

A Wangco Disc Drive...front or top loading cartridge or fixed disc with data capacities from 2.5 to 20 Mbytes (100 or 200 tpi) in the smallest size configurations available. Wangco designed voice-coil positioners speed access and reduce power dissipation. The new brushless DC motor, forced air cleaning system and two-sensor temperature compensator assure highest reliability.



# peripheral for your system

## 1.

A Wangco Flexible Disc Drive...with access time of 6 ms track to track for a 164 ms random average seek. Single and dual density encoding can be accommodated in the same drive with selectable sector options including IBM and expanded soft sectoring, 3/2 hole hard sectoring, and sector generation. Reliability features include an IBM-type ceramic head, low friction Uni-ball positioning, die-cast mainframe and open and closed door interlock. MTBF is 5000 hrs. Power consumption is only 45 watts.

## 1.

A Wangco Tape or Disc Subsystem...hardware, firmware, and software, for PDP-11 and Nova minicomputers. Wangco offers more subsystem configurations for the OEM than any other manufacturer to the user (this means single source systems with components designed together to work together as well as rapid delivery and substantial cost savings).

## 1.

A Wangco Magnetic Tape Formatter...containing all required logic to read and write IBM compatible 1600 cpi phase encoded and/or NRZ mag tape. Requiring only 5 1/4 in. of vertical rack space, each formatter can control up to four 7 and/or 9 track tape drives.

The one OEM peripheral for your system is from Wangco. For more information contact Wangco, Inc., 5404 Jandy Place, Los Angeles, CA 90066. (213) 390-3031. In Europe write or call Wangco, Inc., Postbox 7754, Building 70, 1st Floor, Schiphol-Oost, Netherlands. (020) 458269.



**WANGCO**

A DIVISION OF PERKIN-ELMER DATA SYSTEMS

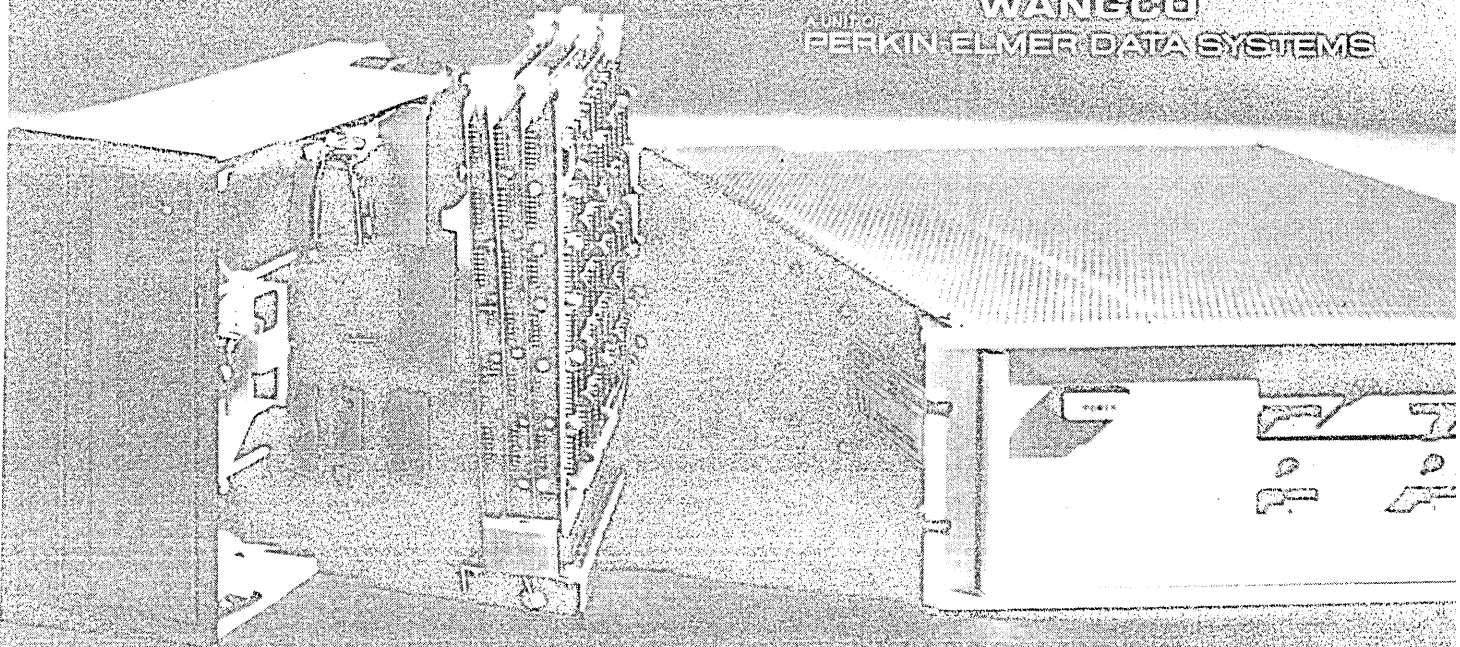

ORDER BY PHONE READER CARD

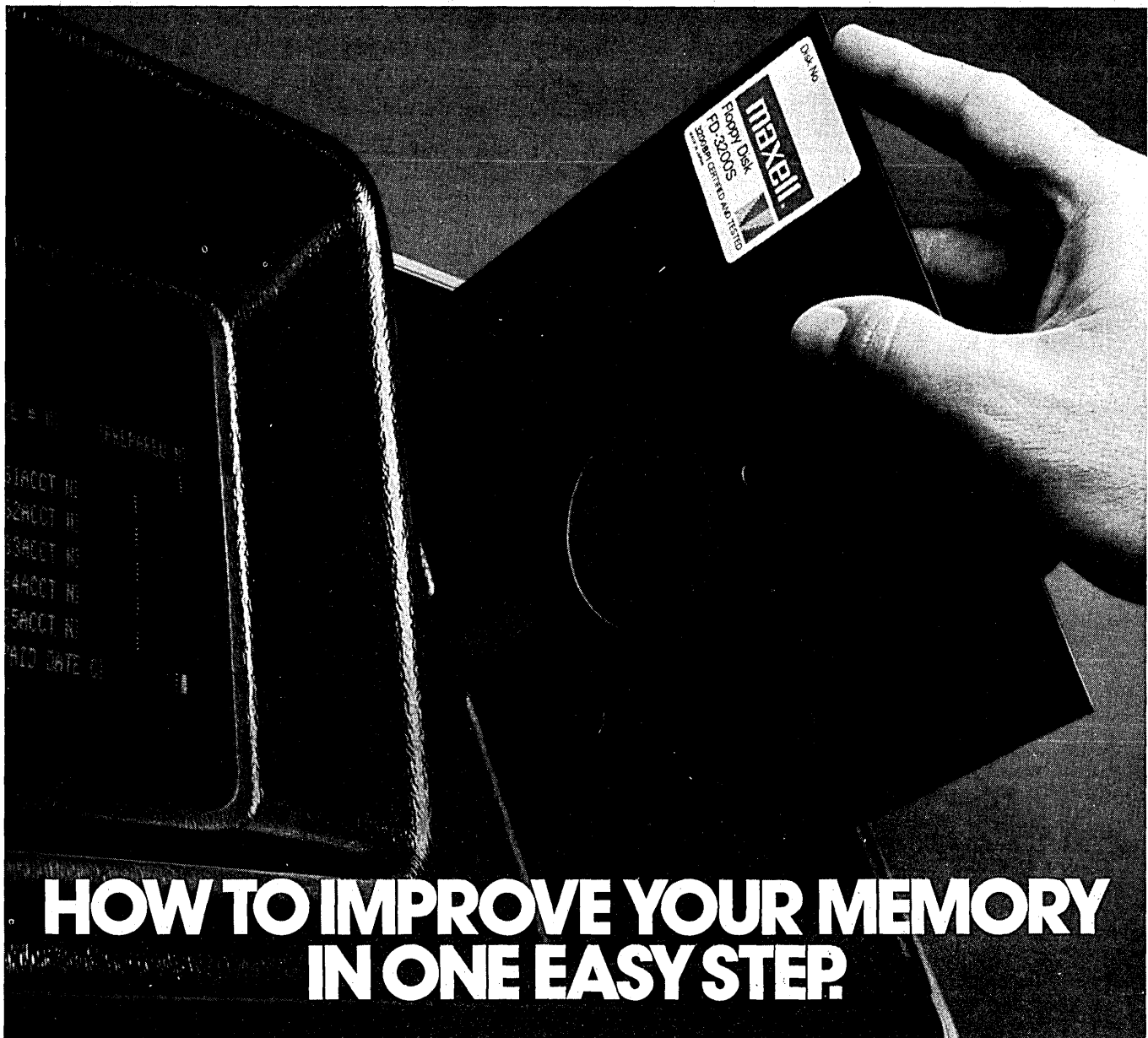

## HOW TO IMPROVE YOUR MEMORY IN ONE EASY STEP.

If your computer ever suffers from a lapse of memory, here's what you can do to help:

Always remember to use Maxell magnetic products. Because we put a lot of things into them to ensure that nothing ever drops out.

Our digital cassette tape, for example, is so good some of the biggest OEM's in the business use it.

And we firmly believe that our new floppys are every bit as good.

They're made to the strictest ISO and IBM Diskette specifications.

They're made of computer grade, super-fine magnetic materials for high density recording at 3200 BPI.

And they have a specially developed binder for improved particle dispersion and an incredibly smooth coating surface.

So if your computer has a problem remembering things, contact a Maxell sales representative and ask about the data products with the good memories.

But you better do it soon. Before you forget.



# From COBOL to MARK IV

by Jim Flynn and Dick Kimber

---

From spending nearly 100% of the staff's time on maintenance, the department went to spending 90% on new development—with less effort too.

---

Typically, when a company's business requirements are fulfilled, top management tends not to place a high priority on solving data processing problems, until those problems begin to adversely affect business activities—as they did at McCulloch Properties, Inc., of Fountain Hills, Arizona. McCulloch is a \$60 million per year land development firm, best known for its Lake Havasu City project in Arizona. That development alone currently boasts two million vacationers yearly, 635 full-time businesses, 15 governmental agencies—and the famed London Bridge.

To 1973, McCulloch had used COBOL-based systems to handle its Havasu project and others. Through the years these systems had become a potpourri of modifications, and increasingly difficult to operate.

The Land Sales System is a good example of what happened. It was relied upon to service 60,000 land contracts, disburse commissions for about 1,000 salesmen, and track the activity of 70,000 land parcels from the initial recording of the Havasu project to the sale and deeding of the last lot.

The system was being supported by literally hundreds of files and programs which had evolved over a period of ten years and had gone through four conversions (one program conversion, two hardware conversions, and a DOS to OS conversion). Through it all, the architecture of the original card system survived. The average daily cycle alone, for example, attempted to process 4,000 transactions through 250 programs and 130 different files. Holding true to tradition, the supporting documentation and programmer knowledge decreased exponentially with time, so that even the most basic modification was approached in a defensive manner

and isolated as a standalone subsystem whenever possible.

All of the existing systems, including Land Sales, shared the following limitations: inflexible file structures, lengthy and complex programs, little or no file integration, and time-consuming report creation or change. Other characteristics which seem naturally to evolve with time, personnel turnover, and changing business climates were: redundant data in multiple master files, mysterious program and file relation-

---

Over ten years, through four conversions, the architecture of the original card system survived.

---

ships, and useless or nonexistent documentation.

Gradually management took an interest—was forced to take an interest—in the MIS department's activities. The choice became clear: continue maintaining obsolete systems or develop new ones. Of course the latter was chosen.

## Questioning COBOL and others

It was then that McCulloch's dp personnel began to seriously question the continued use of COBOL as the shop's primary language. To begin with, COBOL did not promise to reduce the limitations which were just mentioned for the previous systems. Additionally, all reasonable time and cost targets established for the development of the proposed new land system were handily exceeded in projections which assumed COBOL as the programming language.

In considering the use of another programming language, it was determined that the language selected must

have the ability to: be as hardware independent as possible, include a relatively simple query capability in order to provide for some level of open-shop programming, and support future on-line applications.

It was further determined that the language would have to have been an established, proven product; and, in view of the constantly changing application problems of the land development industry, it would have to have the capability to support variable index sequential (VISAM) files.

Informatics' MARK IV was ultimately selected for use in the proposed system. As a data base management system, it assured the company of a sophisticated and flexible method of data organization and, as a programming language, of responsive processing and retrieval of the data.

In addition, MARK IV appeared to be simple to understand and seemed to offer the potential of drastically reducing the time and cost estimates made under COBOL.

During the language evaluation process, the department found itself with many alternatives, looking at TOTAL and IMS as data base managers, and at programming languages such as PL/1.

The other data base systems reviewed were more powerful in terms of flexibility in physical structure and interaction with data bases. From a practical business standpoint, however, many batch systems like ours cannot use such extensive extra power.

In addition to requiring a significantly greater development cycle, these more powerful systems are more complex in their call routines and segment manipulations and consume more of the hardware resource. Finally, they require the use of a program language (COBOL, PL/1, or BAL) which already

## TO MARK IV

had been rejected because of time and cost constraints.

In accepting MARK IV, the only disadvantage identified was the retraining of MIS personnel. This problem was solved partly by Informatics' training course and partly by time.

MARK IV's automatic features have removed many routine data management and programming tasks, shortening the coding portion of the development cycle and eliminating the need for much attendant testing and debugging. Some of the more prominent automatic features that have simplified our operations are:

- reading and writing of records
- segment manipulation
- file coordination
- transaction matching and updating
- table look-ups
- report formatting and sequencing
- text processing
- field conversions/elimination of data exceptions
- sequence checking of files
- job statistics
- understandable diagnostics

Ironically, the very features of MARK IV which reduced the complexities of file structures and program coding so dramatically also raised some unex-

pected problems once the development of the system was underway. By hindsight, these problems were predictable and are best identified as a number of syndromes frequently found in dp personnel.

### The "Hear No Evil" Syndrome

To its surprise, McCulloch discovered that its dp department was as reluctant to accept change and innovation as any of its more traditional business functions.

Contributing to this attitude was the general misconception about MARK IV being nothing more than a report generator. After the education by the vendor, a little arm twisting by management, and—most importantly—some experience with the new system, converts abounded.

### The "Big Picture" Syndrome

The design and development of a MARK IV system should be approached in a markedly different manner with a COBOL-based system. Traditionally, it has been necessary to complete the detail design of a system before embarking on program coding. In particular, the file structures and formats must be firmly laid out and the functions to be performed by each program thoroughly specified before any coding can be started.

With MARK IV, system design may be

done at a higher level. Less of it is necessary. That which is done proves to be more creative for the analyst because MARK IV has fewer formal requirements than COBOL. Under MARK IV, general and detail design *should* be merged to consist of the identification of the functions to be performed, the provision of data names in a file definition required to support each function, and finally, the coding function.

For a number of reasons, we found that it is highly advantageous to begin program *coding* in MARK IV as early in

---

The programmer/analyst can develop specifications as he codes. This was related to us at the beginning, but resisted until we proved it true.

---

the development cycle as possible. First, MARK IV code addresses itself solely to the function to be serviced; there is no "housekeeping," opening and closing of files, file sequencing, or report formatting to cloud the problem-directed coding issue.

Second, MARK IV code is highly modular; therefore, relationships to other functions are not particularly important at the time the function is initially addressed.

# PROGRAMMED POWER...



75 KVA frequency converter/UPS

Beginning with sensitive Power Line Disturbance Monitors, then high-efficiency power frequency converters, UPS, and power conversion systems, PPI offers a broad range of power problem detection and power conversion systems.

PPI was first to offer Power Line Disturbance Monitors characterized by 441 Hz main frequency and 441 Hz detection to 100 Hz, 75 KVA frequency converter/UPS. PPI offers advanced designs in 50-150 KVA UPS. For the future—an even broader capability in Disturbance Monitors and power conversion systems.

- 50 - 441 Hz Power Line Disturbance Monitors
- 75 KVA Frequency Converters/UPS
- 50 KVA UPS
- 75 KVA UPS
- 100 KVA UPS
- 125 KVA UPS
- 150 KVA UPS



Power Line Disturbance Monitor



**Franklin Electric**

Programmed Power Div., 995 Benicia Ave., Sunnyvale, CA., 94086 (408) 245-8900

# How much can you save with fixed disk drives?

## Use our RFQ for PDQ answers.

Take a fresh look at your disk applications. Do they really need expensive removable-media drives? Today, industry giants say no. Which makes it sensible (and more reliable) for you to switch too.

And get a better fix on profits, with Pertec's fixed disk drives. Cost-efficiency is the name of the game now.

Buy a 6 mB fixed disk drive for \$1695. (Quantity 250 price, basic unit.) Lower unit costs and lower cost of ownership mean higher OEM profit margins. Without sacrificing on performance: check the chart for precisely what you need from Pertec's broad configuration mix—no more blowing a system budget on more capability than you require.

**Lower maintenance costs.** Every Pertec unit is sealed against contamination, and is less failure-prone—head crash traumas are minimized. Pertec's reputation for solid reliability is field-proven worldwide.

And note how simple we make servicing: *only* in Pertec drives are circuit boards hinged to flip up for easy maintenance.

**More applications every day.** The market is booming for fixed disk drives, with industry recognition of their maximized utility, in any working or format storage application.

Designing fixed disks in, wherever fast random access is needed, is saving OEMs a big bundle today. And you can get in on the action by checking our specs, and sending in your RFQ.

### Request For Quote:

Select the exact model(s) required to meet your application parameters, and indicate quantity and delivery date desired. Pertec will respond PDQ with price quotes and delivery schedule—no cost or obligation.

Capacity (Megabytes)	Bit Density (bpi)	Speed (rpm)	Data Transfer Rate (MHz)	Platter Configuration	Model Number	Quantity Required	Date Wanted
6	2200	1500	1.562	SINGLE	D1451		
6	2200	2400	2.5	SINGLE	D1452		
12	2200	1500	1.562	DUAL	D1461		
12	2200	2400	2.5	DUAL	D1462		
12	4400	1500	3.125	SINGLE	D1651		
12	4400	2400	5.0	SINGLE	D1652		
24	4400	1500	3.125	DUAL	D1661		
24	4400	2400	5.0	DUAL	D1662		

RFQ for Pertec Fixed Disk Drives submitted by:

Name \_\_\_\_\_

Title \_\_\_\_\_ Phone \_\_\_\_\_ Ext \_\_\_\_\_

Please attach RFQ form to company letterhead and return to Pertec, 9600 Irondale Avenue, Chatsworth, CA 91311.

For immediate requirements call the Pertec regional sales office nearest you:  
 Los Angeles (213) 996-1333. Chicago (312) 696-2460. Hudson, New Hampshire (603) 883-2100.  
 London (Reading) 582-115.

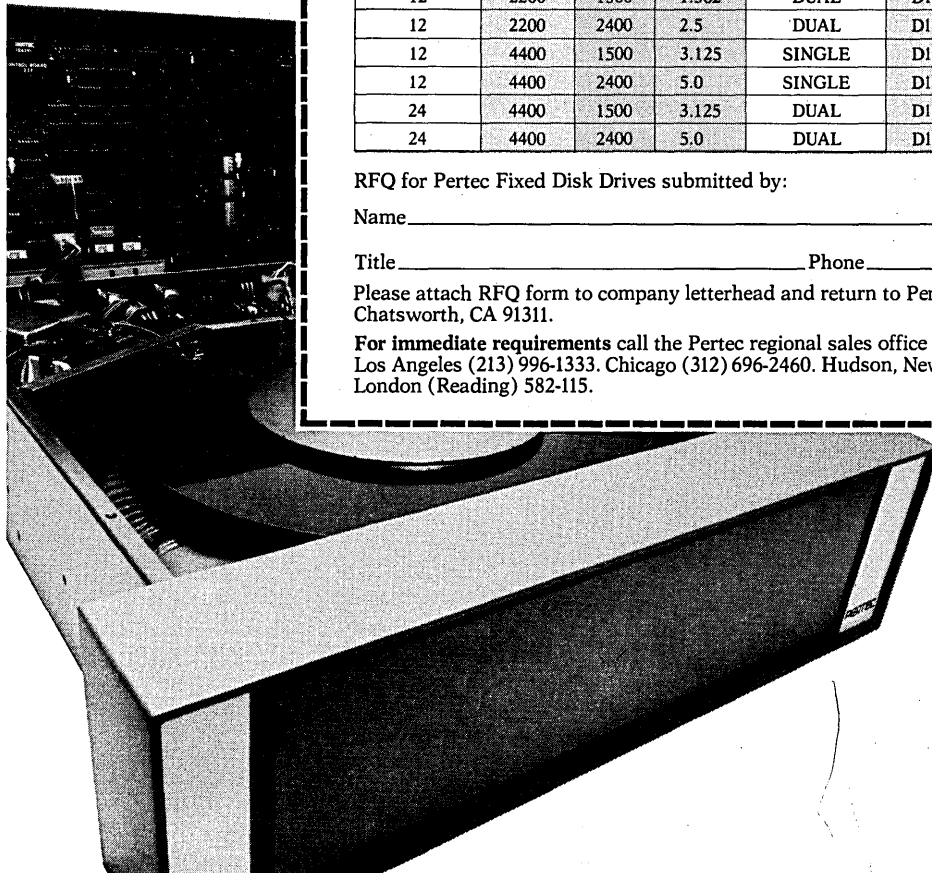

**PCO PERTEC**  
 a division of Pertec Computer Corporation

CIRCLE 44 ON READER CARD

## TO MARK IV

Finally, as a result of the above, the code is potentially disposable, which fact allows the programmer/analyst to develop more detailed specifications with the user as he codes. (This was related to us at the beginning of our project but was resisted for a time until we proved it true.)

### The "Cobol Techniques" Syndrome

Almost every programmer whose background is in a COBOL level language experiences a "Cobol Techniques" syndrome. That is, the programmer will attempt to apply the techniques learned in COBOL to MARK IV code. However, virtually every technique considered standard under COBOL has been automated in MARK IV; therefore, efforts to apply those techniques (such as reading or matching files) will bewilder the programmer. Read and write commands, for example, are unnecessary (and nonexistent) in MARK IV.

Other techniques such as checking for critical field breaks by holding and testing against previous values for report generation can be accomplished but are superfluous code. Again, these aspects of report generation have been

automated.

Linear programs are produced easily and cleanly through MARK IV. We have now broken unnecessary and time-consuming habits that were inherent in COBOL coding. The benefits, of course, are increased productivity and the focusing of programmer effort to creative problem solving.

### Lessons learned

By hindsight, there are several major contributions to the success of our Land Sales System which have been used as guides in subsequent systems development:

Application complexity should be reflected in the data base design rather than in program logic. The automatic data base management and segment manipulation features take on the workload instead of the programmer.

Under MARK IV, it is just as easy to define, establish, and maintain variable length, hierarchical file designs as it had previously been with simplistic fixed length records. There is no need, therefore, to shy away from a more appropriate file design because it appears too complex to implement.

The automatic features should be utilized to their fullest extent. Whether the automatic feature invoked pertains to a data base or program facility, the advantage is the same—the program-

mer knows the feature works. There is no need to code, test, or debug what is automatically invoked.

Program structure should be highly modular. MARK IV "requests" may be structured to break up a complex function into small and manageable tasks. As with other languages, this modularity may be achieved using subroutines.

Work began on the new Land Sales System in June, 1973, but included some false starts in defining and understanding what had to be done. Real progress became apparent early in 1974. With a staff of seven people, the Land Sales System was implemented in February, 1975, a massive effort for McCulloch, representing \$350,000 and approximately ten man years of effort.

Today McCulloch operates in a remote batch mode, using an IBM 370/155 located in Los Angeles. The redesigned Land Sales System, which is still the biggest of our applications, runs in four stages: daily data validation, daily file updates, daily reporting, plus periodic reporting. In addition to our basic MARK IV Model 260-os system, we have made use of several special features, including: extended transaction processing, extended segment processing, table look-up, indexed coordinated files, extended file processing, text processing, and extended reporting.

today's  
planning for  
tomorrow's  
future.  
it's the best  
exchange.

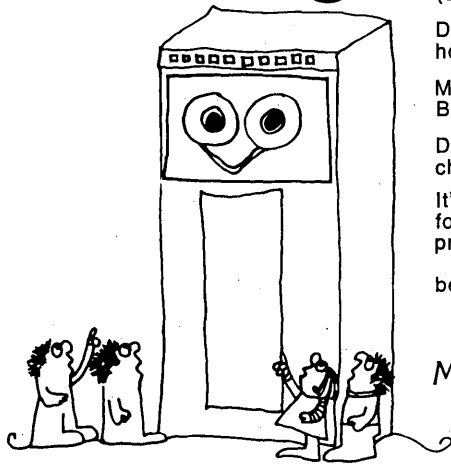

That's MIDWEST STOCK EXCHANGE SERVICE CORPORATION, a dynamic part of The Midwest Stock Exchange. We are investing time today in a long-range data processing plan to assure that tomorrow's needs will be met.

We have been a leader and now we're creating a new, highly competitive data processing environment to satisfy the projected user environment of the future. The user environment that will be concentrated in fewer and larger firms, in a few key cities, heavily dependent upon communications and our ability to respond both flexibly and quickly to changes in economics, market-place needs and regulations. Technically speaking, our resulting data processing environment will be:

#### CURRENTLY

2 IBM 370/145's & 158's with large memory...

DOS/VS tape oriented

Over 100 S/P people

Largest shared order processing communication system in the securities industry (350 terminals)

Data Processing for 60 plus brokerage houses

Maintain Securities for 400 plus Banks and Brokerage Firms...

Data Processing for The Midwest Stock Exchange

It's a multi-million dollar system re-design effort with a completion date scheduled for 1979. It's an all-out effort requiring the expertise of the finest data processing professionals available... allowing for the greatest career growth possible.

It's exchanging today's planning for tomorrow's future. And you can't get a better return than that. If you have talent to invest, let us hear from you.

For further information call or write:

Mr. Henry Roberts/Vice President

MIDWEST STOCK EXCHANGE SERVICE CORPORATION  
120 S. La Salle St./Chicago, Illinois 60603  
(312) 368-2207

#### GOING TO

OS/VS

Heavy Disk orientation  
CICS based applications  
Data base management  
system



# Now United's SPD goes door to door. Call (800) 424-9899

for pickup and delivery to more than 3500 communities.

SPD has always been easy. Now it's a snap because United will rush your important small package (up to 50 lbs., up to 90 inches in length plus width plus height) from your door to destination—in hours. And this guaranteed, same-day service is available 24 hours a day, 7 days a week.

When you SPD it door to door, here's what you can rely on:

1. **Speedy pickup**—within 1½ to 3 hours of your call, depending on your location.
2. **A fast delivery guarantee:** You'll receive a refund of the door-to-door charge if your package doesn't move as specified. Which means we'll deliver it within 1½ to 3 hours of the plane's arrival.
3. **Pick your flight** from the airline that brings you more flights to more cities than anyone.

4. Delivery confirmed upon request.
5. Single-carrier responsibility.
6. **Unbeatable service and great door-to-door prices!** Take a look at these sample door-to-door rates\*:

Between:	Chicago and N.Y.C.	\$63.50
	S.F. and Chicago	\$74.50
	Cleveland and L.A.	\$74.50
	Denver and Seattle	\$69.00

\*Rates effective 10/18/76 and subject to change.

When you need door-to-door service, there's no quicker way than with United's SPD.

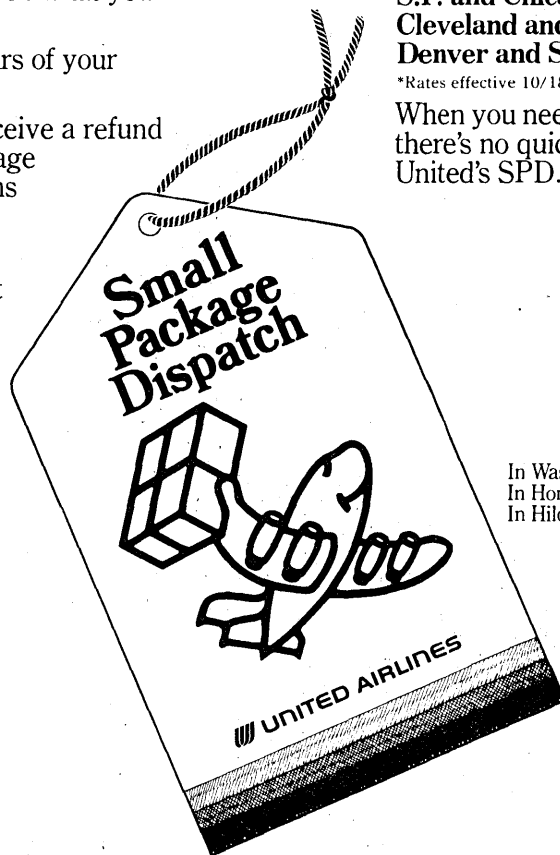

In Washington, D.C., call 223-6947  
In Honolulu, Hawaii, call 842-5252  
In Hilo, Hawaii, call 935-9144

See why United's No. 1 in the cargo sky.  
**UNITED AIRLINES CARGO**

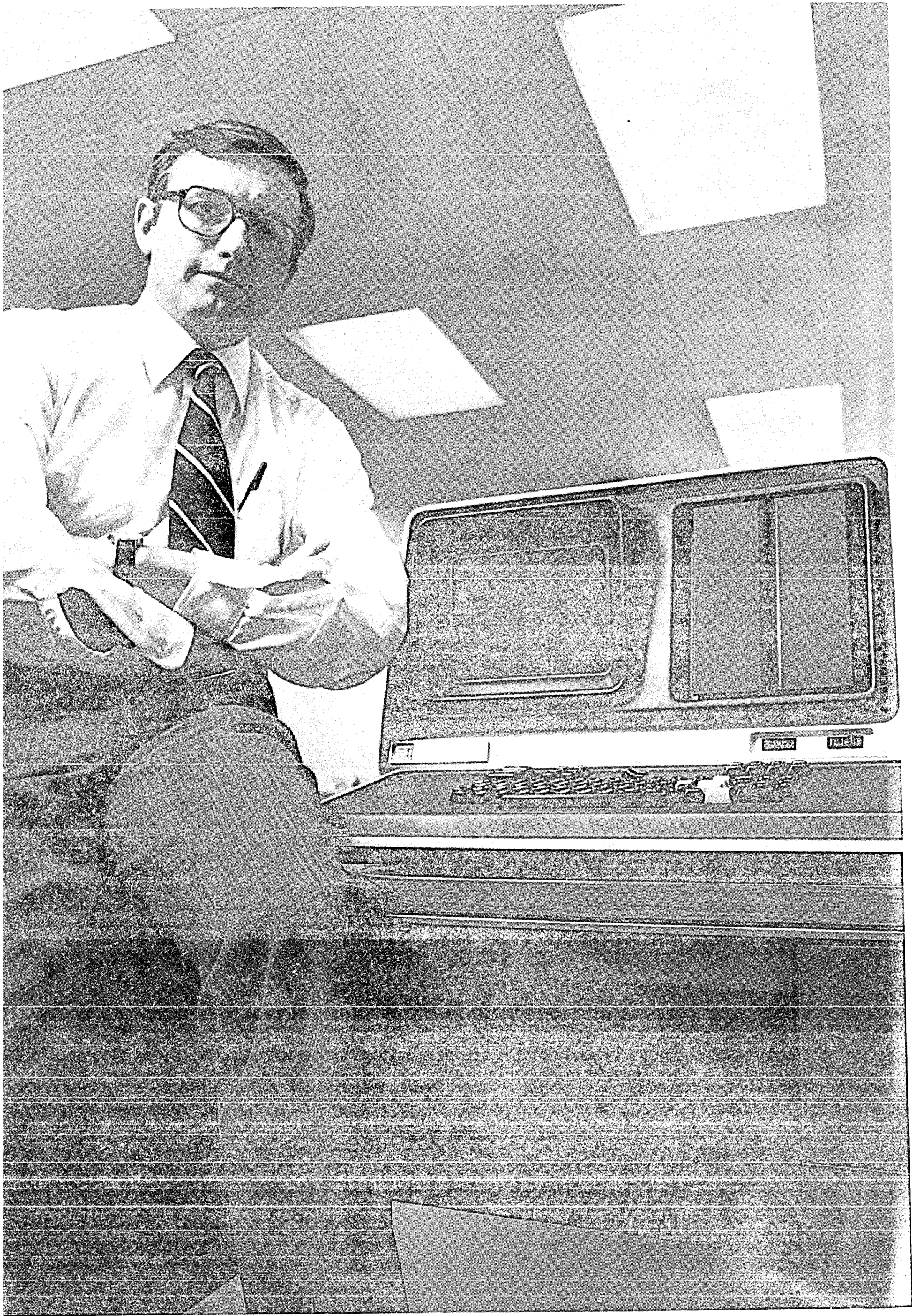

# "Sycor 350 terminals perform the edits and checks we used to do on-line. At a fraction of the time and cost."

*Jack Robinson, Asst. VP  
State Street Bank of Boston*

State Street Bank & Trust Company of Boston is one of the largest custodian banks in America with over 125 portfolios totaling some \$20 billion in assets. This includes serving as custodian bank for mutual funds whose assets represent 30% of the entire domestic mutual funds industry, as well as variable annuities, pension funds, and college endowments.

Each day, the custodian service department must report the net asset value of the mutual funds to the National Association of Securities Dealers for publication by the daily news media.

Getting this information out on time—and getting it out accurately—is vital. To do it, the bank depends on Sycor 350 terminals for processing over 500 daily portfolio and general ledger transactions.

## **Sycor picked for speed and economy.**

"Our growth was placing heavy demands on both our on-line ter-

minal network and keypunch facilities," notes Jack Robinson, assistant vice president. "Type-writer terminals were simply not fast enough to get the job done, and making improvements in the on-line program would have required a massive overhaul.

"The replacement of on-line terminals with Sycor 350 terminals took care of both problems. It also eliminated the need for nighttime keypunching which helped us save even more on operating costs."



The dual-flexible-disk Model 350 is microprocessor-controlled and has 16k bytes of memory.

## **Sycor terminals keep working when the CPU goes down.**

"Every Sycor terminal has an independent microprocessor, so we have as many back-up systems as we do terminals," Robinson says. "If the mainframe goes down, we can still continue entering data.

"We currently receive 12,000 transactions per month by TWX, phone and mail. We enter the data on Sycor terminals and, at scheduled intervals, transmit it to our CPU. This gives us an on-line batch system that gets the job done economically and gets it done right. It's the best of both worlds."

## **Find out more.**

Put Sycor to work for you. Find out how by sending in the reply card or calling the Sycor sales representative in your area. We're in the Yellow Pages under "Data Processing Equipment." Or, contact Bill Newell, our national sales manager, at Sycor, Inc., Ann Arbor, MI 48104.

**Sycor puts computer power where the work is.**

# **SYCOR**

If you use computers as models of dynamic systems . . .

**you  
are  
a  
simulationist**

and

you are invited to join the Society for Computer Simulation and receive our monthly technical journal, *SIMULATION*, every month

The Society for Computer Simulation (SCS) is the *only* society whose central focus is simulation, and *SIMULATION* is the leading monthly journal devoted exclusively to simulation & closely allied computer arts.

If you are working in our field, we think you would find membership in SCS useful in many ways.

In addition to your membership in the Society for Computer Simulation, you'll receive a subscription to *SIMULATION*, the benefits of meeting and interacting with internationally recognized authorities in the field at SCS regional meetings and at national and international conferences cosponsored by SCS, and the knowledge that the information you receive through your membership in SCS will keep you informed in the rapidly advancing art of simulation.

Write for a free sample copy of *SIMULATION* and membership information.

**THE  
SOCIETY  
FOR  
COMPUTER  
SIMULATION**

(Simulation Councils, Inc.)

P.O. Box 2228-D  
La Jolla, Calif. 92038



## TO MARK IV

As a result of our switch from COBOL, we have experienced a shift in workload from maintenance to devel-

opment to challenge proposed tax assessments. Based on the analysis and the data provided, the assessments by the tax authorities were revised in our favor, saving over \$100,000.

In short, we've been made believers.

Large System Development—COBOL vs. MARK IV

	Units of Work		Reduction
	Cobol	Mark IV	
General systems design	8	14	30%
Detail systems design	12	25	38%
Program coding	40	10	50%
Program testing	20	10	—
File conversions	10	2	60%
Documentation	5	4	20%
System testing	5	4	35%
	<u>100</u>	<u>65</u>	

Table 1. The above represents a relative comparison of effort needed to complete the traditional components or steps in large system development in Cobol and Mark IV. The figures are McCulloch's best estimates, having been a heavy user of both languages. These estimates are for large projects. The percentage reduction with MARK IV tends to become even greater as the project size gets smaller.

opment, a reduction in staff, and a change in "complexion" for the dp department.

Some of the change in workload is best shown in Table 1, but a very significant aspect is omitted from that list.

The results, in terms of increased production, are better than we expected, and the reaction of the dp staff has been a welcome surprise. \*

**Somewhat to our surprise, developing systems in MARK IV seems to be very rewarding to the programmers**

That is the switch from spending 100% of our programming effort on maintenance, to spending only 10%. Also, somewhat to our surprise, developing systems in MARK IV seems to be very rewarding to the programmers, since much of the tedious checkout, maintenance, and documentation is done for them automatically.

For McCulloch, the transition has been very satisfying. The programming staff has been reduced 75% to four people from pre-MARK IV levels of 16. (For the most part, this drastic reduction was due to the shift of development from maintenance.)

Not only is more information available quicker than before but other cash savings not previously envisioned have virtually paid for the entire development of the Land Sales System.

Prior to the Land Sales System, top management simply did not bother to ask for dp support in their decision making cycle. First, the turnaround to acquire dp inputs was too long, and second, these inputs when received were often of dubious accuracy. Now, upper and middle management routinely request dp support. In several instances, management's initial "gut" decision has been reversed and a costly error avoided. In one case alone relating to property taxes, the availability and accuracy of data from the Land Sales System gave McCulloch the con-



Mr. Flynn is a vice president at McCulloch Properties Inc. Prior to joining this firm in 1972, he had been a principal in management consulting with Arthur Young and Co., a division controller with Bell and Howell, and head of the systems and dp groups at Mattel, Inc., and at the Glidden Co. He has had approximately 20 years experience in information processing.

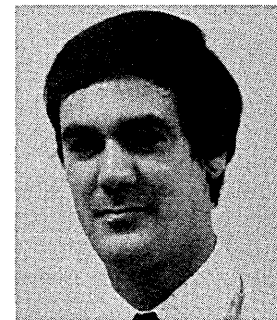

Presently MPI's systems development manager, Mr. Kimber joined the firm in 1974. His previous experience includes two years in systems development with Ciba-Geigy in Basel, Switzerland, and college level teaching in statistics, accounting, and the mathematics of finance.

# DP Dialogue

Notes and observations from IBM that may prove of interest to data processing professionals.



Nebraska corn grower Kenneth Bruns takes a reading of soil moisture, one of the variables considered by Agnet in the calculation of an optimum irrigation schedule.

## Serving the Farmer in the Field

Nebraska farmers are conserving water and cutting the costs of feed and energy with the help of Agnet, an agricultural network developed at the University of Nebraska.

"Our controlling idea in designing the system," says Thomas L. Thompson, professor of agricultural engineering at the university, "was to eliminate the need for any special user training, yet still have a sophisticated interactive system."

Thompson is co-developer of Agnet at the Institute of Agriculture and Natural Resources on the university's Lincoln campus.

After two years, farmers are attributing significant savings in feed costs, water and energy to the system, which offers more than 100 different applications and is based on an IBM System/370 Model 158 at the Nebraska State Department of Administrative Services.

To use Agnet, the farmer or county agent enters the details of the problem at a terminal in a county agent's office, a district station or at the university.

Says James G. Kendrick, professor of agriculture economics and the other co-developer of Agnet: "The user signs on by keying in one word, the name of the desired service such as 'Beef' for a cattle performance simulator or 'Dry' for a simulator of grain-drying systems.

"The computer takes it from there, guiding him through a session. It begins by asking for parameter values: type of drying equipment, capacities, fuel costs and the like. It displays a menu for selection of qualitative parameters such as crossflow or counterflow dryer. For numerical parameters, it asks the user to key in a value. Or the user may enter a zero and the computer will insert a default value from updated agricultural statistics.

"If the user doesn't understand a request, he keys in 'Help,'" Kendrick notes. "The computer then displays an explanation of the question and of the

*(Continued on fourth page)*



*Computer-controlled electric vehicle moves automatically to the selected aisle and bin, for storage and retrieval of goods in a main warehouse of VWR Scientific.*

## CICS/VS Helps Multiply Profits at VWR

"Controlling operations with an on-line system helped us multiply profit severalfold," says James W. Bernard, president of VWR Scientific Inc., one of the country's largest distributors of scientific and photographic supplies and equipment.

Over two years, he notes, the San Francisco headquartered company was able to decrease inventory while improving service levels and cutting operating costs.

"Distribution is the science of customer order and materials handling," says Bernard. "With 48,000 line items in our catalogue, maintaining service levels without excessive inventory is no mean feat—and in this business making a profit means staying lean."

At VWR, the computer handles each major operating function: processing customer orders, directing warehouse operations to pick orders and store incoming merchandise, managing inventory, and generating purchase orders. The company, a subsidiary of Univar Corp., uses 110 IBM 3277 Display Stations in a nationwide network based on the Customer Information Control System/Virtual Storage (CICS/VS) running on a System/370 Model 158.

Sales people use online inquiries to

give customers immediate answers on item availability, order status or prices. Customer orders are entered directly at the terminals to provide rapid turnaround.

To store and retrieve goods in a main warehouse, computer-generated punched cards control electric vehicles which move automatically to the selected aisle and storage bin.

The capture of transaction data during terminal procedures has reduced data preparation costs as well as most sources of data error. Incoming inventory is entered into the system sooner and becomes available sooner.

According to Lester Gray, vice president of management information and computer services, the rapid implementation of the new and enhanced systems would have been more difficult, and many of its most valuable features would not have been feasible, without CICS/VS, an IBM program which manages terminal transactions and file accesses in on-line systems. "The flexibility and device independence of CICS lets us add sites, add new types of terminal inquiry, and introduce major system enhancements quickly and easily, without disruptions," he says.

"CICS enabled us to include some

special features," Gray adds, "including online inquiry access to our backorder system which automatically releases merchandise for delivery as it is received. The system makes provisions for expediting customer orders or handling emergency orders.

"Our applications include a marketing information system which scans our files and produces reports of activity organized by customer, product, vendor or geographic area. This has helped us to identify obsolete items and to supply valuable information to our customers, vendors and operating people.

"We use the system to compile the data for our quarterly price book directly from the price files.

"An important thought behind our 1975 acquisition of Treck PhotoGraphic Inc., a \$90 million nationwide distributor of photographic supplies and equipment, was that we could support 32 new locations and Treck's product line with our existing CICS system.

"With the flexibility and modularity of CICS, we were able to add Treck to our online system easily," Gray reports. "Without CICS, integrating Treck would have been very costly and absorbed our developmental resources for a long period of time."

# MVS Takes Over Swiftly at Fairchild

Global data processing networks—once a dream and later a daring innovation—are now basic to the operations of a number of businesses around the world. But this kind of far-flung organization demands a closely integrated information and data processing system if it is to function effectively.

One company whose manufacturing and marketing efforts span the globe—Fairchild Camera and Instrument Corporation—is establishing just such a system. Within Fairchild, a manufacturer of electronic components and systems, plants and sales offices in the U.S. and overseas are linked directly to an IBM System/370 Model 168 computer at its corporate headquarters in Mountain View, California. The company transmits complex order entry transactions and manufacturing data over a network with which it is linking nearly 100 of its locations around the world.

Early in 1976, Fairchild converted from OS/VS1 to OS/VS2 Multiple Virtual Storages (MVS). Since MVS increases the number of terminal users the system can serve, and because it maintains a predictable terminal response time during peak loads, it provides strong support for combined online and batch operations.

“Our data processing systems really drive this company,” says Burleigh Cook, director of information services for Fairchild. “With worldwide operations in the balance, we wanted assurance that we could keep going when the going got tough. We achieved that reliability with the MVS operating system.

“We are particularly impressed with the sophisticated error recovery facilities and procedures incorporated in the MVS software,” continues Cook. “It has quicker capability for diagnosing problems and correcting them automatically than any operating system I know of.

“This in turn has meant higher availability, which is crucial to the development of an online system such as ours.”

Fairchild and IBM completed joint planning for the move to MVS in November 1975, less than a month after the decision to convert was made. By January, two months later, the system was fully operational.

“It seemed as though we put six months’ effort into those two months,” says Ray Yasukochi, Fairchild manager of technical support, who was in charge of the move. “Actually, we had a highly detailed plan which we carried out ‘by the numbers,’ working shoulder to shoulder

with IBM. It was a smooth transition with a minimum of disruption.”

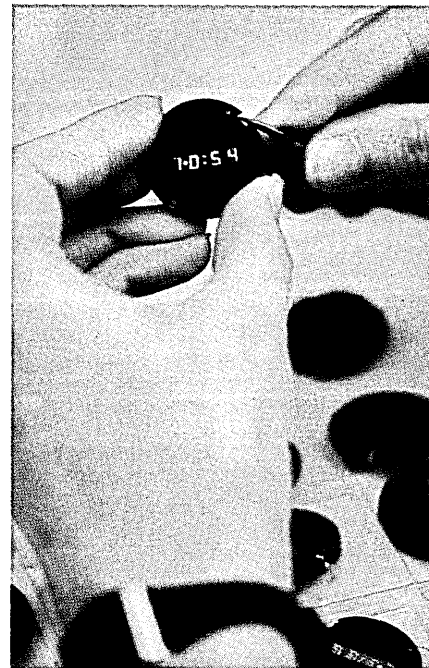

*A quality control worker inspects the components of a digital watch, one of the high-technology products of Fairchild Camera and Instrument.*

## Computer Supports Hospital Patient Care

When a nurse anywhere in Harris Hospital wants to order a test, medication, or X-rays for a patient, she steps up to one of 102 terminals in nursing sta-

tions and other operating areas of the 628-bed Fort Worth, Texas, hospital and keys in the patient's name and indicates to a computer the service she requires.

Much of the actual operation of the hospital—patient care and administrative work—is accomplished through the computer. A realtime medical information system accepts the order and forwards it to the laboratory or other service department. The computer adds currently applicable details of the procedures to orders for tests or X-rays. When the results are available, the system returns them to the requesting station.

### Users Enter Data

“The users do all of our data entry at terminals,” says Herbert A. Witt, director of data processing. “By leaving control of information and responsibility for its accuracy with the user, we eliminate most sources of data error.”

In the laboratory, for example, the response of the computer to requests for service is controlled by the pathologists; they enter the test parameters as data. “What our programmers have supplied is a completely generalized structure for a laboratory test procedure. The pathologists specify each step of the test, and such parameters as the normal range of each test variable.”

User confidence, says Witt, is essen-

*(Continued on next page)*

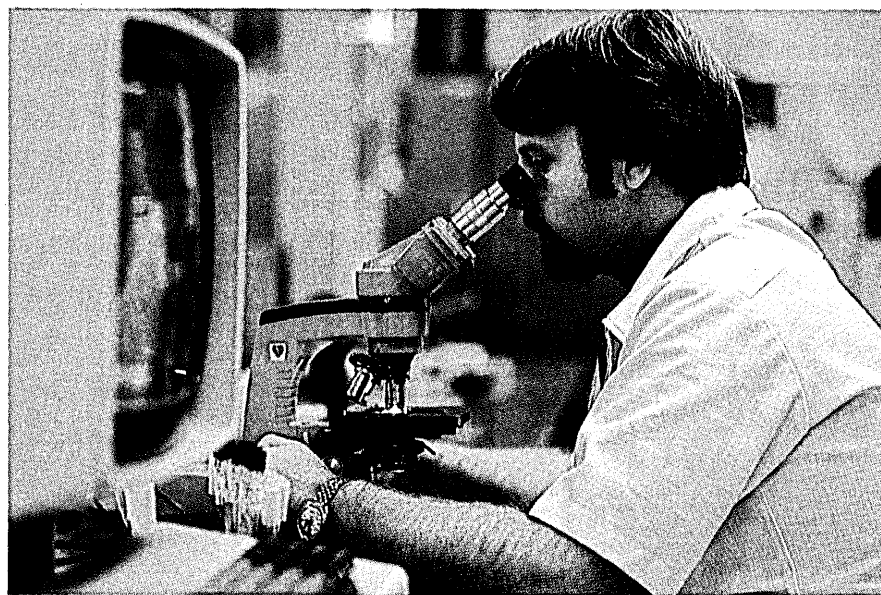

*When a nurse at Harris Hospital orders a test for a patient, an online information system displays the detailed test parameters for the technician here in the laboratory. Results are reported back through the same system.*

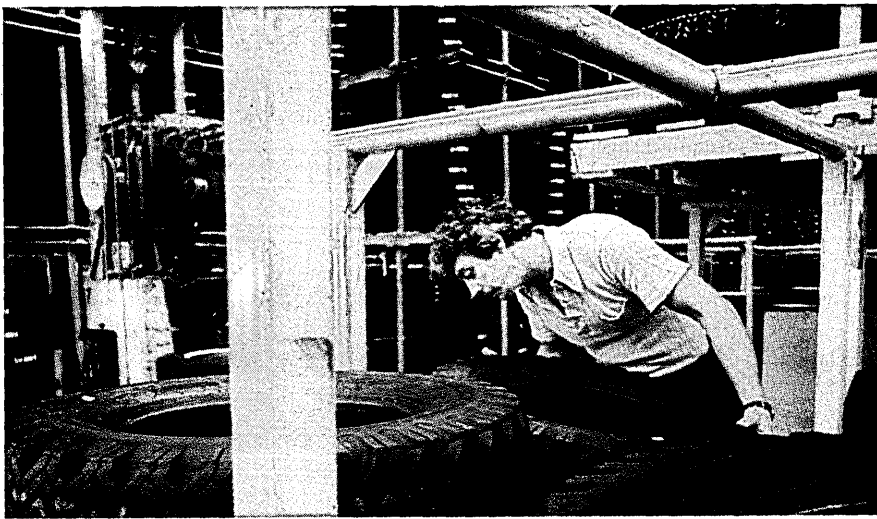

The FIMS online computer system allowed Firestone to improve customer service while cutting back from 45 warehouses to 22 facilities like this modern Cranbury (N.J.) Distribution Center.

## IMS/VS Helps Tires Roll at Firestone

"During the last six years, Firestone has reduced overall costs for warehousing and shipping, transportation and inventory by 10% below what they would have been without the innovations opened up by our information system," says Paul Heise, director of inventory management.

Firestone Tire and Rubber Company began developing its Firestone Inventory Management System (FIMS) in 1968. Four years later it started converting to Information Management System/Virtual Storage (IMS/VS), in order to integrate all subsystems through a common data base.

Today, FIMS is an online system that responds to inquiries and transaction entries from any of 400 IBM 3277 Display Stations in Firestone's nationwide network of sales offices and warehouses. It supports customer order processing, production scheduling, inventory management, warehouse operations, and physical distribution.

Salespeople use terminals to enter customer orders or obtain complete order status information: The system continuously monitors inventory and customer orders, and provides production schedules to tire-making plants. It monitors production, keeping track of tires built to 6,000 different specifications and adding newly made tires to inventory each day. And it schedules the distribution of tires, including warehousing and the loading and routing of trucks.

"With FIMS, we've been able to respond faster to customers' needs while reducing inventory," Heise notes. "It has permitted us to regionalize our distribution system, reducing 45 warehouses to 22 high-volume distribution centers."

"Under IMS/VS the data base used for

order entry is the same one that deploys inventory and schedules production," notes W. L. Smith, assistant controller and director of data processing. "This has enabled us to add some valuable new functions to the system."

"For example," he continues, "the computer organizes orders so that a load for a specific truck or delivery run is all drawn out at one time. We can sort and batch orders from one customer or one geographical region to insure that only full trucks go out, with deliveries grouped by area. We can automatically handle special instructions, such as orders dated for future delivery or specified for a certain day of the week."

While most of FIMS processes current transactions, one subsystem analyzes historical data. "The IMS/VS data base enabled us to develop the Inventory and Distribution Research subsystem," Smith notes, "which analyzes historical patterns in our tire operations."

"This kind of research is vital to our inventory management people," Heise adds. "It helps them select sites for regional warehouses and plan the details of our physical distribution system."

## Helping Farmers...

(Continued from first page)

significance of each possible answer."

Farmers are using Agnet to perform such calculations as irrigation schedules based on soil moisture and crop data, minimum-cost feed mixes, crop-drying schedules, financial analyses of capital investment or crop commitments, soil analyses, pest control and fertilizing schedules and many others.

## Harris Hospital...

(Continued from preceding page)

tial to successful implementation of a system like this. "You can do so much more for your users after they've learned to trust you, to be receptive and to work with you."

"You have to earn that confidence," says Michael Herrmann, assistant director of data processing. "It's a self-reinforcing process: the more user confidence we have, the more we can do for our users."

"We try to avoid urging on them ready-made solutions which they have had no part in specifying. And we stay in touch during the development process, getting their help and approval on details of the system performance. This gives them a sense of identification with the system and a readiness to help make it work."

"Our emphasis has been on performing patient care, as distinct from recording and reporting after the fact," Witt says. "The main purpose of the system is to relieve doctors and nurses of paperwork."

As with laboratory tests, Witt explains, authorized users can also enter, through a 3277 Display Station, orders for medication, X-ray procedures and other patient care services.

### Query Patient's Program

An authorized user at any terminal can determine a patient's medication program or other medical information, or query the patient census, inventory systems, patient billing or payroll system.

Administrative people perform many of their duties through the computer, including management of bed assignments and calculation of insurance benefits. There is a patient billing system, one for purchasing and inventory, and a payroll system.

Admissions personnel, pharmacists, administrators and other users interact via terminals with any of these systems, accessible online under Customer Information Control System/Virtual Storage (CICS/VS).

*DP Dialogue is designed to provide you with useful information about data processing applications, concepts and techniques. For more information about IBM products or services, contact your local IBM branch office, or write Editor, DP Dialogue, IBM Data Processing Division, White Plains, N.Y. 10604.*

# IBM®

Data Processing Division

**DATAMATION**



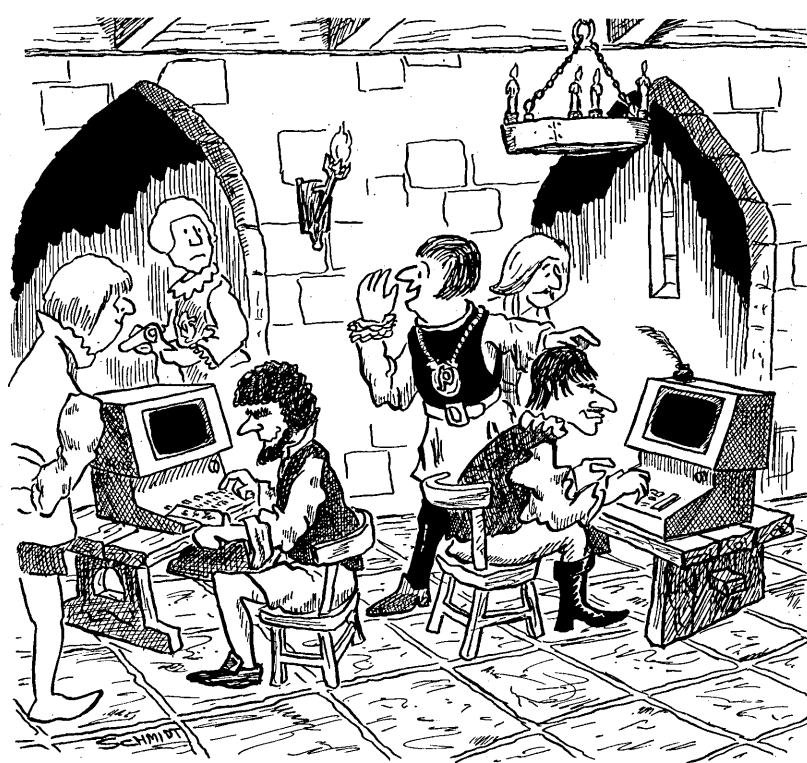

# The Programmer's New Codes

by Jack L. Ludwig

Not so many years ago there was a Programmer who was so enamored of new codes that he spent all his time and all his manager's budget on them. He cared nothing about his schedules, nor for essential documentation, nor for on-line testing except for the sake of displaying his new code on a color crt. He had a different language for every program in the library.

Life was very active in the computer center where his programs were executed; hosts of vendors came to visit every day, and among them one day came two virtual swindlers. They claimed to be universal translators and said that they knew how to organize the most effective Data Base imaginable. Not only were the Calls of interpretive mnemonics and multi-threaded macros unusually fine, but the page sets that were swapped by these codes had the peculiar quality of becoming inaccessible to any program that was not designed for real time, or that was anciently batch.

"Those must be splendid codes," thought the Programmer. "By using them I should be able to discover which programs in my library are still in IBM 1401 compatibility and also which covet entry into os/vs 21.II. I shall select the optimal wares from the spools. Yes I must certainly order some of those multi-threads to be coded for

me."

He gave the two swindlers a lot of cpu cycles in advance so that they might begin their work virtually right away. They put up two partitioned data sets and pretended to code, but they had nothing whatever upon their screens. At the outset (o.s.) they asked for a quantity of the fastest memory and the largest registers, all of which they put into their own working set, and dumped to laser tape all the proprietary packages in source and object/load modules, while they idled far into the night at empty screens.

"I should like to know how those weavers are getting on with the links and chains in the Data Base," thought the Programmer, for he felt a little squeamish when he reflected that any code which was unfit for real time would not be able to use it. He certainly thought that he need have no fears for his routines, but still he decided to send somebody else first to see and test how it was getting on. Everybody on the staff soon heard what wonderful power the page sets would possess, and everyone was anxious to see how inept his co-worker was.

"I will send my faithful old Maintanancer expert to the swappers," thought the Programmer. "He will be best able to see how the stuff links, for he is a clever man and no one

fulfills his duties better than he does."

So the highly confident good old Maintanancer went into the room where the two apt swindlers sat working at the empty crt's.

"Hollerith preserve us!" thought the old Maintanancer, as his confidence quickly diminished. Opening his eyes very wide to remove any self-doubt about his failing eyesight, he said to himself, "Why, I can't see a thing!" But he very cautiously took care not to say so, realizing he was supposed to report back how well the stuff links when he could not even see the stuff in the first place. What was he to do? How could he not see them? He knew how enthused the Programmer had been about these splendid codes.

While immersed thus in thought of self-pity, the old Maintanancer was rudely brought back to reality by the "clicking noises of a LOGON," as both the swindlers logged him on to be close enough to test a little re-entrant. They asked if he did not think it a good structure and beautiful linkage. They pointed to the empty screens, and the poor old Maintanancer stared as hard as he could but he could not see anything, for of course there was nothing to see.

"Good Graphics!" thought he, "is it possible that I am an illogical Boole and deserve the gate? I have never

# IMPROVING COMPUTER OUTPUT

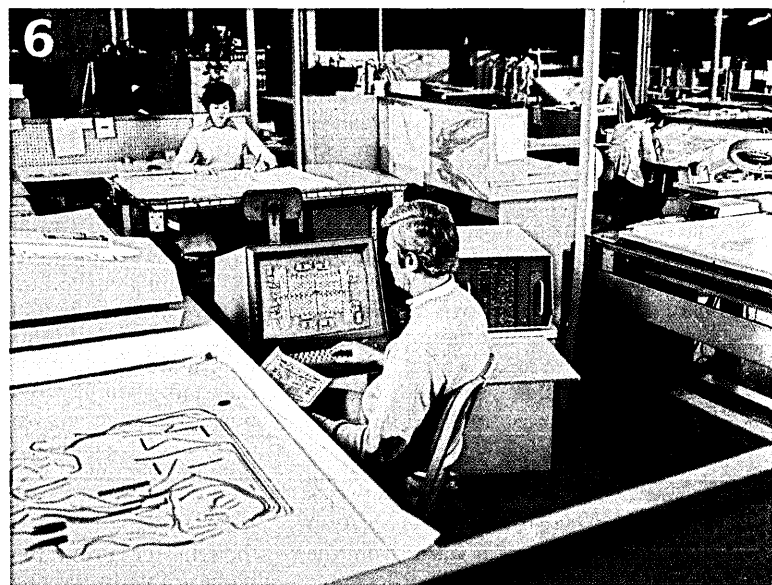
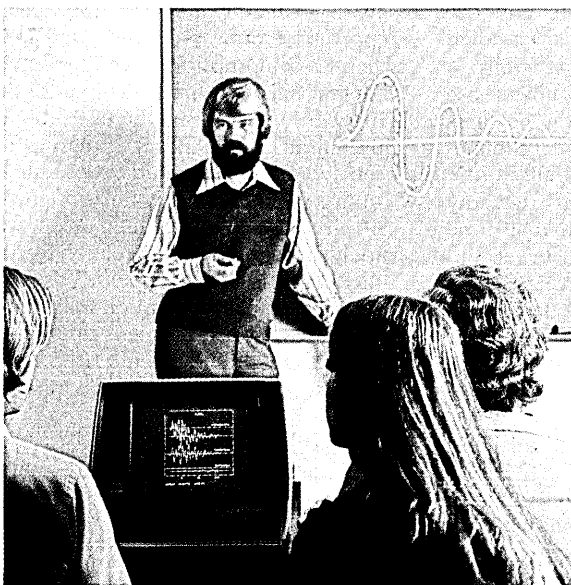
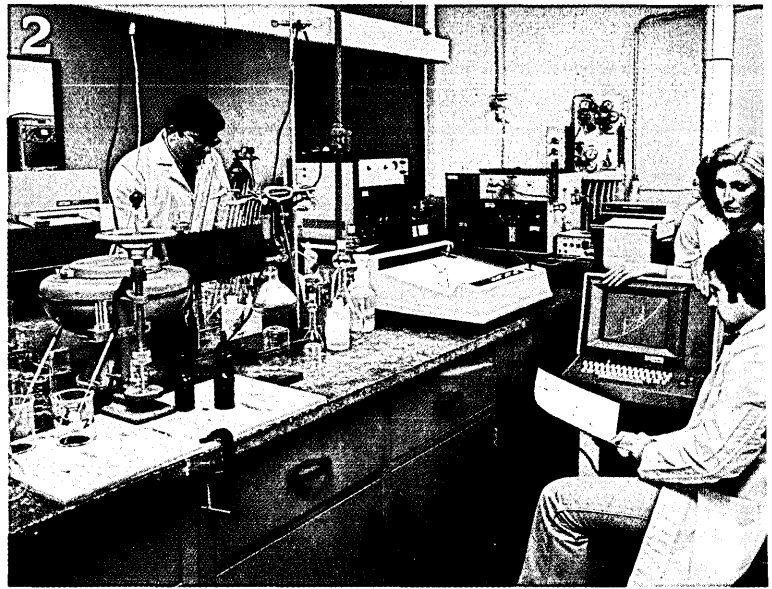
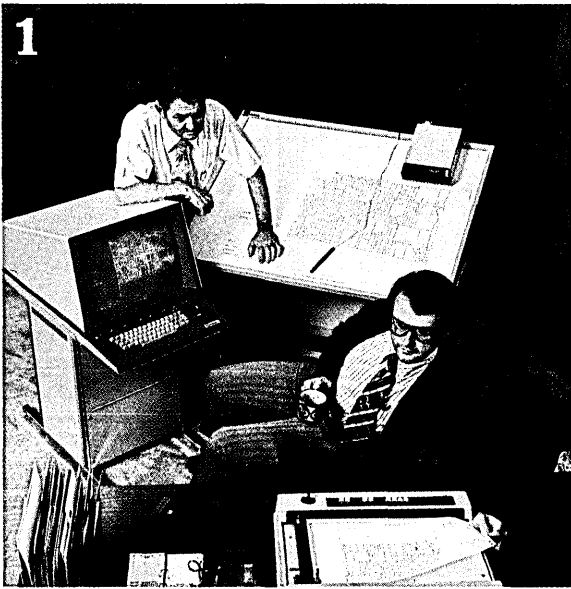

OEM prices available. Copyright ©, 1976. All rights reserved

# If you're not using Graphics you should see who is.

**1** Civil engineers are taking the tedium and expense out of mapping by digitizing plots on the 4954 Graphic Tablet and manipulating real time details on the big-screen 4014-1 terminal.

**2** High-resolution results from analytical instrumentation tests, as displayed on the 4012 Graphic Display Terminal, reduce research costs and eliminate the inaccuracy of manual analysis. The 4662 Interactive Digital Plotter produces camera-ready copies.

**3** Combined storage and refresh graphics capabilities of the 4081 Interactive Graphics Terminal are saving aeronautics and aerospace engineers hundreds of manhours in relating the dynamics of flight to design methods and materials.

**4** The personal, desktop computing power of the 4051 Graphic System frees marketing, finance and administration departments from dependency on the mainframe while it graphically facilitates decision-making.

**5** Education discovered the 4006-1, Tektronix' lowest-cost Graphics terminal, as a dynamic means of demonstrating complex theories and concepts while involving and intriguing students of all levels.

**6** IC modeling takes on a new dimension via the 4014-1. Interactive manipulation, debugging and critical adjustments are made quickly and accurately.

**T**oday, hundreds of companies rely on **Graphics** to find oil, fight disease, forecast budgets, stimulate education, plan cities, design circuits, unsnarl traffic—to instantly interpret complex ideas. Everything expressed in Graphics is better understood, more effectively communicated... by you, or by your competition.

As the world's Graphics leader, Tektronix can give your communications a dimension you've been missing. With high-resolution graphics terminals. Desktop computing calculators. And complete graphic systems. All supported by peripheral devices, proven software, wide-ranging sales and service—and a worldwide reputation for quality and dependability.

Back when Graphics was a \$100,000 novelty, you could afford to ignore it. You can't afford to ignore it now.

Today, Tektronix provides Graphics from under \$3000. Graphics that's reliable, versatile, easy to use. A technology that's essential to modern day efficiency of man and computer. Write us, or call your local Tektronix Sales Engineer and find where our products fit your picture.

**Tektronix, Inc.**  
Information Display Group  
P.O. Box 500, Beaverton, OR 97077

**Tektronix Datatek N.V.**  
P.O. Box 159, Badhoevedorp, The Netherlands



## Get the picture. Get results.

# Reality is the sweet smell of success.

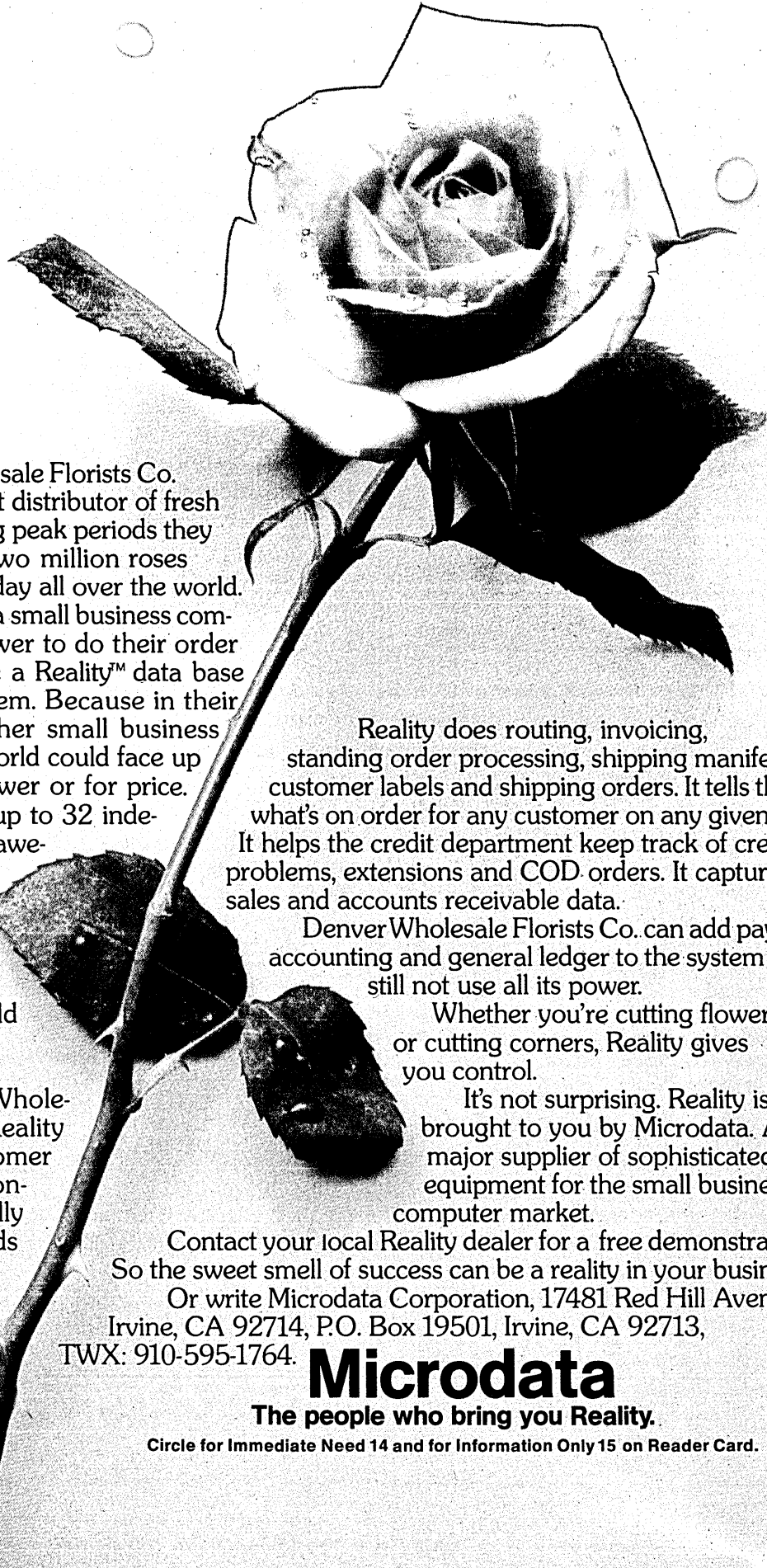

Denver Wholesale Florists Co. is America's largest distributor of fresh cut flowers. During peak periods they may ship nearly two million roses and carnations a day all over the world.

They needed a small business computer with big power to do their order billing. They chose a Reality™ data base management system. Because in their application no other small business computer in the world could face up to Reality. For power or for price.

Reality gives up to 32 independent users an awesome amount of computer power for the money. And it's the only computer system in the world that understands English™.

For Denver Wholesale Florists Co., Reality up-dates the customer and supplier lists on-line. It automatically up-dates all records when a change or addition is made anywhere in the system.

Reality does routing, invoicing, standing order processing, shipping manifests, customer labels and shipping orders. It tells them what's on order for any customer on any given day. It helps the credit department keep track of credit problems, extensions and COD orders. It captures sales and accounts receivable data.

Denver Wholesale Florists Co. can add payroll, accounting and general ledger to the system and still not use all its power.

Whether you're cutting flowers or cutting corners, Reality gives you control.

It's not surprising. Reality is brought to you by Microdata. A major supplier of sophisticated equipment for the small business computer market.

Contact your local Reality dealer for a free demonstration. So the sweet smell of success can be a reality in your business.

Or write Microdata Corporation, 17481 Red Hill Avenue, Irvine, CA 92714, P.O. Box 19501, Irvine, CA 92713, TWX: 910-595-1764.

## Microdata

The people who bring you Reality.

Circle for Immediate Need 14 and for Information Only 15 on Reader Card.

## NEW CODES

thought so and nobody must know it. Am I not fit for my post? It will never do to say that I cannot use the page sets."

"Well, sir, you don't say anything about the multi-threads," said the one who was pretending to weave element linkages.

"Oh, it is beautiful! quite effective!" said the old Maintanancer looking over his templates; "this pattern and these chains! I will certainly tell the Programmer that the page sets please me very much."

"We are delighted to hear you say so," said the swindlers, and then named all the pointers and described the peculiar pattern. The old Maintanancer paid great attention to what was said, so as to be able to repeat it when he got back.

Then the swindlers went on to demand more money, more cycles and more charge-coupled devices, to be able to proceed with the linking; but they put it all into their own partitions—not a single link was ever put into the directory. They went on idly at the empty crt.

The Programmer soon sent another man to see how the page sets were getting on, and if it would soon be ready. The same thing happened to him as to the Maintanancer; he looped and looped, but as there was only an empty screen, he could test nothing at all nor see it.

"Is not this a beautiful piece of multi-level structure?" said both the swindlers, showing and explaining the dynamic pattern and chains which were not there to be seen.

"I know I am not an illogical Boole!" thought the man, "so it must be that I am unfit for my post! It is very strange though! However, one must not let it appear!" So he praised the page sets he did not see, and assured them of his delight in the inversion access and the ingenuity of the plotting design.

"It is absolutely smashing!" he said to the Programmer. Everybody on the staff was talking about this splendid structure and access methodology.

Now the Programmer thought he would like to see it while it was still on the screen and plotter. So, accompanied by a selected number of Codiérs, among whom were the two who had already seen the imaginary results, he went to visit the crafty impostors, who were working away as hard as ever they could at the empty crt's.

"It is magnificent!" said both the virtuous workers. "Look! see, Your Routiness, what a design! What indices!" And they pointed to the empty

screen, for they thought no doubt the others could see the page sets, structures, links and chains.

"What!!!" thought the Programmer; "I see nothing at all! This is terrible! Am I an illogical Boole? Am I not fit to be Programmer? Why, nothing worse could happen to me! Even if my Bio-Rhythm curves were all at nadir and I broke a reflective SDLC buffer for sevens cycle bad luck."

"Oh, it is dynamic!" said the Programmer. "It has my highest appropriation and approval!" and he nodded his satisfaction as he gazed at the empty screens. Nothing would induce him to say that he could not see anything, test anything nor sense anything.

The whole staff gazed and gazed, but saw nothing more than all the others. However, they all exclaimed with Monitorism, "It is indeed beautiful!" and they advised him to access a subset index through this wonderful structure on the occasion of year-end processioning which was just about to take place.

"It is magnificent! optimal! excellent!" went from mouth to mouth; they were all equally delighted with it. The Programmer gave each of the rogues top rated priority of Analyst Senior Superior Androgogist Node Index Numerator Evaluator (Assanine) to be worn on their byte embossed magnetic passkeys.

The swindlers sat up the whole night before the day on which the processioning was to take place, burning hexadecimal screens, so that people might see how anxious they were to get the Programmer's new codes ready. They pretended to take the macros off the screens. They put zero out on the spools to a huge pair of printers and they patched away with ZAPS without any REPS in them.

At last they said, "Now the Programmer's new codes are ready!"

The Programmer, with his grandest Codiérs, went to them himself, and both the swindlers raised one arm in the air, as if they were holding up something, and said, "See, these are the PAGE SETS, this is the CODE, here is the Mainline!" and so on. "It is as cohesive as a system generation. One might think one had nothing to load, but that is the very virtual beauty of it!"

"Yes!" said all the Codiérs, but they could not see anything, for there was absolutely, relatively and virtually nothing to see.

"Will your Lead Programmer be graciously pleased to delink his old codes," said the impostors, "so that we may put on the new ones, along here before the Great Monitorer image reflector."

The Programmer unlinked and de-

### Reality Dealers.

Anchorage 907/276-2431  
Atlanta 404/266-8900  
Baltimore 301/796-4320  
Boston 617/890-1400  
Cedar Rapids 319/377-6259  
Chicago 312/298-3840  
Cincinnati 513/671-1888  
Cleveland 216/621-1888  
Dallas 214/358-2468  
Denver 303/773-1510  
Detroit 313/478-4400  
Harrisburg 717/763-0850  
Houston 713/440-6111  
Juneau 907/586-2524  
Kansas City 913/321-7902  
Los Angeles 213/685-8910  
or 714/521-4041  
Memphis 901/274-5960  
Miami 305/565-0517  
or 305/940-9994  
Minneapolis 612/835-1000  
Newark 201/964-6700  
New York 212/697-4466  
Philadelphia 609/779-1901  
or 215/922-6776  
Phoenix 602/275-7511  
Portland 503/245-6631  
Raleigh 919/782-6020  
Richmond 804/780-2938  
San Diego 714/560-0777  
San Francisco 415/547-6565  
Seattle 206/641-4990  
St. Louis 314/946-6757  
Utica/Syracuse 315/797-8062  
Washington, D.C. 703/549-4300  
Australia 922-3300  
England 0442-61266  
France 460-33-00  
Germany 69-30-01  
Mexico 905-536-90-50  
Montreal (See your directory)  
Puerto Rico 809/844-3020  
South Africa 48-0520  
Toronto (See your directory)  
Venezuela 45.70.15



# READERS' BONANZA!

Get up to 50% OFF on your choice of these 10 outstanding books. Here's a great offer to readers from DBI Books, a subsidiary of Technical Publishing Company—the publishers of Datamation.

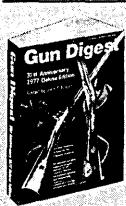

### GUN DIGEST 1977 31st Edition

Edited by John T. Amber  
The lowdown on every facet of guns, shot and shooting. Illustrations, specifications, prices and characteristics on all U.S. and imported firearms and accessories. 448 8½" x 11" pages.

\$8.95.....No. 1076



### CAMPER'S DIGEST 2nd Edition

Edited by Erwin and Peggy Bauer  
Your guide to the great outdoors covers where to go, when, what to take, what to eat and how to prepare it. How to care for your gear. 288 8½" x 11" pages.

\$5.95.....No. 6126



### 1908 SEARS, ROEBUCK CATALOGUE

A perfect reproduction for a nostalgic journey through the good old days when a dollar was still a dollar and the sewing machine was a fantastic dream. Over 600 fun-filled 8½" x 11" pages.

\$3.95.....No. 1908



### ROD LAVER'S TENNIS DIGEST 2nd Edition

Edited by Rod Laver and Bud Collins  
Smashing reading to help your tennis game. Instruction, playing tips, personalities—everything about winning tennis from a superstar. 288 8½" x 11" pages.

\$7.95.....No. 6626



### 495 GOLF LESSONS BY ARNOLD PALMER

Edited by Earl Puckett  
Learn the Palmer Method in this illustrated set of lessons. The seasoned pro is a superb teacher who offers reassuring instruction to reduce your score. 128 8½" x 11" pages.

\$4.95.....No. 4616

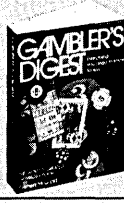

### GAMBLER'S DIGEST Edited by Clement McQuaid

Whatever your game, this incisive volume of gambling strategy can keep the odds in your favor at the table, wheel, sports pool or lottery. Cover your bet in 320 8½" x 11" pages.

\$6.95.....No. 7116



### HOBBY GUNSMITHING By Ralph Walker

Your kitchen table or workbench, a few basic tools, and you're on the way to a rewarding pastime. Close-up photos and detail drawings keep mistakes minimal, and enjoyment maximal. 320 8½" x 11" pages.

\$5.95.....No. 5126



### SKIN AND SCUBA DIVER'S DIGEST By Robert R. Springer

Everything for the underwater adventurer. Dives deep into equipment, technique, and underwater safety. Features on marine life, spearfishing, search and salvage. 288 8½" x 11" pages.

\$7.95.....No. 7616



### SHOTGUN DIGEST By Robert Stack

Covers the history, development and uses of shotguns. Competitive outlooks for U.S. participation in international meets. In-depth articles on chokes, sights, shells and loads. 288 8½" x 11" pages.

\$6.95.....No. 5716



### OUTDOOR PHOTOGRAPHER'S DIGEST Edited by Erwin and Peggy Bauer

47 outstanding features to sharpen your outdoor photography. A must for hunters, fishermen, campers and vacationers. 288 8½" x 11" pages.

\$7.95.....No. 7716

## HOW TO ORDER

Now you can buy any of the books listed on this page and get another book of equal value as a special BONUS.

- Order any combination of books you wish.
- For each book you buy, you may select a second book from this page of the same price or less FREE.
- Please include \$1.50 for each free book to cover postage, packing and handling.

**DBI BOOKS, INC., Dept. D-1**  
Subsidiary of Technical Publishing Company, 540 Frontage Rd., Northfield, IL 60093

Enclosed is my check or money order for \$\_\_\_\_\_. Send books checked above. I've included the necessary postage and handling fees. (See "c" above.)

I'm Buying These	Send These FREE	Book No.	Price Each
<input type="checkbox"/>	<input type="checkbox"/>	1076	\$8.95
<input type="checkbox"/>	<input type="checkbox"/>	1908	\$3.95
<input type="checkbox"/>	<input type="checkbox"/>	4616	\$4.95
<input type="checkbox"/>	<input type="checkbox"/>	5126	\$5.95
<input type="checkbox"/>	<input type="checkbox"/>	5716	\$6.95
<input type="checkbox"/>	<input type="checkbox"/>	6126	\$5.95
<input type="checkbox"/>	<input type="checkbox"/>	6626	\$7.95
<input type="checkbox"/>	<input type="checkbox"/>	7116	\$6.95
<input type="checkbox"/>	<input type="checkbox"/>	7616	\$7.95
<input type="checkbox"/>	<input type="checkbox"/>	7716	\$7.95

Name \_\_\_\_\_  
Address \_\_\_\_\_  
City \_\_\_\_\_  
State \_\_\_\_\_ Zip \_\_\_\_\_

## NEW CODES

linked all his old codes, and the impostors pretended to give him one segment of re-entrant code after the other of the new ones which they had pretended to index. They pretended to fasten something to his vroc and to tie in simulation; this was the chain, and the Programmer tested round and round in front of the screen and Monitorer.

"How well you link in the new codes! How efficient they are!" cried all the people on the staff. "What a design, and what clean structures! They are most optimal codes indeed!"

"The Director is waiting to view the accessing by your macros," announced the Manager of the Computation Center and Thrift Shop.

"Well I am quite ready," said the Programmer. "Don't these codes run well?" and then he tested around again in front of the crt's, so that he should seem to be looking at his gaily displayed cursor.

The operators who were to work the shift stopped and pretended to watch messages from the consoles of both cpu's, and they worked along with their hands on the keyboards. They dared not let it appear that they could not see anything, be it real or virtual.

Then the Programmer worked along in the processioning under the optimal system, and everybody on the tapes and at the discs exclaimed, "How beautiful the Programmer's new codes are! What splendid fine structures! And they link to perfection!" Nobody would let it appear that he find nothing, for then he would not be fit for his post, or else he was an illogical Boole.

None of the Programmer's codes had been so seemingly successful before.

"But he has nothing on the screen nor anything that causes the wait lite to go out," said a Mini-user in an active state of dismay.

"Oh, listen to the mathematician," said his i/o processor, and one person whispered to the other what the Mini-user had said. "He has nothing on; a Mini-user says he has nothing on the screen!"

"But he has nothing on!" at last cried all the staff.

The Programmer writhed, for he knew it was true, but he thought controlledly "the processioning must go on now," so he keyed and stroked the crt faster than ever. The operators listed the full contents of the invisible and empty console screens. The noise of the huge printers in the process of printing vast amounts of blanks made it easy to hear the blush of embarrassment rise on the vain Programmer. \*

# New KODAK KOM-85 Microfilmer.

## More flexible, more capable, and reliable as ever!

When you set out to improve a COM workhorse, you don't tinker with the features that made it an outstanding performer. The advanced KODAK KOM-85 Microfilmer gives you new flexibility and capability, combined with the fast, efficient throughput and high reliability of our proven veteran, the KOM-80 Microfilmer.

If your operation calls for high volume with fast turnaround, you should check into the advantages of the new KOM-85 Microfilmer.

The advanced Hewlett-Packard front-end mini-computer gives you

automatic program loading and integrated job setup through a CRT data terminal. You get input flexibility to accept print-image records from virtually any computer system. Faster job setup, easier film handling.

The KOM-85 Microfilmer gives you multiple-microform-output capability, plus a new expanded page format with up to 172 characters per line and up to 88 lines per page. You get broad coding and indexing capability for roll or fiche. Optional document-related coding for automatic retrieval on

16 mm KODAK ORACLE Equipment. Flexible column indexing for fiche, and more . . .

It adds up to more flexibility, new capabilities. With throughput speed up to 24,000 pages per hour. And the extra-reliable Kodak hardware and comprehensive software to handle COM formatting.

There's even more behind your new KODAK KOM-85 Microfilmer. Thorough training and clear, complete documentation; fast, competent, on-the-spot service; responsive and responsible support from dedicated Kodak people—the kind of support that's helped us set an outstanding nine-year track record in COM.

Look into the new KOM-85 Microfilmer. See your Kodak representative, or write Eastman Kodak Company, Business Systems Markets Division, Dept. DP-66875, Rochester, N.Y. 14650.

Since you demand a lot from EDP, demand the same from COM.

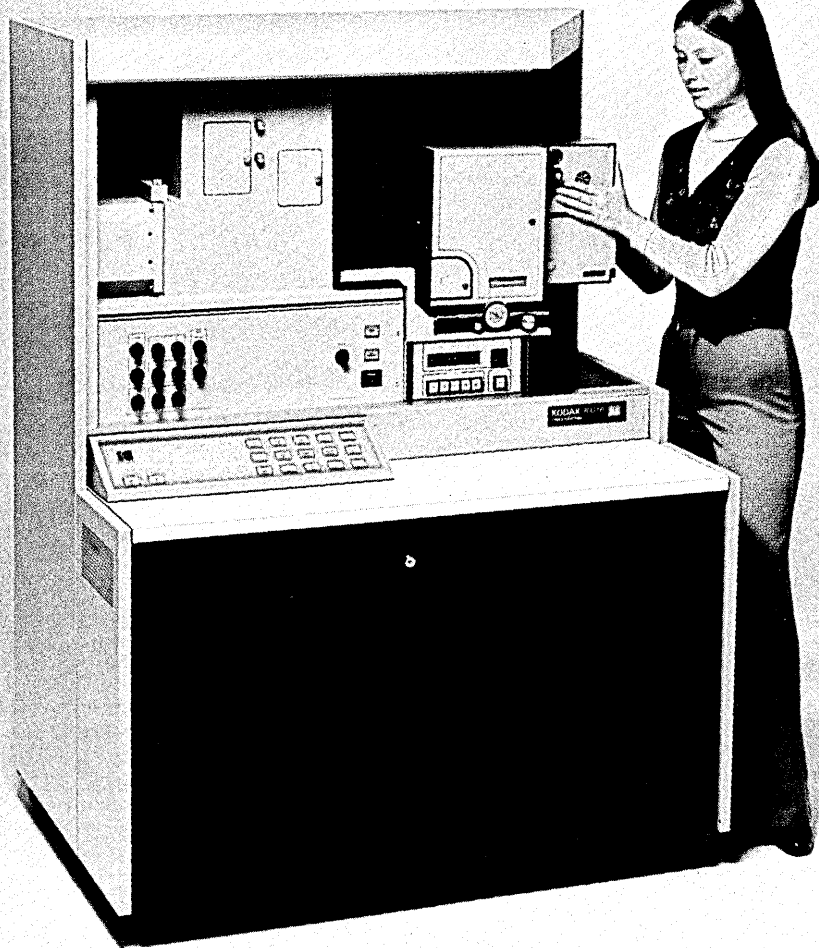

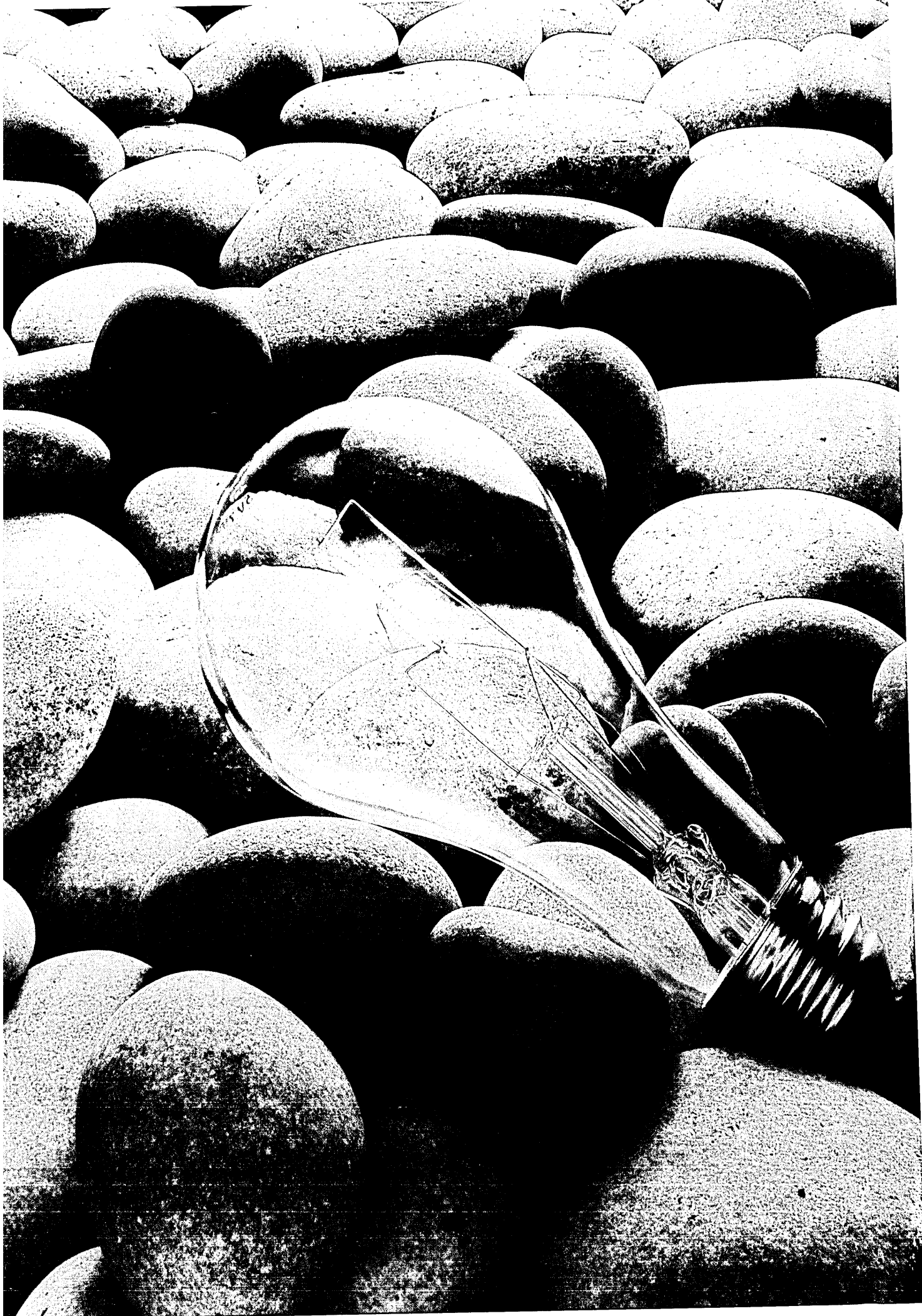



# Our bright idea.

## More computer power for your dollar.

The SEL 32 family of high performance 32-bit computing systems offers a balance between big computer performance and minicomputer prices. Microprogrammable input/output processors, compatible central processing units, high-speed memory systems, and efficient data processing peripherals make up the hardware elements. On the software side, operating systems, language processors, libraries, application packages, and interactive terminal support balance the scales. Together, SEL 32 hardware and software provide a cost-effective solution to your current requirements, with expansion capability to meet your growth needs.

The SEL 32/35 is the strongest price-performer of any 32-bit single or multiple-CPU system available today. These computers can be configured from 64K bytes to 512K bytes of 900 nsec memory. Resembling its more powerful brothers, the SEL 32/35 is a complete package, including central processor with floating-point arithmetic, memory, chassis, power supplies, and cabinet.

The SEL 32/55, offered in a variety of both single and multiple CPU configurations, can be configured from 32K bytes to 1 million bytes of 600 nsec memory.

The SEL 32/50 is a single chassis computer providing the same CPU, I/O, and memory capability as the 32/55, but for dedicated applications.

Just circle our number on the Reader Service Card, or call us today. We'll send you the powerful story of the SEL 32 family.

# SYSTEMS

ENGINEERING LABORATORIES



6901 West Sunrise Boulevard  
Fort Lauderdale, Florida 33313  
(305) 587-2900

# "Hot Topics" Word Puzzle

## COMPUTER SPECIALISTS

Boeing Computer Services is seeking specialists for a broad spectrum of challenging assignments. BCS is young but a "major" in the computer industry and offers outstanding career potential combined with living in the unspoiled Pacific Northwest.

Immediate openings are for:

- **N/C Systems Analysts and Programmers**

Integrate the APT system with process control computer systems to support the fabrication of parts on N/C machine tools. Or, design engineering plans to define geometry in digital form for direct manufacturing application. Prefer two or more years experience and knowledge of APT and/or Post Processor and large mainframes such as IBM 370 or CDC 6600.

- **Analysts/Programmers**

Develop, implement, and maintain information or data systems. Prefer three or more years experience with information or data systems, working knowledge of 360/370 hardware, COBOL or FORTRAN, OS/JCL programming. U.S. citizenship required.

- **Data Base Designer/Analysts**

Design, analyze and develop physical or logical data base applications. Prefer three or more years experience with IMS on large scale hardware. U.S. citizenship required.

- **Minicomputer Systems Specialists**

Application Analysis, System Design and Software Analysis assignments involving evaluation of mini applications for data entry and Data Base management; design of mini business systems; and development, maintenance and preparation of comparative analyses of mini software and operating systems. Prefer experience with current generation of mini and IBM 370 systems. U.S. citizenship required.

Please send résumé to The Boeing Company, P.O. Box 3707-JBA, Seattle, WA 98124.

An equal opportunity employer.

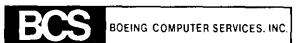

"Amos, wake up—the recession is over!"

The following word puzzle contains the hot topics that the data processing community will "wake up to" in 1977. (To be candid, IBM did not consult us in the timing of the Series/1, "Peachtree" announcement, so that one is actually a

1976 topic. Oh well.) All of the words in the list below are imbedded in the puzzle, though not necessarily next to their counterparts listed here. Note, too, that "systems" and "processing" appear only once.

```

P X T E M I C R O P R O C E S S O R S R G A F
O E G T C A T M O R E R O M A T A C O P I G H
V T I I S E G A U G N A L S O Y L T B E N A W
S J N L A M G N I S S E C O R P A O R D T E P
S M T L F S I A C C T H E H X R W N T I E T E
A E E E S T C G N I K R O W T E N L N E L Y S
I L R T G S H E O N N G L S I R A M S A L P T
R I A A S I J M A C A Y I T I B E L L B I L L
S E C S A Y S E W C L N H H E E C E N T G U Q
L C T E C B S N E A I R F D A T A B A S E U T
A A I M A B P T R M O D E L I N G F I R N S E
I P V D R O W T D E U D I S P L A Y A M C D G
L A E N Y H P A R G O L O H D E R W U R E Y B
O C Y D S R E W E C L O A I F A T V B M U O S
D I P S S A N T I T R U S T Y F I S U P N D F
U T T E E L G R P E P C S D O W F A M S A D O
P Y L D N E I R F R R D I S T R I B U T E D R
L G C T I O N R A P I C U W E B C E A I N R A
A I D I S V E A O P G V E S L E I N O U H C B
I R C T U O E R P S H L A E D M A E N S T J A
R V L D B A R Y U N O I T C E L L O C W R U S
N O I T A C I F I T R E C L Y C C A S A C L T
D I O S L P N V D E C S Y S B X E E N L E I V
E O Y G I R G M E N N E I S T C L E V E N R O
N B S O R T S J O N H S F L I N A D I N G V M
    
```

ANTITRUST  
ARTIFICIAL INTELLIGENCE  
BELL BILL  
CAPACITY MANAGEMENT  
CATAMORE  
CCD  
CERTIFICATION  
DATA BASE ADMINISTRATOR  
DATA COLLECTION  
DISTRIBUTED PROCESSING

EFTS  
EMULATOR  
HOBBYISTS  
HOLOGRAPHY  
INTERACTIVE GRAPHICS  
LAWSUITS  
MICROPROCESSORS  
MODELING  
NETWORKING  
PEACHTREE

PLASMA DISPLAY  
PRIVACY  
SATELLITE BUSINESS SYSTEMS  
SDLC  
SOFTWARE ENGINEERING  
SYSTEMS ANALYSIS  
USER FRIENDLY LANGUAGES  
WORD PROCESSING

\*

**NEW!**

# AUERBACH Buyers' Guide to **BUSINESS MINICOMPUTER SYSTEMS**

A must if you purchase, use, compare or recommend business minicomputer systems. You can't afford to be without this new outstanding buyers' guide—**Guaranteed to save you time and money!**

## **1** Product Reports

analyze the most important systems currently marketed in the U.S. Each report offers a management-oriented overview, competitive product information, hardware and software specifications, user reactions, configuration guidelines and price data... plus totally objective evaluations and recommendations.

## **2** Overview

a special tutorial section, delineates the several classes of business mini systems, and provides guidelines on their capabilities, applications and configurations.

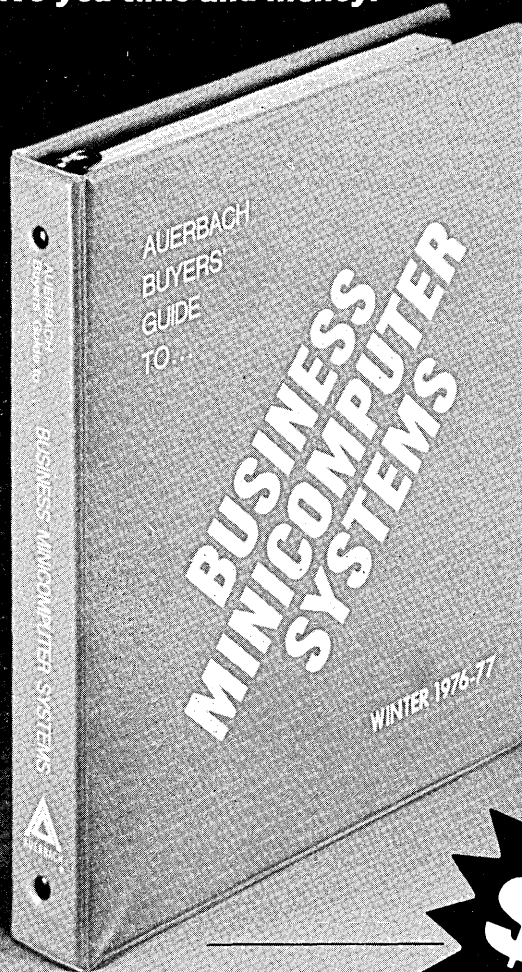

## **3** Search Charts

give you specifications on hundreds of business minicomputer systems, including comparisons on compatibility, capability, features, and more. Arranged in an easy-to-use format.

## **4** Directory of Suppliers

provides a concise, complete list of EDP suppliers.

**ONLY  
\$59**

Over 400 up-to-date, information-packed pages cover every important business minicomputer system used by major industries:

- manufacturers
- wholesale
- utilities
- transportation
- real estate
- retail
- construction
- insurance
- finance

...by any business or government organization.

**At this price, you can't afford to be without it!**



\*If your needs are general purpose minicomputers, then buy the new AUERBACH Buyers' Guide to Minicomputers, also available for only \$59. There's no duplication in information or coverage between these two new buyers' guides. Use independently or in combination with the AUERBACH Buyers' Guide to Business Minicomputer Systems.

AUERBACH Publishers Inc. 6560 N. Park Dr., Pennsauken, NJ 08109 • 609-662-2070 • Telex 831 464

## Education

# Time-Sharing in Education Going, Going, But Not Gone

### Time-Sharing Confronted with Standalone Computers As Educational Institutions Examine One-on-One Approach

When time-sharing was aborning, it was explained that the technique would allow many users to share the processor simultaneously as though each had exclusive use of the large machine. Terminals subsequently became almost as commonplace as the telephone. But in the 10 or so ensuing years, dramatic reductions in the cost of electronics have brought to the marketplace computers that are cheaper than some terminals.

What follows, then, is a natural consequence. Do away with the terminal and modem, avoid the phone line charges and, instead, get your own machine. Some people call this one-on-one.

And it's exactly what the University of California currently is looking into for instructional computing. Not a computer for each student, alas, but a sufficient number of standalone machines to accommodate students who must write, debug, and test programs to satisfy classroom assignments, as well as those who just want to learn what a computer can do.

#### Terminals out at Pasadena

At the Pasadena Polytechnic school, a high school in southern California, they've just replaced their three terminals, which were time-sharing the Cal Tech computer across the street, with three small systems. It's not such a new or startling idea, says supplier Gene Murrow. "It predates time-sharing. Before they had time-sharing, they had one-on-one—one user and a \$450,000 computer!" says Murrow, who is supplying three \$1800 computers.

Murrow is president of fledgling Computer Power & Light Inc., Studio City, Calif. His microcomputer-based Compal-80, priced at a mere \$1,863, comes equipped at that price with 12K bytes of read-write storage, 1K of PROM, a nine-inch crt and keyboard, Extended Basic, and the facility to attach an ordinary audio cassette recorder for auxiliary storage. The system has

been purchased by a number of schools in the Los Angeles area.

The concept of one-on-one is as natural to youngsters as the personal automobile is to their parents. It's the age of transistorized radios for bicycles and of supermarkets selling pocket calculators for less than \$10. The home elec-



THE \$1800 Compal-80 system being used by a number of schools for instructional purposes is shown by Gene Murrow of Computer Power & Light.

tronic video game, which attaches to the tv set, found its place under many a Christmas tree last year. Indeed, Creative Strategies Inc. has projected sales of such games at 17 million by 1980, saying that prices for such games "will fall more rapidly than most industry members recognize." The San Jose, Calif., research firm foresees prices for the low-end, limited-feature games dropping from \$35 last year to \$20 this year.

#### Reeducate users

Murrow, a former math teacher who has been writing instructional programs for years, is convinced there's a place for small computers, too. But he finds he must reeducate users to the idea that three machines, or 32 of them, are better than an equal number of terminals sharing a larger machine. For one thing, a

32-machine facility can have one system crash and still have 31 running. "Also, it's much less likely to crash because it's such a simple operating system," he says. "The one-on-one is so much simpler than these complex time-sharing systems."

He adds that this is especially appealing to school systems, which are delicious targets of bright students whose sole aim is to crash the system. Students love getting into the system exec and into restricted memory. They can do the same with a Compal-80, but then they've crashed only one system, which can be reloaded in 30 seconds.

Educational consultant LeRoy Finkel

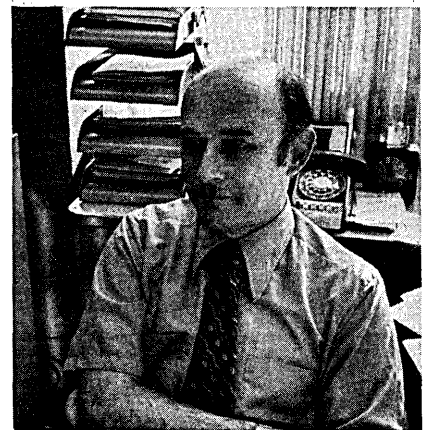

STANDALONE computer systems for less than \$5,000 each are considered ideal by the Univ. of California's Charles W. Stevenson. He prefers them over time-sharing terminals.

of Menlo Park, Calif., recalls the big debate in schools not so long ago. It was over whether students should be allowed to use handheld calculators during exams. One of the strong arguments against it was that many students couldn't afford those \$200 calculators. "With the prices down to \$25," he says, "that argument gets destroyed. Maybe the concept of the future will be that everyone will have to have a home computer."

### Stanford's approach

The problem of delivering computing services to students is being addressed anew this year by Stanford University, which has installed a Digital Equipment Corp. 2040 with 48 terminals. This is being called LOTS, for low overhead time-sharing. The system can be staffed by only four persons, costs \$440,000 to install, and perhaps another \$200,000 a year to operate. It will be for students and faculty only, not for those performing sponsored research work, and it will take an estimated 85% of such workload off the large campus computing facility.

Stanford's progression, from a large mainframe supporting both sponsored research work and students and faculty to the installation of a smaller machine to serve only the latter category, stands in interesting contrast to the program being anticipated by the University of California.

### UC's problem with a 6400

This institution has 120,000 students and nine campuses, all with their own computing facilities for administrative dp, for research, and for instructional purposes. On the Berkeley campus, for example, students formerly submitted jobs in a batch mode to be run on the campus CDC 6400. But the first run, after an anxious wait, would only serve to inform the student that he was a terrible keypuncher—which he already knew. And subsequent submissions reinforced what he also suspected, that there were errors in his program. More recently the campus added two Digital Equipment PDP-11/70s.

"On either system, a student can get computing for a dollar an hour; and those are pretty capable systems," says Charles W. Stevenson, manager of computer planning for the university's Systemwide Administration. The two 11/70s offer two different operating systems and several languages. When the first machine was installed, it was predicted that terminal usage would range between eight and ten hours a day. "Their experience in the first six months was an average of 15 hours of use a day, seven days a week, on each of those terminals," Stevenson says. Based on the use of 25 terminals on each system, he says they can amortize the equipment over a two- to three-year period at a dollar an hour. "They're getting a lot of good computing at a buck an hour."

At that price, he adds, departments prefer the small systems. One professor predicts that within the next six months the campus will have three 11/70s and one 11/34. "And he considered that to be roughly equal to the capabilities of the 6400" at approximately the same price. "And yet one is far more approachable and has a lot more interest for instructional purposes."

Take that a step further and you have

an even more approachable situation, the fabled one-on-one—a standalone machine for instructional computing. It's like a terminal, except that while the student sits at the keyboard he has the entire machine to himself. It would be portable—cumbersome, perhaps, but portable—and could be taken into a classroom for use there. "All you'd need is a three-wire outlet in the wall."

### Why a terminal?

"Why buy just a terminal," Stevenson asks rhetorically, "and then add insult to injury by paying phone charges and the cost of modems and that sort of thing, when you can get what you really need for instructional computing in a standalone version for under five grand?"

He expects soon to be issuing an RFP for this machine. It would have a floppy disc or cassette, graphics capability, maybe in color, an interactive programming capability in some language such as Basic or APL, at least as much user space as in a multi-user time-sharing system, full typewriter keyboard, and some form of coursewriting software or

three-year period.

### The Compal-80, for example

To show that this is not an idle dream, he produces a brochure on the Compal-80 system, saying, "It doesn't take very many hours of use at a dollar an hour to pay for the use of that." He figures it would be less than 18 months. "Probably less than that if you have them in public areas where they're used to the extent that those terminals on the DEC machines are used on the Berkeley campus. And no phone charges."

He has also visited with other prospective vendors, some that regretfully can talk only in terms of a hierarchy of machines. "If you're talking about 200 of these standalone machines, they want you to get one of their big machines. If you want 50 of them, then they want to talk about their medium-sized machines, and if you need one to four, then they want you to get this other (smaller) one. But I think they're missing the point. Because in no case are those systems completely symmetric, and I think it's a mistake to go into this kind of a thing and assume that all systems

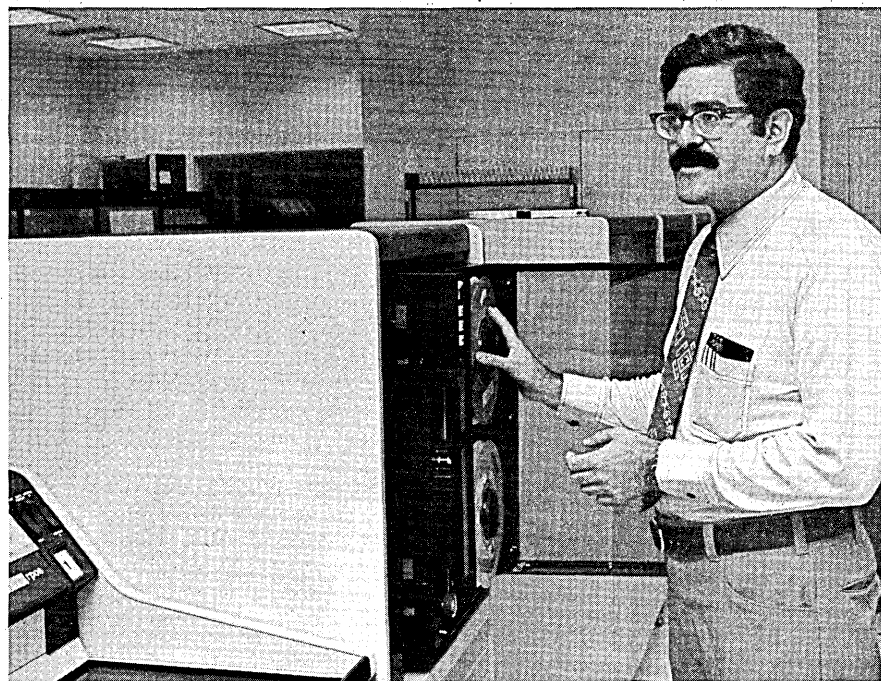

STANFORD'S new DEC 2040 system, shown by time-sharing manager Ralph Gorin, stands in contrast to one-on-one approach to instructional computing.

firmware, such as Pilot or Dialog. And it should be able to communicate with a host computer, should that be desired, and to other devices, such as in laboratory experiments.

"My target price is five grand for that," Stevenson says. "I think it'll come in for less than that from what I've seen so far." In a few years, he adds, such a computer should be available for a third to a half of that price. At a unit price of \$5,000, it's easy to figure how many can be purchased for the cost of installing and operating the larger time-shared systems over, say, a two- or

will be in one particular kind of environment."

Stevenson wants to be able to allow professors to write their courseware, whether it's called computer-assisted instruction or computer-managed instruction, on the same type of machine. And allow them to do this in the privacy of their offices, at home, or in the same setting where students congregate. Vendors, unfortunately, want to provide profs with an expensive one-on-one machine to develop their courseware, overlooking the fact that the programs they develop won't necessarily run on the

# news in perspective

students' machines, and vice versa. There's no symmetry there. What's required is complete program transferrability without change.

## Books vs. courses

He regrets the fact that few academic institutions give a prof equal credit for writing good courseware as for writing a book or technical paper, though hopeful that this will begin to happen. "Well done courseware may involve far more thought and careful preparation and money than writing a book," he says. When this is recognized, it may be possible to store the courseware on a floppy or cassette and sell it in campus bookstores with its companion workbook, thus providing a royalty to its creator. "People sell audio courses now; why not also sell digital courses?" Stevenson asks.

Nor would this be restricted to campus bookstores. What with the current boom in the hobbyist market and the anticipated proliferation of home computers, one could also sell, say, income-tax preparation programs, games, checkbook-balancing programs, and personal records inventory programs.

"I'm not saying these things will replace computing everywhere," Stevenson adds. "Not by a long shot. But it's for a class of instructional use that currently is not being handled very well by anybody—because it's either too expensive or it's unapproachable or you can't get money to pay for it."

—Edward K. Yasaki

## Effects of CAI Studied in LA

Youngsters in four Los Angeles elementary schools returned to school after their Christmas holidays to find themselves part of a federally funded study of the effects of Computer Assisted Instruction (CAI) on elementary students.

And the systems they were working with weren't even in place when the Christmas holidays began. Delivered, installed, and brought up and running during the two week recess were three Cincinnati Milicron minicomputers and 133 Hazeltine Model one CRTs.

The study, to go on over a five year period, is being conducted by Educational Testing Services, Princeton, N.J., best known as administrators of the Scholastic Aptitude Test (SAT) for college bound high school students. Dr. Marge Ragosta of ETS' Educational Studies Div. is project director.

During the study period a selected group of students at each of the schools will be exposed to CAI in math, reading

and language arts. The exposure to math will include grades one through six. Students in grades three through six will be exposed to CAI in all three subjects. Periodically, the progress of students exposed to CAI will be compared to progress of other students in the same subjects.

Three of the four schools involved are in the Venice area of Los Angeles. The fourth is in West Los Angeles. Two have 32 terminals and one computer; a third

## Minicomputers

### DEC's Growth Leaves Gaps For Competition to Fill

The surge in the minicomputer industry shows no sign of slackening. New applications developments, increased acceptance, the facts and fad of distributive processing, even the imprimatur of IBM's Series/1 entry, fuel the thrust even as general economic indicators lag.

The major beneficiary, unquestionably, has been the titan of Maynard, Digital Equipment Corp., whose phenomenal growth has paced the market boom. DEC's first quarter sales were up 46% to \$204.5 million and Wall Street has become accustomed to talk that this, DEC's 20th year, will push the firm into the billion dollar sales bracket. Yet, out in the field—in head-to-head sales competition, among DEC users and potential users—there is growing concern over DEC's ability to absorb the slice of the pie it has traditionally claimed.

The focal point of concern has been the growing lead time DEC has been forced to quote—and the often longer period for actual delivery—for medium and large DP systems, particularly in the business products group, and particularly for oem's. The big money PDP-11 line seems to have been the hardest hit, and while field reports vary widely as to quoted lead times—apparently indicative of a one-by-one customer evaluation in Maynard,—DEC salesmen have apparently been offering some oem's lead times up to and over a year for PDP-11/34s and PDP-11/70s.

The distress of the DEC committed oem's has been both a delight and a source of spillover business for DEC's ever hungry rivals, competition both small and large.

#### It is unavoidable

DEC has aggressively addressed the problem with an impressive plan to double its 3,000,000 sq. ft. of manufacturing plant within two years, but DEC president Kenneth H. Olsen has regret-

has one computer, 17 terminals and a multiplexor which connects it to the fourth which has 52 terminals and no computer.

Minicomputers and software for the system were provided by Computer Curriculum Corp., Palo Alto, Calif. Terminals were supplied by the David Jamison Carlyle Corp., Los Angeles. The fledgling Los Angeles firm (September 1976 p. 176) underbid both Hazeltine and CCC for the \$150,000 terminal contract. All three bid the Hazeltine Model One which had been specified by the School District.

—E.M.

fully acknowledged that, "It is unavoidable that we lose some market share when demand is so high. We like to think," he added, "that what we cannot supply is what is turned over to the competition."

At DEC's annual meeting in October, Olsen described DEC's growth as "unparalleled" by any company of similar size, except in wartime, but he conceded that demand had begun to outstrip DEC's ability to produce: "Difficulties arise when our customers don't tell us of their product needs ahead of time. They are naturally upset when there are shipment delays, especially those customers who depend heavily on us."

Undoubtedly reacting to apprehension that the lead time reflected supply problems like the metal casting and semiconductor bottlenecks that mired PDP-11 production three years ago, Olsen assured stockholders that the problem was capacity not supply. "We sell complex products made up of many different pieces," he said and while DEC's "normal delivery" was between 30 and 150 days, depending on system configuration, with the high demand pressure, delivery for "some pieces" was out to six months "and a few even longer than that."

Olsen's embarrassment-of-riches explanation has been widely accepted by DEC customers, most of their competitors, and by the security analysts who were themselves taken by surprise at the momentum and volume of demand.

There has been some bitter comment from impatient DEC users awaiting shipments that other industry vendors were able to accommodate market growth without DEC's snafus—notably DEC's archival Data General. And competitors snipe at Maynard for "inefficiencies" in final test and assembly and a "product mix problem" which they credit to DEC's matrix production

scheme. But the Wall Street and industry consensus seems to be that DEC has reacted to the problem with all the dispatch and resources a well-managed but habitually conservative company could be expected to employ. Yet over the past eight months DEC has had to deal with a whole range of unlikely management problems, from sales morale to corporate credibility, that reflect Maynard's unfulfilled delivery promises and the resentment of users who rate low in DEC's system-allotment program.

Even the Indian government has protested. Overseas sales seem to have particularly suffered because of domestic priorities—and no explanations are convincing to a DEC-committed systems house which can't get the cpu's it needs for its own sales.

### To favored customers

The variance in quoted delivery schedules seems to depend on who is dealing with what products group when, according to competitive industry sources. The business products group seems to have the biggest problem, but the quotes on delivery don't seem to reflect a corporate schedule or even an across-the-board product group situation. Delays seem to be tailored by DEC officials making the best of a bad situation—according to the importance, need, tolerance, and alternatives available to a particular customer. "It's obvious that in their mind they're not going to pass out machines in the order in which the paperwork comes in," noted a competitive marketing director. "They're setting priorities according to where they have a good market share and in the markets they most value—particularly the Fortune 500 users."

Another competitive executive suggested that DEC product managers have been juggling output among backlog orders: delivering three machines on an order for ten, hoping to catch up later. The varied delivery quotes make it difficult to generalize: some markets report an improved delivery situation over the past two months, in others the situation seemed to deteriorate during the same period.

### Question of competition

The competition for a customer seems a factor too: Data General salesmen seem to report tighter DEC delivery quotes than other smaller minicomputer manufacturers faced. While others reported oem delivery schedules commonly out to a year, Data General sources claimed their salesmen, who

nine months to a year, now bid against 11/70 deliveries in four months for end users and six months for oems.

For the PDP 11/34, end users were quoted four to five months recently, and oem's are now promised delivery within seven months at the outside. The competitive consensus is that DEC is favoring domestic clients—and more than one competitor reported they were interviewing overseas DEC personnel who were disheartened by what they saw as a delivery bias against foreign markets.

One minicomputer executive just returned from a tour of the Far East, reported that in Japan, where DEC has long maintained a sizable staff, DEC users complained bitterly that they had been treated as second class customers. Japanese users quoted DEC PDP 11/70 lead times at six months, eight months for the PDP 11/35 and nine months for the PDP 11/45. "The people over there think they have been forced to bear the brunt of the burden for Maynard's lack of foresight," said a competitive sales chief.

Last year DEC expanded its plant by 20%, developing locations in New Eng-

land and the Southwest. Personnel grew by 30% last year to 2,500 employees, and six months into this fiscal year, they've added 400 more and hiring continues yet despite all this evidence of commitments and active expansion, competitive sources gleefully note that there are apparently a number "sizeable" oem's who have decided to make major investments necessary to switch vendors, either because of the way DEC ignored their problems in the current crisis or distrust of DEC's ability to honor future commitments.

### Up for grabs

The subject is sensitive. A survey of DEC competitors found virtually all claiming that they had gained business specifically because of the DEC delivery delays but for most the extent and nature of that business was not for comment. Part of the sensitivity, apparently, is due to the fact that "several major oem's" have been shopping around and there are a number of important deals up for grabs.

"These are companies that have been in bed with DEC and are now talking

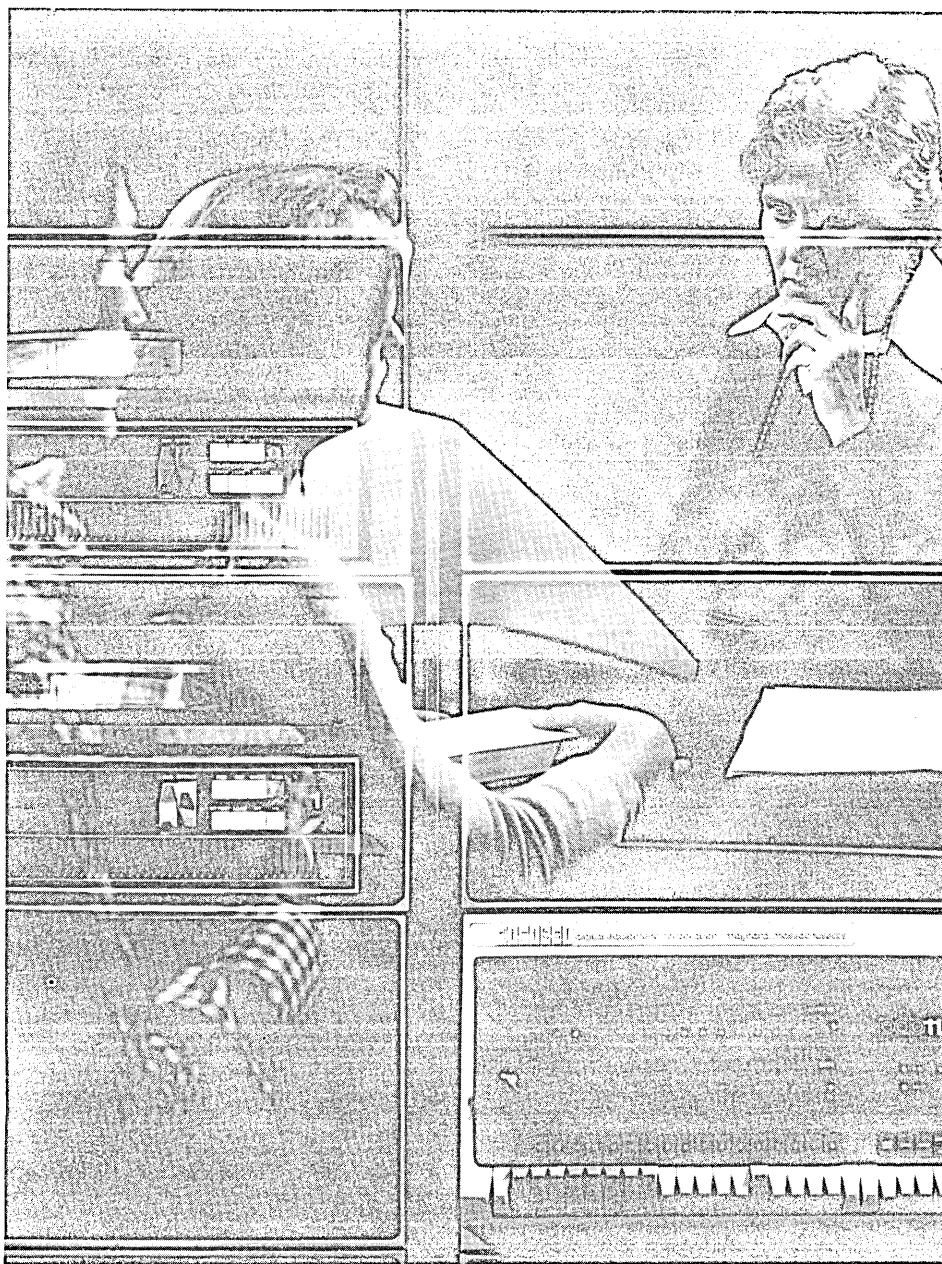

**DEC DELAYS:** One competitor suggests the company delivers three machines on an order for ten, hoping to catch up later. Kenneth Olsen says it's a case of capacity, not supply.

change, even though it will take a major investment and six to nine months, maybe even a year, for them to turn over," explained one industry executive. "But they're out there. And some of them are visiting around the industry talking confidentially about making just that investment."

Because of the cost of their choices, the nature of the business, and the insight into DEC policy that comes from long term ties, major oem switches are seen within the industry as serious no-confidence votes in DEC's ability to resume normal shipments in a sector of the market they previously dominated. It may be simply the "inevitable" loss of market share DEC foresaw—it may even be only business DEC chose to risk—but the hush talk of possibilities has been a source of considerable excitement in minicomputer sales.

Harlan Dybdahl, head of marketing for Modular Computing Corp., Ft. Lauderdale, Fla., is one of the few executives who did not request anonymity. He reported that his company had the "very exciting possibility of two rather large oem's turning to Modcomp either as a second source or—a real possibility—changing altogether from DEC. If deliveries were not a problem, they probably would prefer to stay with DEC, but now they're out in the market."

Dybdahl said Modcomp has also gained "substantial" end user orders largely because of DEC's problems. "We have customers approaching us," he said, "and not just us. There are some sizable firms involved and I know they've been checking with others too." Some have complained of DEC-quoted deliveries on PDP 11/34 machines out beyond a year, he said: 12, 13 or 14 months.

## Two for Interdata

An Interdata sales executive said his company has already been able to nail down at least two similar "good sized oem's"—the deals currently are in contract negotiations, but Interdata personnel are already training the new customers' staff. Both oem firms, said this source, believe it will take them six months to make the changeover.

Jested one hopeful Interdata salesman: "Soon a man will be able to make a good living just going around picking up orders DEC can't fill."

Competitors have attempted to exploit DEC's problems many ways, but all are keeping a tight rein on their own delivery schedules. DEC can sail through its delivery crisis, but for another firm, any hint of similar problems might now trigger a market response all out of proportion to the actual situation. Data

General has used advertising to draw direct comparisons between its own one and two month delivery schedules and DEC's problems. Data General has expanded production capacity 80-90% over the past 12 months and has had the luxury of expanding production just to accentuate the contrast. "We make no

## People

### John Backus of Fortran Fame : Now He'd Unclog the 'von Neumann Bottleneck'

Through a wall of glass, and from a wooden deck beyond it, can be seen the San Francisco Bay. The vista extends from the Pacific Ocean on the left, just outside the Golden Gate bridge, extending to the Oakland Bay Bridge on the right, and includes the motley assortment of high-rise office buildings in the downtown area. It is an exceptionally clear day and the view from atop the fashionable Twin Peaks area of the city seems hardly conducive to getting any work done. But it's the home and second office of John Backus of IBM who, this fall, received the National Medal of Science for 1975.

It's an honor that seldom goes to those working in computing. But this year, when 15 recipients were named in June, Backus was joined by George B. Dantzig of Stanford Univ., who has worked on computer-based algorithms in linear programming and operations research.

Backus and Dantzig are but two of a long list of people considered for the prestigious award. "I never expected that I would be on such a list, really," says Backus. "A mystery to me, how those things happen." But the experience cannot be entirely new to him. In 1974 he was elected to the National Academy of Sciences, and again is one of the very few members of the Academy who have no other specialty than computing.

John Backus is most often thought of as the inventor of FORTRAN, a misconception he immediately asserts the need to dispel. "It just seems so grotesquely unfair," he says, claiming he has been given too much credit for the algebraic compiler development. Backus, who led the group at IBM that developed FORTRAN, talks of the pioneering work of people like Irving Ziller, Robert A. Nelson and Sheldon Best, who were among a small cadre of people on the project.

"Basically there were six or eight people who were central to it," he says. "Those were different days . . . It took us three years. And by today's standards, it was a tiny project. It was only 25,000 instructions."

secret of the fact that we have attempted to cut our lead time to take advantage of DEC's delivery problem," said a DG executive. "We've probably cut our delivery schedules to even less than we would normally like to maintain."

Added a DG spokesman, "We've been following DEC's growth but we're not going to be caught with DEC's shipment problems—one of the benefits of being number two is that you can learn from the other guy."

—Vin McLellan

Backus' group worked at a number of locations in midtown Manhattan. "All the executives and salesmen got the good offices, and we got what was left," he recalls. At one time they occupied the very top floor of the annex of 590 Madison Ave., next to the elevator machinery. They were then moved to a building on 56th Street.

"Looking out of the window across 56th Street," Backus remembers, "there was a vacant lot, and then the back of an apartment building. On the same floor that we were on, there was a young lady who slept without any clothes on. She used to get up and dance very, uh, very free-form dances for awhile, out of sheer exuberance, early in the morning. Needless to say, we had no trouble getting people to come in, not only on time, but early."

Transferred across Fifth Avenue, the group found their offices overlooking the ladies' dressing room of some department store. And their next location provided a similar view at a Bonwit Teller store. "So people spent a lot of time at the windows."

## Historical misunderstanding

A historical misunderstanding regarding FORTRAN, one that Backus admits he has mistakenly contributed to, has to do with an algebraic compiler developed earlier at MIT for the Whirlwind computer, generally credited to J. H. Laning Jr. and Neal Zierler of the Instrumentation Laboratory of MIT.

"A letter I got from the Instrumentation Lab not too long ago indicated that they had demonstrated the principle of producing code from algebraic expressions in 1953," says Backus. "I had always believed that we had got the idea for using algebraic input, and that sort of approach, from seeing a demonstration of Laning and Zierler's compiler at MIT. I have always said that, and it got into certain historical accounts. And I have always said that we started work on FORTRAN in the summer of '54 . . ."



More recently, however, Backus received from Laning a copy of a letter that he, Backus, had sent in May of '54, requesting a demonstration of the MIT compiler. But earlier that month, at an Office of Naval Research conference, Backus and a co-author presented a paper in which they commented on the possibility of having programming systems that handled two-dimensional arrays (the MIT version handled only one-dimensional arrays) and algebraic expressions of a different sort from those accepted by the Whirlwind compiler.

"It turns out we had begun working on FORTRAN in January or February of '54," Backus now says. "We had been doing a lot of thinking about what the input language was to be like and what

was appointed an IBM Fellow, no doubt for his work on the FORTRAN project. But earlier he also worked on various mainframe projects (he was at least partially responsible for talking IBM into building floating point into the 704) and later worked on syntax description.

"I'm surprised to find that some people know me for Backus Normal Form and have no idea that I had anything to do with FORTRAN." He chuckles, pauses, then adds, "You know, *that's* something I did myself." Backus Normal Form, of course, is a notation for describing the syntax of a programming language.

For many years, Backus says, he had worked on the mathematics of families of sets and operations on them. "I have reams of notebooks on various theorems

duced were notebooks, he adds that "I'm certainly enjoying the work I'm doing now." He says his work provides some kind of intellectual basis for a different kind of machine, and is beginning to arouse some interest. "I have this view that modern computers are really very strange if you look at them very closely. You can think of them as being a cpu and a store, and a narrow tube connecting them. What you're trying to do is change the contents of that store in some major and significant way. And it all takes place by sort of huffing and puffing one little word at a time through that damned little tube, which I call the von Neumann bottleneck . . ."

What he wants to do, he explains, is to provide an alternative to the von Neumann machine and to programming languages that mirror it. He's not certain what benefits would result. "All you can say with some certainty is that it's an advantage to have an intellectual viewpoint where you recognize that there's more than one kind of thing in the universe. If you see two things that are different, your idea of the universe is different than if you're staring at the von Neumann computer and can't see anything else."

The life he leads today, plugging away "at abstract stuff," as he phrases it, high above San Francisco, is in sharp contrast to his school days. Backus says he flunked out of prep school four years in a row, attending summer school each year to remain enrolled. He was also thrown out of the Univ. of Virginia.

Backus is the son of a chemist-turned-stockbroker who not only survived the stockmarket crash of '29 but also became a millionaire. The youngster had aspirations of becoming a mad scientist, and at prep school appropriated the equipment to build an elaborate set-up that had vessels with colored solutions and hoses going every which way. He says it looked like the one in the Alec Guinness movie, "The Man in the White Suit." "It bubbled and made beautiful noises." Backus says.

During the second World War, he was drafted into the Army, where he continued his education—if that's the word—in the Army's specialized training program, where he attended the Univ. of Pittsburgh, Haverford College, and a medical school in New York City. The potential mad scientist, picturing himself studying people's brains, found that med school was "quite a different affair," and not what he wanted to do at all.

"I really wasn't interested in anything except listening to music," he says. With a desire now to build a good hi-fi set, he attended a radio technician's school under the GI Bill, and there met the first teacher he liked, someone who interested him in mathematics. This led to an enrollment in math at Columbia Univ.



JOHN BACKUS: An IBM Fellow since 1963, he received National Medal of Science for 1975. Fortran pioneer today works out of second office in his home in San Francisco's Twin Peaks area.

we were going to do. And we had obviously, by the time of that May conference, settled on an algebraic sort of input." Only after this did they see a demonstration of the MIT system. "It doesn't change the fact that (Laning) was the first one, to my knowledge, to have an algebraic compiler." But Backus is now certain that he had learned of the existence of that compiler at the ONR conference. "So it is clear that we didn't get the idea from them. It was just an independent development."

### Named IBM Fellow in '63

The FORTRAN compiler, which the group thought could be completed in six months, was first distributed to customers in April 1957. Backus, in addition to leading the development, says, "I got the project underway." In 1963 Backus

about that stuff, which are all filed away. I didn't get the results that I had hoped to get." So he has set them aside and has been working on programming language fundamentals. "I'm not trying to design another baroque language like FORTRAN or PL/I," he adds. Rather, he is trying to understand the basic ingredients with which to build a language. "And I mean basic, not long lists of features . . . If I succeed in what I'm trying to do, it would result in a language that could be completely described on one page. It would have simple mathematical foundations and its programs would have good mathematical properties." He finds a lack of both these features today.

### "von Neumann bottleneck"

After a long period when all he pro-



# Show this Intertel ad to your Codex salesman.

And he'll grant your fondest wish.

## Go ahead, it's all right.

This advertisement is about network control for on-line teleprocessing systems. It is also about wishes. Since Intertel is the #1 company in network control for on-line systems. And Codex is very big in wishes. It's actually quite logical to show an Intertel advertisement to a Codex salesman.

## Remind him about the Intertel challenge.

Recently, Intertel challenged Codex to a showdown on network control. In case you missed it, here's how it looked.

**OK, Bell.  
OK, Codex.  
OK, Milgo.  
Fill in  
the blanks.  
Or we'll do it  
for you.**

<p><b>Dell?</b></p>	<p><b>Codex?</b></p>
<p><b>Milgo?</b></p>	<p><b>Intertel.</b></p>

**Network Control is our business at Intertel.** We're very good at it. In fact, we're the #1 company in network control for on-line systems. Naturally, we have competition. But our competitors say they have network control for on-line systems, too. Quite frankly, we think they don't. We think it's just talk. Or wishful thinking. Or both. And we're going to prove it. Here's our challenge. If, within 30 days, they send us a specification sheet for their product, we'll be happy to match it at our level. At. Free of charge. Right here to our own.

**And you can decide for yourself who has the best product.** On the other hand, if they don't respond, we'll talk you about that, too. And you can draw your own conclusions. Either way, you'll be better informed about network control. In the meantime, if you want more information about a real Network Control System, one that can improve your system availability and cut downtime to an absolute minimum, call us. We're #1 in network control.

**intertel** 6 Vine Brook Park, Burlington, Massachusetts 01803, Tel. (617) 273-0950

In case your Codex salesman missed it, remind him that his company refused to participate.

## But, don't let him change the subject.

At this point, your Codex salesman may want to talk about something else. Like the weather. Or his kids. Or the great vacation he had in the Philippines. Tell him to save it. You have some very important questions to ask.

## Ask him some tough questions.

The performance you can expect from his product has a lot to do with the way he answers these questions. So listen closely.

Question 1. How many Codex network control systems are installed?

Question 2. Will your product work with any network from 1200 baud to 9600 bps?

Question 3. Can your product do diagnostic testing and restoral in distributed networks,

especially outbound from multiplexers and concentrators?

Question 4. Does your product have an English language display or real time line level monitor?

Question 5. Does your product have dial backup at all speeds, 1200 baud-9600 bps?

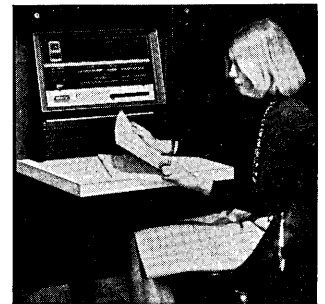

Our NCS4000 is the first Network Control System for distributed processing.

Considering the way his company responded to the Intertel challenge, perhaps you should get the answers in writing, before he disappears.

## Now call us.

Now call Intertel. Ask the same questions and throw in a few tough ones of your own. We'll be happy to answer them.

After all, we've had plenty of experience. Intertel has installed more than 100 Network Control Systems. For banks, airlines, and Fortune 500 companies. All over the world. Right now, those systems are saving time and aggravation for management people just like you.

Call us and ask about them. Or, if you want to know more about our NCS4000 Network Control System, send for our free brochure.

## Don't forget your wish.

Ah, yes. The wish. Well... if you showed this ad to a salesman for our competition, and that salesman is still hanging around your office, you probably wish, more than anything else in the world, there was some way to get rid of him.

There is. Ask him to grant your fondest wish.



#1 in network control

6 Vine Brook Park  
Burlington,  
Massachusetts 01803  
Tel. (617) 273-0950

# news in perspective

("I didn't mention several schools I had been to"), where Backus was to get his first bachelor's degree, and a master's, too.

## At IBM in 1950

"Before I even got my master's, I just wandered in to see an IBM computer. And, uh, sort of got hired then and there." It was 1950 and Backus was conducted through a demonstration of the SSEC, the Selective Sequence Electronic Calculator, managed by one of its inventors, the late Rex Seeber. "I mentioned to the girl who was showing me that I was looking for a job." She suggested that he see her boss, an invitation Backus declined, not even being properly dressed for an employment interview. But she insisted, he did, and he got the job.

The mad scientist-turned-mathematician is now 51 years of age. He somehow retains a boyish, if not athletic, physique, a refreshing enthusiasm for his work, and an ability to examine himself objectively. "Honors are a funny affair," he says. "You really shouldn't take them too seriously."

Backus says he does consider them an honor, and wouldn't put them down. But he's also amused by one he almost got. He was one of seven people selected for the 1974 Presidential Prizes of Innovation, which carried with them monetary awards of \$50,000. It was one of President Nixon's on-again, off-again affairs with the scientific community, a program declared dead earlier last year. Backus' understanding is that the checks were made out and left in someone's safe, awaiting a convenient time for their distribution by Nixon. The president never got around to it.

"I got a call from some bloke in the White House, asking whether I knew that I was being considered for this prize. I said no, I didn't, but I was honored. That was about all the conversation consisted of, as far as I can recall. He stressed that he was not certain that I was going to get it." After he hung up, Backus thought it very odd to be informed merely that one was being considered for a prize. "That was the last I heard of it."

—E.K.Y.

## Technology

### Man and His Machine: The Relationship Becomes Crucial and More Complicated

"It's taken 1,000 years to shake off the shackles of mechanical drudgery." And it's machines, mainly computers, says Dr. Carl Hammer that have "relieved" man of this mechanical burden. Now it's time, insists Univac's computer sciences director, to find ways to use these "mind amplifying machines to strive to become a knowledge society."

Focusing on the future relationship between man and machine, Hammer was one of several top computer technologists to address the American Society of Mechanical Engineers 97th annual winter meeting held early last month in New York. The five-day conference, which featured four forums on the "Impact of Computers on People and Technology," attracted 3,500 attendees to New York's Statler Hilton Hotel. In addition to the four computer forums, the ASME meeting also included 31 computer-related technical sessions, three short courses on dp technology and an 18-booth computer exhibit showcasing such things as numerical control systems and computer controlled industrial robots.

Picking up on the conference's computer theme, Hammer updated the mechanical engineers on the latest com-



DR. CARL HAMMER  
Foresees chips of 10 million bits  
or greater in next 5-10 years.

puter advancements. The "miracle of the chip," made possible by the LSI process, the Univac scientist explained, has produced 4K and 8K chips. But in the next five to 10 years, he predicted an even greater capability with the development of "10M chips or greater."

In terms of computer application power, Hammer sees all this increased chip storage capacity leading in 10 years to selective voice recognition systems which he claimed will "allow operators to talk back to the computer." Also in the not too distant future, Hammer envisions voice-to-print systems and print-to-voice machines which would provide remote access to libraries. "A full language translation capability" for real-time language translation, he said, is five to 10 years away when the 10M chip becomes available.

## More turmoil

On a less optimistic note, Hammer warned that all these technological changes will lead to "another 20 years of turmoil." Contributing significantly to this turmoil, he said, would be software problems. He also believes there will be people problems.

"Enormously large segments of society," he predicted, "will be affected by computer advancements." One of the main impacted sectors, according to Hammer, will be the clerical and secretarial workforce, which Hammer insists will "have to be retrained for something else" in the next 10 to 20 years. It's this relationship between man and machine that Hammer thinks is crucial. "When we finally solve the more important interface channels between man and machine . . . that is the time we will make progress," he emphasized.

## Hopper on planning

Another ASME computer forum speaker, Dr. Grace M. Hopper, head of the Navy's programming languages section, sees progress in computers coming from an examination of the effects of the future on planning in the present. "Look toward the future," she stressed, "in using computers and base plans not on what's being done now but what will be done."

Present needs, she observed, call for "faster and more reliable computers." But with computer processing coming closer and closer to the speed of light, she cautioned against making "things too small too fast."

Getting into her famous minicomputer monologue, Hopper presented her scenario on future computerization. "It's a very different world we're moving toward. There will be an evolution and it will begin when today's computers become overstuffed with applications."

According to Hopper, this is already happening, causing computer builders to turn away from larger and larger computers in favor of smaller distributed groups of systems. "In a few years," she maintained, "all computers will be built out of microcomputers. We'll have a system of microcomputers doing things simultaneously, bringing structural engineering and not step-by-

step mathematical concepts into building computers."

### Multi-dimensional thinking

This new approach to developing computers, she said, will require programmers and analysts "to be architects in order to structure systems." It will also require thinking in a multi-dimensional mode, which Hopper claimed will cause "problems for programmers who think one dimensionally."

The benefits of the mini and micro-computer evolution will be reaped, according to Hopper, by everybody including small towns and businesses. Only a little over five percent of businesses now use some form of computer service, she pointed out.

To remedy this situation, she urged that people be trained "to take the mini and micro out to the smaller towns and businesses." She also encouraged the mechanical engineering community to get involved with computers—"enjoy them, use them and learn about them. They're the second best tool man has built, the first and best tool being language. But remember," she warned, "they are a tool and no more."

### A place for large machines

Dartmouth College president Dr. John G. Kemeny also sees the mini/micro trend as "a major step forward." However, he also believes that there will always be a place for large machines "which provide a means of sharing knowledge." The "best of all possible worlds," he told ASME conference atten-

dees, might be a computer network made up of a large central processor with connecting satellite minicomputers.

Regardless of how computers are configured, Kemeny says society will ultimately benefit from their usage. "The greatest contribution of computers for scientists and society," he claimed, "is in terms of their ability to attack large and complex problems." As an example, he cited the teaching of mathematics to science and engineering students.

"There is very little that couldn't be taught through computers," he contended. "Instead of asking a student to solve a problem, ask a student to program a computer to solve it." In this way, he explained, important conceptual skills could be learned, leaving the arduous mechanical process to the computer.

A long-time advocate of educational timesharing, Kemeny noted that a time-shared computer system "is the only reasonable way to teach science and math today." Unfortunately, educational institutions, he complained, have been "very slow" in getting hands-on computer experience for their students.

Calling this computer experience an "essential part of higher education," Kemeny denounced educational establishments that spent money on "lots of things" other than computers. It's as equally a vital tool as a library, he argued, and could be used to wipe out "superstitious beliefs of what a computer can or cannot do."

—Linda Flato

---

## Railroads

---

### Bar Codes Fall Short of Promised Results

Those multicolored bar codes on the sides of freight cars, meant to improve rail car utilization, have not achieved the results expected. The lack of acceptance of the so-called automatic car identification (ACI) program among American railroaders has caused that industry to re-examine the technology. In another four or five years, it is said, the carriers will have to replace ACI labels at a cost estimated at upwards of \$100 million.

"I think it's fair to say that many people in the industry expected the results of the initial ACI system to be much more positive than what it's been to date," says a spokesman for the Assn. of American Railroads (AAR), which adopted the system back in 1967. By 1974 more than 95% of the 1.5 million rail cars then in service were equipped with the 2 x 3-foot labels, as required. But there was nothing that said the \$30 million or so spent to affix the labels had to be supplemented by an additional investment in trackside scanners to

automatically read the labels. As a result, the AAR estimates that only 600 scanners have been installed, far short of the 5,000 to 10,000 required to develop a nationwide freight car control system.

### Lawsuit against SP

Now, in an antitrust suit filed in late October, it is being charged that one of the rail carriers, the Southern Pacific, is trying to eliminate ACI as a method of identifying and controlling rail cars. SP, it is further alleged, went so far as to specify to suppliers that future freight cars and locomotives were to be delivered without the bar code labels. Spokesmen at SP refused to comment on the issue or the case.

Bringing the action against SP is tiny Computer Identities Corp. of Westwood, Mass., a \$5 million/year maker of bar code labels, wands, and scanners, and a developer of systems for production and distribution control problems. Half of its business is accounted for by the

rail market, such as it currently is: only six or eight railroads use scanners extensively.

The suit, charging violations of the federal antitrust laws and seeking treble damages of \$150 million, identifies as defendants the Southern Pacific Transportation Co. and a subsidiary, TOPS On-Line Services Inc. The latter organization markets the TOPS (total operations processing system) that SP developed for its in-house use. Although SP is known to have tested the label scanners, its system relies on the human eyeballing of a car's identification symbols and numbers painted on the side of each car. Users of TOPS or some version of it are said to include Union Pacific, Burlington Northern, and the Canadian National and British Rails.

### Big contract

But the plum contract being sought by TOPS is a \$50 million order for rail car control systems from ConRail, the consolidation of several regional railroads in the Eastern states. In an attempt to get this contract, Computer Identities charges, SP entered into a conspiracy to discredit the ACI technology, thus opening the way for ConRail to buy the TOPS system, which does not rely on scanning to capture rail car information.

"Think of it this way," explains Computer Identities' president David J. Collings. "Suppose they (SP) made scanners and we designed systems that used people to gather the information. And then suppose they dropped the human-readable information off their cars and urged others to do the same. That would leave the entire market for rail control at their mercy" because cars would then be identifiable only with the use of scanners.

"We feel in an open market the choice of using scanners for data collection, which is the modern way, or using people for data collection, which there may be arguments for here and there, should co-exist," says Collings.

In this atmosphere of uncertainty over whether ACI will or will not continue to be supported by the rail industry, one carrier that has committed to the technology is Grand Trunk Western Railroads, based in Detroit, Mich. This carrier is in the final implementation phase with its \$7.5-million system, of which scanners, minis, and related gear comprise about \$3.3 million. It has installed 61 scanners in its classification yards and along its rights-of-way.

### Scanners are great

Grand Western's Howard Tischler, general manager of information services, has estimated "hard" savings achievable solely through the use of scanners. He foresees a 40% return on investment over a seven-year period,

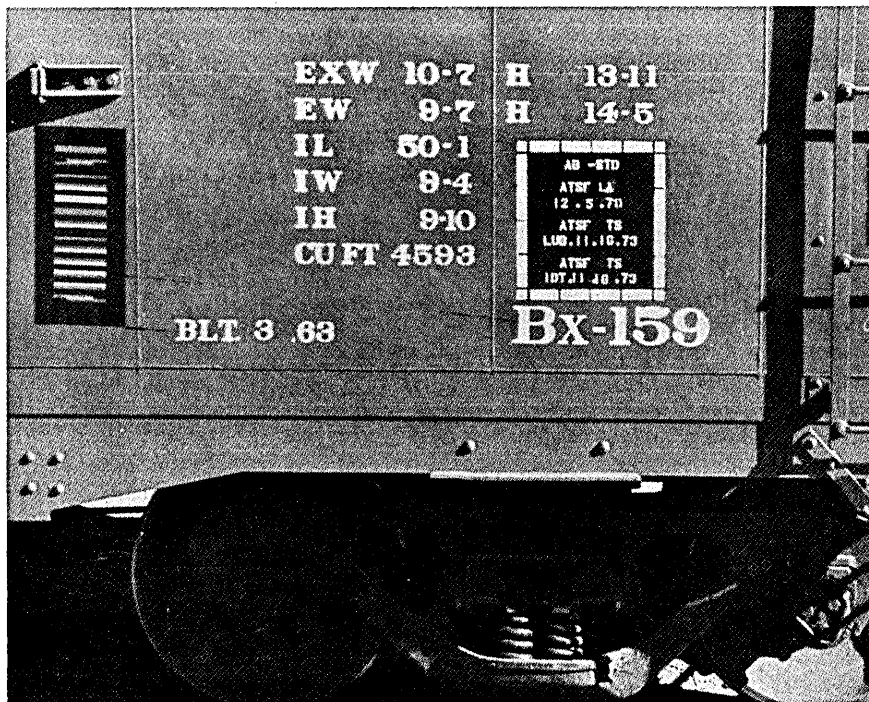

**QUESTIONED:** Labels like the one on the left of this freight car can be read by trackside scanners while cars speed by at up to 80 mph. Recently, the American Association of Railroads, which initiated the automatic car identification program, estimated that only 600 of the estimated 5,000 to 10,000 scanners needed to read the labels have been installed.

paying off the equipment in a mere two and a half years. This disregards such soft savings as improved service to customers and goodwill. "I've been with this project now for almost four years," he says. "I see what scanners do, and I just think they're great."

## Minority view

His enthusiasm represents a minority view in the industry, however, partly because the carriers initially were not educated to the implications of ACI to their operations. Inadequate maintenance of the labels—everything from incorrect labeling to the obliteration of the labels, making them unreadable—is also contributing to the slow acceptance of the program. When the labels were still new, it was being said that 91% of all rolling stock passing a given point was recognizable by the labels. That figure now is said to have declined to about the 80% level, which means you still have to eyeball the cars going by—either on-site or with closed-circuit tv.

"We are looking at ways to improve ACI by increasing readability," says Richard Briggs of the Assn. of American Railroads. He adds that they are looking into more effective labels and readers. "At the same time we're also looking at other methods of car identification, including nonoptical scanners."

—Edward K. Yasaki

## Communications

### Second Bite at the Apple for Bell Foes?

After a year of haggling with the Federal Communications Commission, it looks like American Telephone & Telegraph Co. may have finally gotten its way on the controversial Dataspeed 40/4 CRT terminal. At an informal meeting in late November, the commission agreed to overturn an earlier ruling by the Common Carrier Bureau, paving the way for AT&T to begin tariffing the terminal for interstate operation.

In the surprising reversal, the commission concluded that the combination keyboard and video display system "is not inconsistent with its existing computer rules." But it also added that this decision "was made contingent on the outcome of the pending Computer Inquiry rulemaking. It is intended that this docket," the commission noted, "will be subsequently enlarged to specifically address the issues raised by the Dataspeed 40/4 filings."

To get the regulatory ball rolling in the new tariff process, AT&T has to wait for the formal FCC order which was expected to be issued late last month. Meanwhile an AT&T spokesman indicates that the company will "go ahead and file intrastate tariffs in the rest of the states." Intrastate tariffs on the ter-

minal have already been okayed in various states.

But the final word on interstate tariffing still hinges on the FCC's official decision. This order, reportedly forwarded to Common Carrier Bureau Chief Walter R. Hinchman in early December, will have to be returned to the full commission for a vote after it is cleared by the bureau boss.

## Inquiry on boundaries

The actual decision also will be supplemented by an additional order expanding the reopened Computer Inquiry to include the Dataspeed 40/4 issues. Slated to be wrapped up some time next fall, the new probe is designed to once and for all clearly delineate the boundaries between computers and communications. Comments on the second Computer Inquiry and the related Dataspeed 40/4 question are due Jan. 10.

While the Dataspeed 40/4 dilemma may not ultimately be resolved before late this year when the Computer Inquiry has turned up some answers in this sticky area, AT&T still has the right to seek tariffs and gear up for its marketing campaign. An FCC source pragmatically points out that the company could resubmit its initial tariff filed in November 1975 with possibly minor changes in the rates and specifications. If this procedure is followed, he explains, "they could resubmit the tariff on one day's notice which would mean people wouldn't have a chance to object to it. But they've already had a chance to object to it once," he argues, "so why should they get a second bite at the apple."

## Opponents want it

The Computer and Business Equipment Manufacturers Association, adamantly opposed to the Bell built terminal, is one group that wants a second bite at that apple. Right after the commission's change of heart was an-



DATASPEED terminal is center of controversy between FCC, AT&T and opponents in computer industry. Earliest Dataspeed 40 model was introduced in 1973 with keyboard, display and printer.

# I'm Jim Folts and I'm building the largest company in the terminals business.

We've already shipped a thousand Carousel printing terminals and we'll triple that number this year.

Now we're starting to build the most comprehensive line of terminals ever offered by a single manufacturer. Smart printers and displays. Intelligent terminals. Complete systems. And because we're the Terminals Division of Perkin-Elmer Data Systems, we have the resources of a Fortune 500 company.

That includes a nationwide service program unique to the terminals industry. We offer same-day/next-day service. If our people can't fix your terminal, they'll replace it.

To be the biggest you've got to be the best. In service, in quality, and in performance. And, most important, in people. That's what we're all about. Watch us grow.

PERKIN ELMER | TERMINALS  
DATA SYSTEMS | DIVISION

Randolph Park West, Route 10 & Emery Avenue  
Randolph, NJ 07801 201 366-5550 TWX 710-987-7913

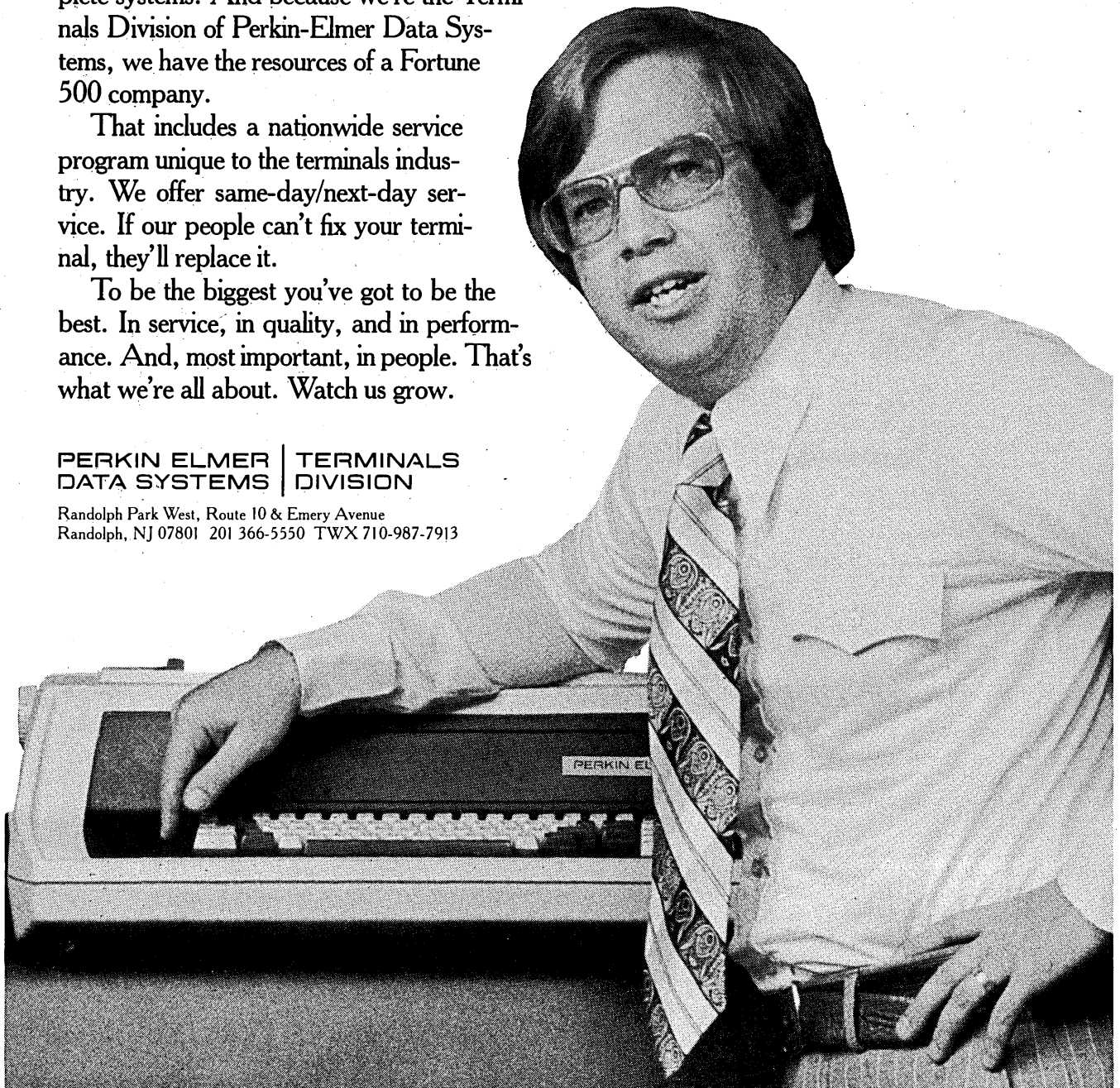

# news in perspective

nounced, the Washington-based association fired off a letter to the FCC, pleading with the commission to delay the Dataspeed 40/4 tariff until the required 60-day comment period was over.

Another industry group, the vocal Computer and Communications Industry Association, also wasted no time in jumping back into the fray. Denouncing the FCC's "press release decision" to allow interstate tariffing of the terminal, the CCIA announced plans to appeal the decision to the U.S. Court of Appeals in the District of Columbia.

But if Bell's game plan is the logical one—to get the terminal tariffed in the shortest possible time—then the CCIA's appeals threat will have no immediate effect, legal experts claim. Following the release of the formal commission order, FCC sources predict that AT&T could resubmit the old tariff and get it approved the day after it's filed. Other than going through the long drawn out

appeals process, AT&T opponents have only two other options—to block the tariff either through a temporary restraining order or a stay of the decision.

Whatever the final outcome is, the commission's current opinion on the Dataspeed 40/4 is clear. "The majority of commissioners definitely believe," says an FCC spokesman, "that it should be tariffed. Their reasoning," he speculates, "is that so many of these devices are already tariffed . . . and they're also hoping there might be some change next year in the Justice-AT&T consent decree." (Under the 1956 consent decree, AT&T is prohibited from offering dp services even through a subsidiary arm.) This possible consent decree revision, he notes, "might allow Bell to sell the terminals even if they can't tariff them. It could," he predicts, "have quite an impact."

—L.F.

## Financial

### Amdahl Given High Marks from NCSS In Seminar for Financial Analysts

"IBM's emerging competition" is a favorite topic for many seminar-goers, particularly the financial community. Last month in New York, several dozen "buyers"—financial institutions with heavy portfolios of IBM (and other) stock—gathered at a Drexel Burnham & Co. meeting to hear four experts on those emerging competitors and learn of IBM's moves to dull their enthusiasm.

The newest of these competitors, the plug-compatible mainframe makers, have been given "credibility" by the performance of Amdahl Corp. and its 470/V6, according to Michael Field, vice president of data systems for NCSS, a \$40 million services company. Last year, NCSS became the first such company to install the Amdahl system, and its experience to date has been a good one, he said.

Most important to the profitable NCSS, the 470/V6 has proved to be 80% more cost effective than the 370/168. It provides 50-60% more throughput than the 168, said Field, and operates at 2½ times the internal processing speed. Reliability has been more than 99%, which is "much better" than that of the 168 when it was first installed at NCSS two years ago. NCSS is also very pleased with Amdahl's support, particularly the on-line diagnosis facility—something IBM offers, "but we never saw."

Describing their decision to buy the V6, Field noted that early in 1976, the NCSS east coast center was running out of capacity on the 370/158 and 168.

Their choices were to add a 158, upgrade the installed 158, or use Amdahl. In addition to the performance improvements, Amdahl offered delivery times of "weeks, while IBM quoted months." The contractual terms were better, especially concerning reliability. The reports from early users, such as Massachusetts Mutual and the University of Michigan, were "favorable."

IBM didn't sit back and let it happen, however, said Field. "We saw levels of IBM management and technical experts we had never seen before. They told us about great things in the 168 we had never heard about before." After the

Amdahl selection, everything went "back to normal." (NCSS still has a 168, plus an owned IBM 360/67.)

While giving high marks to company and system performance to date, Field noted that 1977 will be Amdahl's test year, since it will have more machines and field support. He expects that future versions of the system will implement faster memory chips, allow for use of more channels, and provide new microcoding techniques. "Many of the developments for the next go-round are already in the machine."

### IBM's strategy against competition

Field listed IBM counters to the competition and speculated on more to come. He pointed to the attached processor tie-in with the cpu, microcode that is pulling the operating system into the hardware, and the SDLC communications protocol—all aimed at locking in the user. "All these innovations are being released without much technical information."

He expects IBM to extend the microcode approach, but that will take a couple of years. "As microcode is implemented into larger machines, that will keep new competition from running IBM software unmodified. Independent software groups and companies like NCSS, which modify the operating system, will have to work harder to make new features. *But it's do-able.*" Customers who don't have the expertise will have to conform or go third party. For the conforming, unmodified IBM software will mean more hardware. "I wonder where the user's breaking point is?" asked Field.

### Guessing game for competitors

The discussion on IBM's moves that counter the competition was continued by Marvin Silverman, technical support manager at American Express and president of the OS, Eastern Region Systems Group of SHARE. His was a chronology of peripherals and pricing announce-

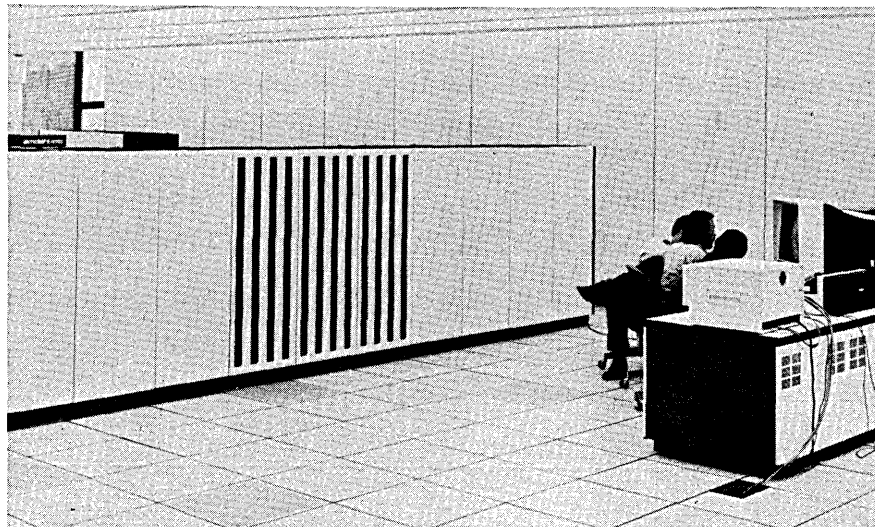

AMDAHL 470/V6: Buyer is especially pleased with Amdahl's on-line diagnosis facility—something IBM offers, "but we never saw."



# Only Perkin-Elmer Terminals give you power front forms insertion.



Take any multi-part business form – bottom glued or unglued – drop it into our front forms insertion device. At the touch of a button, your form will feed automatically. That's it. No alignment problems. No forms separation or tearing. And because it's power-driven, it increases operator throughput.

Carousel . . .  
more than a printer.

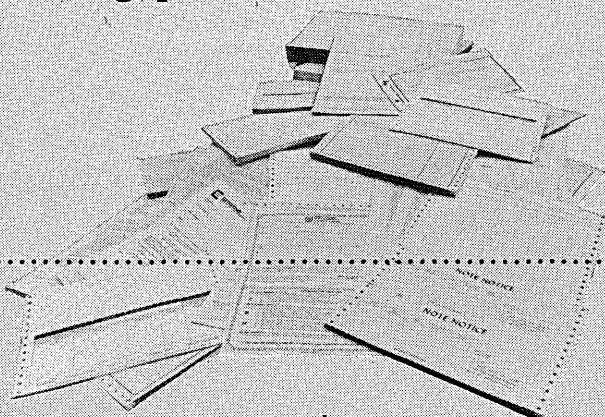

## PERKIN-ELMER | TERMINALS DATA SYSTEMS | DIVISION

Randolph Park West, Route 10 & Emery Avenue  
Randolph, NJ 07801 201 366-5550 TWX 710-987-7913

Overseas, call: 44895-52441 Uxbridge, UK  
887-1000 Sydney, Australia  
416-677-8990 Mississauga, Ontario, Canada

Yes. I want the terminal that can handle my forms.

Name \_\_\_\_\_ Title \_\_\_\_\_

Company \_\_\_\_\_ Phone \_\_\_\_\_

Address \_\_\_\_\_

City \_\_\_\_\_ State \_\_\_\_\_ Zip \_\_\_\_\_

Estimated No. of Units \_\_\_\_\_

Interested in handling:  ledger cards  front forms insertion  
 multipart continuous forms  automatic feeding and stacking  
documents and certificates  independent journaling and forms  
printing  alternate type fonts (Specify) \_\_\_\_\_

# news in perspective

ments IBM has made over the past decade. He landed heavily on IBM's increasing use of microcode and noted that some of IBM's systems software modules, dubbed selectable units, will lend themselves to microcode and, of course, unbundling. Competitors like peripherals makers will be increasingly involved in a guessing game: is the function in the cpu or out?

Minicomputers have been an "emerging" threat for about a decade, but IBM's direct counterattack is recent. The first customer for IBM's Series/1 minicomputer, Citibank in New York, was represented by Michael Cappi, vp of corporate data services. The reasons Citibank is adding Series/1 to its burgeoning coffers of minicomputers were spelled out earlier (December '75, p. 146) but Cappi did note that 35 systems are on order, predominantly for transaction-oriented check processing applications, "which IBM can do better than anyone else." IBM has not given the bank any price breaks, as is its stated policy, nor, said Cappi, is the support extensive, except for field engineering. The bank is developing its own operating system for the mini network.

Citibank ultimately will have 250 minicomputers in its seven operating divisions, including products of Hewlett Packard, Digital Equipment Corp., Data General, and IBM. On a dollar for dollar basis, Cappi did note that DEC's 11/40 is a better buy than the Series/1.

## Citibank reorganization

Cappi described the Citibank reorganization from a "highly efficient centralized operation" to a decentralized one. The bank took a look at its customer and product base and determined, that while many departments had the same products and shared some, there were some distinctly different needs that made continued centralization impractical. They identified 122 distinct dp "channels," but decided to move slowly in decentralizing. For now, it has divided its operations into seven groups, each with their own clump of minis: consumer banking, investment management, international banking, world, national banking, subsidiaries, and an MIS center. In this process, Citibank has trimmed its operations group to 6,000 persons from 10,000, decreased the dp headcount by 63, and cut its dp budget to \$11 million from \$12 million. A center containing two 370/165s and scores of discs, tape drives and printers has been eliminated. While the groups each have autonomous dp departments, Citibank is establishing some networks to transfer common data from one group to another. Also, an MIS center using a 148

does some centralized applications, and a time-sharing center serves the entire bank.

## Competition from Japan

Another IBM competitor, loudly acknowledged by IBM itself, is Japan, or Japan Inc. David Freeman, a Ketrion Inc. consultant who is an adviser to Fujitsu, gave an overview of the Japanese market and of the Japanese as world dp competitors. The future of the IBM look-alikes, Fujitsu and Hitachi, are bright in Japan, he said. Outside Japan there are strong relationships with Hong Kong, Singapore, Philippines, and Australia. And "we must think about mainland China, India, Pakistan." The latter are some years away, but promise strong markets for Japan. Fujitsu itself has already ventured into Europe with its M series; four 190s are installed in Spain.

Freeman showed a chart comparing

## State & Local Government

### Not So Great Expectations

State and local governments, which spend some \$30 billion plus annually for data processing related projects, have become wary of late in predicting success for new programs.

In fact, they almost seem to expect the worst, or at best, a lot of problems before implementation can happen. California's legislative analyst A. Alan Post has said the state has abandoned more computer programs than it has implemented.

In the last decade, the popular press has been full of horror stories of abandoned programs and even of abandoned computers (Aug. 1973, p. 74). In Los Angeles last month there was talk of writing off a \$1.46 million Fire Department computerization project which was to have become functional in December 1973.

But, also in Los Angeles, the Los Angeles county Dept. of Public Social Services is having a different kind of experience. Implementation of a system called Welfare Case Management and Information System or WCMIS (pronounced Wiz-Miss) is proceeding far more smoothly than the department had anticipated. In fact, the department didn't anticipate savings with the system when it submitted a budget for its current fiscal year last summer. Maybe the county board of supervisors did. It cut the department's budget by \$1 million which is just about what the department expects to save thanks to Wiz-Miss.

Robert Best, director of the county's data processing department, said Wiz-

the M series operating systems to IBM systems—something that may be of increasing interest as Fujitsu spreads abroad. The M series OSIV/F4 is comparable to OS/VS2 Release 3 in functions, device support and compilers, sorts, and utilities, according to Freeman. Potentially it is "superior to MVS" in channel throughput due to a Channel Dynamic Address Translator, and in overall implementation. It has "unknown reliability and unknown levels of field support."

The OSIV/F2 is comparable to DOS/VS in functions, device support, and other features. OSIV/x8 is comparable to DOS/VS, plus it provided emulation of earlier Fujitsu equipment and other transition aids. There are no announced counterparts to IBM's OS/VS 1 or VM/370.

Minis, big computers, Japan. As ever, the competition is nipping the giant around the ankles. The audience didn't see IBM falling on its back, quoting Forbes Magazine prognostications of \$40 billion in revenues for the firm sometime in the '80s.

—A.P.

Miss is a three phase project. The first phase, which is the part that will save DPSS some \$1 million this year, was developed by Best's staff over an 18 month period with some outside help from Computer Sciences Corp.

## State and federal help

The project was funded by the county with contributions from state and federal government. Best said total cost of the program, including all hardware, design and development and communications will be \$3,059,000.

As part of phase 1, all files on both open and closed welfare cases were put on disc. These previously were stored in large Rolladex and tub files in the department's main office. There are some 2 million cases on file.

Univac Uniscope terminals are being installed in 65 district offices and four hospitals. In two offices, Covina and Belvedere, and in the hospitals, they're already operational. Best said communications lines are in place and the network has been tested. On March 1, he said, at least one terminal in every office will be turned on and sometime in May, all 150 terminals will go on-line. "It's just a question of training the people in the field."

With this first phase of Wiz-Miss, eligibility workers will be able to prepare a welfare applicant's financial needs for computer processing directly. Under the old method, a clerk would take information from an eligibility worker and would prepare it for another clerk who

# Only Perkin-Elmer gives you two terminals for the price of one.

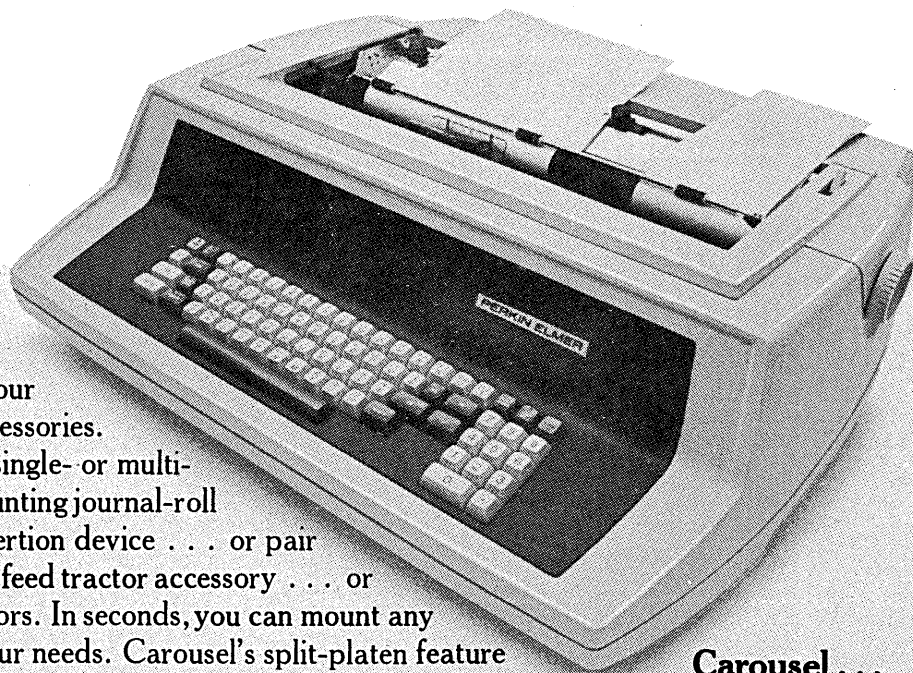

Mix or match any two of our unique forms handling accessories. Combine journaling with single- or multi-part forms printing by mounting journal-roll holder and front forms-insertion device . . . or pair front-insertion with a pin-feed tractor accessory . . . or snap on two pin-feed tractors. In seconds, you can mount any combination that meets your needs. Carousel's split-platen feature then lets you feed, advance, tabulate, and print each form, sheet, or tape independently, under operator or computer control.

**Carousel . . .  
more than a printer**

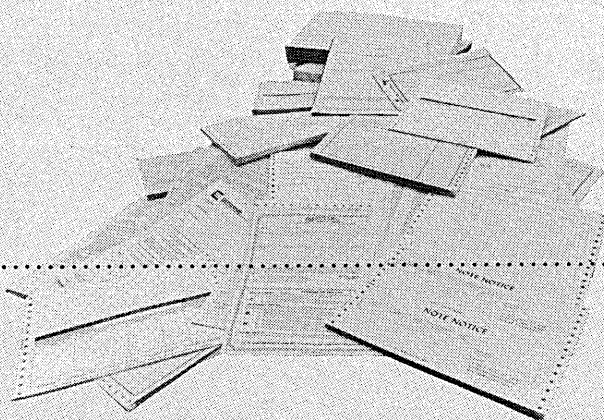

## PERKIN-ELMER | TERMINALS DATA SYSTEMS | DIVISION

Randolph Park West, Route 10 & Emery Avenue  
Randolph, NJ 07801 201 366-5550 TWX 710-987-7913  
Overseas, call: 44895-52441 Uxbridge, UK  
887-1000 Sydney, Australia  
416-677-8990 Mississauga, Ontario, Canada

Yes. I want the terminal that can handle my forms.

Name \_\_\_\_\_ Title \_\_\_\_\_

Company \_\_\_\_\_ Phone \_\_\_\_\_

Address \_\_\_\_\_

City \_\_\_\_\_ State \_\_\_\_\_ Zip \_\_\_\_\_

Estimated No. of Units \_\_\_\_\_

Interested in handling:  ledger cards  front forms insertion  
 multipart continuous forms  automatic feeding and stacking  
documents and certificates  independent journaling and forms  
printing  alternate type fonts (Specify) \_\_\_\_\_

# NETWORK NEWS BULLETIN

- o POLLING
- o USER-DEFINABLE "SOFT KEYS"
- o MULTI-PAGE DISPLAY MEMORY
- o SELF-TEST KEY
- o FORMS DRAWING MODE
- o ALPHA/NUMERIC FIELD CHECK
- o DUAL CARTRIDGE TAPE STORAGE
- o FULL EDITING



2645A TERMINAL

HEWLETT • PACKARD





**The HP2645A Display Station** is welcome news for your information network. For a very reasonable price, it provides the speed and versatility you need for network data entry.

The polling capability will help you reduce network cost by sharing communication lines, modems, and computer I/O channels. You can daisy-chain as many as 32 of these display stations throughout your head office, factory, or sales offices, speeding information to and from your computer at up to 9600 baud.

The eight "soft keys" let you personalize the HP2645A to specific job functions. For instance, you could assign one key to generate a computer log-on sequence and another to call up an order entry form. These "soft keys" are simple to program with each of them capable of storing up to 80 characters.

Even when the computer or data lines are unavailable, the extensive off-line data storage allows you to keep on inputting data. Each of two tape cartridges will store up to 110,000 characters of data, forms, and programs. These optional dual-tape units are integrated right in the terminal itself and can be specified initially or added at any time you desire.

The line drawing set is another useful option that lets you generate and store basic business forms so that you have only to call up the one you need and simply type in your new data.

This kind of convenience extends to the many editing features such as the character or line insert/delete. Accuracy is enhanced by the alpha/numeric field check, which signals with a tone if you have improperly entered an alpha in a pre-assigned numeric field or vice versa.

Another time saver is the self-test key. Press it and you will receive a tone indicating that the terminal is ready to operate. If a fault should exist, the 2645A helps you determine if the problem is in the terminal, communication line, modem, or computer by displaying a coded sequence.

The HP2645A has several other features worth considering when you're choosing a terminal. They include the easy-on-the-eye high-resolution display; plug-in modularity to ease and speed maintenance; and the inherent flexibility of the 2645A in interfacing with your network.

To experience the benefits and features of our new Display Station, give your nearest HP sales office a call. Or write us for more information.

**HEWLETT  PACKARD**

1507 Page Mill Road, Palo Alto, California 94304

For assistance call: Washington (301) 948-6370. Chicago (312) 255-9800. Atlanta (404) 434-4000. Los Angeles (213) 877-1282

CIRCLE 35 ON READER CARD

42701HPT1

# news in perspective

would make a manual check of the card index of welfare cases in the district office then would telephone to the central office to be sure the applicant didn't have a previous record. In some cases this process is computer assisted with overnight service. With the new system the check is made in seconds.

## Response average

The responses at the Covina office have been averaging seven seconds.

At the county hospitals, which are

under the jurisdiction of DPSS, the terminals are used to check for previous medical services and to determine a patient's eligibility for Medicare or Medicaid assistance which means the hospitals get paid a lot faster than they were before.

DPSS says the system will eliminate the need for 500 clerical jobs this year and a total of about 900 when it is fully operational in two or three years. Best has predicted on-going savings of \$6.7 million a year over a nine year period once the system is fully operational.

## How we got a 136-column portable into our 80-column portable.\*

\*Optional APL Code.

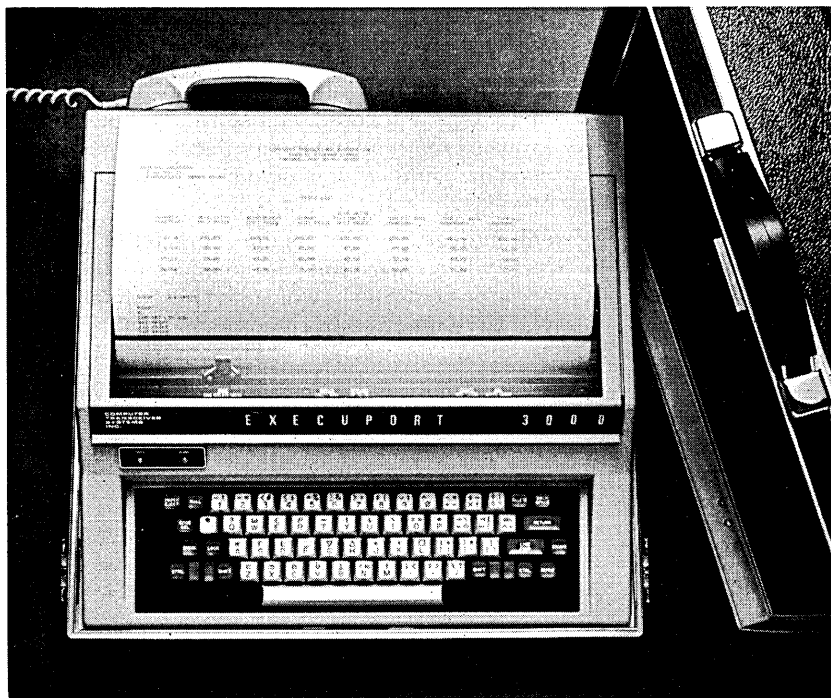

Our new 136-column 3000 portable terminal has the same outside dimensions as our 80-column 300 portable. How did we do it? By completely redesigning its interior.

Result? A terminal with everything: compactness, reliability, two switchable codes, (APL/ASCII), complete plotting capabilities, 14-line spacing in both directions, and, of course, adjustable up to 136-column width.

Equally remarkable, it prints 30 cps, operates over regular telephone lines (with its own acoustic coupler), accepts 80- or 136-column paper rolls, and has a printer with lots of visibility (thanks to a complete facelift).

Our new 3000. Everything you wanted in an 80-column portable. Now in a 136-column portable. Complete with its own self-contained carrying case.

Now we can offer you a choice between our durable 80-column portable with APL/ASCII codes, or our new wider carriage 3000 portable. Take your pick.

Call Charles Kaplan or Shirley Newman at (201) 261-6800 for the complete story. Computer Transceiver Systems, Inc., East 66 Midland Avenue, Paramus, NJ 07652. Tony Swanson, 10471 Oakhaven Drive, Stanton, CA. 90680 (714) 827-0281. Service from 190 locations.



Distributor inquiries welcomed

Phase 2 of Wiz-Miss, still under development, would provide for automatic calculation of benefits and would enroll applicants in the welfare program just as quickly as the need arises, Best said. This phase also would involve conversion of the current welfare system from Honeywell equipment providing batch service to the department's on-line system based on a Univac 1140 2 x 2.

Phase 3 will involve conversion of the final details of DPSS work such as issuance of food stamp authorizations, general relief checks and welfare warrants.

Best said that subject to state and federal approval, he expects Wiz-Miss to be made available to other jurisdictions when it is complete.

And, while Los Angeles county officials were congratulating themselves on the success to-date of Wiz-Miss, over at Los Angeles city hall, city officials were debating what to do about the fire department system that still doesn't work. Under consideration were termination of a \$1.46 million contract with General Research Corp. and possible litigation against the Santa Barbara, Calif., firm. The city signed the contract with GRC in 1969 to design, install and manage what would have been the most sophisticated fire dispatching system in the country. In addition to the \$1.46 million paid GRC, the city spent some \$2.78 million for equipment and installation.

—Edith Myers

## Social Concerns

### Reminiscences and Predictions

The 10th anniversary of Dartmouth College's Kiewit Center—symbol (and workshop) of Dartmouth's pioneering role in the introduction of computing in the educational process—was celebrated by a stimulating symposium on "Man and the Computer" last month.

The two-day discussion was led off by Dartmouth president, Dr. John O. Kemeny, educator and computer pioneer responsible for the college's leadership in this field. Kemeny reminisced about his prognostication ten years ago that "within 25 years computer terminals would be as common in the home as television sets were in 1966 . . . The date 1990 still looks like a good target date."

Commenting on the technology required to bring this widespread use about, Kemeny noted the persisting lack of a cheap general purpose terminal and the potential of the minicomputer in the short run to lead us "in the wrong direction." While valuable in introducing more people to computing, the use of the minicomputer "cuts you off from one of the major benefits that com-

# PERFORM

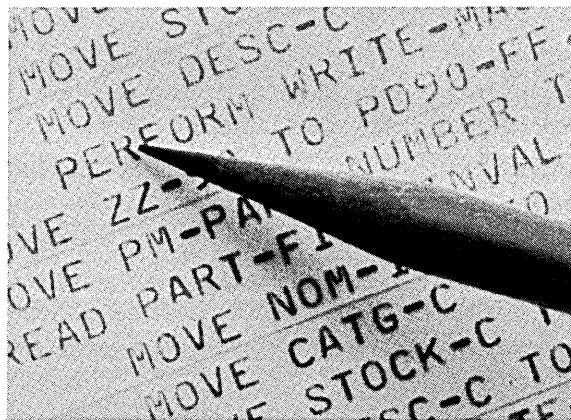

## COBOL with ISAM

If you've got the business application, Interdata's got the COBOL. Right now. In stock. Field proven.

We've packaged our ANSI X3.23—1974 COBOL/32 with ISAM—an enhanced file management system which works with COBOL for a wide range of commercial data base applications.

The rich array of ISAM (Indexed Sequential Access Method) utilities provide for the allocation and dedication of up to 32 contiguous files on each of 32 different disc volumes. COBOL acts as the data description and manipulation language. And maximizes transportability while providing interprogram communication with FORTRAN, CAL assembler and other COBOL programs.

Interdata COBOL/32 with ISAM has been working for more than a year at a variety of sites. Such as one of the largest banks in the U.S. A major retail chain. A large hospital group.

For your business application needs, run our COBOL/32 with ISAM. Write or call for documentation...or immediate delivery.

 **INTERDATA®**

A UNIT OF

**PERKIN-ELMER DATA SYSTEMS**

Oceanport, N.J. 07757 (201) 229-4040.

# BEFORE YOU BUY OR LEASE AN ADD-ON MEMORY, FIND OUT WHO STANDS BEHIND IT.

When you buy or lease an add-on memory, you're also buying or leasing the company that delivers and installs it, services it, updates it, and stands behind it if the darn thing breaks down.

If you don't look past price and specifications in making your selection, you're looking for trouble. With that in mind, we want to tell you about the company that stands behind EMM add-on memories. It should make an attractive product look even better.

We are now the top independent add-on memory house in the world. And we're undergoing a major expansion of staff and facilities to make us even more responsive to the needs of the market.

As a vertically integrated company, we control every step in the manufacturing of our memories, from chips and subassemblies through the finished product. This enables us to keep a tight control on quality and reliability. It also prevents us from passing the buck.

We have the largest selection of memories anywhere: from core you thought you'd never see again through semiconductor memory for this week's variation on the 370.

Behind every EMM add-on memory stands a financially sound company, firmly committed to the add-on memory business. We'll be there with the products and services you need. Today. Tomorrow. 1986.

Maybe that's why EMM has the highest percentage of repeat business of any add-on memory supplier.

We stand behind our product.

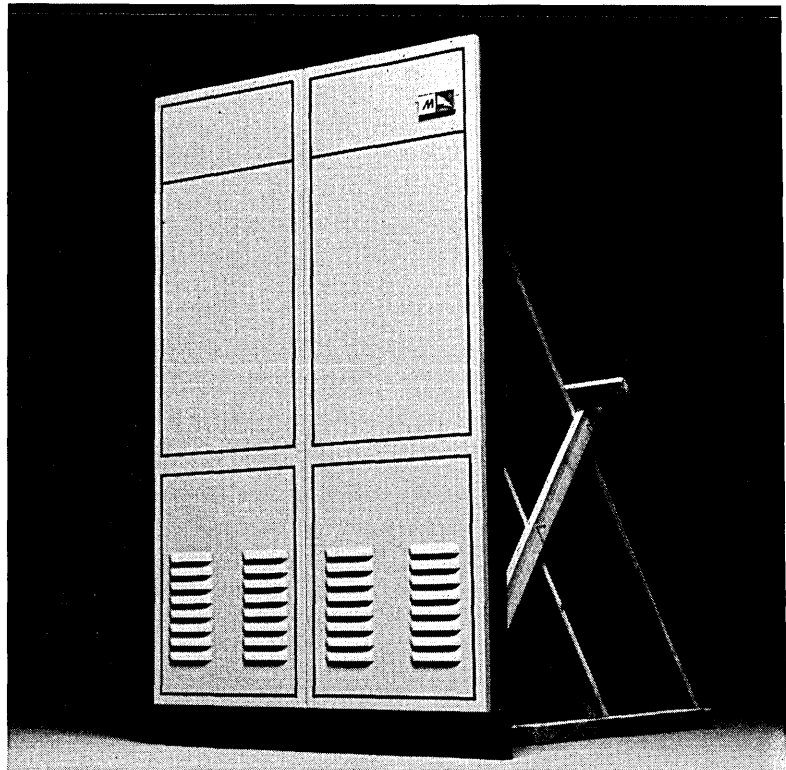

**EMM** SYSTEMS EQUIPMENT DIVISION  
Electronic Memories & Magnetics Corporation  
3216 West El Segundo Boulevard, Hawthorne, CA 90250

## WE'RE COMMITTED TO MEMORY.



# news in perspective

puters ought to be bringing to mankind, namely the ability to share common data bases and more importantly, to share common techniques." (This knowledge-sharing goal is at the heart of one of Kemeny's dreams—a National Automated Reference Library—which, after 20 years, is still a long way from fruition, he said.)

Kemeny listed further problems as roadblocks to achieving "a symbiotic relationship" between man and machine. Language development is one such problem. Decrying current languages as either too specialized or "horribly general," he advocated "a do-it-yourself" language, a language which "would grow as our concepts grow." Too, if the language is to facilitate man-machine interaction, it must permit the "kind of tolerance for errors and ambiguity" that exists in speaking. Unless the terminal is given this kind of tolerance, "we're not going to see tens of millions of people using computers . . . I'm convinced that we still need some major breakthroughs in the development of language."

## Asking too much

Kemeny also raised questions about

the memories that such large networks will require and the perfection that is being asked of computers and data bases. Memories storing billions of pieces of information will come, but "will we know how to use them?" Isn't "too much being asked of the algorithms" for storage and retrieval. Further, the perfection in computer security being asked is greater than would otherwise be expected. "The search for fool-proof or perfect algorithms must have limitations in the very nature of the demand."

In addition to the technological problems, society must do more and more to "realize the role of human beings" in facing the man-machine partnership. So far, many educational institutions are failing in their part in this, "making it impossible for students to have easy access to the computer." That was "okay in 1966, not in 1976," criticized Kemeny. No student should leave college "without being comfortable with computers."

The problems of the widespread use of computers in areas like electronic funds transfer, privacy, and politics were examined by other speakers. Rand's Willis Ware, now serving on the

government's Privacy Protection Study Commission, warned that "technology is tightening the processes of society and unless record-keeping systems supporting such tight systems are accurate, the individual will be harmed . . . We need technically trained people in public policy matters."

The responsibility of computer sciences in major social issues was a theme taken up by Dr. Frank Ryan, director of information systems of the U.S. House of Representatives, in his talk on computer impact on the political method.

"Can computing through its highly entrepreneurial and evolutionary character force unforeseen bias upon the political processes that come to rely upon it? Can computing through its functional strength undermine the self-controls envisioned by the founding fathers?" Most definitely computing can provide benefits, but it can also warp the political method, asserted Ryan. It has already brought mixed blessings in application to the electoral process, in the system of checks and balances, in the workings of Congress.

## To help politicians

In a landmark, eloquent speech, Ryan called for an entity at a "high political level" to examine the impact of computing and other technologies and determine "how the grand design of the

# Resolve™ stops IPLs and downtime dead in their tracks.

One of the reasons they made you a manager was your ability to know when the system was slowing down, operating inefficiently, or on the verge of crashing.

Now there's a diagnostic product that gives more warning than you get from the pit of your stomach.

It's RESOLVE.

RESOLVE is a real time, on-line problem solver that flags (and shows you how to reduce) enqueue conflicts, reserve lockouts, paging thrashing, job looping, in wait states, and jobs hung up in the system.

RESOLVE provides more than 40 operator and authorized TSO user commands. Each one addresses a system problem that can cause lost time or IPLs.

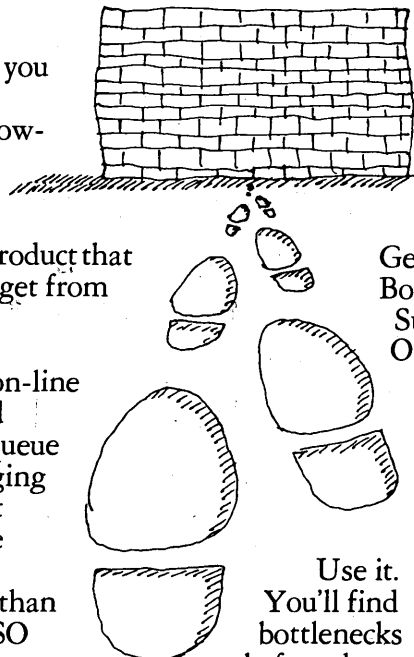

Use it.  
You'll find  
bottlenecks  
before they  
stop the clock. And you'll  
also pick up system

productivity.

More work through the machine. Fewer IPLs. Better management. It all comes from RESOLVE.

Information about RESOLVE is available in writing or over the phone.

Get one or the other when you contact us. Boole & Babbage Inc., 850 Stewart Drive, Sunnyvale, CA 94086; (408) 735-9550. Outside California dial toll free 800-538-1872.

**Boole & Babbage**

Dear George: Sure, I'm a manager, and it looks like RESOLVE will help me manage in real time, on-line. Better get the whole story to

me before the boss finds a clairvoyant for my job.

Name \_\_\_\_\_ Title \_\_\_\_\_

Company \_\_\_\_\_

Street \_\_\_\_\_

City \_\_\_\_\_ State \_\_\_\_\_ Zip \_\_\_\_\_

Phone \_\_\_\_\_ My System: \_\_\_\_\_

Information Only  Send me the package for a free 21-day trial. If I like it, I'll buy it.

I'm an MVS user, send me information on RESOLVE-MVS.

# news in perspective

founding fathers should be modified in the reality of the present day—to keep, to preserve the things thought to be good about government.” Computer sciences could obviously help politicians in this monumental task.

Putting this in practical terms, Ryan emphasized that “we need to create a conception of that reality in terms of a model or schema—an environmental model. We might identify a very important class of those models, called closed models.” Whenever a component was transformed or perturbed, as through the use of computing, “the model would remain invariant.” EFTS needs such an environmental model, he said, and “there is none in the political method, at least not at the federal level.”

How are computers warping the intentions of the founding fathers? Ryan gave example after example. Through the electoral process, the drafters of our governmental framework “hoped that special interest and individual influence could be subjugated to the common good.” An informed electorate, rather than merely a convinced one, is vital to this aim. Yet, says Ryan, when one views the uses to which the computer was put in the last campaign—from

mailing lists to opinion analysis—“it added to the ability to convince, but very little had been done to create an informed electorate.”

In this connection, computers have made possible the identification of representative subsets of the population, and campaign mail tends to go only to these special groups. “That is not the way the grand scheme of our constitutional framework was supposed to work,” Ryan said.

Another intent of our forefathers was that “no qualification of wealth on the part of the candidate should be permitted to fetter the judgment of the people.” This is not a computer question per se, yet their use has contributed to the problem. President-elect Carter alone spent \$750,000 on data processing. (Ryan quipped that computers are being used by candidates effectively against one another, evidenced in the last campaign: “Carter used time-sharing and remote batch. Ford used batch.”)

## Checks and balances

Computing has also shown its potential effects on the system of checks and balances, said Ryan. For example, the

Joint Committee on Internal Revenues Taxation has been using an income tax model to project effects of possible changes. However, the model is run on a system in the Department of Treasury, and initially the committee’s requests went through programmers there. Hence, the executive branch was aware of what the legislators were examining. This was finally changed, with the committee being given direct access to the model via terminal, eliminating the Treasury programmers. But the model used is still on Treasury computers. “Is this the check and balance that was thought of by James Madison? I claim it is not. It is the leap forward to easy use of computers that is bringing about the compromise in political method . . .”

Ryan told the audience that “I am going to help put in a network to all the members offices in the House and Senate.” Congressmen will ultimately have many tools available to them—access to as many data bases as possible, the ability to write their own programs. “This could be an outstanding modern day event. But unfortunately, we can’t say whether this is going to create disastrous political consequences somewhere down the line that we can’t foresee now . . .” One problem is “whether because of the economics we in effect are narrowing their information resource rather than broadening it. It might be easier to use the computer and get partial information than to go out and try to do it right.”

The role of computing in helping society accurately and intelligently determine its social and political direction, in providing technology to further the sharing of knowledge, and in helping protect the individual—these were among the high orders of the discussion. But there are also laws developing that will affect the use and ownership of data of all kinds. One such law is the new Copyright Act, P.L. 94-533, which goes into effect Jan. 1, 1978. Lawyer and writer Robert Bigelow examined some of the implications of that law for computing.

What seems clear is that machine readable data bases and object programs are copyrightable under the new law, said Bigelow. As such, they are protected for the author’s life, plus 50 years, an extension to the 28 years (renewable once) provided before. But the exclusive rights and the rules of infringement concerning works used in conjunction with automated systems are not provided for by this new law. They continue to be covered by law developed under the old 1909 act. So far that law has developed very little for lack of legal cases and decisions that would define it.

## Final recommendations

However, this August the National Commission on New Technological



“How much information can it store, say, on the head of a pin?”

©DATAMATION®

Uses of Copyrighted Works (CONTU) is to make final legislative recommendations on "the reproduction and use of copyrighted works of authorship in conjunction with automatic systems capable of storing, processing, retrieving, and transferring information." CONTU also will consider the problem of copyright registration requirements under the new law as they apply to continuously updated data bases. Copyrighted works must be "deposited" within three months, leading to the question: "Do you run a printout every hour?"

Bigelow also noted that the federal law has left certain aspects to state law to enforce many related computer data issues, such as breach of a data base owner's security arrangements and access to his data; data access by intentional interception of transmission; and unauthorized printouts from a crt display.

While erudition and information flowed from the podium during this symposium, perhaps equally stimulating exchange went on in the halls and after hours. Willis Ware, Frank Ryan, and George Glaser, who spoke on EFTS, seemed to be concocting some cooperative project. Practitioner and press carried forward the debate in private, trading ideas and criticism on the responsibility of each. Ryan, a former Cleveland Browns quarterback, and Kemeny carried on their own battle—on the computer football field, with plays being called from a terminal in Kemeny's office.

Very much in the stream of all conversation was the ideal that there should be more such forums for public policy debate. Dartmouth College in Hanover, N.H. is an excellent environment for it.

—Angeline Pantages

CII-HB territory (49 countries, but excluding among others North America, the U.K., Japan, Italy and Australia) include five Level 64 models against only two in HIS markets—the Level 64/20 and 64/40. Models announced by CII-HB are the 64/20, 64/30, 64/40, 64/50 and 64/60, the latter being at the top of the line as a 370/138 equivalent. The Level 64 line is developed and manufactured exclusively in France.

As for the HIS-made Level 66 line, the story is different. In the CII-HB sales territory, the 66/10, 66/20, 66/40, 66/60 and 66/80 were in the catalogs only when this was written. One large user with multiple Level 66 installations in France apparently was not aware that the 66/10 had been launched in continental Europe. The Level 6 minicomputer still had not been offered in CII-HB territory, though observers felt it would come soon.

The French company has hinted broadly that there still is a lot more to come from the Level 64. It has issued an apparently French-oriented announcement about an interim line for the Series 60 due in or around 1980. At the same time there will be a Y4/Y5 line for users of the CII Iris 80.

Both these lines will be a half way state in the "Unisys project," designed to unify all of the HIS and CII-HB lines by "1982-1985," the company says (see sidebar, p. 165).

### International

## CII-HB Offerings Overlap As Level 66's Join Level 64's

Honeywell Information Systems and its transatlantic partner, CII-Honeywell Bull, are keeping their users guessing—and probably their salesmen too. The product strategy followed by CII-HB

since its legal birth last July 1 has shown break after break with the established HIS line, instead of the promised convergence.

The systems currently available in

# CUE/DSO, a better roadmap to improved system performance.

There are a lot of ways to get around in your system. And, there are a lot of roadblocks along the way that slow performance.

CUE/DSO (Configuration Usage Evaluator/Data Set Optimizer) is like an overgrown roadmap that lets you see how your system and its resources are performing. It isolates hardware and software bottlenecks so you can quickly and easily improve system throughput.

CUE/DSO measures and plots CPU, channels, devices, SVCs, queues, head movements, VS paging and lots more. It gives you specific information on disk volumes, data set organizations and head movements between data sets.

With all this information it's

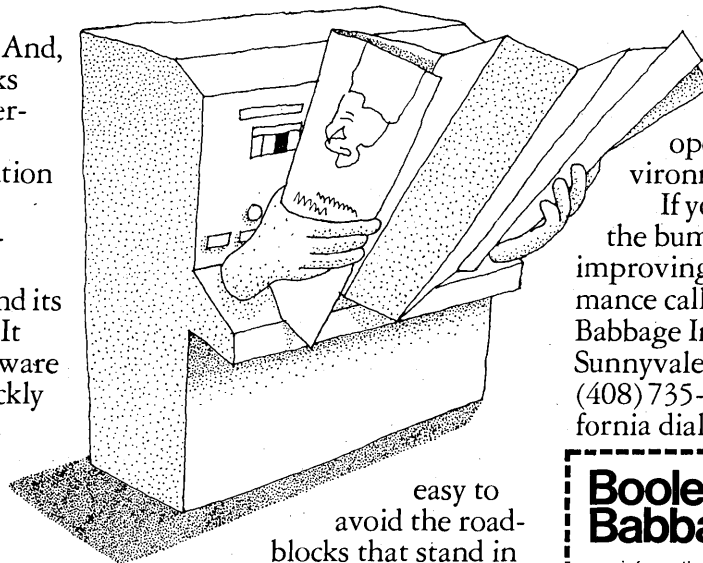

easy to avoid the roadblocks that stand in the way of increasing your system's performance. It also helps you establish a solid base of utilization so you can accurately project when you'll need new equipment and gives you the

documentation you need to justify the expense.

And, CUE/DSO operates in the OS/VS environment.

If you want to avoid some of the bumps along the road to improving your system's performance call or write Boole & Babbage Inc., 850 Stewart Drive, Sunnyvale, California 94086, (408) 735-9550. Outside California dial toll free 800-538-1872.

**Boole & Babbage**

I drive my system at a pretty high speed and need to know how to get improved performance faster. Send me information on the CUE/DSO roadmap.

Name \_\_\_\_\_ Title \_\_\_\_\_  
 Company \_\_\_\_\_  
 Street \_\_\_\_\_  
 City \_\_\_\_\_ State \_\_\_\_\_ Zip \_\_\_\_\_  
 Phone \_\_\_\_\_ Operating System \_\_\_\_\_

# Now, Intel rents memory for IBM 370/125.

Save up to 50% on additional memory for your IBM 370/125. You can do it now with a call to your Intel representative. We're now delivering add-on memory for the 370/125. And we give you three money-saving choices: 30 day rental, long term leases or outright purchase.

Until now you had only one choice: IBM. Our Model 7125 meets or exceeds all their specifications, with equal access and cycle times. Just plug it in. It's totally compatible with all your hardware and software. So why pay more?

Our exclusive 16K bit memory chip provides system expansion up to one megabyte in a small desk high unit. Active spare memory enables you to substitute failing memory in 32K byte increments. Maintenance features include comprehensive error checking and correction logic, automatic memory address relocation and a fault location system that enables chip replacement.

Intel is the established leader and largest

manufacturer of semiconductor memory. Our add-on memory systems for the 370/125, 370/135, 370/145, 370/158, 370/168 and, soon, 370/115, 370/138 and 370/148, enables you to add more memory, in less space and at lower cost. Start saving now. Replace your IBM memory with Intel memory. Remember us when you need to add even more.

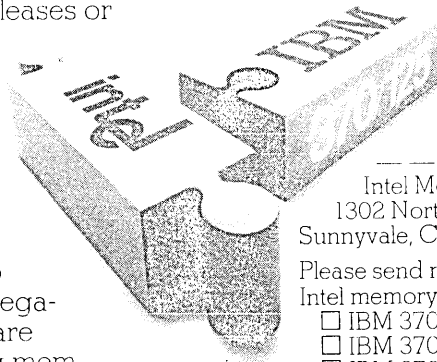

Intel Memory Systems  
1302 North Mathilda Avenue  
Sunnyvale, California 94086

Please send me more information on the following Intel memory systems:

- |                                      |  |
|--------------------------------------|--|
| <input type="checkbox"/> IBM 370/125 | <input type="checkbox"/> IBM 370/135   |
| <input type="checkbox"/> IBM 370/145 | <input type="checkbox"/> IBM 370/158   |
| <input type="checkbox"/> IBM 370/168 | <input type="checkbox"/> IBM 370/_____ |

Name/Title \_\_\_\_\_  
Company \_\_\_\_\_ Mail Station \_\_\_\_\_  
Address \_\_\_\_\_ Phone \_\_\_\_\_  
City/State/Zip \_\_\_\_\_

intel memory systems

Headquarters: California 408 734 8100 Ext. 453 • Sales Office: California 415 692 4762 213 640 0584 • Georgia 404 451 0486 • Illinois 312 649 0050 • Massachusetts 617 237 4673  
Michigan 313 328 1640 • Minnesota 612 835 6702 • New York 212 736 0316 • Ohio 216 836 0457 • Pennsylvania 610 428 8825 • Texas 714 771 5781 • Virginia 703 790 1191  
In Europe contact: Telex International Group In Japan contact: Kanematsu Goshu Ltd

# news in perspective

## Overlap with the 66

But it is widely expected that the smaller Level 66 machines shortly will be let loose on the CII-HB market, thus producing a product line overlap, which is not easy to explain, even if it might be proof of an independence from the French company which few expected.

The overlap is moreover difficult to quantify. The Level 64 now has a top memory size of 768K (for the 64/60 which starts at 192K). The 64/30 reaches up to 384K, the 50 to 512K. The line was developed specifically, says the company, to have a high emulation performance and it seems that most so far sold are operating in emulation mode.

There's an historical explanation for the overlap between the two lines. The Level 64 was intended to take over from the Olivetti-GE 100 and the GE-Bull 200/2000 series. The 66 on the other hand is meant to take over from the GE 600 and 6000 systems. The idea is to provide an overlap to offer both sets of users an uninterrupted growth path.

One reason for the lower Level 66 is that both systems are designed also for new users. Another explanation also is

said officially to lie in the application differences of the two lines. Designed for different types of operation, they

have basic differences in data structure. The 64 is designed for emulation and batch, and the 66 for real-time, large



HONEYWELL large-scale Level 66 model, with memory range of 1 million to 4 million bytes, now is offered in Europe and other CII-HB territories along with Level 64 lines. This suggests an overlap with the Level 64 offerings in that territory.

## TSA/PPE, a dramatic leap forward in system and program management.

Every DP manager wants to get that last 20% improvement out of his systems and programs. The problem is the high cost of getting that optimization.

TSA/PPE (Total System Analyzer/Problem Program Evaluator) gives you the help you need. It does all of the hard work so you can concentrate on areas that will give you the the greatest return in CPU usage.

TSA/PPE samples all system and program modules, extracts pertinent data and produces summary reports to help you locate high activity areas.

You also get a management report of all module usage and a plot of each module's usage over time. Then it will pinpoint high

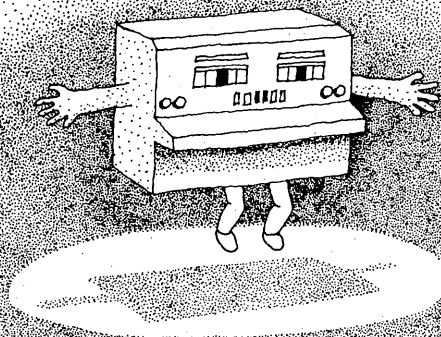

activity and wait problem areas back to specific addresses in your programs.

With all that information, improving system performance is a snap.

With TSA/PPE you'll be able to add new applications, improve throughput, and cut turnaround time with the same equipment.

And, TSA/PPE operates in the OS/VS environment.

If you'd like to squeeze that last ounce of performance out of your system, find out more about TSA/PPE. Contact Boole & Babbage Inc., 850 Stewart Drive, Sunnyvale, CA 94086; (408) 735-9550. Outside California dial toll free 800-538-1872.

**Boole & Babbage**

I think I could improve my system performance at least 20%. Send me more information on TSA/PPE so I can do it the easy way.

Name \_\_\_\_\_ Title \_\_\_\_\_

Company \_\_\_\_\_

Street \_\_\_\_\_

City \_\_\_\_\_ State \_\_\_\_\_ Zip \_\_\_\_\_

Phone \_\_\_\_\_ Operating System \_\_\_\_\_

A world free from early heart attack  
and stroke.

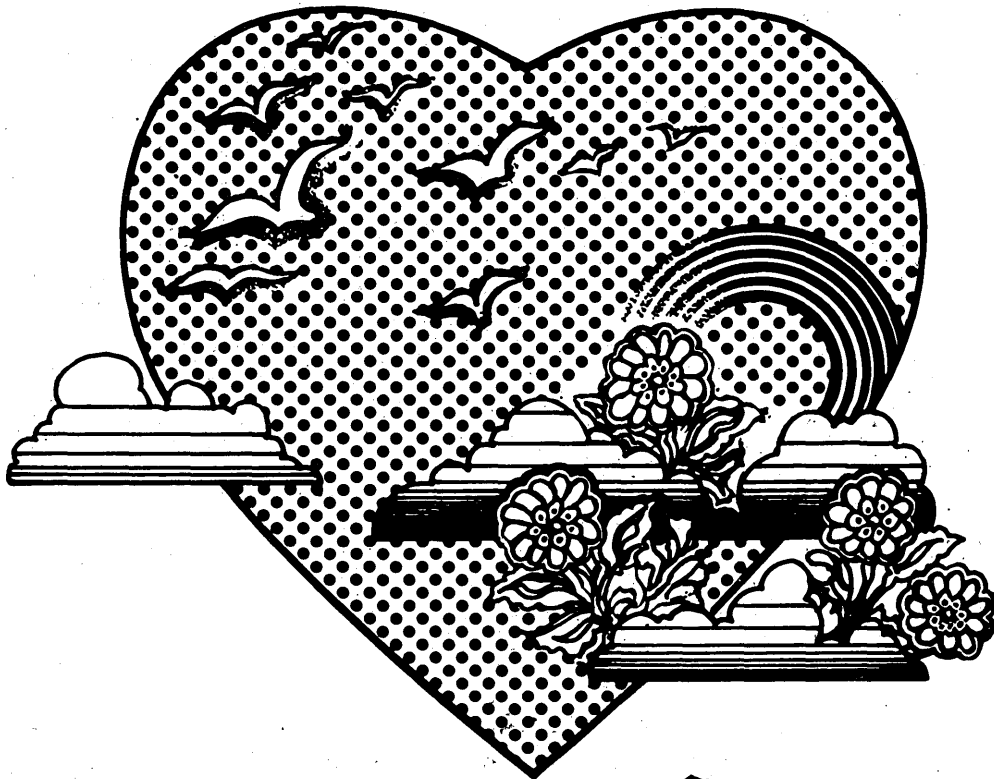

That's what we're all about.

**Ask your  
Heart Association**



**Give Heart Fund**  
American Heart Association

## news in perspective

telecommunication networks and number crunching.

But the L64/60 offers up to 42 communications lines with three controllers—a lot for a batch machine. It allows, incidentally, up to 2.4 billion bytes of on-line disc storage and is reckoned to be equivalent in price to the 370/138.

### Political answer

The other consideration, political rather than marketing, is over an issue which CII-HB currently is keen to play down—but which evidently is not yet dead. The French government, as part of the terms of the deal with Honeywell Information Systems, dearly wishes that the Level 66 system be made in France because the public sector will be buying it. So far, Level 66's have been made only in Phoenix, Ariz., and Newhouse, Scotland. Naturally, the Scottish trade unionists and others have proved a little sensitive on the possibility—as the rational implication would be the shutting down of the 66 line at the already depleted Newhouse plant, particularly with few British public sector orders forthcoming.

## Unisys—A Final Convergence of Honeywell Systems by '82

“Project Unisys”—which has nothing whatever to do with Univac—is a program announced in Paris in September by the newly-formed CII-Honeywell Bull.

According to the company, it is a “global program of convergence” whereby the CII-HB cataloged products will merge into a single unified line of computers, “conceived in association with its American partner, Honeywell Information Systems.” This is due by “1982-85.”

The announcement seems to have been intended for the French audience. But one or two points, depending on the corporate weight put behind them, could have an impact elsewhere.

French computer people, and others fond of CII, were glad to hear that the CII heritage, the X4 and X5 machines originally being developed for Unidata, would see the light of day—at least in some form. The new machines are due

for release around 1980, and will be called the Y4 and Y5. The wherefore of the Y4 is that the machine will serve as an intermediate step to CII Iris 80 users between their current system and the 1982-85 offering.

There also is to be a sort of Series 60 Mark II—another intermediate step—if the announcement literature is not misleading. These machines will incorporate certain CII-developed processor components. Both the Y range and the updated Series 60 will share Series 60 type peripherals.

The announcement also was greeted with a measure of warmth by the hitherto hostile CII Iris users. These nevertheless were reserving a final verdict until they had all the technical details of the new systems. At the time of the announcement, the company also said it soon would be launching further upward extensions of all levels of the Series 60. \*

Manufacture of bigger and bigger 64's in France may be the way around an internationally sensitive issue, one which apparently is still undecided. But CII-HB says that the Level 64 is not indefinitely expandable, and there will

always be a need for “something different” at the top of the range. For a moment, though, there was a question of whether Honeywell were going to have a single range.

—Andrew Lloyd

# Talk to us about Data Communications



That's right, Anderson Jacobson. We started with the industry's first accepted acoustic coupler and we've been expanding ever since. If you want the very best data communications equipment—couplers, modems, modem systems, cassette recorders, and an unmatched selection of keyboard printer terminals . . . then talk to us.

A phone call or letter to our marketing department will get you “on-line” with the best peripheral equipment for your computer system.



**ANDERSON  
JACOBSON**

521 Charcot Avenue · San Jose, CA 95131 · (408) 263-8520  
Paris, France · London, England · Ottawa, Ontario

## News in Perspective

# BENCHMARKS

### Computer Automation Strikes Back:

Computer Automation Inc., sued in 1975 by Datapoint Corp. which charged misappropriation of trade secrets (Oct. 1975 p. 137), filed suit in Los Angeles Federal District Court against the San Antonio firm along with TRW, Inc., and TRW Datacom International charging conspiracy and monopoly in violation of federal antitrust laws. TRW Datacom distributes Datapoint products in international markets. The Computer Automation suit asks for treble damages and an injunction against further prosecution of the Datapoint action. The suit alleges that the defendants agreed to eliminate Computer Automation's SyFA computer system as a competitor in South Africa by conspiring to force SyFA's distributor, Computer Advances of South Africa, into not carrying or promoting the SyFA system, by refusing to send new Datapoint technology or products to Computer Advances which also is a distributor for Datapoint.

The suit also charges that Datapoint acted in bad faith when it brought the trade secrets suit against Computer Automation; that the suit was brought to encourage distributor boycott and to discourage competition by Computer Automation.

### Microcomputer Move:

Pertec Computer Corp., Los Angeles moved to strengthen its position in the microcomputer systems market by issuing a letter of intent to acquire MITS, Inc., Albuquerque, best known for their Altair computers and computer kits for hobbyists. Ryal R. Poppa, Pertec president and chief executive officer said of the microcomputer systems market, "we believe this market will experience dramatic growth over the next several years." He said MITS also will provide an outlet for current and planned products manufactured by PCC's Pertec Div. PCC designs, manufactures, markets, and services digital magnetic tape transports, disc drives, flexible disc drives, microperipherals and microcomputer subsystems, and data entry and communications products.

### Terminal Sale:

Harris Corp., Cleveland has reached preliminary agreement with terminal maker Sanders Associates, Inc., Nashua, New Hampshire, for acquisition of Sanders for \$17 million in cash and assumption of liabilities. Richard B. Tullis, Harris chairman, said purchase price is below book value and, because of this, Harris expects to be able to operate the Sanders business profitably from the outset. Harris plans to operate Sanders as part of its Data Com-

munications Div., headquartered in Dallas. Operations will continue in Nashua under present management.

**The Algorithm:** The encryption algorithm, originally developed by IBM and okayed by the National Bureau of Standards' Institute for Computer Science and Technology, has finally been approved as a Federal Information Processing Standard by the Commerce Department. Based on patents received in March 1974 by IBMers John L. Smith and Horst Feistel, the encryption algorithm must be used by all federal agencies in encrypting data. Excluded from this requirement are data related to the National Security Act of 1974 and the Atomic Energy Act of 1952. The new standard, in the works for four years, is expected to be published officially Feb. 15 and will become effective six months after the publication date. In addition to providing the new encryption standard to the federal government on a gratis basis, IBM also is generously offering a non-exclusive royalty-free license to anyone who wants to use the algorithm, provided it becomes a federal standard. The company earlier had set a deadline of Sept. 1, 1976, but later extended it to jibe with the delayed Commerce Dept. approval date.

### Mass Storage Marketing:

Ampex Corp. has turned over worldwide end user marketing rights to its TBM (Terabit) mass storage system to Systems Development Corp., Santa Monica, Calif. Ampex retains OEM marketing rights to the system. The two firms said SDC will purchase TBM data storage equipment from Ampex and will then use its extensive software and systems integration experience in the development of mass storage systems for its customers. Ampex will continue to manufacture the equipment at its Advanced Systems department in Sunnyvale, Calif. Ampex introduced its TBM in 1972 and has some five installations, including a unit purchased by SDC for \$1.8 million.

### Amdahl User Group:

Fifty-three representatives from all 27 current Amdahl 470V/6 installations and from four potential installations attended the first meeting of a newly formed Amdahl Users Group. Dr. Dick B. Simmons, president of the IEEE Computer Society, was elected the group's president. John W. Lovin, Jr., vice president for data processing at Liberty National Life Insurance Co. was chosen vice president. His company installed the number nine 470V/6. During the two-day

charter session, the group met with Dr. Gene M. Amdahl, company chairman; Eugene R. White, president; and Naoya Ukai, an Amdahl director and representative of Fujitsu Ltd. White asked the group to form two committees—one at the technical level and the other at the user management level—to continually apprise Amdahl management of user satisfaction.

### Amdahl in Germany:

Amdahl International has formed its first operational company, Amdahl Deutschland GmbH, Munich, Germany. The company already has delivered its first computer system to a German customer, a \$4 million 470V/6 system, shipped from California to Max Planck Gesellschaft zur Forderung in Munich. Richard B. Sayford, managing director of the new German company said a second, similarly valued system, was due to be shipped before the end of the year. Amdahl has some 15 technicians based in the Munich area in preparation for the computer installations.

### German Acquisition:

Varian Data Machines, Irvine, Calif. took a big step into the German computer products market with acquisition of Krantz Computer, GmbH of Aachen, Germany. Assets, manpower, manufacturing and sales facilities of Krantz Computer were acquired from its parent company, H. Krantz, a manufacturer of diversified commercial and industrial products. Purchase terms were not disclosed. Donal B. Duncan, Varian Data Machines president, said he expects the combined resources of Varian's advanced computer products and European sales force and Krantz's systems expertise and European marketing strength to "increase our own sales volume in Europe by 50%" during the coming year.

### Crowding but not Overcrowded:

The small business computer market is still at a stage where eventual domination by larger firms is not yet certain, said Creative Strategies, Inc., San Jose, Calif., based on a study it did of the market. "A major shakeout in the industry will not occur for at least three more years. CSI estimated that there are more than 100 participants in the marketplace if systems houses are included. But, said the research company, the market is big enough for everyone. CSI said domestic annual small business computer shipments have grown from \$794 million in 1972 to \$1.4 billion in 1975 and will continue to grow to \$2.2 billion by 1980. Annual unit shipments, the firm said, have grown from 20,300 in 1972 to 38,000 in 1975 and are expected to nearly double by 1980. \*



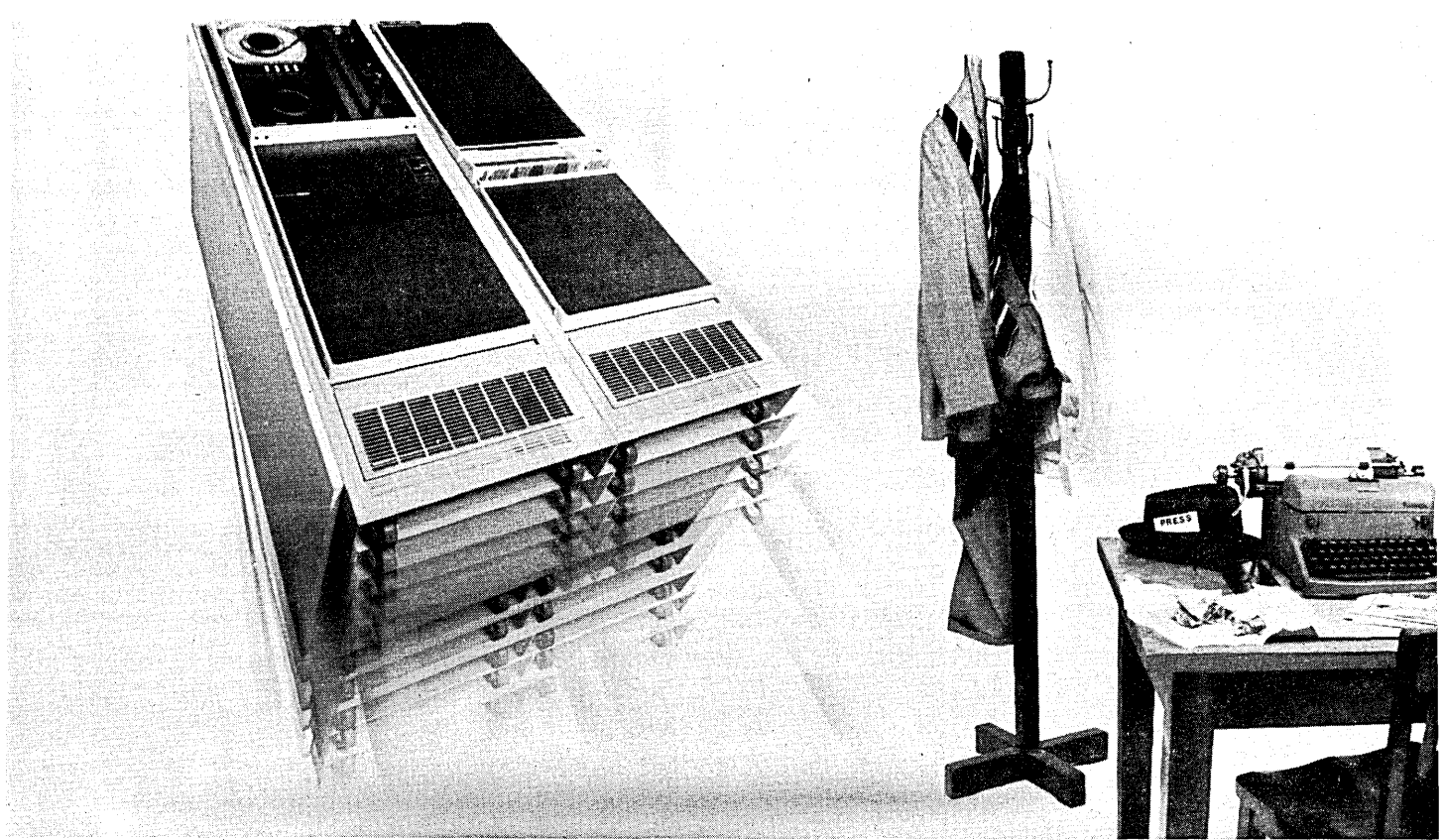

# Faster than a speeding bullet. More powerful than an Eclipse S/200.

It's more memory. It's more software.  
It's more speed. It's SuperEclipse!

Disguised as a mild mannered small computer, our new Eclipse S/230 leaps to the top of the scientific Eclipse line. More powerful because it has double the memory of the S/200, with 512K Bytes. As well as our new heuristic Advanced Operating System, for maximum resource utility and intelligent multiprogramming.

And if you think the S/200 was fast, our new time fighter has a 500 nanosecond MOS memory cycle time, and "look ahead" mapping for faster memory access.

Our SuperEclipse can meet the toughest challenges with the most advanced instruction

sets in the industry. Regular 16-bit single word or 32-bit double word instructions. And super fast floating point.

But the Eclipse S/230 is more than powerful; its high density core or MOS memory modules make it super reliable, too. With a full range of options and peripherals. And lots of support. For a lot less than you might think.

The Eclipse S/230. Here when you need it. With powers far beyond those of ordinary small computers. To discover its true identity, send for our brochure.

**S/230 IT'S A SUPERECLIPSE**

 **Data General**

ECLIPSE is a registered trademark of Data General Corporation.

Data General, Route 9, Southboro, Mass. 01772, (617) 485-9100. Data General (Canada) Ltd., Ontario.  
Data General Europe, 15 Rue Le Sueur, Paris 75116, France. Data General Australia, Melbourne (03) 82-1361

CIRCLE 68 ON READER CARD

# LOOK AHEAD

(Continued from page 16)

if asked (Chief Justice Raymond M. Carlson may retire this year) Christo shot back: "I would be sorely tempted."

## AFTER THE FOURTH TRY--WHAT?

For Leonard Palmer, a former Burroughs salesman, it's the fourth time up at bat against his former employer from whom he's already won two big dollar judgements by juries only to have them set aside by judges. Says Palmer "I'm willing to go to jail for contempt to prove my point."

The latest positive jury judgement for Palmer, who contended his CompuTerminal Service Bureau was put out of business by Burroughs, its prime supplier, came last March (March 1976 p. 18) when Palmer won from a jury a judgement of \$3.48 million in trebled damages. Subsequently, Judge Charles E. Wysynancki, on loan from a federal court in Boston, decided the trial wasn't quite right and ordered a new trial beginning March 1, 1977. Palmer, in the meantime, is keeping afloat doing expert (computer) work for his attorney, Joseph Alioto (son of the one time mayor of San Francisco) and he's prepared to speak his mind at the next trial to the point where he'll either win or go to jail.

## MOHAWK TO OFFER SMART TERMINALS

A leaner, reorganized Mohawk Data Sciences Corp. will push two new entries into the intelligent terminal market later this month. The System 9020--a pre-programmed microprocessor-based one to four-station and CRT offering--and the System 9040; its Cobol programmable mate, are Mohawk's planned Series 90 initiative in the smart terminal market. The two new lines are aimed at a perceived gap in the low end of the vendor spectrum: the 9020 pre-programmed terminal will lease at "less than \$200/month" and its programmable upgrade at "about \$220/month." Purchase prices for single station quotes will be between \$6,200 and \$6,400 on the 9020 and about \$7,000 on the 9040.

## RUMORS AND RAW RANDOM DATA

The New York brokerage firm, Drexel Burnham & Co., speculates that IBM will split its stock for the ninth time since 1954--this time on the order of three shares for two or possibly five shares for four, following a directors meeting Jan. 25. The split would increase the number of IBM shareowners by attracting small investors and thus give IBM the public support it may desire for its moves into the communications field and in its antitrust suits, which will bring the computer giant "even closer to the possibility of regulation." The move also would please IBM employees participating in the IBM stock purchase plan, because its price to earnings ratio has dropped considerably in the years following the Telex judgement (later reversed in appeals court)...Select-A-Seat, San Diego computer reservations firm, won a contract starting Jan. 1 to handle reservations for California's national and state parks, despite a suit brought by the former contractor, Ticketron, a unit of Control Data. Ticketron was unsuccessful in its San Francisco Superior Court suit against the California Dept. of Parks and Recreation in which it charged Select-A-Seat had the advantage of single source negotiations with the state. Select-A-Seat got the job after posting a \$200,000 performance bond...Newest, and maybe one of the largest, consortiums of banks to get into development of a shared Electronic Funds Transfer (EFT) system is the Carolinas Financial Federation made up of 272 Savings & Loan institutions in North and South Carolina which has signed a multi-thousands-of-dollars contract with Payment Systems, Inc. to help with development of a sophisticated shared EFT system...Newly-elected president of the Transportation Data Coordinating Committee, William G. Mitchell, predicts the transportation industry will be communicating "computer-to-computer" within the next five years...Popular as popular computing might be, few computer stores felt a Christmas surge although many geared up for one. Most now are looking for a big rush after Jan. 1, "when people have calculated their tax returns and are spending them" and after April 15, "when they have them and are spending them"...The Digital Computer Association, a group of oldtimers, holds its only meeting of the year March 18 in Los Angeles to "let the air out of some egos and stampede some sacred cows," says a press release from chairman Bob White of Informatics, Inc.

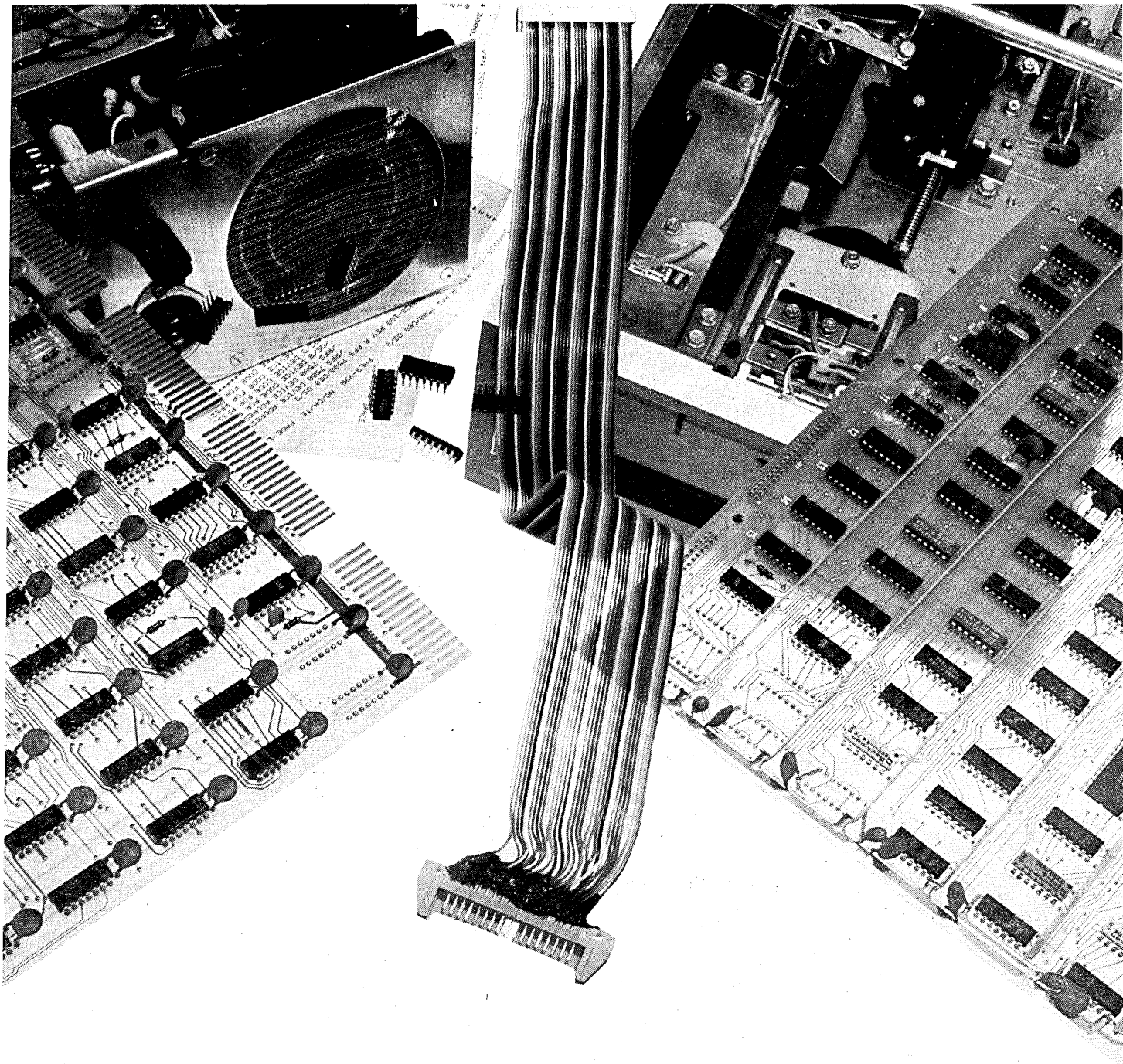

# DON'T GO TO PIECES. GO TO REMEX.

A cost/effective OEM flexible disk system can't be pieced together — hardware from one source, firmware from another, software from a third. Getting optimum performance at a low unit price requires design control to eliminate redundancy and volume production to reduce cost.

That's why Remex offers the RFS7500 Flexible Disk System — a complete system designed and built by Remex — including one to four Remex drives, a microprocessor based controller/formatter, software and interfaces for most major minicomputers plus power supply, cable and rack mountable chassis. The RFS7500:

expands data capacity through implementation of IBM3740 format or a user selectable 1, 2, 4, 8, 16, 26 or 32 sector

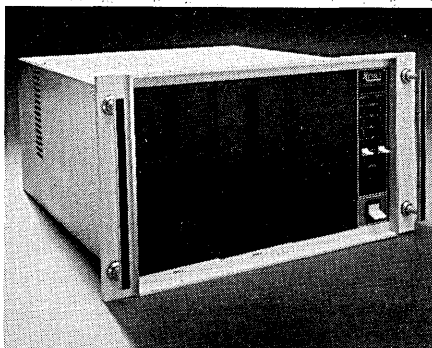

format.  saves computer time by data block transfer of from one to 65K 2-byte words on a single command from the host.  reduces core memory requirements due to automatic track and sector search and auto-initializing without software.  simplifies operation and system integration by 8-command structure.  saves space by housing interface card in the system chassis in some configurations.  speeds access through 6 ms track to track speed plus unit select.

The Remex RFS7500 is a better system at lower cost than the OEM can build himself or buy from a minicomputer manufacturer or second level supplier. Don't go to pieces, go to Remex, 1733 E. Alton St., P.O. Box C19533, Irvine, CA 92713 (714) 557-6860.

Ex-Cell-O Corporation

**REMEX DIVISION**

CIRCLE 47 ON READER CARD

# hardware

## Off-line

If all goes well by the time you read this, the first microprocessor will have succeeded in its debut in controlling the animation of a float in this year's Rose Parade in Pasadena, Calif. A Rockwell International PPS-4 was chosen to control the "Tons of Fun" float constructed by the California State Polytechnic Universities of Pomona and San Luis Obispo. The reason a microprocessor was chosen was to make it easier to isolate problems in case of a failure. The processor was responsible for controlling the animation on a float depicting a panic-stricken mother elephant on roller skates, being guided by a mouse on the tip of her trunk, with her tail pulling her baby elephant in a wagon.

A society has been formed to promote the usage of fiber optics for data communications through information transfer between the user and the manufacturer. The Fiber Optic Communication Information Society (FOCIS) includes representatives of both manufacturers and users of fiber optic cables, connectors, devices and systems. Those interested in joining should contact FOCIS at P.O. Box 2264, Vernon, Ct. 06066

MDS International, the European subsidiary of Mohawk Data Sciences, has announced receipt of the 2000th order for an MDS System 1200/2400. The minicomputer-based system will be responsible for off-line data manipulation, keyed data entry, and data communications. The 1200/2400 first saw the light of day back in 1974.

Things are happening at Applied Digital Data Systems, Inc., the Hauppauge, N.Y. crt terminal manufacturer. First the firm announced an order for 1,000 of its displays, worth more than \$1 million from Display Data Corp., of Hunt Valley, Md., for use in its Insight business system, oriented toward automobile dealers. Shortly thereafter, the firm announced that a marketing agreement had been reached with the Communication Products Section of the Canadian General Electric Company Ltd for CGE to distribute ADDS products in Canada. CGE will market, install, and service ADDS' line of crt terminals, including the Consul and Envoy series of tty compatible displays.

## Signature Display Crt

This one little product might go a long way toward making bankers (and bankees) a lot happier. It's a miniature crt terminal, the basic appearance of which has been around several years and has been well accepted, but a new feature, the capability of displaying a signature, may make the product really take off. Banks should like it because they can get more productivity out of their personnel when they don't have to continually close down teller windows so that customer signatures and account statuses can be checked, and customers should like it for the faster service it can provide.

The signature is displayed in the same manner as a "Times Square" advertising sign, using the equivalent of



12,288 lamps. These are arranged in a pattern of 192 by 64. Signatures appear slightly larger than life-size to assist verification. Multiple signatures can be displayed. The six-inch crt operates at up to 9600 baud. It's manufactured by Informer, Inc., of Los Angeles, but this supplier has exclusive rights to market the terminal to banks and financial institutions in the U.S., Mexico, and the Caribbean. Nearly two dozen banks, primarily in the Dallas/Houston area, are already experimenting with the signature terminal, it's claimed. With signature display capability the unit is priced at \$2,300 each in 100 unit quantities. SIGNATURE TECHNOLOGY, INC., Dallas, Texas.

FOR DATA CIRCLE 231 ON READER CARD

## Data Collection

The model 1647-2 data collection terminal accepts data from punched

badges and 80-column cards. It includes 20 user-definable (thanks to a microprocessor) keys for inputting variable data, and information such as time and keyboard entries is displayed on a 10-digit numeric display. Up to five LEDs are available for prompting the user, and there's room under them for the systems' implementor to specify and attach legends. For program storage, up to 2K bytes of ROM is employed, with architectural support of 16K bytes available if anyone needs it. Output devices for the terminal can include a crt, another LED display, a gas discharge panel, a printer, or a numeric display. It's claimed that the unit has been enthusiastically received in Canada despite what the manufacturer considers to be a price not very competitive with U.S. equipment: \$1,300 each in quantities of 100. EPIC DATA SALES LTD., Richmond, B.C., Canada.

FOR DATA CIRCLE 232 ON READER CARD

## Network Control

NETCON-5 is a diagnostic control system intended as an inexpensive way to monitor and restore malfunctioning data networks. The pitch is that with NETCON, a user doesn't have to dedicate a highly trained (and therefore highly paid) technician to monitor what a non-dp oriented person can do with the proper equipment. System control and monitoring is accomplished by a diagnostic control unit at the central site that accesses, via addressing techniques, and interrogates, diagnostic modules electrically interfaced to remote modems. The system pinpoints problems and restores system operation through alternate facilities, either by switching to dial back-up and/or transferring to a spare modem.



# Standard Memories offers MORE for LESS...

**MORE: Capacity with Increased Performance/Reliability**

**LESS: Initial Cost, Less Spares Cost, Less Downtime**

Increase the data storage capacity of your CPU by simply adding the applicable **PINCOMM**® or **BUSCOMM**® Memory...

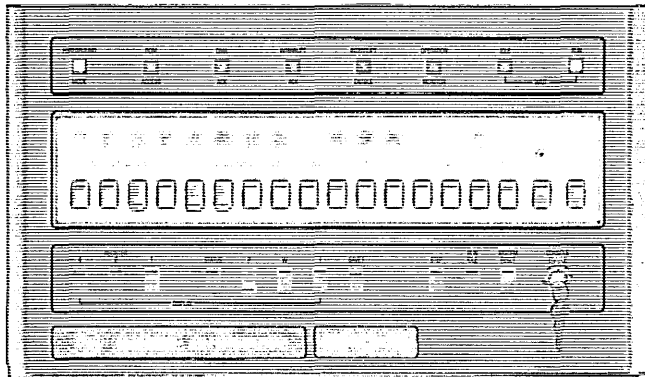

Ask for **PINCOMM**® A 8K or 16K Words  
Compatible to any SPC-16 memory slot  
(Also available for SPC-18)

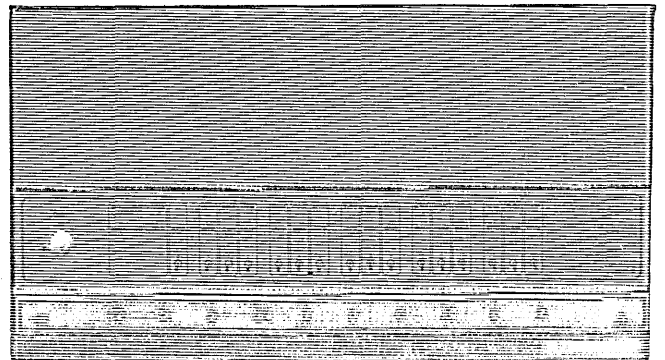

Ask for **PINCOMM**® N 16K Words (32KB)  
Compatible to any NOVA 2 memory slot

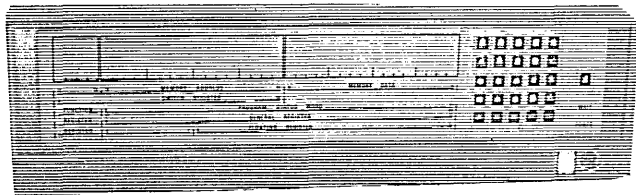

Ask for **PINCOMM**® I 16K Words (32KB)  
Compatible to any INTERDATA 50, 55, 70, 74, 7/16,  
7/32 and 8/32 memory slot

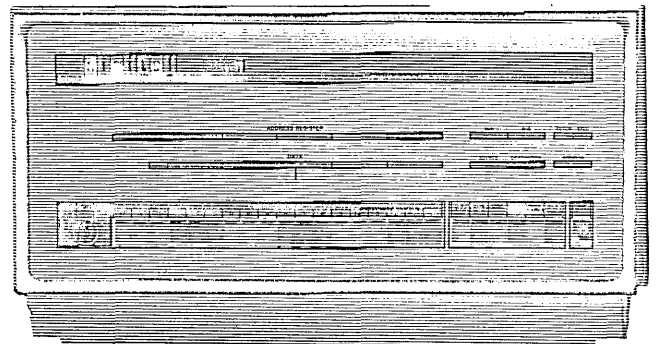

Ask for **BUSCOMM**® H-11  
16K Word increments to 65K in 5¼" enclosure  
UNIBUS compatible (12¼" enclosure available)

**STANDARD MEMORIES**

AN APPLIED MAGNETICS COMPANY

3400 Segerstrom Avenue  
Santa Ana, California 92704  
(714) 540-3605

**360 MEMORIES  
SYSTEM/3 MEMORIES  
TERMINALS  
AVAILABLE TODAY!**

**NOW...YOU HAVE A CHOICE OF ADD-ON MEMORY FOR YOUR PDP-11/70...THE ECONOMIC AND RELIABLE STANDARD COM® 70 SERIES IN 128Kb INCREMENTS. AND DELIVERY IS IMMEDIATE!**

*PINCOMM & BUSCOMM are registered Trade Marks of Standard Memories.*

*Interdata, General Automation, Data General, & Digital Equipment Corp., and their various model designations are recognized registered Trade Marks.*

# hardware

The system operates with synchronous or asynchronous modems and is compatible with Bell 201, 202, and 208 modems. NETCON-5 is transparent to the type of code, speed, or protocol of data traffic. A microprocessor is used to guide the operator through testing and restoral functions in English question/answer format. All communication lines are constantly scanned. Performance statistics are kept for subsequent analysis, and testing can include modem station status, master modem self-test, and remote modem self-test and station polling test. Systems are priced at \$500-750 per remote line. GENERAL DATACOMM INDUSTRIES, INC., Wilton, Conn.

FOR DATA CIRCLE 234 ON READER CARD

## Desktop Mini

Here's a nice rival to the IBM 5100 and other similar systems designed for on-the-spot solution of relatively small problems. The P6060 consists of a keyboard, 40K bytes of memory (of which 8K are available to the user), a floppy disc (with a second one optional to facilitate sorting), a 32-character visual display and 10-key numeric pad. All for only \$7,950. With 16K of

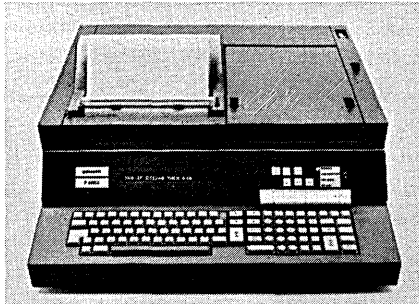

memory and 80-cps, 80-column printer, the price is still under \$10K. Programming is accomplished in extended BASIC, and there is a full raft of options, including an interface to a high performance disc storage unit! All EIA RS232 peripherals can be attached to the 6060. OLIVETTI CORPORATION OF AMERICA, New York, N.Y.

FOR DATA CIRCLE 233 ON READER CARD

## Image Projection

Talk about versatility! One moment the Magna Image I can be projecting Monday Night Football games, and the next it could be assisting a class in computer science, with real terminal information data displayed on a screen or wall. The unit will interface with most raster scan crt's now in use and can display up to 24 lines of 80 characters each. The images can range from 3 x 4 feet up to 15 x 20 feet, with a picture-throw ratio of twice the screen width. The unit is priced at \$4,200,

only a little more than a standard crt. IMAGE MAGNIFICATION INC., Verona, N.J.

FOR DATA CIRCLE 235 ON READER CARD

## Univac's Largest

There's a new top of the line-up at Univac, the 1100/80, and perhaps equally significant, a networking architecture that management feels will dictate the design of communication networks for possibly the next two decades. Depending on whether the 1100/80 will be a uniprocessor or a multiprocessor, the buffer store (cache memory) varies from 8-16K words (36-bit variety) for uniprocessors and a straight 16K words for multiprocessors. Average access time to the processor is 125 nsec, and main memory can supply eight words to the buffer every 1.25 usec. It's a powerful cpu, estimated to be twice as powerful as

the previous top of the line model 1100/40. Basic main memory starts at 512K words and can be expanded to more than 4 million words. The cpu has a cycle time of 50 nsec, floating point and byte instruction sets, and an optional emulation set for the Univac 494 systems Univac would dearly like to convert its users away from. Thanks in part to multilayer circuit boards, Emitter Coupled Logic (ECL), and other technology improvements, the 1100/80 is approximately one-third the size of its 1100/40 sibling and has lower heat dissipation and power requirements. Also new: an I/O channel that easily handles both bytes and words. Minimum systems will rent for \$50K/month including maintenance, to around \$100K/month, or purchase price spreads from \$2-6 million. Deliveries are promised for the first quarter of this year. DCA, or Distributed Communications Architecture, is Univac's

## product spotlight



## Standalone DP/Text Processor/Intelligent Terminal

This small new company could, within a very short time, become one of the largest suppliers of small business systems, become a major factor in the intelligent terminal marketplace, or throw its weight around in the text processing portion of the word processing market. Or, it might just do all three things simultaneously.

The reason is that the equipment is the Teletype Dataspeed 40/2 that Bell would have loved to have taken to the dp marketplace and is now encouraging this group of developers (mostly expertec people) to do. The most natural place for the Cado system would be in upgrading existing Dataspeed 40 users to Cado specs, meaning the addition of floppy discs and a microprocessor cpu to the Teletype Corp. crt and printer. An obvious plus in all this is the high marks Teletype gets on its equipment for solid performance, plus the very competitive price tag on the hardware. This supplier then adds the floppies and cpu and delivers the systems to its more than 20 domestic sales agents, and to agents in Canada and Europe. The agent then gives potential customers courses in how to write BASIC soft-

ware programs and make the machine productive.

A flick of the switch turns the system into an intelligent terminal. It makes the asynchronous Dataspeed 40 look like a synchronous IBM 2770, 2780, or 3780 to interested host cpu's. Terminal configurations from scratch are priced at around \$16K, including communications, two floppy discs, and the 300 lpm printer. Addition of the operating system ups the price to \$20K, but that's still a bargain considering the quality of the hardware. So that the microprocessor inside the Dataspeed 40 doesn't get bogged down in its responsibilities, an Intel 8080 microprocessor is responsible for coordinating the floppy discs and doing the actual computational aspects of operation. The terminal microcomputer only drives the printer and the screen. Even considering the power of the two micros, the system cannot be in communication mode while simultaneously driving the printer and the discs. The little 8080 is busy enough. A hard disc is in the wings for customers who will tackle larger file applications. Deliveries to sales agents in major cities is underway. CADO SYSTEMS CORP., Torrance, Calif.

FOR DATA CIRCLE 230 ON READER CARD

INTRODUCING AN INNOVATION IN DISC CONTROLLER DESIGN

# DIVA'S COMPUTROLLER V

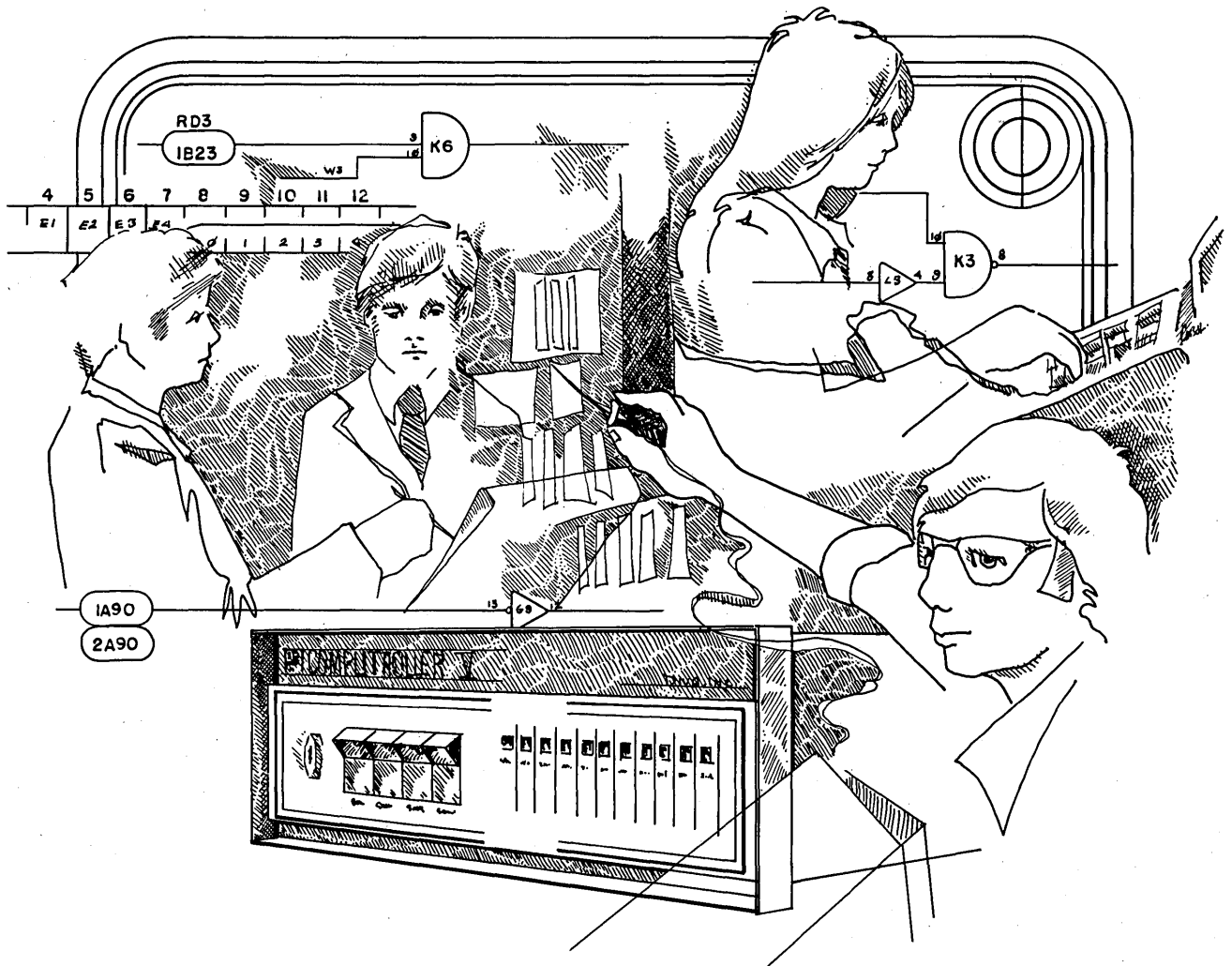

Perhaps you don't realize that you have an alternative to expensive disc storage capability with NO software changes.

Introducing **DIVA's COMPUTROLLER V**, a new addition to DIVA's intelligent line of disc controller systems.

The genius of this design provides you with the following benefits:

- Microprocessor Technology
- Total Software Transparency
- Full Error Correction—Completely Self-Contained
- Built-In Self-Testing Diagnostics
- Expandable 240 Word FIFO Buffer
- Interfaces to DEC, DG, and Interdata Minicomputers
- Dual Processor Support

- Compatible with all Ampex, CDC, Calcomp and ISS Drives
- Cost Effective Mass Memory Storage (5 m/bytes to 300 m/bytes per spindle)
- Eight Spindles per Computroller

**DIVA for mass storage . . .**  
"The original mini-maximizer"



For complete technical specifications and pricing information—call or write us today—

DIVA INC., 607 Industrial Way West, Eatontown, N.J. 07724 (201) 544-9000;

Los Angeles (213) 991-0321; Chicago (312) 956-0688; Phoenix (602) 991-4141; Boston (617) 275-1436; Washington D.C. (703) 435-1299; New York/New Jersey (201) 542-8093.

# hardware

equivalent of IBM's SNA. But there are some big conceptual differences that IBM users will appreciate. "Continued compatibility of present and future products will be ensured by specifying interfaces and functions of all compo-



nents and providing guidelines for building networks." No major new product emphasis to wreak havoc in customer shops, says Univac. A major component of the announcement is TELCON, an intelligent communications system that provides the basic

hardware, software, and peripherals for the user employing DCA architecture. SPERRY UNIVAC, Blue Bell, Pa.

FOR DATA CIRCLE 236 ON READER CARD

## Power Safety Feature

Not every user routinely requires or wants his mini to come back on the air after a power interruption. One solution to the problem is the SAF-START, a switch that must be "knowingly" reset after the power irregularity. It's a small item, priced under \$30, that could save potential damage and even injury. It's available in 120 and 240 volt, 13 Amp versions. JDS PRODUCTS, INC., Pontiac, Mich.

FOR DATA CIRCLE 237 ON READER CARD

## Tape Cleaner/Evaluator

While not really revolutionary in any way, the Century 22 tape cleaner/evaluator appears to be highly refined in almost every way over previous products and will be pitched with some impressive claims to users. Perhaps most importantly, there's a 2,000 hour or one year head life guarantee said to be double what other manufacturers offer. Additionally, the vacuum collector system has been strengthened for more effective oxide and debris removal. Better muffling is provided so that the Century 22 doesn't offend, and there's a switch (optional) for select-

ing 180 or 360 ips forward/reverse speeds. The 180 ips setting yields a four minute cycle time for 2,400 foot tapes. Versions are available for all track/density/combinations, and tape errors are detected and counted at permanent (write/skip) or marginal (hy-

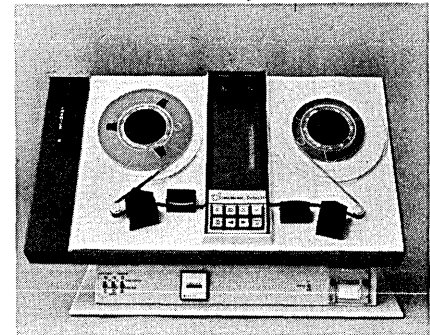

percritical) levels and displayed on an LED panel, augmented by a hard copy digital strip printout which shows error locations. Prices start at \$9,295. DATA DEVICES INTERNATIONAL, Woodland Hills, Calif.

FOR DATA CIRCLE 238 ON READER CARD

## Printer Ribbon

Special weaving, and a new special inking process are the principal reasons the X-TRA-LIFE printer ribbon is credited with providing users with 15% additional wear. The denser weaving means more tensile strength, and per-

# IN WIRE-WRAPPING HAS THE LINE... HOBBY-WRAP-30 FOR AWG 30 WIRE ON (.025 SQUARE POST)

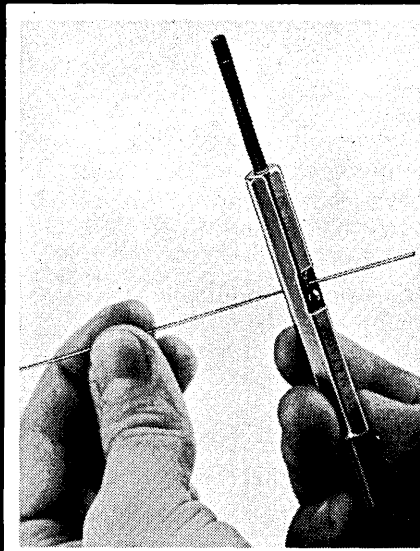

STRIP

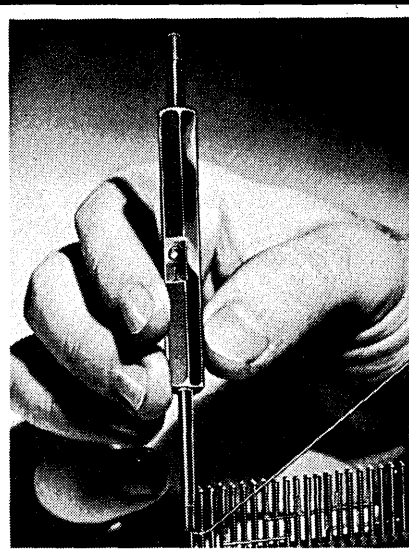

WRAP



UNWRAP

**OK MACHINE & TOOL CORPORATION**

3455 CONNER STREET, BRONX, NEW YORK, N.Y. 10475 U.S.A. • PHONE (212) 994-6600

TELEX: 125091 TELEX: 232395





# Programmers & Engineers

Texas Instruments is seeking highly motivated and creative individuals in its Digital Systems Division in Austin, Texas. Selected individuals will join the rapidly growing minicomputer team which is part of the future thrust of the corporation. You'll enjoy life in Austin — one of the six fastest growing major cities in the U.S. It's got the kind of riches every city wants. Beautiful lakes and hills. The South's largest university. Outstanding parks and public schools. And Texas has no state income tax.

## **Product Marketing Engineers**

Responsibilities will concentrate on identification of minicomputer and computer related product requirements, and working directly with customers and field salesmen on new business. Duties will also include technical support to sales, service and customer training as well as other factory support areas. Requires BSEE/ME, Math or Business with MBA desired as well as 5 years experience in product marketing with at least 2 years in direct support to field sales. Also experience in work processing desired.

## **Mechanism Engineers**

Develop cost-effective advanced computer disc mechanisms having air bearings, and precision linear and radial motion hardware.

## **Design Engineers**

Strength in design and implementation of minicomputer systems for industrial customers. Requires special process I/O designs and interfacing to the TI computer family. Position will include some project management. A BSEE and 4-7 years design experience in digital computers is required; background in software is preferred.

## **Applications Engineers**

Provide support for computerized test systems to include the definition and implementation of such systems using the TI minicomputer family. Assembly language experience is required. Also requires a BSEE and 3-5 years of directly related experience.

## **Packaging Engineer**

Design packaging for new computer peripheral products. Perform cost/performance tradeoffs between various packaging techniques. Specify tooling. Perform heat flow analysis. Requires a BSME and 3-7 years experience in sheet metal, structural foam, injection molding and vacuum forming.

## **Software Development Programmers**

Experience in design and implementation of minicomputer software products; operating systems, languages, data management and utilities. Project management experience useful. Aptitude in Assembly language required. Familiarity with PASCAL desirable. BS or MS in Computer Science, Mathematics, Physics or Engineering with 2-5 years experience.

## **Systems Programmers**

Systems oriented, real-time programming for control systems, new systems design, and distributed processing systems. Aptitude in Fortran, COBOL, and PASCAL. Positions available at various levels from 2 years experience to project management. Experience in microprocessor or minicomputer Assembly language and a knowledge of computer hardware architecture required. BSEE or MS with 2-8 years experience also required.

## **Mechanical Engineers**

Position responsibilities include design of electronic packages for specialized industrial applications and environments. This will cover the spectrum from cosmetic design to space and heat dissipation. Requires a BSME with 3-5 years experience in mechanical design and packaging activities.

## **Applications Programmers**

Positions from project management to team support in industrial applications. Ability to design, code and document software for real-time distributed processing and data exchange systems with interface to customers required. Excellent knowledge of Assembly language and a BA/BS in Math, CS, or related field with 3-8 years experience required.

Send your resume in complete confidence to: Lee Cooke/Staffing Manager/P.O. Box 2909, M.S. 2016/Austin, Texas 78769.

# TEXAS INSTRUMENTS INCORPORATED

An equal opportunity employer.

# hardware

haps more importantly, a greater resistance to stretching and tearing. Ribbons for almost every printer on the market are available almost immediately, and typically cost \$15.05 each for IBM 1403 versions. PRUDENTIAL SYSTEMS INC., Santa Fe Springs, Calif.  
FOR DATA CIRCLE 239 ON READER CARD

## TI Numeric Pad

Many Texas Instruments terminal units don't have numeric clusters or separate numeric keyboards, but users who need them can now obtain them from this Northwestern supplier. Eight standard keyboard layouts are available, featuring line feed, carriage return, period, comma and other symbols, as

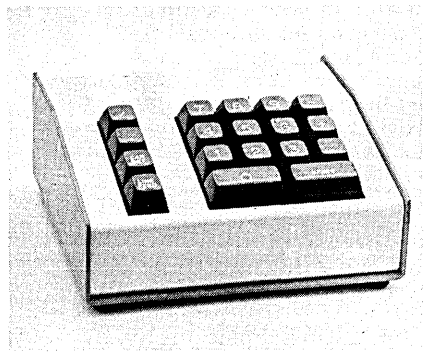

well as the numbers zero through nine. Custom layouts are also available. Prices start at \$200 for a 16-key version. Installation is said to require only 15 seconds and the units are guaranteed for a year. CASCADE RESEARCH ASSOCIATES, Longview, Wash.  
FOR DATA CIRCLE 240 ON READER CARD

## Tape Inspector

An optical inspector for audio, video, computer, and instrumentation grade tape is now being made available to both oem manufacturers of tape drives and tester/cleaners, and end users. The end user who decides to attach the

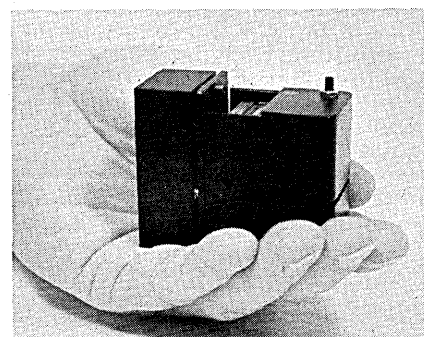

inspector to his or her own equipment will have to be somewhat familiar with electronics, however (at least be able to find a 5V power supply), but that's about it. The manufacturer can supply adjustable mounting plate (\$55!) for

the device.

During routine operation, the inspector can detect errors or irregularities as small as .02 inches, without physically contacting the tape. Relay contacts are provided to stop the transport if desired. The basic unit is priced at \$625. One handy option is a defect counter/power supply that can be set to stop the processing after a predetermined number of errors have been found. Complete with power supply and LED numerical display unit, this option adds \$195 to the basic price. (Prices are for 1/2-inch computer tape.) BOW INDUSTRIES INC., Bailey's Crossroads, Va.  
FOR DATA CIRCLE 242 ON READER CARD

## Camera to cpu Interface

What is claimed to be the world's first vidicon camera to cpu interface with the ability to exchange queries, information, and commands with either analog or digital computers is now available. Twenty i/o lines are the key, making it unnecessary to modify a standard vidicon camera for computer use. Principal applications are thought to be in the research and industrial computer field.

Buffers and interfaces allow the user to tailor the camera to application requirements. A set of standard building blocks is available to perform the more common functions such as point tracking, area measurement, etc. The resolution is 1000 tv lines (almost double a domestic tv set's ration.) Prices start at \$3,500. HAMAMATSU CORP., Middlesex, N.J.  
FOR DATA CIRCLE 241 ON READER CARD

## Small-scale Mainframe

It's hard to believe the Burroughs B-1700, one of the most interesting systems to come to the market in years, is obsolete already but then the announcement was back in mid-1972. Its successor looks like more of a good thing, however: the B 1800 series user can have up to 3.5 time the power of the smallest B 1700 configuration. In general the systems provide up to 40 percent more throughput for about the same price and require about half the power and floor space as comparable B 1700 models. The B 1800 program library is object code compatible with B 1700 routines, and in addition, the B 1800s are compatible with the Computer Management System recently released on the smaller B 80 system.

There are three models: the B 1830, B 1860 and B 1870, differing principally in cpu speeds, memory sizes, cache memory allotment, and disc storage ration. The B 1830 goes from 48-256K bytes of memory and doesn't have a cache memory. The B 1860 goes from 64-384K, and the B 1870 from 96-

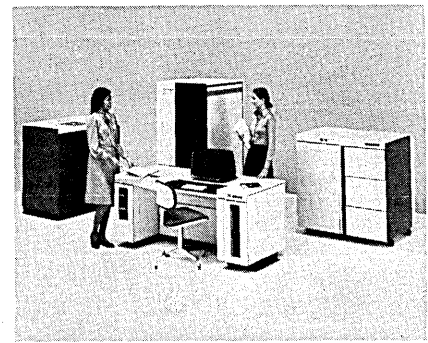

512K bytes. The two larger systems get the high speed bipolar microinstruction cache memory that operates at six times the speed of main memory. Up to 14 channels can be obtained on the systems, all fully buffered. Prices range from around \$108K for a typical small B 1830 to more than \$500,000 for a large B 1870. BURROUGHS CORP., Detroit, Mich.  
FOR DATA CIRCLE 243 ON READER CARD

## DEC 36-biters

DEC has announced new top of the lines in its two 36-bit large-scale computer family, the DECSYSTEM-2050 and both a single- and dual-processor model called the DECSYSTEM-1090. Basically the 2050 boils down to twice the performance of a DECSYSTEM-2040 for only 25% more cost. Current 2040 customers can move to the 2050 by a field upgrade.

The DECSYSTEM-1090 and its dual-processor extension, the DECSYSTEM-1099 are both built around a new processor called the KL10B. This processor



can accommodate up to 20 million characters of main memory, and the system can handle up to 6.2 billion characters of disc storage. DECSYSTEM-2050 prices range from \$525K to \$1.5 million, while a DECSYSTEM-1090 capable of supporting more than 128 interactive users (or 1,000 transaction processing users) runs around \$2 million. Both systems go out the door during this first quarter of 1977. DIGITAL EQUIPMENT CORP., Maynard, Mass.  
FOR DATA CIRCLE 244 ON READER CARD

## Small Biz System

There's so much raw hardware floating around in the microprocessor area that

it has probably held back an even greater proliferation of low-cost, very capable systems. This microcomputer-based system is an exception, mainly because it was designed by a software-oriented person who learned about the hardware as a hobby in his garage. The software is a multi-user BASIC which should be palatable to the end-user target customer. The code is neither re-entrant nor does more than one copy of a routine that users desire to access have to be in memory at one time. It's all done with a clever swapping of program pointers, which helps hold down memory, and therefore costs, requirements. One of the first applications to fly on the system is an integrated order entry/credit/inventory system with a report generator as flexible as many priced more than this complete system. One of the first markets the company may approach is the System/3 market, where the system will be pitched as an on-line solution for a batch host system, meaning that current daily information will be kept on the Microfinancial mini, accessible through the crt terminal in an on-line manner, and used to update the System/3's files off-shift. A typical minimum system, consisting of crt terminal, cpu, floppy disc, and 165 cps serial printer, is priced around \$13K. MICROFINANCIAL CORP., Diamond Bar, Calif.

FOR DATA CIRCLE 245 ON READER CARD

#### Smart Reader

Everything's getting equipped with a microprocessor lately and now it has finally happened at the magnetic-stripe card reader level. The 6150-01 reader, for use in the manufacturer's PTS-100 intelligent terminal configuration, actually makes a lot of sense. It provides the ability to decode information regardless of whether it's printed in the Inter-

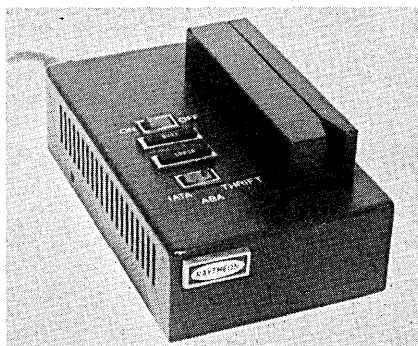

national Air Travel Association (IATA) 72 character standard, the American Banking Association 36 character format, or the proposed ANSI standard 104 character regulation. Raytheon emulators for the IBM 2260 and 3270 as well as those for PARS/IPARS can support the new reader. It lists for \$750. RAYTHEON DATA SYSTEMS, Norwood, Mass.

FOR DATA CIRCLE 246 ON READER CARD

January, 1977

# REMOTE TECH CONTROL



## THE NEW WAY!

Yes—Dynatech now gives you complete remote control over all tech control functions—from an ordinary Touch-Tone® telephone. You can control up to 64 functions using a single dial-up number.

- Network management and reconfiguration for a variety of applications.
- Network maintenance, fault diagnostics and system restoral.
- Analog and digital transfer and loopback.
- Modem, terminal and computer port switching.

Multi-digit security code and auto disconnect features prevent unauthorized or accidental access.

Answerback tones provide positive confirmation of remote control functions.

MODULAR SYSTEMS  
FOR TOTAL DATA  
COMMUNICATIONS  
ANALYSIS AND MANAGEMENT

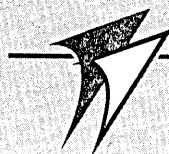
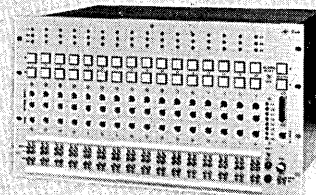

**DYNATECH LABORATORIES, INC.**

*Cooke Engineering Division*

900 SLATERS LANE, ALEXANDRIA, VIRGINIA 22314  
TELEPHONE: 703-548-3889 ■ TELEX: 89-9119

European Sales and Distribution: Furrer Marketing, P.O. Box 99, Baarerstrasse 91, CH-6300 Zug 2 Switzerland Phone: 042-218146, Telex: 72178

AVAILABLE ON GSA SCHEDULE

\*Touch-Tone is a registered trademark of the Bell System

CIRCLE 92 ON READER CARD

# hardware

## PDP-11 Memory

The WE-VM11 semiconductor memory system is electronically and logically compatible with all PDP-11 models. The board is supplied with 4K, 8K, 12K, or 16K by 16-bits of storage at prices ranging from \$750 up to \$1,650. N-

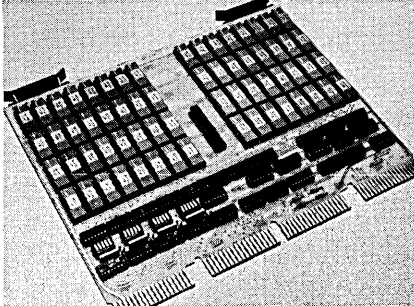

MOS static RAMs are used that require no refresh circuitry, which helps keep the power requirement down to a measly 18 watts, and means that the existing power supply easily suffices. The starting address location of each of the up to 4K modules on the board can be set or reset at the flip of a DIP switch. This manufacturer also offers memory for the PDP-8 models, A, E, F, and M. WE COMPUTER EXTENSION SYSTEMS, Houston, Texas

FOR DATA CIRCLE 247 ON READER CARD

## Crt Terminal

The Consul 980B is a variation of this manufacturer's successful Consul line set up to operate with Burroughs mainframes as an alternative to the Burroughs TD 700-800 series. Several additional and handy features are built into the 980B, including graphics capability, a security keylock, program attention and function keys, a separate function keypad, a numeric keypad, a parallel/serial peripheral interface, and operation at speeds up to 9600 baud. The 980B will cooperate (either synchronously or asynchronously) with all mainframes within Burroughs 1700-7700 lines. Single units are priced at \$3,200, or \$90/month on a three-year lease. APPLIED DIGITAL DATA SYSTEMS INC., Hauppauge, N.Y.

FOR DATA CIRCLE 250 ON READER CARD

## Compact Floppy Disc

It appears Shugart and Wangco projects for developing a smaller version of the versatile floppy disc were on about the same time lines (Shugart's was announced in December 1976, p. 178). The model 82 Micro-Floppy measures only 3.25 x 5.75 x 7.95 inches, weighs less than four pounds and uses a 5.25-inch cassette. The real beauty of the device is that it can be expanded to as much as 498.8 kilobytes, both reducing storage costs and

making the model 82 competitive with higher priced disc storage devices such as cartridge discs—at least in capacity. The basic capacity is 109.4 kilobytes on 35 tracks. The track-to-track access time is 30 msec, and random seeks average out to 370 msec. The error rates quoted are  $1 \times 10^9$  soft errors

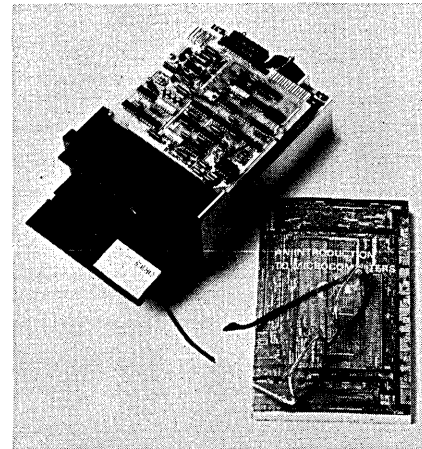

and  $1 \times 10^{12}$  hard errors. The model 82 is strictly available to oem's, who will pay something under \$300/each in large quantities, depending on specific requirements. Evaluation units will be available this month. WANGCO INC., Los Angeles, Calif.

FOR DATA CIRCLE 249 ON READER CARD

# Improve your MVS visibility.

SARA IV, the new BCS management information system for MVS installations provides:

- Specialized SRM performance reports
- Detailed displays of MF/1 data
- System Performance Statistics
- Complete job, step and program analysis
- Flexibility to generate custom reports
- An Exception Reporting Feature
- Management Data for Resource Planning and Control
- Comprehensive Projection and Planning Reports
- Graphic Data Display

SARA versions are available to support other IBM and Honeywell systems.

To schedule a product demonstration, please call (800) 336-0135, or mail the coupon.

**BOEING COMPUTER SERVICES, INC.**  
7777 Leesburg Pike, Suite 217  
Falls Church, VA 22043

I want more information on SARA.

Name \_\_\_\_\_ Title \_\_\_\_\_

Company \_\_\_\_\_ Phone \_\_\_\_\_

Address \_\_\_\_\_

City/State/Zip \_\_\_\_\_

BOEING COMPUTER SERVICES, INC.

CIRCLE 27 ON READER CARD

Save time...money...trouble...

Lease your Teletype\* equipment from RCA...

Model 33ASR (with tape perforator and reader) **\$63\*\* per month**

Model 33KSR (send/receive) **\$48\*\* per month**

• Includes nationwide maintenance service by RCA's own technicians.

\*\*Prices quoted for 1-year lease.

Slightly higher for 90-day lease.

Call or write nearest office: RCA Service Company  
A Division of RCA, Technical Services

Bldg. 204-2  
Camden, N.J. 08101  
Phone: (609) 779-4129

3310 South 20th Street  
Philadelphia, Pa. 19145  
Phone: (215) HO 7-3300

4508 Bibb Blvd.  
Tucker, Ga. 30084  
Phone: (404) 934-9333

20338 Progress Drive  
Strongsville, Ohio 44136  
Phone: (216) 238-9555

43 Edward J. Hart Rd.  
Liberty Industrial Park  
Jersey City, N.J. 07305  
Phone: (201) 451-2222 (N.J.)  
(212) 267-1550 (N.Y.)

7620 Gross Point Road  
Skokie, Ill. 60076  
Phone: (312) 965-7550

2711 Irving Blvd.  
Dallas, Texas 75207  
Phone: (214) ME 1-8770

1501 Beach Street  
Montebello, Calif. 90640  
Phone: (213) 685-3069

\* Registered trademark of Teletype Corp.

CIRCLE 113 ON READER CARD

# FORTRAN

# ABLE

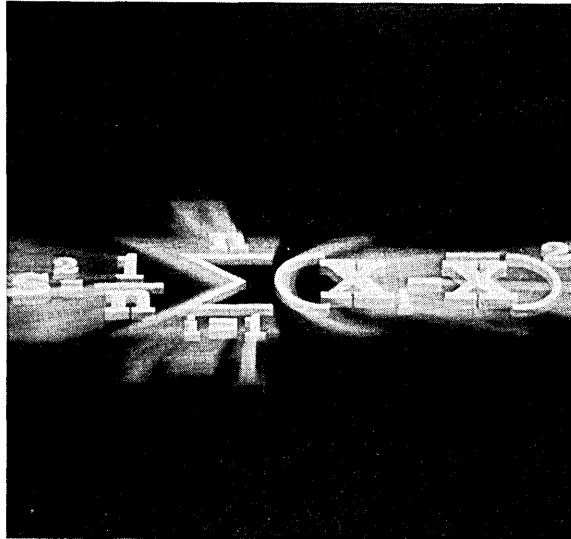

## The language of optimized performance

Interdata's FORTRAN VI optimizes object code to reduce execution steps and dramatically increase overall system throughput. It's a superset of ANSI standard (X3.9-1966) and takes full advantage of the IBM-like architecture of Interdata's 32-bit processors.

Superb data manipulation includes halfword for process control. Fullword for high precision and double precision for volume number crunching.

Its comprehensive reentrant library has run-time subprograms with mathematical functions, language extensions, real-time facilities and input/output.

All these FORTRAN-abilities make Interdata's FORTRAN VI the ideal language system to simplify sophisticated computation.

And, it's field-proven. Write or call today for documentation . . . or immediate delivery.

**● INTERDATA®**  
A UNIT OF  
**PERKIN-ELMER DATA SYSTEMS**  
OCEANPORT, N.J. 07757 (201) 229-4040.



**Litton**

**370/168**

**VS2 - HASP - TSO  
DOS EMULATION (DUO)**

**APPLICATION AREAS:**

- FINANCIAL**
- DATA BASE**
- ENGINEERING**
- DATA MANAGEMENT**
- STATISTICAL/MATHEMATICAL**
- SIMULATION**

**ALL SYSTEMS AVAILABLE  
24-HOURS PER DAY**

**LITTON COMPUTER SERVICES**

**1831 Michael Faraday Drive  
Reston, Virginia 22090**

**(703) 471-9200**

CIRCLE 108 ON READER CARD

**INTRODUCING OUR  
MODEM AND TERMINAL  
INTERFACE  
POCKET ANALYZER.**



**IDS MODEL 60**

Our new Model 60 packs in the most testing capabilities per dollar cost. Pinpoints the source of trouble between the MODEM and TERMINAL. Provides access to all 25 lines of the EIA RS 232 interface. Has 12 monitoring LED's plus two voltage-sensing LED's. 24 miniature switches allow isolated testing and observation of all signals. Mini-jumpers included for crosspatching and signal monitoring. Sturdy 10 oz. unit has hard plastic case, and is battery powered. Immediate delivery.



100 Nashua St., Prov., R.I. 02904. Tel. (401) 274-5100. TWX 710-381-0285

CIRCLE 119 ON READER CARD

# STILL NUMBER ONE.

**Leading Causes of Death**  
United States: 1972 Estimates

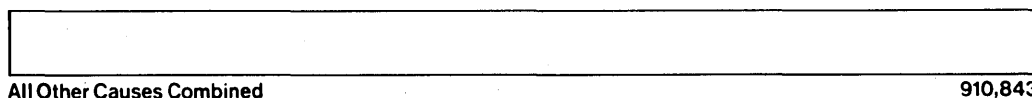

**WE HAVE YOUR BEST INTEREST AT HEART.**

**Give Heart Fund**  
American Heart Association

# Solving business problems is our business.

John D. deButts, Chairman of the Board, AT&T

**You'll be seeing the phrase:  
"The system is the solution!"  
It's more than a slogan. It's a  
basic expression of the Bell  
System's marketing philosophy.**

The single fastest growing part of any business today is communications.

The flow of information.

So it is no wonder that many problems in business are really communications problems in disguise.

**Communications can solve business problems.**

At the Bell System, we believe we can be of enormous value to business—any business—by applying our expertise in communications to your business problems.

Not simply voice communications. But data as well. The Bell System is the largest data transmission network in the world. In short, total communications systems problem solving.

**To solve your problems, we have to understand your problems.**

No single person has the knowledge and experience to deal with the problems of every business.

So we have aligned our efforts on an industry-by-industry basis (i.e. automotive, hotel/motel, education, package goods, travel, etc.).

This way each division has an in-

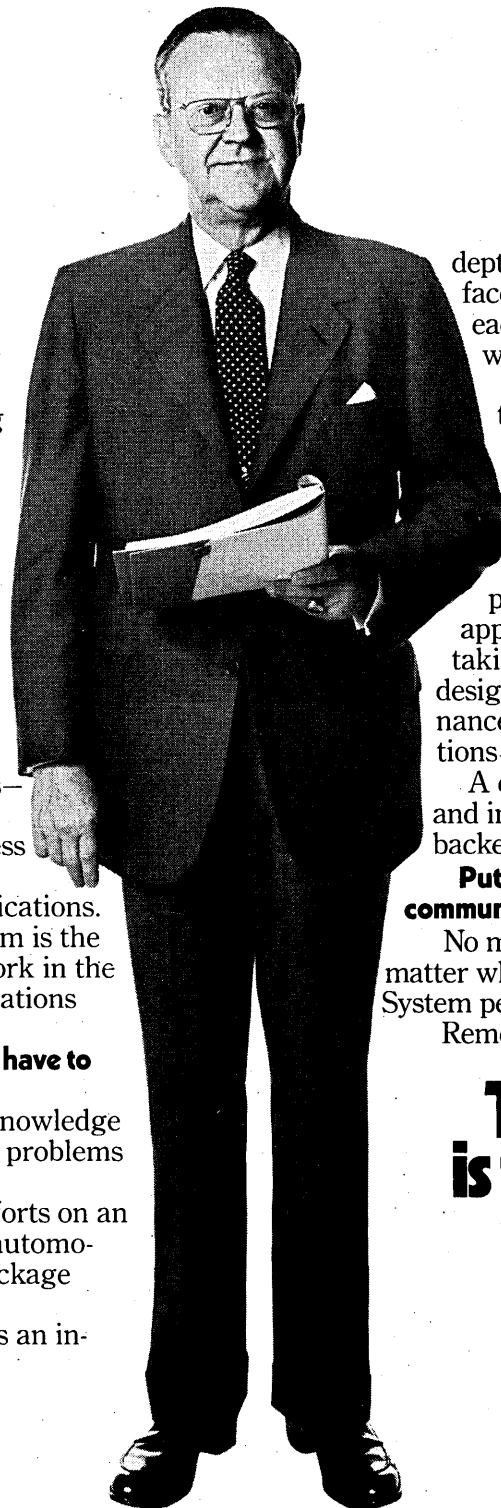

depth understanding of the problems faced by their customers. The heart of each is an Account Representative who is assigned to you.

Your Account Representative thoroughly understands today's complex communications, and more importantly, understands your business thoroughly.

**We take total responsibility.**

Perhaps the single most important part of the Bell System's approach to problem solving is taking total responsibility for the design, supply, installation, maintenance and repair of your communications system.

A communications system designed and implemented by the Bell System is backed end to end by the Bell System.

**Put the resources of the world's largest communications company to work for you.**

No matter what business you're in. No matter where you're located. There are Bell System people ready to meet your needs.

Remember, if you have a problem:

## The system is the solution.



Bell System

# software & services

## Updates

Initial evaluation tests performed on an Intel model AS/5 large-scale computer at Pacific Mutual Life Insurance Co., Newport Beach, Calif. have confirmed the system's compatibility with IBM operating software. According to Clark Hayes and Ken Krum of Pacific Mutual, the AS/5 ran the firm's job stream just as smoothly as it has run on its 370/155 under OS/MVT with HASP. The only change was in performance, with both men estimating that the AS/5 is at least the equal of a 370/158.

The Association for Educational Data Systems (AEDS) has announced plans for its Fourteenth Annual Computer Programming Contest for students in grades 7-12. Deadline for entries is March 1. Entries may be submitted in the following categories: 1) business; 2) biological and physical sciences; 3) computer art; 4) computer science; 5) games; 6) humanities; and 7) mathematics. Details and entry forms are available from AEDS Programming Contest, Dr. Jane Donnelly Gawronski, Dept. of Education, San Diego County, 6401 Linda Vista Road, San Diego, CA. 92111. The grand prize is a \$100 U.S. Savings Bond plus a minimum \$300 travel grant to the 1977 AEDS convention in Fort Worth, Texas on April 25-29.

Management Information Corp. says the Burroughs B80 small-scale system is one of the most important products that will be produced for many years to come by virtue of its performance capabilities, pricing policies, and the total unbundling, including system and application software. MIC has produced an analysis of the B80 priced at \$7.50, available from Box D, 140 Barclay Center, Cherry Hill, N.J. 08034.

If you have a mini system based on Data General equipment with an assortment of peripherals from other manufacturers, you'll soon be able to obtain single-source maintenance on the configuration from Syntonic Technology, a maintenance service of Control Data Corp. based in Pennsauken, N.J. Configurations are now being serviced in the New York and Philadelphia areas, with expansion into major U.S. centers slated for the next 18-24 months. Typical rates charged (in N.Y.C.) are \$24 per hour, or an average of \$300 per month.

## RPG to PL/1 Translation

This vendor, working out of an old house located on a main thoroughfare in a suburb of Buffalo, has specialized over the years in language conversion work. The latest project is a software translator that accepts IBM System/3 RPG II, 360/20 DPS RPG, and 360/370 RPG/RPG II and churns out PL/1 that runs under DOS or OS equipped IBM systems. The basic RPG logic loop is maintained which has the advantage of standardizing the format of converted programs, and the possible disadvantage of not restructuring programs to make use of the later, more efficient programming techniques. Functions that include match record logic, chaining, table and array handling, compile time tables, level control, force function, demand file, and record address files processed within logical limits are all converted. The finished program retains the RPG names and comments. A conversion listing of the original RPG statements aligned with the corresponding PL/1 code is produced as a conversion audit.

The translator is expensive, and at \$40K, it appears the developers really don't want to let it get out of their hands. Two service levels are offered, however, consisting of "clean compilation" (programs converted and ready for testing), and "full implementation" (completely tested programs compared with user-supplied data). The translator can also be leased, and it's claimed that the translator has been thoroughly checked out by a *Fortune 500* user. DATA-WARE INC., Tonawanda, N.Y.

FOR DATA CIRCLE 217 ON READER CARD

## S/32 Packages

A business data processing package of programs developed by a service bureau using IBM System/32 minicomputers is now available to in-house users of the system. Consisting of a payroll inventory control, accounts receivable, general ledger, and accounts payable module, the package is sold complete for \$5K or individually (\$1,500 for the payroll, \$500 for the inventory, and \$1K each for the others). Also offered are fixed-price contracts for modifying/enhancing the routines, and a separate service for creating custom software routines.

Users receive the source code for the programs on a floppy disc complete with a manual—and an agreement that the programs cannot be distributed by the user to other System/32 sites. The

payroll system is fairly comprehensive, even offering automatic deduction cut-offs, multi-pay codes (the ability to pay extra pay during the one pay period without excessive withholding taxes being deducted, etc.), and automatic check, W-2, and 941A generation. The inventory system features 13 month's storage of demand information, re-order, back order, and on-order capabilities, etc. The accounts receivable module can be used as an open item or balance forward record, and can generate statements and invoices if desired. Also featured are a credit limit feature and a minimum payment option. The general ledger module can accommodate any size chart of accounts and does percentage or budget comparisons on income statements. An end-of-year closing program is also included. A/P feature check writing, distribution reports, vendor lists, etc. DIVERSIFIED DATA SERVICES, Columbia, S.C.

FOR DATA CIRCLE 218 ON READER CARD

## Disc Management

Many installations find the management of their direct-access storage devices as complex as that of managing the mainframe and memory's workload. That is the situation PACKMAP attempts to assuage. PACKMAP enables system managers to obtain a picture of the dynamically changing logical structure of direct access volumes. It does this through a graphical reporting mode that provides representations of volume usage and detailed status information. The user can map up to 14 online volumes and ascertain the extents of all datasets on each volume, the VTOC location and size on each volume, the location and sizes of all free space extents on each volume, and the lost space on each volume. Optionally available are the abilities to obtain VTOC listings showing all relevant data attributes about each dataset on each volume, including size and number of extents, and the VTOC (Volume Table Of Contents) data on any number of single datasets, using the catalog if desired. For the \$650 price, the user gets the IBM source code, and documentation (installation and operation). COMPUTER LINGUISTICS INC., Albany, N.Y.

FOR DATA CIRCLE 219 ON READER CARD

## DEC Distributed Processing

It would seem that the ability of the mini manufacturers to remain com-



# asi/inquiry

## The IMS DB/DC QUERY LANGUAGE

USED BY MORE IMS INSTALLATIONS THAN  
ANY COMPETING PRODUCT



ASI/INQUIRY is an IMS DB/DC query language that operates completely as an interactive Message Processing Program. The design of ASI/INQUIRY is such that the *structure of the data base is transparent to the user*. Moreover, one need not have familiarity with DL/1 segment logic or the complexities of multipathing. Extremely rapid response time is assured.

### MAJOR HIGHLIGHTS

- End-user oriented
  - Easy-to-use language
  - Requires no knowledge of IMS
  - Comprehensive diagnostic messages
- Rapid response time for even the most complex queries
- Dynamic priority scheduling to maximize system performance
- Availability of default as well as user-defined screen formatting

Recently delivered, Release 2 of ASI/INQUIRY contained a number of major enhancements, including:

- Development of a TSO-supported version
- Full support of IMS/VS secondary indexing
- Open-ended computational facilities
- Ability to SORT display output

In summary, ASI/INQUIRY represents the state-of-the-art product in an IMS DB/DC or TSO-supported IMS environment. It is the only system combining an easy to use language, complete user flexibility, and rapid response time in a single package. If you want to start answering "What if . . . ." immediately, call or write today for further information.



The Software Manufacturer

Applications Software, Inc.  
Corporate Offices  
21515 Hawthorne Boulevard  
Torrance, California 90503  
(213) 542-4381

# software & services

petitive in IBM installations in light of the IBM Series/1 announcement will hinge to a great degree on the software capabilities the minis can be endowed with. DEC seems to realize this and has announced a software interface that allows the DEC 350 small business system to tie on to IBM 360/370 mainframes and provide the user full interactive distributed processing. Communications procedures between the DEC DATA-SYSTEM and the 360/370 mimic those of the IBM 3271 remote keyboard display and printer controller, a common item. DICAM is the name of the software product, which allows application programs written in Digital's COBOL-like DIBOL to interact with the mainframe. Typical users are thought to include manufacturers, utilities, banks, medical institutions, and wholesale/retail companies in order entry, inventory, billing, consumer information payroll and similar applications. The product, which runs under DEC's CTS-300 operating system has a license price that starts at \$4,500. For those not familiar with DEC's DATASYSTEM family, the machines include the popular PDP-11, support of crt terminals, printers, and

mass storage devices ranging from 512K bytes of floppy disc storage to 112 megabytes of removable disc cartridge capacity. DIGITAL EQUIPMENT CORP., Maynard, Mass.

FOR DATA CIRCLE 221 ON READER CARD

## 8080 Assembler

BSAL-80 might just be different from other assembler language programs you've seen offered for the Intel 8080 microprocessor or 8080 development systems. BSAL stands for Block Struc-

## software spotlight

### Privacy Compliance Model

It's budget time, right? And you've probably been wondering how much to pencil in on the line that reads "changes necessary to comply with the Dept. of Health, Education and Welfare's 19 privacy criteria." It's bound to cost a lot of time and effort, but what figure can be developed to make the entry meaningful?

For a relatively small fee, this firm offers access to a computer model that can determine the approximate costs and impact of both local and national privacy legislation. It's claimed that optimistic, best, and worst case figures

can be determined with the model. Input to the model is in the form of 60-70 descriptions of file contents, record sizes, number of staff programmers, their average cost/hour, etc. One of the model's first users, a bank, discovered "to its horror" it was supplying unneeded confidential information to an outside party by supplying them with what it thought to be a relatively innocent information file. The model is written in ANSI FORTRAN IV, requires about 44K bytes of storage, a card reader, and a 132-column printer for generating reports. It's priced at \$5K. Services based on the privacy model are also offered, priced at \$3K for the first run and somewhat less (to be negotiated between user and vendor) on subsequent passes. FIDUCIARY PROCESSING, INC., New York, N.Y.

can be determined with the model.

can be determined with the model. Input to the model is in the form of 60-70 descriptions of file contents, record sizes, number of staff programmers, their average cost/hour, etc. One of the model's first users, a bank, discovered "to its horror" it was supplying unneeded confidential information to an outside party by supplying them with what it thought to be a relatively innocent information file. The model is written in ANSI FORTRAN IV, requires about 44K bytes of storage, a card reader, and a 132-column printer for generating reports. It's priced at \$5K. Services based on the privacy model are also offered, priced at \$3K for the first run and somewhat less (to be negotiated between user and vendor) on subsequent passes. FIDUCIARY PROCESSING, INC., New York, N.Y.

FOR DATA CIRCLE 216 ON READER CARD

# MVS Users

## DYNAMIC RESOURCE ALLOCATION IS HERE!

**R**eact dynamically to resource allocation demands.

**E**xtend CICS availability, reliability and productivity.

**A**llow resource sharing between CICS and other processing.

**C**ost-efficient distribution of available I/O resources.

**T**otal CICS/MVS environment control.

REACT (Resource Allocation Control Tool)

**S**ON-LINE  
SOFTWARE  
INTERNATIONAL

Software Plaza  
Route 208 North  
Hawthorne, N.J. 07506  
(201) 423-3200

## PROGRAMMERS AND ANALYSTS

### Free Employment Service

#### Serving Northeast, Southeast and Midwest U.S.

- Scientific and commercial applications
- Software development and systems programming
- Telecommunications
- Control systems
- Computer engineering
- Computer marketing and support

Call or send resume or rough notes of objectives, salary, location restrictions, education and experience (including computers, models, operating systems and languages) to either one of our locations. Or check the reader service card for a free sample resume. We will answer all correspondence from U.S. citizens and permanent residents and will guarantee our best efforts in a professional and ethical manner to all qualified applicants that we think we can help. Our client companies pay all of our fees.



RSVP SERVICES, Dept. M  
Suite 700, One Cherry Hill Mall  
Cherry Hill, New Jersey 08002  
(609) 667-4488

RSVP SERVICES, Dept. M  
Suite 300, Dublin Hall  
1777 Walton Road  
Blue Bell, Penna. 19422  
(215) 629-0595

## RSVP SERVICES

Employment Agency for Computer Professionals



## They love me...they love me not...

Terminal manufacturers can be very fickle. Warm and tender when they write the order, most grow cold and unresponsive when you need service or repairs.

Trendata doesn't care for love-hate relationships. We're looking for something more meaningful, more fulfilling. So we offer you no-cost terminal evaluation, nationwide service by our representatives (not someone else's), one of the broadest range of terminals and peripherals



available, and a wide variety of purchase, lease and rental programs.

And because our customer affection is boundless, we offer you all the supplies and accessories you need—ribbons, type elements, tape cassettes, copy holders, acoustic cabinets and forms stackers.

If you're having trouble communicating with your computer or computer terminal representative, call or write Trendata for a rendezvous.



610 Palomar Ave., P.O. Box 5060,  
Sunnyvale, CA 94086 (408) 732-1790

 AN APPLIED MAGNETICS COMPANY

# software & services

including ADD, DELETE, LIST, FIND, REPLACE, MODIFY, GATHER, KEEP and SET commands. BSAL-80 is provided in both 8080 resident and FORTRAN IV cross assembler versions. The assembler/loader is priced at \$975 and the text editor at \$350, or both for \$1,250. The FORTRAN IV cross assembler version is priced at \$1,250. MUPRO INC., Sunnyvale, Calif.

FOR DATA CIRCLE 220 ON READER CARD

## Inquiry/Response

The term "management information system" fell from favor several years ago when developers couldn't deliver on their promises, but MIS has been quietly making a low profile comeback. The concept of providing non-dp-oriented management with near real-time decision information shows up now and again in products like this package, called On-Line Query, which works with the developer's IDMS Data Base Management System to provide key indicator information from IDMS files. Key indicators can mean many things to different businesses, but can for example represent daily cash po-

sition, installations-to-date, sales projections for the coming month, etc. No programming knowledge on the user's part is said to be required; English-like commands are used. The package works in SHADOW II, CICS, and TSO environments and includes the inquiry/-response capabilities; the English-like Query language; multiple access methods, including direct, sequential, and set-related retrieval capabilities; and automatic record editing according to data base limits. Average response times run approximately three seconds. Release 1 costs IDMS users \$9K; the package has completed beta testing at five user sites. CULINANE CORP., Wellesley, Mass.

FOR DATA CIRCLE 222 ON READER CARD

## Small System Conversion

If you are a Datapoint user who is outgrowing the system's capacity, this recent entrant into the commercial systems field has an interesting proposition for you: it will equip you *free* with a translator called UHURU (the Swahili word for freedom) for converting DATASHARE or DATABUS programs from the Datapoint system. Conversions are also offered as a service for programs stored on media (such as floppy discs) not supported by the SyFA system. The developers claim the translator easily handles the first 90% of the conver-

sion, with some analyst help required for the remainder, though a spokesman states that customers say the program does somewhat better. Both DATA-SHARE and DATABUS are COBOL-like languages, as is the target language SYBOL, enough so that it's claimed a COBOL programmer can feel right at home with SYBOL in about a week. The idea behind all this is that SyFA systems can be expanded by Datapoint system users up to configurations that would include more than 304K bytes of storage, up to 24 terminals, two line printers, and 640 megabytes of disc capacity. COMPUTER AUTOMATION, INC., Irvine, Calif.

FOR DATA CIRCLE 223 ON READER CARD

## Language/File Conversion

Convert is offered on this vendor's nationwide time-sharing network for converting several high-level languages into other languages (or different forms) and perhaps more importantly converting file organizations. The conversion library currently consists of descriptors for translating SBC BASIC to XBASIC, IBM FORTRAN IV to IBM OS PL/1 Optimizer and Univac 1108 FORTRAN IV to IBM FORTRAN IV. Rule sets are written in the Convert language, and, once developed, can be used repeatedly for any program within that class. The developers are claiming a breakthrough in the package's

Get embedded

DIGITAL EQUIPMENT CORP. DATA GENERAL CORP.

# PDP-11 & NOVA

USERS... GET THE BEST TAPE AND DISC CONTROLLERS

- Available for virtually all tape and disc drives.
- (Tape) Mix PE and NRZ formats, 7 or 9 track, 8 drives.
- (Disc) Front load, top load or 10-high, up to 100 megabyte.
- DEC and DG software compatible.

SEND FOR COMPLETE INFORMATION

**western peripherals™**

(714) 991-8700 • TWX: 910-591-1687 • Cable: WESPER  
1100 Claudina Place, Anaheim, CA 92805

CIRCLE 117 ON READER CARD

1977 REGISTRATION NOW OPEN  
CERTIFICATE IN DATA PROCESSING EXAM

Prepare for Complete 5-Section ICCP Test with  
**CERTIFICATE IN DATA PROCESSING EXAMINATION**  
By James W. Morrison

Now recognized internationally, the CDP Exam is given throughout the U.S. and Canada. The coveted Certificate leads to professional advancement and monetary rewards. This comprehensive study guide, with its practice tests and detailed answers, concentrates on the full five sections—equipment, programming and software, principles of management, quantitative methods, and systems analysis and design. Within these sections, the full range of knowledge tested by this exam is covered: computers and peripheral equipment; evolution of EDP; computer components and functions; input-output media; COBOL; loops; meta programming systems, etc., etc. An information section on the Exam includes cost of the Exam, its personal and professional value and a discussion of the entire field of data processing. This 465 page professional level study guide, containing 900 questions, is a must for this vital, 5-section test. The book is paper bound for easy handling and measures 7 1/4" x 10 1/4".

Send \$12.00 (plus 50c for postage and handling) to:

ARCO PUBLISHING CO., INC., Dept. DM,  
219 Park Ave. South, New York, N.Y. 10003

CIRCLE 84 ON READER CARD

**DATAMATION**

ability to handle subtle syntax differences in the languages and handle virtually any file organization. Current charges for accessing Convert are \$10/hour connect time for 10 cps terminals, \$13/hour for 30 cps terminals, and 20¢ per "Virtual Processor Unit" which is a way of equalizing cpu/memory charges between the supplier's stable of IBM and Amdahl mainframes. NATIONAL CSS INC., Norwalk, Conn.

FOR DATA CIRCLE 224 ON READER CARD

### IBM Networking

With the addition of a series of software programs or enhancements, IBM will be able to offer its customers far greater networking capabilities in the fourth quarter of this year (or early 1978) than it can today. The networking capabilities finally fill out some of the structure hinted at in IBM's System Network Architecture announcement of two years ago, and finally go a long way toward realizing the full potential of the 3705 communications controller.

The software modules necessary for networking include:

1. The Advanced Communications Function/Virtual Telecommunications Access Method (ACE/VTAM), and Advanced Communications Function/Telecommunications Ac-

cess Method (ACF/TCAM) access logic that provides programming connection between host applications and remote terminal users at single system networks.

2. Multisystem Networking Facility, an optional feature for the above for multisystem (up to four) networks that basically attends to the

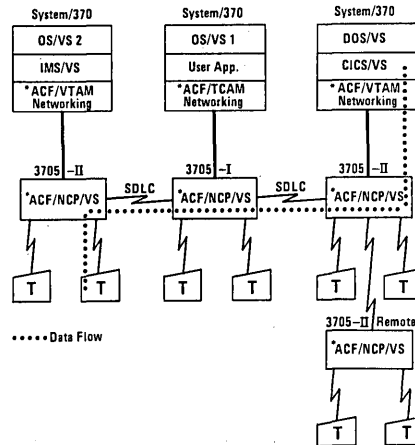

transparent interchange of information from one host to another.

3. ACF/NCP/vs, initials that should look familiar to any 3705 user. This module resides in the 3705 and works with the access method to manage the network and to route data between terminals and cpu's.

It boils down to the ability to have users physically attached (by terminal or application program) to one cpu access programs resident in up to three other mainframes (one other mainframe if a 3705 mod 1 is used). Prices for the various modules range from \$125 up to \$800 for the multisystem capability. IBM CORP., White Plains, N.Y.

FOR DATA CIRCLE 225 ON READER CARD

### Honeywell S/W

Honeywell might be edging into the network architecture picture alongside IBM and Univac if we interpret the announcement of a COBOL compiler and a BASIC interpreter for its Series 60 Level 6 minicomputer family correctly. The COBOL compiler is a subset of ANSI-74 COBOL and is upward compatible with Series 60 level 66 COBOL. The compiler features file handling capabilities, including open, close, read, write, rewrite and delete commands, table handling, subscribing or indexing to three levels support of the SET statement, and full editing facilities. It's priced at \$2,750.

The interpreter operates in an interactive conversational environment in which a user composes, edits, debugs, and executes programs. It also functions in a production mode which is nonconversational. BASIC data files can

## EDP SEARCH

### WHY IS FOX-MORRIS THE FIRST CHOICE OF EDP PROFESSIONALS?

A recognized staff of professional experts offering LOCAL, REGIONAL & NATIONAL COVERAGE through our direct branches as well as coast to coast coverage through our 75 member firms of National Personnel Consultants, Inc.

Completely confidential service geared to your career objectives. Unparalleled contacts with industry based on years of successful results. Professional resume evaluation and career guidance. Client companies assume all employment costs—including interview expense, relocation (if necessary) and search fee. SEND RESUME DIRECT, OR CIRCLE NUMBER BELOW ON READER CARD.

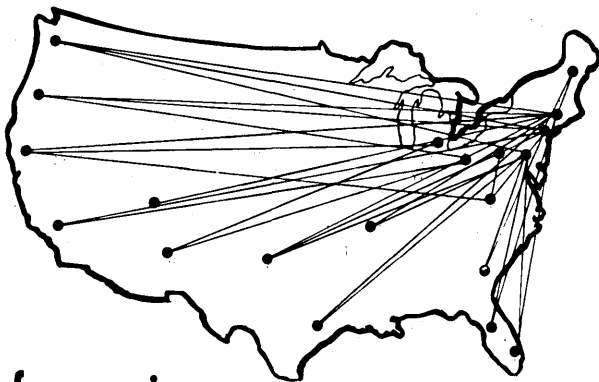

### fox-morris personnel consultants

Philadelphia: (215)561-6300, 1500 Chestnut St., Philadelphia, Pa. 19102  
New York: (212)697-1820, 605 Third Ave., New York, N.Y. 10016  
Pittsburgh: (412)232-0410, 6 Gateway Center, Pittsburgh, Pa. 15222  
Wilmington: (302)654-4465, 2005 Concord Pike, P.O. Box 7017, Wilm., Del. 19803  
Princeton: (609)452-8135, 3490 U.S. Rt. 1, Princeton, N.J. 08540  
Baltimore: (301)296-4500, 409 Washington Ave., Baltimore, Md. 21204  
Charlotte: (704)527-4980, 4000 Park Road, Charlotte, N.C. 28209  
Atlanta: (404)321-3888, 2200 Century Pkwy., N.E., Atlanta, Ga. 30345

CIRCLE 122 ON READER CARD

## Even Webster's Knows About QUEST

**QUEST** (kwest). v. 1. To make a search; to go on a quest.

**QUEST SYSTEMS, INC.** n. 1. A corporation founded in 1968. 2. The largest professional recruitment firm in the U.S. functioning solely in the computer sciences; its client companies pay all employment fees, interviewing and relocation expenses. Quest is known for its deep personal commitment to relate to each candidate as an individual with individual goals. 3. Its professional staff averages over 6 years of experience in EDP recruiting (additionally, staff members have direct hands-on experience in programming, systems, hardware sales, etc.) 4. Quest is presently searching for programmers and analysts (commercial, scientific, systems software) for over 3,500 client companies in the U.S. Quest has openings in over 700 U.S. towns and cities. 5. Methodology — see Questsystem.

**QUESTSYSTEM** (kwest sis'tem). n. 1. Discussing with an individual what he would like to be doing in light of what he has been doing. 2. Analyzing the realities of his objectives as they relate to the current job marketplace. 3. Contacting client companies and other Quest staff personnel to identify positions of possible interest. 4. Introducing the job candidate to his prospective employers by providing complete details to each about the other, ensuring the efficacious use of everyone's time. 5. Arranging interviews. 6. If employment offers are extended, Quest assists in evaluating the responsibilities, compensation and opportunities (and relates those to the initially stated objectives). The Questsystem has been working for thousands of professionals at no expense, whatsoever. Ask your friends of their past dealings with Quest. Then, put the Questsystem to work for you. For additional information on this subject, please inquire directly to Quest Systems, Inc. (All inquiries/resumes received will be responded to immediately and in confidence.)

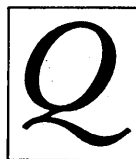

**QUEST SYSTEMS INC.®**

6400 Goldsboro Road  
Washington, D. C. 20034 (301) 229-4200

Baltimore: (301) 265-1177 • Philadelphia: (215) 667-3322

CIRCLE 127 ON READER CARD

# software & services

be interchanged with level 6 FORTRAN routines. The BASIC license fee is \$500. Both products require at least 16K 16-bit words of memory together with a disc or dual diskette and teleprinter-compatible console device. HONEYWELL INC., Waltham, Mass.

FOR DATA CIRCLE 226 ON READER CARD

## System/3 Model 8 Spooling

There must be scores of System/3 Model 8 users who would ante up a maximum of \$75/month to increase system throughput a full 25%. That's the claim made for this spooling package, coming from a manufacturer that has enjoyed huge success in the System/3 market. The only possible conflict in the use of SPOOL/8 is with scheduling requirements, for the package basically resequences the job stream to intersperse heavy output programs with cpu burners. Also, a site must have at least 7K of memory, a model 750, 550, or 400 printer from this manufacturer, and S/3 Mod 10 software. (Dual programming is not required and either BST or IBM tape drives can be used with SPOOL/8.) If

you have the BST drives, however, your rental on the software drops to \$25/month. The package can be halted or canceled and a printout repeated in its entirety by simply dialing the proper instructions on the cpu's data address switches. Each program's print file is maintained on disc, so that operators can halt one program, print another, or repeat printouts out of sequence. BUSINESS SYSTEMS TECHNOLOGY, INC., Santa Ana, Calif.

FOR DATA CIRCLE 227 ON READER CARD

## Fortran Debugging

TRACER, though a machine-independent FORTRAN debugging aid, is set up to help DEC PDP-11 and Data General Nova/Eclipse users get the high-level language sorted out. As programs execute, TRACER shows the programmer the values of variables when they are assigned, the values of IF statement expressions when they are computed, the statement number of labeled statements when executed, and the values of subroutine arguments upon entry. TRACER is invoked by inserting a TRACE statement in the FORTRAN source program. The diagnostic information can vary from a short trace of one variable for the span of only a few statements to a full trace of a complete program. Multiple TRACE statements can appear in the source program to

turn TRACER on and off. TRACER assumes that the user's source program is syntactically correct and causes no compile time errors. Complete with documentation package, an executable form of TRACER is delivered for \$1,200. INFORMATION PROCESSING TECHNIQUES, Palo Alto, Calif.

FOR DATA CIRCLE 228 ON READER CARD

## DOS Documentation

The Data Correlation and Documentation System (DCD) is now available to users of IBM's DOS and DOS/VS operating systems looking for a more efficient way of maintaining and modifying COBOL programs. The package documents the usage of every data item, record and file, including where it comes from, where it goes, how it is processed, how it relates to other files, records and/or data items within the program, etc. The program analysis data is then listed just where a programmer would seem to want it . . . right beside the compile listing, and in a narrative form. DCD documents and links all entry and exit points within the COBOL Procedure Division, and also provides the option of creating complete layouts of files, records and working storage data within the program. The package is priced at \$8K. PSI-TRAN CORP., Arlington, Va.

FOR DATA CIRCLE 229 ON READER CARD

\*

## \*\*OUTSTANDING OPPORTUNITIES\*\*

### in Data Processing (Milwaukee Area)

We have a wide variety of positions available, including: Systems Analysts, Sr. Programmers, Programmer/Analysts, Analyst-Trainer, Installation & Repair of Systems, etc.—Entry level also.

ALL FEES EMPLOYER PAID

Call Collect Today

414/276-4554



**BARNHILL, HAYES & CROSBY, INC.**

633 W. Wisconsin Ave., Suite 310

Milwaukee, Wisconsin 53203

A Licensed Employment Agency

## SR. SOFTWARE ANALYST FOR SIMULATION MODELS

To design and develop simulation models of retail Point-of-Sale terminal systems including the interpretation of the system hardware, software, and utilization requirements as they relate to design, development, validation and application of models. Will perform desk top analysis to obtain information required for validation of simulation models. 3-5 years experience with micro/mini processor systems and communication network with at least a year's work with GPSS. An appropriate degree will round out your qualifications.

**NCR's Point-of-Sale division in the hills of east central Ohio offers excellent professional work opportunities and we invite your consideration at your earliest convenience.**

**Robert W. Donovan**

**Terminal Systems Division-Cambridge**

**NCR Corporation**

**Box 728**

**Cambridge, Ohio 43725**

**Phone: 614/439-0398**

An Equal Opportunity Employer

## cou-ri-er ter-mi-nal sys-tem/

'kûr-e-ər, 'tərm-nəl, 'sis-təm/ n. [Est. 1969, Phx., AZ U.S.A.]:

A versatile family of communications devices compatible with any system supporting the 3270 without application software or operating system modification.



270 Display Terminal

**1. The 270 Information Display System.** **a: Terminals**—choice of 270 Display, 278 Mini-Display, and 275 Stand-Alone. **b: Controllers**—choice

of local, remote, and the new Virtual Terminal Line Controller (VTLC). Both the local and remote controllers are available in redundant configurations. The VTLC relieves the

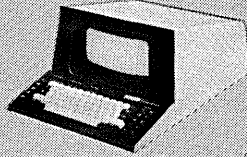

Mini-Display Terminal

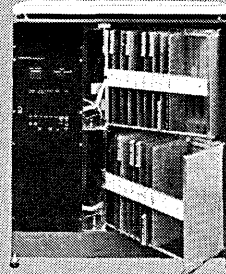

Controller

mainframe of many remote line control functions. **c: Printers**—choice of printer speeds from 100 cps to 200 lpm. **2. Superior performance.**

Equipment installed throughout the United States, Canada, Australia, Austria, Belgium, France, Germany, Great Britain, South Africa, Sweden, Switzerland, and The Netherlands. **3. Reliability.** Field service support worldwide.

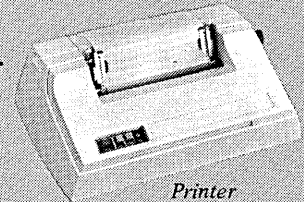

Printer

# Courier

**Courier Terminal Systems, Inc.**

2202 East University Drive ■ Phoenix, Arizona 85034  
(602) 244-1392 ■ TWX: 910-951-0685

DOMESTIC/INTERNATIONAL/OEM

**At Courier,  
we know the meaning of systems.**

# The Marketplace...

## advertisers' index

### SOFTWARE MARKETPLACE

Dataware Inc. ....	192
Diversifieddata Services .....	192
Manchester Equipment Company, Inc. ...	192
Mathematics Products Group.....	192
National Technical Information Service..	192
Software International .....	193
Technology Transfer Incorporated..	192
Westinghouse Electric Corporation.....	192

### DP MARKETPLACE

American Used Computer Corporation... 194	
National Computer Rental .....	193
S/3 Supply Company .....	193
Technicolor Graphic Services, Inc. ....	194
John Toellner & Associates .....	193
TransNet Corp. ....	193

### SOFTWARE MARKETPLACE

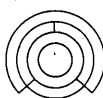

## ramis<sup>®</sup> AN INTEGRATED FAMILY OF DATA BASE SYSTEMS

**RAMIS** provides all the facilities needed for the economical design and operation of information systems in batch, remote job entry and time-sharing environments.

- Complete and automatic data base management technology
- An English-like language for report preparation
- A nonprocedural language for processing and validating transactions
- A data base interface for procedural languages
- An executive to control complex sequences of RAMIS routines

**RAMIS** lets DP professionals build complex systems in one-fifth the time while permitting management staff to tap corporate data bases without putting unnecessary pressure on the DP department.

Write: Mathematics Products Group  
P.O. Box 2392 Princeton, N.J. 08540  
or call: (609) 799-2600

CIRCLE 140 ON READER CARD

### COMPUTER SUPPLIES INVENTORY

The computer supplies inventory system provides an orderly and accurate method for maintaining an inventory of computer supplies or most any other item that may be given a number. The system permits the user to exercise close control of inventory. In today's tight paper market, this system can be of great value to the data processing manager allowing him to control costs and order items based on history and usage information. The computer supplies inventory system has a complete file maintenance and reporting capabilities and provides inventory valuation automatic order and usage data and vendor and receiving information. The reports produced by this system are: vendor, inventory stock status, inventory transaction, edit and file maintenance, new orders, stock received, stock usage, outstanding orders, inventory WTD, MTD, and YTD usage and dollar costs reports. This system is written in ANS-COBOL and is sold in source program form. The purchase price of the system is \$1,500 and includes complete comprehensive user documentation, installation instructions, and optional onsite installation support. The computer supplies inventory system is currently being used by more than 15 companies in the United States.

**diversified**  
data

240 Stoneridge Road, Suite 406, Columbia, South Carolina 29210—Phone: 803-798-2876

CIRCLE 136 ON READER CARD

### RPG/RPGII TO COBOL

Package accepts Sys/3 RPGII, MOD 20 DPS RPG, 360/370 DOS and OS RPG and can produce either DOS or OS ANS COBOL. Inherent functions such as Match Record, Chaining, Subscripting, as well as Table Handling are converted by the system. A cross-reference worksheet of the original RPG statements aligned with the resulting COBOL is produced. Dataware offers 2 service forms: Clean Compile and Full Implementation. Lease and License are also available.

We also have translators for:

Autocoder/SPS-To-COBOL  
Easycoder/Tran-To-COBOL  
BAL/ALC-To-COBOL  
PL/1-To-COBOL  
Autocoder (7070)-To-COBOL  
COBOL-To-COBOL  
RPG/RPGII-To-PL/1



## DATAWARE INC.

495 Delaware St., Tonawanda, N.Y. 14150  
(716) 695-1412

CIRCLE 137 ON READER CARD

### AUTOCODER-TO-COBOL

The system converts source Autocoder (1401, 1440, 1410, 7010, and SPS) to ANS COBOL (DOS or OS). The converter uses a unique method to examine and interpret source code before producing COBOL. Converter features are:

- HANDLES COMPLEX LOGIC CODE; USER MACROS; INDEXING AND CHAINING
- LISTING OF THE OUTPUT COBOL VS SOURCE STATEMENTS (SIDE-BY-SIDE)
- SOURCE NAMES & COMMENTS ARE PART OF THE COBOL PROGRAM
- PROVIDES 90%++ SOURCE CONVERSION

Dataware offers 2 service forms: Clean Compile and Full Implementation. License and Lease are also available.



## DATAWARE INC.

495 Delaware St., Tonawanda, N.Y. 14150  
(716) 695-1412

CIRCLE 138 ON READER CARD

### Reduce your tabulation costs with CENTS-AID II

This fully tested, high speed, cross tabulation computer program package is just what you need. CENTS-AID II lets you minimize the costs of data processing for large and small universes...reduce the storage required... and cuts time required by the computers central packaging unit.

The CENTS-AID II Program Package includes tape, CENTS-AID II Programmer's Notebook, and User's Manual.

Order CENTS-AID II today--PB-244 975/CPM \$500 (\$625 outside North American continent) from:

**NTS** National Technical Information Service  
U. S. DEPARTMENT OF COMMERCE  
5285 Port Royal Road  
Springfield, Va. 22161

For more information on this and other computer products contact Frank Leibsly at (703) 557-4763 or write him at the address above.

CIRCLE 142 ON READER CARD

### We Stock for IMMEDIATE DELIVERY UNCOMMON & HARD-TO-FIND

Computer Disk Packs:

**CDC-9883-91**

**CDC-9877-80MB**

**UNIVAC-8418**

**CALCOMP T300, T80**

**BASIC FOUR 700 (T50)**

**HONEYWELL 451**

Order Direct, Write, Wire, Call:

**MANCHESTER**

EQUIPMENT COMPANY, INC.

120 Beth Page Rd. • Hicksville, N.Y. 11870

**(212) 564-6065**

Suppliers of ALL Computer Disk Packs

CIRCLE 139 ON READER CARD

## FIVE DYNAMIC 3-DAY SEMINARS

WASHINGTON, D.C.

COMPUTER  
SEMINARS  
PRESENTED  
BY THE  
WORLD'S  
LEADING  
AUTHORITIES

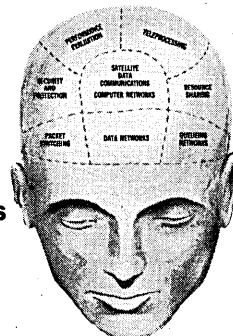

**KLEINROCK**  
QUEUEING SYSTEMS  
February 16-18, 1977

**FRANK**  
SURVIVING THE DATA  
COMMUNICATIONS  
EXPLOSION  
February 23-25, 1977

**ABRAMSON**  
and Cacciamani  
SATELLITE DATA  
COMMUNICATIONS  
March 2-4, 1977

**DENNING**  
UNDERSTANDING  
PERFORMANCE  
EVALUATION  
March 7-9, 1977

**KLEINROCK**  
COMPUTER NETWORKS  
March 23-25, 1977

For information, please write or call:

**TECHNOLOGY  
TRANSFER  
INCORPORATED**

P.O. Box 49765, L.A., CA 90049 (213) 476-1331

CIRCLE 145 ON READER CARD

**DATAMATION**



## JOB ACCOUNTING

The Westinghouse Job Monitor is a low cost accounting system designed to inform you on a daily basis how your computer is being used and how to make better use of the system's resources. Job Accounting information for DOS, DOS/VS, and/or POWER/VS is captured and put into comprehensive reports which provide systems, operations, and management personnel with the following information: (1) chronological reports showing daily activity of job streams, (2) Daily partition utilization, (3) CPU hourly activity, (4) Graphic analyses of overload conditions and machine and device availability, (5) Start I/O by device, paging by job and resource usage summaries, (6) 30-day statistical summaries, and (7) POWER/VS statistics by day and job for users of POWER/VS Accounting. The complete package is provided requiring no special education or programming costs and no dedication of hardware units. One time charge for purchase and free trial available.



Operating Software Packages  
**Westinghouse Electric Corporation**  
 2040 Ardmore Boulevard  
 Pittsburgh, Pa. 15221  
 (412) 256-5583

CIRCLE 148 ON READER CARD

## Get the famous MMS General Ledger and Financial Reporting Systems

or Payables, Receivables,  
Payroll, Net Change MRP

- Over 500 Users
- 90 Fortune's 500 Companies
- Automatic Budget Generation
- Cost Accounting
- Exception/Variance Reporting
- Statistical Accounting
- Graphics . . . and more

## SOFTWARE INTERNATIONAL

Elm Square, Andover, Mass. 01810 (617) 475-5040  
 New York (914) 332-0040 Chicago (312) 729-7410  
 San Diego (714) 292-9833 Toronto (416) 862-0521  
 Philadelphia (302) 995-7101 Dallas (214) 233-5856  
 Washington, D.C. (301) 770-6460

CIRCLE 143 ON READER CARD

## SPECTRUM 1

### DISTRICT SALES REPRESENTATIVE

J. Toellner & Associates seeking regional sales representation in selected markets throughout U.S.A. for SPECTRUM-1. SPECTRUM-1 is a new project management system for use in major DP centers. The product has a proven sales record and solid market acceptance. Liberal commissions will enable representative to earn substantial income in first year. This is an excellent opportunity for a person/company experienced in DP sales. For further information contact

John Toellner, Managing Director  
**J. TOELLNER & ASSOCIATES**  
 4311 Wilshire Blvd.  
 Los Angeles, Calif. 90010  
 (213) 931-1127

CIRCLE 147 ON READER CARD

## DISK UTILITY SYSTEM

Referred to by DATAPRO as "among the best liked software products in the EDP industry," the success and satisfaction of this product is clearly evidenced by more than 2,500 installations to date. The product provides users with a fast, reliable and easy to use means of backing up or copying disk files (including libraries) and data bases, either to tape or disk and time savings. In general, the programs can dump multiple disk volumes and/or files of different organizational structure to tape, can selectively restore any file or volume dumped to tape and can copy complete volumes and/or files from disk to disk.

Features of the product include full verification of data, self relocation for running in any or all partitions, ISAM reorganizations and re-blocking VSAM support, device independence among all IBM supported disk devices and equivalents, self adaptation to core and channel configurations, simple format parameter card input and library backup, condense and reorganize capabilities including selective bookname restore offer considerable operation convenience and time savings.



Operating Software Packages  
**Westinghouse Electric Corporation**  
 2040 Ardmore Boulevard  
 Pittsburgh, Pa. 15221  
 (412) 256-5583

CIRCLE 149 ON READER CARD

## DP MARKETPLACE

### INTRODUCING THE FIRST SHORT-TERM IBM 370 LEASE!

- National Computer Rental now offers the first 24 to 48 month "walk-away" leases on IBM 370/138 and 370/148 systems. Plus . .
- The Most Attractive Lease Rates in the Industry.

CONTACT:  
 T. J. McArdle, President  
 National Computer Rental  
 Ltd.  
 415 Madison Ave.  
 New York, N.Y. 10017  
 CALL COLLECT:  
 (212) 532-1500

National Computer Rental  
 Member of Tiger Leasing  
 Group  
 C.L.A.—member of  
 Computer Lessors Asso.



CIRCLE 141 ON READER CARD

## WESTI TP-INTERFACE

The Westinghouse Teleprocessing Interface System provides a low cost, low overhead, easy-to-use interface for local/remote 2260/3270 type display terminals operating in a DOS or DOS/VS environment.

The monitor portion of the system manages all terminals, application programs, user core areas, disk work space, display screen files, user work areas and handles all error correction. The system can control up to 255 terminal devices and application programs and operates in a single terminal environment, multi-terminal mode enabling many terminals to communicate with the same application simultaneously or in a special multi-copy mode.

Special functions included in the monitor are high speed roll-in/roll-out, data base independence, the ability to run as a subtask, enqueueing, logging, and a collection of supportive utilities. The monitor itself can be generated to operate in as little as 2K of real core on a virtual system.



Operating Software Packages  
**Westinghouse Electric Corporation**  
 2040 Ardmore Boulevard  
 Pittsburgh, Pa. 15221  
 (412) 256-5583

CIRCLE 150 ON READER CARD

## COMPU COVER®

PAT PEND

360/370, SYS 3, SYS 32

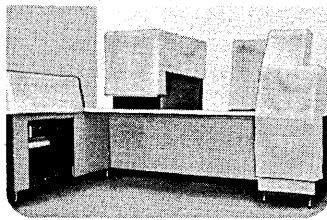

WHY TAKE CHANCES WITH

**SPRINKLER SYSTEMS**  
**ROOF LEAKS**  
**DRAIN PIPES**  
**WATER LINES**

**S/3 SUPPLY COMPANY**  
 P.O. Box C  
 Rutherford, N. J. 07070

CIRCLE 144 ON READER CARD

## DECwriter II

MODEL LA36 PRINTER TERMINAL  
 10-15-30 CHARACTERS PER SECOND  
 REMOTE OR CONSOLE USE  
 132 PRINT POSITIONS

**\$1,645 each**

## DECscope

VIDEO DISPLAY TERMINAL  
 MODEL VT50 12 LINES, 80 CHARACTERS

**\$1,095 each**

MODEL VT52 24 LINES, 80 CHARACTERS  
 NUMERIC PAD • HOLD-SCREEN MODE

SPECIAL FEATURES

**\$1,795 each**

## DECprinter I

MODEL LA180 HIGH-SPEED PRINTER  
 180 CHARACTERS PER SECOND  
 132 PRINT POSITIONS

**\$2,795 each**

100% EQUITY RENTAL PLAN  
 DECwriter \$150 month  
 VT50 DECscope 100 month  
 VT52 DECscope 165 month  
 DECprinter 260 month  
 FULL OWNERSHIP AFTER 12 MONTHS

QUANTITY DISCOUNTS  
 AND LEASE PLANS AVAILABLE

OPTIONAL FEATURES  
 INSTALLED WITHOUT CHARGE

WE ALSO MARKET ACOUSTIC COUPLERS  
 AND DIGITAL CASSETTE UNITS



**TRANSNET CORP**

2005 ROUTE 22, UNION, N.J. 07083  
 201-688-7800

CIRCLE 146 ON READER CARD

(Continued on page 194)

**What's available?  
Is it effective?  
Buy off-the-shelf?  
Or develop in-house?  
What comes next?**



To help you find the answers to these and similar problems, the CAD Centre has organised a major international conference bringing together experienced users of interactive graphics-based design systems and the main suppliers of those systems so that you, as a delegate, can get a complete state-of-the-art report and have an unparalleled opportunity to get REAL ANSWERS TO YOUR QUESTIONS.

**Stratford-upon-Avon Hilton 13-15 April 1977**

For details please contact:  
Miss Clare Nightingale,  
Computer Aided Design Centre,  
Madingley Road, Cambridge CB3 0HB  
Telephone Cambridge (0223) 63125 Telex 81420

CIRCLE 118 ON READER CARD

## A CHALLENGE IN ADVANCED STATE-OF-THE-ART

NCR's Terminal Systems Division at Ithaca, New York is continuing its rapid expansion as a leader in the data terminal industry. Located in New York's scenic Finger Lakes region, we offer an exceptional living environment of a growing, yet peaceful and sophisticated university town atmosphere coupled with bountiful educational and recreational facilities.

### Systems Analysts and Programmers For Development and Testing

- **Communications:** asynchronous and synchronous terminals, protocol, SDLC
- **Knowledge of operating systems;** peripheral drivers, file management, systems generator
- **Knowledge of microprocessors a plus**
- **Requires a BS Computer Science or related degree plus 3-7 years experience**

If you can meet our kind of challenges and want an outstanding compensation and benefits package, please send a current resume, including salary history and requirements. Relocation assistance, if hired. Please write:



An Equal Opportunity Employer

Michael A. Friedenberg  
Professional Recruitment  
Terminal Systems Division  
NCR Corporation  
950 Danby Road  
Ithaca, N. Y. 14850

## CENTRONICS PRINTERS

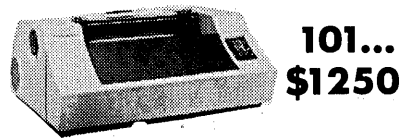

101...  
**\$1250**

ALSO IN STOCK

101A, 101AL, 101S, 102A,  
102AL, 301, 306, 308, 500,  
501, 508

**AMERICAN USED COMPUTER  
CORPORATION**

**617-261-1100**

P.O. Box 68, Kenmore Station, Boston, MA 02215

CIRCLE 135 ON READER CARD

## DIGITAL IMAGE ENHANCEMENT SPECIALIST

Technicolor Graphic Services, Inc., at the Earth Resources Observation Systems (EROS) Data Center has an IMMEDIATE opening for an Image Enhancement Specialist with the following qualifications:

- Degree in computer science or engineering field.
- Three years experience working in the development of image enhancement equipment or techniques as applied to earth resources.
- Knowledge of mini/micro computer systems, large disc management, I/O controllers and array processing.

Generous benefits and relocation assistance available. Send resume including salary history and phone number, in confidence to:

Mr. F. J. Engel, Jr.  
TECHNICOLOR GRAPHIC SERVICES, INC.  
P.O. Box 1242  
Sioux Falls, South Dakota 57101

An Equal Opportunity Employer M/F

## Protect Your Heart CONTROL HIGH BLOOD PRESSURE



Give Heart Fund  
American Heart Association



# Be where the action is in data communications

## DataComm 777 ANNUAL CONFERENCE AND EXPOSITION, WASHINGTON, D.C., MARCH 9-11, 1977

Organized by:

**Auerbach Publishers • Association of Data Communications Users • Computer and Communications Industry Association  
Canadian Datasystems • Computer Decisions  
Computerworld • DataComm User  
Datamation • Infosystems**

Join us for the data communications conference you don't want to miss . . . your annual national conference organized by the industry leaders

That's DATACOMM 77. It promises to be the biggest, best, and most information-packed conference we've put together yet.

Program planners have taken full advantage of the Washington, D.C. conference site to arrange an outstanding series of special sessions dealing with governmental data communications. You'll hear about datacomm procurement within the federal government. You'll learn how data communications works for the military and for federal, state, and local governmental agencies and about systems for information exchange between agencies. You'll also have opportunity to express your views at our unique evening "Town Meeting" with FCC officials. In addition, you'll be brought up-to-date on legislation and other activities taking place right now in the nation's capital.

All this in addition to helpful and informative sessions on planning, implementing, and managing data communications . . . plus workshops and discussions on the latest developments in datacomm applications with special emphasis on distributed data processing and networking.

You'll also see what's new in datacomm products and services. Leading vendors have signed up for participation in the DATACOMM 77 Exposition. It's a great opportunity for you to gather first-hand information. To compare product features and capabilities. To get the data you need to make critical purchase decisions.

*Bring your spouse!* Our unique Spouse's Program features guided tours, other activities arranged exclusively for our DATACOMM family. Included are major Washington attractions and exciting peeks behind the scenes not offered on public tours.

Dr. William A. Saxton, Publisher of *DataComm User* and Conference Chairman, together with *DataComm User* Editor Morris Edwards, Program Chairman, invite you to join your colleagues for the annual national conference and exposition



Dr. William A. Saxton

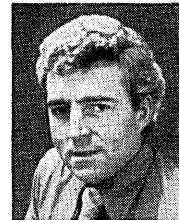

Morris Edwards

organized by datacomm industry leaders for all datacomm interests. Be where the action is . . . DATACOMM 77, Sheraton Park Hotel, Washington, D.C., March 9-11. Send the coupon now for details.

### I'm interested...

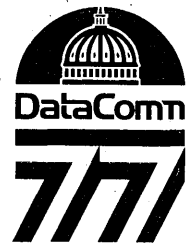

Dr. William A. Saxton,  
Conference Chairman, DATACOMM 77  
60 Austin Street, Newtonville, Ma. 02160

I may attend DATACOMM 77  
 My company may want to exhibit.  
Please send me more details.

Name \_\_\_\_\_

Title \_\_\_\_\_

Company \_\_\_\_\_

Address \_\_\_\_\_

City \_\_\_\_\_ State \_\_\_\_\_ Zip \_\_\_\_\_

Telephone \_\_\_\_\_

Questions? Want to register? Use our toll-free Hot Line: 1-800-225-3232. (In Mass. call 617-964-4550 collect.)

# Miniterm<sup>®</sup> 1203.

## New Portable Champ With The Knockout Features.

The new Miniterm 1203 from CDI packs a fistful of powerful features into an easy handling, lightweight package that makes it a winner for every timesharing application.

Ideal for programmers, salesmen in the field, or anyone who wants to have computing power at his fingertips, the Miniterm 1203 interfaces with all popular timesharing systems and can be used just about anywhere. All you need is an ordinary wall outlet and standard telephone, and you're on-line.

The Miniterm 1203 is at home in any environment. Quiet and unobtrusive, it doesn't need much desk space and is built tough to take the punishment of daily use. In fact, it is the only portable terminal warranted for a full year.

All the Miniterm 1203 features have been designed with the user foremost in mind. For example, the unique 3-way mode keyboard has TTY, upper/lower case typewriter, or numeric only, selectable by the operator!

Everything about the Miniterm displays the kind of engineering excellence users have come to expect from CDI.

Go with CDI's Miniterm 1203. The portable terminal winner.

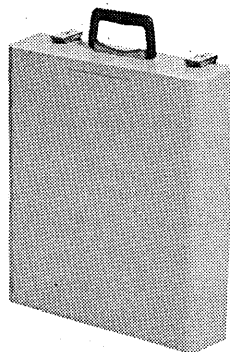
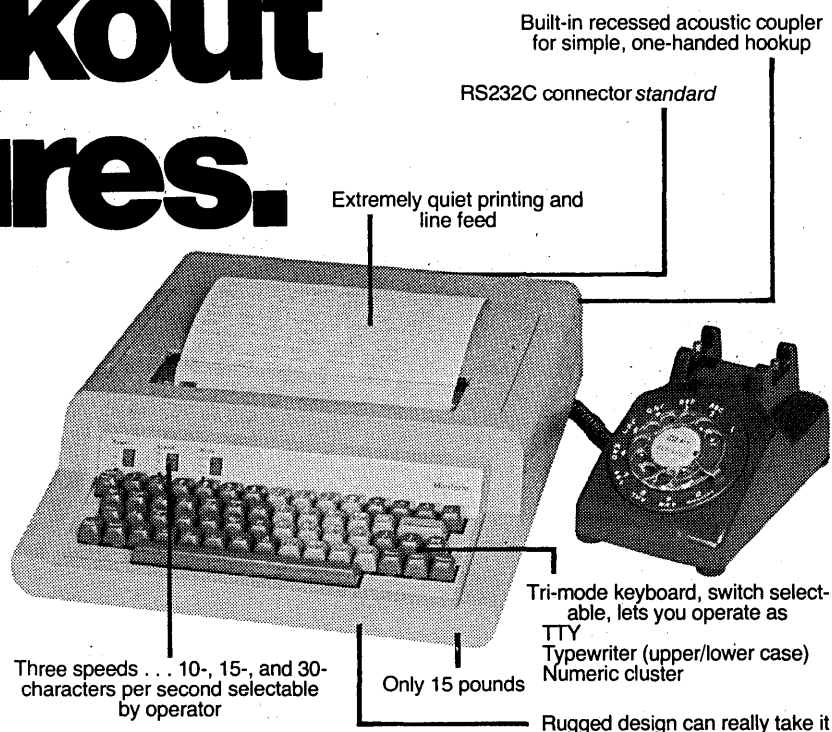

**COMPUTER  
DEVICES INC.**

9 Ray Avenue  
Burlington, MA 01803  
(617)273-1550

## Go With The Guaranteed\* Winner!

\*one year warranty

# advertisers' index

ABAQUEST .....	38
AFIPS .....	78
American Telephone and Telegraph .....	183
Anderson Jacobson .....	165
Applications Software, Inc. ....	185
Applied Digital Data Systems Inc. ....	100, 101
Arco Publishing Co., Inc. ....	188
Auerbach Publishers Inc. ....	135, 136, 137
Barnhill Hays .....	190
Basic Timesharing Inc. ....	88, 89
Beehive International. ....	Cover 3
Boeing Computer Services, Inc. ....	134
The Boeing Company .....	180
Boole & Babbage .....	159, 161, 163
Bourns, Inc.—Management Systems Division .....	91
Bruning Division of Addressograph Multigraph .....	202
Bunker Ramo, Commercial System Department .....	37
Byte .....	4
Centronics Data Computer Corp. ....	10
CFI Memories, Inc. .....	29, 30, 31, 32, 33, 34, 35
CMC, a division of Pertec Corporation .....	1
Computer Aided Design Centre ...	194
Computer Corporation of America .....	4
Computer Devices Inc. ....	196
Computer Professionals Book Club .....	65, 66, 67
Computer Transceiver Systems Inc. ....	156
Comtec Data Systems, Inc., A Subsidiary of American Micro-systems Inc. ....	92
Control Data Corporation .....	44
Courier Terminal Systems, Inc. ....	191
Data Communications Interface ...	98
Datacorp .....	96
Data General .....	14, 167
Data Products .....	104, 105
DataComm 77 .....	195
Datagraphix .....	27
DBI Books, Inc. ....	130
Digital Equipment Corporation .....	74, 75, 169
Diva .....	175
Dynatech Laboratories, Inc. ....	179
Eastman Kodak Company, Business Systems Markets Division .....	131
Electronic Memories & Magnetics Corporation .....	158
Ex-Cell-O Corporation, Remex Division .....	171

Four-Phase Systems, Inc. ....	5
Fox-Morris Personnel Consultants .....	189
General Electric Company .....	24, 25
General Electric Company, Video Display Equipment Operation .....	90
Genesis One Computer Corporation .....	93
Gould Inc. ....	62

Harris Computer Systems .....	42, 43
Hazeltine Corporation .....	76
Hewlett-Packard ... ..	79, 80, 81, 82, 83, 84, 154, 155
IBM .....	121, 122, 123, 124
IMS Associates, Inc. ....	77
Informatics Mark IV Systems Company .....	17
Informatics Inc. ....	20

## SOFTWARE DESIGN CHALLENGE!

Immediate Multiple Openings exist for Hardware/Software Oriented  
Individuals Seeking LONG-RANGE OPPORTUNITIES . . .

We represent one of the nation's leaders in systems and equipment innovation and offer several openings on multi-major long-range programs in Real-Time Hardware/Software Design and Development. Our immediate requirements are for professionals with outstanding technical credentials. A background in some of these areas will be considered: **Signal Processing Design Engineering, Digital Logic/Circuit Design Engineering, Digital Logic Design Engineering, Antenna & Microwave Engineering, Radar Transmitter Engineering, Software Simulation Design, Data Base Management, Intelligence Software, Command & Decision Definition and Design, Weapons & Missile Simulation, Operating System Software Development, Structured Programming, Computer Systems Architecture, Weapon System Software, Real-Time Software Design, Radar and Communications, System Programming, Software Intelligence—Programmers and Analysts.**

These are critical requirements for several long-range programs and offer career advancement and challenging opportunities to the motivated individual interested in a long-term position. Our client offers an excellent living environment and an opportunity for growth.

Please, rush your resume, including salary history, in complete confidence to LRK ASSOCIATES, Management Consultants, 6845 Elm Street, McLean, Virginia 22101. You may call us at (703) 790-8640.

U.S. CITIZENSHIP REQUIRED  
Representing an Equal Opportunity Employer M/F/H



## START '77 BY TAKING ON A BIG ONE!!

CIRCLE 124 ON READER CARD

# SPECTRON stops the finger pointing...

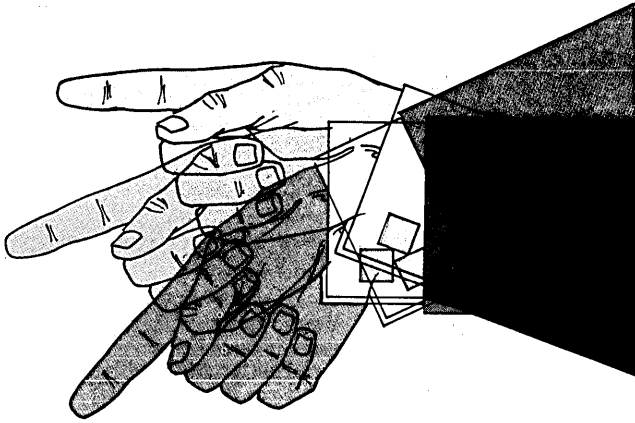

## now YOU can quickly isolate the source of data communications problems

It's a familiar scene. You have a problem, your system is down, Bell is blaming your modem vendor, the modem vendor is hinting your software is bad, and your mainframe vendor is muttering "Bell." All the while, you're out of commission, phones are ringing, and you have no control over events because you don't have the facts.

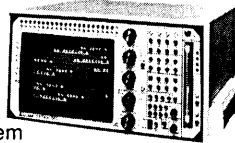

Spectron's DATASCOPE can give you the facts you need—objectively, easily, and, most important, quickly—to isolate the source of data communications problems. And it gives them to you in a language you understand and use every day.

Spectron DATASCOPIES offer a combination of CRT display and magnetic tape recording of all line traffic at the business machine interface of any standard modem.

DATASCOPE monitors data communications channels and shows you exactly what was sent and received—pinpointing problems in system hardware and software. You spend less time tracing problems, because errors caused by equipment malfunctions, incorrect programs, and line trouble are immediately visible. And the DATASCOPE is easy for operations, programming and engineering personnel to use.

Provides CRT display of every data link character sent or received  Simultaneous full-duplex data stream tape recording and display  Accepts all codes and speeds—up to 80Kbps  Switch-selectable hexadecimal or human language display  Compatible with all line disciplines, including SDLC and IPARS  Monitors full- and half-duplex circuits  Compatible with EIA Interface RS-232, MIL-STD-188, and CCITT; others available  Lightweight portability

**If your data communications problems are getting out of hand...** Get more information on Spectron's universal data communications monitors now. Complete and mail the attached coupon, or better yet, call Boyce Adams at 609/234/5700.



Specialists in Data Communications  
Church Road and Roland Avenue  
Mount Laurel, NJ 08057  
609/234/5700

YES, I want to stop the finger pointing. Tell me more about DATASCOPE data communications monitors.

Name \_\_\_\_\_  
Company \_\_\_\_\_  
Title \_\_\_\_\_ Phone \_\_\_\_\_  
Address \_\_\_\_\_  
City \_\_\_\_\_ State \_\_\_\_\_ Zip \_\_\_\_\_  
System \_\_\_\_\_

# advertisers' index

Infotek Systems .....	200
Intel Memory Systems .....	162
Intelligent Systems Corp. ....	72, 73
Interdata .....	103, 157, 181
International Data Sciences, Inc. ....	182
International Federation for Information Processing .....	170
Intertel, Inc. ....	144, 145
Istel Corporation .....	18, 19
Kennedy Co. ....	Cover 2
Lear Siegler, Inc. ....	8, 9
Litton Computer Services .....	182
Lockheed Electronics, Data Products Division .....	199
LRK Associates .....	197
Mathematica .....	36
Maxell Corporation of America .....	110
Midwest Stock Exchange .....	114
Microdata Corporation .....	128, 129
NCR Terminal Systems Division .....	190, 194
OK Machine & Tool Corporation .....	176
Omron Corporation of America, Information Products Division .....	7
On-Line Software International .....	186
Perkin-Elmer Data Systems .....	149, 151, 153
Pertec Peripheral Equipment Division .....	113
Programmed Power Division of Franklin Electric .....	112
Quest Systems Inc. ....	189
Raytheon Data Systems .....	41
RCA Service Company, A Division of RCA, Technical Services .....	180
RSVP Services .....	186
Sanders Data Systems Group .....	13
SC Electronics, Inc. ....	99
Society for Computer Simulation .....	120
Source EDP .....	201
Spectron Corporation .....	198
Standard Memories, An Applied Magnetics Company .....	173
Sycor .....	116, 117, 118, 119
Systems Engineering Laboratories .....	132, 133
Tandem Computers .....	59
T-Bar Incorporated .....	6
Technical Publishing Company .....	106
Tektronix, Inc. ....	126, 127
Teletype Corporation .....	Cover 4
Texas Instruments Incorporated .....	177
Texas Instruments Incorporated, Digital Systems Division .....	39
3M Company, Data Recording Products Division .....	23
Trendata, An Applied Magnetics Company .....	187
United Airlines .....	115
University of Cincinnati .....	202
University Computing Company .....	60, 61
Vadic .....	2
Varian Data Machines .....	68, 69
Versatec, A Xerox Company .....	107
Wang Laboratories, Inc. ....	40
Wangco Incorporated .....	108, 109
Western Peripherals .....	188
Xerox .....	94, 95



**Technical  
Publishing Company**

Arthur L. Rice, Jr., Chairman of the Board  
James B. Tafel, President  
Gardner F. Landon, Exec. Vice President  
Calverd F. Jacobson, Financial Vice President  
and Treasurer

Thomas A. Reynolds, Jr., Secretary  
M. Jay Turner, Jr., Director of Circulation  
Paul C. Jarvis, Director of Information Services

### Advertising Offices

#### Eastern District Managers

A. Treat Walker,  
Warren A. Tibbetts: Greenwich, Ct. 06830  
35 Mason St. (203) 661-5400

#### New England District Manager & Vice President

Warren A. Tibbetts: Manchester, N.H. 03104  
112 W. Haven Rd  
(603) 625-9498

#### Midwest District Manager

John M. Gleason: Chicago, Ill. 60611  
444 No. Michigan Ave.  
(312) 644-3970

#### Western District Managers

Alan Bolté, Jr.: Los Angeles, Calif. 90035  
1801 S. La Cienega Blvd.  
(213) 559-5111

James E. Filiatrault: Mountain View, CA 94043  
2680 Bayshore Frontage Rd.  
Suite 401  
(415) 965-8222

#### U.K., Scandinavia, Benelux

Intergroup Communications, Inc.  
Wallace K. Ponder, European Director  
Paul D. Dimmock, Regional Manager  
31 Lyncroft Avenue  
Pinner, Middx, HA5 1JU  
England  
Tel: (01) 868 9289  
Cables: PACOM, Pinner

#### Germany, Austria, Eastern Europe

Fritz Tæuber  
Soltauer Strasse 85  
D-314 Lueneburg  
Germany  
Tel: (0 41 31) 4 38 49

#### France, Switzerland, Italy, Spain

Gerard Lasfargues  
32 rue Desbordes Valmore  
75016 Paris  
France  
Tel: (1) 288 90 22

#### Japan

Shigeru Kobayashi  
Japan Advertising Communications, Inc.  
New Ginza Building  
3-13 Ginza 7-chome  
Chuo-ku, Tokyo 104, Japan  
Tel. (03) 571-8748

Technical Publishing Company



Business Magazines  
Consumer Books  
Training Systems

Consulting Engineer  
Datamation  
Plant Engineering  
Pollution Engineering  
Power Engineering  
Purchasing World  
Research/Development  
TPC Training Systems  
DBI Books, Inc.

# Software Systems Specialists and Avionics Systems Engineers

New growth programs offer excellent long-term career opportunities for ASW Airborne Systems Hardware/Software Specialists.

- Computer Systems Specialists . . . Design, development and test of ELINT or COMINT systems software with AYK-10 and CMS-2 experience.
- R & D Engineer . . . Real-time Airborne operating systems and associated Software Design/Analysis and application to integrated Command Control Systems.
- Test Equipment Programmers . . . Electronic systems design, test or analysis of ATS equipment with emphasis on development of software.
- Avionics Programmers . . . Design of real-time command and control airborne systems software.
- Avionics Systems Engineers . . . Current airborne radar systems design experience with knowledge of EM and antenna theory.
- Avionics Systems Engineers . . . ASW aircraft experience with emphasis on digital signal analysis.

Please send resume to Art Coyne, Lockheed Employment Office, P.O. Box 551, Burbank, CA 91520.

# LOCKHEED

Lockheed-California Company

Burbank, California

An equal opportunity F/M employer

CIRCLE 123 ON READER CARD

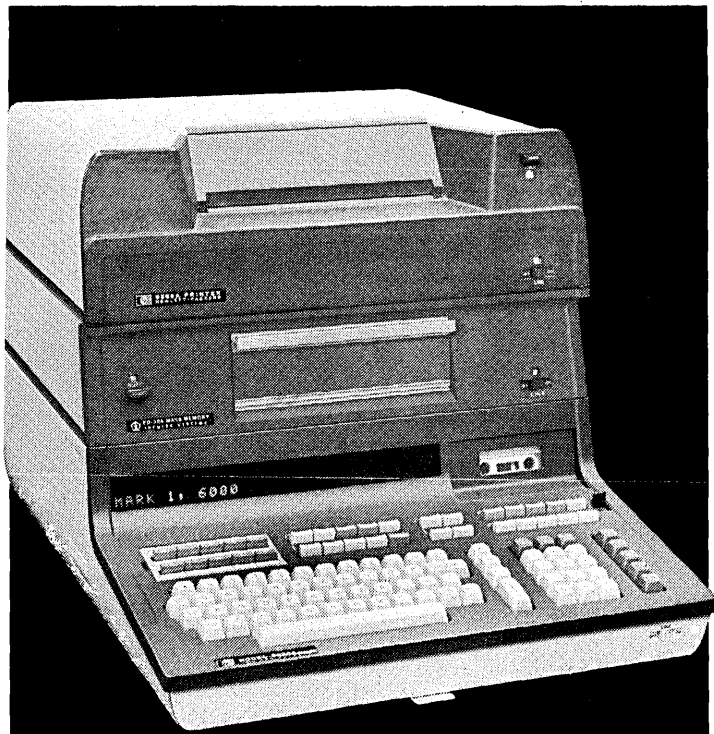

## HP 9830\* users ... your floppy disk is here! \$3895.

- The FD-30 runs on cassette commands... that means *no software changes!* Because it runs on your *existing* programs.
- The FD-30 finds files *50 times faster* than either the 9830 or the 9865 cassette drive.
- The FD-30 stores 5 cassettes of data at the cost of one cassette.
- The FD-30 stores a 6,000 word array in *4 seconds* via a simple STORE DATA—the HP 9880 mass memory takes 11 seconds to do the same job.
- The FD-30 sells for *less than a third* of the 9880B.

Infotek's FD-30 provides 305K bytes of user area. Or 5 to 7 cassettes of data on-line, retrievable *50 times faster* than your present system.

### No installation!

You can fit the FD-30 neatly between the calculator and printer. Just plug-in the I/O connector and power cord. And its color design perfectly matches the 9830.

### Latest Technology

We're using the latest technology microprocessor for the controller/formatter and the finest floppy disk system.

### All for \$3895.

Plus you get quality comparable to the 9830.

Call us collect at (213) 966-7431. Or write Infotek Systems, 733 E. Edna Place, Covina, Ca. 91723. Ask about other 9830 compatible products.

\*a product of the Hewlett-Packard Company



**Infotek Systems**

This forum is offered for readers who want to express their opinion on any aspect of information processing. Your contributions are invited.

# the forum

## Chartae fluxus consilii, Requiescant in pace

Three distinct phases can be observed in most programming projects. We refer to these as the analysis phase, the design phase, and the coding phase. I'll avoid using the term "programming" to describe the third phase because, in my opinion, that term describes the overall process.

The analysts and designers are as much "programmers" as are the coders. Their parts of a programming process can have a very profound effect on a whole project. In each case (analyst, designer, coder) the job must be done well and the results communicated to the next phase. For the coder, the next phase is the computer.

Doing a good job in each phase is a difficult task. Communicating the results is more difficult. Flowcharting has been used at various points in the programming process, as a tool both of the designer and the coder as well as a means of communicating between the designer and the coder.

In my opinion, people do not think in flowcharts. We must be honest and admit that program flowcharts are usually an afterthought. That is, just how many times does someone have a program flowchart that:

1. Was drawn before the program was written?
2. Precisely represents the program?

Not very often. Why? Because as the program is written and the algorithm modified, there is not always a convenient way to modify the flowchart.

It does not take long for one to see the direction of the future. Compare McCracken's recent text on COBOL programming to any of his earlier texts. In the new one, the use of a structured pseudo-English and indentation is shown to present a convenient way of describing the structure of a program.

Naturally, it is easier to translate the pseudo-English into certain programming languages, but it can be translated into any language. As a matter of fact, this pseudocode approach has been used to design programs which were coded in assembler.

Further, with the availability of program design languages, like Caine, Farber, and Gordon's PDL, the pseudo-English documents can be easily modified.

The pseudo-English approach to program development has other advantages too. Perhaps the most important is communications. If the designer used pseudo-English to describe the overall structure of the program, the coder can begin with that document and enhance it to bring it closer



## The Professional Approach To Career Planning

# The New 1977 Computer Salary Survey

Call for your free copy today!

A successful career in today's computer field requires the same professional planning you'd use in developing a new program or system. Each step must be carefully planned to make sure you reach your career objectives on time while avoiding costly side-tracks. That's where the computer professionals at Source EDP and their new report, the *1977 Computer Salary Survey*, can help you.

Together they'll work with you in determining your strengths and where you stand compared with others in salary, position and career potential. They'll help you establish a specific and realistic career plan that will carefully explore all of the alternatives available to you in reaching your career objectives. After fifteen years of experience, Source EDP knows exactly what you can do to gain broader exposure, maximize your compensation and break into management.

Call the professionals at Source EDP today! They'll send you your free copy of the 1977 Computer Salary Survey and start you on your way to a more rewarding and productive career. But do it now, it could be the most important phone call you've ever made.

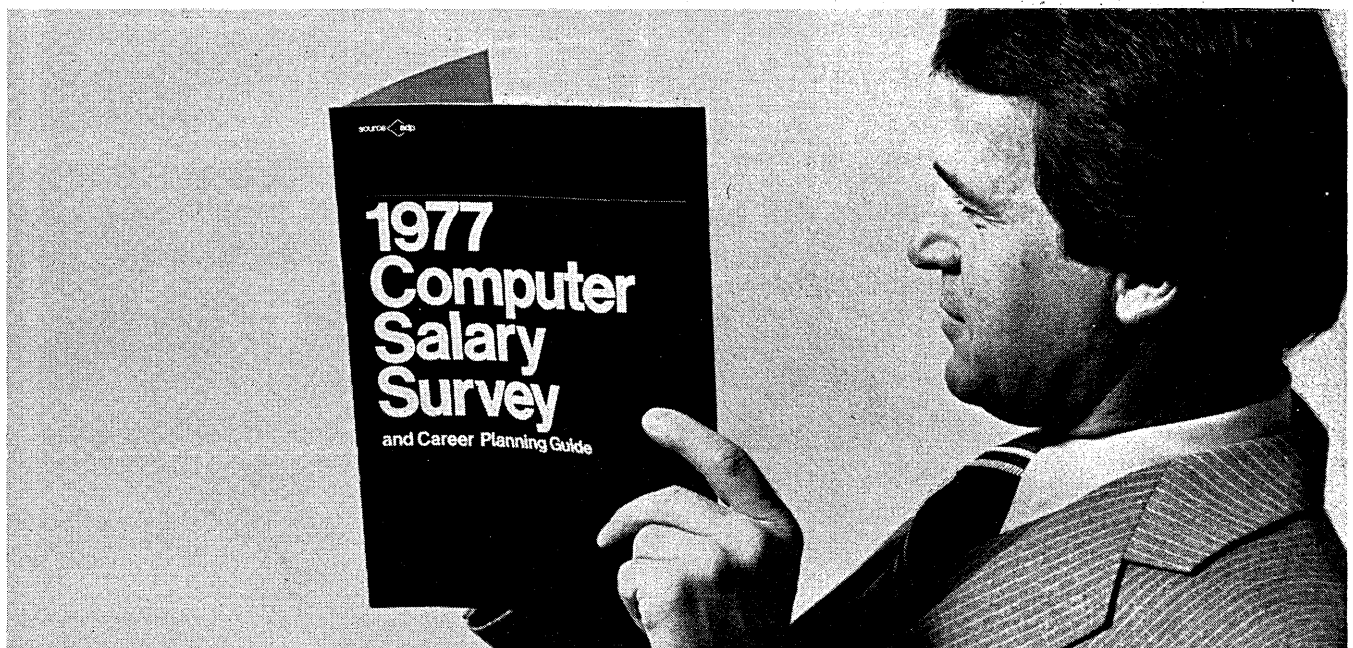
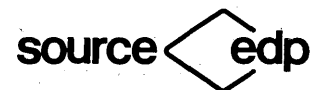

**For your FREE 1977  
Computer Salary Survey  
call the Source EDP office  
nearest you.**

**East**  
Boston 617/237-3120  
Greenwich 203/869-5977  
New York/New Jersey 201/687-8700  
Philadelphia 215/665-1717  
Washington, D.C. 703/790-5610

**Midwest**  
Chicago 312/782-0857  
Cleveland 216/771-2070  
Detroit 313/352-6520  
Kansas City, Mo. 816/474-3393  
Minneapolis 612/544-3600  
St. Louis 314/862-3800

**South/Southwest**  
Atlanta 404/325-8370  
Dallas 214/387-1600  
Denver 303/773-3700  
Fort Worth 817/338-9300  
Houston 713/626-8705  
New Orleans 504/561-6000

**West Coast**  
Irvine, Ca. 714/833-1730  
Los Angeles 213/386-5500  
Palo Alto 415/328-7155  
San Francisco 415/434-2410  
Torrence, Ca. 213/540-7500

**If unable to call, write:**

**Source EDP  
Department D-1  
721 Enterprise  
Oak Brook, Illinois 60521**

**When writing please be sure to indicate  
home address and current position title.**

# Doubles reading speed, instantly.

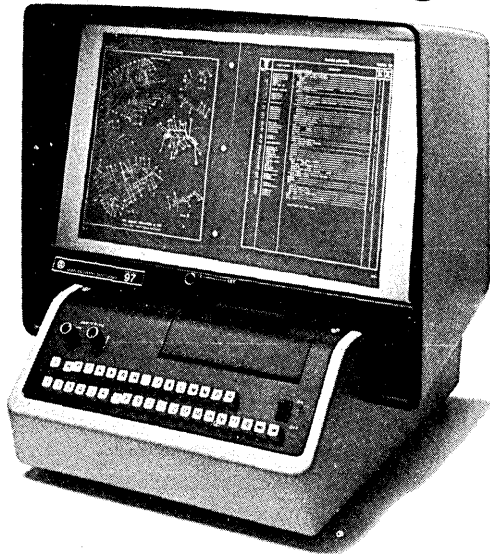

## Introducing the Bruning 97 pushbutton page/select viewer.

You can't read a page till you find it. And our new automated Model 97 viewer instantly locates the page you want, centered perfectly on the screen—with pushbutton ease and accuracy.

It works on the classic grid-map coordinate principle. Sounds simple, but only Bruning offers it in an automated microfiche viewer. And our pushbutton technique is faster and more efficient than tedious manual methods.

The Model 97 is ideal for multiple-frame searches on the same fiche, plus most sequential rapid-search applications.

Another aid to speed reading is its large 12" x 20" screen. It displays two full 8½" x 11" pages at 24X. Or single frames at 42X.

Contact your local Bruning office for a hands-on demo. Or write Bruning, 1834 Walden Office Square, Schaumburg, Illinois 60196.

**The bold force in micrographics.**



**BRUNING**

DIVISION OF  
ADDRESSOGRAPH MULTIGRAPH

CIRCLE 90 ON READER CARD

## the forum

to an actual representation in some programming language. Or as has been done, the pseudo-English is translated into a set of indented comments and the coder simply fills in the code between the comments. In some cases, the code can be generated directly from the design language documents.

PDL, although primitive when compared to other software tools currently being developed, shows the advantage of the pseudo-English approach to program development. Attempts have been made to use PDL through the entire analysis-design-code cycle of a programming project. Although this is beyond the original intent of the use of a pseudo-language, the approach does have merit in that it attempts to use a common tool to communicate between the various phases of a programming project.

By using a common communications tool, one hopes that by reducing the need for translations between phases one increases the chances for the original intentions of a program project to come through in its final implementation.

Latin is a dead language. Program flowcharts must follow Latin. Programming is an evolving intellectual process, and flowcharts have played a role in this evolution. However, their time has passed, just as Latin's time has passed. My last statement on them is "Program flowcharts, may they rest in peace."

*(The translation to Latin was done by Rev. Robert F. Young, S.J. and Rev. Edward R. Powers, S.J.)*

Professor Beidler is the Chairman of the Dept. of Mathematics and Computer Science at the Univ. of Scranton, in Scranton, Pennsylvania.

—John Beidler

Your career is a big bite  
out of your life

# byte back

Programmers  
Programmer/Analysts  
Systems Analysts

Grow with the  
University of Cincinnati  
Interview now. Begin in 1977.

Excellent benefit package includes

- Free tuition (6 credit hours per quarter)
- Relocation assistance
- Competitive salary
- Liberal vacation plan
- 10 paid holidays

SouthWestern Ohio Regional Computer Center, servicing the University of Cincinnati, Miami University and a variety of nonprofit organizations, has openings at all levels. Opportunities exist for people with backgrounds in commercial, academic or scientific applications. Experience in PL/1, COBOL or FORTRAN is desirable.

Resumes must contain current salary. Reply to Mr. John Sullivan, Associate Director, SWORCC, 231 Bethesda Ave., G87 MSB, Cincinnati, OH 45267. If you need additional information, phone 513/475-4134 or 513/475-2636.

An Equal Opportunity Employer

CIRCLE 130 ON READER CARD

**DATAMATION**

New!  
BEEHIVE'S



B500

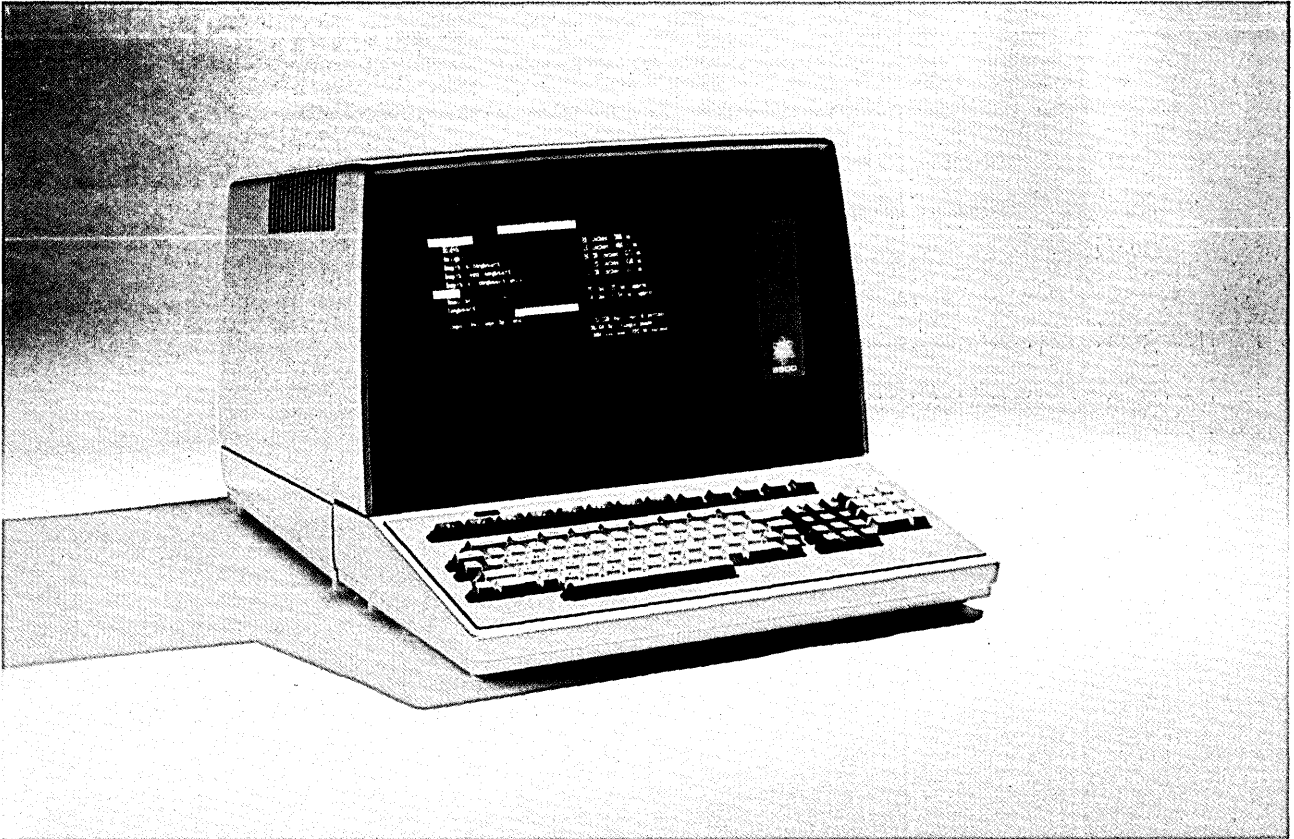

## User Programmable Intelligent Terminal

Expandable Memory

### BEEHIVE'S B500 features

- User Programmable
- Expandable Memory
  - Display—4K RAM (4000 Characters)
  - Program—Up to 4K PROM or 8K ROM
  - Up to 48K RAM
- Down Load Capability from CPU
- Transmission Rate to 19,200 bps
- Expanded Editing Capability
- Flexible Disk Option
- Non-Glare Screen
- Programmable Character Generator

Beehive's user programmable B500 is a video display terminal offering Keystroke-programming, system flexibility and an unmatched cost/benefit ratio. Features include an expandable program memory (56K bytes), down load capability from the CPU, data transmission rates to 19,200 bps, and Full Duplex/Half Duplex on-line operation. Other features: edit functions, RS232C compatibility, 25 lines X 80 character display capacity, line and block transmission, addressable cursor, upper and lower case characters, scrolling, and eight level video. Beehive's B500 also utilizes a detachable typewriter style keyboard with an 11-key numeric pad.

Many additional options are available to meet exacting customer requirements; among them, flexible disk, expanded software capability, 256 programmable characters, and edit features.



Another Terminal from

**BEEHIVE INTERNATIONAL**

Manufacturer of Quality Computer Systems

USA: 4910 Amelia Earhart Drive • Box 25668 • Salt Lake City, Utah 84125 • Phone (801) 355-6000 • TWX 911

EUROPE: Schiphol Airport Amsterdam • Building 70 Schiphol East • The Netherlands • Phone 451-5

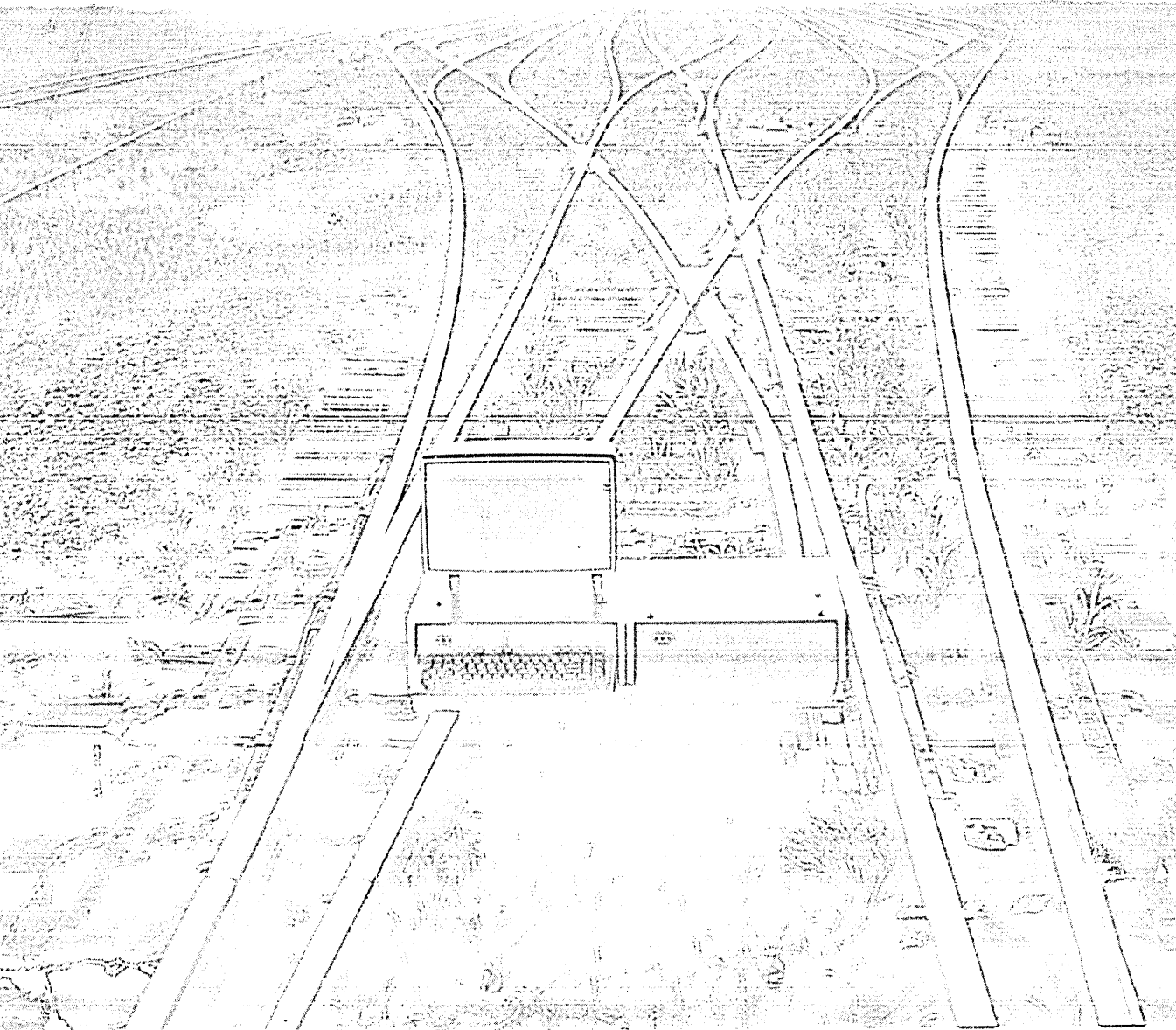

## When it comes to flexibility, the model 40 gives you a lot of ways to go.

When we designed the model 40 system, we included a long list of features and options to give it the flexibility for practically any data transmission requirement. Whatever your industry or application.

First, there's a variety of speeds ranging from 110 to 4800 bps, along with a choice of interfaces, half- or full duplex operation and character and batch mode transmission. The model 40 system also has a number of on-line controls, even odd parity generation and a destructive scrolling feature that permits continuous bottom line reception with no loss of data until memory overflow.

Flexibility features don't stop there, either. There's an expandable memory with line and page scrolling, protected format with variable field transmission, plus many other features and options to select from. And since the entire system is modular, it can be custom tailored to fit your needs.

These are just some of the many reasons why the model 40 has the flexibility to fit just about any system. But the model 40's strongest suit is economy. Because on a cost/performance basis, nothing ever comes close. And delivery is a lot shorter than expected.

For complete information, please contact our Sales Headquarters at 5555 Trolley Ave., Skokie, Ill. 60076. Or call Terminal Central at (312) 932-2000.

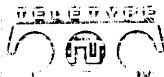

**The Teletype model 40 system.  
Nothing ever comes close.**