

# DATA<sup>71</sup>MATION<sup>®</sup>

March 15

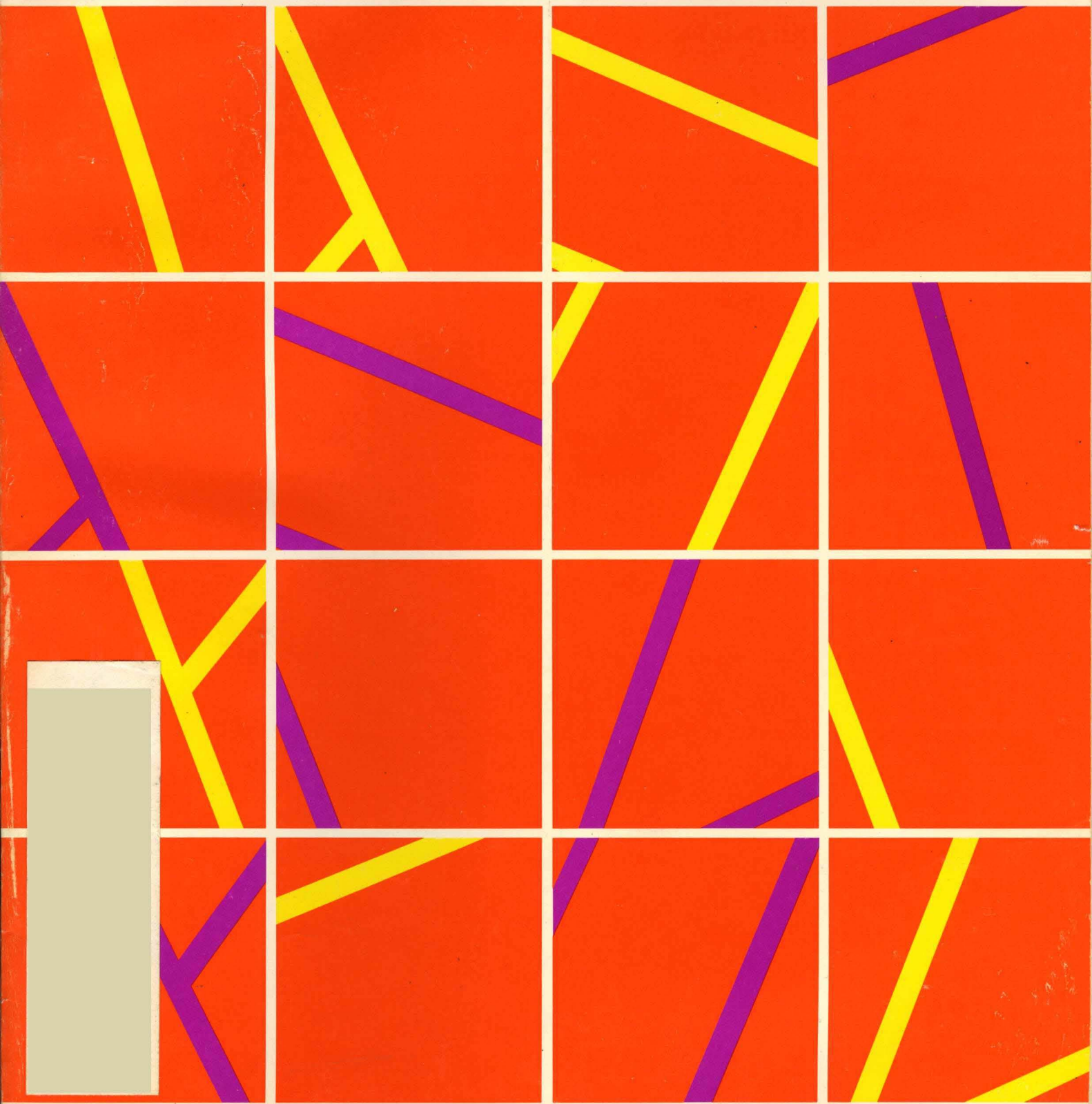

MESSAGE  
SWITCHING

# COMING ON STRONGER...



## With More Drive

Caelus® CD22 and CDD44 disk cartridge drives are designed with the user in mind. 22 or 44 megabit capacity at the lowest cost per bit in disk storage. Electro-optical head positioning system for extreme reliability, overall design

simplicity for maximum performance, rack mountable in your cabinet or ours. Caelus also manufactures its own disk cartridges and drive test units which says it all...total performance from Caelus means total satisfaction for you.



CAELUS® MEMORIES, INC. P. O. Box 6297, San Jose, California 95133. Telephone (408) 298-7080

CIRCLE 1 ON READER CARD

# Tell a friend about Colorado Instruments.

**Better yet—send us his name.  
We'll send him complete literature  
and tell him ourselves.**

We're the best in source data collection systems, although most of your friends probably don't know we exist. We've been "off in a corner" perfecting!

But we've proven ourselves to a number of the country's leading companies.\* By solving some problems in simple ways that would intrigue you. So we're ready to widen our circle—show a lot more people how we can fill the gap between them and their computers.

Our systems are uniquely designed for speed, accuracy and reliability. They collect data directly from its source—the man on the job—and transmit it to the computer. On-line. Or off-line.

By eliminating the need for keypunching, record keeping and pad-in-hand inventories,

they eliminate man-hours. Increase accuracy. Decrease costs.

They are simply designed. And easily operated. Modularly designed. And easily adapted.

Here, we can only touch upon a few of the advantages of our brand of source data collection. At your convenience we'll demonstrate them all.

So you can tell a friend about Colorado Instruments.

You can tell him how we've helped others solve their problems. With time and attendance recording. With production reporting. With inventory control and materials ordering. With purchasing and receiving.

More important, you can tell him how we can help him!

\*Names available upon request

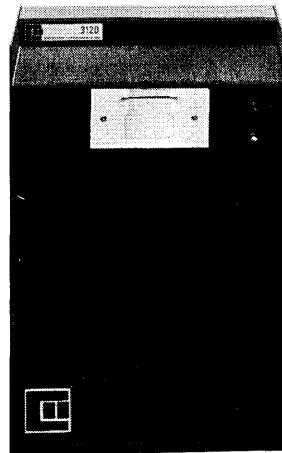

3120 BADGE READING STATION

**Filling the gap between people and computers.**

**COLORADO**  **INSTRUMENTS**

ONE PARK STREET • BROOMFIELD, COLORADO 80020 • (303) 466-1881

CI-342

March 15, 1971

CIRCLE 4 ON READER CARD

1



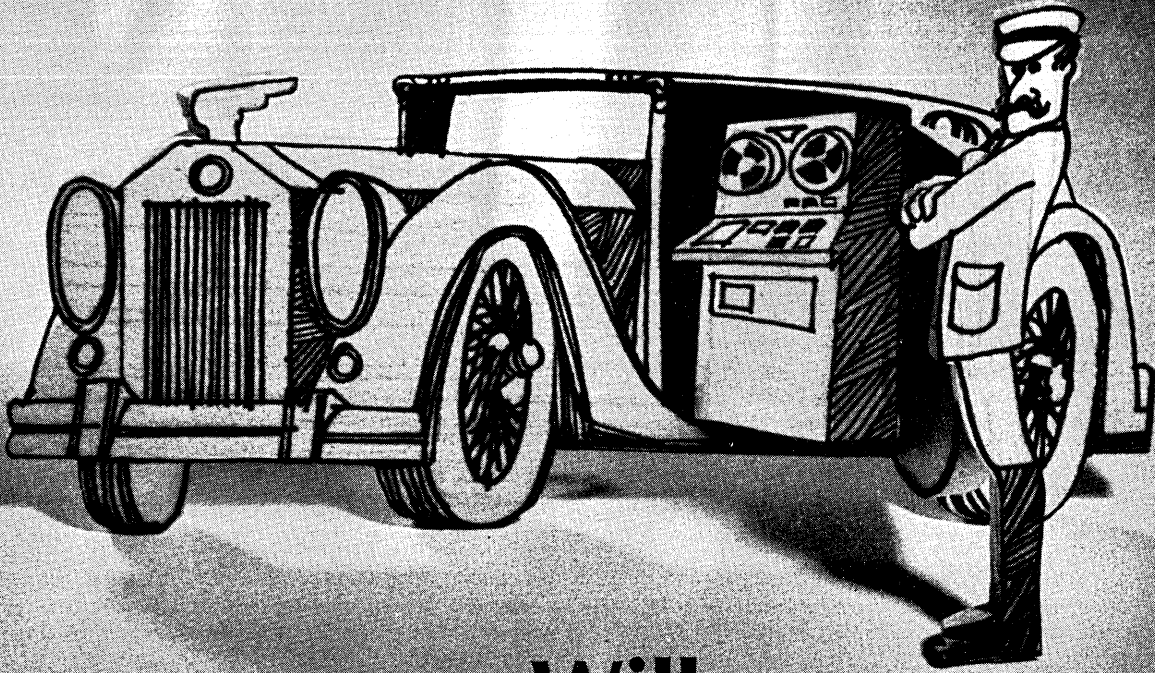

## Will our low-cost terminal fit in with your million-dollar computer?



Our new BR 2210 terminal is compatible with System 360 and other computers.

It should be compatible with your budget, too, because it's the *lowest-cost on-line* CRT (Cathode Ray Tube) terminal in the world.

So if high cost has kept you from putting your computer on-line, the 2210 solves the problem.

Same thing applies to expanding your present on-line system. At less than \$2.00 a day per unit, you can team dozens of 2210's with larger-screen models to achieve a full-scale system at central and branch locations.

Large screen or small, Bunker-Ramo terminals are simple to use. No need to hire skilled operators. Our desktop systems place your computer's information files at the fingertips of the people in your organization who can best use this data.

Let us make the most of the information files already in your computer. Nobody's had more experience or success at this than Bunker-Ramo.

Increased productivity at lowest cost. That should make Bunker-Ramo information systems fit in nicely with your million-dollar computer.

For further information, contact: The Bunker-Ramo Corporation, Business & Industry Division, 35 Nutmeg Drive, Trumbull Industrial Park, Trumbull, Connecticut 06609. Telephone: (203) 377-4141.

**BUNKER  
RAMO**

The real real-time people Branch offices throughout the U.S. and in Toronto, Canada.

CIRCLE 58 ON READER CARD



# DATA MATI<sup>71</sup>ON<sup>®</sup>

**MARCH 15, 1971**

volume 17    number 6

departments	
<i>Letters to the Editor</i>	9
<i>Look Ahead</i>	17
<i>Perspective</i>	48
<i>News Scene</i>	50
<i>Hardware</i>	73
<i>Software</i>	85
<i>Books</i>	95
<i>Washington Report</i>	105
<i>People</i>	107
<i>Index to Advertisers</i>	110

## TECHNICAL

### 22 Digital Switching

The principles and concepts are complex and involved—but here is a tutorial offering an introduction to approaches in the functional aspects of the operational design and testing of a digital message switching system.

## MANAGEMENT

### 32 EDP Goes Multinational in '71

U.S. computer companies must face the worldwide challenge in the decade ahead of competing within national markets, considering the established trend toward higher profits available abroad.

## GENERAL

### 41 Canadian Show

Still a tiny industry, relative to the U.S., Canadian companies showed their technical capability at the first north-of-the-border computer show.

### 45 CEDPA Conference

Progress and plans were considered at the 10th annual meeting of educational data processors.

## COMMENTARY

### 48 Perspective

Competitive memory makers hope to prolong 360 life by offering users add-on core and semiconductor memories in what shapes up as a price and supply battle that can last only a few years, but that may be enough for lessors feeling the 370 squeeze.

### About the Cover

In a sort of graphic rap about the vast uncharted field of random and unscheduled inputs peculiar to digital telecommunications systems, our art director constructed this network of 16 squares arranged by pure chance. Get the message?

# arvey

# the no-fail nc tape



guaranteed  
trouble free

■ **FREE SAMPLE:** Tape tailor-made for your equipment. Attach this ad to your letterhead and mail.

# arvey corporation

LAMCOTE DIVISION

3 Strategic Inventory Locations for Instant Service at all times:

3500 N. Kimball Ave., Chicago, Ill. 60618. (312) 463-1400  
Also: Jersey City, New Jersey, and Los Angeles, Calif.

# DATAMATION®

**MARCH 15, 1971**

volume 17 number 6

This issue 110,959 copies

## EDITOR

**ROBERT B. FOREST**

## EDITORIAL STAFF

*Managing Editor*

*Senior Associate Editors*

*Associate Editors*

*Copy Editor*

*Assistant Editors*

*Special Features Editor*

*Eastern Editors*

*New England Editor*

*Washington Editor*

*Midwestern Editor*

*European Editor*

*Australian Editor*

*Contributing Editors*

**EDWARD K. YASAKI**

**WILLIAM J. ROLPH, TOM McCUSKER  
AUBREY DAHL, RICHARD A. McLAUGHLIN,  
EDITH D. MYERS, JOHN T. WATERHOUSE**

**JANET EYLER**

**MICHAEL WILLIAM CASHMAN**

**ALMA O'STEEN**

**ANGELINE PANTAGES**

**JOHN WESSLER, F. BARRY NELSON**

**W. DAVID GARDNER**

**PHIL HIRSCH**

**LAWRENCE RAGAN**

**PEARCE WRIGHT**

**FREDERICK A. BLAND**

**HOWARD BROMBERG, ROBERT V. HEAD,  
PHILIP H. DORN, LOUIS B. MARIENTHAL,  
DANIEL D. McCracken, F. G. WITHINGTON,  
PAUL ARMER, ROBERT P. BIGELOW**

**ROBERT L. PATRICK**

**LOWELL AMDAHL**

*Editorial Adviser*

*Technical Consultant*

## EDITORIAL OFFICES

**HEADQUARTERS:** 94 S. Los Robles Ave., Pasadena, Calif. 91101, Phone: (213) 681-8486; **EASTERN:** 35 Mason St., Greenwich, Conn. 06830, (203) 661-5400; 19 Marlborough St., Boston, Mass. 02116, (617) 267-9414; 9805 Singleton Dr., Bethesda, Md. 20034, (301) 365-8671; **MIDWESTERN:** 407 S. Dearborn St., Chicago, Ill. 60605, (312) 922-8245. **FOREIGN:** 65, Hill Road, Chelmsford, Essex, England; 322, Park Regis, Park St., Sydney, NSW 2000, Australia.

## GRAPHIC DESIGN AND PRODUCTION

*Art & Production Director*

*Production Manager*

*Production Assistants*

**CLEVE MARIE BOUTELL**

**MARILEE PITMAN**

**GLORIA J. FASANA, LOUISE T. O'CONNOR**

## CIRCULATION

35 Mason Street  
Greenwich, Conn. 06830

*Circulation Manager*

*Marketing Research Director*

**MAE VAN RENNES**

**DOUGLAS DeCARLO**

## PUBLISHER

**GARDNER F. LANDON**

**ASSISTANT PUBLISHER**

**JAMES M. MORRIS**

Circulation audited by  
Business Publications Audit



Member, American  
Business Press, Inc.



DATAMATION is published twice monthly on or about the first and fifteenth day of every month by Technical Publishing Company, 1301 South Grove Ave., Barrington, Illinois 60010; Arthur L. Rice Jr., President; Gardner F. Landon, Executive Vice President. Executive, Circulation and Advertising offices, 35 Mason Street, Greenwich, Conn. 06830 (203) 661-5400. Editorial offices, 94 So. Los Robles Avenue, Pasadena, California 91101. Published at Chicago, Ill.

DATAMATION is circulated without charge by name and title to certain qualified individuals who are employed by companies involved with automatic information handling equipment. Available to others by subscription at the rate of \$25 annually in the U.S. and Canada. Reduced rate for qualified students. Foreign subscriptions are on a paid basis only at a rate of \$38 annually. No subscription agency is authorized by us to solicit or take orders for subscriptions. Controlled circulation paid at Columbus, O. and Form 3579 to be sent to Technical Publishing Company, P.O. Box 2000, Greenwich, Conn. 06830. Copyright 1971, Technical Publishing Company. Microfilm copies of DATAMATION may be obtained from University Microfilms, Inc., 313 No. First St., Ann Arbor, Michigan. Printed by Beslow Associates, Inc.

# EVERY COMPUTER A CALL GIRL

**UNIQUE AUTOMATIC CALLING UNIT WITH SERIAL INTERFACE  
DECREASES COMPUTER FRONT-END HARDWARE COSTS.**

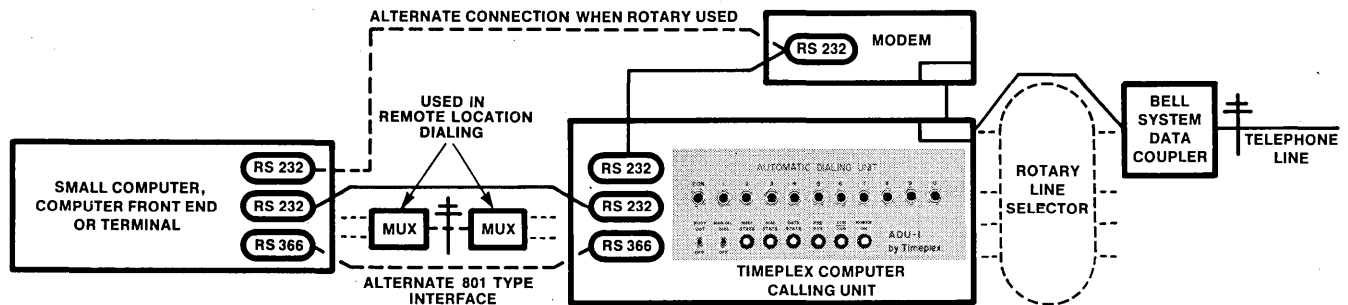

*The telephone pick-up is now out of date.* The Timeplex Computer Calling Unit lets your computer or terminal dial telephone numbers — including area codes and PBX outside line prefixes — directly or remotely thru a dedicated line and data multiplexer. It interfaces with just about anything a computer can output, including RS-232, RS-366 (replaces Bell 801's), ASCII, IBM and Baudot Codes, 50 to 4800 BPS character speeds and connects to Bell System lines thru a standard Data Access Unit, dial pulse or touch tone. Now, even a mini, or small computer without an expensive front end can

poll terminals using the dial network. Large computer systems can now operate without auto-call (801) adapters and can dial multiple, long distance calls at local rates via dedicated lines. Dialing may also be done directly from keyboard terminals. Compatible modems with automatic answer options and an optional rotary (not-busy line selector) enable Timeplex to custom optimize any automatic answer or calling system configuration.

*If you'd like a tour thru the Timeplex Red Light District, come up and see us sometime or better yet, dial us.*

## Timeplex

**Sales Office:** 1522 K Street, N.W., Washington, D.C. 20005  
Telephone: 202-466-2056

**Headquarters:** 65 Oak Street, Norwood, New Jersey 07648  
Telephone: 201-767-1650

**OTHER PRODUCTS:** TIME DIVISION MULTIPLEXERS, AUTOMATIC LINEBACKER, CONTENTION CHANNEL EXPANDER, AND LINE SHARING SERVICE.



**VARIAN 620/i  
USERS:**

**THERE'S  
A NEW  
ADD-ON MEMORY  
YOU WON'T  
SOON FORGET.**

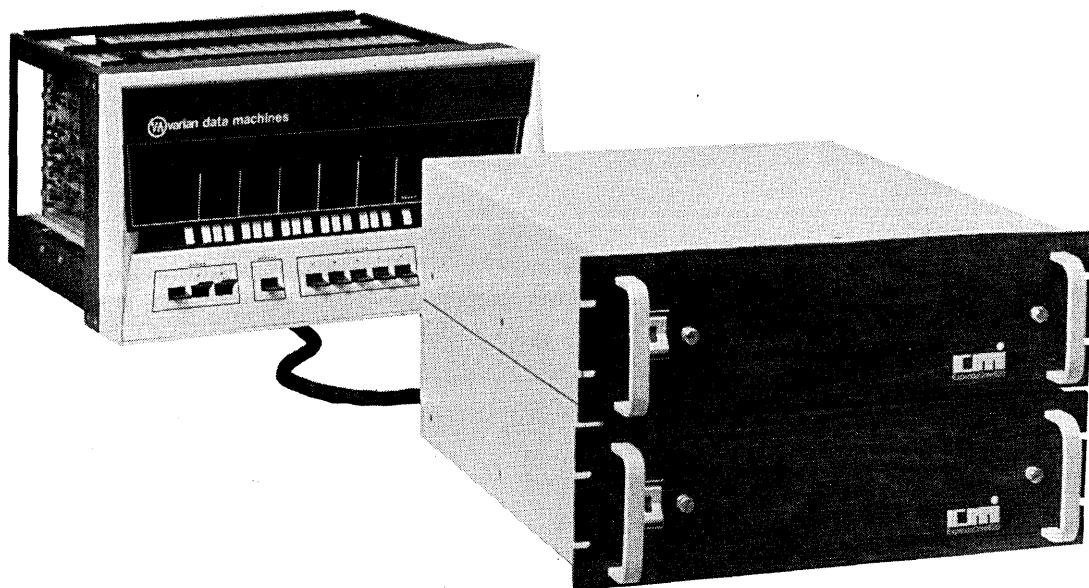

## **EXPANDACORE 620.**

It's a plug-compatible main memory for your 620/i, but over 30 per cent less costly. Easily expandable in 4K increments to 32K, in half the space. ExpandaCore's advanced design has been proven in over 500 installations. Immediately available. For other memorable details, contact our Marketing Department.



CAMBRIDGE MEMORIES, INC., 285 Newtonville Ave., Newtonville, Massachusetts 02160, (617) 969-0050

In the beginning there were only a few credit cards.



Then companies created more credit cards.



Soon almost everyone had a credit card. But some people used too much credit or credit that wasn't their own. And many companies lost money because they didn't have a sure way to check credit quickly and accurately.

So Pitney-Bowes set out to develop a credit authorization system that was better than any other system before.

They came upon a fluorescent encoding technique that was invisible, inalterable, as durable as the card and compatible with any embossing system. They even made sure the code wouldn't change the look or feel of the card. Then they designed a machine that eliminated call-ups, lists, even floor limits. The machine could read the card, register the amount, phone the computer, receive the go or no-go message and give the operator the o.k. or any one of three special signals . . . all in less than 10 seconds . . . for any amount of charge . . . for any credit card.

Pitney-Bowes had done what they had set out to do.

## The beginning of the end of credit card losses.

THE NEW  
PITNEY-BOWES  
CREDIT  
AUTHORIZATION  
SYSTEM



Pitney-Bowes

For information, write Pitney-Bowes, Inc., 9651 Atlantic Street, Stamford, Connecticut 06904 — or any of our 101 offices in the U.S. and Canada.

March 15, 1971

CIRCLE 66 ON READER CARD

7

# A dirty tape can give a computer the DT's.

Dirty tape causes data dropouts. And dropouts can make a computer see things that aren't there. That costs you money. And that's enough to make anyone see red.

RCA Computer Tape helps computers read and write right.

It's a special formulation that starts cleaner. Every inch of every reel is tested and certified in the cleanest of white-room conditions. (We think statistical testing leaves too many blind spots.) And it stays cleaner, longer.

So? Fewer dropouts, more

efficient computing.

Help your computer see things as they really are. Write RCA Magnetic Products, 201 E. 50th St., New York 10022.

Our tape keeps the DT's away.

**RCA** Computer Tape







# LETTERS

## Higher him

Sur:

how does won git a job as a  
 progremmer  
 dispite my qualificashuns i have not  
 maid it yet  
 i am throwthly convensed that  
 discriminashun is the reeson  
 peepol with spanish surnames are  
 not in demand in this aria  
 either that or politiks are involved in  
 gitting werk as a progremmer  
 last weak for exemple i applied for a  
 progremmin job and wuz asked  
 to taik an edp test  
 my score on the exeminashun was  
 won hundirt  
 i also past the verball intervue with  
 flyin culers  
 by all indicashuns i wood git the job  
 persenell said thay wood git in  
 touch with me in a few days with  
 an offur  
 they rode me a letter seyin thay wur  
 reddy to pay me \$16K for my  
 survises  
 i rode bak exseptin the job and asked  
 summ qeshuns about there  
 comeputors  
 persenell rode bak seyin "Forget it,  
 Charlie."  
 my naime is not charlie  
 its the saime storie every time i  
 apply for a progremers job  
 i want to be a *coball* progremmer but  
 no won will hire me  
 is it reely discriminashun and politiks  
 or is it my imaginashun

J. GOMEZ

*Albuquerque, New Mexico*

## High stool dropout

Sir:

From a diagnostical view, the articles  
 by Louis B. Marienthal, Daniel D.  
 McCracken and Philip H. Dorn in  
 the January 1 issue lay it on the line.  
 No one can dispute the fact that data  
 processing performance never caught  
 up with data processing promises. It  
 is all too evident that our contemporaries  
 in the non-data processing  
 world are enjoying our merited dis-  
 comfiture.

However, Mr. McCracken more  
 firmly places the situation in perspec-  
 tive, and, if I may interpret his re-  
 marks, they remind me of the old  
 joke where Jack is reciting his ser-

vices of yesterday, and Jill pipes up  
 "But what have you done for me  
 lately?" This is the question to which  
 the dp manager must provide a posi-  
 tive answer.

And that is just the question which  
 faces us in the hard world of the  
 present. A recitation of past accom-  
 plishments suffices us not. We must  
 prove the worth of our accomplish-  
 ments in the harsh *real* world of mar-  
 ginal return on investments now, as  
 opposed to hopes of glorious future  
 achievements. Unfortunately, the  
 former condescending attitude of the  
 data processing professional, as so  
 ably exposed by Mr. Marienthal, has  
 in the past precluded the free inter-  
 change of ideas and personnel be-  
 tween the various functions of an  
 organization. This barrier between  
 need and knowhow is entirely artifi-  
 cial, but is real nonetheless.

What is required is not a new  
 breed of manager, but a new attitude  
 of humility on the part of the data  
 processing professional. Although he  
 may be an expert in the field of bits  
 and bytes, he is too often ignorant in  
 the matter of dollars and cents, ex-  
 cept in salary demands. We need to  
 learn where the earnings originate  
 and direct our efforts to proving our  
 worth in terms of profits rather than  
 of pie in the sky.

We have one good thing going for  
 us: the computer is not a fad. It is  
 here to stay. With all of its problems,  
 there are few companies which  
 would even consider returning to  
 manual performance of clerical oper-  
 ations. The old man with the green  
 eye shade on the high stool made  
 mistakes too. Perhaps not on the level  
 of the computer, but then he didn't  
 have the opportunity.

GEORGE W. COVILL  
*Silver Spring, Maryland*

## Hic town

Sir:

I recently gave a party for which I  
 programmed and set up a PDP 8/L at  
 home to entertain house guests. The  
 system consisted of a 4K PDP 8/L  
 minicomputer with the peripherals  
 consisting of a tty and a Sykes cas-  
 sette tape transport. A program  
 called HOST, which remained core res-

ident all night, was ready and able  
 at any time to load one of five differ-  
 ent programs depending on the opera-  
 tor's selection. The programs avail-  
 able to the guests were, "The Little  
 Old Joke Teller" (jokes rated G, R,  
 and X), a "Calendar" program which  
 would translate a date into a day of  
 the week, a dice game, a blackjack  
 game and a software routine that  
 would play musical tunes with the  
 aid of a nearby radio tuned between  
 stations.

The computer system was the hit  
 of the party, and as you can guess the  
 "X" rated jokes were by far the most  
 popular item. It was amusing to see  
 the girls continually sneak over to the  
 keyboard and request an "X" rated  
 joke. Considering the amount of  
 drunken abuse the system received, it  
 ran like a champ all night without  
 going down once. I caught my breath  
 at one point during the evening when  
 a guest accidentally poured a whis-  
 key sour down the mechanism of the  
 printer.

There is one drawback to the  
 whole situation; that is, what do I do  
 now for the next year's Christmas  
 party?

EDWARD L. PAVIA  
*Rochester, New York*

Hire the Astrodome. Use a 7600.  
 Program a Bacchanalia. Keep it inti-  
 mate.

## Bennett's tenets

Sir:

I read with interest the reported  
 comments of Dr. Edward Bennett,  
 former Viatron President, regarding  
 the subject of raising venture capital  
 (Dec. 15, '70, p.61).

The comments imply an existing  
 dichotomy between two opposing  
 teams, management and investors.  
 For this reason it is possible to de-  
 scribe the situation as two-sided,  
 with different interests and motiva-  
 tions for each side.

With respect to these ideas, I  
 would like to express a different  
 point of view. Investors and manage-  
 ment should provide their respective  
 talents toward a common goal—the  
 success of the company—and thus  
 must be on the same side. The entre-  
 preneur who starts a business by  
 soliciting the help of others may find  
 it more effortless and rewarding if he  
 is careful in choosing investors who  
 have very similar desires regarding  
 the direction that things should take.  
 For this reason, no lies are necessary,

# Bet Our LI/ON™ Can Make Your 1130...ROAR!

Ever see an 1130 spring to life with on-line teleprinters, teletypewriters, graphic CRT's, paper tape/card readers, even analog control instrumentation? Well, our LI/ON (Logicon Input/Output Network) can make one 1130 look like 15 rooms full of computers running rampant. Conversing fluently with up to 32 Selectrics/Teletypes/CRT terminals, and all sorts of digital/analog devices. Bounding a generation ahead into real-time data acquisition and process control. Trafficking simultaneously in the areas of data communications and digital/analog instrumentation. Interacting at the very source of data origin, R/D labs, front office, factory floor. You can even dial in and compute from home phone and remote locations. LI/ON features fast delivery; low cost; and a bundle of software in the bargain.

For complete details call Lee Eckert collect or write him today.



**ROAR**

**GET A LI/ON AND HEAR YOUR 1130  
ROAR ITS APPROVAL.**



Del Amo Financial Center  
21535 Hawthorne Blvd.,  
Torrance, Ca. 90503  
Telephone (213) 542-7313

**LOGICON** LOGICON'S OTHER OFFICES ARE LOCATED  
IN SAN DIEGO AND WASHINGTON, D.C.

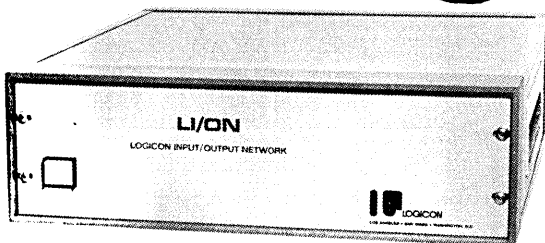

## Letters...

and the team of management and investors is strengthened by the recognition that the different talents of the forces involved can be concentrated on the real and well known situation at hand.

The entrepreneur starts the business and expects to obtain monetary rewards for his efforts; therefore, when he spends money he spends the money of the team, which means that he partially expends his own wealth. It may be preferable to start an enterprise whose building blocks exhibit a natural harmony with each other so that no extraordinary constraints have to be designed to keep the system from falling apart.

One characteristic of the concept of growth is that it implies a continuous change in size, and the most normal and acceptable direction is that one always starts small, becomes bigger and continues to grow according to the fit between the organism and the environment.

RENN ZAPHIROPOULOS  
Cupertino, California

### Up the drawbridge

Sir:

Your Jan. 1 issue includes reviews by your contributing editors of what happened to our industry in 1970. Howard Bromberg asks where all the progress went; Philip Dorn declares that the computer professional has little stature outside his own little world. In expressing these opinions they acknowledge that things have been this way for a long time—too long in fact. You may recall the push two years ago (or more) for a vice president of administrative services or of information services—the titles varied—who would be a computer man and who would report directly to the president. This was seen as a prerequisite to the application of information technology the right way as opposed to the old way.

The problem which seems to persist is the two-jump gap between the user of the computer and the professionals who stand guard over the hardware. The business user perceives the organizational and policy inertias within which he works and reacts away from the high-sounding gobbledegook in which the professional expresses himself. The professional wants to start clean and is unwilling to address inertial-type problems. At the first sign of nonacceptance by some peasant of an executive vp who can't spell BTAM, the

professional falls back on his ivory tower and pulls up the drawbridge.

Perhaps the picture is not as bleak as Messrs. Bromberg, Dorn, Marienthal, and McCracken would have us believe. On the other hand it doesn't take a Bill Buckley to defend the thesis that computer professionals who are pound for pound the best trained brainpower in the West are erratically employed on poorly conceived projects and are subjected to stifling, multilayered managements under organizational structures which should have been buried in the '60s.

We have a bagful of rhetoric; do we have any solutions? One proposal is that if the user takes a leap from his side and the professional one from the other side, the two-leap gap will disappear—as will the personnel! In the past we have cast the systems analyst in the role of bridge-builder. I believe we have to continue the development of this type of individual. He tends to be mistrusted by the computer professional because he is something of a generalist; he is mistrusted by the user because of his technical association. Somehow the "power elite" must screw up their courage enough to trust the system analyst.

JAMES C. HAMMERTON  
Pittsford, New York

### A measure of concern

Sir:

Re: "Needed: A Measure for Measure," by R.R. Johnson (Dec. 15, '70, p.22).

With the changing industry emphasis from hardware improvements towards greater utilization of existing systems, this reader agrees that there is an urgent need to develop a firmly based body of knowledge to measure the capability and capacity of equipment on hand. In analyzing a system's effectiveness, there is another important factor to be considered, namely, the effectiveness of the programmer, his techniques, and resultant program. While the various approaches described by Johnson focus on the measures for hardware "capabilities," the variety of software techniques applied by programmers can directly affect and even diminish the system's effectiveness and utilization. Thus it is suggested that a coefficient (if not a third integral) reflecting programming/programmer efficiencies be applied to Johnson's equation for throughput.

This factor is particularly impor-

tant in determining Class IV-Operating Measures since the data processing manager is concerned with all operating and throughput aspects of the computer center.

Although this factor appears as a simple coefficient to Johnson's equation, it is recognized that this measure is not easily determined. There is a great need to develop a set of measures for "peopleware" along with hardware and software in order to establish a complete system measure.

E. A. BEHRENS  
Cherry Hill, New Jersey

### The graduate

Sir:

I go along with Mr. Leslie Balter, that edp schools do fulfill a necessary need (Jan. 1, p.12).

I graduated from a private edp school in September, 1968, and am proud of it. I am not reluctant to admit it, and I feel they did a good job.

I guess I was lucky in getting a programmer's job before I graduated from school, as I know some of my friends could not get a job without experience. It seems like every place you go they say "We want someone with experience." How in heaven's name do you get experience, except for someone giving you a break and hiring you upon graduation.

It's just disgusting—people in the edp field, crying the blues that they need help, that there will be hundreds of openings in the edp field, yet they will not hire the people without experience.

I feel this is a subject that needs some work on.

LES W. CHITTENDEN  
Silver Spring, Maryland

### Average comment

Sir:

If the average height of an American is 6 feet, and that of others on the Earth is 5 feet 6 inches, then the average height of an inhabitant of the Earth is 11 feet 6 inches. So implies the respected Mr. Kolence, on page 36 of the January 1 issue. Had he used the same denominator in both averages, namely  $n$ , he would have been all right in that case. In general, averages should be combined with caution, like water and sulphuric acid.

ARNOLD I. DUMEY  
Princeton, New Jersey



# DEC now provides national service on key Tennecomp peripherals.

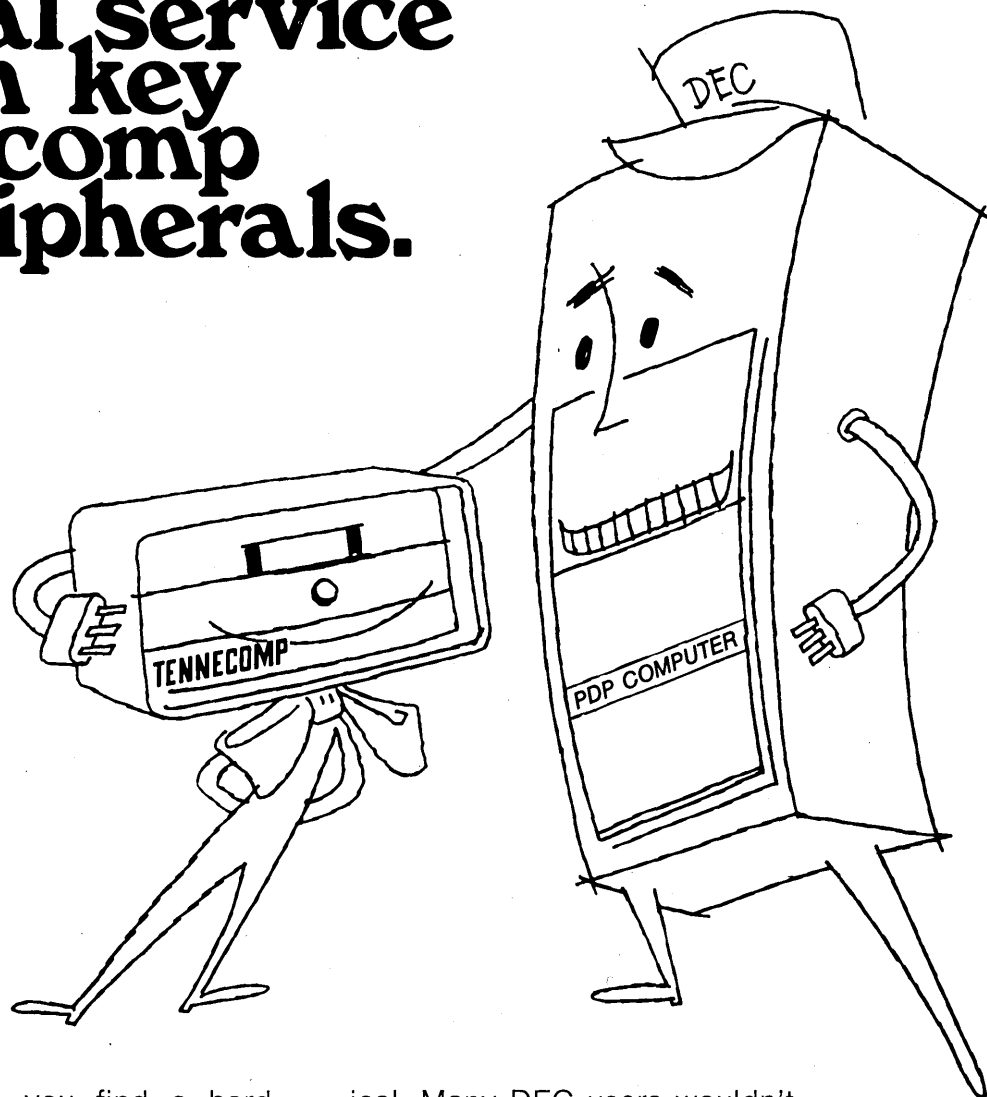

Everywhere you find a hard-working DEC PDP-8, 9 or 11, you're liable to find a Tennecomp peripheral helping it work harder and faster. So DEC has agreed to look after our key peripherals "like one of their own." In fact, you might say they were meant for each other. Tennecomp peripherals have a plug-to-plug compatibility with DEC's minis that has proven both dependable and econom-

ical. Many DEC users wouldn't be without our peripherals. So DEC has agreed to back them up.

For more information on this unique service agreement covering TP-1351 Magnetic Tape Unit, TP-1346 Automatic Tape Loader and TP-1369 Push Button Program Loader. Call Bob Borshay. Area Code 615/482-3491.

**TENNECOMP SYSTEMS INC.**

TENNECOMP SYSTEMS, INC. □ 795 OAK RIDGE TURNPIKE □ OAK RIDGE, TENNESSEE 37830

**We're not going to try  
and tell you our  
new, back-coated tape  
is different.**

**We're going to show you.**

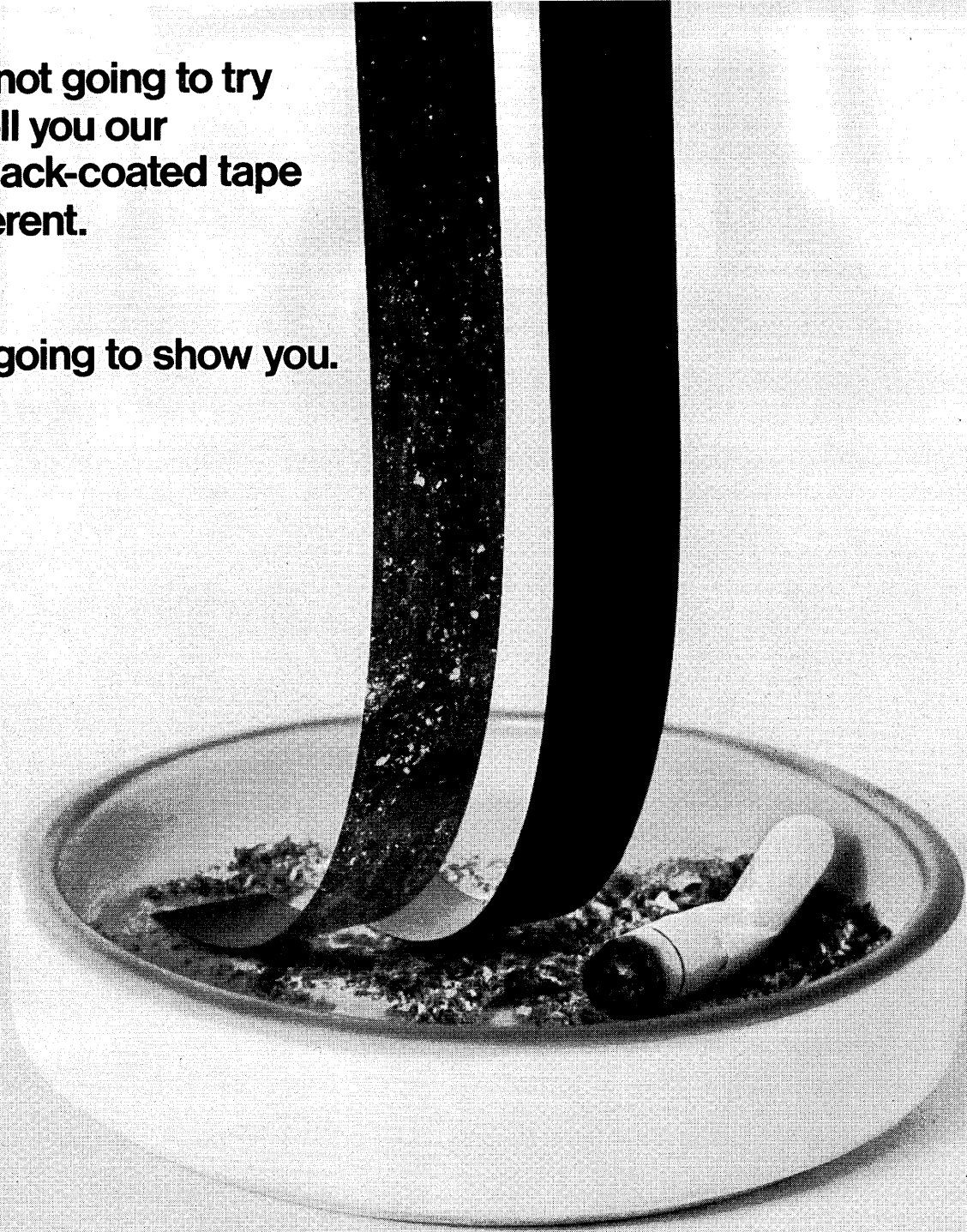

Memorex Computer Media  
1200 Memorex Drive  
Santa Clara, California 95050

I'd like a free "Prove-It-Yourself Kit," with tape samples and an official Memorex ashtray/coaster.

\_\_\_\_\_  
Name Title

\_\_\_\_\_  
Company Phone

\_\_\_\_\_  
Address

\_\_\_\_\_  
City State Zip

Memorex back-coated tape (right) won't hold a static charge. So error-causing debris just can't collect like it does on conventional computer tape (left). There's new back-coated Astron, a durable work tape for your heavy-usage applications, and Quantum CX, a premium tape for long-term storage of your most critical data. Ask your Memorex sales representative for a demonstration. Or mail the coupon today.

**MEMOREX**

# DATA ACTION CHALLENGE:





# WE CAN SOLVE MORE OF YOUR INPUT COST PROBLEMS BETTER THAN ANYBODY CAN!

Data preparation is our business: finding easier, faster, more accurate ways to do it.

Every person at Data Action is committed to computer input—with one goal—to cut your input costs. We make our living doing it. And we do it with a system approach that can save you, in hard dollars, up to 50% of your total data preparation cost—and as much as 30% of your total data processing dollar.

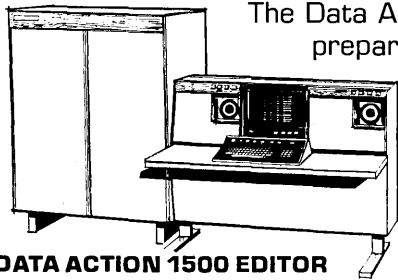

**DATA ACTION 1500 EDITOR**

The Data Action system prepares information for your computer—from the time your source document is created until you address your master file.

The system gives you faster, simpler data preparation. It can eliminate pre-processing runs on your computer. You make one trip to your computer room with completely accurate information.

Two Data Action entry units are available with the system: The 150 Magnetic Data Inscrber and the 220 Typescribe. Choose the one best suited for your requirements.

The 150 Inscrber is a key-to-tape entry unit for use in a central data preparation location. It operates like the keypunch, but without its mechanical limitations. The operator can work faster and more efficiently.

The Data Action Typescribe captures data on magnetic tape at its source. Any typist can use it. It employs a standard IBM Selectric typewriter.

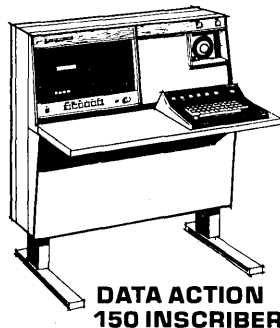

**DATA ACTION 150 INSCRBER**

Data is recorded on tape as the operator types hard copy. The Typescribe eliminates two costly, slow steps in standard data preparation: keypunching and key verifying.

Data keyed on the 150 Inscrber and the 220 Typescribe (as well as the IBM MT/ST) can then be processed by the 1500 Data Editor.

The Editor handles editing of input data automatically, to your criteria. It puts data into final computer-ready form. It eliminates expensive pre-processing runs on your main-frame and eliminates costly machines and operators for entering verified input data.

The ability to perform conditional verification adds to the unique advantages of the Data Action system approach. You eliminate up to 100% of key verification.

The Data Action input system also makes available a tape unit for output on 7 or 9 track compatible tape in all densities (including 1600 BPI)—and a full line of printers from 300 to 1200 lines per minute.

We believe we can solve more of your input cost problems better than anybody else. Why not make us prove it?

Contact your nearest Data Action Sales Office. Or write; DATA ACTION, Dept. A9071, 4445 West 77th St., Minneapolis, Minn. 55435 Phone 612/920-9200.

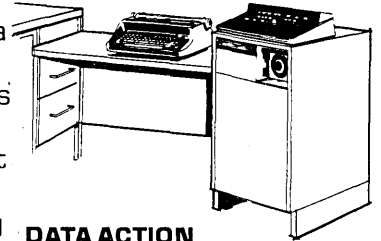

**DATA ACTION 220 TYPESCRIBE**

**DATA ACTION**  
THE INPUT COMPANY



Meet the CartriFile® Model 4196 System:

# The 12 megabit mini-mate

Imagine: a new four-transport magnetic tape system for minicomputers that stores up to 1,250,000 8-bit data words — far more than any other tape system you can economically link to your minicomputer.

The storage capacity of each tape varies with the tape length, number of bits per word, and number of words in each record. Standard cartridge tape lengths are 10, 25, 50, 100 and 150 feet. Each cartridge contains two tapes.

With 150-foot tapes, each of the four tape loops is capable of holding over 3 million data bits.

But you'll get much more than high capacity.

You'll get a high data transfer rate: 18,000 bits-per-second.

You'll get a level of data reliability found only among the largest, most sophisticated systems; applications even include business data processing. You can select 8, 12, or 16-bit computer words.

You'll get four tape transports which let your minicomputer separate, sort, match or merge quickly and conveniently — making your minicomputer a true EDP center. You'll even get a cartridge warranty for 200 operating hours.

Add it all up and you'll find the CartriFile Model 4196

System is truly a minicomputer tape unit with far more capacity, speed, accuracy, and flexibility than any other you can find.

Price: \$6,050 complete with interface, cabling, basic software — everything you need to connect to your computer.

For full information, just call or write: TRI-DATA,  
800 Maude Avenue, Mountain View, California 94040,  
(415) 969-3700. Ask for your free copy of our new CartriFile  
System brochure.

CartriFile is a registered trademark of Tri-Data Corporation

TRI-DATA

CIRCLE 20 ON READER CARD

# LOOK AHEAD

MOVE OVER, MOVE ALL  
THE WAY OVER TO 370

Reports trickling in substantiate rumors that many IBM 360 customers aren't moving up to System 370. Instead they are moving sort of sideways--size-wise and dollar-wise. This lateral movement, which one private survey says accounted for half of its sampling, comes in two forms. Either the user is trading his 360/50 processor for a 370/145 or his 65 for a 155, or he is consolidating. Examples: Two 50s, a 40 and three 30s will be replaced by two 155s; seven Mod 30s will go back for two 155s; and three 65s will be returned for two 165s. Where feasible, these economy-minded users are keeping their present 360 peripherals. Thus, on a processor basis, IBM gains little revenue in some cases and actually loses in others.

The money starts pouring back into the coffer with orders for new items like the 3330 disc drive, and since this is the stone age of the 370 and unbundling evolution, the lateral moves seem only a temporary setback.

DALLAS FIRM STRIKES  
OIL IN TROUBLED WATERS

A company lately beset by financial difficulties, Data Automation Co., Dallas, (president James E. Devlin resigned to be replaced by Loyse E. Caldwell) can boast a bright side in the continued profits of one of its subsidiaries, Data Automation Services, a broker of used edp systems, with six installations in the past six months. A DAS spokesman stated that "a lot of firms, many of them in Fortune's top 500, have decided the 360 series will serve their edp needs for up to five more years; so these companies that can borrow near the prime rate of 5½-6% can buy a used 360 system for perhaps 60-65% of its original price, compared to a new 370 at as much as 7¼%." DAC is now in the process of refinancing, hoping to reprieve both itself and the 360 line.

HONEYWELL SAYS IT WILL  
STAY WITH 8200 SYSTEM

Honeywell (HIS) emphasizes that the new 6000 lines does not mean withdrawal of its 8200 system or its support--now or in the future. Contrary to DATAMATION's report (March 1, p.42), HIS says it had no plans to develop the 8200 into a line of large scale systems. It does intend to make 8200 enhancements, to be announced within the next few months. HIS has more than twenty 8200 installations, including Metropolitan Life, General Motors, and two utilities, Tenneco and Texas Eastern. About 15 more are on order. All are former 800 System users. Startup software problems have been corrected, HIS says.

CALL-A-COMPUTER  
CALLS ON HONEYWELL

Almost half the 570 customers of Call-A-Computer, the GE 265-based time-sharing company, are also hooked onto large, fast-response equipment of other t-s companies. This month CAC announced it's going after them with a Honeywell 6040 (1.2 usec cycle time for 36-bit words), newly-installed at the Santa Ana, Calif., headquarters of Standard Computer Corp., CAC's parent

firm. It also will offer dedicated application services on Standard's IC 7000, a large scale microprogrammed computer, also in Santa Ana. First customer on the 7000 is Northwest Bell and a second is about to be signed. CAC will continue to use 265s in centers at Los Angeles, Minneapolis, Boston, New York and Raleigh, N.C.

Meanwhile, Standard has bagged its first two customers for the IC 7000 which originally was built for CAC. Stanford University will take delivery in April. An aerospace company, which didn't want its name disclosed, installed one last month.

## NEW BUSINESS FOR T-S FIRMS?

A few time-sharing system users are beginning to get the idea that the best place to get an operating system is from time-sharing service vendors who have sunk a bundle into development and improvement. Allen-Babcock Computing, Los Angeles, which has leased RUSH to one user in California, is now talking to three European firms interested in RUSH for internal operations and t-s sales. A-B has signed up for an IFIP Congress booth, by the way. National CSS, Stamford, Conn., is also dickering with prospects for its VP/CSS System (a version of IBM's CP/CMS) for the 360/67. It claims that in the first lease, to Standard Oil of California, it had VP/CSS in full operation within 10 minutes.

## VIP FOR SALE

VIP Systems, Washington-based on-line text-editing firm, is for sale. Discussions have been held with "several" possible buyers, we were told. One of these might be UCC. VIP reportedly wants to merge because of any or all of these reasons: Prexy Joan Van Horn's desire to stay home with her 8 month-old son; her belief that the future in time-sharing belongs to suppliers larger than VIP is now; VIP's substantially increased dollar losses in '70 vs. '69 (January '71 was profitable, though); the cost and time drain of VIP's anti-trust suit vs. IBM.

## RUMORS AND RAW RANDOM DATA

The Feb. 9 Los Angeles earthquake, a business boon to bottled water dealers and home repair companies, did not do much for computer industry vendors, but at least one outfit has hopes. Information Processing Systems, Inc., Englewood Cliffs, N.J., a used computer company, ran an ad in the Los Angeles Times offering to replace quake-damaged equipment "quickly and at low cost." They had no nibbles, but a spokesman says, "at least it was good exposure..." Looks like Memorex won't get the contract to produce Honeywell's new disc drive. We hear that CDC is hot after the order now...A well known, influential computer scientist active in standards work discovered to his horror recently that he couldn't figure out how to hook up to a time-sharing service via an acoustical coupler from his house. He has a Princess phone. A standard dilemma?...Subject of a recent debate by the Bristol/South Wales branch of the British Computer Society: "This house considers that it will no more prove possible to develop ethical standards for the world's youngest profession than for its oldest."

# modem with a future

**RFL building block  
modems let you upgrade  
by changing modules.**

When you rent or purchase an RFL Data Modem, you're protected against obsolescence. You simply change plug-in modules to increase speeds or to meet changing requirements.

But this advanced modular design is only one advantage of RFL modems. We make them for just about every computer, data terminal and time-sharing application. Long experience with industrial applications in a wide variety of fields has resulted in commercial modems of highest quality and dependability, at modest cost. RFL modems let you multiplex up to 8 full-duplex systems on a single circuit, for *substantial* savings. Automatic answering capability is available. New RFL equalizer modules make possible flat delay and/or amplitude char-

acteristics in high speed transmission applications.

RFL equipment is backed by a national service network. Investigate *all* the important RFL features. Send today for our new comprehensive booklet on RFL Data Modems. RFL Industries, Inc., Communications Division, Boonton, New Jersey 07005. Tel. (201) 334-3100 / TWX: 710-987-8352 / Cable: RADAIRCO, N. J.

DATA COMMUNICATIONS AND THE DATA BOOKER

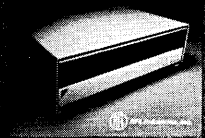

 **RFL Industries, Inc.**

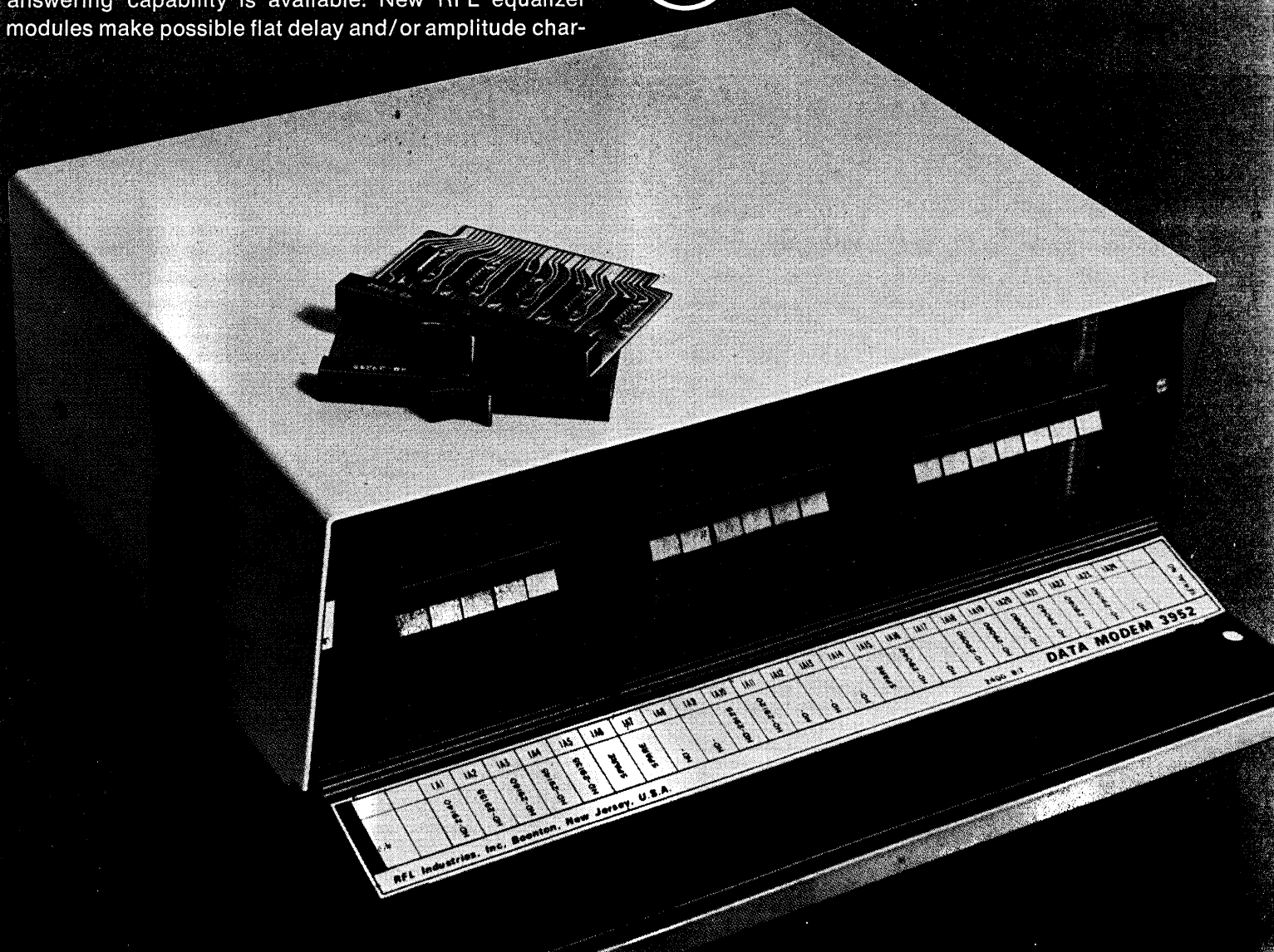





## The Peripheral Processor.

Put most simply, the new MDS SYSTEM 2400 gives you greater I/O services. It's something like a maxi-channel, and something like a mini-computer. Except that it does more, and costs less, than either. That's because we make all the elements that go into it.

### Data-Editor



The heart of the system is the new 2405 Processor.

With up to 32 K bytes available, it can take quite a load off your frame's shoulders. And we have a new language to run the system—a language that anybody in the world can learn in three days. That should take

quite a load off your programming shoulders, too.

### Data-Printer

Configure it yourself. Because it's modular, the 2400 can be dedicated to do your specific jobs, in a cost range starting at \$600.

In its expanded configuration the 2400 edits input, edits output, sorts and merges magnetic tape, reformats and prints, commits reference data to disc, and gives you high speed BSC data transmission.



# Data-Communicator

As an editor, the 2400 will take raw keyboard data and rearrange, reformat, perform any kind of validity checking, range testing, sequence checking, and conditional value testing. It will pool or merge data from various keyboards or from different media. It will select and sort the records needed for a particular run. It will produce one edited reel of magnetic tape ready for processing.

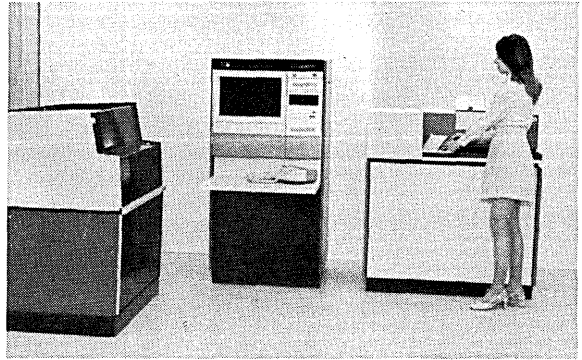

# Data-Converter



As a communications terminal, the 2400 can take a tape that wasn't originally edited for communications and transmit it in compressed, control-coded format. It can convert data received in any code or format, and it will translate, reformat, and output data any way you want. The 2400 can go from any one medium

to any medium or mediums your computer prefers.

# Data-Sorter/Collator

As a converter, 2400 can convert from cards, mag tape, paper tape, communications, and keyboard—to cards, mag tape, paper tape, communications, and line printing.

The 2400 can, in fact, satisfy all your utility needs with off-line simplicity. It's our new generation of peripheral control, timed to meet the newest generation of computer equipment.

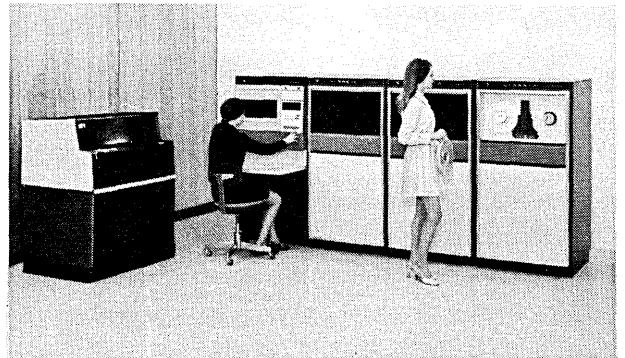

Mohawk Data Sciences Corp.  
Herkimer, New York



**Mohawk Data's System 2400. Peripherals come of age.**

## Design sophistication and teamwork are needed

# The Remote World of

**T** Digital communications have added a new dimension to the family of telecommunications. To many commercial firms, this is a relatively new and uncharted field. But some firms have begun to exploit this facet of data processing.

The difference between digital telecommunications and batch processing systems may be defined as: Digital telecommunications are random and unscheduled inputs from remote locations primarily involving message switching and data exchange, normally using assembler language; while batch processing is scheduled and usually local serial inputs of card, paper tape, or magnetic tape, primarily involved in business and scientific applications, in such higher level languages as COBOL, FORTRAN, and PL/I.

Digital telecommunications systems have a common base. Information must be transmitted from one point to another via a physical wire channel or atmospheric radio signals, using electronic or electro-mechanical transmitting and receiving devices. The distance can be a few yards or thousands of miles. The common base is the transmission facility (channel or circuit) over which the information is passed. The grade or identification of a telecommunications (wire) channel is based on the information-carrying capability as determined by its baud or bit speed. Channels are referred to as voice grade, subvoice, and telegraph. These telecommunications channels and

their characteristics will be described later.

This article will give a brief history of message switching systems and discuss principles of functional design and implementing and testing concepts for digital communications in message switching applications. The material is presented as an overview concerning the operational design and functional aspects of digital message switching and not the engineering and system design studies. However, some technical aspects of transmission modes, code selection, hardware, and channel characteristics will be discussed.

### Background of message switching

On May 24, 1844, when Samuel F. B. Morse transmitted his famous message, "What hath God wrought!" 40 miles from Washington to Baltimore, he gave birth to telecommunications. Morse's telegraph system was the forerunner of the on-line digital telecommunication systems of today.

The military, in joint ventures with commercial carrier firms and equipment vendors, has made many innovations in the field of telecommunications, particularly in digital message switching systems. Owing to the logistic and organizational (worldwide) structure, the military, by necessity, is at the far fringes of the "science" of digital communications and message switching.

The manual torn-tape Teletype method was the

# Digital Switching

by William L. Harper

first generation of message switching. This system required information to be teletyped (punched) on paper tape in a 5-bit code. The code, represented by one to five holes punched through a paper tape (see Fig. 1, page 24) is known as the Baudot code and requires five bits to represent an alpha or numeric character. The bit pattern of the code can be manipulated to allow a maximum of 32 characters ( $2^5$ ) to be represented. The 26 alphabetic letters and the 10 decimal figures could not be represented by the 32 characters of the Baudot code. To overcome this, some alphanumeric characters were assigned the same 5-bit code combination. A 5-bit figures-and-letters code was added to represent an upper case (FIGS) and a lower case (LTRS). By adding the two extra codes, the number of characters and special symbols that could be represented by the Baudot code was increased to 57.

After preparation of the tape or receipt of messages from a remote terminal, the operator would manually tear the message from a spool of tape affixed to the teletypewriter and hand carry it to a transmitting device for transmission over a telecommunications (telegraph) channel connected to the addressee. All in-house processing was performed manually, and switching or routing of messages was determined by a unique routing indicator (code) assigned to each addressee. Transmission speed was 60 wpm. Message switching and information exchange were cumber-

some and slow. Reliability of the network rested with the communications center operator. Error checking and controls were left to his discretion. Many messages were lost or subjected to excessive delays due to human errors.

In a search for a more reliable and faster system, a semiautomatic switching network was implemented. This second-generation network used the Baudot transmission-code structure but utilized a continuous paper tape method instead of the torn-tape concept. Transmission speeds varied from 60 to 100 wpm.

The concepts of operation were primarily the same as those of the torn-tape. Some in-house processing was automated. Upon receipt of a message, the routing indicator was interpreted by the operator, and a push button corresponding to the desired addressee was depressed on the routing indicator panel. The significant difference between the torn-tape and semiautomatic network was that the latter did not require tapes to be physically handled, torn, or "walked" from a receiving position to a transmitting machine. The message could be "automatically" transmitted from the same position where it was received by pressing a button.

Moving from the torn-tape to the semiautomatic required more sophisticated hardware and a higher degree of operator training and competence. Certain control functions were added to the message format to facilitate machine processing. These control func-

# Digital Switching . . .

tions, placed in the message format at designated places, prevented messages from being lost, delayed, or misrouted. For the most part, the reliability of the system was shifted from the communications center operator to the operator who prepared the tape at the originating station.

The semiautomatic system was more efficient and faster than its predecessor. But the reliability of a message getting from point A to point B was not significantly improved. Interpreting message routing, detection and correction of errors, and most of the message processing were still left to the discretion of the operator.

## Increased reliability

With the advent of the aerospace age, a more reliable switching network was sought, with less dependency on the human factor. In the mid-'50s, the Air Force implemented a fully automatic paper tape message switching system using the Baudot code

speed, digital telecommunications message switching network that performed those functions electronically, under the control of software or hard-wired programs.

The significant features of this fourth generation of message switching were:

1. Signalling speeds up to 4,800 bps, or 6,000 wpm.
2. Transmission and processing code of eight bits, seven information bits and one parity bit, for a total of 128 different code combinations to represent a data character or control function, vs. 57 for the 5-bit Baudot code (see Fig. 2).
3. Code conversions capability.
4. Automatic error detection and rejection of erroneous messages prior to entering the system.
5. Automatic recording of errors and other journal recording for historical and statistical purposes.
6. Recording and storing messages on magnetic devices vs. paper tape.
7. Electronic surveillance of messages to prevent

FIGURE 1

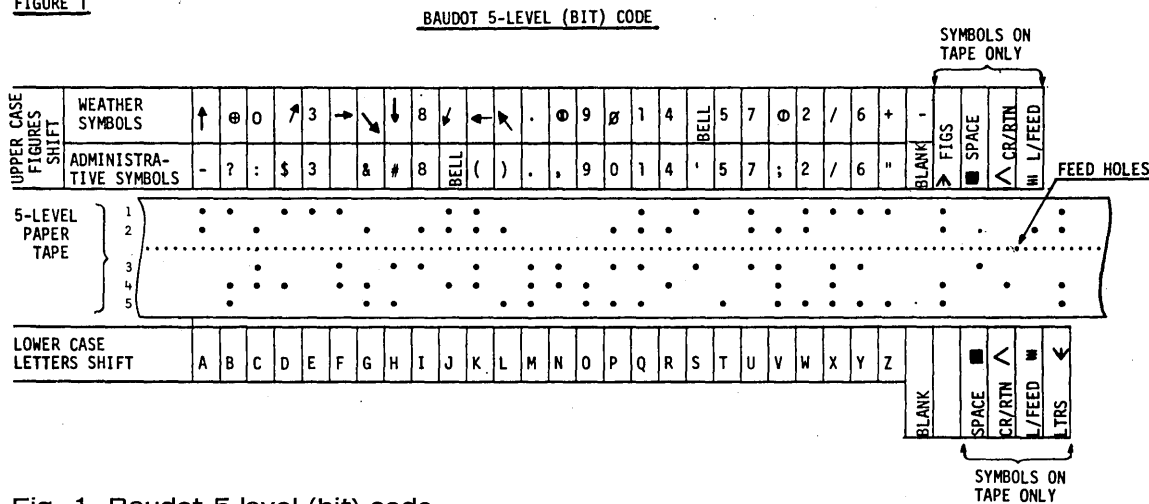

Fig. 1. Baudot 5-level (bit) code.

structure with center-to-center speeds of 100 wpm and cross-office speeds (within centers) of 200 wpm. With automatic switching, routing indicators and control characters were machine interpreted, and messages were automatically routed without intervention by an operator.

This third generation of message switching speeded up and facilitated message processing and information exchange. Invalid routing indicators, and garbled and incomplete messages were machine detectable. But the speed, reliability, and responsiveness were not sufficient to meet the aerospace demands for information handling. The system had two inherent weaknesses which prevented the network from being totally reliable: (1) there were no automatic controls to prevent erroneous messages from entering the network, and (2) too much discretion was left to the operator for message correction and control.

In the quest for a totally reliable system that would meet the enormous demands for information exchange, would negate entry of erroneous messages, and would be less dependent on the operator's discretion for message corrections and control, the Air Force, in 1963, with Western Union as prime contractor, implemented the world's first computerized, high-

loss or delays within the center.

8. Electronically switching messages on a priority FIFO basis.

9. Simultaneous message switching to a given number of terminals.

10. Modular hardware and software expansion capability to accommodate up to 250 terminals.

With computerized message switching, the operator acts and/or reacts to the dictates of the system. Once a message enters the system, it is under the control of an electronic (software) environment.

## Functional design

Some networks may require two switching arrangements—digital message switching and a circuit switching system. Message switching involves (1) message (data) collection, (2) message storage, queueing, and retrieval, (3) message processing, which may include altering the message by deleting or adding data, code conversion, and bookkeeping functions, (4) distribution (switching) data to predetermined locations, and (5) on-line message inquiry capability, i.e., remote terminals randomly accessing a data bank in the switching center for data concerning message reruns, and historical and statistical



information.

Circuit switching employs none of the above software techniques. Circuit switching is a point-to-point, circuit-to-circuit arrangement where the switching center acts as a connector of two or more remote terminals, permitting these terminals to exchange messages, and bypass the processing steps mentioned above.

Functional aspects for the operational requirements involve consideration of: (1) data source and input frequency, (2) volume, (3) distribution and data use, (4) center and terminal output requirements, (5) manual vs. automated functions, (6) growth expansion, (7) resources required, etc. The reliability of a digital communications system is in the functional architectural design and not so much the technical (software) development of the system, just as the safety, functionality, and quality of a building rest with the architect. Competent management, testing, and debugging controls should insure that the system is technically developed according to design plans. If the system's blueprints fail to specify the true operational requirements at the outset, the system will go through a costly iterative trial and error period until all functional aspects of the system are met.

A group of individuals who grew up with and understand the old system at the operator and management levels, who have an imaginative and in-depth understanding of present and future requirements, and who understand the technical (hardware/software) and economic advantages of digital communications should write the functional design specifications for the new system.

This team should not function as an *ad hoc* committee. Instead, individual members should do the data analysis and develop the functional specifications for operational features, such as:

1. Volume of data the system is to handle (analysis of terminal and user requirements).
2. Hierarchy (priority) of storage, queueing, retrieval, and switching messages.
3. Routing (switching) requirements, including alternate routes during channel outage or overload.
4. Restart and recovery procedures (for normal and emergency shutdowns).
5. Statistical and journal requirements.
6. Message throughput requirements.
7. On-line message security protection (if required).
8. Message format and control functions.
9. Message accountability during system failure.
10. Error control and correction.
11. Message storage and retrieval during system overload or channel outage.
12. Operator control vs. automatic control by computer.
13. Man - machine communications (computer printouts and operator responses).
14. Terminal control: frequency of input-free entry or scan (polled).
15. Other unique network requirements based on user/customer needs.

The team should meet periodically to review the progress of the design specifications and should consult with the user/customer during the design stages to insure network integrity. Once all requirements have been individually documented, they can be

consolidated into an operational requirements document and be made available to a group of software technicians for program development. Designers must work continuously in a close relationship with programmers until each feature is independently developed and successfully tested and interfaced with all other operational features. Coordination and control are the cohesive elements throughout the writing of the design specifications and the system's software development, testing, and implementation.

The designer should have a working knowledge of

BIT	→ b7	0	0	0	0	1	1	1	1				
POSITIONS	→ b6	0	0	1	1	0	0	1	1				
	→ b5	0	1	0	1	0	1	0	1				
	+ + + +												
	b4	b3	b2	b1									
	0	0	0	0			TEL	BLANK	K	)	0		
	0	0	0	1			#	ACK-1	UC	L	MINUS	-	1
	0	0	1	0				ACK-2	LC	M	+		2
	0	0	1	1			OWD	REQ	LF	N	<		3
	0	1	0	0				WBT	CR	O	=		4
	0	1	0	1			0	REP	SP	P	>		5
	0	1	1	0			%	SOM-L	A	Q	U/LINE		6
	0	1	1	1			¢	ER	B	R	\$		7
	1	0	0	0			BELL	DM	C	S	*		8
	1	0	0	1	IL		&	EOM	D	T	(		9
	1	0	1	0			MC	SOLB	E	U	"	APOS	'
	1	0	1	1			#	EOB	F	V	:	:	:
	1	1	0	0			#	EOLB	G	W	?	/	/
	1	1	0	1			DEGREES°	RM	H	X	!	!	!
	1	1	1	0			0	SOM-H	I	Y	*	LOZENGE	z
	1	1	1	1			TAB	0		J	Z	@	IGNORE

FIELDATA 7-level (bit) plus 1 parity bit code is used as a standard military code in some digital communications systems. Out of a total of 128 code combinations, only 94 are used to represent either an alpha, numeric, symbol, or control function. Some code combinations may have been altered by extending or deleting some control functions or symbols to conform to system requirements.

LEGEND:

IL	Idle Line	SOLB	Start of Line Block
TEL	Teletype Assignment	EOB	End of Data Block
OWD	One Way Delete	EOLB	End of Line Block
MC	Mode Change	RM	Reject Message
ACK-1,2	Acknowledge	SOM-H	Start of Message High
REQ	Request	UC	Upper Case
WBT	Wait Before Transmitting	LC	Lower Case
REP	Repeat	LF	Line Feed
SOM-L	Start of Message Low	CR	Carriage Return
ER	Error	SP	Space
DM	Disregard Message	TAB	Tabulation
EOM	End of Message		

Fig. 2. 7-level FIELDATA (military) code.

the computer and transmission characteristics, as well as transmission code structures and error detection and correction concepts; otherwise, the counsel and judgment of the vendor may prevail. Unless there is a meeting of the minds, i.e., an understanding of both parties as to the data volume, operational and functional objectives, and the correct hardware system to satisfy these objectives, management may purchase or lease equipment not economically suitable for the network's requirements.

Computer characteristics

Foremost should be (1) modular (both software and hardware) expansion flexibility, (2) internal software (processing) code compatible with the external transmission code structure, (3) interrupts and priority processing capabilities, and (4) I/O buffering and program relocatability.

Number 1 is important because a message switching system should be flexible enough to allow maxi-

mum I/O devices and communications lines to be attached without significantly disrupting operations or requiring major software modifications. Number 2 is important because this will eliminate code conversion routines, conserve core, and save I/O channel processing time in converting from one code to another. For example, when the channel is converting from an internal to an external code or vice versa, e.g., EBCDIC to ASCII, this time would be used for processing data. However, it may not be practical for the network to have a compatible code. To do so may affect the flexibility of the network by limiting the selection of terminal devices because such devices are engineered for different transmission codes.

Number 3 is significant because, when processing messages with different priorities and importance, it would be extremely difficult to process and switch messages without a complicated array of software switches. The interrupt programs for a message switching environment should be on a hierarchy-level, i.e., different types of interrupts based on data processing priorities, automatic control and bookkeeping of interrupts, and an interrupt program with the ability to interrupt and suspend the processing of another program that has interrupted and suspended the processing of a previous program. Number 4 is equally important because a message (or characters) may enter the system at random, independent of CPU control. These messages must be saved temporarily until they can be processed. Separate hardware may be used for buffering; however, some systems may require dynamic core buffering.

The computer should possess a control mechanism, either hardware or software, that will permit programs to be written without the programmer concerning himself with where the program will be located in core when it is executed. Certain hardware registers, known as base, relocation, or index registers, etc., will permit program relocation at any time in a program that is being executed. The interrupt program should control the relocation and return of the program to its previous location, or a different core location, through a series of bookkeeping functions.

Management may not have too much to say about the characteristics or compatibility of equipment or the transmission facilities because they are designed to the manufacturer's specifications rather than the user's. Volume and type of data and throughput requirements will give indications as to computer utilization and the appropriate characteristics such as speed, core size, internal software code, and core modularity.

## Transmission channels

Channels are classified as simplex, half-duplex, or full-duplex. A simplex channel is a single-wire circuit, and data can be transmitted in one direction only. A half-duplex circuit is normally a two-wire circuit and can transmit data in two directions but in only one direction at a time. When speed in transmission is not a major factor, asynchronous mode and half-duplex would be desirable. A full-duplex circuit is normally a four-wire circuit and can transmit data in two directions simultaneously. These three types of channels can transmit data in a serial or parallel pattern in one of two transmission modes— asynchronous or synchro-

nous.

To achieve an economical transmission balance, the choice between a two-wire or four-wire circuit should be measured by (1) data volume, (2) speed and turnaround requirements, and (3) data acknowledgement requirements. In a two-wire channel, transmission is halted to permit the transmission of an acknowledgment. The volume of data derived from one channel can emanate from one terminal or from several on a polled basis (each station sends when electrically called), or on a loop or multipoint circuit, either electronically called or free entry (not under CPU control).

The asynchronous transmission mode is character sensitive. In Baudot, it takes seven bits to transmit an alphanumeric character, five bits to represent the character and a "start" and "stop" bit to separate each character and to synchronize the receiving device with the transmitting device. With an 8-bit code such as ASCII or EBCDIC in asynchronous mode, it takes 11 bits to transmit a character, eight bits (including the parity but in ASCII) to represent the character and one start bit and two stop bits.

Signals are sent on a transmission line either as a mark or space. A mark represents a single bit element of a pattern that represents a character or symbol, or a single mark could represent an alpha or numeric character (see the letter E in Fig. 1). A space represents a negative information bit value.

Synchronous transmission is serial "bit stream" oriented. Data are transmitted in serial bit pattern without the synchronizing start and stop bits. The channel is clocked or sampled at regular intervals by the receiving device to record (normally in a buffer area) the information bit values.

Synchronous channels are more efficient because more data can be transmitted per unit of time than in the asynchronous mode since no transmission time is required for the start and stop bits. Most high-speed terminal devices used in digital telecommunications are equipped for synchronous operation.

Parallel transmission permits sending all information bits in a character simultaneously over separate channels. Normally, parallel transmission is used only a few feet from the computer to the communications control interface device and, from there, data is transmitted in serial pattern.

In digital telecommunications, channel speed or capacity is measured in bits per second or characters per second. Different transmission codes use a different number of bits to represent a character. In order to determine the wpm, this number of bits must be known. (Transmission codes are discussed later.) Characters per second and wpm can be determined by these two formulas:

$$\text{cps} = \frac{\text{bps}}{\text{bpc}}$$

$$\begin{aligned} \text{Where—cps (characters per second)} \\ \text{bps (bits per second)} &= 2400 \\ \text{bpc (bits per character)} &= 8 \end{aligned}$$

$$\text{cps} = \frac{2400}{8}$$

$$\text{cps} = 300$$

Words per minute—wpm (6 characters represent a

standard word in digital communications)

$$\text{wpm} = \frac{\text{cps} \times 60 \text{ seconds}}{\text{cpw}}$$

Where—cps = 300  
cpw (characters per word) = 6

$$\text{wpm} = \frac{300 \times 60 \text{ seconds}}{6}$$

$$\text{wpm} = \frac{18,000}{6}$$

$$\text{wpm} = 3,000$$

### Voice grade channels

A single-voice wire channel has a nominal bandwidth of 4KHz theoretically capable of transmitting 2,400 bps or 3,000 wpm. The voice channel is the basic unit for creating wider bandwidths with a higher bps capacity, permitting a greater amount of data to be transmitted over a channel. In most cases, a line cannot be effectively used at the lowest or highest ends of the frequency cycle range because the outer frequency edges act as a buffer zone to absorb normal interference.

Bandwidth greater than 3KHz for digital transmission was made possible in the late '50s and early '60s by joining computer technology with a telecommunications carrier system. The carrier system is a technique that permits several binary data streams or voice conversations over a single channel by shifting a transmitting frequency to a higher channel range within a single 4KHz circuit, and using this higher frequency band to convey data or voice communications. This technique permits the grouping or combining of these frequency channels (bands) in a special way into a single channel or circuit known as a broadband (sometimes referred to as a wideband) channel.

With modern carrier techniques in circuit disciplines, broadband channels of 8, 12, 16, 24, and 48KHz in bandwidth can be derived from conventional voice channels. These broadbands can be made more flexible by a multiplexing technique. As an example—a bandwidth of 12KHz can be subdivided into four nominal 3KHz voice channels. One channel could be used for voice communications, another for binary data transmission, the third channel for facsimile, and the fourth channel could be multiplexed to provide a number of slow-speed Baudot telegraph channels. (More about multiplexing later.) Bandwidths of 96KHz are possible on a specially conditioned four-wire circuit. Even wider bands with greater bps speed are possible with microwave or coaxial cable channels.

In digital telecommunications, an interface device known as a modem or data set, is tied to a channel to vary or change (modulate or demodulate) a signal to provide compatibility between a transmitting and receiving device and the line. A modem serves several functions: (1) it converts a carrier frequency to a lower frequency suitable for digital transmission; (2) it improves and facilitates sending data bits to obtain an optimum speed; and (3) it protects the signal from certain interferences. But the modem's primary function is to convert (modulate) binary bits, as they

leave the computer or transmitting device, into a frequency signal that the transmission is engineered for, and to convert (demodulate) the signal back to its binary state suitable for the receiving machine. Modem speeds are not related to the KHz capacity of the channel. They are related to the transmitting and receiving devices, and the state of the art in modulating and demodulating methods. The effective modem speeds for noncommon carrier, e.g., Rixon Electronics, range from 45 bps (60 wpm) to 9,600 bps (12,000 wpm) for voice grade leased channels. The

BIT POSITIONS				BIT POSITIONS			
				b1		b2	
b6	b5	b4	b3	0	1	0	1
0	0	0	0	SOH	&	-	0
1	0	0	0	A	J	/	1
0	1	0	0	B	K	S	2
1	1	0	0	C	L	T	3
0	0	1	0	D	M	U	4
1	0	1	0	E	N	V	5
0	1	1	0	F	O	W	6
1	1	1	0	G	P	X	7
0	0	0	1	H	Q	Y	8
1	0	0	1	I	R	Z	9
0	1	0	1	STX	SP	ESC	SYN
1	1	0	1	.	\$	,	#
0	0	1	1	<	*	%	@
1	0	1	1	BEL	US	ENQ	NAK
0	1	1	1	SUB	EOT	ETX	EM
1	1	1	1	ETB	DLE	HT	DEL

With BCD, 64 code combinations are possible to represent Alpha (26), Numeric (10), Symbols (11), and Control Functions (17) to include BELL (BEL) and SPACE (SP). By adding two bits to this code, it becomes 'Extended Binary Coded Decimal Inter-Change Code' (EBCDIC) with 256 total code combinations.

#### LEGEND:

SOH	Start of Heading	DLE	Data Link Escape
STX	Start of Text	ESC	Escape
BEL	BELL	ENQ	Enquiry
SUB	Substitute	ETX	End of Text
ETB	End of Transmission Block	HT	Horizontal Tabulation
SP	Space	NAK	Negative Acknowledge
US	Unit Separator	EM	End of Medium
EOT	End of Transmission	DEL	Delete
		SYN	Synchronous

Fig. 3. 6-bit Binary Coded Decimal (BCD) transcode.

Bell carrier system has modems capable of transmitting up to 230,400 bps over a leased broadband (60 voice-band lines) channel.

### Subvoice and telegraph channels

The subvoice grade of channel falls between the telegraph and voice grade channels and generally has a speed range of 100 to 180 bps or approximately 120 to 220 wpm. This grade channel is serial transmission oriented and can handle any transmission code. Voice transmission is not possible with subvoice channels.

Telegraph grade channels are considered low speed. The normal range is between 45 and 75 bps or approximately 60 to 100 wpm. A carrier technique

# Digital Switching . . .

similar to the carrier system discussed in voice channels permits expanding a voice grade channel into many telegraph channels. This is known as channelizing or multiplexing.

There are two types of multiplexing—frequency division and time multiplexing. Frequency division multiplexing is used in the parallel mode. Each channel is assigned a unique frequency band or cycle. Using this principle, a voice grade channel is divided into several low-speed lines with each line assigned a specific frequency. This permits simultaneous transmission of different information on each frequency band. Time multiplexing is used in serial transmission mode. A voice channel is divided into discrete time slots with each slot transmitting different information from a different input. Several input lines supply simultaneous but different data signals to a scanning

device. This device assembles and transmits a composite signal on a single line to a synchronized scanning device at the receiving end which separates the data signals and distributes them to the appropriate receiving line or device.

In binary synchronous communications (BSC), the data code is “transparent” to the line that transports it. The line serves only to transmit, at various speeds, the signals which represent the data code; the line is insensitive to the code structure.

There are several transmission codes available, but the codes favored are the 5-bit Baudot (discussed earlier), 6-bit BCD, 7-bit ASCII, and the 8-bit EBCDIC.

The Binary Coded Decimal (BCD) is an extension of the Hollerith code (used with EAM cards). BCD is a 6-bit character code and will allow  $2^6$  or 64 total code combinations (see Fig. 3, page 27). More

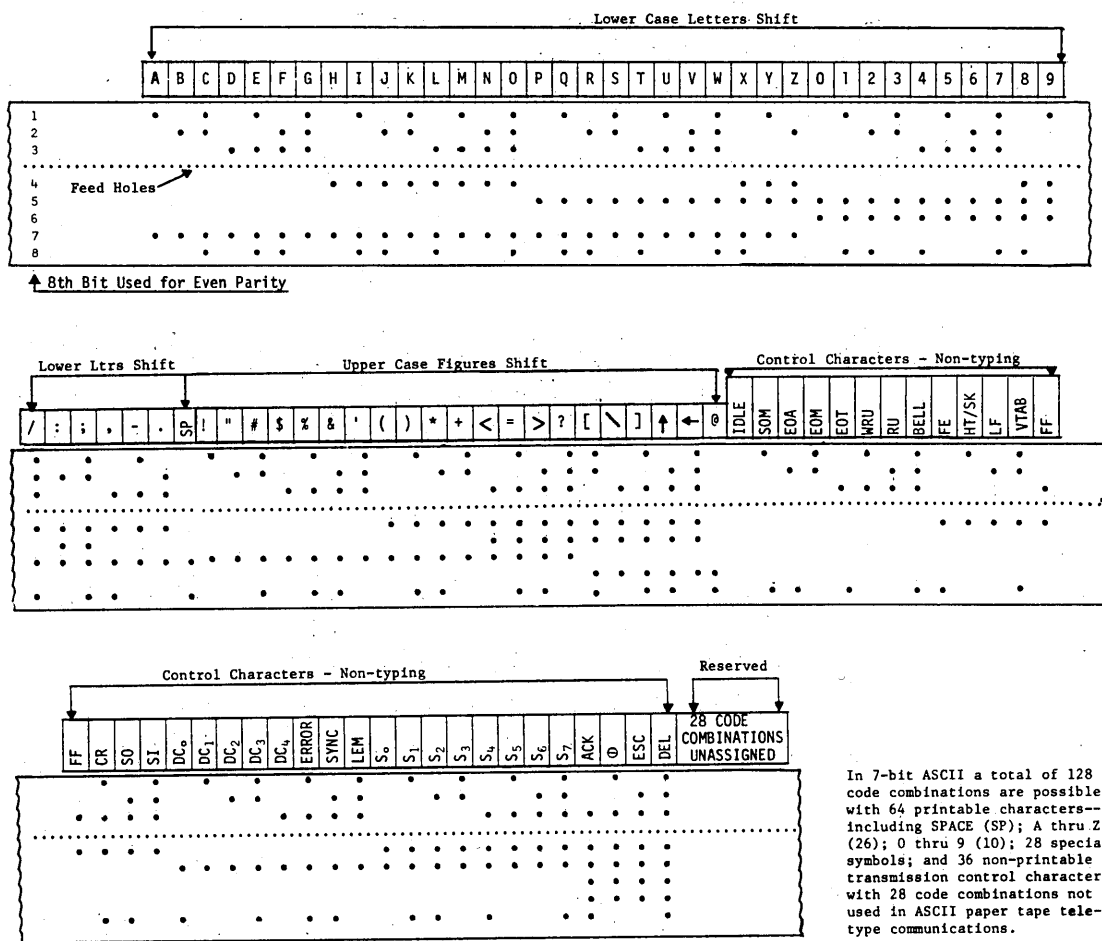

In 7-bit ASCII a total of 128 code combinations are possible, with 64 printable characters--including SPACE (SP); A thru Z (26); 0 thru 9 (10); 28 special symbols; and 36 non-printable transmission control characters; with 28 code combinations not used in ASCII paper tape teletype communications.

Fig. 4. 7-level ASCII paper tape code used with Teletype models 33 and 35.

data can be transmitted per unit of time with BCD than with ASCII or EBCDIC because BCD uses one bit less per character than ASCII and two bits less than EBCDIC. This makes BCD more efficient than either ASCII or EBCDIC because approximately 17% and 33% more data, respectively, can be transmitted. BCD has fewer control bits than the other two codes.

The USA Standard Code for Information Interchange (USASCII—more commonly, ASCII) is an 8-bit code. The code is designed to allow  $2^8$  or 256 code combinations. Currently, only seven bits ( $2^7$  or 128 code functions) are being used for data and control information: 94 alphanumeric and graphic symbols and 34 control code functions (see Figs. 4 and 4A and Table 1). The eighth bit is used for transmission parity

BIT POSITIONS		0	0	0	0	1	1	1	1		
b <sub>4</sub>	b <sub>3</sub>	b <sub>2</sub>	b <sub>1</sub>								
0	0	0	0	NUL	DLE	SP	ø	@	P	~	p
0	0	0	1	SOH	DC1	!	1	A	Q	a	q
0	0	1	0	STX	DC2	"	2	B	R	b	r
0	0	1	1	ETX	DC3	#	3	C	S	c	s
0	1	0	0	EOT	DC4	\$	4	D	T	d	t
0	1	0	1	ENQ	NAK	%	5	E	U	e	u
0	1	1	0	ACK	SYN	&	6	F	V	f	v
0	1	1	1	BEL	ETB	'	7	G	W	g	w
1	0	0	0	BS	CAN	(	8	H	X	h	x
1	0	0	1	HT	EM	)	9	I	Y	i	y
1	0	1	0	LF	SUB	*	:	J	Z	j	z
1	0	1	1	VT	ESC	+	<	K	[	k	{
1	1	0	0	FF	FS	.	;	L	\	l	
1	1	0	1	CR	GS	-	=	M	]	m	}
1	1	1	0	SO	RS	.	>	N	^	n	
1	1	1	1	SI	US	/	?	O	_	o	DEL

**LEGEND**

NUL Negative Value	DLE Data Link Escape
SOH Start of Heading	DC1
STX Start of Text	DC2 } Device Control
ETX End of Text	DC3 }
EOT End of Transmission	DC4 }
ENQ Enquiry (Character)	NAK Negative Acknowledge
ACK Acknowledge	SYN Synchronous
BEL Bell	ETB End of Transmission Block
BS Backspace	CAN Cancel
HT Horizontal Tabulation	EM End of Medium
LF Line Feed	SUB Substitute
VT Vertical Tabulation	ESC Escape Character
FF Form Feed	FS File Separator
CR Carriage Return	GS Group Separator
SO Shift Out	RS Records Separator
SI Shift In	US Unit Separator
SP Space	DEL Delete

**Fig. 4A. 7-level ASCII software code.**

checking. ASCII was chosen by the federal government as the standard transmission and processing code. Military and other governmental agencies are favoring ASCII while many commercial firms are sticking with EBCDIC.

The Extended Binary Coded Decimal Interchange Code (EBCDIC), as the name implies, is an extension of BCD. It requires eight bits to represent a character and allows  $2^8$  or 256 code combination (see Fig. 5, page 30). However, unlike ASCII, all eight bits of the code are used to represent data or a control function.

Knowing the grade definitions and differences between channels and how to recognize a character by the bit code structure are of little significance. Knowing the following is important: (1) how many bits are required to represent a character; (2) what combinations of characters and symbols can be represented; (3) the channel grade and transmission mode

required to transmit the code; (4) channel utilization; (5) throughput and turnaround requirements; (6) code conversion requirements; and (7) error detection and correction methods. This last item deserves further discussion.

Most message switching applications require an error detection and automatic retransmission request (ARQ) capability. The bit configuration that represents the control characters, which determine the message distribution, its priority, and security, must be protected during transmission and machine processing. Error detection and correction becomes more critical in the transmission of perishable data, i.e., meteorological data concerning severe weather warnings to command and control systems. These data must be acted upon by man or machine in real-time, and in addition to the bit configuration mentioned above, each character of the text must be protected.

The type of error detection used depends upon the system's requirements. The most economical and commonly used method is the parity bit vertical redundancy check (VRC) by character and the longitudinal redundancy check (LRC) by message block, sometimes referred to as a two-dimensional parity system. Parity may be even or odd and the check will be both a vertical bit check and a longitudinal (horizontal) check. A one-dimension parity system may be employed by using either the VRC or LRC method. However, the accuracy of the error detection would not be as valid as a combination of VRC/LRC.

The sum of the "one" bits for any single character (vertical check) or group of characters, known as a block (longitudinal horizontal check), will always be even or odd depending on which parity method is used.

To satisfy the odd or even parity arrangement in VRC, an extra bit is added to each character to make the bit configuration odd or even. The receiving device will check each character for the proper bit parity. If the check does not match the odd or even arrangement for the system, a negative check is sent

¢ Cent Sign	¬ Logical Not
· Period, Decimal Point	- Minus Sign, Hyphen
< Less Than	/ Slash
( Left Parenthesis	, Comma
+ Plus	% Per cent
Vertical Bar-Logical OR	_ Underscore
& Ampersand	> Greater Than
! Exclamation Point	? Question Mark
\$ Dollar Sign	: Colon
* Asterisk	# Number
) Right Parenthesis	@ At
; Semicolon	= Equals
" Quotation Mark	' Prime, Apostrophe
^ Exponentiation	{ Left Brace
] Right Bracket	} Right Brace
\ Reverse Slant	~ Tilde
[ Left Bracket	

Note: Certain of these symbols are represented by various code combinations of either Baudot, ASCII, BCD, or EBCDIC.

**Table 1. Graphic symbol meanings.**

to the transmitting device.

In the LRC parity method, characters are grouped into horizontal columns or units known as a block, and depending upon requirements, may vary in length. Each block of data is indicated by an end of block (EOB) control character. To satisfy the LRC odd or even arrangement, a count of the number "one" bits contained in each column is inserted by the transmitting device immediately after transmitting a block of data which is usually one line of data. The receiving device compares this count with the num-



# Digital Switching . . .

ber of "one" bits received. If they are equal, an ACK (acknowledgment) is sent and the next block is transmitted. If the count is not equal, the transmitting terminal automatically retransmits the block. Usually, after three tries without successfully retransmitting the block, an audible alarm or light, or both, alerts the transmitting operator that transmission difficulty is being experienced. The major disadvantage of a simple parity system is that corrections cannot be made.

Other error detection and correction codes are available which may be used with other transmission codes, but they are complex and more expensive than the two-dimensional VRC and LRC parity method. One such code is the cyclic redundancy check (CRC) code. This code adds check bits to the data stream by dividing the serialized bits in a block (similar to LRC) by a predetermined binary number. The remainder, being the check bits, is transmitted to the receiving device where it is compared in a similar arithmetic manner. The use of the code may monopolize as much as 20% of the bit stream for error checking and require expensive circuitry at both ends of the line.

Message switching systems developed without

comprehensive testing and validation of the operational specifications would cause complete chaos when trying to implement and operate the system, and for months would cause frustrating problems, both software and operational. Although programmers may test and debug the individual features or modules of major programs until they are logically correct, when these modules are put together to do a particular processing job, it is imperative that they be tested against the actual conditions as specified in the requirements package.

The measurement of a successful test and the implementation of an on-line message switching network depend on many variables that are not present in a batch system. Errors can more easily be detected and corrected in a batch system than in an on-line system because of the nature of the two systems. In on-line systems, there are fewer stand-alone programs or subroutines. The majority of the programs/routines must interface, process and pass on, and, in some cases, alter data, and perhaps do this at different core address/locations. This makes interfacing numerous interrelated programs extremely difficult, and makes

BIT	b1	0	0	0	0	0	0	0	0	1	1	1	1	1	1	1	1		
	b2	0	0	0	0	1	1	1	1	0	0	0	0	1	1	1	1		
POSITIONS	b3	0	0	1	1	0	0	1	1	0	0	1	1	0	0	1	1		
	b4	0	1	0	1	0	1	0	1	0	1	0	1	0	1	0	1		
	b8	0	0	0	0	NUL	DLE	DS		SP	&	-					0		
	b7	1	0	0	0	SOH	DC1	SOS				/	a	j		A	J	1	
	b6	0	1	0	0	STX	DC2	FS	SYN				b	k	s	B	K	S	2
	b5	1	1	0	0	ETX	DC3						c	l	t	C	L	T	3
		0	0	1	0	PF	RES	BYP	PN				d	m	u	D	M	U	4
		1	0	1	0	HT	NL	LF	RS				e	n	v	E	N	V	5
		0	1	1	0	LC	BS	ETB	UC				f	o	w	F	O	W	6
		1	1	1	0	DEL	IL	ESC	EOT				g	p	x	G	P	X	7
		0	0	0	1		CAN						h	q	y	H	Q	Y	8
		1	0	0	1		EM						i	r	z	I	R	Z	9
		0	1	0	1	SMM	CC	SM		¢	!	:							
		1	1	0	1	VT				.	\$	,	#						
		0	0	1	1	FF	IFS		DC4	<	*	%	@						
		1	0	1	1	CR	IGS	ENQ	NAK	(	)	-	'						
		0	1	1	1	SO	IRS	ACK		+	;	>	=						
		1	1	1	1	SI	IUS	BEL	SUB		¬	?	"						

**LEGEND:**

- |         |   |     |                     |     |                              |
|---------|---|-----|---------------------|-----|------------------------------|
| NUL     | Null                                      | PRE | Prefix              | SI  | Shift In                     |
| PF      | Punch Off                                 | SM  | Set Mode            | SMM | Start of Manual Message      |
| HT      | Horizontal Tabulation                     | PN  | Punch On            | DLE | Data Link Escape             |
| LC      | Lower Case                                | RS  | Reader Stop         | DC1 | Device Control               |
| DEL     | Delete                                    | UC  | Upper Case          | DC2 | Device Control               |
| RES     | Restore                                   | EOT | End of Transmission | DC3 | Device Control               |
| NL      | New Line                                  | SP  | Space               | DC4 | Device Control               |
| BS      | Backspace                                 | SOH | Start of Heading    | NAK | Negative Acknowledge         |
| IL      | Idle                                      | STX | Start of Text       | SYN | Synchronous                  |
| CC      | Cursor Control                            | ETX | End of Text         | CAN | Cancel                       |
| DS      | Digit Select                              | ACK | Acknowledge         | EM  | End of Medium                |
| SOS     | Start of Significance                     | BEL | Bell                | SUB | Substitute                   |
| FS      | Field Separator                           | VT  | Vertical Tabulation | IGS | Information Group Separator  |
| BYP     | By Pass                                   | FF  | Form Feed           | IRS | Information Record Separator |
| LF      | Line Feed                                 | CR  | Carriage Return     | IUS | Information Unit Separator   |
| EOB/ETB | End of Block/or End of Transmission Block | SO  | Shift Out           | IFS | Information Field Separator  |
|         |   | ENQ | Enquiry             |     |                              |

Fig. 5. 8-bit Extended Binary Coded Decimal Interchange Code (EBCDIC).

in-depth testing a logical follow-through in a message switching environment.

*Test material.* Testing requirements, specifications, and procedures, along with keypunch instructions, should be developed by the architectural designers who developed the functional specifications. Equipment configuration and personnel requirements necessary for testing should also be specified. Local testing using in-house equipment may be sufficient for some systems. Others may require, in addition to local input/output, that remote terminals be used to simulate actual live conditions. This would be an ideal method for testing. However, with remote testing (unless part or all of the existing terminals can be made available for testing), additional communication lines and equipment will have to be installed to parallel the existing system. This may be an additional cost that management may not want to incur.

The test should be accomplished off-line with a sufficient quantity of predetermined and prepared testing materials. Test material consisting of dummy messages should be run through the system in sufficient quantities to test the functionality of the design specifications and to insure message protection.

*Test team.* Testing and implementation of the system should be a joint effort comprised of operators, programmers/analysts, and members of the functional design team or committee. A test coordinator should be appointed to direct the testing and implementation. A lead programmer(s) may be a member of the team for software consultation.

*Saturation testing.* During testing, every condition should be simulated with message data to specifically test each feature. Some features, such as message routing, statistical requirements, throughput, and format and control, will be fairly simple to validate. But restart/recovery, message accountability during system failure, and message storage and retrieval during system overload and channel outage will require more involved test procedures. To adequately test these features, the system should be saturated with messages of all categories and the system purposely stalled and restarted to test all aspects of these features. Without a comprehensive and in-depth shakedown, it may take many costly months to render the system reliable.

It is vital that the overload conditions be tested. This should be done by message saturation. The system should be designed so that overload occurs before the system becomes actually filled to capacity. Given a system of different message priorities, classifications, and messages with perishable data, overload should be triggered when the storage capacity has reached 80% to 90%. This 20% to 10% leeway should leave sufficient space to process high precedence and other urgent types of data.

To create an overload condition, more messages will have to enter the system than the system is capable of handling. This can be accomplished by writing test data to magnetic tape, disc, or drum, and then re-entering the data into the system simultaneously. If this is not practical, output channels and devices could be shut down, which would create the same effect. When the system reaches this predetermined figure, the overload feature will activate and low precedence messages will be written to a save area (external storage device). When the system falls

below this figure, data should automatically re-enter the system and be queued for output processing. Some errors may occur only once during testing but when repeating the process that *seemed* to have caused the error, the same error condition will not repeat. Many errors will have to work themselves out over a period of time. Some errors may be caused by hardware or line conditions; such errors may be infrequent, due to random and low-volume input.

*Cutover.* Operator training (both terminal and switching center) should have been accomplished, and operating manuals and other documentation made available prior to final test and implementation. This is necessary to familiarize operators with the peculiarities of the computerized system. After cutover, it may be necessary to run the old system in parallel with the new system until sufficient confidence is built up with the computerized system. At this time the old system may be disbanded.

*Past test observation.* The validity of the system may not be proven until it has been run on-line in a dynamic message switching environment. After the system has been tested and implemented, it should be under close scrutiny for a period of time, and during this time one of the lead programmers and operations analyst should be readily available to correct any software or operational problems that may arise. A system may test out successfully in an off-line environment but when run on-line under live conditions, may experience difficulty. There are certain variables inherent in off-line testing that are not present in an on-line situation. In off-line testing, the input is calculated and controlled. For the most part, testing is done at favorable times when the processing of live messages is low and when the off-line equipment is less likely to be seized for on-line use due to equipment problems with the primary system.

## Summary

Digital telecommunications and message switching principles and concepts are so complex and involved that only an overview can be stated in the few pages of this paper. The information presented here is general in nature, suggesting certain approaches to the functional aspects of the operational design and testing of a digital message switching system. ■



Mr. Harper is presently engaged in systems analysis and technical writing for the Air Force at the Communications Computer Programming Center, Tinker AFB, Oklahoma. He retired from the USAF in 1968 with 20 years' experience in telecommunications and data systems of the DOD's AUTODIN and the Air Force's Automated Weather Network.

## U.S. computer companies face challenge of entering national markets

# '71... the Year EDP

**M** The year of 1971 will be remembered as the beginning of the decade in which all computer companies had to enter the international market as multinational companies in order to maintain or gain an important market share segment of the total hardware and services market. This year is more important than any other past year in the international computer markets because this decade will be characterized by multinational competition of many large computer companies operating locally in many countries as true multinational—not export—companies. The following trends are dictated both by a natural evolution of the worldwide computer markets as well as by specific developments in 1970:

By 1975 the non-U.S. free-world market will have increased in size to 90% of the U.S. market and still have a faster growth rate than the U.S. market.

Honeywell's acquisition of General Electric's computer operations and particularly of Bull-GE will force all computer manufacturers to compete more aggressively in worldwide markets to remain competitive by 1980.

Both European and Japanese companies will become, for the first time, important factors in worldwide markets—including the U.S.

The trend to proprietary software packages and packaged services in general will make entry into worldwide markets easier and less risky for computer service companies.

The size of the computer market alone is forcing all companies to focus their attention on the non-U.S. markets. In 1966 the year-end U.S. computer inventory (\$10.1 billion) was more than twice as large as the computer inventory outside of the United States.

By 1975 the free-world non-U.S. inventory will

		1969	1971	1972	1975
TOTAL EDP EXPENDITURES (\$ BILLIONS)	U.S.	11.6	16.0	22.1	30.6
	FOR.	4.54	7.41	12.1	19.7
EDP EXPENDITURES AS PERCENT OF GNP (PERCENT)	U.S.	1.22	1.50	1.8	2.18
	FOR.	0.41	0.59	0.81	1.12
TOTAL AVERAGE INSTALLED INVENTORY (\$ BILLIONS)	U.S.	22.0	29.3	38.9	51.7
	FOR.	11.9	19.1	30.4	48.5
TOTAL SHIPMENTS (\$ BILLIONS)	U.S.	5.2	6.5	9.0	12.0
	FOR.	3.4	5.3	8.0	11.7
SHIPMENTS AS PERCENT OF GNP (PERCENT)	U.S.	0.55	0.60	0.73	0.86
	FOR.	0.31	0.42	0.49	0.67

(Source: MAPTEK Information Services, copyright Quantum Science Corporation.)

Fig. 1. Comparison of U.S. and foreign markets.

# Goes Multinational

by Mirek J. Stevenson

reach nearly \$50 billion and will be less than 10% smaller than the 1975 U.S. inventory of \$52 billion.

The sheer size of the free-world non-U.S. market in which the non-U.S. based companies can compete more effectively will create several large European and Japanese computer companies. The total non-U.S. manufacturers' shipments were only \$200 million in 1966. By 1975 they will exceed \$3 billion out of a total of nearly \$12 billion of non-U.S. shipments, thus creating several large scale companies with major research, development, service and customer support capabilities. At that time the shipments of foreign companies will equal the 1969 shipments of the U.S. manufacturers, excluding IBM. Thus the 1975 competitive pressures from foreign manufacturers will resemble the 1969 environment in the U.S., even assuming that U.S. companies are successful in competing in the worldwide markets.

By 1975 many of the industrialized free-world countries will reach the U.S. level of penetration of their Gross National Product in terms of computer shipments (Fig. 1). West Germany will continue to be the major market, as it is now, shown in Figs. 2 and 3. The non-U.S. free-world market will have a far greater proportion of new installations than the U.S. market. Therefore it will be more susceptible to entries by new competitors, and to increasing a company's market share, than the domestic U.S. market. In the U.S. 42% of new shipments in 1975 will be for replacement and upgrading of existing systems which tends to freeze the market share at status quo or for very small users where IBM has an overwhelming advantage. In contrast, only 25% of non-U.S. free-world market will be for replacement or upgrading of existing installations.

The acquisition by Honeywell of the General Electric computer operations and formation of Honeywell

	GNP		COMPUTER SHIPMENTS		SHIPMENTS AS A % OF GNP	
	1969	1975	1969	1975	1969	1975
UNITED KINGDOM	112.0	165.0	0.63	1.48	0.58	0.90
WEST GERMANY	152.0	265.0	0.85	2.61	0.56	0.98
FRANCE	118.0	190.0	0.54	1.45	0.49	0.76
ITALY	82.0	140.0	0.27	0.79	0.33	0.56
JAPAN	166.0	350.0	0.68	2.94	0.32	0.84
OTHER FREE WORLD	470.0	640.0	0.43	2.43	0.11	0.38
TOTAL	1,100.0	1,750.0	3.40	11.70	0.31	0.67
UNITED STATES	931.4	1,390.0	5.20	12.0	0.55	0.86

(Source: MAPTEK Information Services, copyright Quantum Science Corporation.)

Fig. 2. Computer shipments by country (\$ billions).

Information Systems (HIS) will be a major motivating force for U.S. companies to move into multinational operations. The Honeywell-General Electric merger of computer capabilities creates marketing strength in Europe on a country by country basis unmatched by any other company except for IBM.

In countries such as France, Germany or Spain, where Honeywell was a weaker or very small competitor, Bull-GE commanded a large market share. In

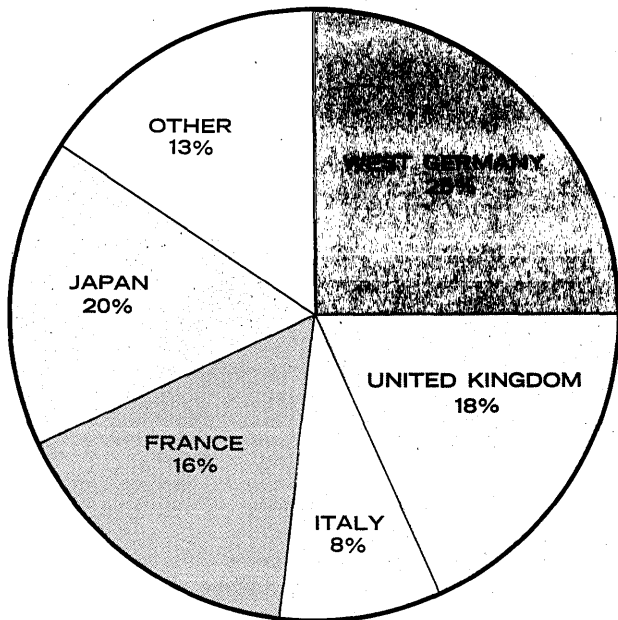

(Source: MAPTEK Information Services, copyright Quantum Science Corporation.)

**Fig. 3. Relative size of 1969 computer shipments.**

countries such as England and Sweden, where Bull-GE was weak, Honeywell had above average strength. Thus the excellent fit of the European countries operations of the two companies creates a competitive second computer power which did not exist previously.

Since Honeywell is now clearly the No. 2 computer company internationally, all major system manufacturers will have to push hard in 1971 to gain a sure position in the international markets.

Why must they do so in 1971? The reason is relatively simple. Even though HIS has already worked intently on integration of all GE operations with the existing Honeywell activities, it will be well into 1971 and possibly early 1972 before the entire product line and international market strategy are fully worked out and under full implementation by HIS. Thus all major systems companies must be in a strong posture, particularly in Europe, to compete effectively before the full strength of the combined HIS and IBM capabilities begins to bear down.

The sword, however, cuts both ways. Major European companies will not be able to ignore the U.S. market for much longer either. Although they lack the size and resources to compete in the U.S. to date, the series of large scale mergers, consolidations and acquisitions which will surely create several major multinational computer companies out of ICL, CII,

Siemens, Philips, AEG-Telefunken and Olivetti, in addition to the major Japanese companies will make it feasible for them to plan a serious entry into the U.S. market.

Once their size allows them to compete in the U.S., they will not only do so, but will have to do so. Even with the large growth of the non-U.S. free-world computer market, the center of the computer industry is now and will continue to be throughout this decade in the United States and any major manufacturer cannot be truly an international company without selling and manufacturing directly in the U.S. market. Since they cannot be absent from the U.S. without falling behind, the European and Japanese companies will be in the U.S. market soon—and most probably by acquisitions. The severe shakeout of the computer industry in 1970 which will not be totally over in 1971 will present the European and Japanese companies an opportunity to establish a position in the U.S. by favorable small and large acquisitions. The Japanese in particular have already begun to move in this direction.

So watch out. If you are not multinational, you just may not be able to stay in the game till 1980 even if you feel comfortable in your U.S. and limited international posture today. Even the U.S. market may get tougher without a multinational approach to the marketplace.

The organization structure of international and multinational companies has always been an important problem for any company operating in worldwide markets. The problems center on either using a single structure which reflects product, geographic or functional (such as Control Data organization) aspects of the company or dividing the company into domestic and international divisions which have multiple regional operations all with complete duplication of facilities and capabilities.

Organization in any industry is an extremely complex question, and it is particularly so in the computer market, which is characterized by very large marketing and customer service commitments, very high research and development expenditures, and great system complexity which requires integration of many products into a unified and compatible product line.

---

## Major European companies will not be able to ignore the U.S. market for much longer either.

---

Duplication of facilities becomes very expensive.

Many of the medium sized computer companies have not been oriented toward operating on a worldwide basis and have little direct knowledge of foreign company operations. The variation between markets in different countries is far greater than for many standard products such as automobiles or consumer products. The customer support, the marketing organization, and the local regulations lead to ever increasing complexity of organizing for worldwide computer operations. Even most of the major corporations have not been able to organize effectively to deal with the worldwide computer markets.

IBM, the most successful computer company, has



evolved a relatively unique organization for international markets and this organization has contributed to its becoming the leading worldwide computer company.

The IBM solution, through the IBM World Trade Corporation, a wholly owned domestic subsidiary, achieves a blending of product, geographic, and functional organization advantages. Its method of operation in worldwide markets merits a detailed examination by any company which expects to become a significant multinational company in this decade.

IBM World Trade has successfully solved many of

---

### **Even most of the major corporations have not been able to organize effectively to deal with the worldwide computer markets.**

---

the problems of coordination of the individual nation's requirements, diversity of products, product variation between different countries, and technological features by assigning product development and manufacturing responsibilities to individual development laboratories and production facilities on a worldwide basis. Each IBM plant (including the U.S. plants) has been given the charter to manufacture specific products both for the local market and for the export market. The export market often turns into imports into the United States for domestic U.S. use. In many countries IBM becomes a major exporter and contributor to the balance of payments and thus is a welcomed, rather than a resented, factor and competitor in the local market.

The development laboratories are also specialized in a particular technology and carry the development responsibility for a product or technology for the entire company. They are locally controlled by the country companies of IBM World Trade, but the actual staff coordination is controlled by the Systems Development Division which directs the individual programs and contracts with the country companies for the development efforts.

Such worldwide assignment of production and development responsibility concentrates the production efficiencies for each group of products into a single plant and eliminates the problems of coordination of multiple manufacturing facilities in different markets. By assigning responsibility for technology and production on a plant or laboratory basis, IBM is able to adapt better to the local available resources and to the local environments in each of the individual countries.

Thus the entire line organization of IBM World Trade is geographical, divided into four non-U.S. areas: Far East, Latin America, Canada, and Europe, which are subdivided into specific regions as appropriate. The country managers for each country have full management responsibility for all decisions and report to the directors or vice presidents in charge of one of the four areas.

IBM has thus solved the multidimensional problem of products, functions (such as manufacturing or de-

velopment), and geography by adopting a geographical line organization, staffed in each country totally with local national staff, but eliminating the duplication of effort by specifying the local product and technology responsibility for the functional aspects of manufacturing and product development.

This type of multinational organization, crossing easily country boundaries with products and technologies, has not been a comfortable one for many companies. Yet, if technology and products are integrated on a worldwide basis, are aimed, planned, and designed for the entire world market and not just one area, they are all adaptable to all the markets.

Very recently the consumer electronics, and particularly the home entertainment industry and the component companies serving it, have been forced to think on a worldwide basis under the brutal impact of Japanese and other Far East competition. In the short span of three years, the U.S. component industry has had to completely reorient itself to plan, manufacture, and sell on a worldwide basis. Those companies that did not establish Far East facilities are now finding themselves noncompetitive both in the Far East and in the U.S. In the integrated circuit markets Texas Instruments moved on a multinational basis early and now is a dominant factor in Europe, Motorola was able to capture a foothold despite a late start, and Fairchild never went multinational and as a result has been largely left out of the only component growth market in 1970.

The computer industry will also be forced into such worldwide multinational direction partly because use of computers is all-pervasive. It forces unification of procedures, systems, software, and even hardware—particularly with the rising importance of remote computing. The growing multinational character of the major customers of the computer industry will further advance the worldwide view of the industry, its products, and markets.

The push by systems manufacturers from the U.S. market into European markets to meet the threat of the Honeywell Information Systems, Inc., and the parallel move of peripheral equipment companies will

---

### **Those companies that did not establish Far East facilities are now finding themselves noncompetitive . . .**

---

create a rising need for software and contract programming support that will have to be provided by independent service companies. Because of the naturally different distribution of companies by size in European markets, the small and middle size machines will be more prevalent than in the U.S. These installations often require a significant level of outside contract programming support because of a lack of in-house software talent, and will represent new and significant markets to the software and other service organizations.

The current trend to proprietary packages in the U.S. computer market creates a new strategy on which service companies can base their entry into

## Why we're introducing a not-so-high-speed high-speed card reader.

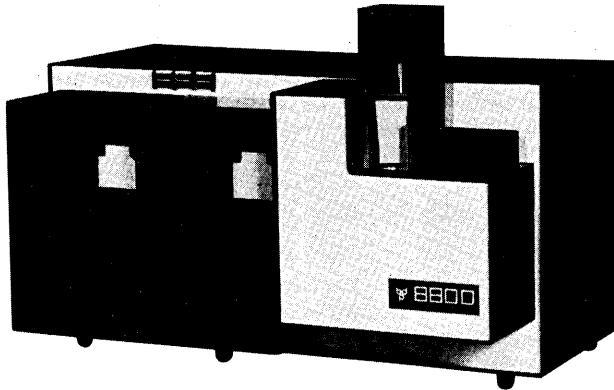

### 8800 multiple card reader

The Bridge Data Model 8800 card reader reads 80-column cards at a 650 cpm rate, 96-column cards at 1000 cpm.

In a world measured in nanoseconds, that's not so fast.

But in a world measured by the ability of someone to keep the machine fed, or by the ability of the machine to mate efficiently with 9600-baud high-speed terminals, it is comfortably quick.

And which world do you really live and work in? Right. The real world.

A world where long life (10 years, or 20,000 hours), reliability (1,000 hours MTBF), and accuracy (one possible error in  $300 \times 10^6$  data bits), are at least as sacred as achieving ultimate speed and status.

That's the world we design for. By building card readers that are fully compatible with standard 80-column cards and the new System/3 cards. (No sense building a machine that lasts ten years if it's obsolete in two.)

By building card readers that are compatible with people; ours has two stackers, for instance, so that you can maintain the 1,000 cpm rate without creating a cardboard blizzard.

And by building card readers with no-choke price tags.

There's more to the 8800 Series than this. (Screwdriver-simple maintenance, for instance.) But no more room to discuss it here.

For more detailed information, write or call: Bridge Data Products, Inc., 738 S. 42nd Street, Philadelphia, Pennsylvania 19104. Phone (215) 382-8700.

**bd**  
**P** **BRIDGE DATA**  
**PRODUCTS, INC.**

CIRCLE 18 ON READER CARD

multinational operations more safely than in the past. Organization of computer service companies in overseas markets has been difficult for many U.S. companies previously because of their lack of knowledge of local operating practices, the difficulty in recruiting local talent, and the higher risks of building up staff capabilities to attract local contracts. In general, exporting of services of job shop type has been much more difficult and risky than exporting hardware.

However, the product nature of proprietary packages now allows these same companies to either adopt an export posture of marketing proprietary packages in Europe and other countries or become truly multinational in an operating sense by establishing local operations which create such packages at a lower cost than their U.S. operations. While contract programming for U.S. customers can rarely be done from a remote location, creation of a proprietary package can be readily implemented in remote countries in lower labor cost or higher skill areas, provided that the system design is carried out in close contact with the ultimate user and that transfer of the system design to the remote "production" facility is properly planned and implemented.

Once such programming capability has been established in the local country for the purpose of developing specific defined proprietary packages, its objectives and market can be expanded at a far lower risk into local contract programming, turnkey system studies, facilities management, and other more job shop type or contract markets which often have a long selling lead time.

The computer industry is and will continue to be a growth industry despite all of the dire forecasts and forebodings issued regularly from all sides. However, the worldwide aspects of the business must be taken seriously. Nothing can be more dangerous than discounting "foreign" competition and discounting the threat of Japanese companies and European companies.

It was not long ago that "Made in Japan" was a slur. Soon it may be closer to a compliment. Consumer companies have found that if you can't beat them, you may as well join them. Even U.S. automakers are doing so. The computer industry is facing its worldwide challenge today and aggressive multinational posture is the road ahead. ■



Dr. Stevenson is president of Quantum Science Corp., a technological information service company headquartered in New York City, which provides services on the computer, communications, electronics, and other fields to major U.S. and international corporations. The company is currently conducting a multiclient study which will forecast and identify the changing structure of the multinational computer market. Prior to founding Quantum, Dr. Stevenson was at IBM.

**If your world is  
punched full of holes,  
and limited to  
3 1/4" x 7 3/8"...**

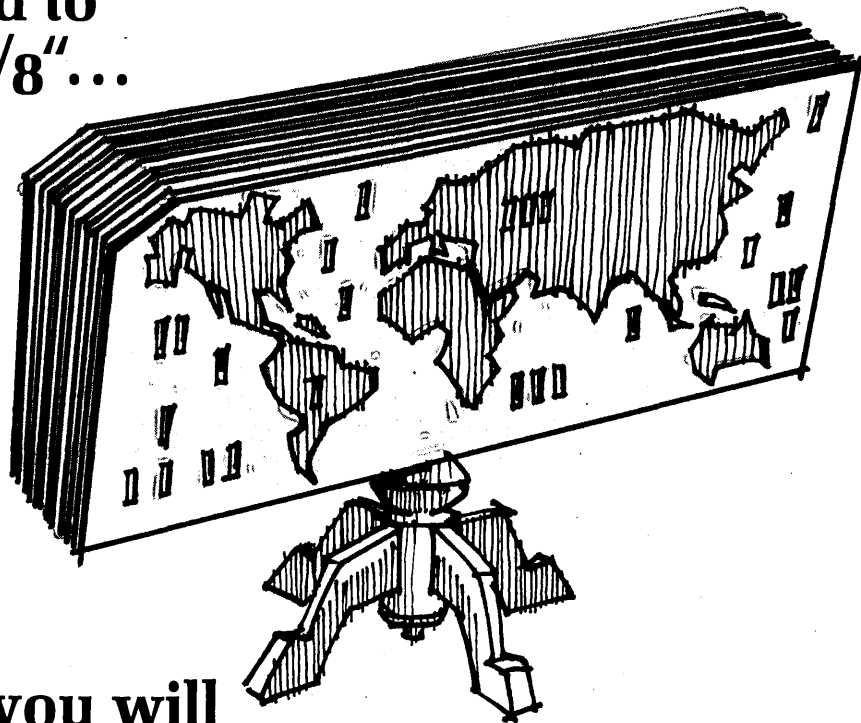

**Someday you will  
change the shape of things**

**SOMEDAY IS HERE. NOW.**

Scan-Data Corporation makes it possible with OCR systems that give real meaning to the word flexibility.

That eliminate the need for re-creation of source documents.

Part of the reason is SWAMI. Software-Aided Multifont Input. The world's first, and only self-teaching OCR system. It's designed for use with any Scan-Data system, old or new. It enables you to read virtually any consistent font, even degraded characters—directly from source documents. Combined with our superior handprint capabilities, SWAMI makes document re-creation a thing of the past.

That's only part of the reason. The rest has to do with our new 250 and 350 Page and Document Readers. Which take direct input from pages or documents from 3" x 7" through 11" x 14". On almost any weight or grade of paper.

It all adds up to practically unlimited flexibility in data processing. And that means time and money savings for you.

Ask us to tell you about the wonderful world of OCR.

Yours now. Courtesy Scan-Data Corporation.

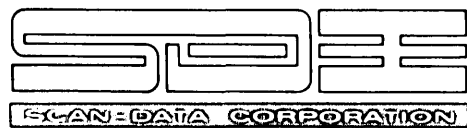

**"Someday" is here. Now.**

**800 East Main Street/Norristown, Pa. 19401/(215) 277-0500**

# FOR JUS YOU CAN TRADE TEN FOR VACUUM COLU

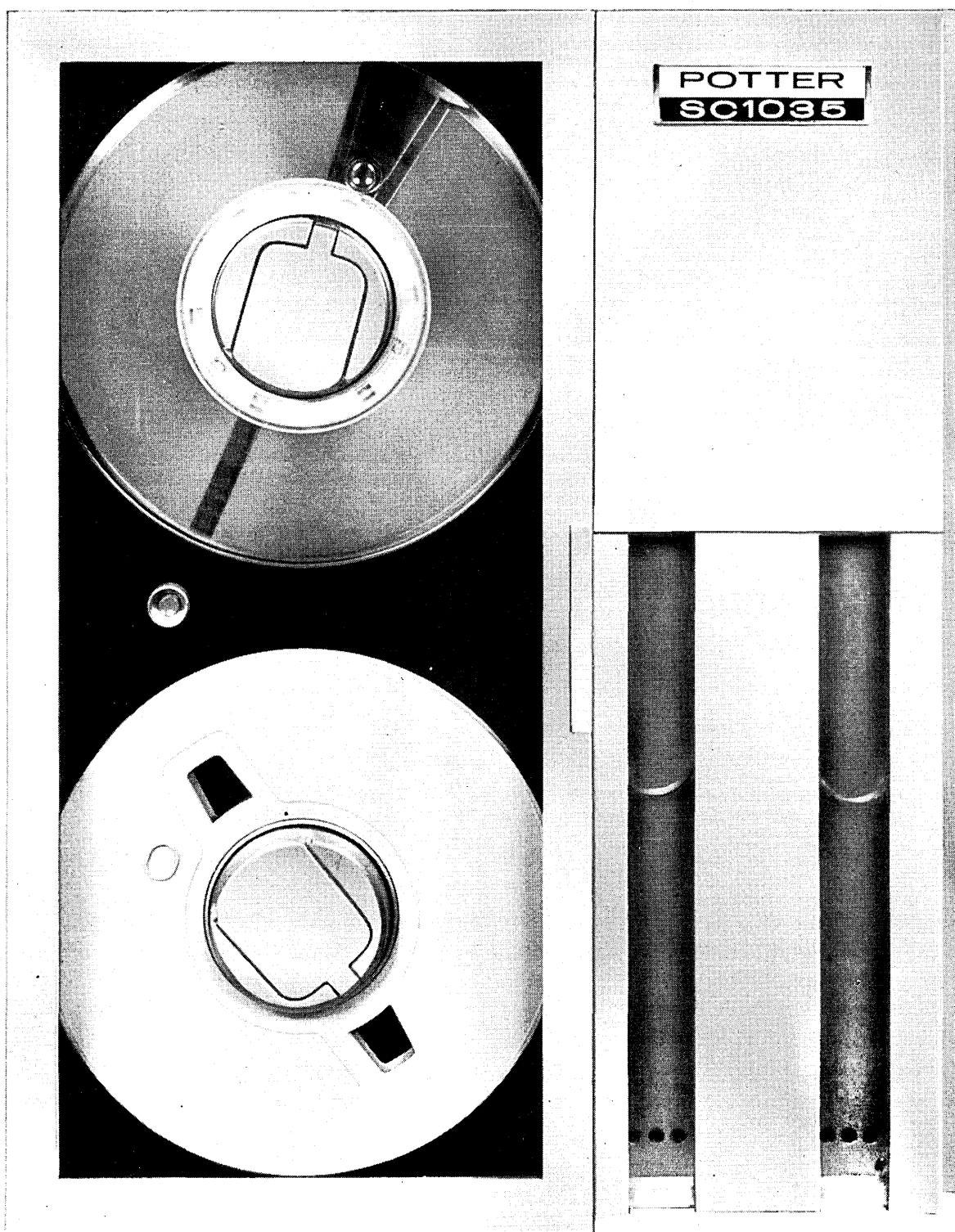

# T \$2,850\*

# SION ARM TROUBLES

# MIN PERFORMANCE

Why put old style tension arm tape drives on your up-to-date mini-system? Potter's SC 1030 Series Magnetic Tape Transports give you big system performance at tension arm prices.

Dual vacuum column buffering provides uniform tape tension and eliminates tension arm roller damage and tape stretching. The low inertia single capstan drive and dynamic reel braking assure smooth, rapid starts and stops. Advanced design integrated circuit read/write electronics. Choose your tape speed — 5 to 45 bi-directional ips. And your format — 7 or 9 channel, NRZI 200, 556, 800 bpi or PE 1600 bpi. This rugged, precision-made unit is compact — just 24½" high, 19" wide and 11" deep — and it can mount in any plane.

The SC 1030 Series units are designed to be virtually maintenance-free. All are supplied with the exclusive Potter HARD COAT read/write head that just doesn't wear out or require amplifier adjustment. The use of plug-in electronics modules and convenient test points coupled with the elimination of mechanical adjustments make servicing a snap.

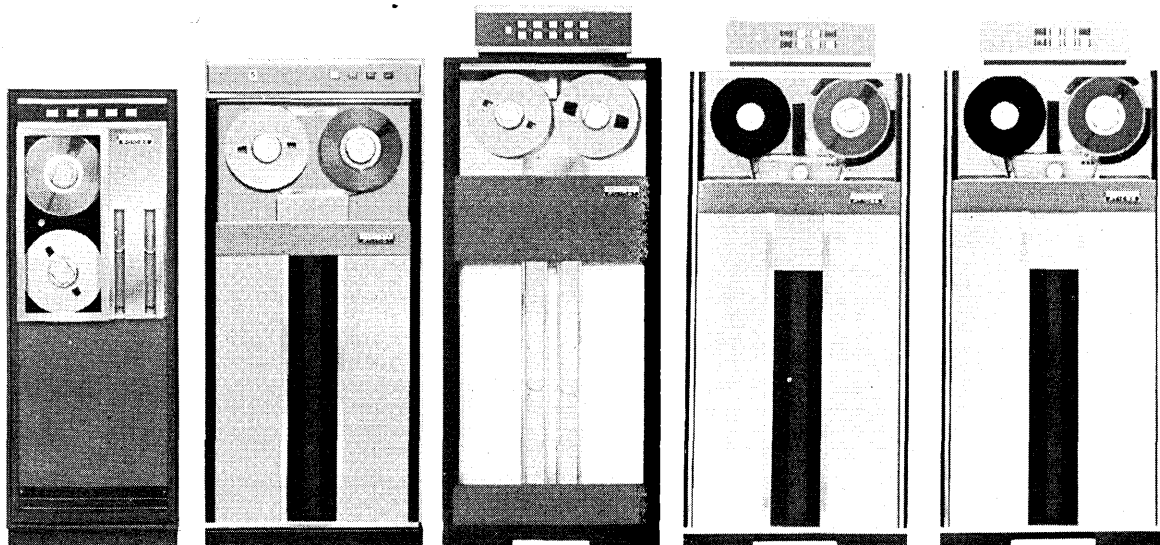

**SC 1030**  
45 ips

**SC 1051**  
75 ips

**SC 1081**  
150 ips

**AT 1082**  
150 ips  
Auto Thread

**AT 1092**  
200 ips  
Auto Thread

Potter has led the way in peripheral development since EDP began. Now we're the first to offer low-speed, vacuum column, single capstan tape drives at tension arm prices. Another addition to the broadest line of computer peripherals in the industry. For more information on any Potter tape drives, or disk drives, controllers, line printers or 96 column card equipment, write or call: Potter Instrument Company, Inc., 532 Broad Hollow Road, Melville, N. Y. 11746 Phone 516-694-9000.



\*In OEM quantities

**Potter. A lot more than less expensive.**

March 15, 1971

CIRCLE 51 ON READER CARD

39



# QUADRI... ON THE MOVE!

AND NOW "Q" CORE...THE FIRST MAJOR  
ADVANCEMENT IN MAGNETIC ROM SINCE 1952!

... THE UNIQUE NEW PROPRIETARY "Q" CORE represents the ultimate in reliability. It eliminates the inherent mechanical and electrical weaknesses of the "U" and "E" Cores.

#### WHY IS "Q" CORE UNIQUE?

- Quick change, pluggable matrix. How fast can *you move*?
- Yes, it can be altered in the field faster than any other system!
- Need a system than can drive a complete library of programs?
- The 13" x 11" card holds up to 100,000 bits with cycle times of 200 nanoseconds!

And, one of the really outstanding features is the off-the-shelf delivery schedule.

Call or write today:

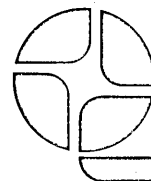
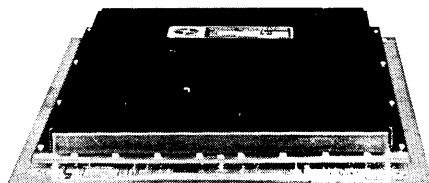

**QUADRI**  
CORPORATION  
2950 WEST FAIRMONT  
PHOENIX, ARIZONA 85017  
(602) 263-9555

## Computers north of the border

# Canadian Show

by W. David Gardner, New England Editor

**G**A week before the opening of the Canadian Computer Show a technical team at the Canadian Marconi Company was working feverishly to make a new 16-bit computer. Called the CMA-716, the mil spec computer was designed to sell for about \$15,000 and will be aimed primarily at the U.S. market.

Three days before the three-day show opened on September 14, the Canadian Marconi team finished its job. Presto: The show had its lone Canadian-developed-and-built computer.

The incident illustrates a great deal about the show and, beyond that, about computers in Canada. First, there still isn't much of a computer industry in Canada to speak of. Second, there is great technical capability north of the border (much of which moves south, however, to work at U.S. firms).

This first Canadian Computer Show illustrated something else: that there is tremendous interest in computers in Canada. "At first we were looking for 5,000 people to attend the show," said Derek A. Tidd, who managed the show for Industrial and Trade Shows of Canada, "Then, after we could see there was interest building up, we figured we might get 10,000. But everyone was surprised—we got more than 15,000 in all. And that's quite high for what is really an industry show."

In essence, the Canadian Computer Show—which henceforth will be an annual affair—is the Canadian version of the Fall and Spring Joint Computer Conferences. There were about 120 exhibitors in Canada and the overwhelming majority of these were U.S.-based firms—from IBM and the Digital Equipment Corp. on down to several peripheral manufacturers.

Theme of the show seminar was "The Shared Use of Computers Through Communications." Harvey S. Gellman, president of DCR Systems

Ltd. of Toronto, wasted little time in getting to the heart of the matter. To Americans attending the seminar, it sounded just like home and Ma Bell.

"Because there is not an adequate communications network in Canada," said Gellman, "the common carriers are subjected to a steady barrage of complaints by computer users. Complaints deal with rate structure, size and flexibility of bandwidth, line quality and reliability. . .

"Canada's common carriers have developed an effective network for voice communications, but the existing systems for data communications

continue to have serious deficiencies. Customers want better reliability, a wider range of speeds and lower costs. . .

"In a recent study by the Federal Government's Telecommission, most complaints by computer users were directed at the communications companies. Yet, in their replies to the Telecommission, the carriers seemed to ignore the complaints and concentrated on describing the improvements they had recently made in communications services."

The remarks by Gellman and the other speakers were underscored by the Canadian government's proposal to establish "a trans-Canada computer network" that would enable users to connect to various computer service complexes. The network, most observers of the Canadian computer industry believe, would also help encourage smaller Canadian firms to grow and would help block U.S. firms from taking over the industry in Canada.

Other speakers and panelists ran the time-sharing gamut from discus-

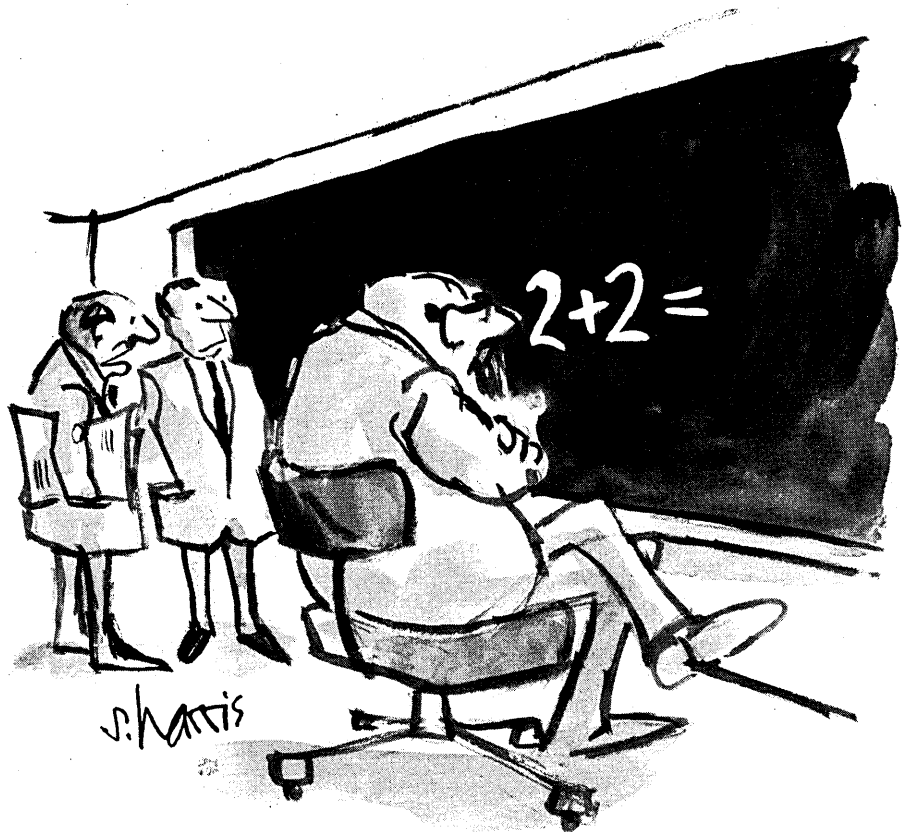

"Frobisher is questioning ALL our old beliefs."

Improving the efficiency of your computer systems in this cost-conscious economy is probably the biggest headache you have. And, that's why you should get complete information on the latest techniques in computer system performance evaluation:

For monitoring total system performance X-RAY™ is a unique hardware/software system capable of analyzing all aspects of *current system performance* including configuration utilization, system software overhead, application program efficiency, and program and data base organization.

For simulating even the most complex aspects of *planned or existing multiprogramming, real-time or time-sharing systems*, CASE is the least costly way to make system decisions . . . CASE will accept system and workload measurement data generated by X-RAY and predict the interaction of virtually any combination of hardware, software, data base and user programs.

X-RAY and CASE can be used together to provide a complete computer performance evaluation system. X-RAY and CASE are available independently or as a system under purchase, lease, license or service plans. For complete details, contact:

## APPLIED SYSTEMS

Division of Computer Learning & Systems Corporation  
5530 Wisconsin Avenue, Chevy Chase, Maryland 20015  
(301) 652-9220

# How to cure your biggest headache

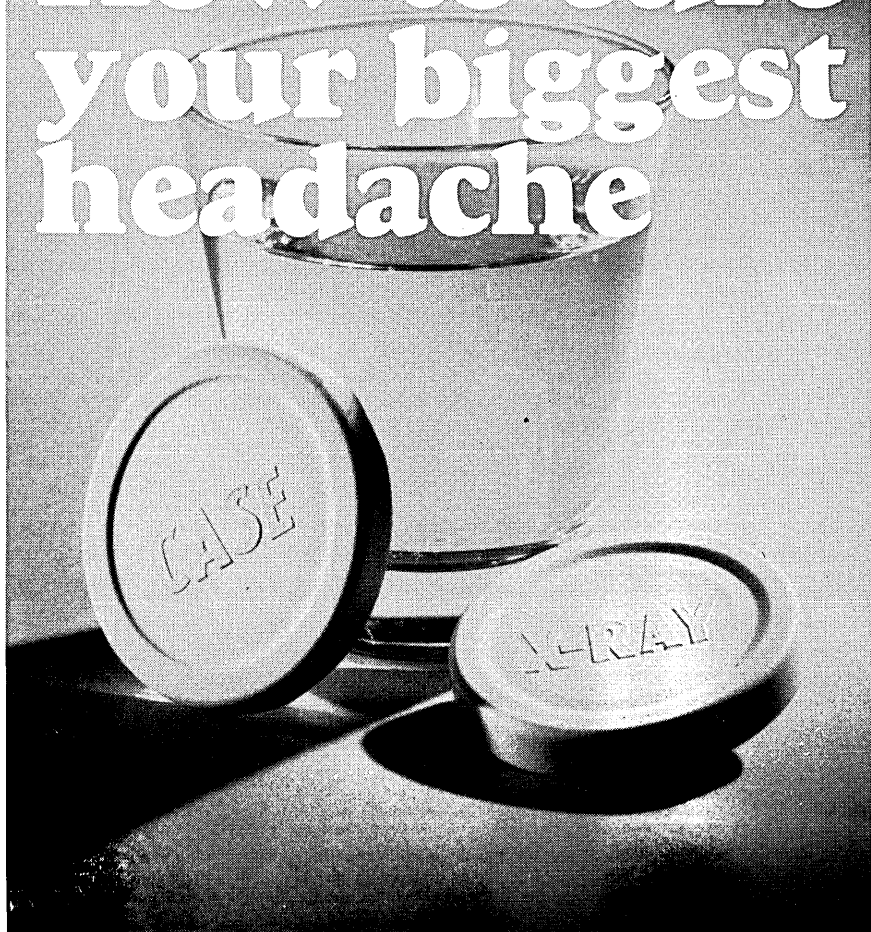

## Canadian Show . . .

sion of security of time-sharing systems to a presentation on the legal contracts that should exist between data centers and users.

Speaking on "The Present Status and Future Potential of Time-Shared Systems," Lyman E. Richardson, president of T-Scan Ltd. of Toronto, said: "Computer developments have been such that the processing potential often exceeds that of the individual user and this is the underlying challenge for time-sharing."

Rubin J. Rosen, a partner in P.S. Ross and Co. of Montreal, discussed "Auditing, Control and Security of Time-Shared Systems." He outlined ways to establish controls to ensure that only authorized persons have access to data in time-shared systems.

Rosen observed at one point in his talk that computer communications lines can be tapped. "Data transmission, just like voice transmission, is susceptible to wire tapping," said Rosen. "It is important to remember, if in our particular circumstances we are concerned about this type of encroachment on our privacy, that the eavesdropper does not introduce any information into the system—he normally continues to listen until he finds something of particular value to him."

Other speakers included Tim Reid, an Ontario attorney, who spoke on "Contractual Relationships, Liability and Regulations of Time-Shared Systems"; and Allan E. Gottlieb, deputy minister of the Department of Communications, Ottawa. Gottlieb's subject was "Computers, Communications, and Government."

Gottlieb warned that the Canadian computer utilities could fall under foreign ownership or that they could become "mere distributors" of foreign programs. Gottlieb said: "It seems to me essential that if we are to develop Canadian computer utilities in the interest of the Canadian economy and the Canadian people, we will have to maintain control of this important industry in Canada, just as we have in the past maintained control of telecommunications, banking, airlines, hydro and railroads. And at certain points along the line, some or even all of us will have to forego certain economic benefits of a North-South integration."

The Canadian Computer Show was sponsored by the Canadian Information Processing Society. The 1971 show will be held September 15 to 17 at the Exhibition Park in Toronto. ■



# Scare hell out of your secretary. Get her a computer.

About 45 minutes after the handsome thing is on her desk, she'll be an expert.



Look at the Datapoint 2200.

It ushers in the sensible age of computers. She'll enter data directly from source documents. She'll verify it on the CRT screen. And it's transmitted with no other human involved. (No mistakes either.) She doesn't need any other equipment. It's a friendly terminal that talks to her. Guides her. Walks her through the job. And without a peep or noise. It's the first computer that doesn't add to office turmoil.

Some slightly technical information about the 2200:

1. It has a programmable memory of up to 8192-8 bit words.
2. It takes a library of basic systems created by CTC.
3. It enters data directly to tape, at the speed of light.
4. It works with any data code. ASCII, EBCDIC, BCD, etc.
5. Beautifully enough, no special training is required.
6. Sleek and handsome. (Wait till you see it!)
7. Self-contained unit. That means you lay out nothing for supplemental units or auxiliary power.



**Home Office:**

9725 Datapoint Drive/San Antonio, Texas 78229/(512) 696-4520

**Regional Offices:**

Western—3807 Wilshire Blvd./Los Angeles, Calif. 90005/(213) 380-2497

Midwestern—7851 Metro Pkwy./Minneapolis, Minn. 55420/(612) 727-1344

Federal—1515 Wilson Blvd./Arlington, Va. 22209/(703) 524-6455

Eastern—1345 Ave. of the Americas/New York, N.Y. 10019/(212) 541-9205

There are fourteen additional field offices throughout the United States.

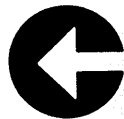

**Secretary's Computer from  
Computer Terminal Corporation**

CIRCLE 25 ON READER CARD

(the people who took the terror out of computers)



# Now, a new way to transmit expensive computer data.

In a time of rising costs, Western Union is proud to announce a service that will cost you less. And best of all, a service that will improve the cost efficiency of one of your biggest investments. Computers.

We call it Datacom. A new common-carrier service for the transmission of digital data. And it can save users as much as 80% of present costs for transmitting large amounts of information.

In addition, Datacom will allow you complete flexibility for adding or changing your terminal locations or service arrangements on short notice without heavy expenses.

Datacom provides two-way multi-channel service between any two of the 45 terminal cities linked with our 7900-mile transcontinental microwave network. And it permits dropping off messages to third cities. No matter where you are, you can tie into the Datacom service via private wire extension to the nearest terminal city.

The new service is possible through

channel subdivision techniques that increase information carrying capacity at a given bandwidth. Speeds of 75, 110, 135 and 150 baud with 12 to 24 multiplexed channels are available.

With Datacom, you don't need multiplex equipment of your own. Hardware is located at Western Union facilities in terminal cities. We take care of all maintenance.

Datacom is part of the growing family of Western Union services that we call electronic data communications. EDC for short. These include a nationwide computerized network, leased private wire systems, the Telex/TWX networks and a digital communications network.

#### Datacom is available in these cities.

Albuquerque	Hartford	Oklahoma City
Atlanta	Houston	Omaha
Baltimore	Indianapolis	Philadelphia
Birmingham	Jacksonville	Phoenix
Boston	Kansas City	Pittsburgh
Buffalo	Knoxville	Portland
Charlotte	Los Angeles	Richmond
Chicago	Memphis	St. Louis
Cincinnati	Miami	Salt Lake City
Cleveland	Milwaukee	San Diego
Dallas	Minneapolis	San Francisco
Denver	Newark	Seattle
Des Moines	New Orleans	Syracuse
Detroit	New York	Tampa
El Paso	Oakland	Washington, D.C.

Contact Mr. C. S. Kilcourse, General Manager, Administration, Western Union Telegraph Company, 60 Hudson Street, New York, New York 10013. Or get in touch with your Western Union representative. TWX (710) 581-4072.  western union

# Cheaply.



## 10th annual meeting of educational data processors

# CEDPA Conference

**G** "Educational Computing: Expectations vs. Realities" was the theme of the 10th annual conference of the California Educational Data Processing Association at the Oakland Hilton, Dec. 2-4.

Guy Dobbs, vice president of Xerox Computer Services, hit hard on this theme when he spoke of the gap between expectations and realities. He said, "The computer business is characterized by oversell at all levels by technological radicals. The rate of creativity far exceeds the rate of absorption by society. We continually forget the fundamentals, like understanding the learning process. We've abdicated the responsibility for sane growth to the technologist. The ultimate use of computer power is to *support* human activity not *replace* it." Dobbs feels there is a sole method of decreasing this gap. His answer: "Increase the human use of human beings!"

Mr. Dobbs also feels the problems are due more to technology and less to lack of content in education. "We're caught up in a technological revolution" in which it is "difficult to forecast and realize the impact."

Dialogue sessions were a new and important feature of this conference. The usual general opening session was replaced with five open-ended discussion sessions. These sessions, on the whole, were intense and animated. Topics covered were: Using the Computer for Teaching; Teaching about Computers and Computing; Data Processing Management; Testing, Research, and Guidance; and Administration of Computer Technology in Education. While topics varied widely, participants seemed to express similar concerns. Over and over, one could hear talk of tightened budgets, high cost of computer technology, insufficient software, and lack of coordination and planning. Participants must have found these discussion sessions relevant as they were mentioned frequently during the remainder of the conference.

There was something for everyone in the sessions the next two days.

Different presentations were given for elementary, secondary, and junior college interests. Topics ranged from "In-house Systems at the State Department of Education" to "Education Job Placement by Computer," from "Time-sharing in Education" to "Computer-Managed Instruction."

One widely discussed session was a panel on Computer Assisted Instruction, led by Dr. Bernard Luskin, vice chancellor for educational development at Coast Community College District, Newport, Calif. The CAI system at this college is well known as an example of sophisticated computer usage. But the surprise of the session was when Dr. Martin Wiskoff, of the U.S. Navy, Bureau of Personnel Research, described the CAI systems and evaluation research going on in naval schools. The superiority of these programs was startling and enviable to many in public education.

Judy Edwards spoke on "Computers, Instruction, Relevance." Mrs. Edwards, of the Northwest Regional Educational Lab, said that most

students today feel that public education is "boring, irrelevant, and condescending." She feels that the main goals of instruction should be how to learn and how to think. She went on to say that the computer can help by releasing creative teachers from clerical and fact-giving tasks. The teachers can then establish a climate for learning. Mrs. Edwards listed several other ways computers can help students and feels "the computer may have been invented just in time for man to survive."

A special pre-session on Program Planning and Budgeting Systems was very well attended. Interest in PPBS in California schools has continued to grow, aided by legislative prodding which requires school districts to implement new budgeting and accounting systems by 1973.

CEDPA was celebrating its 10th anniversary at this meeting. And it has grown tenfold, from 35 to 350 members.

The thrust of CEDPA was redefined by Dr. Murray Tondow, the organization's new president. Dr. Tondow called on CEDPA members to focus on legislative action as a means of achieving their goals. He feels that CEDPA must have "expanded responsibility as technology expands." We can expect to hear more about this, or, perhaps, even see results in the future.

—Bradford Burris

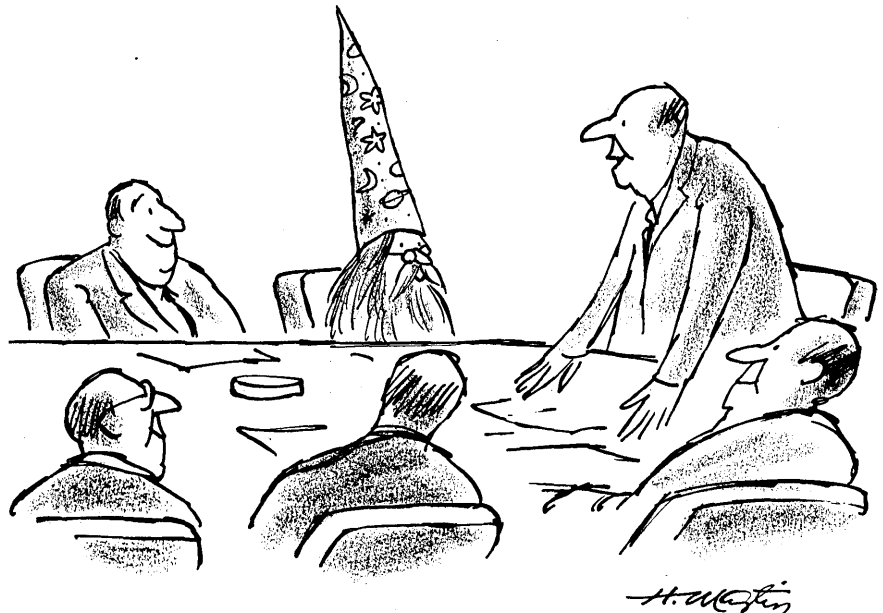

"... and I think we all know who is responsible for the company's fantastic turnaround situation."

# Introducing

It's an entirely new way of organizing a corporation's computer system. Not just hardware or software, but total integration of EDP services with important corporate departments.

Here's how worksharing works:

You equip each major division or department of your company with its own small business computer system, with terminals and software tailored to each department's function.

The department gets truly productive automation, plus on-the-spot processing for routine reports and analyses. And the local processor automatically extracts and forwards pre-processed data to your mainframe. Automatically. With no manual or mechanical data preparation or encoding steps.

The result is a system with some startling advantages. First, it works for a living. It makes an obvious and demonstrable contribution to each department's profitable output.

Second, a worksharing system provides your mainframe with a continuous, absolutely current flow of data. Automatically. As a natural by-product of active participation in the daily work.

Third, as more departments are given local processing capability, they begin to interact with each other. An order

# Worksharing.

entered at a remote sales office can automatically adjust a production schedule or a warehouse "pick sheet," print shipping papers on the loading dock, initiate billing, adjust sales totals in management analyses, alert the controller of expected income, and make the VPs smile. All within a few minutes.

Of course, all this would be Pie in the Sky except for one thing. Cost. Now, there is a small business computer flexible enough and inexpensive enough to commit to a single department. System Ten business computer by Singer.

A System Ten computer will accommodate up to twenty workstations and process all twenty jobs simultaneously. It's designed to be used easily by ordinary business people without special EDP training. It uses simple two-wire connections—easy to install. It's ready to go on-line to your mainframe. And most important, its cost is extremely realistic. On the basis of cost per function, a System Ten business computer is the most efficient system available to you today.

To find out why, and to get more information about how a worksharing system could work for your company, call your nearest Friden Office. Or write Friden Division, The Singer Company, San Leandro, California 94577.

**The computer that works for a living.**

**System Ten  
business computer  
by Singer**

CIRCLE 7 ON READER CARD

# PERSPECTIVE

an interpretive review of significant developments

## Short-Term Price and Supply War Begins: Memory Firm Corps vs. IBM

Conditioned to severe IBM moves to discourage competitors in the peripheral industry, the computer community read of the giant's January purchase price cuts for a passle of unexciting out-of-production systems with unnervingly little interest. But one, a 40% purchase-price reduction on IBM's lumbering 2361 large core storage (LCS) models, drew attention to a budding effort by independent firms — the offering of core and semiconductor memories to System 360 users.

These memories break down into 2361 core substitutes for IBM 360/50s and up, and main memory add-ons for installed IBM 360/30, 40, 50, and 65 systems. Only a handful of firms are offering one or both types of products and their total installed base is hardly a dent in the IBM armor: about \$25 million worth, most of it in bulk core systems, and most of that by one manufacturer, Ampex.

But these firms are hoping that the installed value for each type of memory will total \$100-250 million by 1974. (Range indicates healthy disagreement.) They admit they will be short-lived markets, and production should be curtailed within two-three years. Wisely, most of the entrants do not depend on these products for their livelihood, having diversified oem and end-user product lines.

Based on that, one would not expect IBM to rail unnecessarily against them. But they are banking on the success of a movement called "extend 360 life." That makes them, like all other independents feeding on the 360, the natural ally of IBM's biggest set of competitors, the leasing firms. Lessors have a giant stake in keeping their \$2.5 billion worth of IBM 360 systems installed past 1975. And that's how the memory makers have become part of a major threat to the new System 370, deserving an occasional swat from IBM, if not a clout.

The 2361 price cut pushed the one- and two-megabyte models down to \$177,830 and \$296,380, which is 27-39% less than the systems of its

three main competitors, Ampex Corp., Fabri-Tek, Inc., and Data Products Corp. All of them feel that it's an IBM "fire sale" to get rid of inventory piling up; 250 2361's were reportedly built. The effect is "insignificant," since they primarily lease their systems, and their rates remain highly competitive with IBM's unchanged rental fees. Leader Ampex admits it's bound to hurt a little, but contends that most users have opted for foreign units because of performance, not price. Competitive units range in cycle time from 1.8-4 usec vs. IBM's 8 usec.

However minor the price cut may be considered, it is the first such change in the 360 core memory line. Observers call it a "tacit warning": as long as IBM doesn't dip below product cost, it is not bound by law — only by marketing and production considerations — from further changing its rates and policies. For now, IBM is really held back only by its overwhelming desire not to add to 360 life as well.

### Shaping Up

Unfettered for now, how do the suppliers and their markets shape up? And what does the user gain from all this attention? Spokesmen for the three main competitors in bulk store systems vary on their market projections. Ampex's Eugene Krushcke sees a total market of 1,000 one-megabyte systems, worth \$250 million. This firm, with a long lead, has installed 45 systems since mid-69, and is currently building two a week for delivery. Fabri-Tek, whose first installation went in late in 1970, sees a total market for 300-400 megabytes by 1974, worth \$80-100 million, according to vice president Richard Baker. Most will be on memory-bound Mod 50's, he says. And Data Products, with three installations and hopes for "a few dozen by year end," projects at least 500 megabytes by '74. (DP plans systems for other vendor processors as well.) Lockheed has a bulk storage system for the 360, but no installations and more actively

solicits oem and special contracts.

The life of their leases beyond '74 will depend on 360 life; a source says that memory costs should be recovered within two years, so profit potential is "good-to-gravy." The major fear is that IBM will unveil a faster 2361. If it does, one firm expects it'll interface with 370's and the large-scale 360's, excluding the 50.

What's in it all for the user? Obviously, he has price alternatives, the independents' prices becoming more attractive under long-term leases; he receives the performance improvement noted earlier, although he has to provide the software knowhow to crank it up to full speed because the suppliers don't have much programming talent; and generally, he has little trouble interfacing the unit, since IBM's 8080 interface is used. Besides being an alternative to disc in some functions, the high-speed models are a tolerable and cost-saving replacement for some main memory. Ampex notes that a trade of 256K core for a \$6700/mo. one-megabyte ECM is a savings of \$2545/mo. Maintenance is the only naughty problem and the user must make sure his vendor has a good service.

### Memory corps

Moving over to the suppliers of main memory add-ons, one finds Ampex's counterpart is Data Recall, Inc., El Segundo, Calif. It has installed 72 core boxes on 360/30, 40, and 50 systems since February 1970. Fabri-Tek is attacking this market, too, having announced memory for the 30 last fall; it has 10 orders, and plans to announce 360/40 and 50 systems this spring. Semiconductor memories have been introduced by Advance Memory Systems, Inc., Sunnyvale, Calif. for the 30, 40, and 50, and by Cogar Corp. Herkimer, N.Y. for the model 65. Data Products is expected to announce their core versions for at least one 360 model soon. Electronic Memories Inc., Hawthorne, Calif., is studying both the bulk store and memory extension markets. And don't even count out oem-oriented Lockheed; leasing firms have some oem characteristics. (Lockheed is rumored



working on a Model 65 add-on.)

The most successful firms to date are linked with lessors. Data Recall, which is a spinoff from Ampex, has unburdened itself of rentals, end-user marketing, and maintenance chores. To date, its marketing agent is a leasing firm, Computer Investors Group, which purchases the memories to give DR an enviable cash flow. CIG owns \$45 million worth of 360 computers and half of the DR memories are in CIG installations. Comma Corp. is doing the maintenance on some mod 30 memories, while Honeywell Information Systems handles the rest. In fact, Data Recall is negotiating with HIC to handle the installation as well.

Advanced Memory Systems has contracted with Intel Computer Leasing for a minimum of \$3.75 million worth of its SSU semiconductor memories — and that could grow to \$12 million between now and 1973. At the same time, Intel is talking to Data Recall about providing core-memory alternatives.

Some idea about potential market was provided by Richard Bravo, of the still uninvolved Electronic Memories. Bravo noted that one private survey netted the following about users planning to obtain more memory within the next year: 21% of mod 30 users; mod 40 — 58%; mod 50 — 33%; mod 65, 75, and 85 — 21%. Some sources say the 30 and 40 figures are too low. He also said that one leasing company with \$250 million worth of 360s estimated that if all its systems were expanded to full capacity, \$11 million worth of main memory would be required. Very roughly calling that 1/10th the leasing community, the ballpark potential becomes over \$100 million (IBM price) for lessors alone. Even trimmed well down into the \$10's of millions, independents have it all to shoot at, since IBM won't rent memories for use on purchased equipment and it won't offer discounts on the purchase price.

### To market

Is there an add-on memory market among renters of 360s? Fabri-Tek thinks there is and raises the total market for main memory add-ons to \$200 million worth by the close of '74. Using the firm's 30 memory as an example, vp Baker says the user can't just ignore a purchase and rental 20%

less than IBM's. The small user is particularly conscious of budget, he says, and there are 5,000 mod 30 users without full memory capacity.

Data Recall's president, Stuart J. Lotwin, disagrees with Baker. He feels IBM discourages renters from adding on any foreign box, especially main memory, since it requires a processor modification. Actually, IBM's stated policy isn't intimidating: the user or vendor can make the cpu modifications needed for the add-on of non-IBM units; they are trivial. IBM will continue to maintain the cpu. However, the user is liable for any damage to IBM-owned equipment arising from the modification. Lotwin said that originally, he, too, was optimistic about renter prospects, but now feels that liability scares off the user. Most vendors say they are willing to assume that obligation full, however.

---

What's in it for the user? Sheer economy — if he can figure out the savings and cope with a mixed installation.

---

What's in that market for the user? Sheer economy, again, especially in longer-term leases. And he doesn't have to pay extra-shift charges on the independent's products — particularly significant in systems like the 50 and up, which are invariably used for two or three shifts a day at a monthly cost of 10% of rental per shift. Maintenance problems are minimal.

It's difficult to compare prices, because IBM's don't increase linearly (or logically); competitors sometimes come in below IBM prices, sometimes are equal, depending on the module. And the picture gets more confusing when a firm like Fabri-Tek offers to replace 448K bytes of your 512K memory on the model 50 with 192K of its own add-on memory and a one-megabyte bulk core system, bringing you up to 1.2 megabytes of core for \$10K/month vs. \$14K/mo. for IBM's 448K, including extra-shift charges.

But the savings are there, the choice is there, if the user can figure

it out and cope with a mixed installation. And if IBM doesn't come along with main memory price cuts on purchase or rental, elimination of extra shift charges, or other such changes.

If all these memory makers can gin up their marketing and maintenance forces or agents, the industry should see a hot — short — battle among them over the next two years. One source says the bulk core producers are currently fighting each other harder than they are IBM.

Where to after that is something they are all thinking about. The core makers foresee their total oem market continuing to increase 20-30% annually through 1975, when they feel semiconductor memories will begin to mature. While they don't expect cores to actually diminish, they are looking ahead. Many have either in-house semiconductor capability or are looking at possible partners. And they are planning new products in diversified areas.

As for their future in the end user market, most specifically among System 370 users, they are hopeful but conservative. IBM has made it plain the 370 won't be as easy to latch on to as the 360. The 370's main core memory is cheaper than the 360's — some modules priced up to two-thirds less. The memory structures are different. The 145 has a semiconductor memory. And there are even rumors of a 155 with five megabytes of very high-speed memory, adding to the "technological-psychological mystery" of the 370.

Fabri-Tek's Baker, however, feels that the big memory makers will have the volume to squeeze profitably under the 370 pricing umbrella and doesn't fear interface problems with the 155 and 165, at least. The 145, however, may be a problem since the processor must be modified; that may mean altering microcode — and IBM won't allow anyone to get their hands on that.

Ampex, on the other hand, sees the 145, with its 512K-byte limit, an excellent prospect for cheaper bulk core linked through an "I/O device" called the IBM 2909. Where there's a will...

In the meantime, with all respect for the giant, the competitors will be prepared for the occasional IBM swat.

— Angeline Pantages



## Where Has All the Money Gone?

In the eyes of one Wall Street advisory consulting firm that specializes in technology markets, there are two chief drags on venture capital investing in new computer companies.

First, many parties that traditionally invest in venture capital have turned to more attractive investments like, say, public securities and, second, many venture capitalists are tied up simply trying to bail out some of their past investments. "Still, we're finding that a company that's competitive and good — a company that makes sense as a business — can still get funding," says Walter Channing Jr. of Channing, Rothbard and Weinberg, Inc. The firm evaluates technology companies seeking financing. Observing that it is difficult these days for companies to go public, Channing noted that many venture capitalists have been forced to plow back into past investments resources that they would normally be investing in new companies. "It's finally become a buyer's market," says Channing. "Previously the power was in the hands of the entrepreneur. Now the guys with the capital have the negotiating strength."

Channing was asked whether the good old high-flying days of 1967-68 will return? "I'm not so sure those days were so good," says Channing. "Some companies weren't formed because of need, but because capital was around to start companies. The formation of time-sharing companies got out of hand, for instance."

Channing feels there was a certain negative side to the high-flying days of the hot issue market: He finds that now the stocks of many good issues are depressed.

On the plus side, Channing detects the start of a resurgence of interest in venture capital investing and looks for the situation to start picking up noticeably in the fall.

"We're also seeing a tendency among venture capitalists to be more professional about finding new companies," says Channing. "We think this is a good trend because a lot less money will be lost in the future. Everyone's getting smarter."

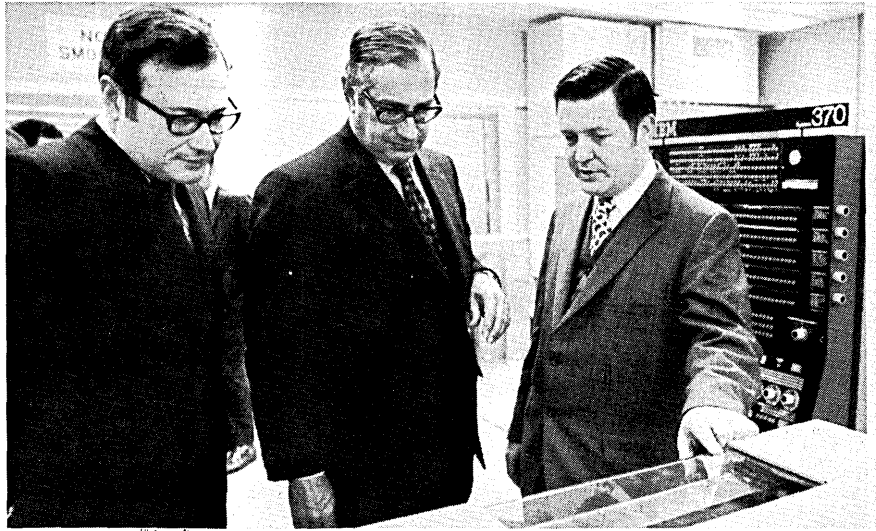

THEY LIKE IT: Zayre officers Paul Kwasnick, Sumner Feldberg and Robert Bozeman have good reason to like new 370/155, first to be installed anywhere. It replaces a 30, 40 and 50 and slices firm's costs by a third.

## Zayre Is the Site of First 370/155 Operation

During the 1930's a young ambitious IBM salesman named T. Vincent Learson sold some tabulating equipment to a small chain of apparel stores in the Boston area. The whole thing, however, was something of a fiasco, because as one top executive of the chain stores recalls, "the tab equipment was kicked out."

It was said to have been the only account Learson lost when he was in Boston.

Learson, of course, has since risen to the top of IBM — he is president of the computer colossus — and that little chain of apparel stores has evolved into the gigantic Zayre Corp., which is predicting sales of about \$8 million this year. After its difficulties with IBM's tab equipment, Zayre avoided data processing like the plague, but years later, the firm returned to the data processing fold. An IBM 1401 was installed in 1961.

In recent years, Zayre has remained a loyal IBM customer and recently became the first customer installation of IBM's 370/155. The machine was said to carry the number 44, meaning that IBM had 43 models in house before a customer received one. The first 165 is scheduled to be delivered within a month.

"System 370 continues to exceed

our expectations in every aspect," said R. A. Pfeiffer Jr., president of IBM's Data Processing Div. at unveiling ceremonies for the new equipment at Zayre's suburban Boston headquarters. "We are particularly pleased that Zayre's computer was delivered ahead of schedule."

IBM picked a "clean" installation for its first 155. There were, for instance, no peripherals from independent manufacturers at the data processing site, although an Inforex key-to-tape system was observed in an adjoining room.

"We've been extremely pleased with the 155," said Robert M. Bozeman, Zayre's assistant vice president of management information systems. "It was installed quickly and we ran 200 hours straight without a problem from the start."

Bozeman said the 155 is replacing IBM models 30, 40 and 50, and that, in all, Zayre expects to realize a financial savings of one-third with the new equipment. The 30 and the 40 were displaced immediately by the 155 and Zayre will operate both the 50 and the 155 while shifting the installation over from DOS to OS. In addition, a model 145 is on order — scheduled to be installed in the summer — and the first of the two 3330s is scheduled to be installed in September.

Bozeman said that, besides the  
*(Continued on page 55)*

# A few well chosen words from one memory expert to another.

Let's talk manufacturer to manufacturer.

You make computers. We make memory systems.

And in the 13 years we've been around, we've learned a thing or two about what goes on in a computer's mind.

Because we've been there. Our memory systems are standard or optional equipment in some of the finest minds in the computer industry. The biggest manufacturers of computers in the world.

We're pretty sure they aren't buying from us just because we're big too. Of course, it helps.

But if you're sharp enough to build something like a computer, you don't go around buying memory systems like you would a shirt. Because the label impresses your friends.

You buy them on the basis of reliability. Versatility. Compatibility. Service. Engineering. All those intangibles that become very tangible when it comes

down to the nitty gritty of whether a customer buys your brain or somebody else's.

If you're looking for a way to improve or expand your memory capability, remember to get in touch with your local Bryant representative. Or write to 850 Ladd Road, Walled Lake, Michigan 48088. He'll show you the widest line of memory systems in the world. And he'll show you how to change your mind. For the better.



**BRYANT COMPUTER PRODUCTS**  
**THE BIG MEMORY EXPERT.**

A UNIT OF

**XLO**

EX-CELL-O CORPORATION

# We're over- whelmed

... with your great response to the TDS/Remcom-2780 Terminal.

You believed us when we said it was the remote batch terminal that is truly compatible with OS/360 and DOS/360 and all IBM 2780 software.

You ordered it. For as low as \$850 per month, including maintenance, on our new 18-month rental period.

And you carefully considered our options: 300 or 600 CPM card reader, 400 or 600 LPM printer, double buffering to 1200 bytes, and up to 80% increase in send-receive rate with our exclusive *advanced data compression/decompression*.

Now, to overwhelm you with service, we've established eight regional centers complemented by the nationwide Honeywell offices that service TDS/

Remcom-2780 Terminals.

One thing more. You have not overwhelmed our capacity. Delivery is still 60 days!

Contact Tracor Data Systems, 601 California St., San Francisco, Calif. 94108. Phone (415) 781-5455 or our regional office nearest you: Chicago — (312) 298-5090, Dallas—(214) 328-9991, San Francisco—(415) 781-5455, Washington, D.C.— (703) 820-7802.

**TRACOR** DATA  
SYSTEMS

*Quality in computer products.*

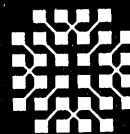

# Now you'll be overwhelmed

... with the price, performance and 60-day delivery of our 2314-compatible disc drives. Performance, it's there! Our disc drives are plug and pack compatible with the IBM 2314.

Reliability, it's unsurpassed. Advanced electronics, such as monolithic circuitry, assure you more equipment up-time. Easier and faster maintenance, too.

Price, we've got it. Monthly rental for our TDS-833 Controller and our TDS-733 Disc Drive in the 3-spindle configuration is \$2,108; in the 6-spindle it's \$2,958; in the 9-spindle, \$3,808. Of course, you can get single spindles as well. 24-hour maintenance and unlimited use are included.

Here's how sure we are that you'll keep our disc drives once you try them. We offer a 30-day, no-

obligation, free test for the first system in any customer's account.

Price, performance, and 60-day delivery... there's none so overwhelming.

So come on, now. Overwhelm us. Contact Tracor Data Systems, 601 California St., San Francisco, Calif. 94108. Phone (415) 781-5455 or our regional office nearest you: Chicago — (312) 298-5090, Dallas — (214) 328-9991, San Francisco — (415) 781-5455, Washington, D.C. — (703) 820-7802.

**TRACOR** DATA  
SYSTEMS

*Quality in computer products.*

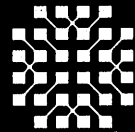

# Our economy model.

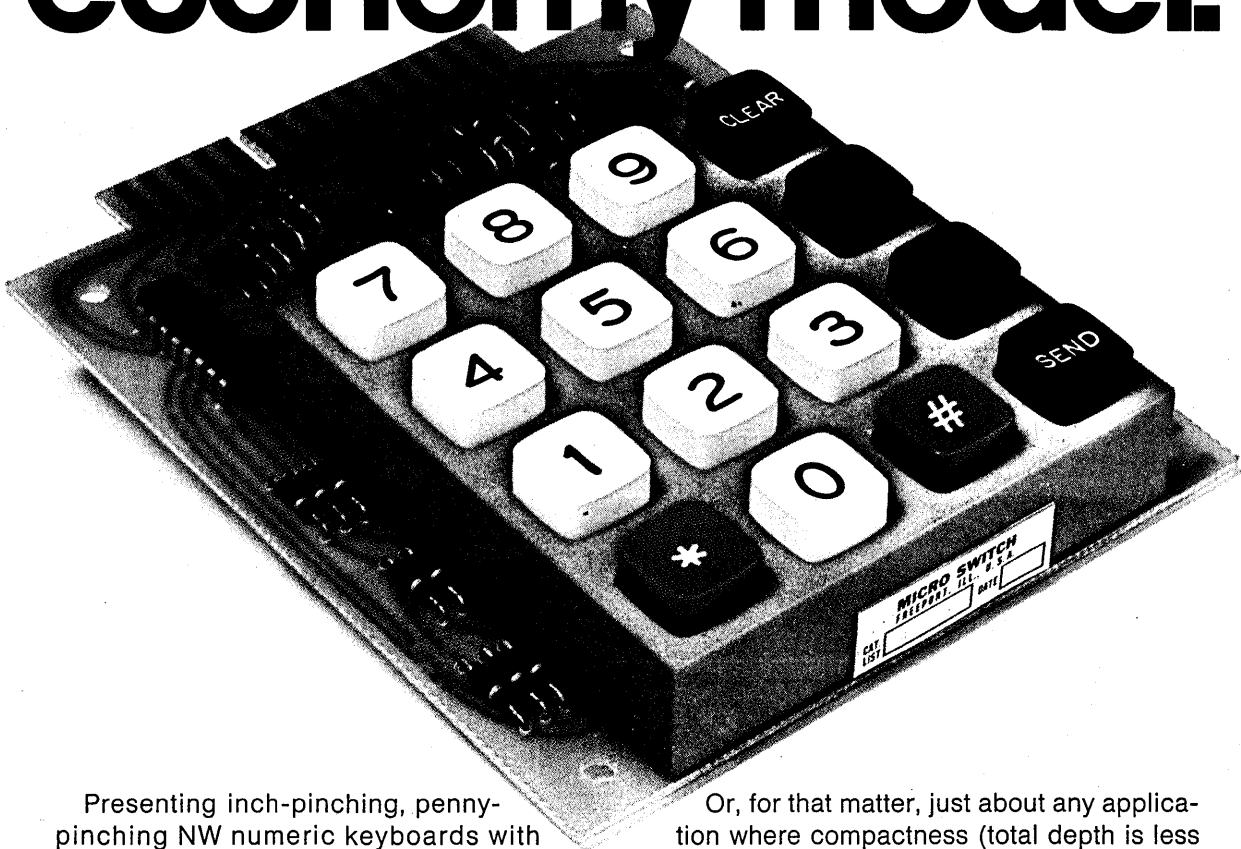

Presenting inch-pinching, penny-pinching NW numeric keyboards with DTL encoding.

They can squeeze in back of most any panel. Because a low-profile design doesn't take up valuable, behind-panel space.

And they offer a slow make, slow break contact action at a low per-station cost.

Key formats are available in "adding machine," Touch-Tone\* or in custom colors and legends within existing housings. Which makes our new models ideal for desk top calculators, point of sale stations and credit verification equipment.

Or, for that matter, just about any application where compactness (total depth is less than one inch), life (tested to one million electrical operations) and low cost are important.

NW keyboards are available in either 12 (3x4) or 16 (4x4) stations. Each with BCD or Excess 3 codes. But if you don't require our encoding, non-encoded keyboards are also offered.

Your MICRO SWITCH Branch Office can arrange for off-the-shelf availability for evaluation and prototype use. Call them or write for our special NW keyboard literature.

\*Trademark of AT&T.

**MICRO SWITCH**  
FREEPORT, ILLINOIS 61032  
A DIVISION OF HONEYWELL

HONEYWELL INTERNATIONAL: Sales and service offices in all principal cities of the world.

economies of "more bang for the buck" for the 155, his installation can save on peripheral equipment and on personnel — less of each are needed to operate one machine vs. the former configuration of three machines. The model 145 represents future growth at Zayre and was not included in Bozeman's analysis.

Paul Kwasnick, vice president and treasurer, said Zayre has purchased the 155. The company, however, is financing the equipment via a third party leasing arrangement. The purchase value was placed at \$1.2 million by Kwasnick.

One Zayre employee at the installation said IBM had sent some of its top installation and computer design people to assist in the installation of the new equipment. The computer, he said, was installed in a matter of hours.

Zayre's computer installation processes data on more than 2 million customer sales recorded in the company's stores each week and the firm said that Zayre's computer applications for the 155 required no modification of previous programs.

The wide variety of data processing chores performed by the new equipment includes the processing of point-of-sale information from thousands of Zayre departments, as well as inventory data provided by the firm's distribution center.

In addition to the equipment at Zayre's headquarters at Framingham, Mass., the company operates six System/3 mod. 10s at distribution centers across the country. Eventually the S/3s will communicate directly with the 155.

### Anything IBM on This Table, 27-39% Off

In January IBM announced its first purchase-price cuts on out-of-production equipment since 1965. They include processors in two maverick models of the 360 line — the smaller RPG-oriented 360/20s and the scientifically oriented 360/44; the 2314-1 disc drive; and the 2361 large core storage.

The model 20 cpu's were chopped by 30%. The models 3, 4, 1, and 2 (in ascending order of size), formerly ranged from \$16,100 to \$56,830 and

now are \$11,270 to \$39,780. The largest of the 20s' the model 5, remains unchanged. One source reads this move to mean IBM does not plan to support these customers in the 370 line. They require a disproportionate amount of support to revenue and, if anything, should be transferred to the enlarging system/3 line, which has automatic design tools for application packages and other more economical support practices.

The model 44 processor was cut by 25% and now ranges from \$87,200 to \$311,700. The 2314-1 disc drive was reduced by 25% so its cost is now \$170,830. Rental users are the only ones who can take the purchase option on the drives. The 9-spindle 2314-1 was actually supplanted starting June 1969 by a faster 2314-A1 (60 msec access time versus 75 msec). The 2361 large core storage 1- and 2-megabyte models came down 40% to \$177,830 and \$296,380, respectively. Each are 27-39% less than the prices offered for higher speed competitive systems produced by independent firms.

IBM has also stopped production on most of the rest of its 360 processors; the 30, 40, 50, 65, 75, and 85. The 25 is in limited production; the 195 in full production. But it is not expected that prices will be cut on any of these models since they would hurt 370 sales. The 1965 price reductions were 15% off the processors of the 7080, 7090, 7084, and 7094 II, and 15% off the core systems of the 94 and 94 II.

### United We Stand, Departed We Fail!

Each year in the U.S. enough airline tickets are stolen and forged to amount to over \$100 million in fares. Over 90% of that potential dollar value is concentrated in Los Angeles, and nobody has more trouble with bogus or stolen tickets than United Air Lines terminal at L.A. International. Clearly something had to be done — UAL's earnings have been depressed enough lately and they need all the paying passengers they can get.

TRW Data Systems of suburban Redondo Beach, Calif., supplied a version of their Credifier credit checking system to UAL late in January. Included in the package were 23 keyboard terminals scattered about the

boarding and ticket areas for UAL employees to enter ticket numbers into a hardwired cpu using a disc storage unit for memory. The capacity of the disc unit is 110,000 serial numbers and more disc units can be added if the number of tickets exceeds this figure. As of February 9 there were 65,000 stolen ticket numbers on the disc sufficient to turn on a little red light at the terminal one second after the ticket number is entered, and bring UAL supervisors and L.A.P.D. officers into action. Since the system has been operational, UAL has altered the destinations of enough people to feel that they are getting their money's worth — a rental of something less than \$2K/month. There are also checks performed for forged tickets, but neither TRW, UAL, or the L.A.P.D. want to talk much about the process, understandably. A forged ticket turns on *three* lights.

Of course, now that the word is out that UAL has this system, potential passers of the bad tickets can take their chances with some other airline not having such a system. If a UAL ticket is passed, the cost will eventually come back to United. The agreement on stolen tickets currently reads that the original issuer of the ticket pays the tab, and not the airline that accepts the ticket. United is now pressing to renegotiate this agreement with the other lines.

There appears to be some disunity on whether the system will really do the job. "Backwards," says Capt. Frank Beeson of the L.A.P.D. bunko division. "The whole system is backwards. If you really want to go about the problem correctly, then you put all the *good* numbers in the computer. The forgers are already altering one digit on these serial numbers so that no match is made by the computer and the ticket is assumed to be good." Such a system, however, would require gobs more memory capacity according to TRW, and would be prohibitively expensive unless all the other airlines co-operated. TRW is busy negotiating with several other major carriers on installing the current system used by UAL — but we understand that one of the major carriers is balking at going along. Which leaves some with reservations that if only United is united, it isn't enough.

*(Continued on page 56)*



### Computers in LA Feb. 9 — Nothing Earthshaking

Downtime from power failures played havoc with work schedules, but otherwise computer rooms in Los Angeles fared well Feb. 9 after the area's severest earthquake in 38 years.

It was a maintenance man's nightmare, however. Mike Tannahill, 28-year-old administration operations manager with the Los Angeles IBM field engineering office, said the office had its busiest day in history. The facility on the 22nd floor of the 42-story Union Bank Building in downtown was vacated shortly after the 6 a.m. earthquake. When Tannahill and his staff had climbed the 22 flights of stairs back to the office at 7:30 a.m. (a power failure shut down the elevators) all eight lines to the office were loaded. In the next 45 minutes IBM received 70 calls from clients whose machines were down. During Tannahill's 12-hour work day IBM handled a total of 94 service calls. On a normal shift it receives 50.

A sampling of the problems:

Control circuits had been jiggled loose on a 360/67 at System Development Corp. in Santa Monica. The Los Angeles County Medical Center's mod 50 had lost power, while all supplementary power was being used to keep the rest of the hospital in operation. The Broadway Department Stores was about to start running the payroll on a mod 40 when it lost power. Southern California Gas Company wanted someone over to help it restart a 40 and 50. It feared a disc crash. Out in Encino, Informatics actually had a disc crash. In Van Nuys, out in the hard-hit San Fernando Valley, the 1900-pound mod 20 cpu at Litton Data System had toppled over onto its side. The computer room at the Metropolitan Water District was flooded.

McDonnell Douglas Automation said a mod 30 at its Torrance facility went down and the company was now taking a long hard look at its security setup. Most often mentioned by some 15 installations called on by *DATA-MATION* was the value of installing uninterruptible power supplies that keep computers running during power failures.

A UPS system at Transamerica in downtown Los Angeles kept three

mod 65s in operation but the computer center lost a day and a half of work anyway when the company's management sent employees home while the 35-story building was inspected for structural damage. In the tape library, 600 reels came crashing down from their storage racks, but luckily were work tapes and no files were lost.

At the Broadway installation, security precautions almost proved hazardous. The computer room uses a buzzer lock on the door. When the power went out, the buzzer was inoperative and employees had to vacate through a fire exit. DP manager Vince Conant said it cost about \$1500 in production time and to re-certify some 80 reels of tape, shattered when 500 of them were jolted out of their racks in the 2000-reel transient tape library. Permanent files are stored elsewhere. But it made its payroll on time.

Casters placed on peripheral equipment to facilitate the CE's work turned out to be undesirable in earthquake country. At one facility, peripheral units that were neatly lined up the previous day were found to have "walked around." A caster in a disc drive at Informatics got caught in a cable cutaway on the floor to cause the disc crash. A tape drive at the Transamerica installation was found leaning dangerously with the caster lodged in a cable hole. Other installations were inspecting tipped machines for damage.

J. Damate at the Los Angeles County Medical Center said his mod 50 was down six hours and estimated it cost the center \$15-20K in lost production.

A.E. Scott, edp staff supervisor at Southern California Gas Co., was becoming concerned when the IBM field engineer hadn't shown up after the second call; but was pleasantly surprised when his IBM CE strolled in accidentally because the elevator in his own building wasn't working.

Bill Kervahn, manager of dp at the Metropolitan Water District, was back in business by noon the day after the earthquake, despite a flood in his 600 sq. ft. room in the basement of the building. A three-inch diameter overhead plumbing pipe burst, pouring water through the acoustical tile ceiling and directly onto the cpu of his mod 30. Kervahn was delighted with

IBM servicemen who were on the scene a half hour after he called and with the IBM salesman who by noon had located two replacements. They weren't needed.

Mike Tannahill says IBM was lucky. Normally, it has only a dozen field engineers available on the graveyard shift. The early morning earthquake awakened all of the 180 day-shift staff who immediately called in and were assigned to specific clients. Most telephones in the San Fernando Valley were out of order and distressed clients couldn't call in. That helped too, says Tannahill.

### Bill Introduced to Aid Jobless Workers, Firms

A bill authorizing the federal government to spend \$450 million on assistance to unemployed defense workers and underemployed defense firms has been introduced by Congressman Robert Giaimo of Connecticut and John Davis of Georgia. It's HR 34, the "Conversion Research and Education Act of 1971." The assistance would consist of grants to schools, non-profit organizations, individual scientists, engineers and technicians, defense-related companies and lenders.

One part of the program would support "community conversion corporations," new non-profit groups set up to perform civilian-oriented R&D.

Another part would finance the training of scientists, engineers and technicians so they could apply their talent to civilian problems. Some of this money would go into fellowships, and some into grants enabling companies to enroll their personnel in the conversion-oriented courses. Other grants would finance management training programs aimed at helping the managers convert the R&D activities of their companies into peacetime applications. Loans for financing such conversions would be guaranteed by the feds through the Small Business Administration, and SBA would pay part of the loan interest charges.

Other sections of HR 34 authorize contracted studies of the conversion problem, and permit establishment of a "computerized conversion information service." SBA would administer part of the program, and the National Science Foundation would be in

## EDP Professionals Want Exemption

charge of the rest.

In FY '72, which begins next July 1, a \$100 million expenditure is authorized. The following year, this would increase to \$150 million, and in FY '74 would rise to \$200 million.

Similar legislation was introduced in the last congress but it didn't get anywhere. This year, the chances are better. Congressman Davis, the co-sponsor, is chairman of the House Science and Astronautics Subcommittee to which the bill was referred.

## EDP Professionals Go Into Labor

Another development in the computer programmer's drive for professional status took place last month when the Department of Labor's Wage and Hour Division held hearings to help determine whether data processing employees at a certain level should be given "exempt" classification under the U.S. Fair Labor Standards Act. This would mean that minimum wage and overtime pay regulations would not apply to programmers and systems analysts, and the ignominy of punching a timeclock would in most instances be eliminated.

Prominent among those who took positions in favor of such an exempt status were the newly formed Association of Computer Programmers and Analysts, and the Industrial Relations Committee of the Western Electronic Manufacturers Association. Paul C. Notari, president of ACPA, defined "professional" as "an individual who is engaged in a specialized occupation that requires a distinct and extensive body of language for initial entry into the occupation, a continuing effort of study and learning to sustain oneself in the occupation, and the use of judgment and discretion to perform a major portion of activities associated with the occupation." He went on, "I am convinced that anyone engaged in an occupation meeting these criteria certainly cannot be bound to rules restricting the amount of time he legally can apply to his work effort without pro-rata compensation."

Representing WEMA was Casey F. Koziol, director of personnel at Motorola, who concurred with Notari on the need for professional status for certain edp personnel, with the addi-

# Something is about to happen.



1600 cpi—that's what's about to happen. And like any event (blessed or otherwise) you'd better be ready. Kennedy System 8000 is the **only** magnetic tape system that allows you to plan for 1600 cpi operation at a later date—with no increase in system cost now.

If NRZ1 is your problem now, Model 8208 Format Control Unit can handle up to four transports. These may be Model 8109, 800/1600 cpi units and/or Model 8107, 7-track, 200/556/800 cpi. When the time comes to add Phase-Encoded 1600 cpi operation, you simply add Model 8216 PE Format Control Unit. All nine-track transports now operate in both NRZ1 and PE mode. No other changes required. The interface remains unchanged—no new transports to buy. You're in the 1600 cpi business.

To make the interface design even simpler, Model 8208 accepts commands in the form of "Write one record," "Backspace one file," etc. Or, you can build your own control units.

1600 cpi—it's going to happen. And if the prospect of owning a house full of obsolete tape decks worries you—contact us. We'll get you to the doctor in time.



KENNEDY—WE'VE BUILT LONGER. WE BUILD BETTER

KENNEDY CO. 540 W. WOODBURY RD., ALTADENA, CALIF. 91001 • (213) 798-0953

CIRCLE 27 ON READER CARD

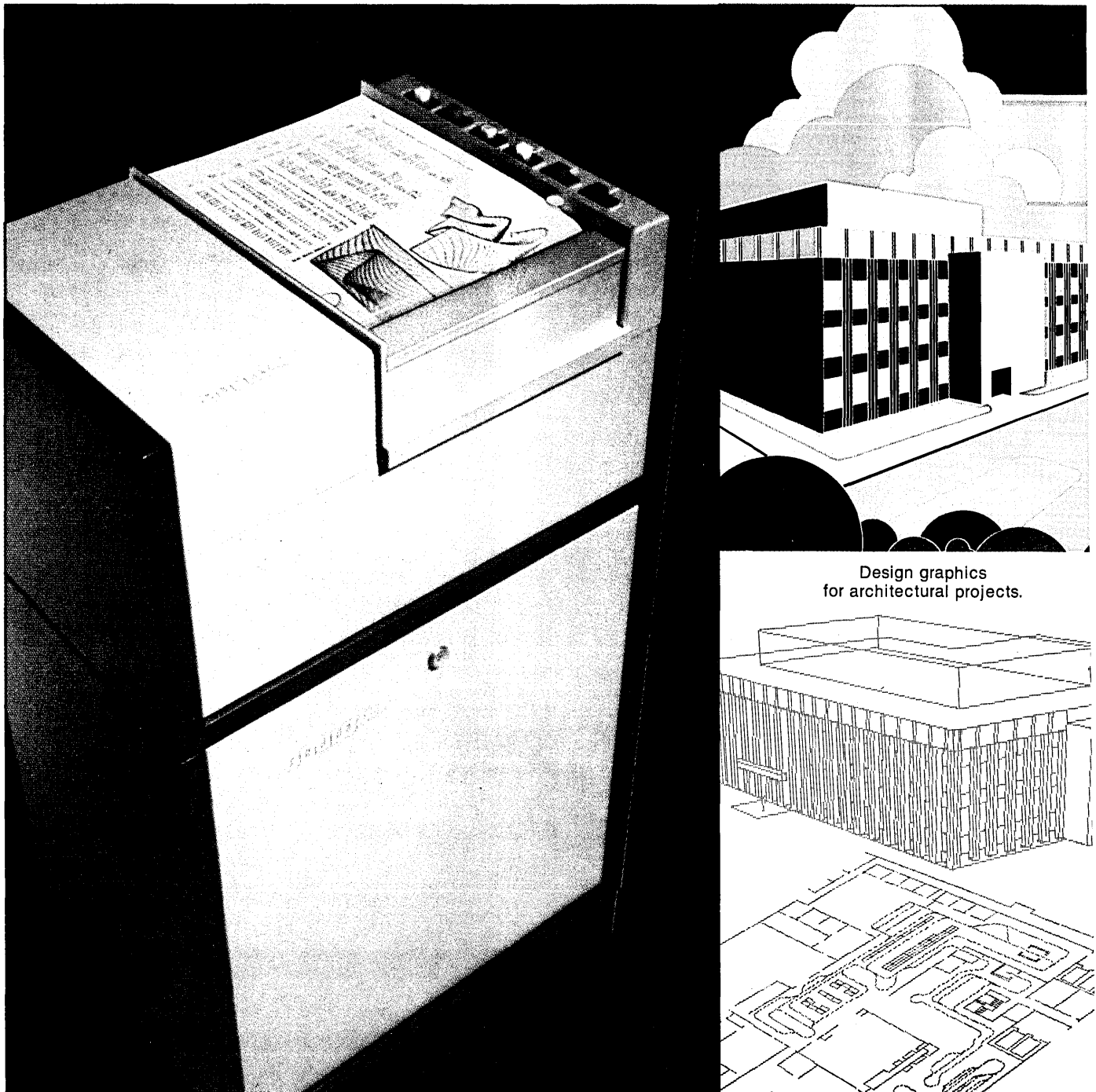

## We helped pull the plug in the computer bottleneck.

A couple of years back, there wasn't a printer around that could begin to keep up with the output capability of high speed computers. And if the data involved both alphanumerics and graphics, acceptable hardcopy took hours to come by.

No more.

The Gould 4800 is the first printer to deliver both alphanumerics and graphics at 4800 lines per minute. That's several times faster than most printers on the market. What's more, the Gould 4800 can maintain such speeds as long as you like.

The Gould 4800 is electrostatic. So the



Computerized design for aircraft brake drum.

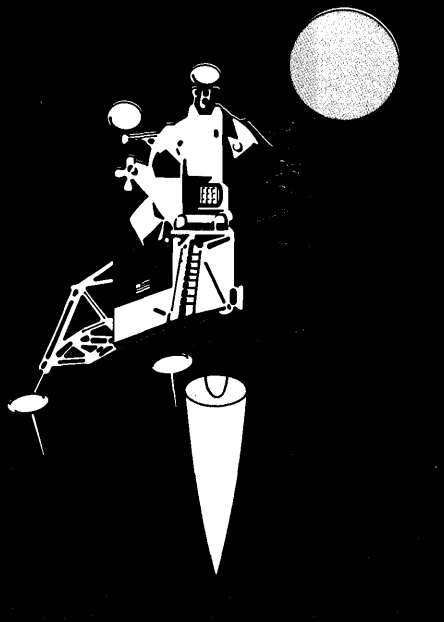
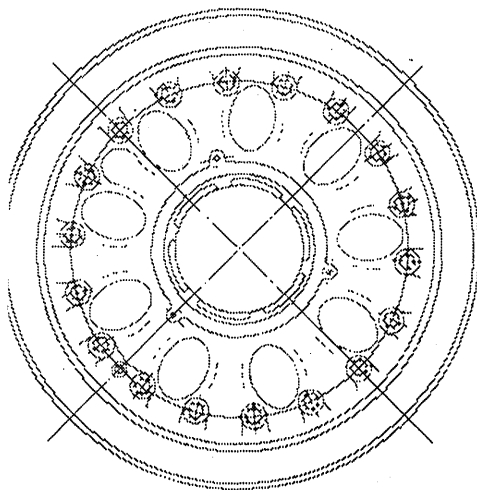

Critical aerospace graphics for quick evaluation.

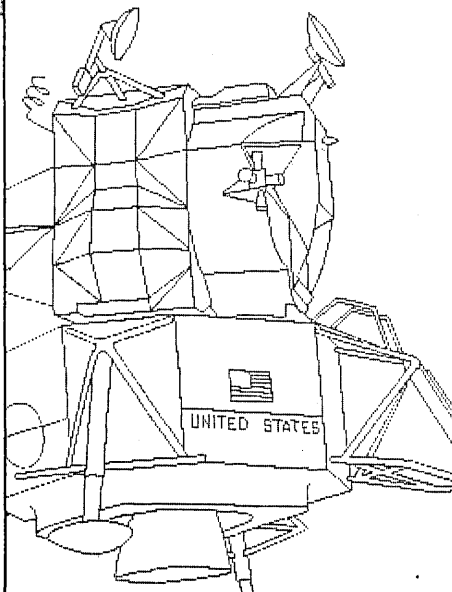

On-time, easy-to-read management reports.

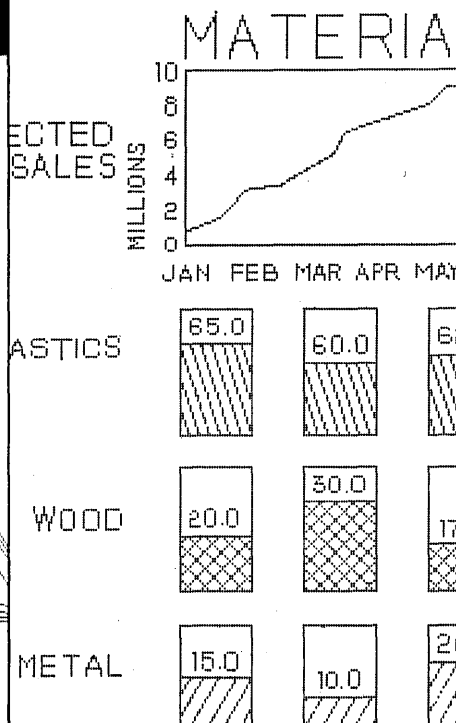

clackety-clack of impact printers is replaced by silence. And people who get paid to think, get some peace and quiet for a change.

There are some nice options, too. Like a character generator. And a choice of 8½" or 11" format. We'll also supply software. Plus interfaces for almost any major computer.

Anybody who uses a computer can use it a lot more efficiently with a Gould 4800. It's another example of how Gould's Instrumentation Group puts hard-to-get information into easy-to-use form. Gould Inc., 8550 West Bryn Mawr Avenue, Chicago, Illinois 60631.

# All our minimemories take a lot of shock and vibration.

Last year, we introduced a line of 9" x 6" minimemories. And they sold well indeed on the basis of application, capacity, and price.

Now we've discovered you're also taking to them for environmental reasons. They're rugged, able to take 10-g shock and 2-g vibration, even without shock mounts. And they're reliable. Try 11,880 hours MTBF (per MIL-HDBK-

217A) and more than 180,000 complete start-stops without signal degradation. Not to mention mounting convenience—the minis that operate in any position.

The applications still send you: mini-computer auxiliary storage, numeric control, production checkout, inventory control, communications terminals, and lots more even we hadn't thought of.

Four capacities— $\frac{1}{2}$ ,  $\frac{3}{4}$ , 1, 1  $\frac{1}{2}$  megabits—each in the same small size.

And the price is attractive (all in 1-9 quantities): \$2750,  $\frac{1}{2}$ -megabit model; \$3150,  $\frac{3}{4}$ -megabit; \$3530, 1-megabit; \$4350, 1  $\frac{1}{2}$ -megabit.

Whatever your needs in disc memories, Librascope Division of The Singer Company can fill them. For complete technical data, write 808 Western Ave., Glendale, California 91201.

**SINGER**  
LIBRASCOPE

There must be many uses for minimemories.



## NEWS SCENE

tion that WEMA is also plumping for professionalism for technical writers, engineering and drafting designers and engineering technicians. One interesting aspect of the WEMA presentation was a definition of the esoteric position of senior systems analyst, taken from the WEMA Benchmark Survey: "Identifies and defines business problems or processes that can be improved in method, organization, procedure and information flow, interviews all levels of management and operating personnel; examines and evaluates functional organizations, policies, and procedures; gathers and analyzes operating data. Develops proposals supported by economic evaluation and provides systems specifications for subsequent implementation by computer or other business equipment."

This differs slightly from the ACPA definition, which includes such phrases as "The system analyst must be a former programmer who fully understands the problems and vexations of programming operations. Furthermore, he must be highly familiar with the various functions or problems which are to be computer applied."

Definitions are ever difficult in the quest for professionalism. One thing seems clear: Even if a firm decides to pay overtime to edp personnel (as it can if it chooses, even to exempt employees), what professional would deign to accept it?

### MDS Bets Big on End User Market

Mohawk Data Sciences Corp. has bought Atron Corp., Minneapolis manufacturer of minicomputers, and is beginning to market a series of peripheral processing systems.

The events move the developer of the Data Recorder, which in the past few years has been eclipsed by the company's peripheral gear business, squarely into the end user market.

Company president, R. P. Rifenburg, describes MDS involvement with its new System 2400. "The Peripheral Processor" (see p. 73), as a case of "you bet your company." He claims the company has made the largest commitment in its history to the new line and expects it to be very instrumental in pushing revenues to the quarter billion mark. The \$250,000

figure is halfway to Rifenburg's declared goal of making MDS a \$500 million company.

Rifenburg also said that System 2400 fulfills the original goal of MDS's founders. The company was formed in 1964 after the announcement of System 360 with the intention of producing a faster 1401 to sell to IBM users who didn't want to convert.

Pressure for the MDS move into end user sales of peripheral systems has been building through the past year. Despite profit growth of about 25%, Data Recorder deliveries plummeted and sales leveled sharply.

Rifenburg called it a disaster year for the data entry equipment largely due to the replacement of seven track equipment, the Model 1100 gear, with Model 6400 nine track devices. However MDS has some 8000 of the individual data entry devices in operation along with another 500 or so units in the Model 9000 cluster system which helped generate \$38.2 million in rental and service revenue, a hefty one-third of the company's \$102.5 million total.

Oem sales impacted by NCR's cutback on data recorders and the general economic downturn raised sale revenue only \$3.4 million to \$64.3 million. In 1969 sale revenue was \$60.9 million, an increase of \$16.4 million over the previous year.

The figures indicate a growing future for end-user marketing and a rental base. For MDS an easy way to exploit this is to repackage its existing products which is what it has done with System 2400. The gear includes the printers, card and paper tape units, a communications adaptor, an oem disc unit and the data recorder that the company has been selling oems. An addition is a new magnetic tape drive which may eventually be sold as a replacement for the IBM 2501-5 drives. All of the equipment can be mixed and matched for off-line input preparation, output conversion and communication, the System 2400 tasks.

The only item MDS did not have in-house was a computer and the purchase of Atron takes care of that. The deal, a \$6.5 million stock swap, amounts to making a cost item into a profit item. MDS helped establish Atron, held 195,000 shares and has been buying 85% to 90% of its pro-

Collins **NEW**

**TE-236**

**2400** BPS

**DATA MODEM IS . . .**

**FASTEST**

in acquisition time.  
Only 10 ms.

**SLOWEST**

to error.  
BER is 1 in 1,000,000.

**HIGHEST**

in reliability.  
MTBF is 20,000 hours.

**LOWEST**

in price for any modem approaching Collins quality.

Only

**\$1750**



Call or write your Collins rep or  
Collins Radio Company, Dept. 600,  
Newport Beach, California 92663.  
Phone: (714) 833-0600.

CIRCLE 67 ON READER CARD



# D-112

12-Bit Minicomputer  
Plug and Program  
COMPATIBLE  
With PDP-8\* Series

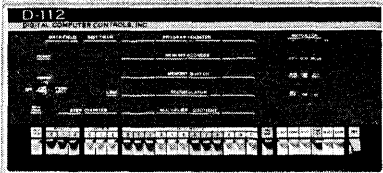

8¾" High x 19" Wide Console

- Now with complete options—Extended Arithmetic, Power Fail, Data Break, Real Time Clock, Comm. Interfaces
- Peripherals — DECTape\* Equivalent, IBM Compatible Tape, Disk Systems, Printers and Displays
- MSI, TTL, Integrated Circuitry
- 1.2 Microsecond Memory Cycle Time
- Memory Expansion to 32K Words in Main Console

## DIGITAL COMPUTER CONTROLS, INC.

23 Just Road  
Fairfield, New Jersey  
201-227-4861 07006

\*Registered Trademark of Digital  
Equipment Corporation  
Digital Equipment Corporation

CIRCLE 23 ON READER CARD

## NEWS SCENE

duction. Now it can possibly take a profit from the remaining 10% to 15% and also get a tax credit for Atron losses. In FY 1969 Atron lost \$1.1 million on revenues of \$895,483.

Rifenburgh expects the company to have a 20% annual growth to the \$500 million mark. The Data Recorder's role will continue to decline and the impression is that it is fast becoming merely the expedient that got the company going. Data entry competition already considers MDS static in that market and company officials are quickly merging the System 2400 with the 1401. Rifenburgh ties the two together nicely by recalling that the 1401 when introduced by IBM at the 1959 Eastern Joint Computer Conference, was designated an I/O processor for the 7000 series.

He adds that MDS is not attempting to get into the cpu business but wants to be a throughput specialist on the periphery. Which may be so, at least for the next five years, which is the life span he allocates the 2400.

### Intranet Computing: One Small Step ...

It isn't easy for a company to pull itself out of Chapter XI without being acquired (Feb. 1, p. 47) but it looks as if Intranet Computing Corp., Los Angeles time-sharing and peripherals manufacturing firm, is going to do it.

The company, which completely shut down operations when it filled bankruptcy proceedings last November, began operating again in a small way early last month. Armed with \$60K raised by "a small group of wealthy individuals," many of whom are substantial Intranet shareholders, Intranet resumed work on completion of a \$680K contract from JPL for controllers that enable Univac 1100 series computers to use disc drives. It was anticipated completion of the contract would take 45 days. This would complete what James Halverson, vice president and director of finance, called Step One on the road back.

With the initial \$60K, Intranet received assurance of an automatic commitment for an additional \$250K on completion and acceptance of the JPL order. This, said Halverson, would enable them to pull out of Chapter XI, completing Step Two. The

company owes \$1,500,000 in trade debts and \$1,500,000 on convertible debentures. Their biggest single creditor is Univac for \$500K. Under the plan they hope will get them out of Chapter XI, all debt would be converted to stock.

They won't jump back into time-sharing. Instead they'll concentrate on promoting their hardware and on leasing the operating system they developed for their 1108-based time-sharing system. Halverson said the OS would lease for about \$8K per month.

Step Three of the recovery plan calls for a public offering of from \$1-3 million this fall. Then, "with the spookiness gone," says Halverson, "we'll be able to dicker from a good position with big companies interested in acquiring a big part of Intranet." And only after such an acquisition will they get back into time-sharing.

### Better Late Than Never

Early last year, a dedicated time-sharing computer system was announced that its builders said could comfortably handle 96 commercial users online at one time or 32 scientific users. Nothing was said about the arts.

Yet, a little more than a year later, that is the area in which the TENET 210 (Feb. '70, p. 197) is seeing its first use — and for free its manufacturer, TENET, Inc., Sunnyvale, Calif., granted \$10,000 worth of time on its first prototype 210 to the East West Music Ensemble, a San Mateo, Calif., group set up to preserve traditional Oriental music and to promote understanding of East and West through musical performance. The group will use the time to develop a multifunction music system that will perform such tasks as composition, transposition, and converting to and from Oriental and Western notation.

Admittedly TENET is a little behind the schedule included in its original announcement, which called for deliveries to begin last July. They're still aiming for July — July 1971. This is when they hope to make delivery on their first sale, a sale that was "almost a sure thing" at this writing. But there were other promising nibbles. They have two working prototypes and there is talk of a one-per-month production rate later this year.

The 32-bit (plus parity) word machine is attractively priced at \$396K (up from an originally announced \$325K) including two disc files, memory mapping and communications equipment for 32 terminals and it can make beautiful music.

## NEWS BRIEFS

### NASA Bags First Illiac IV

Illiac IV, the huge parallel processor under development by the University of Illinois and Burroughs since 1966, will be installed at NASA's Ames Research Center, Moffett Field, Calif., instead of at the University as previously planned. DOD's Advanced Research Projects Agency, the sponsor, denied that student demonstrations several months ago were the reason. NASA, said ARPA, came out first in a five-way competition.

The system is to be installed at Ames late this year. It will be a stripped-down, 64-processor, one-quadrant version of the original four-quadrant design. The university "will continue to have overall responsibility for . . . manufacturing and basic system software until these are completed," ARPA said. But other sources report that the agency has decided to hire an outside software contractor.

### Huson Moves North

Disenchantment over recent corporate reorganization moves, we hear, led to the resignation of Andrew S. Huson as general manager of Raytheon Computer. Huson, who had been at the helm of the Santa Ana, Calif., firm for three years, has moved north to become president of Data Technology Corp., San Jose maker of digital modules, cassettes, and tape reels. He leaves a 400-man operation to join one that employs some 600. Succeeding him at Raytheon is J. Thomas Markley

## NEW COMPANIES

One new service bureau is banking on a brisk trade in System/3s. **CMC System/3 Service**, Newton, Mass., will provide assistance in implementing (Continued on page 68)

March 15, 1971

# ALPHA DATA HAS A 128 TRACK MIND.

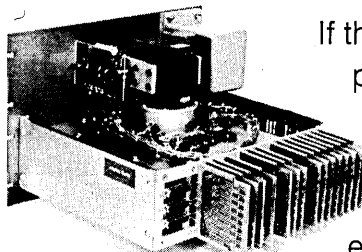

If that is too many for your present needs, we have a starter unit with only sixteen. If you need more later, it is easily expandable. With all of

these features our magnetic disc memory is still the best buy in the industry:

- Head lifters to eliminate disc contact starts and stops.
- 8.4 milliseconds average access time.
- Sealed construction.
- Choice of interfaces — bit serial or parallel.



8759 Remmet Avenue, Canoga Park, California 91304 • (213) 882-6500

CIRCLE 17 ON READER CARD

## computers carted with care

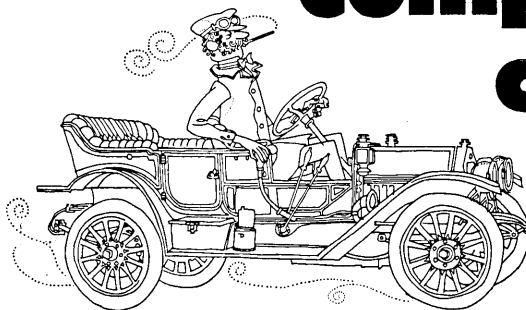

When you ship computer hardware, look for an experienced computer mover like Data Transportation Company, an agent of Burnham Van Service, which helped pioneer the nationwide moving of "electronics" and other high value cargo. Data Transportation Company has air-ride vans with power tailgates and the most advanced tie-down systems. But more important Data Transportation Company has the know-how to load, move, and unload your computer hardware without damage. And the know-where to spot your shipment at all times, day and night, from one end of the country to the other. Call the man from Burnham Van when you're ready to ship. Call Data Transportation Company, Burnham agent specializing in carting computers with care.

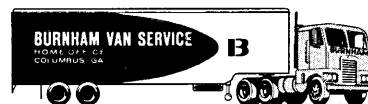

## Data Transportation Company

64 Barnard Avenue / San Jose, California 95112 / Telephone (408) 294-3812

CIRCLE 33 ON READER CARD



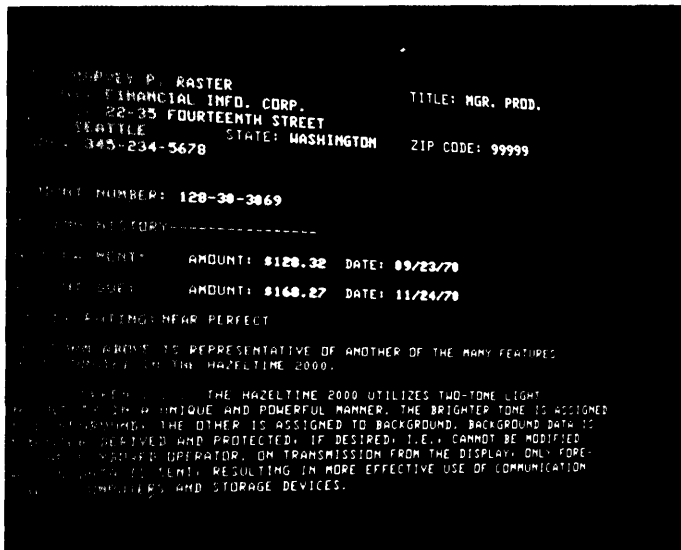

**Two-level video intensity.** Useful for form fillout. Computer-derived protected data is lower intensity; operator-entered data is brighter. **Selective scrolling** at any line when under program control; automatically at line 1, unless otherwise directed. **Automatic tabulation** in form fillout directs cursor to next entry point.

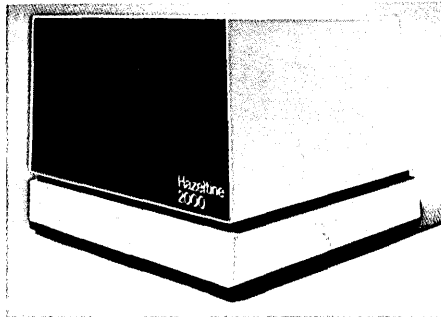

**3 remote monitors** may be connected without amplifiers. With amplifiers added, the number is unlimited.

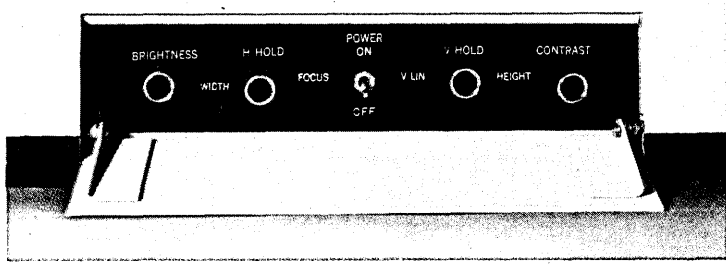

**Individual TV adjustments** conveniently located up front for optimum operator comfort.

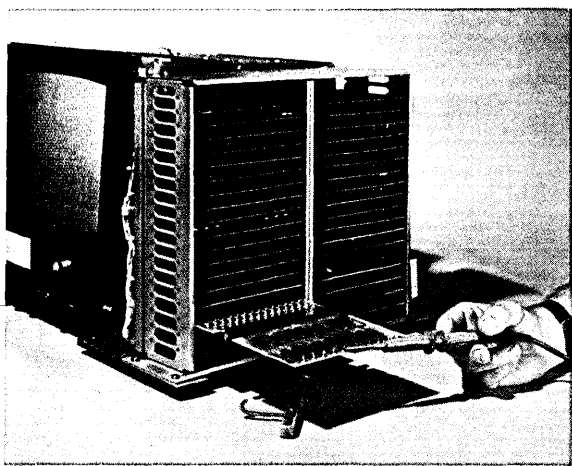

**Reliable solid-state circuitry** assures virtual trouble-free operation. Maintenance is as easy as opening a drawer.

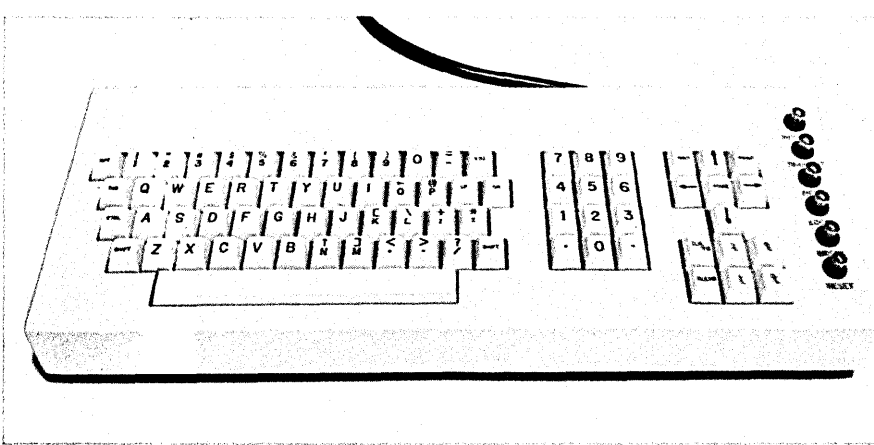

**Quiet, solid-state keyboard** in Teletype terminal format may be operated remotely.

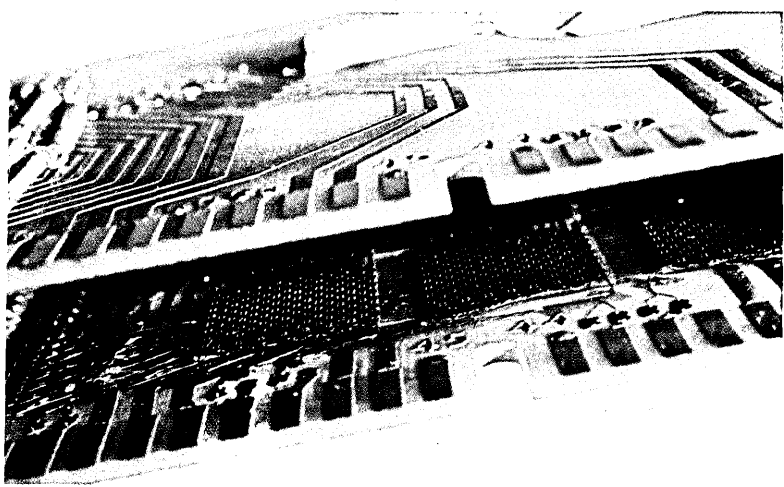

**High-speed, random-access core memory (2048 x 8)** provides flexibility and efficiency consistent with all the unique design features of the Hazeltine 2000.

## Plus: Low Cost!

**\$88 per month (12-month rental) plus \$20 maintenance.**

We'll be happy to demonstrate the Hazeltine 2000 in your offices.

# Hazeltine 2000

**Hazeltine Corporation**

Little Neck, N.Y. 11362 Phone (212) 423-4800



**measurex**  
1000 High-Torque Servo

# A minicomputer here?

## Sure! And ours is helping boost profits up to \$20,000 a month.

Paper mills can be pretty rough on electronic equipment. So any computer system put there had better be able to take it — especially if it's guaranteed to increase profits. And Measurex of Santa Clara, California does just that. They guarantee profit increases from \$4,000 to \$20,000 a month.

That's one big reason why they chose our 2116 Computer as the heart of their paper mill process control system. They knew it would keep on working in spite of heat, humidity, vibration and corrosive fumes — acting as an on-the-spot control center in Measurex's unique system for regulating the moisture and fiber content of paper speeding along at hundreds of feet per second.

It's a job that affects profitability in a big way. Misjudging fiber or water content, even slightly, can be costly. But improved reliability and accuracy can pay off to the tune of half a million dollars a year in added profit. With so much at stake, it's not surprising that Measurex chose our computer.

There are other things to like about our small computers: good specs, comprehensive software and simple interfacing with all system components. Constant updating without obsoleting your present system. (Measurex will soon switch to our new 2116C just by plugging it into the old interfaces.) Plus our complete line of input/output devices, available off-the-shelf.

Another benefit: our minicomputers don't put the squeeze on an OEM like Measurex — or any other purchaser. For instance, you can now buy our new powerful 2116C, with up to 32K of core memory — all in the mainframe — for just \$50,000. If you don't need that kind of power, our 4K version of the 2114C costs just \$8500. And we've doubled the memory of this computer, too. So you can now get a 16K version for \$22,000.

Get the full story on computers you can depend on. Call your nearest HP sales office or write to Hewlett-Packard, Palo Alto, California 94304; Europe: 1217 Meyrin-Geneva, Switzerland.

HEWLETT  PACKARD

DIGITAL COMPUTERS



conversion to System/3 ... Consolidated Computer Ltd. and Ford Motor Credit Co. established a new lease financing company, **Consolidated Computer Leasing Corp.**, to finance the leasing of up to \$15 million of Key-Edit equipment to users in North America ... Inforex, Inc. formed **Infobond Corp.**, to manufacture and market the kind of wire bonded printed circuit boards it uses in its key entry systems ... **Microwave Inc.**, organized in New York City, describes itself as, "the first company specializing in the development of packaged software for microfilm systems." ... A new facilities brokerage operation, **Communications Facilities Exchange**, Ramsey, N.J., lists private wire circuits available for shared use under various common carrier tariffs and facilities available in customer-owned systems ... **DataCreation Services** was formed in Beverly Hills, Calif. to create large test data files for software quality assurance ... The Singer Co. formed a new **Information Systems Group** to, "undertake ex-

panded operating responsibilities in the retail automation, office equipment and data processing field." ...

**Bridge Computer Systems, Inc.** was formed in Mamaroneck, N.Y., to tailor, "complete low-budget computer systems for specific needs" ... **HCR Systems Corp.**, Cambridge, Mass., will specialize in computer consulting services for the hotel, construction and real estate industries ... Another new consulting firm, **Welch Associates, Inc.**, Waltham, Mass., will offer consulting services in executive and professional placement, search, technical marketing and information processing ... **Speedkeeping Systems, Inc.**, Mountain Lakes, N.J., was formed to market computerized bookkeeping-accounting systems ... **Staff Dynamics, Inc.**, a subsidiary of Data Products Corp., Woodland Hills, Calif., opened a Computerized Drafting Center to operate as a service bureau to, "provide high quality inked schematic and logic diagrams drawn to mil standards suitable for microfilming."

**MERGERS, ACQUISITIONS**

The urge to merge wasn't strong in 1970 when merger announcements were down 15% from 1969 according to Chicago-based merger specialists, W.T. Grimm & Co. which noted that one trend which kept the decline as low as it was, was a need for adjustment and divestment, "particularly for companies suffering indigestion from acquisitions in the merger-heated years of 1968 and 1969." Some 27% of 1970's mergers were sales of subsidiaries, divisions and/or product lines, says Grimm, up from 13% in '69. Early announcements of 1971 for the data processing industry reflect more of the same. **Varian Associates**, Palo Alto, Calif., purchased for cash the Vacuum Equipment Div. of **Norton Co.** with major facilities in Newton, Mass and Sunnyvale, Calif. ... Shareholders of **Computer Radix Corp.**, New York City, approved an agreement to acquire the New York

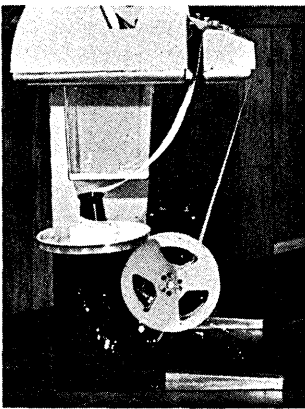

**FEED,  
COLLECT  
TAPES  
IN ONE OPERATION**

***in/opac*** DIVISION

Numeridex Tape Systems, Inc., Dept. D  
4711 W. North Ave./Chicago, Ill. 60639/312-772-6400  
**Your most complete source of supply for  
data processing peripherals and expendables**

CIRCLE 44 ON READER CARD

IN/OPAC's Data Center, designed specifically for Teletype Model 33 terminals with time-share users in mind, provides continuous, simultaneous winding and unwinding without operator attention. The Data Center fastens to the terminal in seconds. Write for details. Let us send you our new data processing input-output accessories catalog.

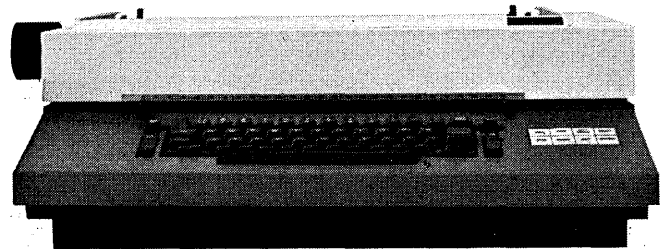

This is the real-time computer terminal that's 48 pounds *portable*. The lightest Selectric available. Carrying case is available too. It's the model 5-41, and has a speed of up to 15 chars. per second, and the wide 15" platen.

Novar Corporation • 2370 Charleston Road  
Mountain View, Calif. 94040 • (415) 964-3900  
Nationwide Service In 56 Cities

**NOVAR**

A Member of GT&E Information Systems, Inc.

CIRCLE 29 ON READER CARD

operations of **Boothe Resources International**. . . **Survey Research Sciences, Inc.**, Dallas, acquired the Market Research Div. of **University Computing Co.** . . . **United Computing Systems, Inc.**, Kansas City, Kans., acquired the time-sharing services, and "certain software packages and facilities," of **Academy Computing**, Oklahoma City . . . **RCA Corp.** sold its brokerage data processing service to **Automatic Data Processing, Inc.**, New York City . . . **University Computing** increased its ownership of **Computer Technology, Inc.**, Dallas, with acquisition of an additional two million shares from **LTV Aerospace** . . . **Computer Network Corp.**, (COMNET), Washington D.C., acquired the computer business of **U.S. Time-Sharing, Inc.** . . . **Leasco Systems Corp.**, Oak Brook, Ill., the computer systems consulting subsidiary of Leasco Data Processing Equipment Corp., sold its Education Division to **Deltak Inc.**, a new company headed up by former LSC officers .

## SHORTLINES

It's really official. GTE (aka General Telephone & Electronics), which followed ITT, RCA and IBM into the ranks of firms seeking initial identity, is now GTE on the New York stock exchange instead of GEN . . . Seaco Computer Display, Inc., Dallas, moved into far eastern markets with appointment of Mitsui & Co., Ltd., Japanese general trading firm as its sales and service representative in that part of the world . . . Tenecomp Systems, Inc., Oak Ridge, Tenn., and Digital Equipment Corp., Maynard, Mass. signed an agreement under which DEC will provide maintenance nationally on three Tenecomp peripherals, all plug-to-plug compatible with the PDP-8, 9 and 11 families . . . ITT Data Equipment and Systems Division began delivery on its Alpha-scope Display Systems, a direct replacement for the IBM 2260 . . . The University of Houston will offer a six-week summer course on Computer

Science, An International Perspective, July 15 - Aug. 29. Registration information can be obtained from Robert A. Sibley, Jr., Department of Computer Science, University of Houston, Cullen Blvd., Houston, Texas 77004 . . . American Express Investment Management Co. and the Fireman's Fund American Insurance Co. signed a contract with Western Operations, Inc., for development of an institutional portfolio management system scheduled for installation during the second quarter of 1971 . . . Infodata Systems, Webster, N.Y., last month installed its first INQUIRE, a software package for management and research, in Europe, in the Esso Petroleum Co., Ltd. computer center in London . . . Computer Sciences Corp. received an initial five-year contract for \$11 million from RCA for major software for the Navy Aegis . . . Information Storage Systems, newly acquired by Intel Corp., moved into a new 30,000 sq. ft. headquarters facility in Cupertino, Calif. ■

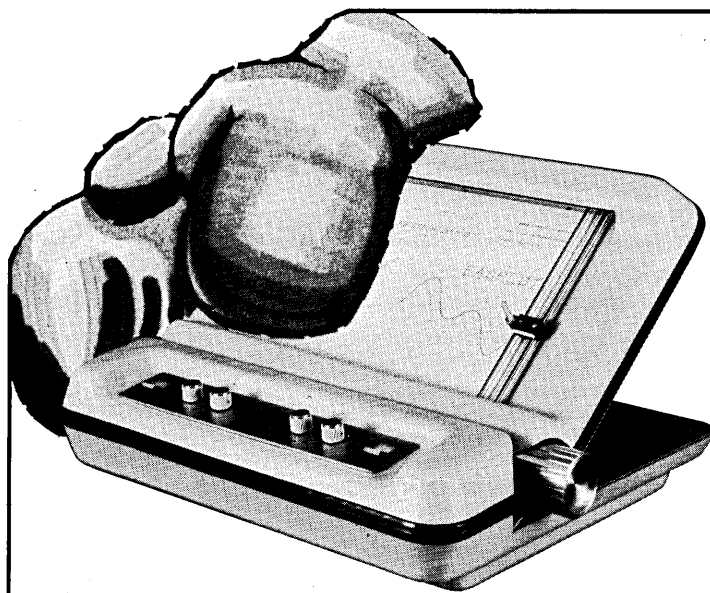

*It's not even a fair fight.*

Omega-t's FasPlot is the best of its kind on the block . . . or in the whole computer industry, for that matter.

*Sound like childish claims? Well, listen.*

# Our Plotter can outplot your plodder.

Our plotter is the fastest in its class, moving along at 10 ips.

Our plotter is adaptable to any type of interface, on or off-line, including CRT.

Solid state electronics make FasPlot dependable and accurate. And, it's easy to operate, with no special software necessary.

We'll put our plotter up against our competition's any day. Glen Renfro is FasPlot's manager . . . just call or write him at Omega-t Systems, Inc.

**omega-t systems incorporated**

300 TERRACE VILLAGE • RICHARDSON, TEXAS 75080 (214) 231-5121



®  
\*REGISTERED TRADEMARK

CIRCLE 30 ON READER CARD



**Speed isn't everything.  
High resolution isn't everything.  
Upwards expandability isn't everything.  
But all three together?  
That's everything.**

**And that's the new Singer  
COM plotter/printers.  
Here today. Yours tomorrow.**

MS-5000 works off your digital computer, on line or off line. MS-6000 works off its own internal digital computer. For technical literature and applications assistance, write: Singer Micrographic Systems, 1077 E. Arques Avenue, Sunnyvale, Calif. 94086.

Visit us at SJCC.  
Booth-1713  
and NMA.  
Area D-10.

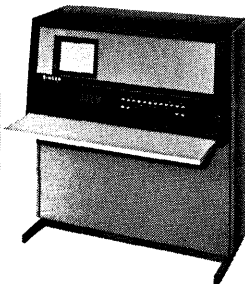
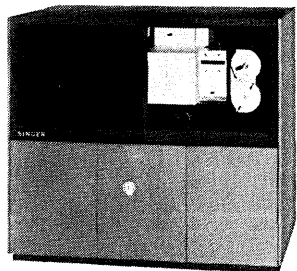

**Computer  
Output Microfilm  
Systems by  
SINGER**

# Remember when verification could mean punching a second card, then a third card, and maybe a fourth?

## Cybercom has changed all that.

For eighty-one years, the punched card has been man's solution to the problem of getting man-generated data into the computer.

The bulky punched card. The slow punched card. The ridiculous punched card.

Cybercom has the *now* solution. Key to cassette. Verify electronically. Convert to mag tape. Hand the tape to your computer.

Stop and think about it. It makes sense. And it saves money.

Cybercom, 432 Toyama Drive, Sunnyvale, California 94086 (408) 734-3230



CIRCLE 34 ON READER CARD

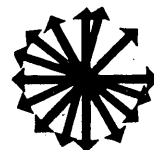

# HARDWARE

## Computer System

From the people who brought you the Data Recorder series (six years ago) comes the system 2400, which they expect to extend their—and users'—data entry, conversion, and communications capabilities for maybe the next five years.

System 2400 is designated the peripheral processor. Minicomputer based—an Atron cpu—it combines tape drives, disc units, printers, 80 column card equipment, paper tape readers, and a communications controller into variously configured programmable subsystems. The mini has a memory range of 4-32K and can accommodate up to four i/o channels. Each channel has a 250 kc transfer rate and can handle up to 16 peripheral devices. User programming is accomplished with Mohawk data language—a data-oriented language with PL/I characteristics. Assembly language utilities and subroutines complete the system software.

Peripherals for the i/o subsystem include a new series of 45 ips tape

drives, inaugurating this manufacturer's entry into this product area. The model 2431 reads and writes on 7-track tape in 200, 556, or 800 bpi densities. Model 2433 handles 9-track 800 bpi tape, while the 2434 is a read-only unit for all densities of 7-track tape, and 800 bpi 9-track data. These three units are NRZI recording

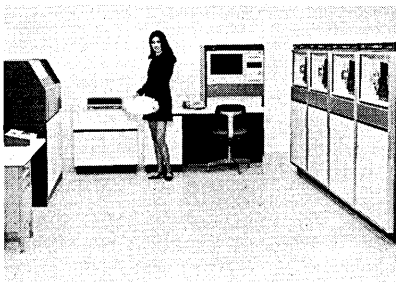

mode units, while the 2435 reads and writes 1600 bpi tape in the phase encoding method.

Disc storage is the model 2471 drive with controller. The controller can handle up to four drives, with each two-surface disc containing up to 2.47 megabytes of data. The data transfer rate is 200 kc. Printers for

system 2400 are two chain models, and a drum unit. Models 2443 and 2444 have top speeds of 450 lpm with either 100 or 132 print positions, respectively. A punch card reader, as well as paper tape equipment complete the peripheral list.

System 2400 communication capability is based on the model 2401 communications controller. The package permits the system to be a 2780 to IBM 360 computers. Transmission rates range from 600-9600 baud over half- or full-duplex. A last item that can be included in the system 2400 is the data recorder. Up to four can be connected for data input, pooling, and editing. Typical configurations of the system 2400 are: The data communicator, a cpu with communications controller, plus the 2443 printer, 2458 card reader-punch, for \$1270/month on a one-year lease including maintenance. First shipment of system 2400 will be made in August. MOHAWK DATA SCIENCES CORP., Herkimer, New York. For information:

CIRCLE 325 ON READER CARD

## COM Units

Once the under \$50K limit for COM units was broken recently, several firms have approached \$40K. This manufacturer, with the announcement of s/COM-70R, is approaching \$30K. Several models in varying configurations are available, starting with the s/COM-70R, using a 16mm camera and priced at \$32,850 for on-line versions, and \$35,850 for doing off-line processing from a 9-track, 800 bpi IBM compatible tape drive. Next up the scale is the s/COM-70F which adds 105mm fiche capability. (There are predictions that 80% of

the COM devices sold in the future will have this feature.) All the units are hardware and software compatible with 360 model 25s and up, with no changes necessary to the printer routines. The off-line model is priced at \$42,850, and the on-line model is priced at \$39,850.

All the units are said to operate at 15,000 132-character lpm with a basic 64-character EBCDIC set standard, and another 64 characters available as an option. Forms overlay is standard. The units incorporate a light emitting diode array instead of crt or fiber optic technology, and the LED's are said to have a life expect-

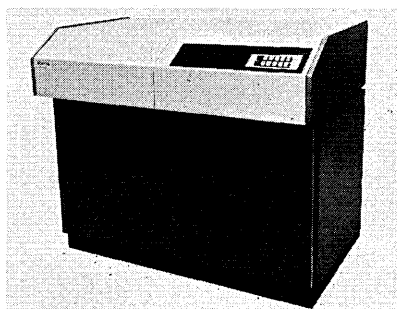

tancy ranging up to one million hours. SEQUENTIAL INFORMATION SYSTEMS, INC., Elmsford, New York. For information:

CIRCLE 326 ON READER CARD

## Two-in-One A/B Modem

A modem incorporating the features of both the Bell 201A and 201B data sets enables users to operate over either the switched network or C2 conditioned lines. The modulation scheme is Bell-compatible, selectable by means of a mechanical jumper. Data rates are 2000 bps and 2400 bps, respectively. Price of the unit, called the TR-201A/B, is \$1495. Delivery requires 30 days ARO. TEL TECH CORP., Rockville, Md. For information:

CIRCLE 327 ON READER CARD

## Commo Line Adapter

Owners of this manufacturer's COMP-16 and COMP-18 minicomputers can attach the UNIMUX line adapter as an option, allowing communication with remote terminals, other computers, or peripherals over tty or telephone lines.

Three pieces of hardware make up the UNIMUX. The modem buffer interfaces to any EIA RS-232C modem for half-duplex transmission, or two could be configured for full-duplex mode. The second piece of gear is the tty line buffer. Third, the multiplex

controller provides communication between each buffer and the COMP 16/18 on a direct memory access channel. It can control up to eight half-duplex or four full-duplex lines, or mixed combinations, and can be expanded up to 64 9600-baud lines. Operation of the line adapter is under program control. The price is \$1850. UNICOMP INC., Northridge, Calif. For information:

CIRCLE 328 ON READER CARD

(Continued on page 75)





**N/C Data Input**

The DATAPREP 100 is used for formatting graphic information into digital data suitable for input to artwork generators, display systems, computers, or numerical control machine tools. The operator contacts the desired point on the "menu" adjacent to the table working area and then contacts the desired position on the table. The system automatically outputs the data to the device selected. Initially the device will be directed

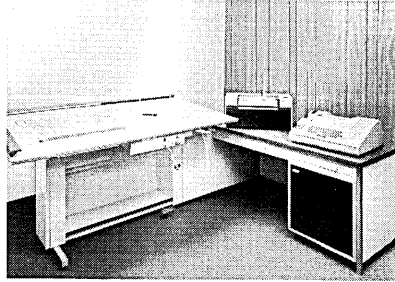

toward automated photo plotting, drafting, and pattern generation equipment.

The 100 can also be interfaced with computers or peripherals, or can be ordered with an optional mini-computer inside for more complex applications. Also featured on the model 100 are automatic step and repeat, and line and character delete. Prices start at \$17K for the turnkey systems, but might range up to \$50K depending on additional equipment desired. DS AMERICA, INC., Santa Ana, Calif. For information:

CIRCLE 329 ON READER CARD

**Model 65/67 memory**

The latest IBM product to come under fire by other manufacturers is the 2365 core storage unit on 360 model 65s and 67s. Offered as a replacement for it is the model 70—but the real surprise is that the replacement unit is MOS/LSI semiconductor memory effectively allowing installations to almost upgrade their 65s (and simplex 67s) into 370s since the technology is very similar to the memory used on the 370/145. The basic module is 256K bytes cycling at

750 nsec, but can be expanded up to a megabyte. Access time is 425 nsec.

Also, the model 70 fits into the space required by four of the 2365 boxes, which might be put to good use by an installation. A rental contract for 256K for one year is \$7500/month, including maintenance, or the model 70 can be purchased for \$297K. Both the purchase and rental prices appear to be substantially under IBM's rate for the 2365. COGAR CORP., Wappingers Falls, New York. For information:

CIRCLE 330 ON READER CARD

**Modem**

The vds-202 modem is a replacement for Bell 202 units, providing the same asynchronous data transfer rates up to 1800 baud. Interface specifications are rs-232 B/C for the vds-202 which is available off the shelf in up to 30 days ARO depending on quantity. The end-user version is priced at \$445, or the modem is offered to OEMs minus the packaging and power supply for \$250. UNIVERSAL DATA SYSTEMS, INC., Huntsville, Ala. For information:

CIRCLE 331 ON READER CARD

**Small Business System**

They're time-sharing systems, including Nova or PDP-11 minicomputers and terminals, but the Commander 500 and 1000 are really a case of bundled hardware: the vendor is marketing software, including its own interactive language with English phrases which step the operator through transactions, and selling the hardware incidentally. The market being pursued includes hotels and

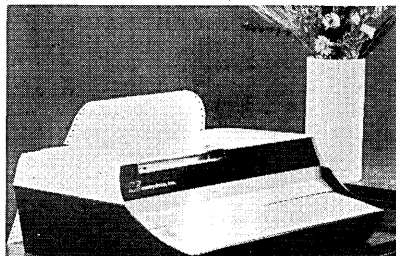

motels, nursing homes, health and legal services, retailers, and light industries.

Software will be customized for individual users, with programs handling such jobs as accounts receivable and payable, payroll, and reservations. The terminals include standard alphanumeric keyboards and an 80-column, 12 cps printer. Prices vary from \$25-35K, depending on number of terminals. Deliveries are scheduled to begin in the next quarter. MOBY-DATA, INC., New Hartford, N.Y. For information:

CIRCLE 332 ON READER CARD

**Baud Correction**

Data signals distorted as much as 45% can be corrected using the 11 start-stop regenerative repeater, it is claimed. The baud rates accommodated number four, and range between 30 and 150 baud, and optionally up to 2,400 baud. The SSR-11 delays signals 50% of one bit, and retransmits the signal over rs-232B/C compatible interfaces into a modem. Priced something under \$300, the units are available 30 days ARO. SUSQUEHANNA CORP., ATLANTIC RESEARCH DIV. Alexandria, Va. For information:

CIRCLE 333 ON READER CARD

**Remote Terminal**

A 4K Nova 1200 minicomputer is at the heart of the UT-1 batch terminal which, in its basic configuration is comprised of an ASR 33 tty, a 400 cpm reader, a 245-1110 lpm printer, a modem adapter, all standard software available for that particular computer, plus the UTEX executive for operating on-line to a time-sharing computer. This configuration is priced at something under \$35K, with emulation packages for IBM 2780, Univac 1004, and CDC 200 terminals. UNITECH, INC., Austin, Texas. For information:

CIRCLE 334 ON READER CARD

**Paper Tape Conversion**

Coded information from 5-, 6-, 7-, or 8-channel paper tape can be converted into 200, 556, or 800 bpi 7-track IBM-compatible tape, or even 9-track 800 bpi format using the Verta-Tape. The "programming" for each customer's application is accomplished through a plug-in patch-board. The paper tape is read at 500 cps. The 7-track Verta-Tape is priced at \$8K, while the 9-track unit goes for \$9K. First deliveries are expected this month. DATASCAN, INC., Clifton, New Jersey. For information:

CIRCLE 335 ON READER CARD

(Continued on page 79)

**What  
every 360\* user  
should know  
about the  
Cogar 70.**

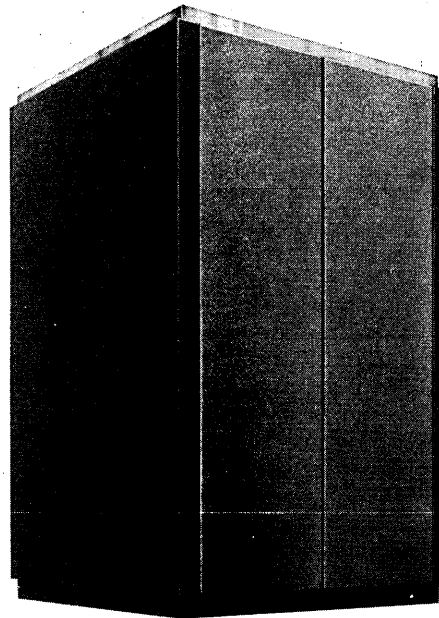

# It saves you money.

The money you'd spend in moving to a more powerful system. The Cogar 70 all-monolithic add-on memory is designed to plug into your present 360 system. Increasing system capacity. Improving performance. With no changes to your software. That means your 360 may be all you'll need for another two, three or even five years. Quite a saving.

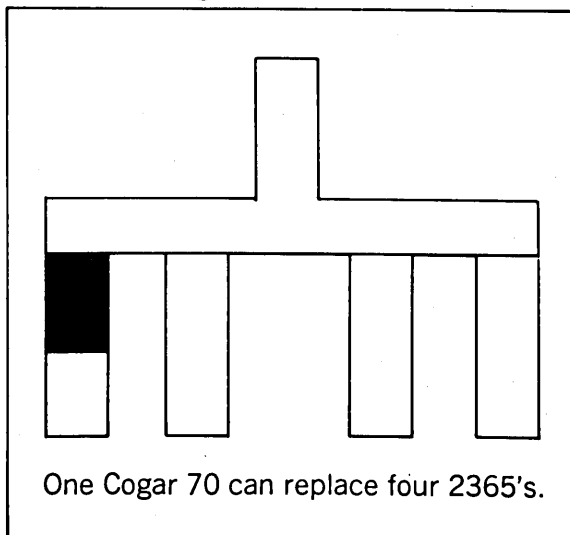

And Cogar 70 keeps on saving you money as your memory requirements grow. You can add on to a Cogar 70. Plug in additional 262K-byte increments. All the way up to a full megabyte in the

same cabinet. With further cost savings at each increment.

You'll also save money on maintenance. Because Cogar 70 is all monolithic it's much more reliable. It eliminates tens of thousands of solder connections. Potential sources of failure. It uses only one-third the power of a 2365. And finally, it has its own built-in fault-isolation system permitting "off line" troubleshooting to rapidly isolate memory failures.

How much does it all add up to? That depends on your present equipment and your future needs. Why not check with your Cogar representative.

He'll put it all in dollars and cents.

Cogar Corp., Technology Div., All Angels Road  
Wappingers Falls, N.Y. 12590 (914) 297-4323  
Please send me additional information on the Cogar  
70 add-on memory.

Name \_\_\_\_\_

Title \_\_\_\_\_

Company \_\_\_\_\_

Address \_\_\_\_\_

\_\_\_\_\_ Zip \_\_\_\_\_

Phone \_\_\_\_\_

I have an immediate application

I have a possible future application

Have salesman call

My CPU is \_\_\_\_\_ Model \_\_\_\_\_ Core size \_\_\_\_\_

\*360 is an IBM designation for its computer systems.

Media is the tape with the lifetime guarantee\*.

It's also the tape that reaches you within 48 hours after you place an order.

Our reasoning went like this. It doesn't matter how good a tape is if you can't get it when you need it. *After* you get it, the quality begins to matter. And the longer you have it, and the less trouble you have *with* it, the more likely that your future orders will be for Media tape.

That way we all win.

By the way, Media is a division of General Kinetics Incorporated, the

tape rehabilitation specialists. For 12 years we've been making used tape better than new. So you can imagine how good our new tape is.

MEDIA 3200 FCI computer tape.

For complete details on our lifetime guarantee, write or call today:

Media, a division of General Kinetics Incorporated

11425 Isaac Newton Square

Reston, Virginia 22070

(703) 471-7522

\* With proper care and regular maintenance, Media tape is guaranteed to outlive your present computer installation.

**computer  
tape from**



A DIVISION OF GENERAL KINETICS INC.

**GKI**

**the first computer tape with a  
Lifetime Guarantee  
& 48-hour delivery service!**



**first**

## ... HARDWARE

### Display System

Up to 32 of this manufacturer's series 2000 crt display terminals (Aug. '69 p. 164) can now be attached to either the multiplexor or selector channels of 360/370 computers to provide a local display system. The maximum character capacity of a single crt is 1920, but this decreases as the number of displays increases—down to 240 characters if a full 32 displays are configured. No hardware or software changes are said to be necessary for replacing IBM 2265 units. Replacing one 2065 would run \$140/month, including the controller. ATLANTIC TECHNOLOGY CORP., Somers Point, N.J. For information:

CIRCLE 336 ON READER CARD

### Cassette Transports

Any tape problems that might occur with the CM-100 asynchronous cassette drives won't be attributable to pinch rollers or capstans since Philips-compatible cassettes will be directly driven in the units. Two-track recording is done at speeds up to 10 ips, with start/stop times of less than 40 msec quoted. Included in the package is the power supply, serial/double parallel buffer with all analog circuits, EOT/BOT sensing, and parity checking. Recording density is 800 bpi. The basic CM-100 is priced at \$800, with clusters of two or three units possible (though more expensive). COMPUTER MATE, INC., San Clemente, Calif. For information:

CIRCLE 337 ON READER CARD

### Memory Expansion

Varian 620/i minicomputer users can now equip their machine with from 4-32K 16- or 18-bit core words in 4K increments. ExpandaCore 620 contains its own power supply and plugs into the computer the same way the manufacturer's core extension does. The access time of the unit is 750 nsec, and the cycle time is 1.8 usec. A 4K 16-bit system with power, cable assembly, and temperature monitor is priced at \$3750 in single units, with 16K priced at \$11,100. Delivery is 30 days ARO. CAMBRIDGE MEMORIES, INC., Newton, Mass. For information:

CIRCLE 338 ON READER CARD

(Continued on page 81)

# Florida- Where the workers are as productive as the orange groves



*Read about  
a labor picture  
that can only  
spell profits...  
performance...  
productivity  
for you.*

Here's what we can deliver when you come to Florida

- We can out-recruit anyone for skilled labor. We'll show you proof of 10-to-1 superiority in competitive recruitment.
- Our skilled work force is growing faster than in any state in the Southeast.
- We now have in Florida a larger working age population (18-65) than any other Southeastern state.

Florida is a great place to live and work. Won't you let us reveal the hidden profit potential in Florida's remarkable labor picture? Just phone (904) 224-1215 or write in confidence.

Dept. F-6

Please send information about:

- Manufacturing plant  
 Headquarters office  
 Research  
 Warehouse  
 Other \_\_\_\_\_

NAME \_\_\_\_\_

TITLE \_\_\_\_\_

COMPANY \_\_\_\_\_

ADDRESS \_\_\_\_\_

CITY \_\_\_\_\_ STATE \_\_\_\_\_ ZIP \_\_\_\_\_

# Florida

DEPARTMENT OF COMMERCE  
BUREAU OF INDUSTRIAL DEVELOPMENT  
107 WEST GAINES STREET  
TALLAHASSEE, FLORIDA 32304

CIRCLE 32 ON READER CARD



# *If it's been in 10 years... it's a Digitronics data terminal*

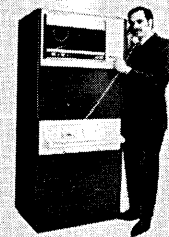

...Ask Lever Brothers Company or any of our other customers.

The first installation of terminals for high speed transmission of data over the dial telephone network including a unique error detection technique and automatic retransmission was made for Lever Brothers Company in March 1961. Since then more than 35 terminals have been added to the system, and the features are basically the same. Oh we offer some additional options—like automatic polling and higher speeds—and the cabinets and technology are more modern, but all of our customers with thousands of terminal installations want information transmitted error-free and at high speeds—they want to be able to choose terminals for any media—perforated tape, computer compatible magnetic tape, or hard copy; acoustic coupled or highest speed modems—and they want equipment which will be up-to-date in the years ahead.

Interested in data acquisition and communications equipment with features that last?  
Contact: Digitronics Corporation, One Albertson Avenue, Albertson, New York 11507  
(516) 484-1000.

 **DIGITRONICS** CORPORATION



*D505 Paper Tape Terminal, installed March, 1961*

**Time-share Terminal**

Ingredients for the Auto-Pro 1000 t-s terminal are an ASR 33 tty, an input data coupler, an acoustic coupler, and a digital plotter. This configuration allows either digital or analog information to be entered directly into the computer without the necessity of first punching the information onto paper tape. Once the input has been run into the user's program, re-



sults can be plotted.

The Auto-Pro 1000 is priced at \$7950. The manufacturer also has some programs available for problems involving analytical instruments such as spectrophotometers, gas chromatographs, liquid scintillation detectors, amino acid analyzers, and electrophoresis systems. BECKMAN INSTRUMENTS, INC., Fullerton, Calif. For information:

CIRCLE 339 ON READER CARD

**Card Equipment**

Users of this manufacturer's Comp-16 and Comp-18 minicomputers now have available to them a 300 cpm reader called the Mod 250, and a 120 cpm card punch labeled the Mod 260. Both units handle 80-column cards, and oem's can obtain the two peripherals for incorporation with other minis. The reader uses a vacuum pick finger method. Availability on both peripherals is immediate, with the reader priced at \$3200, and the punch at \$11,600. Necessary support for adapting the

peripherals to the proprietary computers is included in these prices. UNICOMP, INC., Northridge, Calif. For information:

CIRCLE 340 ON READER CARD

**Automatic Control**

A computer control system designed for process control and plant monitoring includes a cpu, applications software, an operator console with crt, plus i/o equipment and a full complement of peripherals. Called Fox 1, the system features a cpu of

the firm's own manufacture; 24 bits plus parity words; core cycle of 960 nsec; core memory of 16, 24, or 32K; and drum memory of 256 or 512K. The console provides both alphanumeric and graphic display. Peripherals include a tty, paper tape reader and punch, card reader and punch, and line printers. Prices begin at \$150K. Deliveries are slated to begin not later than next January. THE FOXBORO CO., Foxboro, Mass. For information:

CIRCLE 341 ON READER CARD

**MTUs**

It hasn't been very long since the larger computer users were busy converting over to 1,600 bpi tape drives, and now they are available to the less sophisticated installations as well. The 800 series drives offer small-scale users combinations of 200/556 or 556/800 on the 8107 7-track unit, and 800 bpi NRZI/1,600 bpi phase-encoded formats on the 8109 9-track version. The two drives are basically 25 ips units, but can also be obtained with speed capabilities ranging from 10 to 37.5 ips. Automatic density recognition and switching, preamble/postamble generation, error detection/correction, and deskewing are also features of the 8000 series.

An 800/1,600 bpi subsystem consisting of a model 8109 mtu and 8216 controller, would be priced at \$6K, and the 7-track 8107 with its associated control unit is priced at \$4625. Some units have been shipped but availability is currently 30-45 days ARO. KENNEDY CO., Altadena, Calif. For information:

CIRCLE 342 ON READER CARD



**This unit makes the output typewriter** in the Facit 3851 — the conventional typewriter with input/output. It is also available in two other versions — output only and input only. All three provide full utilization of the 7-bits code.

There is further interesting information on the new Facit 3851 in this publication.

**Facit 3851 - the conventional typewriter with input/output**



For further information, contact in US: Facit-Odhner Inc., 501 Winsor Drive, SECAUCUS, New Jersey outside US: Facit AB, Albygatan 102, 171 84 Solna, Sweden

CIRCLE 70 ON READER CARD



What happened to the model 19?

You're looking at some of the Teletype® basics used in building a data communications system. Printer, keyboard, tape sending and receiving combinations in a variety of speed capabilities. Teletype's modular design concept gives you the opportunity to extract the best terminal combination for system

needs today, and refine, add to, subtract and adapt as system modifications are called for. Just as important as the basics, are some of the things not obvious in the photos below. The logic devices, options and accessories that add almost limitless possibilities for making things happen exactly as

your system requires. We have some solid state logic devices that provide precise control of data traffic. That enable your computer to automatically poll data from a number of terminals and feed each terminal with processed data. There are error detection, correction and signal regeneration options to

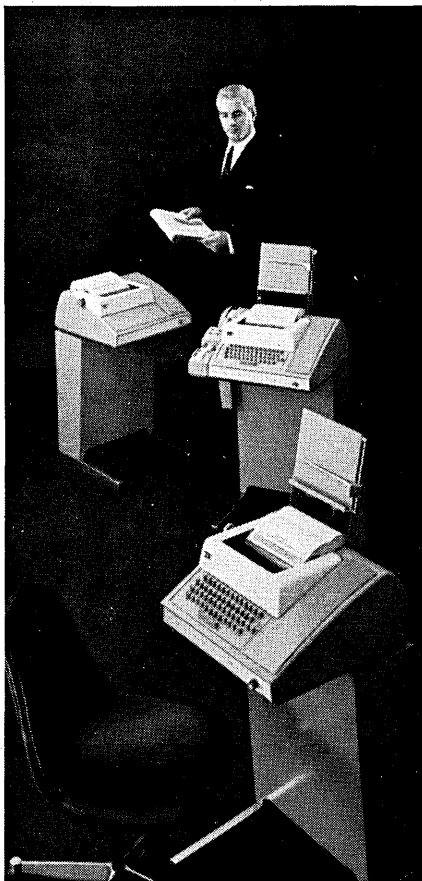

**model 33 series:** An extremely economical 100 wpm terminal line. Has 4-row keyboard, uses 8-level ASCII code. The most widely used terminal in time-sharing systems today.



**model 35 series:** A rugged, heavy-duty line of 100 wpm terminals. Uses ASCII. Units in foreground are self-contained paper tape punch and paper tape reader.

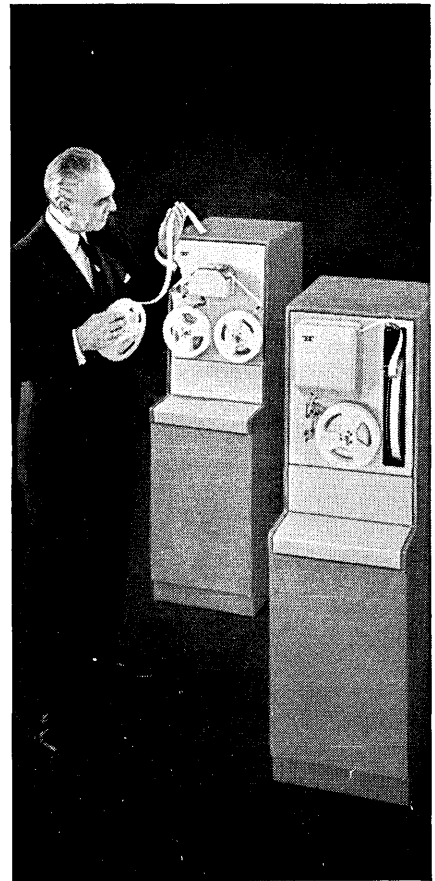

**Telespeed™ equipment:** A line of high-speed tape-to-tape terminals capable of sending and receiving at speeds of 750, 1050 (shown above), or 1200 words per minute.

# DATA COMMUNICATIONS

equipment for on-line, real-time processing

keep data flowing faultlessly. Options such as pin-feed platens and form feed controls that make it possible to fill multiple copy business forms on-line. And many, many more. What did happen to the model 19? Believe it or not, there are still some of these old, die-hard terminals around. And that's

another advantage your data communications dollar buys when you specify Teletype equipment. It lasts. Moves data reliably, economically, for a long time. On a price/performance basis, Teletype equipment is in a class by itself.

Teletype data communications equipment is available in send-receive capabilities of up to 2400 words per minute. If you would like specific information about any of the equipment described here, write: Teletype Corporation, Dept. 81-17, 5555 Touhy Ave., Skokie, Ill. 60076.

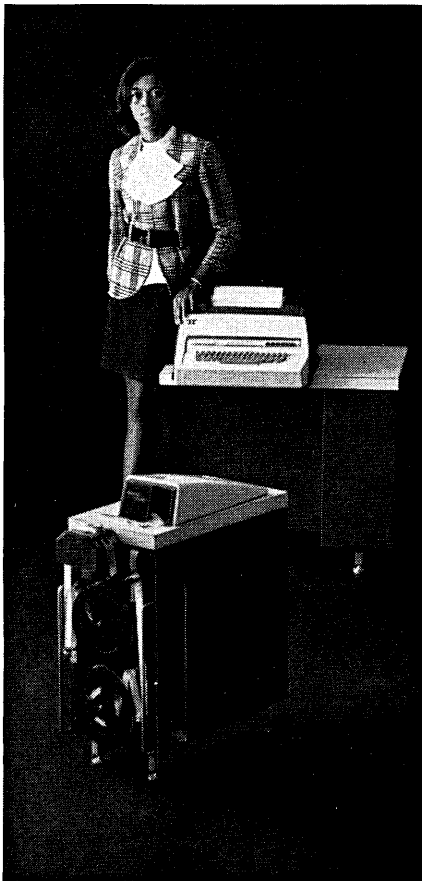

*model 37 series: One of the most versatile heavy-duty terminal lines going. Generates all 128 characters of ASCII. Operates at 150 wpm. Prints in upper and lower case.*

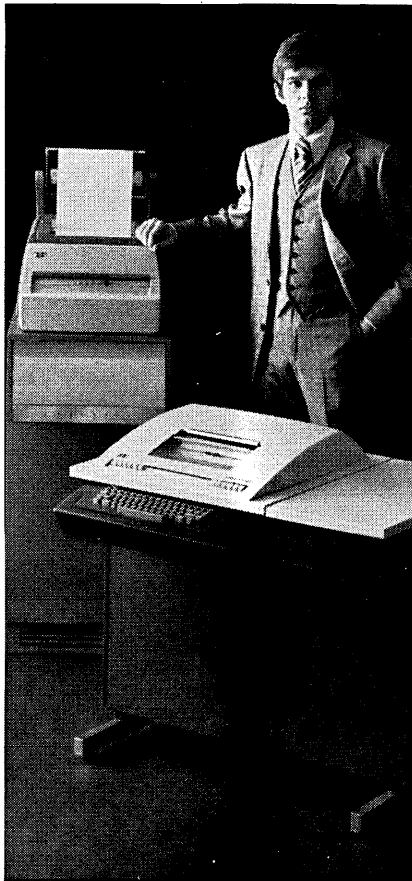

*Inktronic® data terminals: A unique electronic, solid state terminal. Prints up to 1200 wpm. Forms characters through electrostatic deflection (no typebox). ASCII compatible.*

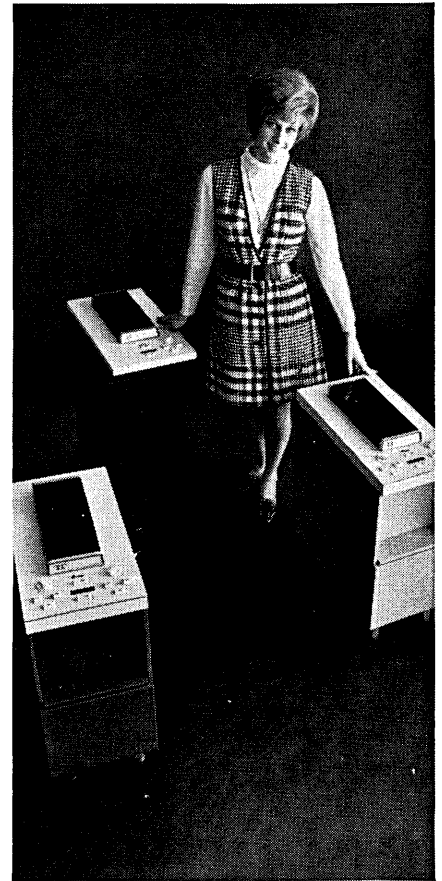

*magnetic tape data terminals: Use compact reusable tape cartridges. Operate on-line at up to 2400 wpm, and connect "locally" to lower speed Teletype terminals using ASCII code.*

Teletype is a trademark registered in the U.S. Pat. Office

**machines that make data move**



This Japanese character demonstrates how you can personalize your printout with the unique Bright Industries' BI 1215 Bar Printer. You may choose literally any type face in any language, and in any size to one-quarter inch. Fonts can be changed in the field in minutes.

This character is the Japanese ideograph for the word "bee." It is composed of two distinct characters (and printing strokes), one symbolizing the general concept of insect, the other the specific concept of bee. Only the BI 1215 lets you go back and increase your vocabulary so elegantly; with a Roman font it enables you to go back and underline or add phonetic symbols.

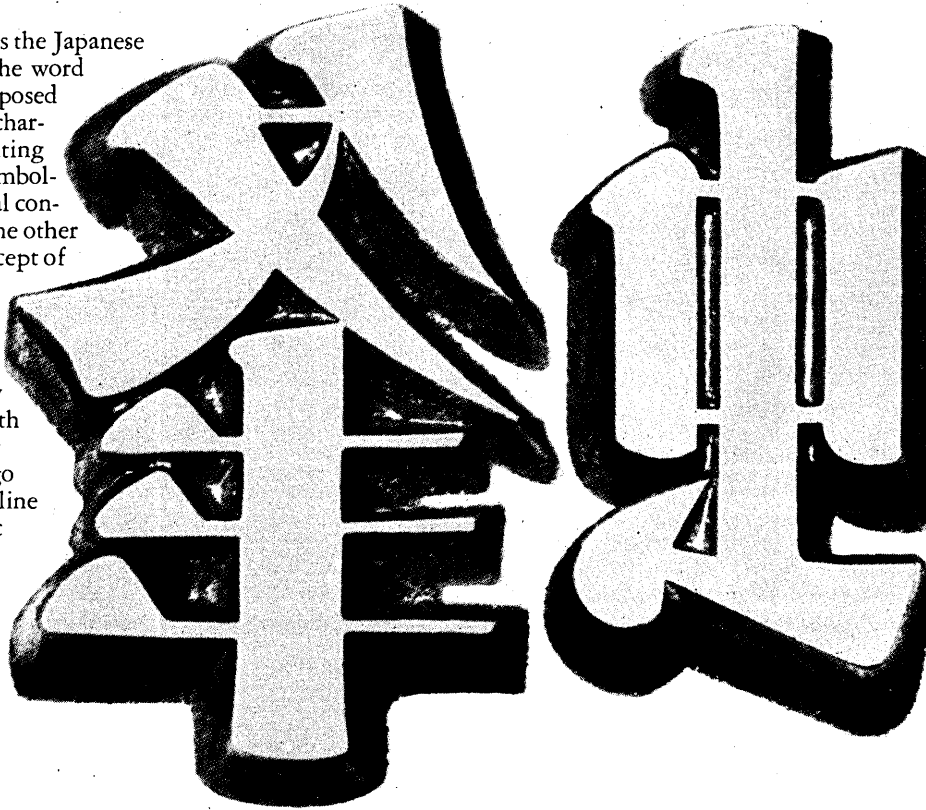

This character aligns so precisely both vertically and horizontally that you can emphasize by overprinting a line and still achieve a printout so faultless you'd be proud to sign your name to it. The BI 1215 will maintain this quality of printout at rates to 300 lines per minute, 132 characters per line.

This character will print to perfection less expensively and more reliably because the Bright Industries' BI 1215 is built simply, tested rigorously, and serviced painstakingly from delivery day through the life of the product.

This character was brought to you by the Bright Industries' BI 1215 Bar Printer. There's nothing else like it in the world.

Bright Industries, Inc.  
One Maritime Plaza, San Francisco • 94111  
Telephone: (415) 391-9794

Bright Industries is an affiliate of Tracor, Inc.

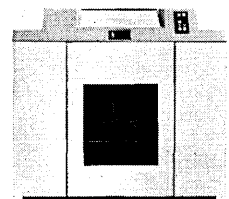



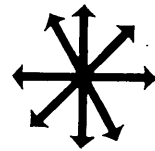

## 21 Applications Programs

This company may have become No. 1 in number of new software announcements with its latest burst: 21 complete applications programming packages for its new small- and medium-scale computers in the 115 line, the existing series 400 models and Model 58.

Ten financial management programs for general-purpose use with the small-scale Model 58 card and disc systems handle accounts receivable and payable, general ledger, payroll, and inventory reporting.

Three manufacturing programs are offered for the 115 line. These include ADAPT for numerical control applications and an inventory management forecaster/controller system, both of which have been developed for use with disc systems. The third package is for determining distribution by value (ABC analysis).

The forecaster/controller runs on the 115, 1015, and 2015 mainframes, while the ADAPT package is designed especially for small manufacturers using Model 115 systems. The ADAPT system requires 32K main memory.

Four systems are being provided for banking. One is a small-scale communications application called Dedicated TRUMP, for use on the Model 115 to handle transaction processing on teller terminals, crt's, teleprinters, etc. Three other packages are available with medium-scale systems: A disc-oriented transit system for use on Series 400 computers provides control over proof of deposit, sorting, and transmittal of checks through the computer system to the original bank of deposit. The other two programs are for mortgage banking and mortgage loan functions. Both are designed for Models 1015 and 2015 mainframes.

Three packages for distributors al-

low the user to schedule vehicle usage; to handle balance-forward accounts receivable; and to conduct a programmed review of ordering, forecasting, and inventory situations in a distribution warehouse. (The latter package is an extension of PROFIT II, announced last year, and runs on 115, 1015, and 2015 systems.)

One other applications group for medium-scale systems is tailored for printing, publishing, and broadcasting use to fulfill subscription functions. It runs on 1015 and 2015 systems. Unlike Honeywell's new computer systems, most of this software is still being field tested and will not be available until the latter part of the year. HONEYWELL INFORMATION SYSTEMS, Wellesley Hills, Mass. For information:

CIRCLE 308 ON READER CARD

## AED for Minicomputers

Here is a chance for users of IBM 1130s and System/7, the Honeywell Series 16, the Raytheon 700 series, Digital Equipment Corp. PDP-10s, and Philips 9200 computers to cash in on the tax money we all pay. The AED system originally developed at MIT with U.S. Air Force and industry support is no longer restricted only to

large systems, providing the users of these computers with an extensive library of software components for device-independent I/O, data structuring, memory management, and free-format input and output. FORTRAN compatible, AED has been used to build compilers, operating systems, and other programs.

A user writes an AED program and specifies the target minicomputer

environment. This program is then run on a 360, the AED program system requiring approximately 150K bytes. The resulting program is then recompiled to obtain the final minicomputer version. Installation requires approximately \$8K for the system, and a monthly rental of \$500. SOFTECH, INC., Waltham, Mass. For information:

CIRCLE 302 ON READER CARD

## Insurance

System 1099 is a series of COBOL programs to help insurance companies that provide accident and health coverage meet the requirements of the Internal Revenue Service ruling 69-595. Basically it enables the company to collect information regarding claims payments to health care providers on a continuing basis through-

out the year. System 1099 uses the provider's Tax Identification Number, if available, but allows for operation without it. Provider name and address information is also maintained.

At the end of the year, the system prepares IRS forms 1099 on paper or magnetic tape, as required by the 69-595 ruling. System 1099 requires about 32K bytes on a 360/30, and

can also run on some Honeywell equipment. The \$1800 price includes documentation for the mail-out package. AMERICAN INFORMATION DEVELOPMENT, San Francisco, Calif. For information:

CIRCLE 309 ON READER CARD

## 360 APT

IBM's NC/360 APT processor has been around for about five years, and this firm apparently felt it was time for modifications to be made, with APT/70 the result. Actually, since 85% of the coding is in FORTRAN with the remainder in computer-dependent assembly language code, APT/70 can be optimized to a particular installation's computer, and is said to result in an APT processor that is 30% smaller and 20-50% faster

than NC/360. Included in the 360 release are inclusive subscripts, segmented READ, CLMERGE, conditional execution, translate only, and a variable attribute and cross reference list to aid part programming debugging. APT/70 is a full five-axis system requiring about 185K bytes on the small version; a 230K byte large version is also offered. The program runs on model 40 and up 360s running MFT, MVT, HASP, etc.

The pricing is a little complex, but is probably in the user's favor. In-

cluded with the APT/70 system is a usage measurement component called SOFTOMETER. The purpose is to measure the actual usage of APT/70 and bill the user accordingly. In no case, however, will the monthly charge be less than \$1K. Reference manuals, an operations guide, and a rewritten dictionary are provided with the package. SYMBOLIC CONTROL INC., San Mateo, Calif. For information:

CIRCLE 306 ON READER CARD

(Continued on page 87)



# Inexpensive CRT display wishes desk-top position.

## Willing to relocate.



It's the new Bendix Logiport/1, the first truly portable, remote-access CRT terminal.

Thanks to its incredible compactness and integral acoustic coupler, it goes easily from one spot of your operation to another. From desk top to desk top. From lab to sales meeting. From city to city.

Communicates easily, too. Large, easy-to-read, 32-character-line, alphanumeric display sees to that.

Putting Logiport/1 into action is as easy as placing a standard telephone handset on the coupler, then dialing

over ordinary telephone lines. Instantaneously, you're in real-time touch with a time-sharing computer anywhere.

Logiport/1 is good-looking, too. (We figured any CRT display that's going places should look good getting there.)

Cost? Under \$3,000. Never before has a CRT terminal done so much, so well, for so little.

Willing to relocate. Easy to read. Inexpensive. Good-looking. Immediately available. That's Logiport/1. It could turn out to be one of the best traveling salesmen your organization has.

Interactive Terminals Corporation  
197 Albany Street  
Cambridge, Massachusetts 02139  
A subsidiary of The Bendix Corporation  
Gentlemen: Please send my free  
brochure on the Logiport/1.

Name \_\_\_\_\_

Firm \_\_\_\_\_

Address \_\_\_\_\_

City \_\_\_\_\_

State \_\_\_\_\_ Zip \_\_\_\_\_

Check if interested in a no-obligation Logiport/1 demonstration.

**Bendix**

**Burroughs/CDC Link**

Large scientific programs that might tax the capabilities of B2500 or B3500 computers can now be processed on CDC 6000 series equipment using the 2500/3500 computers as remote terminals. Called 200 EMULATOR, the five program package is written in COBOL and assembly language and requires approximately 10K to emulate a CDC 200 remote job entry terminal. Programs are then run through the 2500 or 3500 for processing on the CDC gear, and results are transmitted back for listing. The data communications environment runs under the control of the CDC EXPORT/IMPORT system. Included in

the package are an operator's manual, program manual, reference manuals, and source and object programs copied to a customer supplied tape. The price is \$1200. AMERICAN MICRO-SYSTEMS INC., Santa Clara, Calif. For information:

CIRCLE 304 ON READER CARD

**Matching/Scoring**

PROFILE is a matching, scoring, and retrieval system that compares all records in one file with all records in another file and calculates a score for those pairs that meet user-specified criteria. The score reflects the degree

of similarity between a pair of records. Thus, the package can match people and jobs, buyers and sellers, students and colleges, etc. It can also rank optimal matches, and its retrieval methods facilitate the creation of teams or project groups. A built-in report generator simplifies output. It is written in BAL and runs under System/360 os with minimum 64K. A 14-year lease is \$17,500. Shorter leases are being considered by the vendor. CAMBRIDGE COMPUTER ASSOCIATES, INC., Cambridge, Mass. For information:

CIRCLE 310 ON READER CARD

**360 DOS Spooling**

The first nice feature of DOS ASAP (Automatic Spooling with Asynchronous Processing) is that it obviates the need for IBM's POWER routines that do the same job. A second feature is that DOS ASAP requires only about 2K, versus some 20K for POWER, plus perhaps 1K more of buffer space.

Additionally, DOS ASAP has been integrated into the supervisor in an attempt to cut down on redundant coding. No partition or multiprogramming support is required for dos ASAP to alleviate the cpu's dependence on the relatively slow unit record devices serviced—the printer, reader, and punch.

DOS ASAP is written in assembly

language and is priced at \$3500, plus a nominal installation charge depending on an installation's location. All future improvements in the program will be supplied free of charge. UNIVERSAL SOFTWARE, INC., Danbury, Conn. For information:

CIRCLE 303 ON READER CARD

(Continued on page 90)

*Save time...money...trouble...*

**Lease your Teletype equipment from RCA...**

**Model 33ASR** (with tape perforator and reader) **\$50 per month.**

**Model 33KSR** (send/receive) **\$37 per month.**

- Immediate delivery in any quantity.
- Includes nationwide maintenance service by RCA's own technicians.

Call or write nearest office: RCA Service Company  
A Division of RCA, Technical Products Service

Bldg. 204-2  
Camden, N. J. 08101  
Phone: (609) 963-8000  
Ext. PY-4129

3310 South 20th Street  
Philadelphia, Pa. 19145  
Phone: (215) HO 7-3300 (Pa.)  
(609) WO 3-2043 (N.J.)

1778 Marietta Blvd., N.W.  
Atlanta, Ga. 30318  
Phone: (404) 355-6110

5121 W. 161st Street  
Cleveland, Ohio 44142  
Phone: (216) 267-2725

43 Edward J. Hart Rd.  
Liberty Industrial Park  
Jersey City, N. J. 07305  
Phone: (201) 434-2318 (N.J.)  
(212) 732-9494 (N.Y.)

7620 Gross Point Road  
Skokie, Ill. 60076  
Phone: (312) 965-7550

2711 Irving Blvd.  
Dallas, Texas 75207  
Phone: (214) ME 1-8770

1501 Beach Street  
Montebello, Calif. 90640  
Phone: (213) 685-3092



CIRCLE 52 ON READER CARD

**INSTALLING  
TERMINALS**



*first install*

**TASK/MASTER**

*a comprehensive T-P monitor*



**turnkey systems inc.**

one eleven east avenue  
norwalk, connecticut 06851  
(203) 838-4581

# Tomorrow, you'll appreciate the solutions we offer today.

Communications and computer people share common dilemmas.

Sometimes it's the need for more sophisticated systems. Or added capacity. Or getting more efficiency out of existing systems. Whether these problems relate primarily to data processing or communications, Computer Control Systems offers some very special answers.

Take our TELESWITCHER® communications controllers for example. Tailored originally for small-

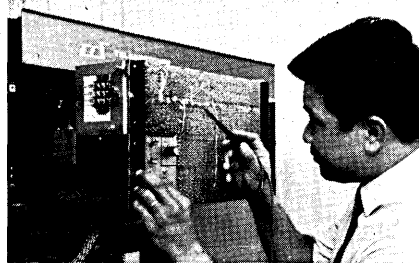

to-medium-sized networks, TELESWITCHER systems have provided a blue chip list of clients with a store-and-forward capability that is both sophisticated and economical.

For larger communications networks, there's the larger TELESWITCHER. And while it's controlling communications, it can solve some other problems, too. Like front-ending for a host data processor. (It can also stand alone.)

When you come to us for a turnkey package, you get more than hardware, software, installation and maintenance. You get the assurance that we'll be around to serve you tomorrow. Because of our financial backing — as a subsidiary of Union Service Industries. Because of our lease or purchase choices — thanks to UC Leasing, Inc., another USI subsidiary. Because of our commitment to grow — with offices now open in Atlanta, Chicago, New York, San Francisco and Dallas. Because of our track record — with successful installations for investment banking firms, transportation companies, law enforcement networks, and other growing organizations.

So, before your communications or computer requirements get too



complex, let's talk about some head-on solutions. Contact us today. We'll back you up tomorrow.

**CCS** *Teleswitcher*  
**COMPUTER CONTROL SYSTEMS INC.**

A Union Service Industries Company, 13740 Gamma Road, Dallas 75240 (214) 233-2971

# Data-Cabinets... they may just solve your printout filing problems

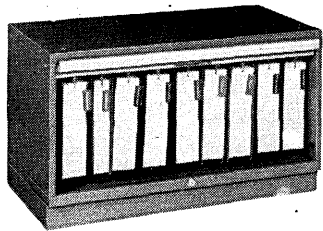

Each Wilson Jones Data-Cabinet keeps up to 10,000 bound EDP sheets in a dust-free and secure environment.

Stacked one on top of another...placed side-by-side or back-to-back...even on desks or counter tops—handsome new Wilson Jones Data-Cabinets fit anywhere, unobtrusively, compactly. Inside, an enormous amount of EDP records can be stored—over 10,000 marginal-punched sheets in 10 or more binders, 14 $\frac{7}{8}$ " x 11" or smaller.

Nylon post binders can quickly and easily be fitted with nylon T-bars and suspended from the top of each unit. Binders can be added, removed, or rearranged in any order.

Double-wall steel construction. The unique door provides a modern uncluttered look to your office. Individual lock assures record security. In all black or in harmonizing sage and tan. Matching base available.

Your data processing supplier can tell you more about our new compact Data-Cabinets. Or for further information, fill out the coupon below.



**WILSON JONES**

A Division of *Swingline*, Inc.

Wilson Jones Company, Dept. D-3  
6150 Touhy Avenue  
Chicago, Illinois 60648.

Please send me full information about your new Data-Cabinets

Name \_\_\_\_\_

Firm \_\_\_\_\_

Address \_\_\_\_\_

City \_\_\_\_\_ State \_\_\_\_\_ Zip \_\_\_\_\_

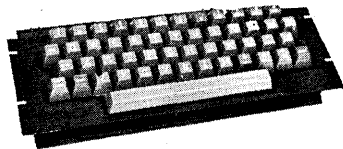
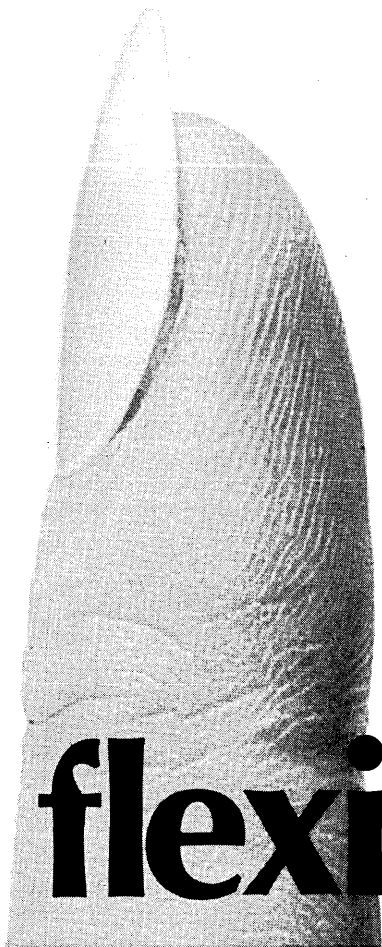

## an added dimension with Manmachine™

Coding flexibility lets you choose USASCII, Baudot, BCD, EBCDIC, 4/8, hexadecimal, any custom code. Manufacturing flexibility lets you change codes fast. Unlimited layout flexibility. Almost any number of keys.

There's more to Manmachine™—automatic current limiting, high reliability, real economy.

Send for your brochure.  
Data Electronics Corporation,  
12 Cambridge Street, Burlington,  
Mass. 01803. (617) 272-7460.

# DE

You get more than a great keyboard from Data Electronics

# flexibility

CIRCLE 60 ON READER CARD

## INFORMATION SYSTEMS

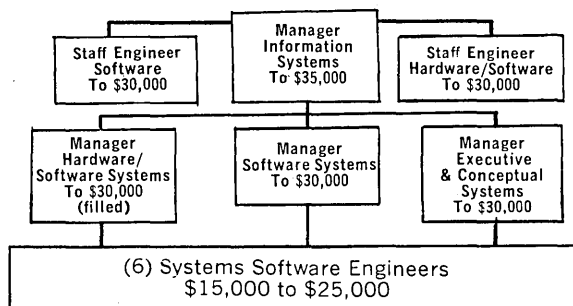

The Vice President of a billion-dollar corporation (our client) is committed to coordinating the most talented team in the country to tackle the problems of the 1970's and 1980's. He's looking for a dynamic approach to large scale command and control systems such as Weapons, Transportation, Space Systems, and many other commercial and military systems.

The top position requires an individual who has had primary responsibility for the software development of major Command and Control Systems, a proven management capability in the computer Software field, and a recognized authority in Information Systems.

The three managers and two staff positions reporting to the top position require background in:

- Software design of major C&C systems
- Working knowledge of higher level simulations and simulation languages
- Design of special purpose software interface hardware
- Design of communication networks for computers
- Working knowledge of different machine architectures and applicability to different functions.

The Systems Engineers must have designed, modified, and/or maintained operating systems, had a working knowledge of compilers and assemblers used in Major Command and Control Systems, a background in defining concepts, and the design of large scale data bases.

If your background meets the requirements listed, send your resume and a cover letter indicating in which areas you qualify and WHY. Also include your present and required salary, and geographic restrictions. This information will be held in the strictest CONFIDENCE. Mail today to: Mr. John P. Callahan—Dept. X, Suite 1515, 1405 Locust St., Phila., Pa. 19102, 215-985-1700.

"OVER 20 K"

Executive Service of The Callahan Center for Computer Professionals.

CIRCLE 503 ON READER CARD

## ... SOFTWARE

### Mini Assembler

Programs that will eventually be running on Computer Automation 216 or 816 computers can be assembled on other machines using an assembler offered by this firm. Written in FORTRAN, the assembler requires as little as 8K on an IBM 1130 for converting source programs into paper tape object program images. Features include label tables larger than assembling programs on the 816/216 duo, six-character labels, literals, out-of-range references, and a cross-reference table. The mail-out package is priced at \$1K. DECISION SCIENCE, INC., San Diego, Calif. For information:

CIRCLE 305 ON READER CARD

### More DOS Spooling

It seems as if great ideas—such as replacing some other manufacturer's product—occur to several people at about the same time. In this case, another DOS spooling replacement for IBM's POWER II is offered, with no modifications to user programs required to effect a substantial increase in throughput, it is claimed. Requiring from 4-10K of memory, DISK-SPOOL releases the cpu for other functions while the card reader, printer, or punch is operating, and can be interrupted to handle priority I/O jobs. Among the other features of the program is the ability to retrieve unprinted or unpunched output from disc files in the event of system failure. Prices start at \$5400. CONTINENTAL SYSTEMS ASSOCIATES, INC., Atlanta, Ga. For information:

CIRCLE 307 ON READER CARD

### OS/360 APL

Access to files of any size on any device at assembler language speed despite swapping of t-s users is one of the attributes claimed for APL-FIOS. Additional capabilities are formatting, shared files among many terminals, three levels of queuing, APL workspace extension I/O, and many others. The assembly language program requires approximately 4K bytes of memory on 360s using OS. A DOS version is also available. APL-FIOS leases for \$900/month. APL GENERAL INC., Trenton, New Jersey. For information:

CIRCLE 300 ON READER CARD



# FRUSTRATED?...

BY MANAGERS WHO DON'T UNDERSTAND YOU AND YOUR E.D.P. PROBLEMS...

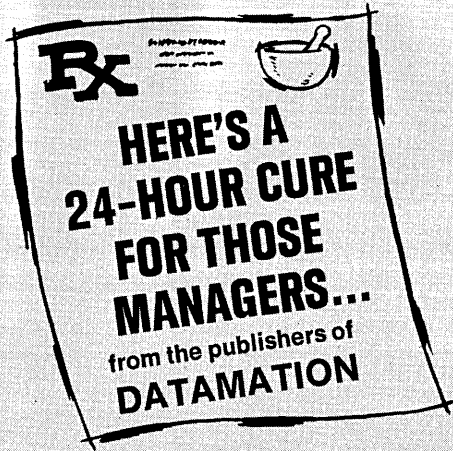

**PRESCRIPTION:**

Recommend **COMPUTER BASICS FOR MANAGEMENT**, a successfully tested home study remedy . . .

**TAKEN AS DIRECTED:** it promises to clear up the mysteries of E.D.P. in 24 hours of an executive's spare time . . . No . . . it won't make him an E.D.P. professional . . . simply a more knowledgeable, more tractable associate on computer matters.

**FOR FAST RELIEF:** get this prescription in the proper hands, today. Tear off the ad, below, attach a pass along slip and send it on its way. On second thought, it might be better to let your Personnel Director handle this for you.

(tear along dotted line)

## The future belongs to the computer oriented executive

Prepare for tomorrow now! Hundreds have learned to understand this modern business tool quickly, easily, at home, the A.T.I. way. You can, too. Enroll, without risk, in "Computer Basics for Management" today.

**6 easy lessons to full understanding**

Without any prior knowledge, by the final lesson you have cleared up the mysteries of EDP, written your own program to prove it and, most important, as a "Computer Oriented Executive," you are ready for tomorrow's opportunities.

**You won't master programming**

But, in just 24 hours of your spare time you can master the fundamentals of EDP—all aspects, from the major elements and functions of computer systems, through machine and assembly language, to basic programming principles. It's comprehensive, concise, but certainly not a crash course. You study at your own pace, thoroughly mastering one lesson before proceeding to the next.

**The most effective way to quick understanding**

Through the repetition of hearing—seeing—doing, the Tri-Media Method skillfully combines the major elements of learning to increase your perceptive and retentive ability. The many students tested on campus and TV found Tri-Media the easy way to EDP understanding. So will you!

**Developed by a task force of experts**

A.T.I. is an accredited member of the National Home Study Council, specializing in management training. It was organized by the publishers of "Datamation," the most respected magazine in the computer field. This singular association made possible the selection of outstanding EDP instructors, who perfected and tested this course at a large university.

**All course material supplied by A.T.I.**

Absolutely no extras! Your complete study package arrives, postage-paid, ready to start. This includes • a standard, fully transistorized, cassette tape player with 4 batteries, which you can use for pleasure, later • 6 cassette taped lectures • an illustrated workbook • flip charts and test books for each lesson • plus an introductory cassette with full instructions on how to proceed.

**IT'S SO EASY—THE A.T.I. TRI-MEDIA WAY**

YOU HEAR	YOU SEE	YOU DO
While you LISTEN to the lecture you LOOK at accompanying flip charts, clearly illustrating every step as you progress. When instructed, you stop to RECORD your newly acquired knowledge in your workbook. This implants it firmly in your mind. If not clear the first time, replay a lesson as often as you like, or repeat portions as you go until you fully grasp every detail. Finally, to avoid any misunderstanding, complete the Test Book for that lesson and mail it to the A.T.I. Grading Center. There, an experienced instructor will personally review your work, returning it promptly with corrections or suggestions clearly noted. It's that simple . . . but so effective.		

**GUARANTEE:** Order "Computer Basics for Management" today! Think of it as a risk-free investment in your future—with nothing to lose—everything to gain—and five full days to convince yourself it is all we promised. If not completely satisfied, just return the course material for a full refund. Your total investment: including cassette tape player, all course material and grading—\$195. And it's tax deductible in many cases. Charge it to your credit card if you wish, or arrange for company sponsorship if you can. But don't delay! There could be a computer in your path tomorrow.

**FREE Datamation Glossary:** Enroll right now and receive as a gift the popular "Datamation Glossary"—62 fact-filled pages of data processing terms. It's the last word for anyone who must communicate in modern business. And it's yours FREE, whether or not you decide to keep the course, if you act at once. So, fill in the coupon and mail it today.

 **American Technological Institute**  
A subsidiary of Technical Publishing Company  
Dept. D, 35 Mason Street, Greenwich, Conn. 06830

**SEND IN THIS NO-RISK COUPON TODAY**

American Technological Institute  
Dept. D, 35 Mason Street, Greenwich, Conn. 06830

Send me "Computer Basics for Management." If I am not completely satisfied within 5 days after receipt, I will return it for a full refund—but I may keep the "Glossary" as a gift.

\$195.00 payment enclosed—or charge my Account # \_\_\_\_\_

Diners Club  American Express  Master Charge

Name \_\_\_\_\_

Address \_\_\_\_\_

City \_\_\_\_\_ State \_\_\_\_\_ Zip \_\_\_\_\_

Signature \_\_\_\_\_



**AMERICAN  
TECHNOLOGICAL  
INSTITUTE**



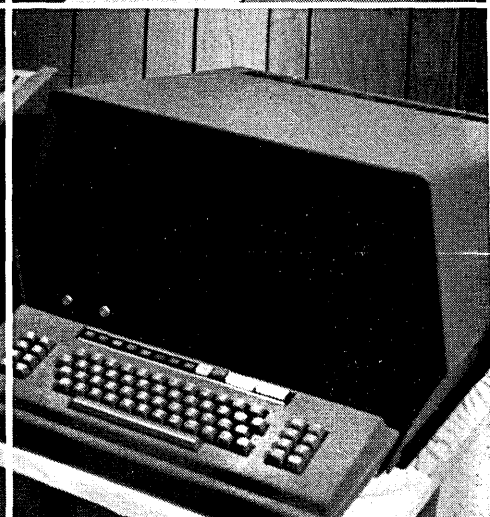
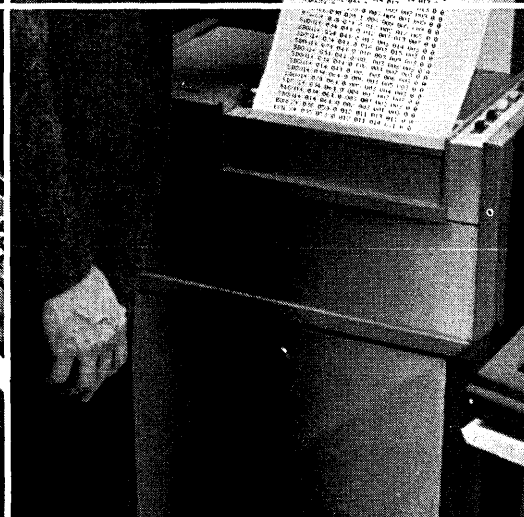
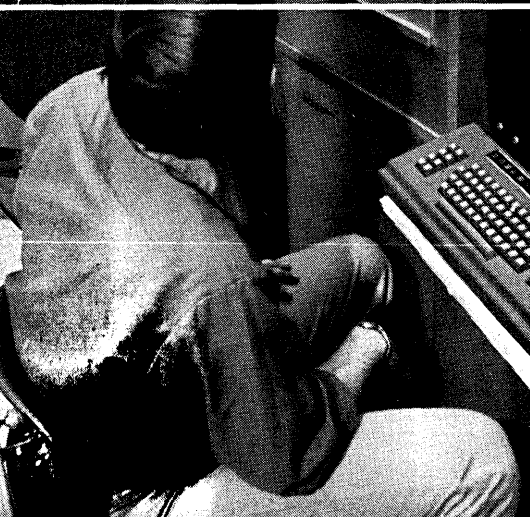
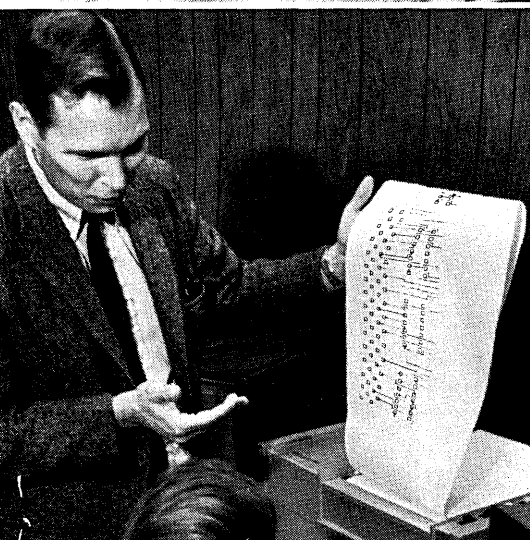
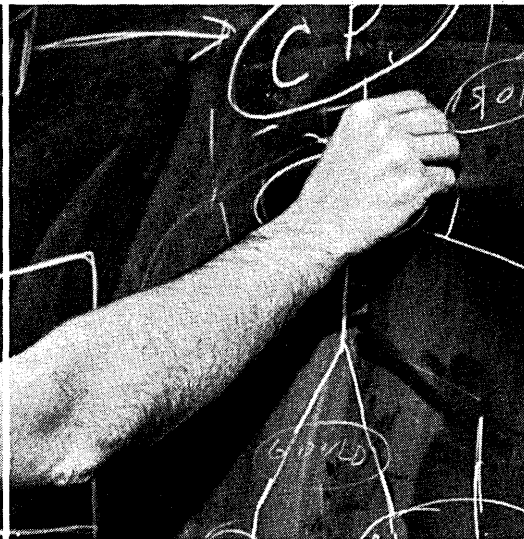
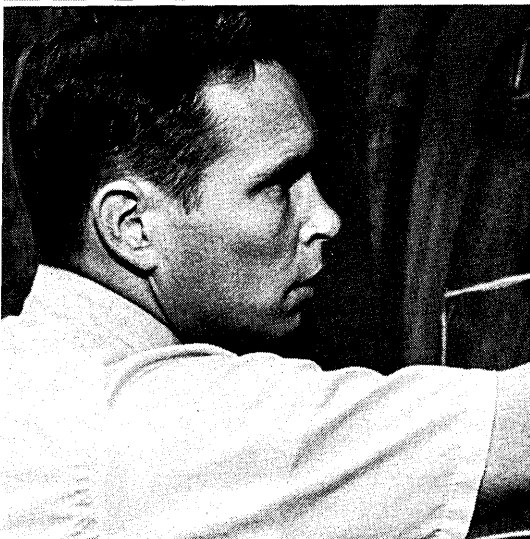
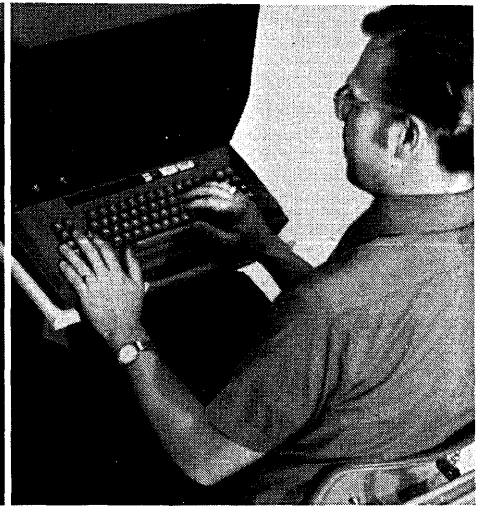
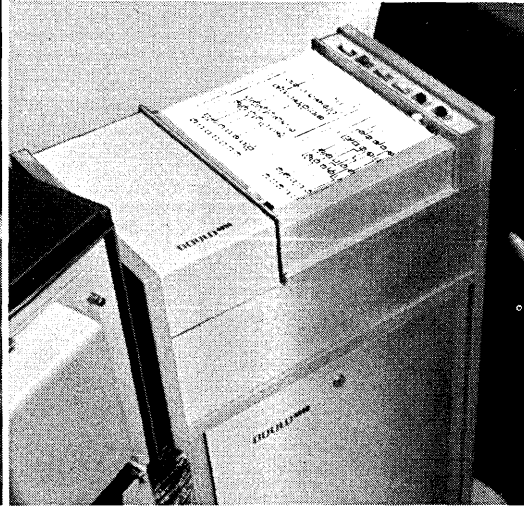

# Software systems firm slashes printout costs, compresses production schedules with Gould 4800.

Automation Technology Inc. is a specialty software systems house in Champaign, Illinois. One of their many capabilities is the design and production of the precision artwork used for making printed circuit boards. To help meet the rapidly growing demand for increasingly complex and compact circuitry, ATI uses a Gould 4800 electrostatic printer/plotter.

Art Carroll, ATI's President, provides the details:

"One of the key steps in our operation is the validation of our circuitry designs. This is done with our design automation system and requires several iterations to arrive at the optimum combination of component placement, circuit paths, interconnections and drilling patterns. Before we had the Gould 4800, we had to go to our photoplotter for these iterations. This was both costly and slow as photoplotter time runs about \$75 an hour and one iteration may take hours to produce.

"The Gould 4800 gives us both alphanumerics and graphics for pennies per page. And lets us pinpoint defective inputs and make corrections as we go.

This way, we don't have to use the photoplotter until we're ready for the production master.

"As our circuit designs grow more complex, the Gould 4800 becomes even more valuable. At the rate of 100 sq. in. per sec., it furnishes a graphic printout that superimposes the wiring patterns for several layers of a multi-layer circuit. It also provides our alphanumeric "fail" list that gives us complete details on connections not successfully completed. This permits early manual intervention.

"This sort of speed, combined with its versatility, quietness and reliability, makes the Gould 4800 ideal for our operation. Without question, it's our key piece of peripheral equipment."

All kinds of companies with all kinds of hardcopy requirements have found the Gould 4800 to be an optimum solution. This smooth, quiet electrostatic printer delivers up to 4800 lines per minute on an 8½" or 11" format. It has an optional character generator. Software and interfaces for major computers are available. And while the Gould 4800 has relatively few moving parts and little need for maintenance, there are service facilities nationwide.

**Find out what the Gould 4800 can do for you.** Give us a call. Or write: Graphics Division, Gould Inc., 3631 Perkins Avenue, Cleveland, Ohio 44114.



# Put a lock on your print-out problems

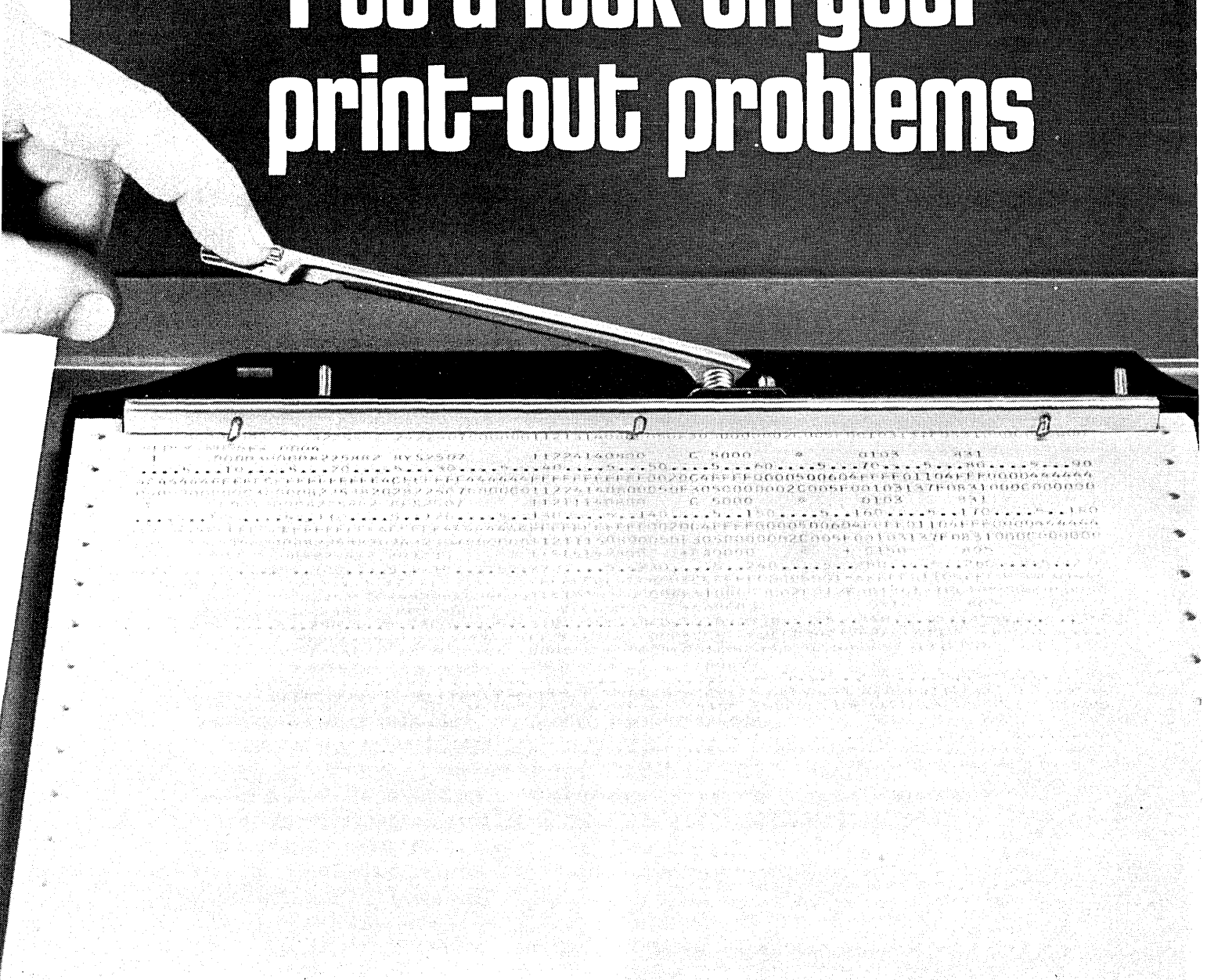

Press the lever in our new heavyweight Accodata binder and it springs open. Insert Forms. Push the lever down and Accogrip bar locks sheets in: burst or unburst. Instantly. No pin feed hole threading. A great time-saver for updating daily reports. Even different size sheets can be combined. In beautifully-textured 90 pt. Accohide\* or genuine pressboard. In 5 popular sizes. In 2 colors: blue and executive red. When you want binding as advanced as your computer, your Acco dealer has the details and so does our new 4/color catalog. You'll like the new Accodata-grip binder. Puts print-out in place. Properly.



5150 N. Northwest Highway, Chicago, Illinois 60630; New York, Los Angeles, Boston/Canada/England/Holland/Mexico/Venezuela/EI Salvador/Jamaica/Japan

\* A chemical resin.

CIRCLE 8 ON READER CARD

# BOOKS

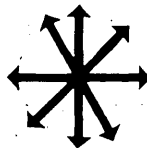

**APL Programming and Computer Techniques**, by Harry Katzan, Jr. Van Nostrand Reinhold Company, New York, 1969. 329 pages, \$12.

This is a good book, adding to the remarkable collection of books on APL—remarkable in that the level of writing is uniformly high in all the books on the subject that I have seen.

A subject with as wide applicability as APL needs a variety of books, covering the topic from various viewpoints for the differing needs of a wide range of readers. This book seems to be aimed at the person without prior contact with computers who wants to know what computers and programming are about. The examples lean rather distinctly to the scientific and mathematical side of the field.

One of the minor defects of the English language is that the range of modifiers is sometimes not explicitly clear. In this instance, the title contains an ambiguity of substance for the potential buyer: does "APL" modify only "programming," or does it also modify "computer techniques"? In short, is the book *only* about APL? In a word, no.

The book begins with three chapters on computer concepts: data representation, the concept of an algorithm, flowcharts, the elements of machine architecture, etc. The heart of the book, about half of the total, then is devoted to APL programming, presented at a level designed for the beginner. The exposition is clear and well motivated; there are many short examples woven in with the text. Then, apparently in an effort to give the beginner a little breadth along with his first brush with computers, there are chapters on computer systems and devices (more on architecture, mass storage, lease vs. buy, etc.) and programming systems and languages (operating system concepts, virtual storage, associative memory, and FORTRAN).

FORTRAN? This is something of a shock. Your average APL enthusiast pretends not to know that FORTRAN exists. But here it is, sketched rather briefly but entirely fairly. A 30-page appendix contains a dozen complete sample programs, presented as APL

terminal sessions with explanatory text.

If there really are readers who want this combination of material, which is a publisher's marketing decision, not a reviewer's problem, then this book covers it well. My only reservation would be that the absence of exercises limits its usefulness for the claimed purpose of serving as a textbook.

—Daniel D. McCracken

## BOOK BRIEFS...

**The SIMSCRIPT II Programming Language**, by P. J. Kiviat, R. Villanueva, and H. M. Markowitz. Prentice-Hall, Inc., Englewood Cliffs, N.J., 1968. 399 pp. \$10.95 (\$6.95, paperback).

SIMSCRIPT II was developed by the RAND Corp. to facilitate the simulation of large, complex systems and to reduce the total time spent in designing, programming, and testing simulation models. The language is free-form and English-like. The compiler corrects a large percentage of user syntax errors and forces execution of every complete program that is submitted. Some debugging statements and newly designed program control features are also provided. This book describes the language, while the implementation will be covered in another volume.

The book is organized into chapters corresponding to the following language levels. Level 1: A simple teaching language designed to introduce programming concepts to non-programmers. Level 2: A language roughly comparable to FORTRAN. Level 3: A language roughly comparable to ALGOL or PL/I. Level 4: That part of SIMSCRIPT II that contains the entity-attribute features. Level 5: The simulation-oriented part, containing statements for time advance, event-processing, generation of statistical variates, and accumulation and analysis of simulation-generated data.

A point to remember...

Low Cost  
**OMNIGRAPHIC®**

## POINT PLOTTER

for pulse height analyzer,  
DVM or digital oscilloscope

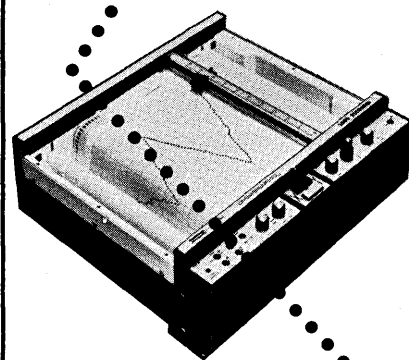

Model 3200-16-17

**\$1695**  
COMPLETE

Or, simply convert your model 3000 Omnigraphic strip chart recorder into a Point Plotter by plugging in 2 modules for just

**\$960**

Your Point Plotter will give you:

- 4 resolution selections: .025", .050", .075" and .100".
- Interchangeable Fibre Tip Colored Pen Points.
- Maximum sensitivity setting 1 mv/in.
- At resolution setting of 40/in., a plotting rate of 15 points/sec. (Will plot 400 channels in approximately 27 sec.)

Write today for the newest Houston Instrument brochure describing the expanded variety of functions available to present users of the HI model 2000 X-Y and model 3000 strip chart recorders.

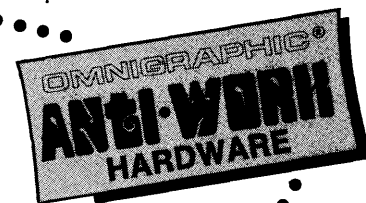

® A registered trademark of Houston Instrument.

**houston instrument** | DIVISION OF BAUSCH & LOMB®

4950 TERMINAL AVENUE, BELLAIRE, TEXAS 77401  
(713) 867-7403 CABLE HOINCO

houston instrument | European Office

8043 Unterfohring, München | Johanneskirchner Strasse 17  
W. Germany | (0811) 36-6300



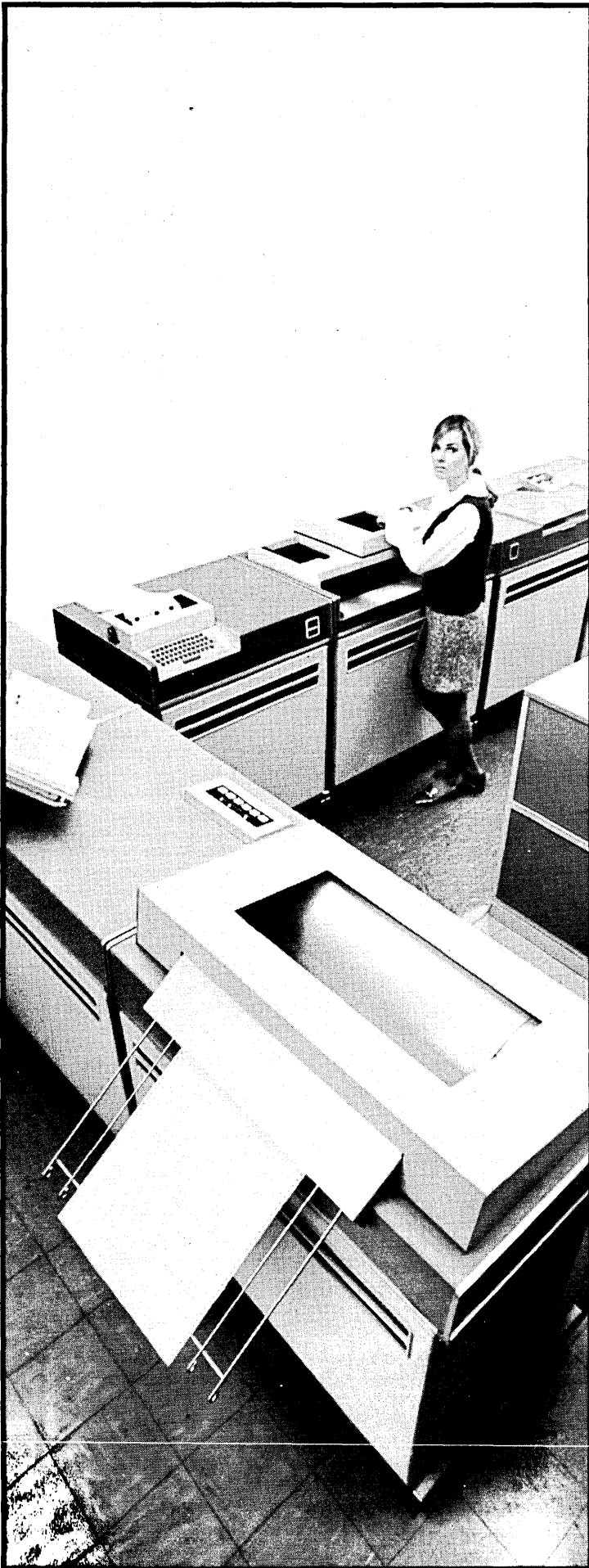

Frank Loria is the Corporate EDP Manager of SOS Consolidated, Inc. It's a firm that turns out everything from invisible door hinges to clutch pedals for automobiles to custom made fireproof doors. It's also a firm that depends on overnight production and cost reporting to meet customer demand and keep costs in line.

To do all that, Frank Loria needed a computer system that gave him optimum performance and capability for every dollar he spent. So he looked, looked again, then selected the NCR Century 100. But superior price/performance wasn't the only reason.

"We grew up on NCR accounting equipment. We were pleased with the service. We were pleased with the assistance we received from the NCR people. We expected the same kind of treatment with our NCR Century. And we weren't disappointed."

Superior price/performance, dependability and service. Frank Loria wouldn't tolerate anything less from his computer and his computer company. And we weren't about to let him down.

There are over 7,800 other NCR computer systems at work right now . . . solving problems just like Frank Loria's . . . solving problems just like yours. And we'd like to tell you about them. Because we figure it's the best way to prove our point.

Now, more than ever, NCR means computers.

**NCR**  
Computers  
& Terminals

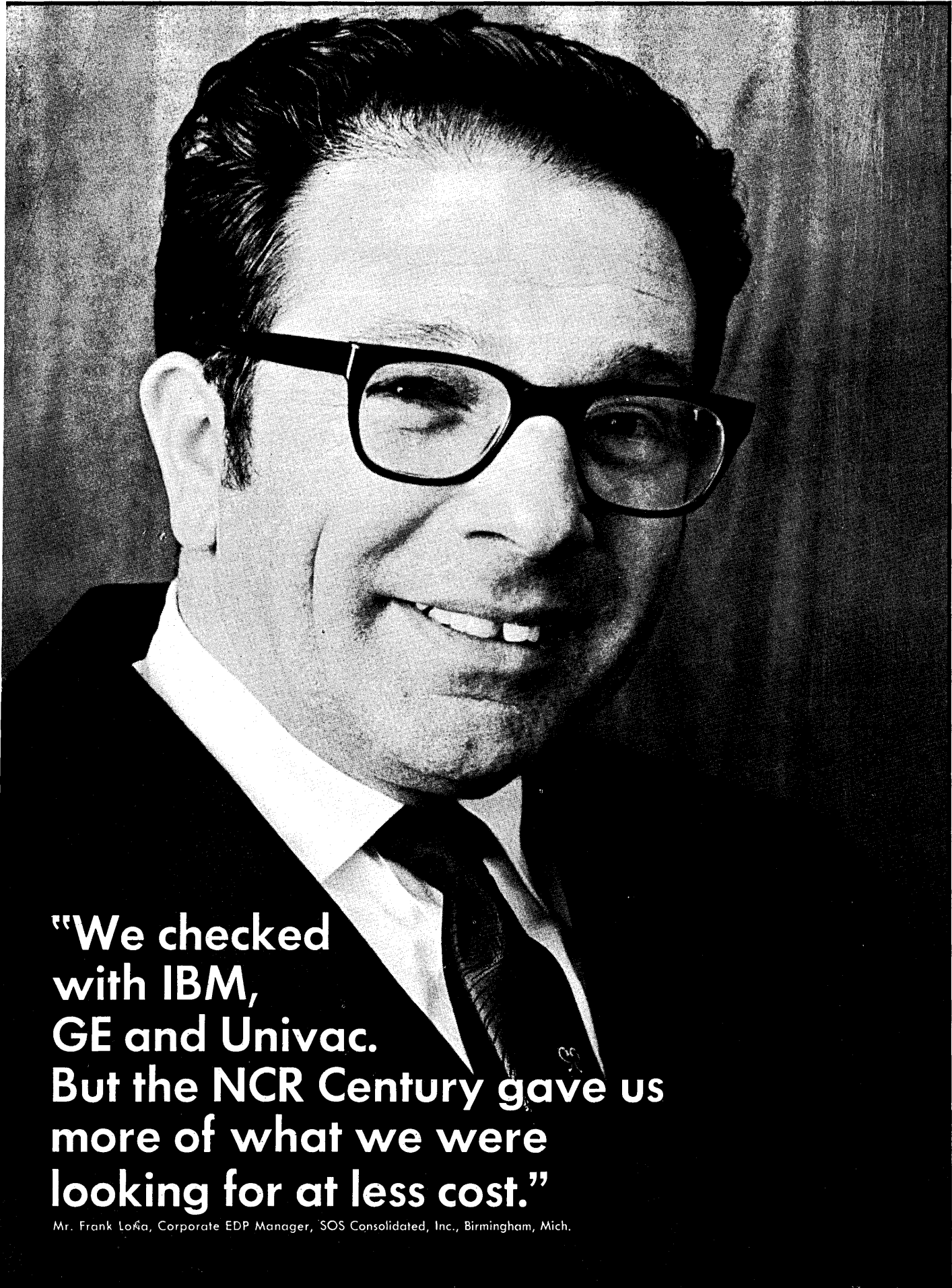

**"We checked  
with IBM,  
GE and Univac.  
But the NCR Century gave us  
more of what we were  
looking for at less cost."**

*Mr. Frank Lofo, Corporate EDP Manager, SOS Consolidated, Inc., Birmingham, Mich.*



# 36 Better Ways to Store and Handle Disk Packs are Shown in the Wright Line Catalog



To combine maximum protection, and most efficient use of space, Wright Line's complete line of disk pack storage equipment stores the disk packs in drawers that fully extend for easy access. In the line you will find library storage units, desk height cabinets, trucks and fire resistant Data-Bank Safes. They are all shown in your Wright Line Catalog, your one best source for information on Disk Pack Storage and accessories for use in tape, eighty column, and the new ninety-six column card systems.

It's so easy to solve your data processing accessory needs with the Wright Line Catalog



**1.** Select from the catalog and mail or phone your orders directly to your local Wright Line branch office or main plant in Worcester. Wright Line's more than 60 offices are listed in the yellow pages.

**2.** If additional information is needed when ordering or planning installations, call your local branch office and ask to have one of Wright Line's more than 125 field specialists call on you.

If you don't have a Wright Line Catalog, we'll be glad to send you one. Write or phone any of our offices or circle the readers' service number below.

*Everything for data-processing . . . except the computer*

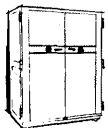

DATA-BANK SAFES

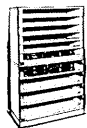

DISK STORAGE



CARD FILES



TAPE STORAGE

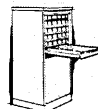

SYSTEM/3 ACCESSORIES



DATA PROCESSING ACCESSORIES

# If you want to cut your communications costs, this is the second step. It's DataPak.

The little black box is a multiplex modem. Unlike ordinary data modems, it doesn't require a separate telephone line for each data circuit. Which means it can save you a bundle.

Because DataPak single-handedly turns one telephone line into a carrier for ten, twenty or more teleprinter or low speed data terminal circuits simultaneously. And that can be like cutting your computer's phone bill by as much as 95 per cent.

These are hard times, and with communications costs skyrocketing, a saving like that on line costs alone becomes rather meaningful. Which should make our next bit of news downright irresistible.

Because Data Products Corporation, the people who invented DataPak, will survey your present message switching or data collection communications system, free of charge. And show you ways to spend less on communications. Without communicating less.

We'll examine your entire network point to point, city

by city, terminal by terminal. Your current costs, routing and network layout. We'll even do a complete, computerized analysis, where warranted, to insure your system is optimized for minimum routing mileage.

Why are we doing this? Because we want to prove that DataPak is the most reliable, cost-effective method of providing corporate data communications—be it an airline reservations system or a steel company message switching system—or anything in between. DataPak® is reducing line costs for companies like yours (a lot of companies) right now.

And we've been doing it for twenty years, which ought to tell you a lot about the kind of reliability and service you can expect from us.

At a time when communications expenditures can amount to as much as ten per cent of your total operating costs, you ought to know more about what we can do for you.

Especially when we're willing to do so much. Free.

## This is the first step. It's free.

D

Data Products Corporation  
Telecommunications Division  
65 Commerce Road, Stamford, Conn. 06902

I'm interested in your free data communications system analysis.

Name \_\_\_\_\_

Title \_\_\_\_\_

Company \_\_\_\_\_

Address \_\_\_\_\_

City \_\_\_\_\_ State \_\_\_\_\_ Zip \_\_\_\_\_

My system includes:

Message Switching  Data Collection/Distribution  News Distribution  Reservations

Other \_\_\_\_\_

Terminal data rates:  10 cps  15 cps  30 cps  60 cps

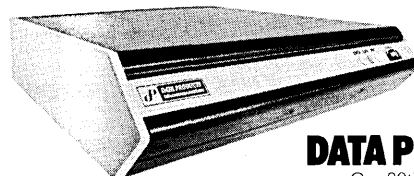

**DATA PRODUCTS DataPak.**

Our 20th year in data communications

Now a new combination of solutions to your data entry problems:

# Transitel Computer Support Systems. Systems. Systems.

Plus experienced data entry analysts.  
To help you get maximum savings from  
a data entry system that meets your needs.

The big job is finding the  
**right** system—or combination  
—to solve your problems.

So we analyze first.  
Then talk systems:

**Data Station**—The key-to-tape  
data entry system with features  
operators like the best.

**Data Communications Terminal**—  
The multifunction unit that can  
transmit at rates up to 3,600 bps.  
And print your reports, too.

**KeyTran**—The shared processor  
data entry system powered for  
maximum throughput per  
operator.

Only from Transitel.

There's no time like the present  
to find ways to solve data entry  
problems. And cut costs.

Call or write now. For complete  
information on our new  
combination of solutions.

**equipment  
that's nice  
to people—  
plus service to keep it that way.**

 **TRANSITEL**<sup>®</sup>  
COMPUTER SUPPORT SYSTEMS

DIVISION OF SANGAMO ELECTRIC COMPANY  
P.O. Box 7255, Park Hill Station, Denver, Colorado 80207 ☐ PHONE (303) 399-2263

# WASHINGTON REPORT

## NEW EXPORT TAX RULES NOW IN THE WORKS

Legislation providing tax deferral on export income may be introduced in the next month or two. The exporter would be allowed to set up a DISC (Domestic International Sales Corp.), a special subsidiary whose earnings would be tax-free until dividends are paid out to the parent. It would also provide a "safe haven" rule for sales to foreign subsidiaries: the DISC would be permitted to earn 4% profit on sales or 50% of the combined taxable income on both U.S. manufacturing and export, whichever is higher.

## FED ISSUES RULES ON BANK DP SERVICES

The Federal Reserve Board has proposed that bank holding companies be permitted to provide data processing services for (a) the holding company and subsidiaries, (b) other financial institutions, or (c) others, provided that the value of services performed for the latter group is not a "principal portion of the total value of all such services performed." DP industry sources here are not yet alarmed since much hinges on Fed interpretation of the term "principal."

## NEW BILL TO REGULATE BILLING PRACTICES

Sen. William Proxmire (D.-Wis.) has introduced a bill (S. 652) requiring creditors to investigate and answer customer billing complaints within 30 days or forfeit the disputed amount. Other provisions would compel creditors to mail statements at least 21 days before required payment date, and credit payments on day received. It would prohibit creditors from threatening consumers with adverse credit ratings while a billing dispute is under investigation.

## CAPITOL BRIEFS

Scantlin Electronics' plan to offer shared private line service sans FCC regulations has been OK'd by the commission, but a similar bid by Timeplex, Inc. has been rejected...In the 22 months ending last October, the Bell System provided 1547 manual and 558 automatic data access arrangements...Western Union of Hawaii, a new telegraph company subsidiary, has asked the state to OK a dial-up teleprinter service that would serve the islands and be able to interconnect with the U.S. mainland...The Census Bureau is Testing DUALLIST 3, a display program for Third Count summary tapes...A new computerized mapping system developed by the Economic Development Administration (Commerce Dept.) allows housing, income and other statistical distributions recorded on two or more maps to be combined automatically into a single composite...U.S. govt. export licenses issued for computer sales to Eastern Europe increased to \$24.1 million worth in 1970 from \$16.2 million in 1969 and \$9.8 million in 1968...If the Labor Dept. decides that programmers are professionals (see p.57), it will have a damaging impact on the efforts of the Communications Workers of America to organize programmers...EIA's new international council is setting up a special study group for East-West trade.

# ORDER NOW!



1. HAMMING—INTRODUCTION TO APPLIED NUMERICAL ANALYSIS 256 pages, \$14.95  
Presents the numerical analysis most needed by computer users.
  2. MOCHEL—FORTRAN PROGRAMMING, PROGRAMS, AND SCHEMATIC STORAGE MAPS 208 pages, \$5.95 soft  
Fast method of writing and debugging programs.
  3. DAVIS—INTRODUCTION TO ELECTRONIC COMPUTERS, Second Edition 550 pages (tent.), \$10.95 (tent.)  
A major revision of a best-selling text.
  4. DAVIS-LITECKY — ELEMENTARY COBOL PROGRAMMING, A Step by Step Approach 256 pages, \$4.50 soft  
One of the first to adhere to American National Standards.
  5. SLAGLE—ARTIFICIAL INTELLIGENCE: The Heuristic Programming Approach 224 pages, \$8.95  
Shows that machines can imitate human intelligence.
  6. RALSTON—INTRODUCTION TO PROGRAMMING AND COMPUTERS 496 pages, \$9.95  
Emphasizes communication between human and computer.
  7. RALSTON—FORTRAN PROGRAMMING: A Concise Exposition 120 pages, \$3.50 soft  
Accompanies above text—yet self-contained and complete.
  8. BELL-NEWELL—COMPUTER STRUCTURES: Examples and Readings 576 pages, \$16.50  
One-third of the book is original machine material.
  9. GATELY-BITTER—BASIC FOR BEGINNERS 120 pages, \$3.50 soft  
Auto-instructional text for courses in programming the BASIC computer language.
  10. PETERSON-HOLZ—FORTRAN IV AND THE IBM 360 244 pages, \$5.95 soft  
Stresses professionalism and techniques.
  11. WATSON — TIMESHARING SYSTEM DESIGN CONCEPTS 270 pages, \$9.95  
Covers the major hardware and software concepts required for the design and understanding of timeshared and multiprogrammed computer systems.
- Also
12. KOHAVI—SWITCHING AND FINITE AUTOMATA THEORY 500 pages, \$16.50
  13. GIVONE — INTRODUCTION TO SWITCHING CIRCUITY THEORY 448 pages, \$13.50
  14. MANNING-GARNERO—FORTRAN IV PROBLEM SOLVER 167 pages, \$4.50 soft
  15. MAISEL—AN INTRODUCTION TO ELECTRONIC DIGITAL COMPUTERS 384 pages, \$9.95
  16. HELLERMAN — DIGITAL COMPUTER SYSTEM PRINCIPLES 424 pages, \$13.50
  17. COLE—INTRODUCTION TO COMPUTING 384 pages, \$9.95  
WEISS—COMPUTER USAGE SERIES
  18. Applications 352 pages, \$8.95 hard; \$5.95 soft
  19. Fundamentals 448 pages, \$9.95
  20. 360 Assembly Programming 352 pages, \$9.50
  21. 360 Fortran Programming 192 pages, \$6.95

----- 10 DAY FREE EXAMINATION -----

**McGRAW-HILL BOOK COMPANY, BOX 402, HIGHSTOWN, NEW JERSEY 08520**

Send me book(s) circled below for 10 days examination on approval. In 10 days I will remit for book(s) I keep, plus a few cents for postage and handling, and return unwanted book(s) postpaid. (We pay delivery costs if you remit with this coupon—same return privilege.) Include sales tax if applicable.

- |              |              |              |              |              |                |
|--------------|--------------|--------------|--------------|--------------|----------------|
| 1. 025889-9  | 2. 042635-X  | 3. 015821-5  | 4. 015780-4  | 5. 058005-7  | 6. 051161-6    |
| 7. 051164-0  | 8. 004357-4  | 9. 005491-6  | 10. 049610-2 | 11. 068465-0 | 12. 035298-4   |
| 13. 023310-1 | 14. 039918-2 | 15. 039736-8 | 16. 028072-X | 17. 011770-5 | 18. 012385-3   |
| 19. 012382-9 | 20. 012380-2 | 21. 012381-0 |              |              | hard, 012384-5 |

NAME (print) \_\_\_\_\_

STREET ADDRESS \_\_\_\_\_

CITY \_\_\_\_\_ STATE \_\_\_\_\_ ZIP \_\_\_\_\_

For prices outside U.S., write McGraw-Hill Int'l. N.Y.C. 10036

62DAT31 SBN

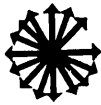

# PEOPLE

**Richard I. Tanaka**, in his second term as president of the American Federation of Information Processing Societies (AFIPS), has been elected a trustee of the International Federation for Information Processing (IFIP)—the federation of 32 countries concerned with computers and information processing. Tanaka leaves the AFIPS presidency in July and a nominating committee, headed by Jim Wolle of General Electric, soon will consider nominees for the post with elections during the Spring Joint Computer Conference in Atlantic City. Tanaka who has been the U.S. delegate to the IFIP General Assembly, is a vice president of California Computer Products, Inc., Anaheim, Calif.

**John V. Titsworth** has been named vice president of Control Data's Memory Products Div., heading planning, designing and manufacturing of the company's rotating memory products. He also will head the company's Magnetic Products Division which makes power supplies. He has been general manager of the Memory Products Division . . . Singer Company Friden Div. has named **Joseph P. Francini** vice president of research and engineering in the Advanced Systems Operations, a group



R. Tanaka



R. Muchmore

involved in developing systems products for the San Leandro, Calif. company. Francini has been director of research and engineering some two years, following technical staff positions with Univac and RCA . . . Tracor Data Systems, the Austin, Tex. maker of peripherals, has named **Charles H. Taft** president of a subsidiary, Berkeley Scientific Laboratories. He formerly was with Dero Research & Development Corp., Huntington, N.Y.

March 15, 1971

The company also announced the appointment of **Allan C. Glaser** as a senior vice president for operations and control . . . Ampex Computer Products Division announced a new position of manager of sales support to original equipment manufacturers. Filling the post is **Gerald J. Sullivan**, formerly national sales manager for OEM products . . . Digital Equipment Corp., Maynard, Mass., has appointed **John Holman** to manage the company's Computer Special Systems Group which markets and builds customized systems, peripherals and interfaces . . . TRW Systems Group, Redondo Beach, Calif., named **Robert B. Muchmore** the group's chief scientist, filling a post held by Dr. William S. Carlson who died last fall. Replacing Muchmore, who was manager of the Software and Information Systems Div., is **Dr. Robert Bromberg**, who was vice president of the Science and Technology Div. He becomes acting head of the division . . . **John Ottina**, formerly of King Resources and System Development Corp., has moved to Washington, D.C. as chief deputy commissioner of education in the federal government. Joining Ottina as an aide is **Harry Silberman**, former SDC manager of educational systems . . . **Thomas A. Jenkins**, former president of Datel Corp., has been named vice president of ElectroPrint, Inc., Palo Alto, Calif. The company makes



R. Bromberg



T. Jenkins

high speed electrostatic printing devices which use plain paper. The firm intends to enter the computer print-out and office copier markets . . . **Paul H. Stone** was named executive vice president and general manager of Mobark Instruments Corp., Sunnyvale, Calif. The company makes digital cassette tape recorders for dp uses. He left the Rucker Co., where he was president and general manager of the Moore Systems Div. ■

## These books are on trial . . .

. . . trial examination by you. Check those books below you want sent to you for a free 15-day trial examination. Then clip and mail the entire ad to Prentice-Hall at the address below.

- RPG: Report Program Generator**, Joyce Currie Little, Community College of Baltimore  
This new book is designed to cover all the IBM versions of RPG. It can be used by both beginners and experienced tab-hands to learn how to write programs in RPG. It provides many examples, illustrative sketches, and many final reports demonstrating the various capabilities of RPG as a programming tool.  
March 1971, approx. 352pp., \$11.95 (78336-5)
- Parallelism in Hardware and Software**, Harold Lorin, IBM Corporation Systems Research Institute  
Oriented for non-mathematicians, this new book serves as an introduction to hardware design concepts for programmers and software concepts for hardware people. The motives for trying to achieve concurrent operations, the various forms in which it may appear in the hardware and software of a computing system, the constraints, problems and design approaches are discussed in a simple narrative form.  
June 1971, approx. 512pp., \$15.00 (64863-4)
- Computer Programming System/360**, Ivan Flores, Baruch School of Business, City University of New York  
This revision of Ivan Flores' introductory text provides a systematic examination of programming and computer principles from an assembly language perspective. It offers a thorough investigation of programming giving the hardware and software principles necessary to the novice.  
September 1971, approx. 384pp., \$12.95 (16598-5)
- Expanded Use of Computers in the 70's**, Fred Gruenberger, San Fernando Valley State College  
This new book forecasts the direction of the computer industry. It presents the results of a UCLA/Informatics sponsored symposium. It focuses on manufacturers, expansion of present commercial and scientific markets, and potential service markets. Ideal for students in computing and business management courses.  
April 1971, approx. 128pp., \$6.95 (29470-2)
- Job Control Language and File Definition**, Ivan Flores, Baruch School of Business, City University of New York  
A comprehensive study of job control language written for advanced work, the organization of this text makes it understandable to students of modest experience. Offering five levels of explanation arranged in ascending order of complexity, the book integrates job control language and file definition.  
July 1971, approx. 288pp., \$12.50 (51000-8)

Send me the books indicated above for a free 15-day examination. Within the 15-day trial period, I'll either send you my check for the indicated amount or return the books and owe nothing.

Name \_\_\_\_\_  
Address \_\_\_\_\_  
City \_\_\_\_\_  
State \_\_\_\_\_ Zip \_\_\_\_\_

## Prentice-Hall, Inc.

Englewood Cliffs, N. J. 07632

Dept. 1

D-DATA-50

CIRCLE 35 ON READER CARD



# Timely news about Data-Phone® from Western Union.

"After April 1, 1971 AT&T will no longer install terminals (under 300 baud) for Data-Phone. We can, right now."



Z.V. Zakarian, president,  
Western Union  
Data Services Company.

If you plan to install or expand Data-Phone service, you should be aware of this important development. While AT&T will continue to maintain its presently installed terminals, it will not provide additional terminals under 300 baud — F.C.C. docket #18519 "Western Union acquisition of TWX from AT&T." This includes units such as the model 33 and model 35 teleprinter.

Who can? Western Union Data Services Company. And we're prepared to respond immediately to your needs. In addition, we can look at your future requirements and help you plan for them.

If you're considering installing or expanding Data-Phone terminals think of us. And we suggest you think of us now.

April 1 is just around the corner, so contact us today.

We are a new Western Union company. Our mission is to assist customers with data handling problems by providing data terminals and systems. We have a staff of systems and applications people available to help you. And we offer nationwide servicing, engineering, training and support.

For your Data-Phone or other data handling needs, call on us.

Contact me at Western Union Data Services Company, 16 McKee Drive, Mahwah, New Jersey 07430. Phone: 201-529-4600. Outside N.J. call toll-free 800-631-7050. Telex: 12-5077.



**western union**  
**data services company**

YOU'LL BE THE ONE  
WITH ALL THE ANSWERS  
if you order your own  
personal copy of the  
Datamation Industry Directory.

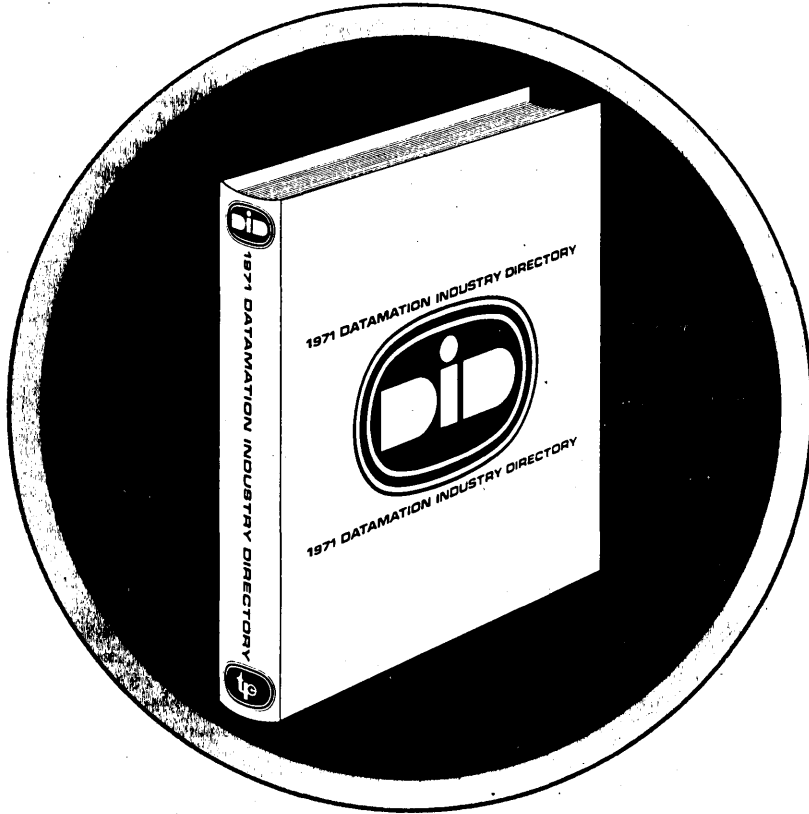

It was designed by independent EDP consultants who know your problems—and know what products and services you can use to solve them. So it includes everything from acoustic couplers and air conditioning to X-Y plotters.

Then this mass of information was simplified and cross-referenced to save you time. You can find out quickly the answers to such questions as:

What are the basic specifications?

What's the price?

Is the product compatible with my equipment?

Is there a service facility near my installation?

Is the supplier well enough established that I can count on him?

The directory will be delivered in May to over 31,000 computer installations. But you can get your own private copy to keep by mailing the coupon below.

**Clip and mail  
this coupon today**

A. Treat Walker, Manager  
Datamation Industry Directory  
35 Mason Street, Greenwich, CT 06830  
 Here's my check for \$25.00.  
Reserve a personal copy of DID for me.

Name \_\_\_\_\_

Title \_\_\_\_\_

Company \_\_\_\_\_

Address \_\_\_\_\_

City \_\_\_\_\_ State \_\_\_\_\_ Zip \_\_\_\_\_

# ADVERTISERS' INDEX

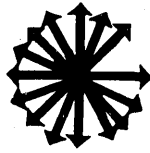

ACCO	94
Addressograph Multigraph Corporation	Cover 3
Alpha Data Incorporated	63
American Technological Institute	91, 102
Applied Systems Division of Computer Learning and Systems Corporation	42
Arvey Corporation, Lamcote Division	4
Bridge Data Products, Inc.	36
Bright Industries Inc.	84
Bryant Computer Products, A Division of Ex-Cell-O Corporation	51
The Bunker-Ramo Corporation, Business & Industry Division	2
Cadillac Associates, Inc.	110
Caelus Memories, Inc.	Cover 2
Callahan Center for Computer Professionals	90
Cambridge Memories, Inc.	6
Cogar Corp., Technology Div.	76, 77
Collins Radio Company	61
Colorado Instruments, Inc.	1
Computer Terminal Corporation	43
Computer Control Systems Inc.	88
Cybercom	72
Data Action	14, 15
Data Electronics Corporation	90
Data Products Corporation, Telecommunications Division	103
Data Transportation Company	63
Datamation Industry Directory	109
DATAMATION Magazine	99
Digital Computer Controls, Inc.	62
Digitronics Corporation	80

Entrex, Inc.	74
Facit-Odhner Inc.	81
Florida Department of Commerce, Bureau of Industrial Development	79
GKI, A Division of General Kinetics Inc.	78
Gould, Inc.	58, 59
Gould, Inc., Graphics Division	92, 93
Hazeltine Corporation	64, 65
Hewlett-Packard	66, 67
Houston Instrument, Division of Bausch & Lomb	95
Interactive Terminals Corporation, A Subsidiary of The Bendix Corporation	86
Kennedy Co.	57
Logicon	10
McGraw-Hill Book Company	106
Memorex	13
Micro Switch, A Division of Honeywell	54
Mohawk Data Sciences Corp.	20, 21
The National Cash Register Company	96, 97
Novar Corporation	68
Numeridex Tape Systems, Inc.	68
Omega-T Systems Incorporated	69
Pitney-Bowes, Inc.	7
Potter Instrument Company, Inc.	38, 39
Prentice-Hall, Inc.	107
Quadri Corporation	40
RCA Magnetic Products	8
RCA Service Co., A Division of RCA	87
Redcor Corporation	Cover 4
RFL Industries, Inc.	19
Scan-Data Corporation	37
Singer-Librascope	60
The Singer Company, Friden Division	46, 47
Singer Company, Micrographics System	70, 71
Teletype Corporation	82, 83
Tenncomp Systems Inc.	12
Timeplex, Inc.	5
Tracor Data Systems	52, 53
Transitel Division of Sangamo Electric Company	104
Tri-Data Corporation	16
Turnkey Systems Inc.	87
Western Union Data Services Company	108
Western Union Telegraph Company	44
Wilson Jones, A Division of Swingline Inc.	89
Wright Line, A Division of Barry Wright Corporation	98

## WHAT IS YOUR TRUE WORTH?

### FREE JOB OPPORTUNITIES BULLETIN

Cadillac Associates represents the nation's largest and most respected professional placement service. Our close relationship with the nation's finest firms generates continuous career opportunity information and allows us to confidentially present your qualifications to those at "decision-making" levels.

Our bulletin, published quarterly, listing available opportunities in the Systems & Data Processing field is available free of charge and will be mailed to your home upon your request.

For your free bulletin, without any obligation, circle reader service card #501. Please USE HOME ADDRESS ONLY!

### FREE CONFIDENTIAL PLACEMENT SERVICE

If you desire immediate assistance in locating an opportunity consistent with your objectives (professional/financial/geographic), CALL OR WRITE TODAY. A member of our staff of SYSTEMS & EDP SPECIALISTS will reach you by telephone to discuss your objectives and how we might help you satisfy them. A resume, or some details of background, will be appreciated.

Remember: Our client firms are located from coast to coast and assume all expenses (agency fee, interviewing & relocation).



**JACK JEROME,  
CADILLAC ASSOCIATES, INC.\***  
32 West Randolph St. Chicago, Ill. 60601  
Financial 6-9400

West coast residents—contact:  
Lon D. Barton Associates, 3325 Wilshire Blvd.  
Los Angeles, California 90010  
(213) 385-9111

\*"Where More Executives Find Their Positions Than Anywhere Else in The World."

## TECHNICAL PUBLISHING COMPANY

Arthur L. Rice, Jr., President  
Gardner F. Landon, Exec. Vice President, and President, Thompson Division  
James B. Tafel, Exec. Vice President, and President, Technical Division  
Calverd F. Jacobson, Financial Vice President  
Edwin C. Prouty, Jr., Secretary and Director of Data Processing

### ADVERTISING OFFICES

<i>Sales Manager &amp; Vice President</i>	<b>JOHN BRENNAN</b> 205 West Wacker Drive, Chicago, Ill. 60606 (312) 346-1026
<i>Eastern District Managers</i>	<b>JAMES M. MORRIS</b> <b>WARREN A. TIBBETTS</b> <b>IRWIN L. WERFEL</b> 35 Mason Street, Greenwich, Conn. 06830 (203) 661-5400
<i>New England District Manager &amp; Vice President</i>	<b>WARREN A. TIBBETTS</b> 112 West Haven Rd., Manchester, N.H., 03104 (603) 625-9498
<i>Midwest District Manager</i>	<b>JOHN M. GLEASON</b> 205 West Wacker Drive, Chicago, Ill. 60606 (312) 346-1026
<i>Western Manager &amp; Senior Vice President</i>	<b>HAMILTON S. STYRON</b> 94 So. Los Robles Ave., Pasadena, Cal. 91101 (213) 681-8486
<i>Western District Manager</i>	<b>JAMES E. FILIATRAULT</b> 61 Renato Court, Redwood City, Cal. 94061 (415) 364-3171
<i>England and Western Europe</i>	<b>WALLACE K. PONDER</b> 12 Somerset House, Somerset Road London, SW 19, England 01-947-0076

# Maybe your computer is trying to tell you something.

Like hurry up.

A computer's time is much too valuable to waste on an inefficient entry system.

What good is a speedy computer if it has to slow down, and wait for data?

Call us at A.M., and we'll get to you just as fast as our entry systems will get data to your computer.

Because A.M. has more experience with data acquisition. And more ways of getting information into a computer.

Paper tape systems. Magnetic tape systems. Optical character recognition systems. And the A.M. 6000. Which we think is the most sophisticated key-to-tape system to ever work with a computer.

So we can speed things up between central data processing and the many places where information originates.

We won't keep your computer waiting. We'll send an A.M. systems engineer to look at what you have in EDP equipment, or at the outside facilities you use.

Then we'll tailor the system to meet your particular requirements.

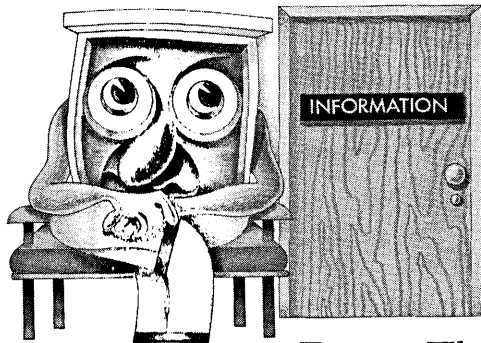

We'll give you all the systems support you need because we're a big corporation. And we have the size in service to back up our entry systems.

So write us at A.M., P.O. Box 3176, Cleveland, Ohio 44117. Or call your nearest branch. And to get a complete description of all A.M. systems, ask us to send you, "A

Funny Thing Happened On The Way To The Computer."

What we've done for the letters leaving your office we can do for the data entering your computer.



**Computer Support Systems**

Addressograph Multigraph Corporation

**LOOK OUT HONEYWELL . . .**  
**REDCOR'S KEYLOGIC SYSTEM CAGES PAPER TIGERS**

A few years ago there were paper tigers pussy-footing around the computer field.

Now Honeywell has let one loose right in the data entry marketplace.

Frightening thought? No. Paper tigers are easy to corner and capture. How? Get a tiger tamer.

Get KeyLogic. KeyLogic (key-to-disc) systems are in the field working.

Have racked up thousands of hours of experience. Thousands of dollars in user savings.

Little wonder that REDCOR has great confidence in its KeyLogic system.

It's doing what we say it will do. Meeting specification and delivery promises. Users have confidence, too.

They show it with new orders. Proven performance records. Cost savings now.

Not a digestible menu for paper tigers.

If you're out beating the bushes for a data entry system, be cagey yourself.

Wear the REDCOR badge of confidence. It's not just a lick and a promise.

It's your guarantee that KeyLogic systems will give you a dramatic cost saving, live performance. Now.

Call REDCOR: (213) 348-5892.

**REDCOR**  
**The Other Data Entry Company**

