

DATA⁷¹MATION[®]

February 1

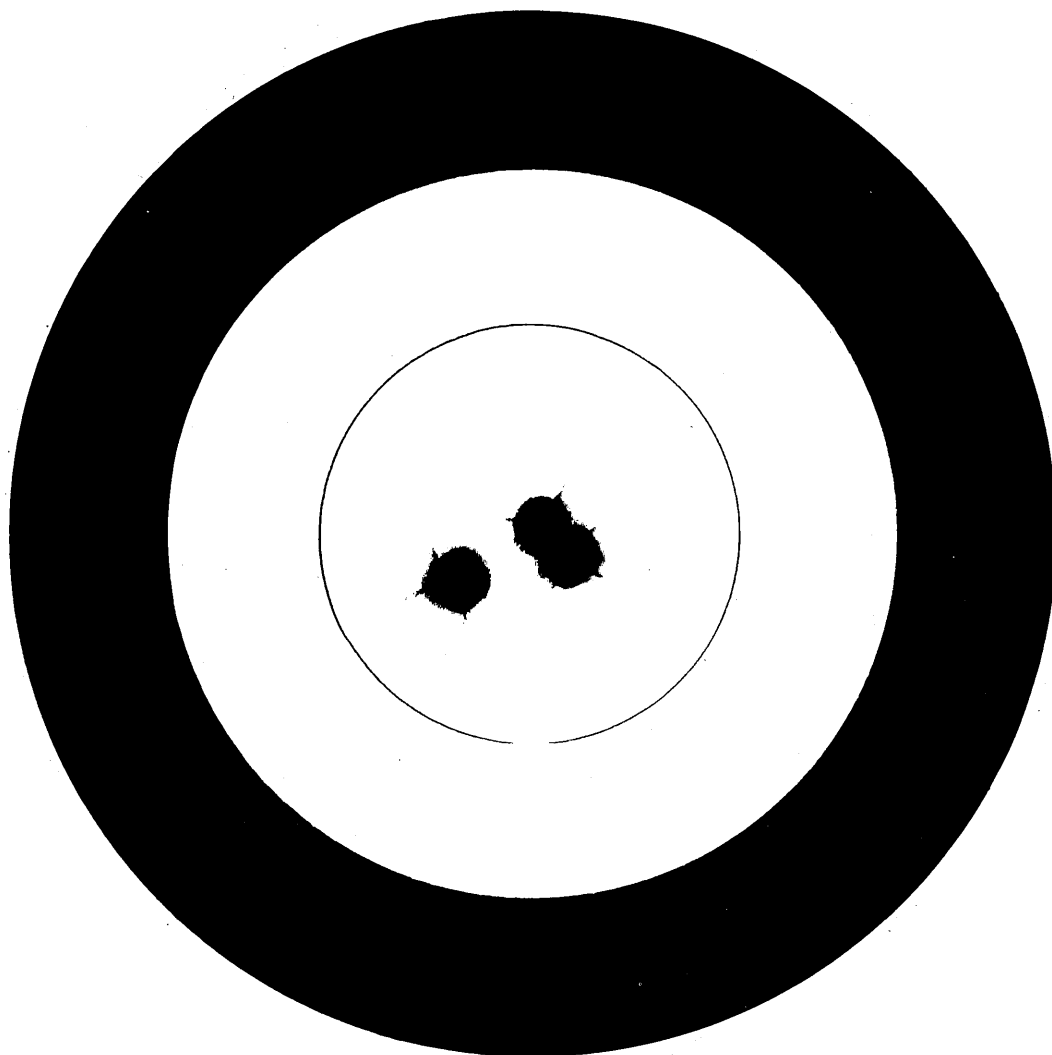

man/job/compensation...
computer expanded opportunities



On Target with Solutions

Our systems-capability solutions are dead-center on your minicomputer problems.

We aim to solve your problems in a variety of ways. Aside from our line of general-purpose computers described below, we have a full range of DELIVERABLE software: MOS, FORTRAN IV, BASIC, RPG IV, among others. We offer the largest line of FIELD-PROVEN peripherals. And we have maintenance contracts that are tailored to your system needs. We have a special Systems Engineering Department that DELIVERS.

Now about that hardware...

620/i: The total capability minicomputer. So great, over 1400 used worldwide.

620/f: New, so fast it just did one mega-execution while you read "so fast," completely compatible with the 620/i.

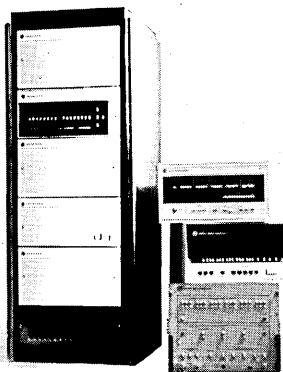

R620/i: The number one ruggedized minicomputer.

520/DC: Today's most cost-effective data communications system.

If you want to be on target with TOTAL solutions, why not talk to the big company in small computers?

U.S. Sales Offices: Downey, San Diego, San Francisco, Calif.; Washington, D.C.; Chicago, Ill.; Waltham, Mass.; Ann Arbor, Mich.; Minneapolis, Minn.; Albuquerque, New Mex.; New Rochelle, Syracuse, N.Y.; Fort Washington, Pa.; Dallas, Houston, Texas. Other offices worldwide.

Varian Data Machines, a Varian subsidiary, 2722 Michelson Dr., Irvine, California 92664. Telephone 714/833-2400.

 **varian**
data machines

The Big Company in Small Computers

An easier keyboard for your operator... An advanced tape station for your computer

The Tally Datascribe emphasizes simple operation with your keypunch operator in mind . . . and a host of versatile data handling options for more efficient utilization of a key-to-tape recorder. If you already have key-to-tape recording and communications equipment, you'll be especially interested in Datascribe. That's because Datascribe designers took the time to reflect on the shortcomings of all the earlier key-to-tape equipment in order to build a better machine.

The keyboard is virtually identical to the conventional keypunch keyboard. Operation is so simple you can learn from the manual if you choose. For training purposes, all data is displayed in English language. Both the 7 and 9 track units are identical in operation and features.

The Datascribe system is one basic unit which, with the addition of appropriate plug-in options, can be additionally used as a remote data terminal, pooler, high speed communicator or high speed print station.

The Datascribe offers a unique and highly efficient data compression feature. In the transmission mode,

one character can be used to represent many when data is identical to the preceding data or preceding record. Datascribe operates over dial up telephone lines. Both supply and take-up for full 10½" reels is standard.

And this is just the beginning. Call your nearest Tally regional office or contact us here for full details.

Tally Corporation, 8301 South 180th Street, Kent, Washington 98031. Phone (206) 251-5500.

Regional Offices:

Chicago: 33 North Addison Road, Addison, Illinois 60101
(312) 279-9200

Dallas: 2339 Inwood Plaza, Dallas, Texas 75235
(214) 521-5657

Los Angeles: 501 N. Golden Circle Drive, Santa Ana, California 92705 (714) 542-1196

New York: 45 North Village Avenue, Rockville Centre, Long Island, N.Y. (516) 678-4220

Richmond: 5404 Distributor Drive, Richmond, Virginia 23225 (703) 231-0259

San Francisco: 420 Market Street, San Francisco, California 94111 (415) 989-5375

England: Tally, Ltd., Tally House, 7 Cremyll Road, Reading RG1 8NQ, Berkshire Reading 580-142



TALLY
Vanguard Series

SUZY'S MARRIED TO OUR AD MANAGER

(they fight a lot)

"My husband Clyde?

Oh, he's all right. Good husband, good manager — but he never wants to say *enough* about a good thing.

PI's new 1217/19 customized digital recorder, for instance. That's why we have an occasional spat.

"If it were left to him, he'd just tell you the 1217/19 is synchronous and incremental, up to 1600 bpi, and features IBM compatibility, 7 or 9 channels. 'Never write too much in an ad,' he says, 'people won't read it.'

"Phooey!

You're reading this, aren't you?

"The rest of the good news (with apologies to no one): the 1217/19 also comes in 7 and 9 channels read-read, remotely selectable. It interfaces with your existing equipment, and is ideal for such uses as process control, off-line data processing, key-to-tape and tape-to-tape transfer, minicomputers, and many more.

"Every unit is easily field modified to meet new requirements — you simply choose the modular features you want. Result? A top-quality *custom* recorder at surprisingly low cost!

"If you'd like more information on the *enchanting* 1217/19, call, TWX or write Clyde or one of the other boys—Norm, Ridge or Konrad. Better yet, if you want the *full* story, call me!



PRECISION
INSTRUMENT

3170 Porter Drive, Palo Alto, California 94304 ■ Phone (415) 493-2222 ■ TWX No. 910-373-1752

CIRCLE 30 ON READER CARD

DATA⁷¹MATION®

FEBRUARY 1, 1971

volume 17 number 3

MANAGEMENT

22 Job/Man Matching in the '70s

Developed in the '20s, perfected in the '30s, industry's personnel selection techniques are no longer adequate. Here is a system that offers some hope.

28 EPIC—a Cafeteria Compensation Plan

Man does not work for bread alone — maybe a better parking place should be part of the reward package.

TECHNICAL

32 Optimizing Assembly Program for Minis

This assembler algorithm is a plan to reduce errors and increase the efficiency of your minicomputer.

GENERAL

34 De Ludi Natura

A new and less restrictive theory of programming and information could lead to a breakthrough into the realm of intuitive knowledge and draw more talented individuals into the profession.

37 Australian Report

Establishment of two peripheral manufacturers, a major increase in available computing power, and formation of public companies highlight the dp year Down Under.

40 Tokyo Show

A conference report.

COMMENTARY

44 Perspective

There is some progress in the government's efforts to upgrade the nation's air traffic control system — but the goal may not be any nearer . . . And a report on IBM's recent moves to unplug the compatible peripherals with new price cuts.

About the Cover

The bands of the spectrum widen for our symbolic man as the computer finds ways to increase his options and broaden the perspective of the area in which he can work successfully. The expansive design is by our art director.

departments

<i>Calendar</i>	9
<i>Letters to the Editor</i>	13
<i>Look Ahead</i>	17
<i>Perspective</i>	44
<i>News Scene</i>	46
<i>Hardware</i>	69
<i>Software</i>	73
<i>People</i>	78
<i>World Roundup</i>	85
<i>Index to Advertisers</i>	86
<i>The Forum</i>	90

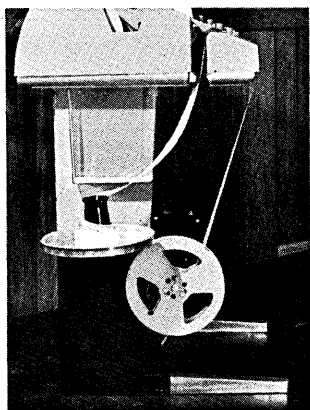

IN/OPAC's Data Center, designed specifically for Teletype Model 33 terminals with time-share users in mind, provides continuous, simultaneous winding and unwinding without operator attention. The Data Center fastens to the terminal in seconds. Write for details. Let us send you our new data processing input-output accessories catalog.

**FEED,
COLLECT
TAPES
IN ONE OPERATION**

***in/opac* DIVISION**

Numeridex Tape Systems, Inc., Dept. D
4711 W. North Ave./Chicago, Ill. 60639/312-772-6400

**Your most complete source of supply for
data processing peripherals and expendables**

CIRCLE 50 ON READER CARD

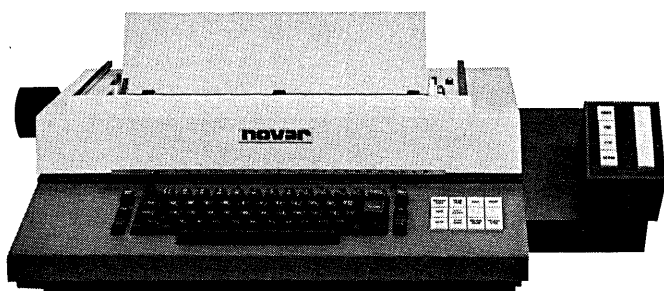

Novar terminals can be equipped for *automatic* detection of errors caused by noisy phone lines — and for *automatic* correction by retransmission. Assures that only correct data goes to the computer. Models 5-50 and 5-51.

Novar Corporation • 2370 Charleston Road
Mountain View, Calif. 94040 • (415) 964-3900
Nationwide Service In 56 Cities

NOVAR

A Member of GT&E Information Systems, Inc.

CIRCLE 33 ON READER CARD

DATAMATION®

FEBRUARY 1, 1971

volume 17 number 3

This issue 110,901 copies

EDITOR

ROBERT B. FOREST

EDITORIAL STAFF

Managing Editor

Senior Associate Editors

Associate Editors

Copy Editor

Assistant Editors

Special Features Editor

Eastern Editors

New England Editor

Washington Editor

Midwestern Editor

European Editor

Australian Editor

Contributing Editors

EDWARD K. YASAKI

WILLIAM J. ROLPH, TOM McCUSKER

AUBREY DAHL, RICHARD A. McLAUGHLIN,

EDITH D. MYERS, JOHN T. WATERHOUSE

JANET EYLER

MICHAEL WILLIAM CASHMAN

ALMA O'STEEN

ANGELINE PANTAGES

JOHN WESSLER, F. BARRY NELSON

W. DAVID GARDNER

PHIL HIRSCH

LAWRENCE RAGAN

PEARCE WRIGHT

FREDERICK A. BLAND

HOWARD BROMBERG, ROBERT V. HEAD,

PHILIP H. DORN, LOUIS B. MARIENTHAL,

DANIEL D. McCRACKEN, F. G. WITHINGTON,

PAUL ARMER, ROBERT P. BIGELOW

ROBERT L. PATRICK

LOWELL AMDAHL

Editorial Adviser

Technical Consultant

EDITORIAL OFFICES

HEADQUARTERS: 94 S. Los Robles Ave., Pasadena, Calif. 91101, Phone: (213) 681-8486; EASTERN: 35 Mason St., Greenwich, Conn. 06830, (203) 661-5400; 19 Marlborough St., Boston, Mass. 02116, (617) 267-9414; 9805 Singleton Dr., Bethesda, Md. 20034, (301) 365-8671; MIDWESTERN: 407 S. Dearborn St., Chicago, Ill. 60605, (312) 922-8245. FOREIGN: 65, Hill Road, Chelmsford, Essex, England; 322, Park Regis, Park St., Sydney, NSW 2000, Australia.

GRAPHIC DESIGN AND PRODUCTION

Art & Production Director

Production Manager

Production Assistants

CLEVE MARIE BOUTELL

MARILEE PITMAN

GLORIA J. FASANA, LOUISE T. O'CONNOR

CIRCULATION

35 Mason Street
Greenwich, Conn. 06830

Circulation Manager

Marketing Research Director

MAE VAN RENNES

DOUGLAS DeCARLO

PUBLISHER

GARDNER F. LANDON

ASSISTANT PUBLISHER

JAMES M. MORRIS

Circulation audited by
Business Publications Audit



Member, American
Business Press, Inc.

tp DATAMATION is published twice monthly on or about the first and fifteenth day of every month by Technical Publishing Company, 1301 South Grove Ave., Barrington, Illinois 60010; Arthur L. Rice Jr., President; Gardner F. Landon, Executive Vice President. Executive, Circulation and Advertising offices, 35 Mason Street, Greenwich, Conn. 06830 (203) 661-5400. Editorial offices, 94 So. Los Robles Avenue, Pasadena, California 91101. Published at Chicago, Ill.

DATAMATION is circulated without charge by name and title to certain qualified individuals who are employed by companies involved with automatic information handling equipment. Available to others by subscription at the rate of \$25 annually in the U.S. and Canada. Reduced rate for qualified students. Foreign subscriptions are on a paid basis only at a rate of \$38 annually. No subscription agency is authorized by us to solicit or take orders for subscriptions. Controlled circulation paid at Columbus, O. and Form 3579 to be sent to Technical Publishing Company, P.O. Box 2000, Greenwich, Conn. 06830. Copyright 1971, Technical Publishing Company. Microfilm copies of DATAMATION may be obtained from University Microfilms, Inc., 313 No. First St., Ann Arbor, Michigan. Printed by Beslow Associates, Inc.

If you think your university only wants batch, how come they buy so much timesharing service?

University comp centers mostly offer batch processing. And that's all. Tradition has it that batch is the only thing the scientists and economists and business offices want.

But 'tain't so.

Look around the campus for terminals connected to outside timesharing services. Look in the physics department, or engineering, and among the biologists and economists. Look in the special research grants where timesharing services are easy to bury. You may be in for a surprise.

That's where the PDP-10 comes in. A big, flexible computer that can handle a campus full of timesharers, as well as your batch. Real-

time from remote terminals, too. And all simultaneously.

Batch processing keeps the computer efficient. But more and more universities are discovering that timesharing keeps the users efficient. And with a PDP-10, you get the best of both worlds - timesharing and batch processing simultaneously. Plus real-time.

And the economics of having a PDP-10 will be another surprise. As a rule of thumb, if your university rents 20 timesharing terminals, you could own the PDP-10 for the same fees.

Think about it. And give us a call. Bowdoin did. Catholic U. did. University of Oregon did. SMU did. Western Ontario did . . .

digital

Digital Equipment Corporation, Maynard, Mass. 01754, (617) 897-5111

POTTER LP 300 135 LPM, UP TO \$3,385 E

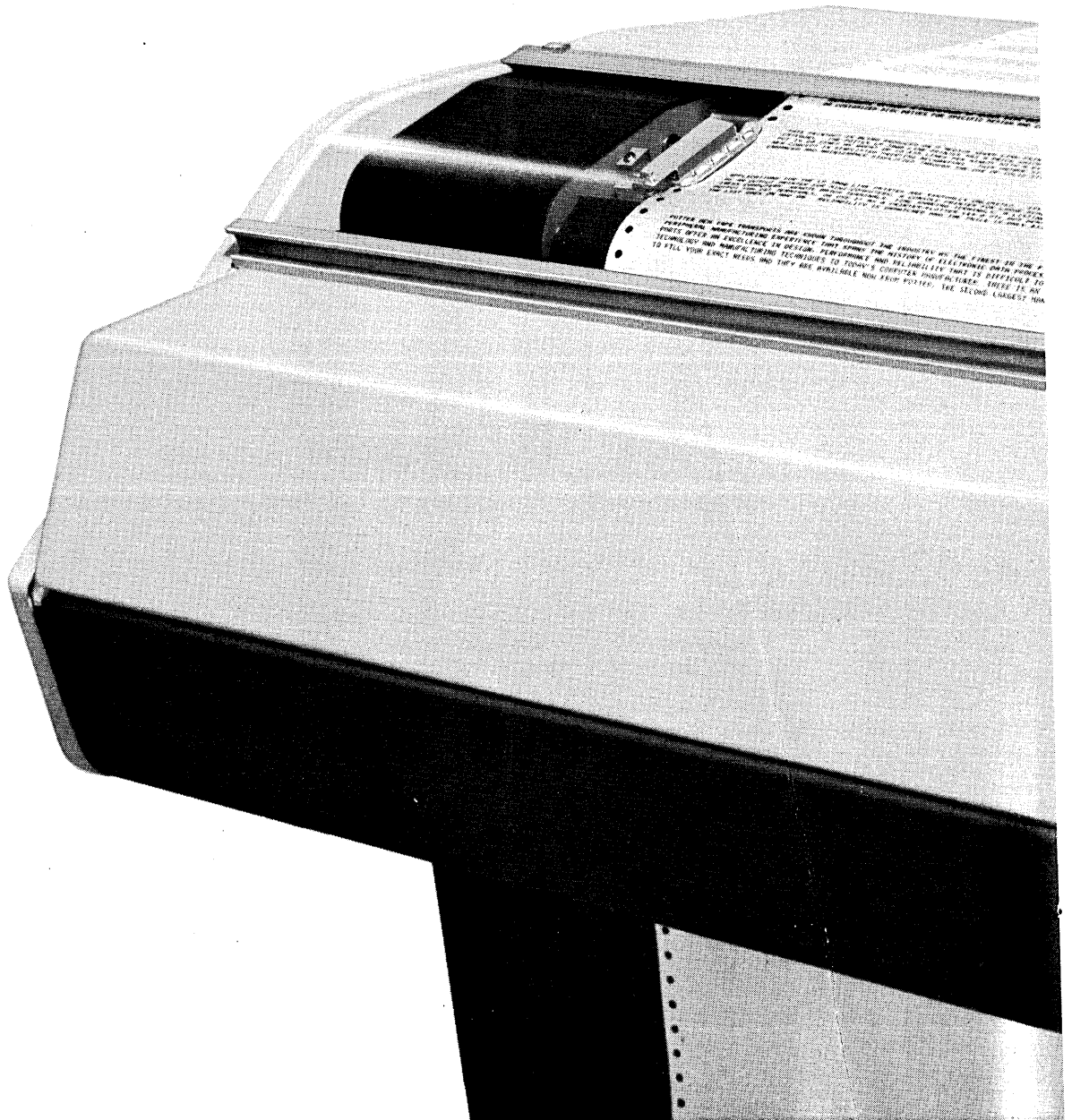

This is the lowest price in the world for a printer with these characteristics. Until now, system manufacturers have had to decide between 15 char/sec. typewriters or the high priced 300 lpm or faster computer printers. The Potter LP 3000 combines high speed with low cost.

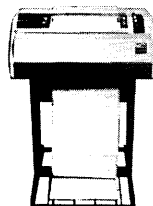

The Potter LP 3000 Line Printer is ideal for data communications systems and mini-computers. At 300 char/sec. or 135 lpm it is perfectly matched to 2400 baud data rates and offers more than 10 times the speed of ordinary I/O typewriters — all at only a fraction of the cost of computer line printers.

D LINE PRINTER 132 COLUMNS ACH/100



Designed with just a small percentage of the parts used in other printers, it gives you a level of reliability never before possible. You can incorporate the Potter LP 3000 Printer into your system easily and with confidence. It's in production now!

For information on the LP3000 and any of Potter's com-

plete line of magnetic tape transports, disk drives, printers or 96 column card peripherals, contact Potter Instrument Company, Inc., 532 Broad Hollow Road, Melville, N. Y. 11746. Phone: (516) 694-9000



No one beats a path through your computer room on Heugatile Carpet Squares

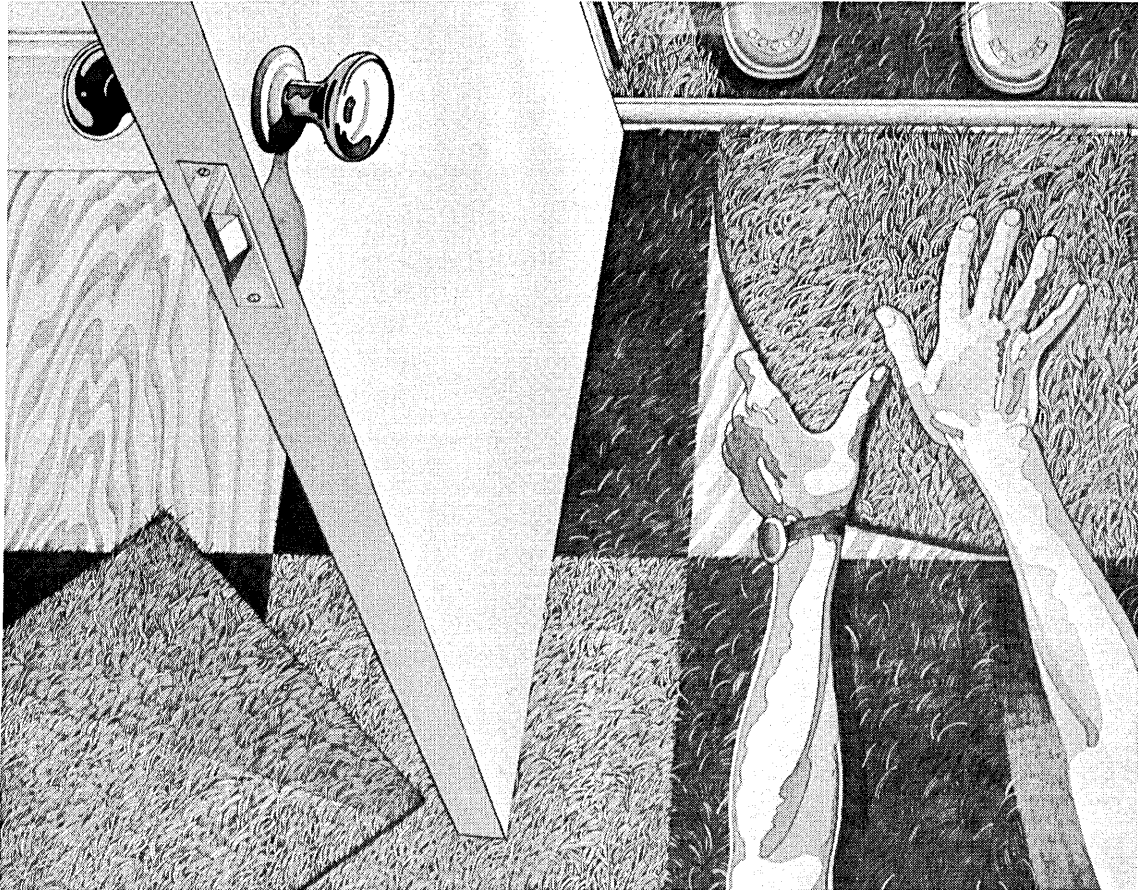

Light traffic area

Heavy traffic area



In the time other carpets are developing bedraggled trails of wear in the heavy traffic lanes, Heugatiles stay fresh and new—two to three times longer.

The secret is rotation. Before Heugatiles are worn by heavy traffic, you simply lift them out and easily move them to light traffic areas.

And underfloor access needn't be a headache. The one floor covering that licks this problem efficiently for computer rooms is Heugatile. Our carpet squares lock solidly in position by their own vacuum. But when you need to get to underfloor switches and control cables, up they come with no effort whatsoever. No glue, tape, tack strip or pad is needed, ever.

Noise problems? Heugatiles help silence the 'drum effect' created by vibrations from suspended floors. No static build-up either.

And you don't have to buy Heugatile. You can lease it, just as you would lease any equipment—with a service contract that guarantees continuing satisfaction. You can lease as little as 200 square yards, too.

Heugatile's special construction hides soil. Cleans easier. They're made by the most experienced manufacturer of carpet squares in the world.

Send in the coupon today for more information. Warehouses and showrooms from coast to coast.



HEUGATILE

HEUGATILE CORPORATION
185 Sumner Avenue
Kenilworth, New Jersey 07033
Dept. D-21

- Send me more information on Heugatile.
- This is for a current project.
- I'm interested in leasing Heugatile.
- Have representative contact me.

Name _____ Title _____

Company _____

Address _____

City _____ State _____ Zip _____

DATE EVENT/SPONSOR LOCATION CONTACT COST

Feb. 9-11	WINCON Aerospace & Electronic Systems Convention	Los Angeles	W. H. Herrman, IEEE 3600 Wilshire Blvd. Los Angeles, Calif. 90005	\$15, members \$20, others
Feb. 9-11	COMP SO East	New York City	Computer Exposition, Inc. 37 W. 39th St. New York, N.Y. 10018	Prereg., free \$2 at door
Feb. 15-19	Computer Display Equipment Exhibit	Frankfurt, Germany	U.S. Commerce Dept. BIC-932 Washington, D.C. 20230	\$450, exhibitors
Feb. 17-18	AIAA Integrated Information Systems Conference	Palo Alto, Calif.	R. W. Rector Cognitive Systems 319 S. Robertson Blvd. Beverly Hills, Calif. 90211	\$20, members \$35, others
Feb. 18-19	ADAPSO 31st Management Conf.	Phoenix, Ariz.	ADAPSO 551 5th Ave. New York, N.Y. 10017	\$80, members \$100, others
Feb. 17-19	6th Annual Conference on Digital Computers in Process Control	Baton Rouge, La.	Dr. Cecil L. Smith Louisiana State Univ. Baton Rouge, La.	Unknown
Feb. 22-24	Canadian DP Institute Conference & Trade Show	Ottawa	Revett Eldred, DPI Box 2458, Sta. D Ottawa 4, Canada	Invitational, by request
March 8-10	AMA Management Systems EDP Conference	New York City	American Mgt. Assn. 135 W. 50th St. New York, N.Y. 10020	Unknown
March 9-11	ASM, AMS Business Equipment Show	Tulsa, Okla	A. O. Oyler, BEST Box 141 Tulsa, Okla. 74102	Free admission \$215, exhibitors
March 10-12	4th Annual Simulation Symposium	Tampa, Fla.	Annual Simulation Symp. P.O. Box 1155 Tampa, Fla. 33601	\$85
March 22-24	Numerical Control Society's 8th Annual Conference	Anaheim, Calif.	NCS 44 Nassau St. Princeton, N.J. 08540	\$95, members \$125, others
March 23-26	Information Industry Association 3rd Annual Meeting	Lancaster, Pa.	IIA 1025 15th St. NW Washington, D.C. 20005	\$75, members \$125, others \$25, spouses
April 1-2	ACM Symposium on Information Storage & Retrieval	College Park, Md.	Dr. Jack Minker University of Maryland College Park, Md.	Unknown
April 6-9	COMP SO West	Anaheim, Calif.	Computer Expositions, Inc. 37 W. 31st St. New York, N.Y. 10018	Free preregistered \$2 at door
April 14-15	ISA, IEEE Electronics & Instrumentation Conference	Cincinnati	William Meinders Husky Products, Inc. 7405 Industrial Rd. Florence, Ky. 41042	\$2 registration
May 18-20	Spring Joint Computer Conference	Atlantic City	AFIPS 210 Summit Ave. Montvale, N.J. 07645	Preregistration \$20, members \$50, others
May 25-28	20th Annual Convention National Microfilm Assn.	Washington, D.C.	NMA Suite 1101 8728 Colesville Rd. Silver Spring, Md. 20910	Unknown



**C
A
L
E
N
D
A
R**

The Cybermess.

(Cleared up by Cybermatics Inc., Fort Lee, New Jersey)

What you see in the picture below is a bad case of cyberling rivalry. The phone book is full of companies named Cyber-something. Since we helped make this mess, we'd like to clean up our corner of it.

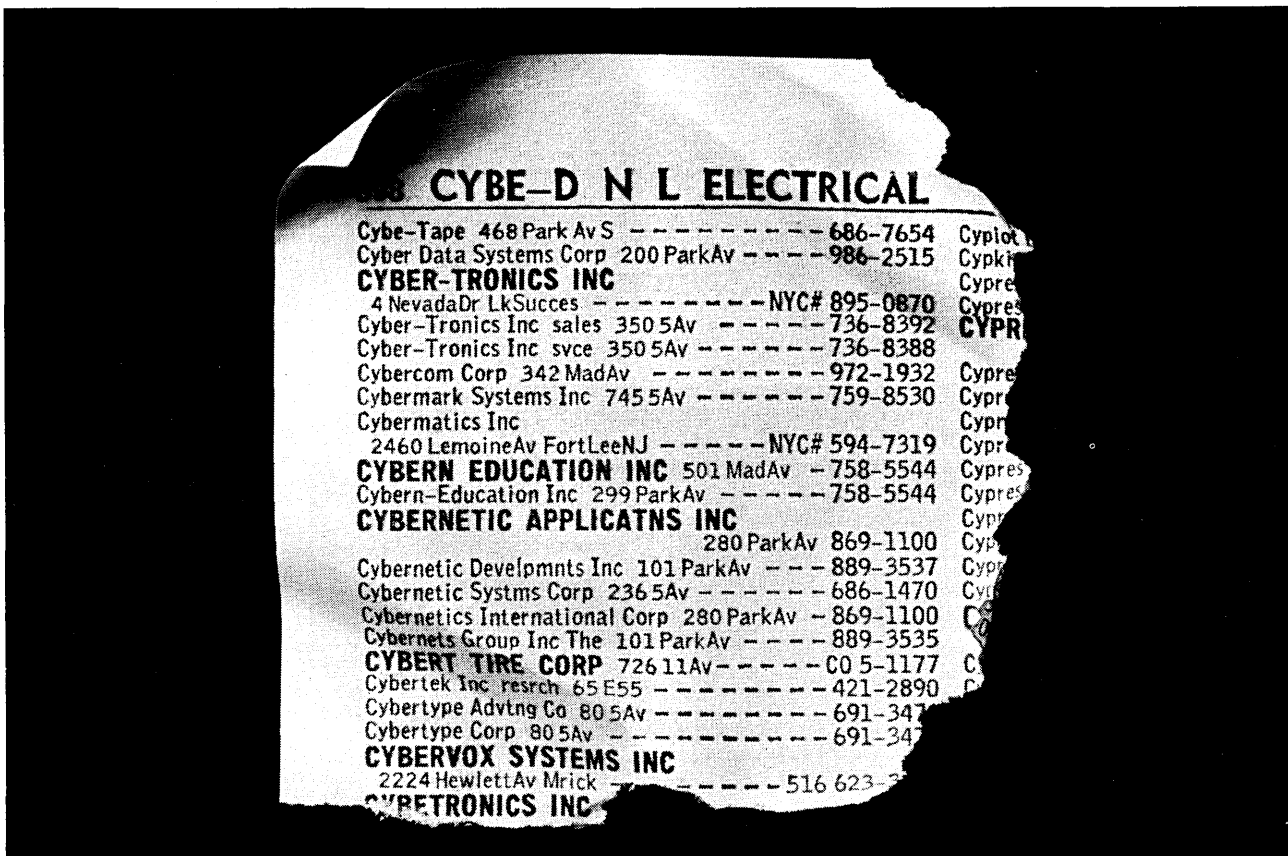

Here's the mess, torn from the phonebook. We're in there somewhere. Can you find us?

Our full name is "Cybermatics." You won't find the word in a dictionary yet, but it has a precise meaning: the science of managing information-communication systems.

That's exactly what Cybermatics Inc. does. We develop on-line computer systems. This is the big leagues of the computer game. It takes big-league talent. Four of the 18 great brains in on-line computers work at Cybermatics.

Companies don't build on-line computer systems every day. So it may be quite a while before you ask your secretary to get you "Cybermatics."

But when you do, please pronounce it very, very carefully.

GEORGE

IS A GENIUS!

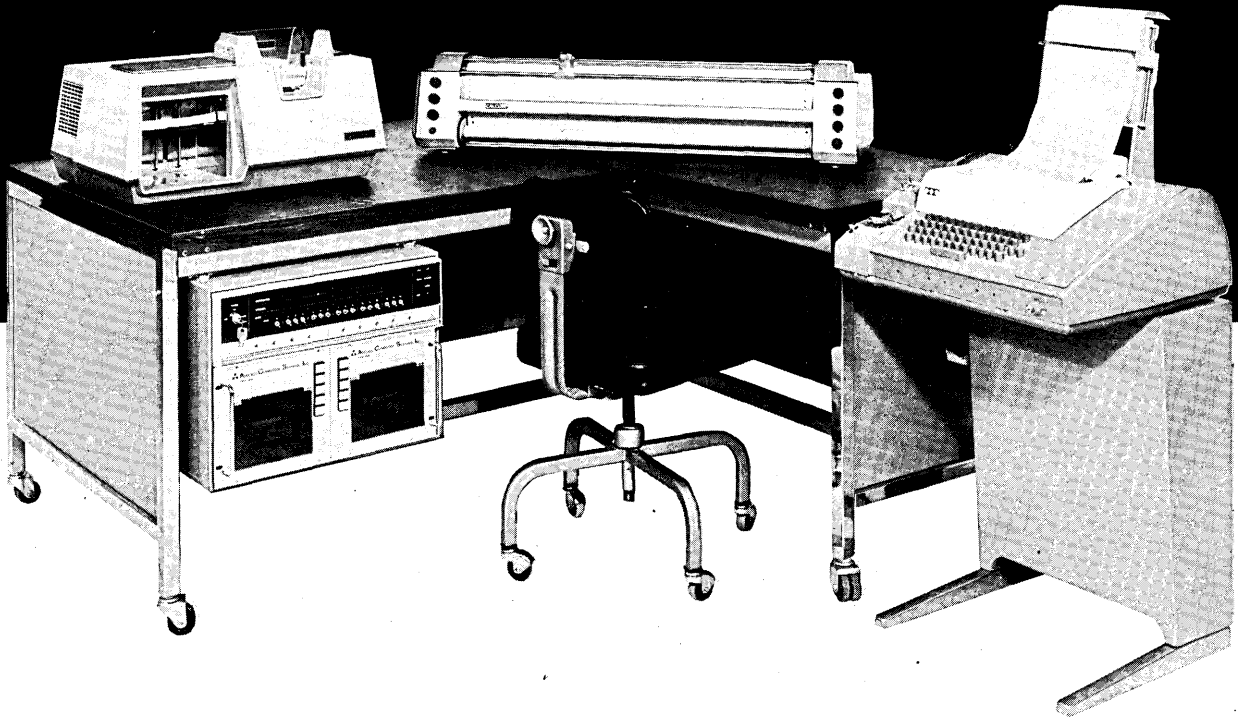

More than just a "smart" terminal, **George** combines the flexibility of a minicomputer terminal with the hardware for *real time data acquisition* and control. Designed for the scientific user, **George** can be individually programmed to meet a customer's special needs. Remote batch, interactive, real time data collection, on-line and off-line modes to build a truly cost effective automation system.

Available with a variety of I/O devices

- * IBM compatible tape
- * line printer
- * card reader
- * A-D converters
- * D-A converters
- * plotter
- * cassette storage
- * CRT displays
- * multiplexers
- * stepping motors

Write or call today and let ACSI solve your problem.



APPLIED COMPUTER SYSTEMS, INC.

A Subsidiary of COLUMBIA SCIENTIFIC INDUSTRIES, INC.

BOX 6479 AUSTIN, TEXAS 78702

(512) 926-1536

What looks like a new computer, acts like a new computer, but costs 30% less?

A used computer.

Figure it out. With savings like 30% on System/360's and peripherals, a used computer gives you great price/performance. Especially since computers don't wear out.

Dataware Marketing buys and sells used computers. Aside from the manufacturer, we

have the world's largest available selection of used computer systems. Plus reps around the world. And all our equipment qualifies for manufacturer's maintenance.

Speak to the people at Dataware about your computer needs. The savings speak for themselves.

Dataware

MARKETING, INC.

Subsidiary of Boothe Computer Corp.

Home Office 555 California St., San Francisco 94104, (415) 989-6580
New York (212) 758-4955 • Chicago (312) 696-4550 • Los Angeles (213) 776-6861



LETTERS

Dumping grounds

Sir:

Re the letter in the Nov. 15 issue, p. 15:

If Koh Amar Jachweg's wife sees anything pornographic in that core dump, he should cancel his wife, not DATAMATION.

SCHUYLER SHARP
Tulsa, Oklahoma

Glad tidings

Sir:

I enjoyed reading the historical account of the analog tide predicting machine used for over half a century by the Coast and Geodetic Survey in the article, "The Great Brass Brain," by Mr. Al Collins (Nov. 15, p. 32). I share the admiration of Mr. Collins for the ingenuity of the designers of the "Brass Brain." However, I was somewhat disturbed by the critical comments concerning the digital computer program which is now used for tide prediction.

The implication is made that the digital program is changing the problem to be solved. Mr. Collins says, "The problem has to do with nature, not the corporate controller or the latest super-programmer's notion of what he thinks the problem is or should be. The machine did not stretch the state of the art." I am certain that the digital computer programmer has not lost the concept of the tide prediction problem. Both the tide predicting machine and the computer program combine the elementary constituent tides into the composite tide. Both systems use the same harmonic constants to represent the constituent tides. Schureman, in his *Manual of Harmonic Analysis and Prediction of Tides*, stated, "Without the use of a predicting machine the harmonic method would involve too much labor to be of practical service, . . ." The digital computer simply supplies the labor that was not available to Schureman.

Mr. Collins indicates the tide for any minute can no longer be attained. Actually the tide at any desired time interval, whether it be each hour, minute, second, microsecond, etc., can be obtained with the

use of the digital computer. This is done by supplying the angular speeds of the 37 tidal constituents in units of the time interval desired.

The article brings up the question of whether the computer will have as good a record of error-free operation as the tide predicting machine. I have used the tide prediction program about 700-800 times in the last 12 years and I do not recall having a bad program run.

An estimate of the savings by using the digital computer can be made by comparing the cost of operating the tide machine to the cost of using the digital computer. For one year of tide predictions at one location, about eight (rather than three as stated by Collins) hours of labor are required to adjust and operate the tide machine. One year of predictions consisting of high and low tides to the nearest minute and a value for each hour of the year requires about 35 seconds on the CDC 6600. In terms of expense this means about \$80 for the operation of the tide machine and about \$8 for the digital computer—a ratio of 10 to 1.

I have great respect for the scientists who developed the tide predicting machines of this country, Ferrel (1885) and Harris and Fischer (1912). I imagine that if these men were in the tide predicting business today they would be using electronic digital computers.

N. A. PORE
U.S. Weather Bureau
Silver Spring, Maryland

Tender compaction

Sir:

I read with great interest the article entitled "The Myriad Virtues of Text Compaction" (Dec. 1, p. 36). However, since we are manufacturers of "intelligent remote batch" data terminals, it is with regret that I note that none of these excellent principles have been applied to the data transmission industry. It seems that giant steps have been taken with regard to the hardware that is used to transmit data. Speeds of up to 9600 baud on voice-grade lines are becoming commonplace. Associated with these advances, however, are rela-

tively high costs.

It is a shame that the large mainframe manufacturers have not seen fit to make use of these excellent compaction and compression techniques in their "supported" communications software. We, as independent terminal manufacturers, are forced to simulate existing hardwired terminals in order to gain a foothold in the marketplace. Our intelligent terminal as well as others in the marketplace could easily be programmed to make use of the new compaction technology.

It is not economically feasible, however, to write a new communications program for each new customer. We are therefore at the mercy of the mainframe manufacturers' software development schedule. It is only through their efforts that an industry standard can be developed. It is frustrating to be aware of techniques which could improve data communications throughput by 25% to 50% without increasing the cost and not be able to implement them. The ramifications of this concept are staggering. Throughput could be improved drastically; therefore, time-sharing utilities could handle more lines with the same equipment, and existing data communications facilities could handle a proportionate increase in data customers without any investment in additional facilities. It is time that we call upon our existing hardware resources to perform efficiently, rather than replacing them with faster hardware devices which will perform inefficiently faster.

NEIL J. WEBER, C.D.P.
Noller Control Systems
Milwaukee, Wisconsin

Th, en, re, ed, on

Sir:

I must congratulate Messrs. Synderman and Hunt on their interesting article on text compaction. As a user of large free text files I wish I had thought of it myself.

However, in regard to their remark that the optimal selection of master and combining characters would make the basis of an excellent thesis, perhaps I can make a contribution. Cryptographers have long been interested in the frequency of occurrence of letter pairs in English text. The reference quotes a work dated 1893. The 15 commonest digraphs in order of frequency are:

(Continued on page 15)

Suspenders are back in style!

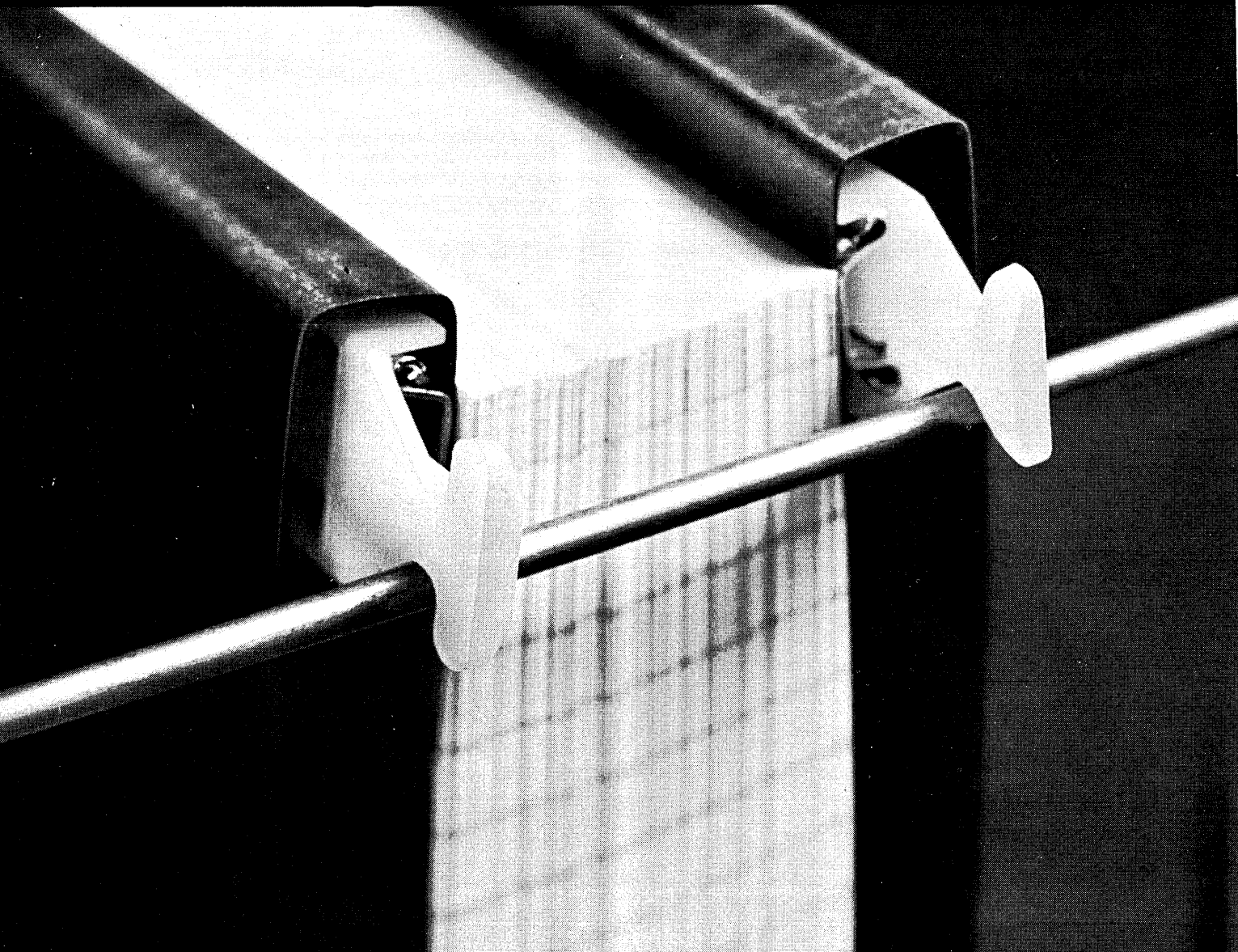

If it works for pants, why not for printouts?

National presents Hang-A-Ref™ Data Binders, the ones with a unique sliding hook that lets you hang up to 8" of data on any National Control Rack.

Slide it out to hang in file or storage; slide it in for easy carrying and reference. (Don't worry, it slides in all the way so it can't scratch desk tops.)

Hang-A-Ref Binders available in two different cover materials:

National Blank Book Company, Inc.
Dept. D
Holyoke, Massachusetts 01040

I'd like my free copy of your Data Reference Control System Catalog.

Name _____

Title _____

Company _____

Address _____

City _____ State _____ Zip _____

Natlon™, a long-wearing plastic material; and Pres-Vin™, a press-board material coated with clear vinyl. Printouts can even be color-coded – Hang-A-Ref Binders come in eleven different colors!

To put all your printout problems back in shape, call your National dealer now, or clip the coupon for a new data products catalog that describes our complete line of binders, racks, accessories – the works.



NATIONAL BLANK BOOK COMPANY, INC.
A Subsidiary of Dennison Manufacturing Company

CIRCLE 32 ON READER CARD

Letters . . .

TH, HE, AN, ER, ON, RE, IN, ED,
ND, AT, OF, OR, HA, EN, NT.

The most frequent digraph is commoner than the letter C, and the least frequent occurs more often than V, which confirms the authors' idea of the value of compaction.

Examination of the list given above shows that U should probably be dropped from the master list in favor of H. I say "probably" because the initial and final letters in words become important in the light of the authors' finding that blanks are so common. Reference to the nearest dictionary shows that the most likely letter for a word taken at random to begin with is S. Since S is a popular final letter, appearing in most plurals, it must also be a candidate for master character.

One more thought, the trigraph THE occurs more often than the letter G, and 10 others more often than J.

I look forward to the graduate thesis and only hope that we wait for it before standardizing on a "compact text code."

B. FARRELL CHOWN
Ottawa, Ontario, Canada

Modularity

Sir:

Your columns have recently contained some comments on COBOL and modular programming techniques. The discussion stems from Mr. Vaughn's article "Can COBOL Cope" in your Sept. 1 issue (p. 42). May I add to the fire by suggesting that the problem is not so much COBOL as modularity?

It is now generally accepted amongst computer programmers that modularity is a useful technique. The advantages of breaking down a complex problem into its constituent parts now seem so obvious that they need not be summarized here. Yet few installations manage to do modular programming successfully, and the resulting modular programs are often no better than the monolithic programs they replace. In fact, modular programs are often monolithic programs broken into arbitrary "modules," each of which reflects the characteristics of the monolithic programs they replace. How then should a programmer avoid this pitfall? How should a programmer break a program down into modules? These questions are only now beginning to receive the attention they deserve.

To answer them one must answer the following questions: What is the theoretical structure of a program; what compromises have to be made to make a program testable; what compromises have to be made to code a program in a given language.

Attention is usually given only to the last question—hence the preoccupation with COBOL. Sometimes attention is given to the second question, and only rarely to the first. But it is just the structural characteristics of a program which can throw most light on the problem of devising modular solutions to programming problems.

For example, how does a program structure relate to the files it is processing; how should file exception conditions be handled; why does hardware dependent logic (i.e. page spacing) cause so many headaches; at what point should particular report lines be constructed and printed? And so on. Answers to these questions must be found which depend only on program structures, and not on programmer whims, if there is to be any consistency in program design.

If program design is seen as the real problem, then language problems are put into a proper perspective, and seem far less important. A better understanding of program design might even open the way for we programmers to influence the kind of languages which are provided to code our programs.

ALAN COHEN
New York, New York

Tagging along

Sir:

The "particularly biting jab" leveled at the NCR color coded tag by William H. Burkhart, president of Transaction Systems, Inc., as quoted by author F. Barry Nelson in the article "pos Now Respectable; NCR Has It!" in the Nov. 15 issue (p. 129-131) is completely untrue. The NCR color bar tag cannot be falsified by the use of a Polaroid Colorpak camera (either the \$25 minus employee discount model, or the \$170 model with no discount) because of the specific spectral components demanded of the reflected light by the handheld wand.

This, and most other attempts to alter the color coded tag data content, will render the tag completely unreadable due to the extensive error

checking designed into the NCR coding and reader system.

The NCR color bar tag is as "criminal proof" as a magnetic tag, and much easier to determine visually if it has been tampered with by some unscrupulous person.

THOMAS A. SHERBY
*Director, Dayton Engineering and
Advanced Development
National Cash Register Company
Dayton, Ohio*

Sensorship

Sir:

Your Dec. 1 issue's "Look Ahead" column included some incorrect and misleading speculation about IBM's DACS (Data Acquisition and Control Systems) organization, which—among other duties—handles the IBM 1800.

In announcing IBM System/7, we made it clear that the new computer complemented the capabilities of the 1800 by extending its range and making additional applications feasible.

We referred to System/7 as a "sensor-based system" and have taken the same approach with our DACS centers and specialized marketing representatives. They have been redesignated as "Sensor-Based Systems Centers" and as "sensor-based systems representatives" to more accurately describe their scope. The only change was one of terminology.

Rather than cutting back our sensor-based marketing organization, we have, in fact, expanded it by providing additional educational, technical, and marketing support.

JAMES J. KEIL
*Director of Systems Marketing
IBM
White Plains, New York*

Caught on base

Sir:

Regarding the letter from Mr. J. N. Lambrecht in the Dec. 1 issue: I hate to tell him, but hexadecimal was used by the people connected with SWAC, which went on the air in early 1951, I believe.

They became quite proficient in operating on that base. One of them claimed that lapsing into base 16 in a supermarket had been a minor source of embarrassment on occasion.

ARNOLD I. DUMEY
Princeton, New Jersey

BURROUGHS B 6700

It's the most advanced business data processing system now available for service.

Because it provides:

POWER. One, two or three central processors. One, two or three input/output processors. Double-size main memory (up to six million bytes). Electronic exchange architecture.

MULTIPROCESSING. It's automatic. With any mix of programs. For flexibility and throughput.

DYNAMIC RESOURCE ALLOCATION. For "fail-soft" security and continuous operating efficiency.

COMPLETE SELF-REGULATION. The computer runs itself under Master Control Program supervision.

EXPANDABILITY. You can add equipment as you add the work. Any time. With no reprogramming.

DATA COMMUNICATIONS. Service for more than 3,000 lines. Without burdening the central system.

VIRTUAL MEMORY. No more limits on program size. It's independent, so programmers don't have to plan for it.

COMPILER LANGUAGE PROGRAMING. Exclusively. It makes program writing and modification a lot easier.

DISK STORAGE. Massive—with up to 72 billion bytes on-line. Fast—with access to any record in as little as 1/500th of a second.

These important systems design capabilities are ready for you now in the B 6700.

From the company that's recognized for leadership in systems design...



Burroughs



LOOK AHEAD

IBM ALSO FEELS
FITS OF DEPRESSION

IBM, the firm that "fires but never has layoffs," has reportedly given 1,800 staff-level employees a choice: go back into the field or submit to "involuntary resignation." It's well known that IBM hasn't escaped the effects of a lousy economy; it has had to fire people, trim development, drastically cut travel budgets, even eliminate thousands of phone "squawk boxes." The next squawk you hear...

BOOTHE LIKES TERMINALS;
ANTES UP \$1 MILLION

Boothe Computer has upped its stake in the crowded CRT terminal field with an injection of funds into Courier Terminal Systems, two-year-old Phoenix firm, now headed by ex-UCC executive Ed Kearns. Kearns joined the struggling 55-man firm last November as it was about to run out of the original \$1.5 million investment by Boothe and three other firms. Boothe has now committed an additional \$1 million, raising its interest to 80% from 40%. Courier has been making the Executerm, a Teletype compatible terminal, and recently the E-60 and E-65 which are replacements for IBM's 2260 and 2265. Some 100 have been installed and the company is about to announce a \$500,000 order from a large bank in the Pacific northwest, boosting its backlog to \$1 million.

BERKELEY COMPUTER
IN BUSINESS FOR REAL

One of the companies most rumored to be going out of business in 1970, began 1971 still very much alive. Berkeley Computer Corp. says its big Model 500 time-sharing machine is now ready for customer use. It had been up and running since early last fall but needed software refinements. Now Berkeley says it's ready to talk with prospects. And the company expects by the middle of this month to announce either a merger or new financing which will make possible construction of a second Mod 500 and the development of the 1000, a production version of the 500 with twice its capacity.

IBM BOMBS
USER SUPPLY LINES

IBM scored a direct hit on both the peripheral and leasing firms by replacing the 2314 in the 360 and 370 lines with the 2319 for 20% \pm less. It was called a marketing coup. Both groups are adjusting their prices (see page 47). But one IBM-watcher called it an IBM "over-reaction." He thinks the Mean Gray Giant need not have undercut the competition to protect its disc market and that it should expect more anti-trust suits for "rule of reason" violations.

In effect, such a suit would require proving IBM, as the dominant factor in that industry, actually intended to--and indeed did--hurt competition through price cutting. The counter claim could be that IBM's intent was to create a larger disc market by making the drive more economical, the effect being a bigger pie to divvy up. The competition has countered with price cuts of their own that go about 10% below the 2319. But

LOOK AHEAD

EECO JABS AWAY WITH PUNCHED TAPE READER

the question is whether this is far enough below the new IBM price umbrella to attract users to mixed installations. Leasing companies who own an estimated 700 to 800 2314 systems, expect a lot of commission-hungry IBM salesmen to be calling at their accounts. Among other fearful expectations for '71: IBM will eliminate extra-shift charges on tape drives too.

The commercial market for punched tape readers runs \$30 million a year and is increasing about \$5 million annually, says Bill Fordiani, marketing director of Electronic Engineering Co. of California. He adds that this growth should continue for the next three to five years. The company this month will introduce still another product for this market-- the 8000 series reader and spooler, aimed at commercial punched tape applications such as teletypesetting and programmed test equipment. It handles up to 350 cps asynchronously and 750 cps synchronously, and operates with 70% transparent tapes. Paper tape lives.

DATA ENTRY FIRMS ENTER NEW PHASES

Inforex, of Burlington, Mass., is understood to have shipped more than 200 of its intelligent Key Entry systems in the U.S. and has others installed abroad through an agreement with Computer & Systems, Ltd., London. The company has formed Inforex Leasing Co.-- 40% owned by Inforex and 30% each by United States Leasing International, Inc., of San Francisco, and the St. Paul Leasing Co.

Also in the data entry business, Entrex, of Lexington, Mass., is shipping its first system to a New England-based insurance company and another system is expected to go to the UK soon. Although Infoton is well known as a crt manufacturer, the firm sees its real future down the line a bit with a data entry system using--of all things--an optical character recognition unit the company has developed. It has a working prototype and thinks an entire system could sell for as low as \$35,000. It could be out before year-end.

RUMORS AND RAW RANDOM DATA

Texas Instruments which has been firmly denying it has any interest in entering the general purpose computer market, recently published a brochure on its model 980, calling it a "general purpose digital computer." Meanwhile, TI's super computer, the ASC, may find uses in weather forecasting and air traffic control after it is operational in 1972 . . . The Greyhound vs. IBM anti trust suit may come to trial. The leasing company reportedly will appeal this month that it is ready to take IBM to trial, and ask that the action be returned to an Illinois court. A federal panel in December consolidated the complaint with a Control Data suit pending in St. Paul Federal District Court.

"YOU MEAN NOW I CAN DESIGN
A PRINTED CIRCUIT BOARD ON AN
EVANS & SUTHERLAND LDS-1 IN 3-D?"

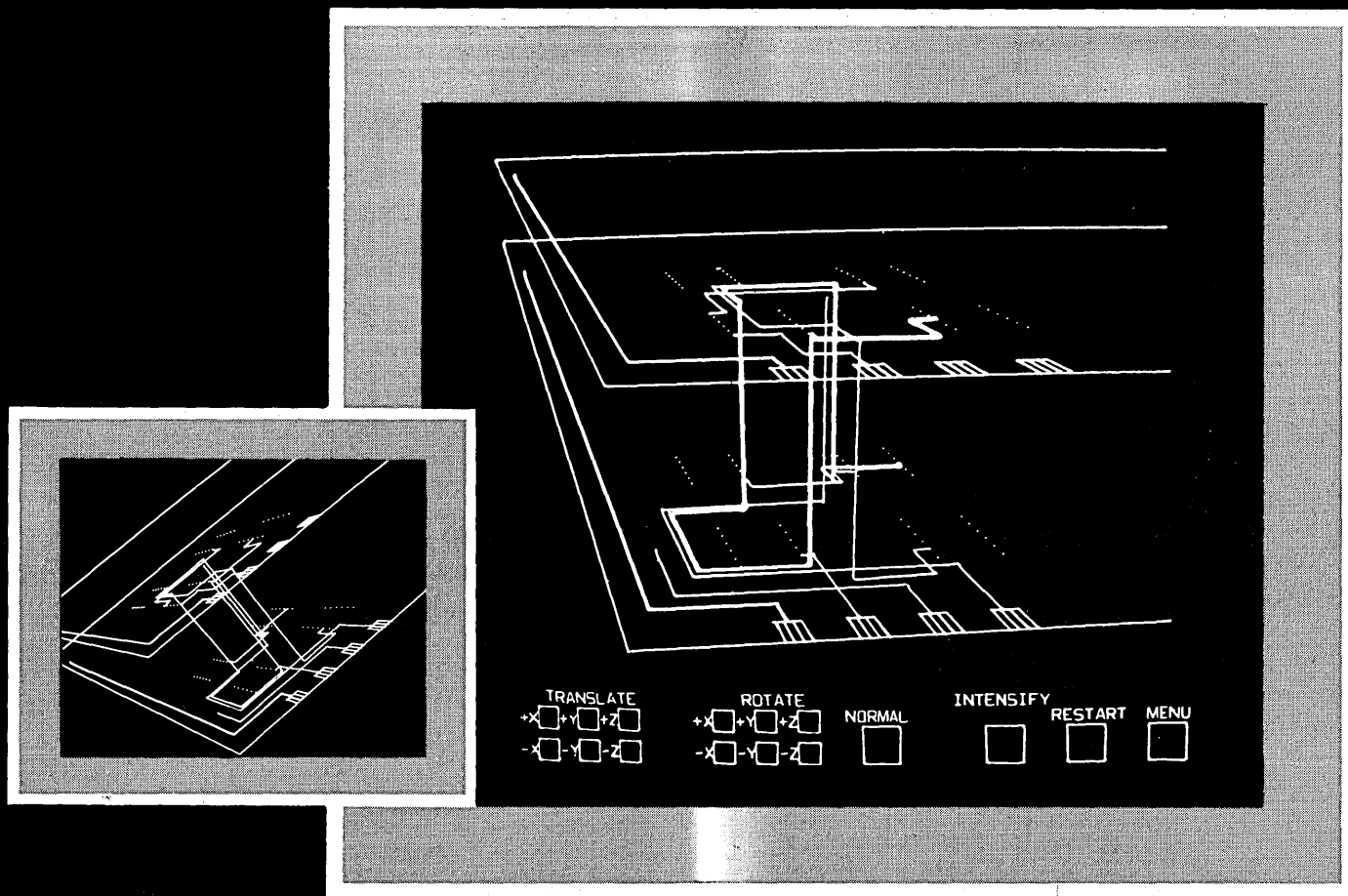

"AND E&S CAN INTERFACE THE LDS-1 WITH MY COMPUTER SYSTEM?"

If you design and produce printed circuit boards or integrated circuits from mask layouts, the Evans & Sutherland Computer Corporation's LDS-1 will save you money.

- Evans & Sutherland's LDS-1 computer graphics system, when added to your existing computer, lets you design circuit layouts directly on a scope. "Bugs" are worked out with your computer doing the calculating. With the Evans & Sutherland LDS-1 computer graphics system, hardware does the hard work . . . faster . . . easier . . . and at less cost!

- With the Evans & Sutherland LDS-1 computer graphics system, the hard

work is made easy. You zoom in and magnify dense sections of your layout. Then rotate or translate it, and add, check or delete runs with ease. With the LDS-1, you can place yourself inside a multilayered circuit and rotate it around you. The entire network between critical points is intensified by the LDS-1. Use of the third dimension, when needed, saves you time . . . effort . . . money!

- Further cost reductions are achieved by several designers using the LDS-1 with your central computer operating on a time-shared basis.

- Evans & Sutherland Computer Corporation provides the software to

interface the LDS-1 graphics system with your present system, both the hardware and software.

- Applications? Printed circuit boards in two or three dimensions. Engineering drawings. Mechanical layouts. Integrated circuit, LSI and multilayered masks. Simulation. What else do you need? Let's talk about it.

- For our literature package on layout design, write or call: Evans & Sutherland Computer Corporation, 3 Research Road, Salt Lake City, Utah 84112.

Telephone: (801) 322-5847.
The most sophisticated name in computer graphics.

EVANS & SUTHERLAND COMPUTER CORPORATION



How can you determine the best software package for your needs?

Look no further!

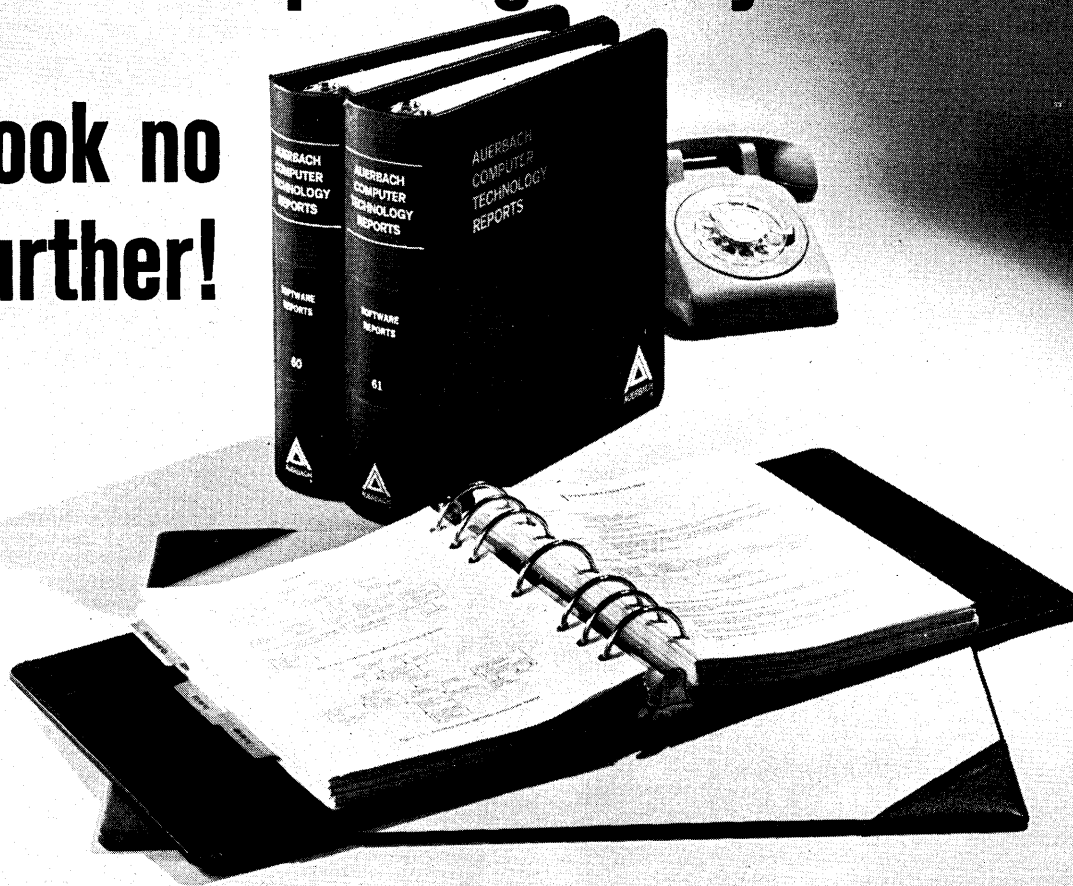

AUERBACH SOFTWARE REPORTS give you the facts you need to decide whether to develop a software system in-house or buy an existing one.

You'll save weeks of frustrating research. And you'll be able to justify your decision in much less time than it takes to make a wrong one.

It enables you to select the right package for your applications from the more than 3,000 proprietary software programs now being offered.

Business . . . Scientific and Engineering . . . Systems Software. Here are the facts you've been looking for, covering more than 20 application areas, such as:

**Inventory Control
Payroll
Accounts Receivable
Accounts Payable
General Ledger**

**Information Retrieval
Flow Charting
File Maintenance
Production Planning
and Control**

Definitional Reports and Comparison Charts show you hardware requirements, operational characteristics, programming languages, sources and availabilities—and the cost for each package!

AUERBACH Software Reports is a brand new loose-leaf reference service. It is up-dated bi-monthly, so you will always have the latest, most accurate information at your fingertips. For further details and sample pages, mail the coupon below.

AUERBACH Info, Inc.

121 N. Broad Street,
Philadelphia, Pennsylvania 19107

Please send me detailed information and sample pages from the new AUERBACH Software Reports.



Name _____ Title _____
(Please Print)

Company _____

Address _____

City _____ State _____ Zip _____

Phone _____

Signature _____

Information and Management consulting services available through AUERBACH Associates, Inc.

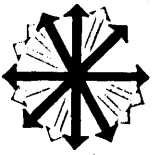

A Monster As Big As Life

Scientists who would "educate" the public by talking with mass circulation magazine writers may have had second thoughts after reading LIFE magazine's account of "Shaky, the First Electronic Person," in the Nov. 20 issue.

The writer, Brad Darrach, describes the gyrations of Stanford Research Institute's computer-driven robot which, he reported, rushed down a hall looking into four rooms before finding the right one, "as we hurried to keep up." Bert Raphael, one of the SRI scientists working on the robot, wonders why anyone had to hurry that day in May when the LIFE writer visited SRI, since Shaky was inoperative. All the writer witnessed was a movie made six months earlier, simulating what the scientists thought Shaky could be programmed to do someday. They admit it does perform three programmed functions, but it doesn't look into rooms or walk down halls.

Darrach, however, was not writing just about Shaky—but about a much bigger computer monster, one that would be upon us within three to eight years: "A machine with the general intelligence of an average human being . . . able to read Shakespeare, grease a car, play office politics . . . educate itself with fantastic speed. In a few months it will be at genius level and a few months after that its powers

will be incalculable." This he attributed to Marvin Minsky of MIT's Project MAC who, he says, "told me (this) with quiet certitude." Minsky, of course, has denied saying any of this. The professor did talk with Darrach of *human* intelligence. And he did warn that if a machine were developed with the capability to design other machines, we should stop it until we had adequate protection. He said nothing about a 3-8 year timetable.

According to Darrach, other experts on artificial intelligence offered the writer much more conservative predictions of 100 to 150 years (not reported in LIFE). The writer has also told us the article was revised several times so that the "average reader" could follow it "with care."

Although the article obviously is a piece of fantasy which should be dismissed as such, it does pose the question of whether and how leaders in the widely exposed computer sciences field should communicate with the public. Stanford psychoanalyst Kenneth M. Colby, who refused to be interviewed by the LIFE writer, says he talks only with science writers. Edward Feigenbaum of Stanford says he and Joshua Lederberg spent an afternoon with the LIFE writer because they were sensitive to the growing public awareness of the computer and this was a challenge to educate. "Then we were clobbered with this piece of

stupidity." Now, says Feigenbaum, "I'm nervous even talking with *Datamation*."

Silence may be the only defense against distortion. But one wonders if LIFE would have published such an article if more authoritative information had been available on the subject. John McCarthy of Stanford notes there is no consensus among the artificial intelligence community of its prospects. Nor, to our knowledge, has there been any briefing for the general press on the subject—such as a briefing on its limitations.

This, obviously, is because no one is organized to take on such an endeavor—or for that matter any other effort to help the press chronicle significant developments in computing. Much has been said of the need for professional societies, chartered to keep members informed, to take up the challenge of informing the public. The way to the public is through the press. Some faint efforts have been made. We hear a lot about a Computer Year and one society has asked Congress for a commemorative Computer Postage Stamp. But what society recently has provided a local newspaper with the name of an expert it can call for help in writing a story about a computer-related subject?

—Tom McCusker

It's time to change those personnel selection techniques we developed in the '20s

Job/Man Matching

M The two-and-a-half decades since World War II have seen the greatest technological revolution in man's history. Yet the ideas and techniques applied to industry's single largest problem—the recruiting, screening, and selection of manpower—developed in the '20s and brought to fruition in the Depression of the '30s, are still with us in the '70s.

The tremendous labor pool of the Depression decade permitted management the luxury of hiring one in twenty—the “most qualified,” perhaps in reality the most “over-qualified.” Still in widespread use, the techniques which suited the years of large labor pools are maladaptive in these times of full employment when a 5% unemployment rate is considered a dire sign of recession. The expensive symptom of this maladaptive set of employment practices is the high level of labor turnover among all classes of worker,

**The cost . . . is probably
billions of dollars
annually.**

but particularly among the semi- and low-skilled, both white and blue collar. It is estimated that today workers under 35 change jobs on the average of once in one-and-a-half years, while those over 35 stay on their jobs only about twice as long.

During the particularly tight labor market of the Korean War years, when employment at a General Electric Co. plant in Schenectady soared above 35,000, a management study of employee turnover revealed that in order to fill the “last 5,000 jobs” on the payroll 17,500 to 25,000 people were hired in one year! And this occurred a decade before the “discov-

ery” of the hard-core unemployed. In today's labor market, employer after employer has revealed that virtually every business has its own trigger point, that when employment passes a certain level an annual ratio of between 3.5 and 5.0 hires per job is not unusual. In one situation, an employer with whom we worked has a job category in which he experiences over 700% turnover per year. The cost for the entire economy—in recruiting, training, rework, scrap, union grievances, lower productivity, turned-off customers, low morale—is probably billions of dollars annually.

The problem is just as severe for the job-seeker. That people frequently seek and find low- and semi-skilled jobs on a hit or miss, trial and error basis has long been known. In simpler times it was possible for a job-seeker to have some knowledge of the content of many of the jobs he was likely to get—in these times he is fortunate if he knows the real requirements of more than a handful of jobs. So he searches by trial and error. And because it is relatively easy to get another job at about the same pay level, he tries and errs and moves on to another trial and so forth.

That management often tends to hire on the same basis, with little or no attention given to the work-content preferences of the people at low- and semi-skilled levels is—by definition—equally true; these people do not hire themselves. The Black Revolution of the '60s was as much a revolt against the irrelevance of the employment practices of industry as against any other single factor.

The National Association of Manufacturers was struggling with the oft-heard complaints of their members about the cost of turnover. At the same time that it was turning its social concern to the problem of hard-core unemployment, NAM, aware that it was dealing with two sides of the same coin, took upon itself the responsibility to develop a solution. In 1966, Richard Cornuelle and Wright Elliot led this effort through the Center for Independent Action. Michael

in the '70s

by Samuel H. Cleff and Robert M. Hecht

Youchah, computer and systems consultant to both NAM and to the New Jersey Department of Labor and Industry, was assigned by both groups to find a way to harness the computer to the solution of the problem of matching people and jobs. The NAM, at Youchah's suggestion, took the safest and wisest of research and

... a revolt against the irrelevance of the employment practices of industry ...

development approaches—two completely different solution directions at the same time and in parallel. The first was a computerization of the traditional extrinsic job labels, experience, education, etc., approach; the second was “way out,” scrapping all but the intrinsic essence of the traditional, using the computer as a machine tool.

The GE Missile and Space Division was asked to propose an r&d outline for the nontraditional approach. Under the direction of Louis Cimino, the division put together a conceptual approach and converted it into a proposal to NAM. Thus, in the spring of 1966, there began what was to be a most significant and successful research program into the manpower selection process, completely supported by private, nongovernment funding provided by NAM, Lilly Foundation and The Stern Family Fund.

The objective of the research was to determine whether and how jobs and job applicants could be matched at the semi- and low-skilled levels in both white and blue collar jobs to assure a higher degree of job satisfaction for successful applicants and, simultaneously, higher productivity and lower costs for

employers.

Underlying the research was a basic, common sense principle, long part of our industrial folklore but never verified scientifically and consistently ignored in practice by both people seeking jobs and employers with jobs to fill.

The principle is this:

In looking for work (as elsewhere in life), people seek out those activities in which they feel they are more likely to be successful. Conversely, they avoid those activities in which they feel less likely to be successful. Occupationally well-adjusted people—those who like what they do and believe they are doing it well—are significantly more likely to do a better job for their employers, and to stay on their jobs longer, than people who are occupationally mal-adjusted—those who do not like what they do and believe they are not doing well.

A broad cross section of 29 national and local employers in the Indianapolis area provided a variety of jobs to be filled and real life job situations for analysis. Seven Indianapolis employers¹ and the EDP Division of Honeywell, Inc., in Brighton, Mass., cooperated fully in a separate study (Project Indianapolis) to validate initial findings.

In all, the research and development program—formulation of hypotheses, experimentation, statistical analyses, verification—lasted some two-and-one-half years and produced two major results.

First, a universal “language” or common set of variables, was invented for *describing in identical terms* the actual activities content of *any* semi- to low-skilled job in the economy—and the actual activities previously performed and currently preferred by people who seek to fill that job (or who fill it now).

Second, the basic principle underlying the research

1. The Indiana National Bank; L. S. Ayres and Company; College Life Insurance Co. of America; General Motors Corp. (Allison Division); Indiana Bell Telephone Co.; RCA; and Western Electric.

Job matching . . .

was found valid. Occupationally well-adjusted people whose activities preferences and history match job activities requirements do tend to stay on their jobs longer and do tend to be identified consistently by their supervisors as "successful." Such individuals can now be identified accurately in advance through use of job/applicant profiles made possible by the universal language.

Male or female, black or white, urban or rural, high school graduate or elementary school drop out, hard-core unemployed or steadily employed—all can be described in terms of both an activities experience profile and an activities preference profile. Both profiles can be computer-matched against either white collar or blue collar job profiles written in the same language.

Further, this language permits mathematical comparison not only of job and job applicant, but of job and job (within and between companies), and applicant and applicant.

What follows is a brief technical description of how the Cleff Job Matching System was developed and how it can be applied to the mutual benefit of employers with jobs to fill and the applicants seeking jobs. Detailed statistical reviews of all reported findings are available in a technical paper.

Neither the employer who has gone through half-a-dozen hires to fill a single job satisfactorily nor the five misplaced previous hires need to be convinced that something is wrong with the system. In fact, a lot is wrong with it.

While Project Indianapolis was still in the early discussion stage, certain basic facts demanded recognition:

1. Not only was available research scanty, but no successful attempt had ever been made to build a system of organizing concepts which treated the field of human resources management in a systematic way, with experimentally testable solutions to problems faced daily by employers, employees and job seekers.

2. Job titles, which now total 42,500 as listed in the U.S. Employment Services' *Dictionary of Occupational Titles*, have more and more become social labels, and less and less useful in describing the job itself. Thus, a "building engineer" mops down the halls and a "fireman" on a diesel locomotive does—what???

For these and related reasons, it was agreed at the outset that standard hiring and job seeking methods, with their reliance on hope, hunch and tradition, had become increasingly obsolete. The research and development objectives for Project Indianapolis therefore were drawn as follows:

1. To investigate an analytical approach and develop the basic methodology for matching people and jobs at the low- and semi-skilled levels.

2. To validate these concepts and methods and to develop a mechanizable operational model for matching people and jobs at these levels.

A systems analysis approach was taken toward meeting these objectives. Statisticians familiar with Indianapolis were hired to develop representative samples of available jobs and chronically unemployed job seekers. With the help of the 29 cooperating employers, a sample of 57 open job categories was selected. Then social workers from Flanner House interviewed a sample of 150 chronically unemployed peo-

ple, black and white, male and female, who might be considered for those jobs.

Both the jobs (through incumbents and supervisors) and the job seekers were interviewed in depth. All interviews were taped and transcribed verbatim.

The interviews when analyzed produced an exhaustive sample of 2,400 human activities or behavioral units required on the jobs; and an even larger group of 3,500 behavioral units from the 150 people interviewed. It was then possible to attempt to develop a set of dimensions common to both pools of behavioral units.

All the behavioral units gleaned from the people interviews were initially grouped according to their relation to one of the three basic orientations common to all behavior: Things, People, and Ideas. This triad is as old as Plato and is also used by the U.S.

SAMPLE "DIMENSIONS OF WORK"

T—Things—behavior most immediately and directly oriented toward concrete things.

Examples:

T1. ATHLETIC

Job activities which immediately and directly involve the worker with things such that:

- ** he uses the large muscles of his body in hard physical labor
- ** he pays attention to broad overall results only
(dig ditches, shovel coal, load trucks)

T7. CORRECTION

Job activities which immediately and directly involve the worker with things such that:

- ** he corrects the quality in his own work or in the work of others
- ** he ensures quality performance of machinery and equipment
(set up machinery, repair parts and equipment, inspect work of others or self.)

P—People—worker behavior most immediately and directly oriented toward other people and animals

Example:

P3. MANAGEMENT

Job activities which immediately and directly involve the worker with people such that:

- ** he guides, influences, or directs the present and/or future ongoing behavior of others
- ** he takes or shares responsibility for results of that behavior, including their work
- ** there is high potential for emotional relationships
(train new workers, supervise workers, monitor or guard, hire employees)

I—Ideas & Information—worker behavior most immediately oriented toward ideas, symbols and information.

Example:

I3. CLERICAL

Job activities which immediately and directly involve the worker with ideas and symbols such that:

- ** he records or orders data of any kind
- ** processes paper work intended to do that
(file letters or cards, update stock records, keep records of transactions, etc.)

Department of Labor's *Dictionary of Occupational Titles*. About 60% of the behaviors from both sets of data fell into the Things-oriented category. Some 25% of the people-interview units and 30% of the job-interview units came under the Ideas category. The remaining 15% and 10% respectively, were grouped under People.

(To anyone familiar with the psychological testing done in vocational guidance and industry generally, this distribution is most interesting. Such testing usually is concerned primarily with Ideas, and while it is also concerned with People, very little testing is done in the Things area. This may help explain the low predictive validities of psychological testing in blue collar employment as well as the relatively high validities of such testing for largely clerical and administrative jobs.)

Subcategory definitions implicit in the data were discovered and defined for the behavioral units collected in the people interviews. Then these were used as the base for classifying the units from the job interviews. What resulted was a set of 16 "Dimensions of Work"—the language common to both men and jobs. Eight of the 16 dimensions pertain to Things and four each to People and Ideas (see box at left).

After months of sorting, testing, checking, and statistical scaling, we developed three basic tools—one for use with job applicants, the other two for use with supervisory personnel—based on the 16 Dimensions of Work and containing behavioral units collected from people and jobs.

Developed for job seekers was a Self-Interview Check List, a prepatterned, self-administered interview form. Applicants, unsupervised, go through the form twice in about an hour. First they indicate those units they like best and dislike most (i.e., what motivates them positively and negatively); then they indicate those they have done most and done least. When scored, two highly reliable applicant profiles result: one describing activities preference, the second activities experience, arranged according to the 16 Dimensions of Work.

For supervisors of jobs to be filled, we developed a Job Outline Check List and a Job Card Sort: both are completed in about half an hour with the help of a personnel representative, methods man, or industrial engineer, as appropriate. The check list describes the specific requirements of the job. The card sort describes the job in general or global terms and serves as an internal consistency check on the specific job profile. An accurate profile of job requirements, both positive and negative, results. The profile then can be matched with the profiles of applicants for the job.

Fig. 1 shows the profiles of applicants for these jobs. Fig. 2 (see page 26) shows the experience/preference profiles of successful applicants for these jobs.

The two person profiles in Fig. 2 are each excellent matches for a different one of the two job profiles shown in Fig. 1. They are each classic mismatches for the other job.

What was learned initially in Indianapolis and subsequently validated in Indianapolis and Brighton was that the closer the person/job match and the higher the preference/experience correlation the better the hire—from the viewpoint of employer and employee alike.

By November 1967, we were ready to test the basic organizing principle underlying these efforts—namely, that *occupationally well-adjusted people who are well-matched to their jobs tend to do a better job for their employers and to stay on their jobs longer.*

These tests were conducted in both Indianapolis and Brighton. In Indianapolis, the participants were 7 employers and 177 of their employees from 23 widely varying white collar and blue collar jobs: bank teller, electronics assembler, sales clerk, buffer machine operator, computer operator, telephone repairman, and others from factory, retail establishment and office. The employees had to have two things in common—relatively long service (9 months to 20 years) and average or better ratings by their managers for on-the-job success.

In Brighton, Honeywell's EDP Division selected 113

JOB PROFILE #1. Receptionist clerk-typist in bank.

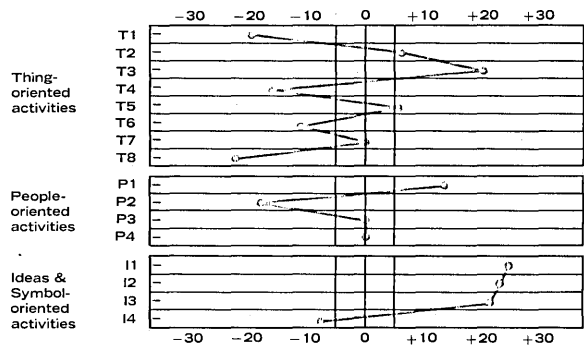

JOB PROFILE #2. Electronics assembler, TV manufacturing plant.

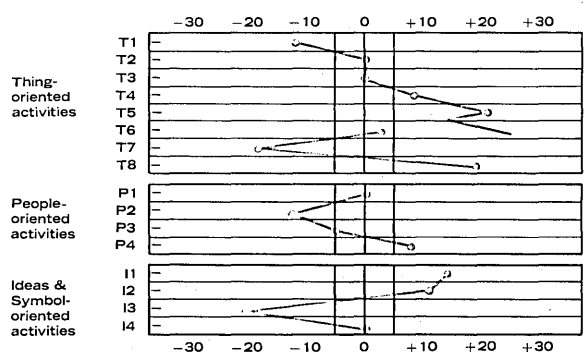

Fig. 1.

people who made up 12 job groups of 7 to 13 individuals each. Four of the groups were regarded by management as unstable, eight groups were considered stable.

Job Outline Check Lists were completed by supervisory personnel for all jobs involved at both locations. Self-Interview Check Lists were completed by all 250 employees, about a third of whom were asked to complete them again one to four weeks later. These lists were administered by briefly trained personnel people, in order to simulate operational conditions.

In both Brighton and Indianapolis, all participating employees also completed a data sheet which included three scaled questions concerning perceived success on the job:

1. How well prepared were you to your job, in comparison with your fellow employees?

2. What are your chances for promotion in comparison etc.?

(Continued on page 26)

Job matching . . .

3. How good a job do you think you do in comparison etc.?

The experiment was completed over a four-month period. As data came in, the check lists were scored

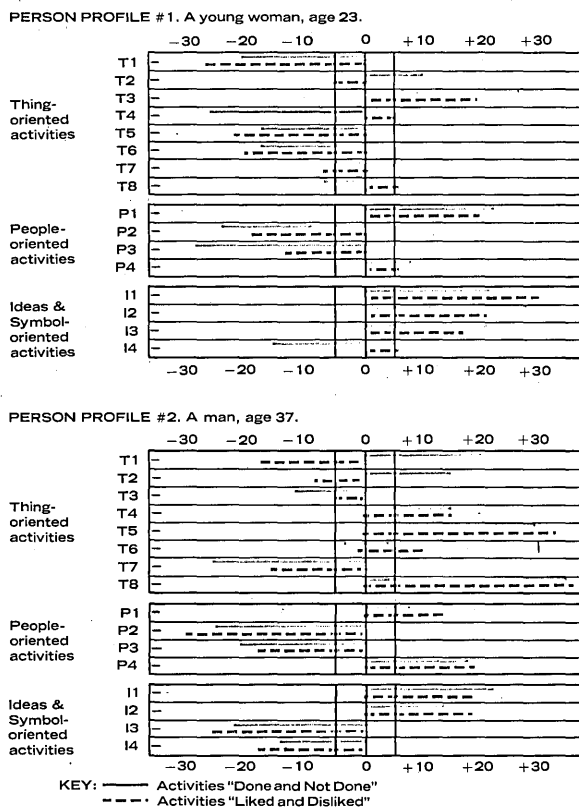

Fig. 2.

and every response recorded. Statistical analyses were done by computer. The evidence clearly supported the hypotheses that:

1. For long-term employees regarded by their managements as successful on-the-job, there was a consistent and very significant positive correlation between the employee's self-reported activities history and the management-described job requirements.

2. Management had rated each employee's on-the-job success as average or higher; when employee self-rating was similar, self profiles and job profiles matched much more closely than where success ratings disagreed.

3. At Honeywell, where no criteria for successful performance were used to differentiate between workers: zero order person-to-jobs matches in almost every case identified members of "unstable" work groups which had consistent and continuing high employee turnover, while matches in the stable groups were significantly higher.

4. Reliability of the profiles generated by the Self-Interview Check List in the test-retest experiment was exceptionally high, with a median interprofile correlation of $+ .93$ for activities experience and $+ .88$ for activities preference.

Analyses of the Indianapolis and Honeywell results led us in our development of the operational model. For example, we found that employees who considered themselves average or above on the job, and had average or above preference to experience correlations, weighted preference and experience in a sys-

tematically different way than those who were below average on both measures. We also discovered that the specific requirements of the job were weighted much more than the values derived from the general description of the job. Our computer systems model takes these factors into account. The system uses the better-matched, better-adjusted, higher-evaluated workers as a model.

Job profiles and applicant profiles are compared by correlation for similarity, and by a difference statistic to control for major differences. The correlation compares the shapes of the profiles and is partially controlled by the real zero center of the profiles. The difference measure compares the extent of divergences between sets of profiles of near-similar shapes. The computer can search a file of hundreds of jobs or of people according to these analytic search strategies in seconds.

Three important facts are provided each time an individual person is matched to a "bank" of profiled jobs by the computer, in real time via time-shared service:

1. A Preference to Experience Index,
2. A Person-to-Job Index, and
3. A Difference Index for each Person-to-Job comparison.

Fig. 3 (see page 27) shows a typical print-out, with these indices noted. In order to be screened into a job the applicant should have each index at or better than a company-determined score. The jobs are printed out in rank-order according to either of the person-to-job indices. As in any referral-placement-selection situation, the efficiency of the system increases with the number of people and the number of jobs with which they are matched. The system will go either way—it will match people profiles against a job file or job profiles against an applicant file.

Typically, a company stores 20 to 30 job categories, those representing its highest turnover, and matches applicant profiles against this file. Obviously it is also less expensive to store the usually smaller number of job profiles than the larger number of applicants. Paper tape storage for relatively inactive files is possible and can be loaded into the computer when neces-

... correlations with four to five times the predictive power of the "normal" psychological test battery . . .

sary. In a placement service such as an employment agency, private or public, it makes sense to store the profiles of active job-seekers, matching employer requests (in the form of job profiles) against this people register, removing the person's profile when he has been successfully placed.

What have been our validating experiences? The experimental validation study done in Indianapolis and Brighton developed average people-to-job correlations with four to five times the predictive power of the "normal" psychological test battery validations with similar work groups. We have followed up some

of the Indianapolis subject-groups two-and-a-half years after original data collection. In a bank, an insurance company, and telephone company (a total of about 85 employees) we found that higher-matched employees had from 150% to 250% more months with their companies than did those who had below average matches. In a one-year study at a large supermarket chain, where we studied 30 "standard"

```
JANE DOE
147-18-4906
JOB APPLICANT
EXPERIENCE PROFILE
-8 0 0 -4 -8 4 -8-13 12 12 1 -1 2 3 2 4
PREFERENCE PROFILE
-13-13 6 0 -7 -3 -4 -7 10 10 4 1 3 7 4 5
COMBINED PROFILE
-10 -6 3 -2 -7 1 -6-10 12 11 3 0 3 6 3 5
SUITABILITY OF PREF. TO EXPR. IS 0.7467

      8 PROFILES ABOVE MINIMUM
HOW MANY DO YOU WANT TO SEE? 5

SUITABILITY INDEX IS 0.7062
DIFFERENCE INDEX IS 782.
OPERATOR
ABC COMPANY
JOB PROFILE
-11 -9 10 -2 -5 -8 -3-15 17 2 2 5 22 0 11 1

SUITABILITY INDEX IS 0.6390
DIFFERENCE INDEX IS 991.
COUNTER CLERK
ABC COMPANY
JOB PROFILE
-17 -1 -2-16 -3 -2 -6-15 13 -3 2 10 15 12 14 -1

SUITABILITY INDEX IS 0.4183
DIFFERENCE INDEX IS 1402.
SUMMARY CLERK
ABC COMPANY
JOB PROFILE
-11 4 10 -8 -3 -2 10-16 6 -8 0 1 13 15 20 4

SUITABILITY INDEX IS 0.3213
DIFFERENCE INDEX IS 1480.
AUTOMATIC OPERATOR
ABC COMPANY
JOB PROFILE
-16 -1 12-12 2 -2 10-13 5-12 0 3 16 5 12 0

SUITABILITY INDEX IS 0.1372
DIFFERENCE INDEX IS 1773.
TECHNICIAN
ABC COMPANY
JOB PROFILE
-12 -4 14 -8 -1 7 19 -5 -3-12 0 1 12 10 7 7
```

Fig. 3.

long term successful employees and 35 "hard-core" employees, we found much the same thing. Among their standard employees, those with above average matches were with the company four to five times longer than those with below average matches. In the "hard-core" group, six-months turnover was 78% for below-average matches, 44% for above-average matches. In Charlotte, N.C., where the Cleff Job Matching System (CJMS) is being used to place largely semiliterate black farm-hands in traditionally white industry, with a very small job bank, the hire to referral rate is about 75%—with retention at about 70% after 90 days. The system has recently begun to refer ghetto dwellers in Newark, through the Business & Industrial Coordinating Council, into a job register of only 50 job categories representing some 200-250 openings.

The pressing need for a workable and holistic, but analytical, job matching system has been demonstrated over and over again by the many fascinating applications which others have suggested. We are now experimenting with some of these suggestions. For example, in cooperation with New Jersey Rehabilitation Commission, we are using CJMS for some of its clients. We developed a procedure for analyzing

a client's physical and emotional capacities and incapacities using the same 16 Dimensions of Work. This provides a vocationally functional profile of the rehabilitation client. A job register containing some 250 job profiles, developed for New Jersey Employment Service, provides a large sample of jobs against which the set of person-profiles are compared. Both client and counselor then have a set of real jobs to which a client may be referred or which can serve as a realistic basis for planning vocational rehabilitation.

Working with a county vocational school system we are planning to use the system to profile industry examples of trades for which students are trained. This sample can be compared to the profiles of the courses themselves for guidance in adjusting them to industry's requirements. And, of course, student guidance and placement is an obvious spin-off.

Management people we've spoken to have asked us to use the system for comparing jobs and building job hierarchies and development ladders. Others have suggested using it to select cadres for new production lines or as an industrial engineering tool for constructing jobs which match the present work-force. The list of suggestions goes on and on. Our response is simple: we believe that the system can help do those things, but we do not know if it can. CJMS is certainly no panacea for all of our human resources problems, but the available evidence suggests that it is worthwhile to test it in these roles. ■



Dr. Cleff is vice president of research and development of ADP Personnel Data Systems, Inc. Previously, he worked at the Center for Independent Action where he conceived, researched, and developed the operational man/job matching system. He received his doctoral degree from the Univ. of Pennsylvania.



Mr. Hecht is vice president of marketing of ADP Personnel Data Systems, Inc. He is a former faculty member of the City College of New York and Bronx Community College, where he was also coordinator of institutional studies. A member of the American Psychological Assoc., he is co-author of the booklet "Interviewing Techniques for the Non-Personnel Executive."

A practical plan to vary the reward diet of your employees

EPIC: New Cafeteria

by Jay R. Schuster, Lewis D. Hart and Barbara Clark

M There has been much talk recently in computer oriented firms about "cafeteria" or "supermarket" compensation. Such systems let employees choose the forms of compensation they want from several alternatives.

In order to stimulate creative thinking in this area, we want to share the results of some work we have done. We will discuss why we think "cafeteria" compensation systems will be instituted; what they will do; and, briefly, how we think our developmental system, called the Extended Program for Individual Compensation (EPIC), can meet these requirements.

Much research on the motivational role of compensation has been conducted by contemporary behavioral scientists. Results suggest that individuals are motivated to perform by different forms of rewards. Preferences for forms of rewards vary according to personal characteristics. These preference differences led us to conclude that organizations would get more motivational mileage out of employee compensation if they would determine the kinds of compensation that employees want and give it to them in exchange for performance the company wants. This conclusion is fundamental to EPIC. In other words, if an organization is content with traditional compensation forms, or if management says, "I know what is best for my people," a system like EPIC is not for them.

Existing systems

To distinguish EPIC from other "optional" compensation programs, we might mention these programs briefly, especially since we stole some of their principles. At present, there are three major attempts in this area: individual estate planning, compensation choices at the time of hire, and choices within a single form of compensation.

Individual estate planning schemes provide for someone, usually an external consultant, to meet with

and confidentially discuss the individual compensation needs of senior executives in an organization. Based on this discussion and the consultant's knowledge of compensation, a "custom built" program, made up of deferred pay schemes, life insurance plans, etc., is built for the individual executive. Such a program is intended to keep the executive happy with the company. This kind of undertaking is very costly in both employee and consultant time and, therefore, is usually used only for people at the very top of the organization. Although the estate planning concept is good, such "personal treatment" is impractical for other than the most senior executives. This means that money spent to compensate rank-and-file employees is not used in a manner responsive to their preferences.

Compensation choices are sometimes offered when an employee is hired. For example, a new man may be given a choice from: a higher base pay and an average sized life insurance plan, a little less pay and a slightly better life insurance plan, or substantially less pay and a lot more life insurance. These offerings do not usually change during the term of the employee's service. The most obvious problem is that the original choice is not responsive to the changing needs or preferences of employees or the firm.

Some firms offer a single benefit with several variations from which employees select. For example, a stock savings program often enables the employee to elect from several kinds of investment for his and the company's contribution. Choices often include putting all the money in the company's stock, half in company stock and half in some sort of bonds, or half in company stock and half in a diversified stock fund. The problem here is that in many cases the employee is selecting between alternatives he did not really want anyway.

EPIC differs from these schemes. It is a system designed to find out what form of compensation

employees want, and provides a way to give it to them in exchange for something wanted by their employing firm: loyalty, performance, or whatever represents the firm's needs.

Under EPIC, employees choose between several compensation alternatives including base pay increases and benefits improvement. Therefore, they must understand as much as possible about the financial impact of each alternative on their personal situation. The same number of dollars spent on life insurance for one individual may not be as effectively spent as it would be on another because of differences in age, number of dependents, etc., which cause insurance premium rates to vary.

A constant context

For alternatives to be offered in a constant context, preferences from which management will make its compensation alternative offerings are communicated

contains all the intended compensation alternatives is used. The questionnaire also gathers such data as name, job title, years of service, pay level, etc. This information establishes the characteristics of individuals and is validated against the using organization's personnel data base so that the "start-up" personal information is accurate. With the questionnaire goes a booklet showing the employee how to apply the unit value evaluator to each of the initial compensation options offered to him. For example, for each type of life insurance that could be offered, the booklet shows on a matrix the unit effectiveness at each age level, pay level, etc. From this he can choose options which get the most mileage out of the dollars at his discretion.

Preferences are gathered by age, pay level, performance level, etc., in order of importance so that not only the most preferred options can be determined, but also those having second and third order importance. This is important to later offerings made

Compensation Plan

to employees in terms of "relative unit effectiveness."

To arrive at "relative unit effectiveness," actuarial formulas are used to build an evaluator for compensation alternatives. Since people are involved, we couldn't assume they would understand and apply complex algebraic formulas to their individual characteristics and compensation package, and then reach a valid decision. To make understanding easy we substituted "unit value" for dollars in discussing, computing, and communicating the compensation program's components. A dollar value is placed on a unit before the first offering of compensation choices. For example, a unit starts out with a value of \$1. Everything to do with the system is related in terms of unit effectiveness—i.e., a unit of a firm's expenditure on compensation is offered in three forms of compensation: A, B, and C. For a particular individual, a unit of the firm's money spent on alternative A might benefit him 1.75 units, spent on B, 1.80 units, and on C, 1.05 units. The conversion of unit values for employee information enables him to judge relative value of alternatives in terms of current and future dollars, and relates the "purchase" of compensation alternatives to something he can understand.

Because tax rates vary, the formulas take into consideration the impact of taxes on each alternative offered. By use of special purpose computer programs, the system handles changes in tax rates, age, pay level, and other variables impacting the compensation alternative selection process.

It is interesting to note that individuals do not necessarily select the compensation alternative with the greatest unit value. This simply reflects individual preferences within a group with like characteristics.

The first step in the actual installation of the system is to establish the compensation preference patterns of employees. This provides the "start-up" data base to which all future election opportunities will be related. To gather preferences, a questionnaire which

after the offering of the most preferred alternatives and is one of the means by which preference changes are incorporated into the system.

The unit evaluators computed from the formulas are incorporated into a computer simulator program. This program relates preference patterns, actuarial computations in terms of units, and the characteristics of the individuals to be offered the election opportunity. The organization's management is provided with the distributions of the characteristics of employees who reflected various preference patterns, and the potential unit cost of the alternatives. Management then determines the preferences of the groups of people it considers most important, and can ensure that these groups' preferences are included in the offerings. For example, let's say that good performance is valued by management. The preference patterns of the best performers can be identified and taken into consideration in designing the options to be offered. Management can in this way isolate preferences of its most important employee groups.

Most desired combinations

The simulation program is run through the most desired combinations of alternatives to inform management of the probable costs of these packages, and the numbers and types of people who would be likely to select them. Management then determines the composition of the choices it will provide at the first employee offering. These groups of compensation alternatives then become "optional modules." For example, module A might be made up of so many units of company investment in life insurance and so many of sick pay; B, so many units of additional contribution to a stock savings plan and so many in more liberal medical payments; and C can offer more vacation time, a pay raise, and a parking place nearer to the employee's place of work.

(Continued on page 30)

Compensation Plan . . .

The computer generates a document explaining the optional modules being offered in terms of the employee's individual characteristics carried in the data base of the system, and indicates to him the unit value of each module as it relates to him. The employee is given a short time (usually two weeks) to make his election and return it for computer processing. His choices are good for a period of time set by the organization's management, but probably for at least a year. New employees are given the election form and explanatory document when the management of the organization designates their eligibility for participation. This procedure is also used when employees are given an opportunity to choose from a new set of alternatives, or to change their present choices. Periodically, certificates are issued to participating employees to show what he had elected during the period, and also, by applying the unit evaluator, what his current compensation program is worth to him.

The computer generates periodic reports to management regarding the status of the program, how money is being spent on total compensation, etc. It also serves as an information point by providing reports of benefits elected, as well as individual election information for carriers, such as external benefits brokers.

Salary review

At management's option, the organization's annual salary review process might be included in the system. In this case, the usual process of individual performance appraisal is conducted and a number of dollars for salary increase purposes is established for the individual. The employee could then be offered an opportunity to accept the salary increase or spend the money on an offered alternative to a pay increase, such as a benefits improvement, if this more closely meets his needs. In this case, the system would show him the relative financial effectiveness of an increase in pay compared to other alternatives he might choose.

Assuming that the better performers get the largest increase in pay and these alternative can be used to "purchase" other, more desired alternatives, the best people would be getting more of what they want from the company in return for performance consistent with the organization's objectives. Hopefully, this would make good performance more worthwhile to the individual. Such a system lets the using organization offer choices to employees in two areas of compensation expenditure: the money the company would spend on salary increases as a part of the regular salary review, and the money they would spend to improve "everybody's" fringe benefits program.

What's the payoff?

The organization has a record of its compensation allocations, their distribution across the company, and the direct costs, from reports provided by the system. The system provides the organization with objective data derived from its own environment. Assuming EPIC is run by a central agent with numerous using organizations, the company can also compare its position in the competition for good performers with that

of other firms in the system. The system issues certificates to employees that outline their current total compensation program. This probably adds stature to the company compensation alternatives, making them seem more tangible.

The employee benefits from EPIC since he has the opportunity to "purchase," at group rates, designated compensation alternatives he might otherwise secure individually at greater cost. It also gives him a compensation program he wants rather than something his organization thinks is best for him.

By electing among alternatives, the employee is sensitized to the choices he might make. This contributes to his sense of long-range compensation planning, and allows him to optimize his decisions.

In a future study, it will be interesting to evaluate the impact of such "cafeteria" compensation planning systems on individual behavior, represented by the preference patterns over time. Such an undertaking will provide an opportunity to test a considerable number of dimensions of what behavioral scientists say about compensation practices. A developmental system like EPIC can serve as a model from which other such systems can be built. We hope the builders of the next generation of such systems will respond to needs and problems uncovered by analysis and critique of a system such as EPIC. ■



Mr. Schuster (left), is manager, compensation planning at System Development Corp. in Santa Monica, Calif. Prior to his association with SDC, he was a member of the personnel staff of TRW Systems and Xerox Corp. He has published numerous articles in the field of organization and compensation and served as a consultant in these areas.

Mr. Hart (center), an associate of the Santa Monica-based management consultant firm of Coleman and Associates, is currently specializing in consulting support and the building and marketing of programming architecture, hardware configuration analysis, and management systems. He has had diversified experience with such firms as SDC and Xerox Data Systems.

Miss Clark (right), is a member of the compensation staff at the Automobile Club of Southern California. She was formerly a compensation analyst at SDC, where she was a member of the team that developed and conducted national salary surveys of the computer programming, human factors, and operations research professional groups. Miss Clark has published a number of articles in the compensation field.

OCR

from Plessey

How does it affect you?

The first Plessey optical character reader has been designed primarily to handle turn-round documents. It reads 'B' font characters at speeds up to 3,000 per second using a detection system capable of recognising relatively degraded print.

The character repertoire of the Plessey OCR-B is 0-9, E,H,K and R. It can be used on—or off—line. The reading head can be fitted to most conventional document transports. There are built-in test facilities to speed servicing and reduce maintenance downtime.

How does it affect you? Significantly, if you're in the turn-round document business. Fill in your name

.....
and address

.....
and send this coupon to the Sales Manager (OCR),
Plessey Electronics Group, Sopers Lane, Poole, Dorset,
England BH17 7ER. Then you may have
made the first step towards saving time,
money and effort in processing documents.



Plessey Electronics

Plessey Incorporated, 767 Fifth Avenue, New York, NY 10022

**An algorithm to
get the most out of
your minicomputer**

Optimizing Assembly Program for Minis

by David E. Ferguson

T Minicomputers invariably provide some sort of abbreviated or "short" addressing. This might take the form of base addressing, page addressing, relative addressing (particularly useful for branching), or any of a number of other addressing techniques. These techniques all use a short address field, normally 7, 8, or 9 bits, so that an entire instruction can be contained in 16 bits. Obviously this precludes all of memory from being addressable by a single instruction. Many computers avoid this obstacle by also providing a full or "long" address form of the instructions which usually take 32 bits. Clearly the short form takes less storage and, in addition, is normally faster. Therefore, in programming such a computer the programmer will try to use the short form where possible and will otherwise use the long form.

Therein lies one of the major problems in programming minicomputers and one of the greatest sources of error. Namely, the programmer must select which mode is to be used. This is sometimes quite difficult to do. Worse yet, subsequent modification to a program can introduce errors into previously working code. These errors take the form of attempting to address a location with the short form when that location is out of range. The converse problem, that is, using the long form where the short form could be used, although not an error, introduces inefficiencies into the program.

A technique whereby the assembler makes these decisions is presented here. Furthermore, with rather minor constraints, this method will produce an optimum assignment. Since these assignments are not made until assembly time, modifications to a program (reassembly) cannot introduce new errors. The term "optimizing assembly" as used here is unrelated to certain first generation assemblers which used the term to describe the assignment of instructions to nonsequential locations on a disc or drum.

Restrictions

Two restrictions are introduced here in order to simplify the following description. These will be discussed in more detail later.

The first restriction is that the location counter increases monotonically; that is, the location counter

is never reset to a lower value than its current value. It is not unusual for programmers to do so, however. The motivation for doing so is to define overlapping data storage and to insert code (normally initialization code) into a buffer which will not be used until later.

The other restriction is that there are no boundary alignment requirements; that is, it is never required to set the location counter equal to some value modulo some other value. Some byte addressable computers require certain data and instructions to be on an even boundary or a multiple of four, etc. This is rarely encountered on minicomputers.

An optimizing assembler

Although a detailed specification cannot be given here, a general description of an optimizing assembler will be. Unlike a conventional assembler, an optimizing assembler cannot assign values to labels in the first pass since address references are encountered which may be either short or long. The assembler may not be able to determine whether or not a short address can be used because this may depend on how many other undetermined addresses exist between the reference and the location referenced (or between the reference and the base, etc.). Instead, the first pass assigns a two-valued vector to each label which might, because of obvious similarity, be referred to as a "complex" value. The "real" part refers to the number of definite increments to the location counter, or its "minimum" value, and the "imaginary" part refers to the number of undetermined address references encountered, or its "uncertainty" value. At the end of the first pass a symbol table of complex values has been produced.

Before going on to the following passes, a word about expression evaluation. One of the requirements of an assembler is to evaluate expressions. Evaluating complex expressions is not much harder than evaluating scalar expressions. The sum or difference of two complex values follows the rule of conventional complex arithmetic. Adding (or subtracting) a scalar to (from) a complex value involves adding (or subtracting) the scalar to (from) the real part. Multiplication and division of location values is not normally permitted with relocatable assembly values.

The second pass attempts to determine all undetermined address references. This is done by computing the short address required assuming maximum uncertainty (complex arithmetic) and assuming minimum uncertainty (imaginary part zero). If a short address is possible using maximum uncertainty a reference is decided to be short. If a short address is not possible using minimum uncertainty it is decided to be long. Otherwise it is undetermined. Undetermined references are collected in core in the second pass.

Resolving these references is inherently an iterative procedure since one or more undetermined references may exist between a reference and the location referenced. The intervening undetermined references may, in turn, depend on still others or, indeed, on the first one. Clearly an iterative pass over the source program would be impractical. On the other hand, it will normally be impossible to keep the source in core.

However, in real programs very few references are undetermined. Most references will be either long or short regardless of what the remaining references may be. All that is necessary is to keep the undetermined references in core and to do an iterative assembly on these references. Furthermore, in actual practice, very few iterations are required; six iterations would be considered high. Note that no input or output is associated with these iterative passes. These passes are made until a pass is made in which no undetermined references are determined.

At this point, one of two situations exists. Either no undetermined references remain or else some do remain. In the first case, which is quite unlikely, no uncertainty remains, and the final or generative pass is made (over all of the source, of course).

In the second, or most likely case, what is to be done about the remaining undetermined references? Nothing will be resolved by further passes. However, none are needed; *all undetermined references are short!* This "uncertainty principle" for assembly programs may seem remarkable at first but can be shown in the following manner.

If a pass is made which cannot determine any undetermined references but some still remain, then those remaining undetermined references must comprise one or more sets of interdependent relationships. If there is more than one set, the argument for one set can be applied to each set; therefore, assume there is just one set. Choose one reference in the set, and assume that it is short. The fact that it was undetermined guarantees that this is possible since by the definition there exists some set of conditions which make this possible. However, *choosing this reference to be short cannot force any of the remaining references of the set to be long.* This cannot increase the distance between any reference and its base (be it a base register, page origin, location counter, etc.). Hence it either leaves the remaining reference of the set undetermined or causes one or more of them to be short. If any references of the set remain undetermined, this can be repeated for the resultant set which contains at least one less number. Ultimately, repeating the argument will produce a null set.

Consequently in either case, once a pass is made which does not determine any undetermined references, the final assembly pass can be made. Actually

the final pass can begin as soon as a pass is made in which no previously undetermined references were determined to be long. This can be seen by making minor modifications to the above argument.

The restriction that the location counter be monotonically increasing poses no real problem. It was imposed in order to preserve the rules for evaluating complex expressions. If storage is not overlapped, these rules are still valid. Furthermore, if data storage (not instructions) is overlaid with other data storage, or even with instructions, the rule still applies. Only if instructions are overlaid with instructions can conflicts be introduced. But this represents an error unless chain assembly is permitted. This restriction could be relaxed to say that instructions cannot be overlaid with instructions.

The elimination of boundary alignment requirements was necessary to guarantee the statement that "choosing a reference to be short cannot force any of the remaining references of the set to be long." This rule breaks down when boundary alignment considerations are made since choosing a reference to be short will move up following locations but may not move up some following reference due to a boundary. Although the boundary alignment problem can be solved, it is rarely encountered in minicomputers.

Conclusion

It was mentioned that the first pass of the assembly made two valued definitions of the labels and that the second pass collected the undetermined references. The reason that the undetermined references were not collected on the first pass is because during the first pass all forward references would be undetermined, giving an inordinately high number of such references. Therefore, the optimizing assembly process is a three-pass operation, at least as far as input passes over the source is concerned. However, neither the first nor the second pass produce any output, so that this represents a rather efficient assembly process.

The function of an assembly program is to simplify writing programs in computer instructions. Since addressing considerations are one of the most troublesome aspects of programming a minicomputer, anyone responsible for producing an assembler should consider developing an optimizing assembly program. ■



Mr. Ferguson is president of Programmatic Inc., a Los Angeles based subsidiary of Applied Data Research, Inc., of which he is also vice president. Mr. Ferguson has been active in software since 1957, when he graduated from UCLA with a BA in mathematics. He has previously held positions with Computer Sciences Corp., Western Data Processing Center-UCLA, and the Service Bureau Corp.

Concerning the nature of the game

De Ludi Natura

by Lucian J. Endicott, Jr., and Peter H. Huyck

G If you tell someone that you are a programmer, you may be asked, "What do programmers do?" If you reply by explaining that machines can only do what they are instructed to do, etc., you perform a double disservice to your profession. First, you introduce an oversimplification which misleads people about the symbol manipulation capacity of modern computers, and second you give the impression that you are some sort of minor bureaucrat. (Regrettably, many programmers

A program is a map of one state of a machine into another . . .

think of themselves as just that.) If, on the other hand, you reply that you design computers, you immediately win respect and admiration. However, this answer is also misleading, and it is difficult to explain to a layman how a program completes the design of a computer.

By far the best answer is, "I design information." This is the most accurate statement of the programmer's function, and it will stimulate your interlocutor's curiosity. The phrase "information design" strikes one as odd at first. We do not think of a hydraulic engineer designing water, but rather pipes, valves, and processes. But a programmer designs information with other information, which results in further information; there is no other manifestation of his work.

The problem with this reply is that you may then be asked what you mean by information, and that question is somewhat more difficult to answer.

This paper approaches programming from three different perspectives, with the aim of putting new intellectual equipment at the disposal of programmers. The first section discusses the convergence of the disciplines of designing computers from an engineering point of view and designing computers from a programming point of view. Suggestions are provided for ways in which the two disciplines could each benefit from the experience of the other. Then an introduction to the work in design done by Herbert A. Simon of the Carnegie-Mellon Institute is presented. Finally, an attempt is made to suggest

areas for investigation which may eventually lead to a formalized theory of programming, followed by a short bibliography with which programmers should be familiar.

Our goals, for developing this paper were to stimulate new ideas and encourage professionalism in programming. We are not speaking here of professions in the normal context—where a professional's income is based on the client relationship, and professional status is determined by fellow professionals. Neither engineers nor programmers qualify as professionals by these criteria, with the exception of consultants. When we talk about professionalism we mean certain qualities developed in the professions and certain differences which characterize the type of activity of those who enter the professions. From his knowledge of something, the professional designs to some purpose, be it health, acquittal, or whatever; this distinguishes him from artists, who create, and scientists, who discover.

Engineers, in designing computing machinery, have progressed from hardwired circuitry to read-only storage to read-write coding techniques. At each stage in the development they have considered themselves to be designing computers with the most eco-

From his knowledge of something, the professional designs to some purpose . . .

nomical and powerful technology available. A study of the most recent technology reveals that in many respects engineers are involved in activity identical to that of programmers. Both professions have been involved in designing information, and any designer who has progressed from the hardwired circuits to the new coding techniques is aware of the exact logical equivalence of a pulse in a latch and a flag in a control block.

A program is a map of one state of a machine into another, or one universe of information into another; the program is contained in both universes of information and thus contains itself, like a Kline Bottle. Designing such a map is programming. The informa-

tion which results from the mapping is useful, and, indeed, that is what it is to design: to make something useful in terms of some goal.

More communication is needed between the two groups involved in designing programs. Engineers write very "tight" code; the traditions and procedures of their profession serve them well in this respect and programmers could learn much from them. On the other hand, engineering is needlessly repeating many of the same mistakes that programming has already made and to some extent contained. The proliferation of languages and support systems is a prime example. Control storage should be understood to be the base element in a set of storage hierarchies.

Communication between programmers and engineers is complicated by the fact that both groups take widely differing views of the nature of their activity. To the engineer, the coding language is documentation which describes what he is doing. He thinks of himself as gating, latching, and flip-flopping only with a different technology. The programmer, on the other hand, thinks of himself as manipulating a language according to certain grammatical rules. It is all the same. The latching and flip-flopping of the one can be translated into the grammatical rules of the other and vice versa.

The history of information design indicates that many more clerical and administrative tasks will be

... engineering is needlessly repeating many of the same mistakes that programming has already made ...

taken over by machines in the future. This will open up new areas of design with extremely powerful tools, for example nonprocedural language compilers using machine theorem proving techniques.

One spokesman for an emerging science of design is Herbert A. Simon of the Carnegie-Mellon Institute. In a recent book¹ he discusses the study of systems which are the way they are because they have been formed by goals and purposes; that is, systems which have been designed.

The designer is concerned with how things ought to be in order to attain goals. Adaptation to a goal involves a relation among three things: the goal, the artifact, and the environment. Natural law impinges on an artifact through two of the terms that characterize it: the structure of the artifact itself and the environment in which it performs.

Like any artifact, a program can be thought of as an interface between an inner environment (the substance and organization of the program itself) and an outer environment (the surroundings in which it operates). Therefore, whether a program will in fact perform the function for which it was designed depends on its internal construction and its external

environment. If the inner environment is appropriate to the outer environment, or vice versa, the program will serve its intended purpose. Notice that this applies equally well to many things which are not man-made; in particular it applies to the adaptive living systems that have evolved through the forces of organic evolution. We should expect, then, that nature will have much to teach us about design.

Description of a program in terms of its organization and functioning, that is, its interface between

... nature will have much to teach us about design.

inner and outer environments, is a major objective of design activity. Central to this description are the goals that link the inner to the outer system. In many cases, whether a particular system will achieve a particular goal or adaptation depends on only a few characteristics of the outer environment, and not on the detail of that environment. One important property of most good designs is that, in one way or another, the designer insulates the inner system from the environment so that an invariant relation is maintained between inner system and goal. This relation is independent of wide variation of most variables of the outer environment. Such is the design of a ship's chronometer.

Often we have to be satisfied with meeting design objectives only approximately, which allows the inner system to show through. In this case testing must be done in a taxing environment in order to "prove" the internal structure.

There are many principles of good design. Design should be hierarchical with no flat levels. A rough approximation of this notion can be given by imagining an organizational chart of a company where at no node did anyone have substantially more people reporting to him than at any other node. Design should also entail nearly decomposable components which can be developed independently of other components. Design should address an entire system, par-

Designing information is very similar to designing a technical paper.

ticularly the interface with human beings who are part of the information universe.

Designing information is very similar to designing a technical paper. The design principles which affect the interface between the inner system and the outer environment are similar for both a well-designed information system and a well-designed paper. For example, human factors are critical to the design of an information system—a fact that was largely ig-

1. *The Sciences of the Artificial*, The MIT Press, 1969.

nored in the early days of programming. The recent emphasis on human factors in the interface between program and user parallels the constant concern for being understood when writing a paper.

Problem representation has a very strong influence on design. We might hope someday to achieve in information design the ability to characterize the main properties of a system and its behavior without elaborating the detail of either the outer or inner

Analog processing is the more primitive function . . .

environments. We should work toward a future when information design depends primarily on the relative simplicity of problem representation for its primary source of abstraction and generality.

No rigorous definition of information is possible at this time. However, some observations can be made. These are interesting in themselves but are also intended to stimulate further investigation into the theory of information design.

The question "What is information?" is identical to the question "What is knowledge?" knowledge being information in a specific locale, i.e., some human mind. In recent times there has been a hypostatization of information which should be seen in the perspective of the development of digital and analog computers. A first, descriptive definition of information is "that which is processed by a mind or computer."

Just as there are two types of computers there seem to be two classes of information: analog (or continuous or nondenumerable) information and digital (or discrete or denumerable) information. If it is true that the mind is a hybrid computer processing both analog and digital information, and that data is generally processed as analog, digitization taking place relatively infrequently, then many common notions can be explained. For example, people do think in both words (digital) and pictures (analog), some individuals being biased more in one direction than the other.

Our culture is primarily verbal and hence digital. "Knowledge" is frequently equated with verbal knowledge. Verbal knowledge is in fact only the smaller of two sets of knowledge, but it is the type most readily transferred from one individual or generation to another. Analog processing is the more primitive function, digital processing having been only recently acquired in conjunction with socialization. The language reflects this with the word "believing" for analog processing and "knowing" for digital processing. Intuitive solutions to problems may be derived from the analog processing, while formalization represents digitization.

Deductive reasoning has been formalized, while inductive reasoning has not. This may be because deductive reasoning operates on the discrete which is denumerable, while inductive reasoning operates on the continuous which is nondenumerable. Both deductive and inductive logic may be complete unto

themselves. The present apparent incompleteness of deductive logic would then be the result of confusing digital with analog processing, i.e., using nondenumerable sets in proof procedures.

The validity of a theory such as we have suggested is determined by its consequences. We expect that these views will stimulate a theory of programming less restrictive than that of recursive functions and the development of a theory of information for more than two-state channels. A greater interest would be taken in many-valued logics, and the incompleteness problem would be re-evaluated.

Perhaps the most important consequence would be a new sense among programmers of the importance of their work resulting in improved performance and increased ease of recruitment into the profession of talented individuals.

Suggestions for Further Reading

- Burnshaw, Stanley, *The Seamless Web*. New York: George Braziller, 1970.
- Guilford, J. P., *The Nature of Human Intelligence*. New York: McGraw-Hill, 1967.
- Minsky, Marvin (ed.), *Semantic Information Processing*. Cambridge: The MIT Press, 1968.
- Cohen, Paul J., *Set Theory and the Continuum Hypothesis*. New York: W. A. Benjamin, Inc., 1966.
- Quine, W. V., *Set Theory and Its Logic*. Cambridge: Belknap Press, 1969. ■



Mr. Endicott is advanced programming development manager at IBM's Research Triangle Park Systems Development Division. He has been a systems programmer with IBM for the past 10 years, primarily in communications systems. He is a graduate of Emory Univ. and of Melbourne Univ.



Mr. Huyck is in advanced programming technology in the IBM, Research Triangle Park, Systems Development Division. He has been a systems programmer with IBM for the past two years, primarily in communications systems. He is a graduate of the Univ. of Iowa.

From nothing to two peripheral producers is the one-year track record Down Under

Australian Report

by Frederick A. Bland, Australian Editor

G The last survey on Australian computing appeared in *DATAMATION* close on two years ago. Since that date one of the most important developments has been the establishment of a manufacturing industry. The number of projects under way are as yet few and only one—*EAI*—has begun to achieve significant export sales.

A recent change in tariff classification of crt display terminals may cause some increase in the number of projects aimed at the internal market particularly if protection is extended to cover other computer classifications.

Looking back from the present day to January 1969, manufacturing in Australia was really little more than an idea in the head of Malcolm Macaulay. An American from Minnesota, he had founded Data Display, Inc., sold out to CDC, had become a consultant in Minneapolis, and had crossed the Pacific to be visiting lecturer at the University of New South Wales. He had by that time founded Information Electronics Ltd. as the first Australian computer manufacturing company and the first specifically computer stock quoted on the stock exchange here.

In order to understand peripheral manufacture in Australia, it is necessary to digress to a discussion on betting on horses, since it is to cater to this Australian obsession that several manufacturing projects have gotten off the ground.

Each state in Australia has its own Totalizator Agency Board (*TAB*), which is a quasi-governmental body operating betting shops throughout the state with a high concentration of outlets in the capital

cities, thus making these organizations real-time prospects for real-time computer systems. Bookmakers can operate at the race tracks and the tracks operate their own totalizators, but the main repository for bets anywhere in Australia is the *TAB*. On some days the "investor" will have a choice during the day of four or five race meetings in his own home state plus an important interstate meeting and, in the evening, a greyhound and a trotting meeting.

The most important race meeting in Australia is the Melbourne Cup held in November of each year. The winner of the cup in 1890 was Carbine and the winner in 1948 was Rimfire, a descendant of Carbine. What has all this to do with computing?

First computer network

The state which is the most advanced in the computerization of betting is Victoria, home state of the Melbourne Cup Meeting. *CARBINE* (Computer Automated Real-time Betting Information *NET*work) was the acronym chosen for the first Victorian *TAB* computer network, which provided the first order for terminals to be manufactured in Australia; this was based on two 32K CDC 3100s. The terminals were manufactured by Plessey Pacific, the Australian subsidiary of the British company that has a large stake in *ICL*.

RIMFIRE, the newer acronym, stands for Remote Issuing Machine For Integrated Real-time Execution. This system will, when it is complete, comprise two 65K CDC 3300s, which were installed in June and August, 1969, five CDC 1700s, 96 crt telephone betting

terminals and 1,000 ticket issuing machines. The new system is designed to handle 13 race meetings on any one day, 12 races at any one meeting with the possibility of 9 different types of bets. Current figures are 8 meetings per day, 10 races and 4 different bets.

Information Electronics obtained its first major order as Australia's independent computer manufacturer from the Victorian TAB for 96 crt terminals for telephone betting. The first 16 terminals were delivered during the first week in May 1970.

What IE has done is to take for its cathode ray tube a standard 12-inch Philips portable television set. Mr. Macaulay, now chairman of the company, says: "We remove the parts known as the front end or intermediate frequency components. We do not need these because we send the signals to the picture tube as demodulated television video and no detection is required. The picture to be displayed to the operator can be a mixture of white on black or black on white, which, in the particular application at the Victorian TAB (telephone betting), allows the highlighting of some important piece of information, such as the bettor's current balance."

Besides the specialized crt terminals for the TAB, Information Electronics has begun production of double-sided circuit boards with plated-through holes. The company has built its own camera for the production of printed circuits.

"The company is aiming to be a specialist electronics manufacturer, whilst at the same time creating our own line of equipment," says Mr. Macaulay. "We have already announced our own IE-33 terminal and in 1971 will be manufacturing Ferranti Argus computers under license from Ferranti in Britain." With 70 employees Information Electronics is close to capacity in its present premises and is expected to commence building operations in 1971.

IE's contract from the Victorian TAB is worth \$400,000. A second contract worth ten times this amount has been let to CDC for the production of 1,000 ticket issuing terminals to be used in hundreds of betting offices in Melbourne city and suburbs. Ticket sellers at these agencies can at present handle up to 250 transactions per hour, which is a very high rate for manual operation. The new machines will be able to issue 900 tickets per hour, but obviously this operation will be customer-controlled according to the ability of bettors to reach the counters fast enough to invest their money on their fancied horses and dogs. The first 150 terminals will be developed and manufactured in the U.S. at Minneapolis, but the remaining 850 will be manufactured locally because of the heavy customs duty on such a large order.

The system will incorporate five CDC 1700 computers as communications controllers. Each 1700 module will have 32K words of core storage, two magnetic tape units, one mass storage drum of 262K words and a Teletype terminal and will handle 200 ticket issuing terminals. Each module will also require a communications preprocessor interface with read-only memory. The first 1700 module to be installed will also have a 300 lpm printer, a card reader and a third magnetic tape unit to assist in program development. The existing twin 3300 installation is the master system and the five communications modules will be linked directly with the master system.

The first 100 terminals and the first two 1700

modules were scheduled for delivery in August 1970, after preshipment acceptance tests in Minneapolis in July. The next 50 terminals and the third 1700 module had a delivery date of November 1970. System acceptance is planned for April 1971, and the first 40 fully automated agencies should be operating in June 1971. The plan for conversion is to spiral outwards from the headquarters building and to have the whole of the Melbourne area fully automated by February 1973.

Employees doubled

This manufacturing project, apart from any plans for expanding the selling or maintaining of computers or other divisions of CDC in Australia, is going to enable the company to double its number of employees from 250 to 500 during 1970 and 1971.

Victoria is not the only state where better betting facilities are creating manufacturing opportunities. Both the Australian Capital Territory (ACT), which compares to the District of Columbia in the United States, and New South Wales are providing further scope for production.

In Canberra, ACT, the federal capital, the requirement is for multiplex equipment. It has produced a joint agreement to manufacture between the Univac division of Sperry Rand and Racal Electronics Pty. Ltd., an Australian subsidiary of a British company. Univac provides the marketing of the equipment, Racal the manufacturing facilities.

Outlining the background of the project, Erle Milburn, general manager for Univac in Australia, says: "It was realized that Univac needed to have a reasonable cost 256-line multiplexor so as to obtain the order. After some investigation we decided that the most suitable design and production facilities available were those offered by Racal Electronics. The multiplexor is suitable for any system in which large numbers of low-speed lines must be connected to a computer system and although our immediate requirement is for a 256-line system, units can be designed to handle in excess of 1,000 lines simultaneously."

Univac will be installing a twin 9400 computer complex as the major component of this Canberra contract.

In New South Wales, IBM is supplying the computer, Standard Telephone and Cables is providing Teletype terminals and an Australian company, Amalgamated Wireless (Australasia) is manufacturing the ticket issuing terminals. This contract is valued at \$3 million and a substantial portion of it (\$650,000) has been subcontracted to Stott Data-graphics, another Australian-owned company.

In a totally different field, EAI in Australia has designed an analog computer which fits in well at the lower end of the EAI range of equipment. Called the EAI-180, it is aimed at the university and technical college market.

Boris Schlensky, employed by EAI in Australia late in 1968 as engineering manager to design and build the first two prototypes of this machine, now general manager for the company, says: "At first we did not plan to sell this machine in the U.S., but the present recession has made companies and institutions price-conscious. We were originally manufacturing the

machine ourselves, but demand has been such that we have been forced to subcontract the manufacture of subassemblies to Hawker Siddeley Electronics." U.S. sales for this machine begin in June, 1971, by which time it will already be well on its way towards notching up its first 100 export sales.

No technical penalty

"At the same time that we have found a market that is fairly wide," continued Mr. Schlensky, "the production of this machine does not place any great technical penalty on us. The requirement is for a machine which is accurate to 0.1 or 0.01 of 1%. To produce a machine which is 0.001% accurate is very difficult in Australia because the basic components for such devices are not available or, if they are, they are very expensive. Very accurate resistors or capacitors are just not made here because there is no requirement for them in manufacturing processes. However, this is not specifically a need in Australia; the same statement would be true of very many of the developed countries of the world," he concluded.

What has EAI planned for the future in Australia? Mr. Schlensky says: "We're working on a digital recording system, which will automate the digitizing of information recorded in the laboratory and the factory. We're aiming to replace the chart recorder. Our parent company does have equipment priced at around \$25,000. We want to come up with something

at a more realistic price for Australia and hope to be announcing this new machine around the end of the year, but again our function will be design and marketing, not production."

These are some of the companies which have already made a claim either through design work or manufacture to a greater part of the Australian market than can be obtained by selling what their own or other companies produce overseas. The new element that has been injected into this situation is the tariff change.

Formerly all computer products attracted 7½% duty if imported from countries outside the British Commonwealth, whose products enter free. This has changed for crt display terminals, which now attract a rate of 42½% plus 5% primage from outside and 17½% from inside the Commonwealth.

No indication has been given whether these rates will be further extended over other computer products apart from crt display terminals, which need attract the higher rates only if a comparable terminal can be manufactured within the country. The market in crt terminals is sufficiently high (one estimate gives 5,000 in the next five to seven years), to ensure investigation of local manufacture. However, it cannot be expected that there will be a huge increase in computer manufacture in general as opposed to specialized large volume segments since Australia, with its 13 million people, represents about 1% of the total computer market on the world scale. ■

\$96⁰⁰*

NEW OPTO-ELECTRONIC KEYBOARD

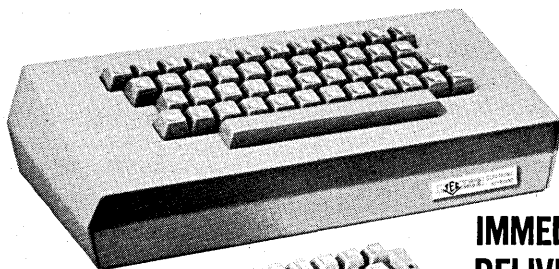

IMMEDIATE DELIVERY

They said it couldn't be done! Build a DTL/TTL compatible contactless, solid state keyboard with bounce-free output for less than \$100.00 (As low as \$60.00 in large qty.). TEC did — with optical code generation on a 47-key keyboard generating 65 ASCII character codes — and keytops are included! To learn more about this keyboard — a direct replacement for many now on the market — call or write TEC, Incorporated; 6700 South Washington Avenue; Eden Prairie, Minnesota 55343; or phone (612) 941-1100.



*IN 25-99 QUANTITIES, LESS ENCLOSURE

\$1,836⁰⁰*



IMMEDIATE DELIVERY

This low price doesn't mean a bare bones, unusable terminal! With TEC's Series 400 DATA-SCREEN™ Terminal, you get a 1000 character display unit with full edit capabilities (insert/delete character/line; erase to-end of line/page; blink; screen protect; tab; and full cursor controls). You get Teletype (current loop; TTL; RS 232) or high speed parallel (TTL compatible) interface. Price includes keyboard! For more facts, contact TEC, Incorporated; 6700 South Washington Avenue; Eden Prairie, Minnesota 55343; or phone (612) 941-1100.



*IN QUANTITIES OF 25

A Conference Report

Tokyo Show

by Edward K. Yasaki, Managing Editor

GIn Japan, numerology is big. There are "good" days for weddings, and people observe them. When there's a "bad" year for giving birth to a daughter, the nation's birth-rate plummets. Even names for children are selected on the basis of the number of strokes in the ideogram. In the arts, the even numbers like 2 and 6 are out, and odd numbers like 3, 5, and 7 are in. This apparently doesn't apply to the sciences, for the binary cult has captured the imagination of the people there. And that's pretty good for a nation weaned on the abacus. Japan, with a population of 100 million, is second only to the U.S. in the number of computers installed.

Hoping to capitalize on this, and campaigning to get American companies to begin to expand their marketing effort in Japan, the U.S. Department of Commerce last fall sponsored an exhibition in Tokyo of American-made computers and peripherals. It was the largest such show they've yet put on. Not merely an affair set up in one of the seven Trade Centers maintained abroad by the department, this one took over a smallish hall at the Harumi Fair Grounds and was devoted exclusively to computers. Some 60-plus firms took part in this effort. They ranged from Data Decisions Corp., New York City, the only software house there, to Control Data Corp., which had an operating 6600 on display—largest mainframe yet taken into Japan.

Two low profiles

Very much conspicuous was IBM, which didn't show up at all. Word was that IBM chooses not to be identified as an American firm, but rather as Japanese; among U.S. mainframe makers, only IBM and NCR have manufacturing plants in Japan, having established such facilities before the lid was clamped shut by the government there. NCR wasn't at the show either. In some circles, this is known as maintaining a low profile.

Another company that stood out

was Information Machines Corp., Santee, Calif., which makes a point-of-sale recorder. Its Registron was the only special-purpose terminal on display. Despite its narrow application, the terminal received unusual attention from the showgoers. According to Bernard Edelman, IMC president, the firm got from 700-800 inquiries, of which 400-500 were brought back to the U.S., which may lead to four or five orders. One "substantial" order resulting from the show is reported.

Edelman says he spent very little time at Harumi, leaving that to his Japanese trading company, and instead made the rounds of prospective buyers among the retailing community in Tokyo. He got a very good reception, he says, adding that one interview took 4½ hours—which is a long time to discuss inventory control

no previous marketing experience in Japan, the firm was able to get assistance from the department in finding a trading company to assist them. About two weeks before the six-day show opened, Edelman selected Tokyo-based Communications Science Corp., a part of Takachiyo Koheki, which also imports Burroughs equipment and CDC's ocr gear. And when Edelman reached Tokyo, they had already run off literature for distribution at Harumi, had bilingual people available to him, and had him scheduled for an orientation/sales meeting. Thus, they manned the booth and made presentations while he made calls in the city.

In addition to lining up trading companies, Commerce also promotes the show, sends invitations to the types of buyers sought by exhibitors, and pays for the shipment back to the plant of any equipment displayed but not sold. The exhibitor pays for initial shipment to the show, must send at least one representative to man the booth, and pays from \$450 to \$1,000 booth space fee. All booths are designed, built, and paid for by the department.

"We couldn't afford to build a

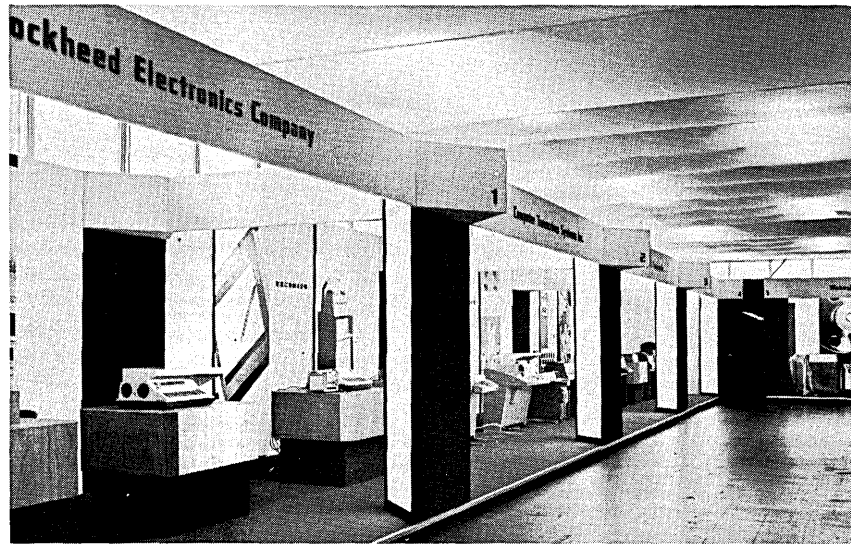

Booths for the show were designed, built, and paid for by the Commerce Dept.

and sales analysis. "To sell your products, you must have customer-use proof," he asserts, pointing to some 20 operating installations that the firm has in the U.S. "Those guys will fly over here at the drop of a hat to see an installation, if they're interested."

IMC was one of the few exhibitors who were considered "new to market," as Commerce calls them. With

booth like this for this show," said Ralph Swanson, general sales manager for Data Disc Inc. Swanson, elated by it all, said the firm was also exhibiting at Commerce's Milan, Italy, show later this year. Any company, small or even middle-sized, that doesn't take advantage of a show like this is crazy, he asserted. A firm new to this market, Data Disc, had started its formal sales effort in



Japan only a month before. Swanson admitted that the economic slump in the U.S. prompted the company's expansion abroad, but also explained that the firm is in the midst of a transition from an r&d and manufacturing company to one that is marketing oriented. Overseas markets, he thought, would account for from 30-50% of Data Disc's sales within three years.

No less enthusiastic was Bob Tidrick of Data Products Corp., Woodland Hills, Calif., peripherals manufacturer. With some minor exceptions, Tidrick said, all of DP's sales so far in Japan have been to original equipment manufacturers (oem's). Included are reading mechanisms for the firm's card reader and the hammer mechanism for its line printers. "There's some interest in our 6040 disc file," he added, "and a lot of interest in our process for manufacturing cores." For the company, the show came at an opportune time, being only a few months after Tidrick's arrival. On the day it opened, he got the names of 46 people who left a business card or a name and address. Of these, several were from the main oem-ers and, hopefully,

were the type of people he must make sales presentations to.

The right crowd

After two days, one exhibitor found that 70% of the names he had collected were manufacturers, exactly the crowd he was marketing to. The other 30%, he figured, were non-qualified curiosity-seekers.

The curious were clearly in evidence. The large users and the oem-ers, hopefully the prospects for the products on display, were sent invitations to attend the show. Others, including students who had a legitimate interest and passersby from another show across the street, were lined up outside—in the rain, on some days. Asked how long he had been waiting, one chap said almost three hours. His patience was rewarded, however, for some of these people were allowed inside for the last hour of the show.

Surprisingly few attendees were seen with an armful of sales literature, although they did pick up those brochures that apparently described equipment they were seriously interested in. Only rarely was someone

seen photographing the equipment; nevertheless, Digital Equipment refused to open the cabinet of its PDP-8/E.

In the four years or so that DEC has been selling in Japan, it has made more than 120 installations, according to Yu Hata, manager there. Most of these are parts of systems, such as IC testers or systems for laboratory automation and patient monitoring. When a minicomputer-based system is not available in Japan, and especially when it is needed for an industry considered critical to that nation's development, the oem has little difficulty getting an import license. Fortunately for manufacturers of IC testers, the semiconductor industry is one of those now considered critical.

Hata, who says DEC received five orders on the first day of the show, figures there will be a market of some \$100 million in Japan in a few years for minis. His largest Japanese competitor is Hitachi, but there are more than a dozen others. Asserting that most of them are making copies of the old PDP-8, Hata says there's at least three years' technical lag between DEC and Japanese firms.

Also watching the growing use of

Tokyo Show...

minis in Japan is Dave Krueger, sales manager for Kennedy Co., Altadena, Calif. The company was showing its tape drives for minis at the Harumi show, but has been marketing in Japan for some three years. According to Krueger, business was slow there until 1969 but has been picking up.

Cogar Corp. also had a booth, showing IC memories to makers of communications equipment, computers, and test equipment. It's represented by Japan Office Supplies Co. Ltd., which is run by the ex-president of IBM Japan. Thomas Kwei, Cogar's systems applications manager from Wappinger Falls, N.Y., says it will be a few years before Japan reaches the degree of integration (semiconductor talk, not racial) achieved by U.S. firms in its IC memories. He guesses they're currently behind by a factor of two or four—a lag of two to three years.

Another semiconductor memory manufacturer there was Advanced Memory Systems, one of eight companies represented by the trading firm, Munzig International Inc. Others exhibiting under the Munzig flag were Beehive Medical Electronics, Bryant Computer Products, Computer Access Systems, Computer Memory Devices, Decision Data, Odec Computer Systems, and Wang Computer Products. With eight firms crammed into one booth, it was a bit crowded; but what the booth lacked in visual appeal was made up for by the presence of the most attractive girl at the show.

Shows without sex appeal

In general, though, the whole show lacked sex appeal. Absent were pretty girls in minis and assorted show biz garb, magicians performing card tricks, two-story booths, and the amplified voices of barkers. But that's the way Commerce runs these shows, and also the direction in which AFIPS is going with the Spring and Fall Joints. For comic relief, there was a PDP-12 that played electronic tunes, and CDC's line printer produced Snoopy posters.

But all was not music and games. Early in the week, CDC became concerned over the impotency of the air conditioning and began punching holes in the cabinets of some of its peripherals. The crowd was always largest at CDC's end of the hall, which didn't help the cooling problem, but soon the entire facility was aswarm and people were stepping outside for

a breath of cool, if not exactly fresh, air. Other exhibitors complained that their sales and technical literature was being held up by customs people, who were also delaying approval of such supplies as ribbons and printer paper.

All in all, however, the show was successful, to say the least. As always, Commerce released sales figures, placing the total at more than \$2.25 million; and yet the CDC 6600 on display was sold before it was brought to Tokyo, and that must be worth at least \$2.25 million by itself. The system will go into a service bureau in Tokyo. Another exhibitor, Viatron, reported sales of \$700K, several others went over the \$100K mark, and "at least 10 companies indicated that they expect to sell more than a million dollars worth of computer products during the next few months."

Japanese were, poor—or at least poorer than in the opposite direction—and that's certainly not surprising, for the people there are more accustomed to going from Japanese to English. Thus, this really is no explanation, nor should it be a measure of the success or failure of the seminar. Judging by the paid attendance throughout the 3½ days of sessions, upwards of 400 at each, it was a popular feature. The program, chaired by Dominic Laiti of KMS Industries, had sessions on such topics as operating systems, MIS, graphics, standards, minicomputers, and terminals.

Big turnout

In any attempt at evaluating the show, one can't overlook the fact that the Commerce Dept. attracted almost 20,000 people to a computer



Colloquium, cosponsored by Commerce and ACM, featured simultaneous translation, wireless headphones.

A bit of an enigma but probably equally successful was a concurrent seminar sponsored jointly by Commerce and the Assn. for Computing Machinery. Papers, in both English and Japanese, were translated simultaneously, and facilities for a question-and-answer session were made available. The sessions were well attended—a credit to the organizers—but, to the consternation of many session chairmen, there was little response from the audience. One chairman even considered starting a debate among the panelists in the hope of generating some discussion from the floor. But no debate, no questions. One explanation was that the translations from English to

show with 60 exhibitors. This compares with the 21,000 at the last Fall Joint where more than four times as many exhibitors showed their stuff. And of the 20K, some 10K came with invitations.

Just how large is the market in Japan? In terms of the value of installed computers, Japan is second only to the U.S. Purchases of dp equipment increased from \$360 million in '67 to some \$620 million in '69, according to Commerce figures. The market should top \$800 million in '70 and reach \$2.2 billion in '74. "The U.S. share of Japanese dp imports has risen steadily during the past three years, from about 66% in 1967 to 73% in 1969. Due to the

leading position of American dp technology, the U.S. is expected to maintain its share of Japan's imports that could reach \$259 million in 1974."¹

Conversations with users in Japan indicate a need for optical character readers, COM systems, key-to-tape or disc systems, and, over the longer pull, terminals. This is not to say that there's a ready market for these devices, for there's a difference between "need" and a demand backed up by an ability or willingness to pay. Terminals, for example, are still relatively scarce, but a growth rate exceeding that in the States is being anticipated. One also gets the impression that Japanese peripherals, at least currently, are generally inferior to U.S. makes. In the document cited above, other products are listed according to "highest" and "good" sales potential.

There are several ways one can try to break into this market. As mentioned already, Information Machines merely linked up with a trading firm that will take care of sales calls. It's a route taken by many. Cogar has sent Tom Kwei to hold seminars at the offices of sales prospects, with presentations given in English. He says he gets exceptional turnouts, and the intelligent questions asked indicate his listeners get the message. His talks, of course, are on IC memories, and some people contend that technical presentations like that can be in English.

Then there are people like Tidrick, who was given some Berlitz lessons and a plane ticket. He, like many others, is trying to figure out whether the company should go it alone, link up with a trading company, or get into some licensing arrangement whereby his products will be made in Japan. Still new to the country, Tidrick recalls vividly his initial impressions.

The first thing he learned, he says, is that the rent for a house or apartment in the Tokyo area adequate for his family—wife and two children—is from \$1,000 to \$1,500 a month. As if that weren't enough, the renter must make at least a six-month deposit and pay from six months' to a year's rent in advance. Tidrick adds that offices rent for \$300-700/month, and the deposit required is from two to five years' rent.

On top of that, he sends his kids to

an American school, which costs about \$1,000/year/kid, plus a dollar a day each for bus fare. Another family, with four children, finds it cheaper to send them to school in a cab. Food? It can be cheap if you don't insist on eating as you would in the States. Steak, for example, cannot be a weekly fare when it costs

changes in technology, in sociology, in economics. Such an opportunity today, unquestionably, is the emergence of the Pacific Basin as a major economic force in the world. It is already creating huge markets. It will produce even grander ones in the years just ahead."

Among marketers, there's general



A 2- to 3-hour wait was endured by some, not all of whom were allowed inside.

from 2½ to 4 times what it does back home. "Setting up an office with one man in Japan," he concludes, "is more costly than setting up a three-man office in the States."

Supporting this contention is another Successful American Salesman now hanging his hat in Tokyo. He and his wife rent a two-bedroom home on the outskirts of Tokyo, one that he figures would sell for perhaps \$21,000 in southern California. His rent is almost \$1,000, and he once overheard his landlord say that the house had a market value in excess of \$100,000. Maybe real estate speculation is a better racket than computers.

But this salesman, after a year and a half in Japan, sees a grander role for himself. He looks to the time, a few years hence, when he will head the company's marketing throughout the Far East. Over the longer stretch, this makes sense. *Forbes* magazine, in a recent cover story on the Pacific Basin, said:

"The world's great lasting fortunes and its great lasting business successes have almost always gone not to those who were simply shrewd or sharp but to those who recognized and capitalized on vast sweeping

agreement that it takes at least a year to get to know the territory in Japan. Both to introduce American manufacturers to this market and to help the more established firms gain a better foothold, Commerce is considering other shows in Tokyo this year. There's also talk of a repeat of last year's, only bigger, but perhaps not until '72.

(Recognizing the existence of a larger market in Europe, the department also has shows lined up for that part of the world, some of them featuring computers as part of, say, a business equipment show. Firm dates on these, as well as marketing assistance, are available from the 42 field offices of the Commerce Dept. in the U.S. Each has an international trade specialist.)

This is all part of a program that started in the early '60s with the passage of the Export Expansion Act. Currently, about 2,500 firms participate in the program annually, less than a third of them being new to the export game or new to a particular market. The goal is to raise this to 50%.

And, according to numerologists at the Commerce Dept., 1971 is a "good" year to get started. ■

1. World Markets for U.S. Exports, U.S. Dept. of Commerce, Bureau of International Commerce, June 1970, IMIS 70-223.

PERSPECTIVE

an interpretive review of significant developments

ATC Upgrading Plan Still Flies But Target Seen a Long Way Off

Federal efforts to upgrade the nation's air traffic control system apparently moved forward last month, but no one really could be sure the ultimate goal was any nearer.

Raytheon Corp. was responsible for whatever progress occurred. The company has a contract for a "computer display channel" (CDC) — a complex crt and an associated processor — which represents a key element in the updated air traffic control system. Originally, this equipment was to be delivered in 1968. Actually, an acceptable processor wasn't delivered to the Federal Aviation Administration, manager of the program, until late last year. And it wasn't until last December that FAA began acceptance testing of the crt. Last month, with initial testing of the crt complete, it looked as if Raytheon had finally made it.

Next step is to integrate the Raytheon CDC into a "beacon display system" which will make it easier for air traffic controllers to keep track of planes. The system has been designed to display, on a crt in front of the controller, alphanumeric codes representing each plane's altitude and identity. This information, located adjacent to the radar blip representing the plane, will travel with the blip as it moves across the crt. Currently, the controller must record plane altitude and identification manually on little plastic markers called "shrimp boats" and then move them by hand across the screen to keep up with the blip.

The new system will offer several other improvements — such as display of aircraft buried in storm clouds, and projection of flight paths for aircraft designated by the controller — but a rather complex gauntlet must be traversed before these wonders can become operational.

Enter IBM

First, the Raytheon CDC, which contains the controller's crt, must be mated to an IBM 9020 input processor (a modified 360/50). The input comes initially from radar signals bounced off

aircraft fuselages and from "transponders" — black boxes aboard virtually all commercial aircraft — that can transmit identification and altitude data.

The Raytheon-IBM integration was scheduled to begin last month at FAA's Atlantic City test facility. Assuming no hitches develop, the system will be moved to Jacksonville, Fla., in April where it will be mated with another major element in the updated air traffic control system. The Jacksonville add-on consists of a computerized subsystem which records and processes flight plan information. This data is cranked in originally before a plane takes off, is updated if any changes occur subsequently, and, in the ultimate operational system, will be transmitted to each en route air traffic control center having responsibility for the flight as it progresses from takeoff to landing. The basic output of the flight data subsystem consists of "flight strips" placed alongside each controller's display station. Also, some of the information will be displayed on the crt, along with beacon data.

At Jacksonville, a system displaying beacon and flight data for high-altitude flights only will be tested. Hopefully, by February 1972 this system will be delivered to the en route air traffic control center serving the Los Angeles area, and by late in '72 will be ready to go into regular service there.

Turbulence Since '61

A number of problems could crop up in the meantime, however, and considering the past history of the project, they probably will. Since 1961, when FAA began actively developing what is known officially as the "National Airspace System" (NAS), so many misfortunes have occurred that one wit suggests sending the agency a CARE package.

Last summer, NAS specs were completely redesigned because IBM was having so much trouble with the earlier ones. The new specs are simpler, and presumably easier to imple-

ment. But they require the company to redo a good deal of its previous labor. Sources suspect that IBM hasn't yet thrown enough troops into the breach. While the effort is improving, we were told, it may not be improving fast enough to produce an acceptable system without further delays.

Back at the airport

While the en route portion of the NAS program lurches forward into an uncertain future, the other major portion, which involves airport automation, also seems to be threatened. Key item in the terminal automation program is a system called ARTS III, contracted to Univac. So far, a total of 35 systems have been ordered, and another 29 will follow if they can be justified by a cost-benefit study.

One reason for FAA's difficulty in catching up with the state of the art is suggested by the way it handled Raytheon's work on the computer display channel. Although the specs were very complex, FAA apparently didn't see any need to let a prototype contract and then award production to the successful developer. Instead, FAA combined both steps into a single buy, held a competitive procurement, and, in January 1967, awarded the job to Raytheon.

We were told that at the time Raytheon was already seriously behind schedule on another FAA contract, involving a TACAN (Tactical Air Navigation) system. It wasn't until last summer that FAA saw the need for an alternate supplier. By that time, Raytheon's performance was so embarrassing, and Congressional pressure so insistent, that the agency had to contract with Sanders.

The Sanders crt is due this April, and according to FAA, probably will be delivered on schedule — i.e., less than a year after the contract was awarded.

It's interesting to speculate where the NAS program would be today if FAA had hired Sanders as a backup to Raytheon in January '67. (One cynic suggests that the system would be no farther along, but the monkey would be on IBM's back for late delivery of software, instead of Raytheon's for late delivery of hardware.)

One reason for FAA's management difficulties was alluded to recently by administrator John Shaffer, when he testified before a House appropriations subcommittee: "... procurement and engineering used to be in the bailiwick of the Associate Administrator for R&D," Shaffer ex-

plained. "(Recently) we brought aboard a new chief of procurement ... He reports to (Associate Administrator for Administration) Clark Harper. So we have taken the fox out of the chicken coop."

—Phil Hirsch

IBM's New Peripherals May Be Too Much Competition for Competitors

It was a hectic six months for the makers of IBM-compatible peripherals as the giant's growl grew to a loud roar. The sequence:

June 30, 1970: IBM announced the big 3330 disc drive with fine price/performance, a writable control store, and no 2314 compatibility. Competitive intelligence had long been at work, and several peripheral makers claimed they'd have their own versions soon after IBM delivered.

September: IBM announced the 2314-like 2319 disc drive for the 370/145, complete with a cpu-integrated control unit with a low price tag. The independents grumbled "unfair" as they worried about how they could economically interface their drives with the integrated file adaptor — a technique surely to be used on future 370s.

November: IBM improved its weak tape drive line by offering the better, cheaper 3420/3803 system.

December 1: IBM sued Memorex and a subsidiary Peripheral Systems Corp. for trade secret violations involving its 3330 disc drive and breach of nondisclosure agreements by unnamed ex-employees. (See Jan. 15, 43.) It then turned specifically on Richard Stock, ex-IBM now with Information Storage Systems, Inc., for basically the same violations.

December 14: As IBM roared out of 1970, it made the 2319 available on most 360s and all 370s with shipments to start April 1. The independents screamed that this was a "little 2314 repackaging and a lot of price cutting," as their frayed nerves turned into ulcers.

Summarized one observer: "IBM is trying to tell the compatible peripheral makers that if they play follow-the-leader too closely, it will undercut, outperform, and/or sue them." He added, "I think IBM has nipped the

mixed installation trend in the bud."

What the Dec. 14 2319 announcement means is that IBM users, merely by using a field-modified 2314 control unit, can replace their 2314 drives with 2319s, rather than use lower priced competitive versions, and save up to 19%. Some were surprised to learn the 2319 doesn't need the integrated file adaptor that is required on the 370/145.

One modified control unit, priced at \$1480/month, will handle up to three 87-megabyte 2319s that rent for \$1000/month each, or a total of \$4480/month. The 2319 has a 60 msec access time, and a transfer rate of 312KB. Users with a three-spindle configuration would save \$455 a month by replacing 2314s. Users with the full 2314 (eight spindles and a spare) could convert to three 2319s and the controller at a saving of \$1025/month.

Extra shift charges out

IBM also announced it has eliminated extra use charges on all multiple-spindle drives. It previously charged extra for use exceeding the 22 eight-hour shifts a month allowed with the basic rental. The extra charge in the controller remains, however. And the company further cut 2314 versions from use on the 370/145. In September, it said the 145's integrated file adaptor would handle one three-spindle 2319 and up to five more 2314 spindles. The maximum cost for that configuration is \$3830/month. Now IBM says that the same \$550/month IFA will control two 2319s and two 2314 spindles. Cost: \$3470/month.

While some users praised the independents for forcing IBM to drop its inflated prices, others had little sympathy for the me-tooers. One large IBM customer with a roomful of for-

eign disc and tape drives claimed "they've missed their chance.

"They should have been developing their own high-performance peripheral subsystems in addition to the plug-compatible gear. But they didn't want to spend the time and money developing the necessary software." He admitted, on the other hand, that such subsystems would have had to be "worth their weight in gold" to convince the user to convert.

And, as if leasing companies didn't have enough trouble, IBM's price cut is about the same as the discount many lessors offered on 2314s in two-three year contracts, and many of those contracts are coming to an end in 1971 and 1972.

IBM's legal moves to protect its future in the peripheral market somewhat surprised those that thought obtaining specifications, and even advance information on IBM products, were part of "normal industry intelligence operations." While some considered IBM's suit against Memorex as merely a warning to the competition about hiring away its developers and using 3330 data long before IBM deliveries, the giant underscored its seriousness by attacking an individual in a second suit.

The complaint, filed in Santa Clara County Superior Court, says that Richard Stock was an IBM staff engineer working on disc development for the Merlin (3330) and "other advanced IBM files" from June 1968 to Sept. 1970. IBM alleges Stock told IBM supervisors he intended to join the engineering staff of ISS and to design and develop a Merlin magnetic disc such as is used in the IBM Merlin file. That is what seems to have roused IBM's legal wrath, plus the allegation that Mr. Stock knew nothing about discs and disc files before joining IBM. Stock also is charged with breach of contract, and trade secret lawyers think this may become somewhat of a landmark case, testing the enforceability of IBM's employee contract on nondisclosure.

And what of the independents at which all of this is aimed? One manufacturer summed up the industry's feelings: "We survive in this business just as long as we outperform and out-price IBM. What else can we do but make price adjustments?"

—Angeline Pantages ■

NEWS SCENE

Honeywell's New Line: Stay with a Winner

IBM talks softly but carries a big umbrella. Honeywell, with three new machines and other assorted products, is talking loudly and, at the same time, has opened its own new umbrella — not as big as IBM's to be sure, but not as expensive either. The new Honeywell equipment is broad and covers the low and medium ends of its existing line. In addition, Honeywell is expected to round out the high end of its line later this month with a brace of big machines.

The technical aficionados won't be overly intrigued by the new Honeywell machines. There are, for instance, no claims at setting new industry standards, no semiconductor memories, no virtual memories, no exotic technical "break-throughs." However, anyone with more than a passing interest in price/performance specifications will find "The Other Computer Company's" new machines interesting.

Honeywell, which electrified the industry last year with its daring acquisition of GE's computer operations, is playing it safe with its new equipment. Essentially, Honeywell is repeating its timeworn and successful approach to selling computers: huddle under

IBM's pricing umbrella by offering more bang for the buck.

The stepping-stone machine for what Honeywell calls "a new family within the Series 200" is the 115, introduced less than a year ago. More than 300 of the 115s were delivered last year (orders for nearly twice that were received) and Honeywell decided the concept was so good it would bring out some sister machines embodying the same concepts. Thus, the 115/2, the 1015, and the 2015 (the new "15" family).

The Model 115/2 has a memory cycle time of 2.25 usec, and its 32K main memory is expandable to 64K. In a typical 32K configuration with console, a card reader/punch, printer, and two disc drives, the 115/2 would lease for \$4,073 per month on a five-year contract.

The medium-scale system, the 1015, has a memory cycle time of 1.6 usec and a 64K main memory expandable to 128K. A typical configuration will rent for \$8,371 a month.

The 2015 has a main memory of 96K — expandable to 256K — and has a 1.3 usec cycle time. A typical configuration would lease for \$12,800/month.

One logical question: What happens to the Series 200? Honeywell

says it plans to continue to make all its machines in the 200 series, but many are betting that the 200 line will be deemphasized as the new machines are promoted. In fact, a likely lineup of Honeywell's new "hard sell" line would be: the 115, 115/2, 1015, 2015 and, from the Series 200 line, the 3200 and the 4200. The line would



C. W. SPANGLE
A plan for compatibility.

likely be rounded out at the bottom by the Model 58, the Bull machine that is Honeywell's answer to the System/3. At the top, Honeywell is expected to emphasize the new high-performance machines, already noted, which should be unveiled any day now. The new machines will probably be enhancements of GE's old 600 line and, indeed, are slated to be built in the former GE Phoenix plant.

While the Model 58 has been successfully sold in Europe for nearly 18 months, Honeywell's decision to market the machine aggressively throughout the U.S. is a significant move. Honeywell is hoping it can convince users that it has a better price/performance than IBM's System/3.

All this takes us to a problem: a major drawback of the Honeywell line is its lack of compatibility within the line. The "15" machines are compatible with the Series 200, and all of the machines in the Honeywell line have been designed to easily convert IBM programs.

But most of the Honeywell and General Electric machines are not compatible with one another. On the



MODEL 115/2 in \$4K-8K per month range.

subject of compatibility, C. W. Spangle, the chief operating officer of HIS, says: "From the very beginning we realized that this was a problem for us and we've been working at ways to overcome it. We don't see any overall easy solution to this. Hardwarewise, we already have a plan for peripheral compatibility across the entire product line; so we're not too concerned about that, but the compatibility question of a customer being able to move his programs easily from a former GE machine to a Honeywell machine or vice versa is one that's more difficult."

Honeywell's new product orgy was not restricted to cpu's. The firm also unveiled peripheral devices and about 25 software routines and industry-tailored application packages. The software routines and application packages represent something of a shotgun blast and are designed to solve problems in a variety of fields, including manufacture, banking, distribution, hospitals, insurance, education, and government.

In sum, then, as far as the "15" machines are concerned, it is interesting to note precisely how much mileage Honeywell is getting from a single generation. Honeywell introduced the flagship machine in its 200 series — the model 200 — in December of 1963, and, now here is HIS more than seven years later announcing what are essentially enhancements of the model 200. Honeywell officials, however, are quick to point out that the 200 line has evolved on a technological scale over the years. That may be true, but Honeywell's experience illustrates that marketing strength, a high level of customer support, system reliability, and low price are what many users are seeking.

— W. David Gardner

Fallout of Adversity ... the Plus Side

Necessity really can mother invention. Just ask the principals of trouble-plagued Intranet Computing Corp., Los Angeles time-sharing and peripherals manufacturing firm which, on the day before last Thanksgiving, filed bankruptcy proceedings under Chapter XI in the Los Angeles Central Division Federal District Court.

On Christmas Day the same principals had formally incorporated a new

company, Corporate Finders, Inc. The company was founded for the express purpose of resurrecting Intranet but, at this writing, its future looked considerably more secure than that of its predecessor.

James W. Halverson, vice president and director of finance for Intranet and president of Corporate Finders, said Intranet's big problem in its period of financial pressure before Chapter XI filing was one of lack of exposure. Among individuals and

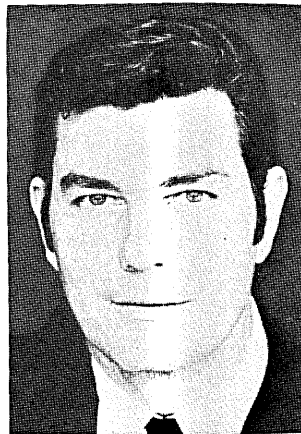

JAMES W. HALVERSON
Corporate Finders will go on.

companies who might have come to its rescue, Intranet was not well enough known for what it was doing or how.

It was felt a national clearing house for companies in trouble and potential investors could be the answer and that this could be automated. Corporate Finders went looking and found a group with a job-match system under development which they felt could be converted to serve their purpose. For employee characteristics, such as salary and experience, they substituted characteristics for the company in trouble, such as sales volume and product line. For employer traits they substituted traits required or sought by a potential investor, such as cash flow, product compatibility, etc. And using this data they make a match or develop a list of possible matches.

And while still trying to put the system to work for Intranet, they acquired some outside clients. Whatever happens to Intranet, Halverson said, Corporate Finders will go on. Its officers, in addition to Halverson, are Ted Neville, director of contract administration and procurement for Intranet, and

Dick Dooly, treasurer of Intranet. Working with Corporate Finders as independent associates are Art Speckhard, Intranet president, and Thomas C. Wood, its vp and director of the system development division.

And what of Intranet? Principals met in late December with a bankruptcy referee with four alternate plans of arrangement, one of which was expected to be concluded within 30-60 days of the meeting.

Halverson said the plans revolved around two "interested investors," one a large aerospace firm and the other a group of "wealthy individuals," many of whom are substantial Intranet stockholders. They have evolved plans covering these separately and together. If they go alone with the group of individuals they expect only to be able to get the hardware operation going again and to complete a \$680K contract from JPL for controllers that enable Univac 1100 series computers to use disc drives and for which they have received verbal assurance of an extension from JPL.

This would require an investment of from \$100K-200K. It would take from \$500K to \$1 million to get their time-sharing operation going again, Halverson said, and this is what they would expect from the aerospace company. A combination of the two investment groups could get them moving on both fronts.

Halverson said Corporate Finders could be acquired by a revitalized Intranet or might just "go its merry way." But go it will, its principals are sure, as "the only nationwide automated matching service of its kind."

IBM High on Remote Maintenance Scheme

Though detractors accuse IBM of not using the most advanced technology in its products, few can fault the firm's service organization. Field service may not be flawless, but it's one of IBM's marketing hallmarks.

Now, with the advent of the System/370, IBM is implementing a remote maintenance support network that should improve field service, or at least enable it to keep up with increasingly sophisticated equipment. The new service, called Retain/370

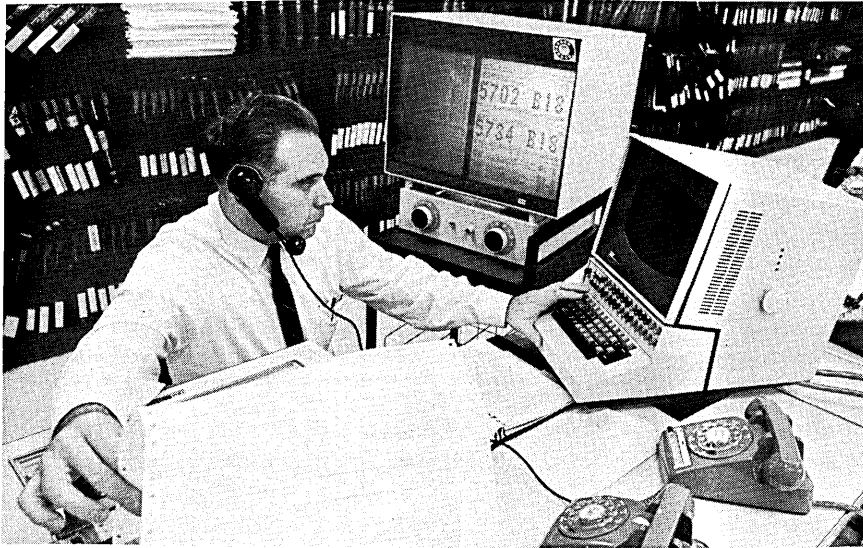

NOW WHAT'S WRONG? Regional maintenance specialist searches data base in Raleigh for help in tracking problem with IBM equipment as part of firm's new remote maintenance service.

(Remote Technical Assistance and Information Network), is headquartered in Raleigh, N.C., where a data base of maintenance information as well as remote diagnostic programs — a “data link” — are being maintained.

There is no extra charge to users except for phone company fees for the data access arrangement necessary to run remote diagnostics for System/370 mainframes.

Although the service is primarily an adjunct to System/370, it also includes remote testing of 90% of IBM's teleprocessing equipment directly through the Raleigh center and provides program maintenance support for OS and DOS, not limited to the new systems. Only the data base, and not the data link, is used for program support, however. Retain/370 will be available around the clock seven days a week, beginning with the first System/370 deliveries this month.

Goal of the new maintenance service is to enhance the customer engineer's capability of diagnosing a problem. Thus, when a CE is faced with disc drive trouble, for example, he phones a maintenance specialist at one of three regional technical support centers in Chicago, Los Angeles, or New York. The specialist then searches the Raleigh data base in an interactive mode using a crt terminal; or, together, the CE and the specialist may use the data link — operating over dial-up lines from the customer location using an IBM supplied adapter for systems that have dedi-

icated lines — to run diagnostic programs at the Raleigh center. The output may be displayed at both the support center and the user site. Problems and corrections discovered are entered into the Retain/370 data base for future reference, thus keeping the information constantly up to date.

Two searching and retrieval methods are provided, one interpretive, the other incremental. The interpretive method is used when the existence or location of specific maintenance information is not known. With this method, the entire data base can be searched by using a series of key words entered by the specialist from information provided by the CE. The incremental retrieval method uses progressive index levels, such as the master index, which lists all machines by unit type. When a unit type is entered, a subindex lists related information categories. A selection from this page produces a list of abstracts on the selected category. When an abstract is selected, the full text of the selected record is shown. This method is used when the category of specific data is known.

Remote maintenance of teleprocessing equipment has been used since October 1969 but was limited to only about 20% of the total product range until development of the 1200 Baud Terminal Diagnostic Analyzer and Tester. This is a portable device which not only tests almost the full line of teleprocessing hardware, but which uses an acoustic coupler, making the

Raleigh facilities available to installations with dedicated phone lines without interrupting the customer's use of such lines. Previously, only teleprocessing installations with access to dial-up lines could connect to the center.

Using the 1200, the CE merely dials Raleigh, where a general diagnostic test is run or he may request specific tests tailored to a particular problem. The tests are run under computer control from the maintenance center, and the customer can continue to use his own computer for jobs other than teleprocessing. If the equipment is not operating properly, the CE is informed of the probable location of the malfunction.

If during the testing the CE requires additional help, he can press a “talk” button and confer with a specialist at the test center. But these men are only on duty from 8 a.m. to 8 p.m. Eastern time.

If remote maintenance isn't enough to improve field service, IBM has a couple of other developments: a System/370 Model 145 console simulator and a CAI system to train CEs. One 1130 cpu will drive six simulated consoles, and courses using this equipment will be established this year at education centers in Endicott, N.Y., Chicago, and Los Angeles. Training applications include console operation, system data flow, resident and nonresident diagnostics, troubleshooting, and operating system training.

ITEL Leasing to Offer Semiconductor Memories

ITEL Computer Leasing Div., San Francisco, has taken what could be considered a step to block off possible inroads on its 360 leasing business with the advent of the 370.

ITEL has signed a contract with Advanced Memory Systems of Sunnyvale, Calif., for a minimum of \$3.75 million worth of semiconductor memory systems which can serve as extensions of main memory for 360/30, 40, and 50 users whose current alternative is going to IBM for additional increments of higher priced core. Gary B. Friedman, president of ITEL Computer Leasing, said the agreement gives ITEL exclusive marketing

rights to the AMS systems which utilize the same technology as the AMS SSU (Semiconductor Storage Unit, March 1970, p. 194) which is similar to that used in the IBM 370/145.

Friedman said the agreement makes ITEL the only leasing company with an alternative source for extended main memory. The others, he said, must go to IBM. He said the cost advantages of the AMS systems (savings of \$1-2K per month depending on requirements) will make it attractive to 360 users who might have been considering moving to 370s to stay where they are.

ITEL will begin taking deliveries on the AMS systems in June. They will both sell and lease them, and if they do as well as they expect to, they'll extend their commitment to \$12 million for a period through Sept. 1973.

One of ACM 71 Goals Is a Profit of \$5K

ACM 71 will be held in Chicago August 3-5. It will continue the dialog between those who make use of the computer and the computer professionals, but this time the pros will initiate the conversation.

The ACM council recently adopted three resolutions concerning the conference:

One, that the conference would be held and would continue the discussions begun at ACM 70. Regional ACMers felt that if it didn't there was no need of having just another technical conference. They felt there are already more than enough.

Resolution Two set a ceiling for member fees to the conference of \$35. Gordon Smith, ACM director, said that this move stemmed partially from Computer People for Peace demands that conference fees be reduced.

The third resolution stipulates that the conference result in a \$5,000 profit. ACM 70 was budgeted for a \$23,000 loss and resulted in one of \$83,000, which the association hopes to reduce through the sale of Proceedings.

The dialog sessions at ACM 71 will be sponsored by association's Special Interest Groups and Committees (SIGs and SICs). Dr. Melvyn H. Schwartz, of Northwestern Univ.'s

Vogelback Computing Center, is program chairman.

Concurrent with ACM 71 in Chicago a dissident group of ACMers will hold a "Counter" Conference in Boulder, Colo. The group's goal is to censure the windy city for its treatment of protest and protesters during the 1968 Democratic Convention. Although this has become a somewhat empty gesture and the ACM has invited the group to return to the fold, the conference will be held. The group now feels it will provide a needed forum for technical papers.

Down and Happy

While ACM nationally is mounting an intensive campaign for members, the Los Angeles chapter has cut its membership in half and then some and is happy about it. The chapter last summer switched its membership record keeping from manual maintenance to the Informatics Mark IV file management system. The system is being provided by Informatics free of charge. It has made possible the purge of some 589 members who, in effect, weren't really members at all, as their renewal dates had come and gone without them or the chapter being the wiser. Some had been "carried" for as long as two years. Paul Cudney, chapter membership chairman, is pleased. "Now we know where we stand." Memberships on record went from 1100 to 511. Cudney feels sure the bulk of members purged will be back on board as soon as they're contacted because they've had 100% response from those contacted so far. And this doesn't hurt headquarters totals, as memberships in headquarters and chapters are independent of each other.

Computer Dept. Flunks Out at Notre Dame

The Univ. of Notre Dame has decided to discontinue its undergraduate program in computer science. The school's academic council cites dwindling demand for the program — no freshman indicated it as a major — and increasing capability of the university's four colleges to provide computer training through other depart-

ments.

The two-year-old department of computer science will cease to exist after May 31, 1971. The 37 students now enrolled will fulfill requirements by taking computer-related courses in other departments. Six professors are also affected by the closing.

The council also stripped the university's computing center of institute status. At Notre Dame an institute is a "major organization not with a college and devoted to advanced academic study, teaching, and research." The center nevertheless will continue to supply service for faculty and administration.

The Notre Dame action apparently indicates no trend to undercut computer science, though it does support those who contend it should not be an undergraduate specialization. It does indicate, however, that schools are reducing the number of smaller departments in order to economize. And it is possible to read the ending of institute status for the computing center as an indicator of the decrease in research grants and the decrease in popularity of such activity on campuses.

The Big Get Bigger — So What Else Is New?

The bigger, the better seems to be the unsurprising result of a survey conducted for Leasco Systems Corp. by the marketing research firm of Daniel Yankelovich, Inc., which determined in the study, covering 286 companies (purportedly 60% of the nation's computer installations), that a "performance gap has opened between the very largest installations and smaller ones that threatens to leave the smaller user further and further behind in effective computer utilization."

The study focussed primarily on IBM users and classified them as follows: 1) small — 360/20 computers or equivalent; 2) 360/25 and 30 or equivalent; 3) 360/40 and 50; 4) large — 360/65 and 67 or equivalent.

Among the "key findings" of the survey is that most computer applications are still confined to the standard accounting applications, especially among smaller installations. In more sophisticated applications, such as financial planning, the number now running ranges from 35% for small

users to 74% for the large. It's the same kind of ratio for such similar complex applications as numerical control which the survey says provides "significant potential impact on profits." It also shows that the large user is two to six times as likely to be running sophisticated applications with large possible payouts as the small user.

Another key finding for Leasco, appropriately, is that another factor distinguishing users by size is that six out of seven of the largest installations use outside computer consulting services compared to three out of five for smaller users. The inference can be drawn that small users had better get with it as far as outside help is concerned in order to survive.

Frank H. McCracken, president of Leasco Data Processing Equipment Corp., the parent company, stated:

"Tragically, the smaller user is busy-ing himself with reinventing the wheel — designing computer systems for payroll accounting, inventory control, customer billing, etc., when he should use available knowledge in these areas and move on to solving problems that can provide profits to top management."

He predicts that the rate of growth of edp expenditures on the part of larger firms over the next five years will cause the performance gap to increase unless the small stop thinking small.

EDS Rebuffed in Move to Build in Pastoral Dallas

At presstime, Ross Perot, president of Electronic Data Systems, Dallas, and keynote speaker at the FJCC, still hadn't decided where and whether to

build his company's corporate headquarters.

His first plan was to build it on 170 acres of land he bought in North Dallas, where it would be in a park-like setting surrounded by a golf course. However, he was unable to get the land rezoned for such a project, and he then announced that he was considering either the East or West Coast, showing an admirable flexibility. He also is looking at various Dallas suburbs, some of which have offered sites and tax concessions in order to bring the EDS payroll to their areas.

EDS employs about 3,000 people, 800 of them in Dallas. "Some of those men would just as lief headquarter elsewhere," Perot said, according to a story in the *Dallas Morning News*, which also stated that Perot resented the fact that the news media represented the building effort as a Perot rather than a corporate project, but he said he would try "to solve the problem as unemotionally as possible."

If EDS moves, which is doubtful, a good bet might be the East Coast, where Perot has a sizable investment in the brokerage firm of F.I. DuPont Glore Forgan & Co. with an option to assume control. This seems likely — the firm recently received the EDS dress code (skirts not to be more than two inches above the knee, no brown shoes with grey suits), which prompted some to allow as how they'd just as lief headquarter elsewhere.

FCC Likely to Bear Down on Carrier DP Affiliates

Western Union's plan to change its Securities Information Communication Service (Sicom) from a regulated communications service to a non-regulated, hybrid dp service has been delayed by the FCC. Sideline observers suspect this decision means the commissioners have decided to impose tight controls on communication carriers that want to enter the dp services business.

Last December, the commission announced that before reaching a final decision in the Sicom case, it will issue a final decision in the computer/communications inquiry. The policy enunciated in that decision will then determine whether, and under

(Continued on page 63)

CIRCLE 17 FOR HONEYWELL →
DATAMATION



"Are you familiar with the Protestant work ethic?"

The Other Computer Company thought it would be nice to have everything under one roof.

So here it is.

Now that The Other Computer Company offers a broader range of computer products than anybody, we thought it might be helpful for you to have everything in one place.

This handy insert contains

descriptions of computer-related products and services that Honeywell offers. After you look through it, you might want to save it. For a rainy day. Write us for your file copy.

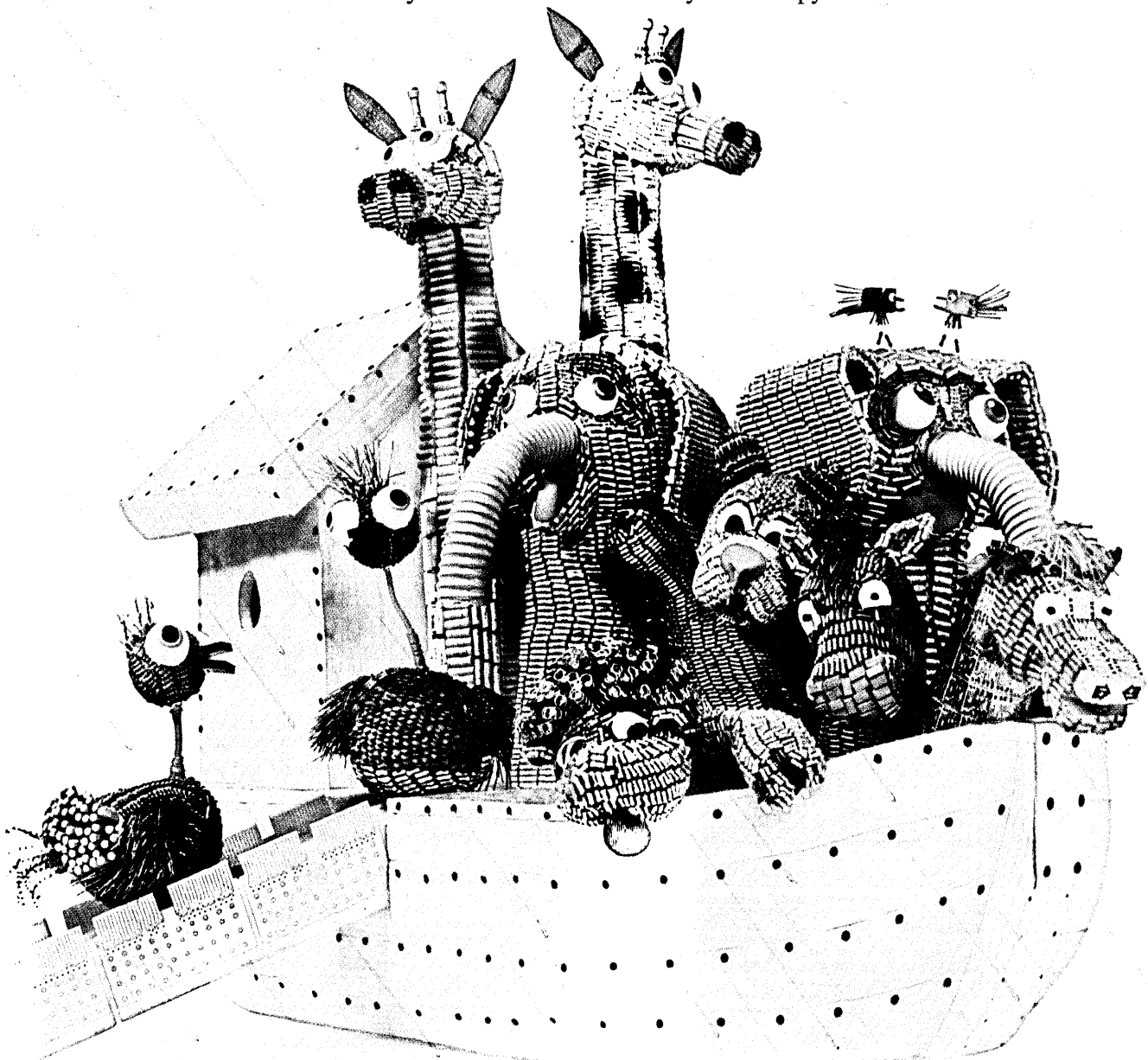

Designation	General Application	System Rental (K/Mos.)	Data Structure	Maximum Memory Size (K = 1,024)	Maximum Disk Storage	Average Disk Access Time (MS)	Maximum Card Read - Punch Speed (CPM)
58	Local/ Remote Transaction Processing	0.9-2.8	8-bit byte	10,000 bytes	4.6M	72.5	200-30
G-105	Business Batch Processing	1.2-3.5	8-bit byte	8K bytes	6M	115	400-300
G-115	Business Batch Processing	1.4-5	8-bit byte	16K bytes	92M	87.5	600-300
G-120	Business Batch Processing	2.2-6	8-bit byte	32K bytes	92M	87.5	600-300
G-130	Business Batch Processing	3.3-7	8-bit byte	32K bytes	92M	87.5	600-300
110	Business Batch Processing	2.4-4	6-bit character	32K characters	9.2M	82.5	600-400
115	Business Batch Processing	2-6	6-bit character	32K characters	36.8M	62.5	1050-400
<i>115/2</i>	Business Batch Processing	3.8-8.5	6-bit character	65K characters	147.2M	62.5	1050-400
120	Business Batch Processing	2.7-4.6	6-bit character	32K characters	73.6M	97.5	1050-400
125	Business Batch Processing	3.2-8.5	6-bit character	65K characters	147.2M	62.5	1050-400
200	Business Batch Processing	2.6-10	6-bit character	65K characters	147.2M	62.5	1050-400

Italicized figures indicate new product

Here's how The Other Computer Company covers the marketplace with computer systems.

Honeywell offers the widest range of advanced computer systems in the industry. Hardware, software, and price combinations are virtually limitless.

Compact models like our Model 58 provide a starting place for the

smaller business. Card or disk flexibility, uncomplicated programming tools, and simplified keyboard/display offer a productive man/machine system.

Larger batch-oriented card, tape or disk systems, such as our

new Model 115/2, are available for business data processing. These low-cost, high-performance systems are highly adaptable through the use of an extensive array of application-oriented software packages.

Maximum Tape Transfer Rate (KC)	Maximum Printer Speed (LPM)	Other Peripherals or Features	Major Operating System Characteristics	Significant Programming Languages Available	Other Systems Software Available
—	200	Alpha and Numeric Keyboard Data Entry, Mark Reader	Card and disk operations	<ul style="list-style-type: none"> ■ Mini-COBOL ■ GECOL 	<ul style="list-style-type: none"> ■ Application Packages for Basic Accounting
60	300	MICR, Paper Tape, Terminals		<ul style="list-style-type: none"> ■ Assembler ■ LOGEL 	<ul style="list-style-type: none"> ■ Remote Terminal Software ■ Tab Simulators
60	1100	MICR, Paper Tape, OCR, Terminals	Card/tape/disk load and monitor routines and communications systems	<ul style="list-style-type: none"> ■ Assembler ■ LOGEL ■ Fortran IV ■ COBOL ■ RPG (G-120 & G-130) 	<ul style="list-style-type: none"> ■ Sort/ Merge ■ Utilities ■ Application Packages ■ Tab Simulators ■ CPM
60	1100				
60	1100				
19.2	650	MICR, Paper Tape, Terminals	Card/tape/disk load and monitor routines and communications systems	<ul style="list-style-type: none"> ■ COBOL ■ Fortran IV ■ Assembler 	<ul style="list-style-type: none"> ■ Sort/ Merge ■ Utility Routines ■ Application Packages ■ Tab Simulators ■ CPM ■ Conversion Packages
149	1100				
149	1100	MICR, Paper Tape, OCR, Terminals	Card/tape/disk load and monitor routines and communications systems	<ul style="list-style-type: none"> ■ COBOL ■ Fortran IV ■ Assembler 	<ul style="list-style-type: none"> ■ Sort/ Merge ■ Utility Routines ■ Application Packages ■ Tab Simulators ■ CPM ■ Conversion Packages
149	1100				
224	1100	MICR, Paper Tape, OCR, Terminals, Magnetic Drum	Card/tape/disk/communications monitors regulate data flow (foreground/background processing)	<ul style="list-style-type: none"> ■ COBOL ■ Fortran IV ■ Assembler 	<ul style="list-style-type: none"> ■ Sort/ Merge ■ Utility Routines ■ Application Packages ■ Tab Simulators ■ CPM ■ Conversion Packages
224	1100				



Designation	General Application	System Rental (K/Mos.)	Data Structure	Maximum Memory Size (K = 1,024)	Maximum Disk Storage	Average Disk Access Time (MS)	Maximum Card Read - Punch Speed (CPM)
405	Business/Scientific Batch Processing	5-10	24-bit word	12K words	120M	87.5	600-300
415	Business/Scientific Batch Processing	7-14	24-bit word	16K words	120M	87.5	1200-300
425	Business/Scientific Batch Processing	9-20	24-bit word	131K words	120M	87.5	1200-300
435	Business/Scientific Batch Processing	12-25	24-bit word	131K words	120M	87.5	1200-300
<i>1015</i>	Business Batch Processing	8-18	6-bit character	131K characters	280M	62.5	1050-400
1200	Business/Scientific Batch Processing	7.5-17	6-bit character	131K characters	280M	62.5	1050-400
1250	Business/Scientific Batch Processing Multiprogramming	9-19	6-bit character	131K characters	280M	62.5	1050-400
<i>2015</i>	Business/Scientific Batch Processing Multiprogramming	13-30	6-bit character	262K characters	280M	62.5	1050-400
2200	Business/Scientific Batch Processing Multiprogramming	11-21	6-bit character	262K characters	1.2B	103.8	1050-400
410	Time Sharing	10-15	24-bit word	16K words	120M	87.5	1200-300
430	Time Sharing	16-21	24-bit word	32K words	120M	87.5	1200-300
440	Time Sharing	20-25	24-bit word	65K words	120M	87.5	1200-300
3200	Business/Scientific Real-Time Multiprogramming	18-34	6-bit character	524K characters	1.2B	103.8	1050-400
4200	Business/Scientific Real-Time Multiprogramming	22-50	6-bit character	524K characters	1.2B	103.8	1050-400
8200	Business/Scientific Real-Time Multiprogramming	35-80	6-bit character 48-bit word	1,048K characters	1.2B	103.8	1050-400
615	Business/Scientific Multiprogramming	25-80	36-bit word	262K words	3.2B	26	1200-300
635	Business/Scientific Multiprogramming/Time Sharing	35-120	36-bit word	262K words	3.2B	26	1200-300

Italicized figures indicate new product

And more computer systems.

Our broad array of medium-scale systems, including our new Models 1015 and 2015, have been designed for bigger batch processing workloads, multiprogramming, and real-time communication. They feature full disk or tape operating system control with hardware protection and interrupt processing capability. Operating systems flexibility provides for phased implementation from single job stream to full dual-job

stream processing functioning concurrently with communications and data transcription.

Applications in data base management, real-time data communications, and time-sharing are accommodated easily by the expandable and adaptable architecture of these systems.

Large-scale systems offer greater throughput and efficiency via such features as interleaved addressing and overlapped mem-

ory accesses, processor and I/O subsystems, and hardware multiprocessing.

The largest of these are three dimensional in their ability to offer full multiprogramming with multi-processing while controlling a time-sharing network. Operating systems control all concurrent operations while providing job accounting and continuing analysis of operating efficiency.

Maximum Tape Transfer Rate (KC)	Maximum Printer Speed (LPM)	Other Peripherals or Features	Major Operating System Characteristics	Significant Programming Languages Available	Other Systems Software Available
83	1200	Magnetic drum, MICR, OCR, Paper Tape, CRT, Terminals, DATANET* 20, 21, 30, Floating Point Operations	Batch processing and multiprogramming executives regulate data flow while optimizing system efficiency	<ul style="list-style-type: none"> ■ Fortran IV ■ COBOL ■ Assembler ■ Macro ■ RPG ■ LP 	<ul style="list-style-type: none"> ■ Integrated Data Store (I-D-S) ■ CPM ■ Engineering Subroutines ■ Floating Point Utilities ■ Statistical Subroutines ■ Operating System Utilities ■ Large Library of Application Packages ■ Sort/Merge
160	1200				
160	1200				
160	1200				
224	1100	MICR, CRT, OCR, Paper Tape, Terminals, Satellite Computers, Magnetic Drum, Floating Point Operations	Multiprogramming mode with communications	<ul style="list-style-type: none"> ■ COBOL ■ Fortran IV ■ Assembler 	<ul style="list-style-type: none"> ■ PERT Time/Cost ■ Simulation ■ Floating Point Utilities ■ Data Base Management ■ Extensive Library of Applications Packages ■ Recovery/Restart Operations ■ Sort/Merge
224	1100		Full dual job stream multiprogramming with communications, local and remote batch processing and data base management		
224	1100				
224	1100				
224	1100				
160	1200	Magnetic drum, MICR, OCR, Paper Tape, CRT, Terminals, DATANET* 20, 21, 30, Floating Point Operations	Batch processing, multiprogramming and time-sharing executives regulate data flow while optimizing system efficiency	<ul style="list-style-type: none"> ■ Fortran IV ■ COBOL ■ Assembler ■ Macro ■ BASIC ■ RPG ■ EXPER (CAI) ■ LP 	<ul style="list-style-type: none"> ■ Integrated Data Store (I-D-S) ■ CPM ■ Engineering Subroutines ■ Floating Point Utilities ■ Statistical Subroutines ■ Operating System Utilities ■ Large Library of Application Packages ■ Sort/Merge
160	1200				
160	1200				
224	1100	MICR (n/a Model 8200), CRT, OCR, Paper Tape, Terminals, Satellite Computers, Magnetic Drum, Floating Point Operations	Full dual job stream multiprogramming with communications, local and remote batch processing, and data base management	<ul style="list-style-type: none"> ■ COBOL ■ Fortran IV ■ Assembler ■ Advanced LP (Model 8200) 	<ul style="list-style-type: none"> ■ PERT Time/Cost ■ Simulation ■ Floating Point Utilities ■ Data Base Management ■ Extensive Library of Applications Packages ■ Recovery/Restart Operations ■ Sort/Merge
224	1100				
224	1100	■ Hardware Multiprogramming	Multiprocessing/Multiprogramming control; eight programs processed concurrently		
160	1200	Paper Tape, CRT, Terminals, DATANET* 30, DATANET* 355, Magnetic Drum	GECOS* 3-Dimensional Executive: <ul style="list-style-type: none"> ■ Multiprogramming ■ Local and Remote Batch Processing ■ Time-Sharing ■ GECOS Data Base Management 	<ul style="list-style-type: none"> ■ BASIC ■ Fortran ■ COBOL ■ ALGOL ■ Text Editor ■ Macro ■ JOVIAL ■ APT ■ LP 	<ul style="list-style-type: none"> ■ Integrated Data Store (I-D-S) ■ Sort/Merge ■ Media Conversion ■ PERT Time/Cost ■ Wide Range of Comprehensive Application Packages for Commercial and Scientific Use ■ SIMSCRIPT
160	1200				

*Registered Trademark



Designation	General Application	Purchase Price	Cycle Time (μ sec.)	Maximum Memory (K = 1,024)	Data Structure	Maximum Disk Storage	Average Disk Access Time (MS)	Maximum Card Read-Punch Speed (CPM)
112	Data Acquisition and Control	\$5,500	1.69	8K	12-bit word	14M	90	800-100
316/316R	Real-Time Processing R (Ruggedized)	\$ 8,400/ \$14,500 (R)	1.6	32K	16-bit word	14M	90	800-100
516/516R		\$23,800/ \$24,800 (R)	0.96	32K	16-bit word	14M	90	800-100
632		\$97,000	0.85	131K	32-bit word	57.6M	67	800-400
1601	Real-Time Processing R (Ruggedized)	\$12,300	1.6	32K	16-bit word	14M	90	800-100
1602/1602R		\$12,900/ \$20,900 (R)	1.6	32K	16-bit word	14M	90	800-100
1603		\$21,490	1.6	32K	16-bit word	14M	90	800-100
1605		\$33,900	0.96	32K	16-bit word	14M	90	800-100

And still more computer systems.

The Honeywell Series 16 is a family of general purpose, 16-bit, modular computers with high computation and I/O speeds.

Models 316 and 516 are available in standard or ruggedized versions. They are ideal for scientific, industrial control, communications, and time-sharing applications.

Models 1601 through 1605 are specialized for data

acquisition, monitoring, automatic testing, and production control applications.

Model 112 is an adaptable low-cost computer for data acquisition and communication. And, at the other end of the family, Model 632 offers power for real-time processing and control

operations. The subsystem design of Model 632 supports different configurations for memory and I/O capabilities.

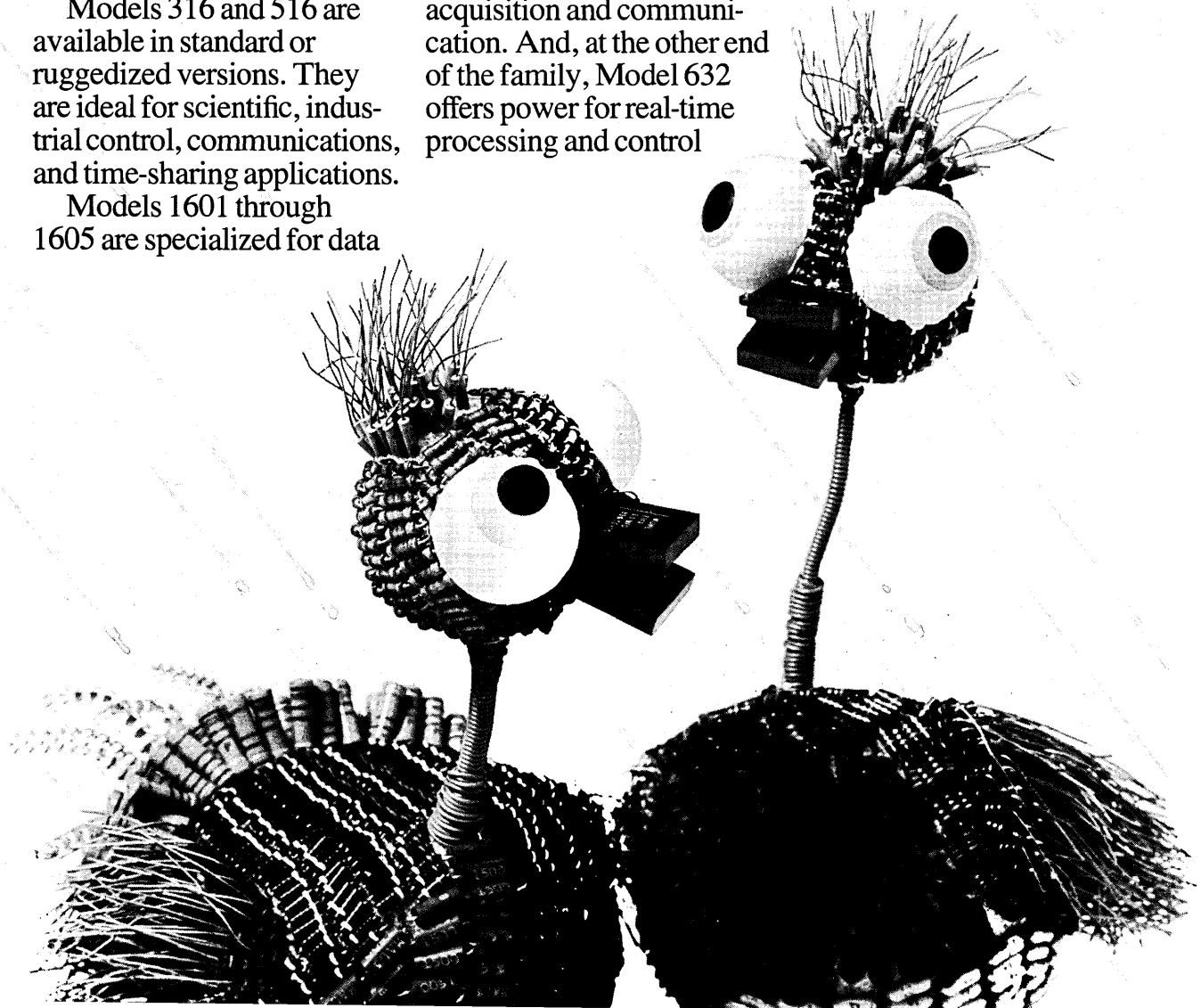

Maximum Tape Transfer Rate (KC)	Maximum Printer Speed (LPM)	Other Peripherals	Major Operating System Characteristics	Significant Programming Languages Available	Other Systems Software Available
64	900	TTY'S Plotters, etc.	<ul style="list-style-type: none"> ■ Real-Time Supervisory and Process Control Operations 	<ul style="list-style-type: none"> ■ Fortran IV ■ Utility Routines ■ Assembler 	<ul style="list-style-type: none"> ■ Extensive Library of Commercial and Scientific Subroutines, Including Floating Point Operations
64	900				
64	900				
120	900				
64	900				<ul style="list-style-type: none"> ■ Specialized Packages Designed for Real-Time Control Applications
64	900				
64	900				
64	900				

And The Other Computer Company

covers its computer systems with application packages.

Even a product line as impressive as Honeywell's wouldn't be complete without equally impressive application software.

That's why we stress package applicability, quality, and support. That's why we stress package design, pre-testing, training and documentation aids, and on-going maintenance. That's why just about every kind of industrial and commercial user can find Honeywell packages of specific value to his business.

Best of all, these packages, training and documentation, and maintenance are included as part of the Honeywell bundle.

Industry Segment	Application Packages
<i>Financial Management:</i>	Payroll, Accounts Receivable and Payable General Ledger, Inventory Reporting, Report Writer.
<i>Manufacturing:</i>	Factor - Management Information and Control System: <ul style="list-style-type: none"> ■ Inventory Forecasting and Control System ■ ABC Analysis ■ Inventory Simulation ■ Bill of Materials Processor ■ N/C ■ Preventive Maintenance Scheduling
<i>Banking:</i>	Demand Deposit Accounting, Mortgage Loan Accounting, Savings Accounting, Installment Loan Accounting, MICR Entry and Remote Entry for Demand Deposit Accounting, Proof and Transit, Central Information File, On-line Real-time Savings and Loan Processing.
<i>Distribution:</i>	Inventory Simulator, Inventory Forecasting and Control, Seasonal Forecasting, Inventory Status Reporting.
<i>Medical:</i>	Single Hospital System or Hospital Computer-Sharing System (HCSS) - Comprehensive Patient Accounting System, Cost Allocation System, Personnel System, Payroll System, Accounts Payable, General Ledger, Property Ledger, Preventive Maintenance.
<i>Education & Government:</i>	Student Scheduling System, Computer-Assisted Instruction, Real Estate Tax Accounting.
<i>Insurance:</i>	Comprehensive Life Insurance Processing for small-to-medium size companies; Fire and Casualty System Designs.
<i>Retail:</i>	Assist - Management Information System for multi-store retailers, Accounts Receivable, Fashion Merchandise Management System, Staple Stock Control System.
<i>Printing and Publishing:</i>	Specialized Technique for Efficient Typesetting, Photostet System for computerized photo-composing, Subscription Fulfillment.
<i>Management Science:</i>	PERT Time/Cost, Linear Programming, Statistical Analysis, Simulation, and an extensive library of scientific subroutines.
<i>Engineering:</i>	Civil and Electrical Engineering Packages including structural and circuit analysis programs.

Product	Characteristics				Special Features
Disk Pack Drives	Capacity Per Drive 1.56-29.1M	Data Structure 8-bit Byte	No. of Disks 1-11	Access Time 30-100ms	Transfer Rate 110-312 K ■ IBM Compatible ■ Self-Cleaning
Magnetic Tape Units	Speed 16-150 in./sec.	Channels 7 or 9	Density 200-1600 bpi	Tape Width ½"	Read Options Forward Reverse ■ Simultaneous Read/Write ■ Automatic Tape Load
Line Printers	Speed 100-900 lpm	Character Set 64	Line Option 120 or 132 Characters	Format Tape 8 Channel	No. of Carbons 5 ■ Buffered Models Available
Card Equipment ■ Readers ■ Punches ■ Reader-Punches	Speed Read: 200-1050 Punch: 100-400	Hopper Size 500-3000	Feed Technique End Feed	Options ■ High-Speed Skip	Error Check ■ Indicators ■ Parity ■ 51 or 80 columns ■ Mark Sense Read Option
Circular Magnetics ■ Reading ■ Writing ■ Media Encoding	Speed 600 cps	Card Specs. Min: 1" x 1½" Thickness .01-.022	Unit's Weight 4.6 lbs.	Unit's Dimensions 4.5" x 3.8" x 7.8"	■ Highly Reliable ■ Circular Magnetic Read and Write Techniques
Paper Tape Equipment	Speed 120-1000 cps	Paper Tape Opaque/Punched	Tape Width 11/16-1"	Read Options Bi-directional	■ Simplified Loading Procedures
Visual Displays	Transmission Speed 1200-4800 bps	Display Capacity 1012-2024 Characters	Displays Per Control 1 or 2	Options ■ Hard Copy ■ Polling ■ Memory Expansion	■ Horizontal Vertical Line Draw Capability ■ Optional Keyboards
OCR Equipment ■ MICR ■ Document Reader	Speed 1200 doc./min. 1200 doc./min.	No. of Pockets 12 2	Font E13B COC-5	Checking Mechanisms ■ On-line Procedures ■ Parity	■ CMC 7 Option ■ Mark Sense Reader Options
Digital Products	DATA-PAC: A complete family of proven digital modules for use in manufacturing mini-computers and computer-related products.				

Logic Modules	Over 100 I/C types; 5-, 10-, and 25-MHz switching frequencies.							
Core Memories	Model No.	Cycle Time (μ sec.)	Access Time (NS)	Split Cycle Time (μ sec.)	Maximum Capacity (Words-Bits)			
					Basic Module	Two Module	Three Module	Four Module
	ICM-40	1.0	500	1.25	4K-28 8K-28 16K-14	—	—	—
	ICM-40E	1.0	500	1.25	16K-26 32K-13	16K-52 32K-26	16K-78 32K-39	—
	ICM-100 ICM-160 ICM-161	1.0 1.6 1.6	360 550 650	1.0 1.6 1.88	1K-10 4K-16 4K-16	— — 4K-32 8K-16	— — 12K-16	— — 8K-32 16K-16
Analog Interface Modules	Complete line to meet A/D, D/A conversion and interface requirements.							
Hardware, Power Supplies, Accessories	Compatible line of digital product backplanes, mounting hardware, housings, power supplies, accessories, and supplementary logic module PACs – preengineered, prepackaged, and predocumented.							

Here's how The Other Computer Company covers your OEM requirements.

No other manufacturer offers as broad an OEM product line: all major industry-compatible peripherals, a variety of applications-oriented devices, minicomputers, and a complete line of digital modules.

The design and field engineering support for these products guarantees smooth equipment interface. Continuing on-site maintenance agreements are available through Honeywell's national network of over three thousand field engineers.

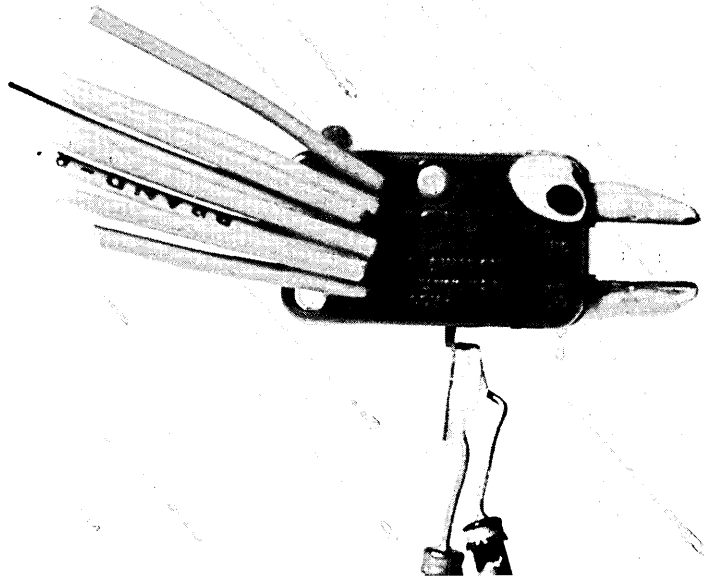

Here's how The Other Computer Company covers your need for time-sharing systems.

There's a new Honeywell in the field of time-sharing, with knowledge and in-depth experience that is unmatched.

Systems design, software, and conversational languages are time-tested and field-proven.

Honeywell time-sharing systems start at under \$3000 a month, and range up to large multi-processors for huge user networks. With a range of capabilities like this, the user has a choice of alternatives for in-house, dedicated, or subscriber-based systems.

For information services.

To extend the usefulness of Honeywell time-sharing systems, a variety of general-purpose and specialized services are offered through data centers in sixteen major cities. Contracts can be arranged for time-sharing computer use. And the appropriate terminals can be leased. Information Services Data Centers are located nationwide.*

Honeywell also offers services to increase the efficiency of hardware and software systems. Contract programming and assistance help the user meet his specific goals. And facilities management helps by managing labor, hardware, or supplies at the user's installation.

Honeywell can also help the user with batch processing service, computer time, or data conversion.

*Boston, New York, Washington, Philadelphia, Atlanta, Dallas, Houston, Tampa, Chicago, Cleveland, Detroit, St. Louis, Minneapolis, Denver, Los Angeles, San Francisco.

For education services.

As a recognized leader in data processing education, Honeywell offers tuition-based programs, seminars, tailored training, and video-tape courses.

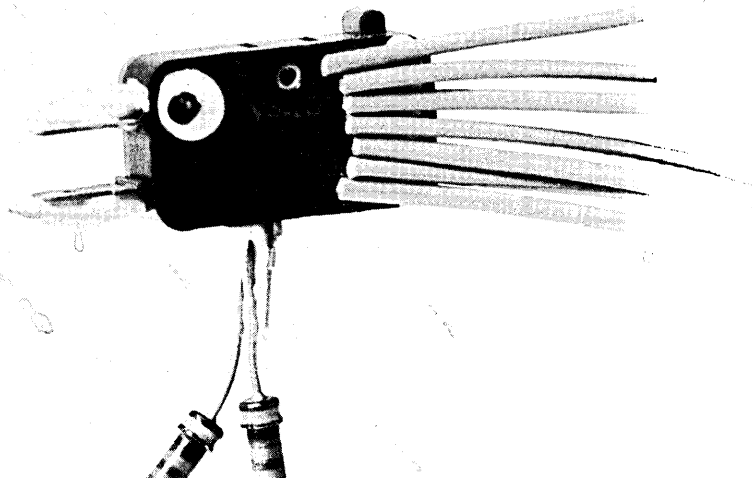

Model	System Rental (\$K/Mos.)	Maximum Memory (Words)	Maximum Disk Storage	Maximum No. of Simultaneous Users	Terminals	Significant Languages Available
1642	2.9-4.5	16K	36M	32	TTY's, Plotters, etc.	<ul style="list-style-type: none"> ■ BASIC ■ Fortran IV ■ SOLVE ■ TEACH ■ EDIT ■ COBOL* ■ EXT. BASIC*
1644*	4.2-5.9	32K	36M	32		
1646*	5.6-7.8	32K	93M	32		
1648*	8.0-12.5	32K	115M	64		
255	16-18	16K	218M	32	TTY's, Plotters, CRT's, Intelligent Terminals, Computers	<ul style="list-style-type: none"> ■ BASIC ■ Ext. BASIC ■ Fortran IV ■ COBOL ■ EXPER (CAI)
265	18-20	16K	218M	32		
275	20-22	32K	218M	32		
410	10-15	32K	120M	20		
430	16-21	32K	120M	30		
440	20-25	64K	120M	50		
615	25-80	262K	3.2B	100		
635	35-120	262K	3.2B	100		

Italicized figures indicate new product

- 1648 Products: applications using remote terminals connected to a 1648 Time-Sharing Computer.
- Business and Scientific Time-Sharing: cost accounting, production control, payroll, etc.; calculations, design optimization, statistics, etc.
- EDINET: terminal-oriented educational applications partially or totally dedicated to educational institutions.
- Network Information Systems: applications such as Keytax (income tax preparation), General Ledger, Building Utility Design System (BUDS), etc.

- Contract Programming and Assistance: systems and program development to meet customer requirements. Technical advice (systems and programming) is also available by contract.
- Facilities Management: partial or total management or operation of a customer's data processing activities.

- Batch Services: processing customer data on HIS computers using application-specific products such as Automotive Systems – providing inventory and financial management services to vehicle dealerships. Honeywell Securities I – a field-proven brokerage “back office” information handling system. HIS Application Packages – many offerings for industry-specific applications. Specialized – customized applications and systems as required.
- Computer Time: sale of HIS computer power (clock time).
- Data Conversion: translation of customer's input documents into computer readable media at our data conversion centers.

- Tuition Education: Honeywell Institute, established in 1969 to provide highly qualified personnel to industry, has graduated more than 1500 day and evening students. Schools exist in Los Angeles, Dallas, Detroit, Chicago, Boston, and Atlanta. Each school offers free graduate-interviewing services to industry.
- Seminars – advanced professional seminars are conducted throughout the country on subjects such as Data Base, Project Management, Teleprocessing Network Design, and Advanced Systems Analysis. These seminars are conducted publicly or at the company.
- Contract Education: the Institute offers tailored training on an on-site basis. Courses have been conducted at many major companies and government agencies.
- Video-Tape Courses: training courses are offered for programmers and analysts covering Data Base, BASIC programming, Management Science, and Management Games. Tapes are compatible with most video-tape equipment.

						Data Preparation				
	Series	Tape Density	Record Length	Keyboard Character Set	Program Load Options	Product Name	Model No.	Monthly Rental (1 Yr. Lease)	Purchase Price	
Keypape (single-station)	700 (7 channel)	200, 556 bpi standard; 800 bpi optional	80 char. standard; 8-400 char. optional	64 char. plus control keys; Honeywell and IBM compatibility	Keyboard entry standard; automatic load via mark-sense card optional	Basic Keypape	700	\$152	\$7,000	
							900	177	8,300	
						Expandable Keypape	701, 702, 702A	169	8,400	
							901, 901A	182	8,550	
		900 (9 channel)	800 bpi standard				Pooler	712,912	41	1,220
							Adding Machine	713,913	63	2,210
							Check Digit Validation	714,914	21	1,050
							Pooler Converter	970	80	2,400
						Automatic Program Load	150	15	700	
	Model	Rental		Purchase		Maximum No. Stations Per Control	Disk Storage			
Keyplex (multi-station)	5500	\$1,400 plus \$85 per station per month		\$67,200 plus \$4,100 per station		64	7.2 million bytes		8-400	

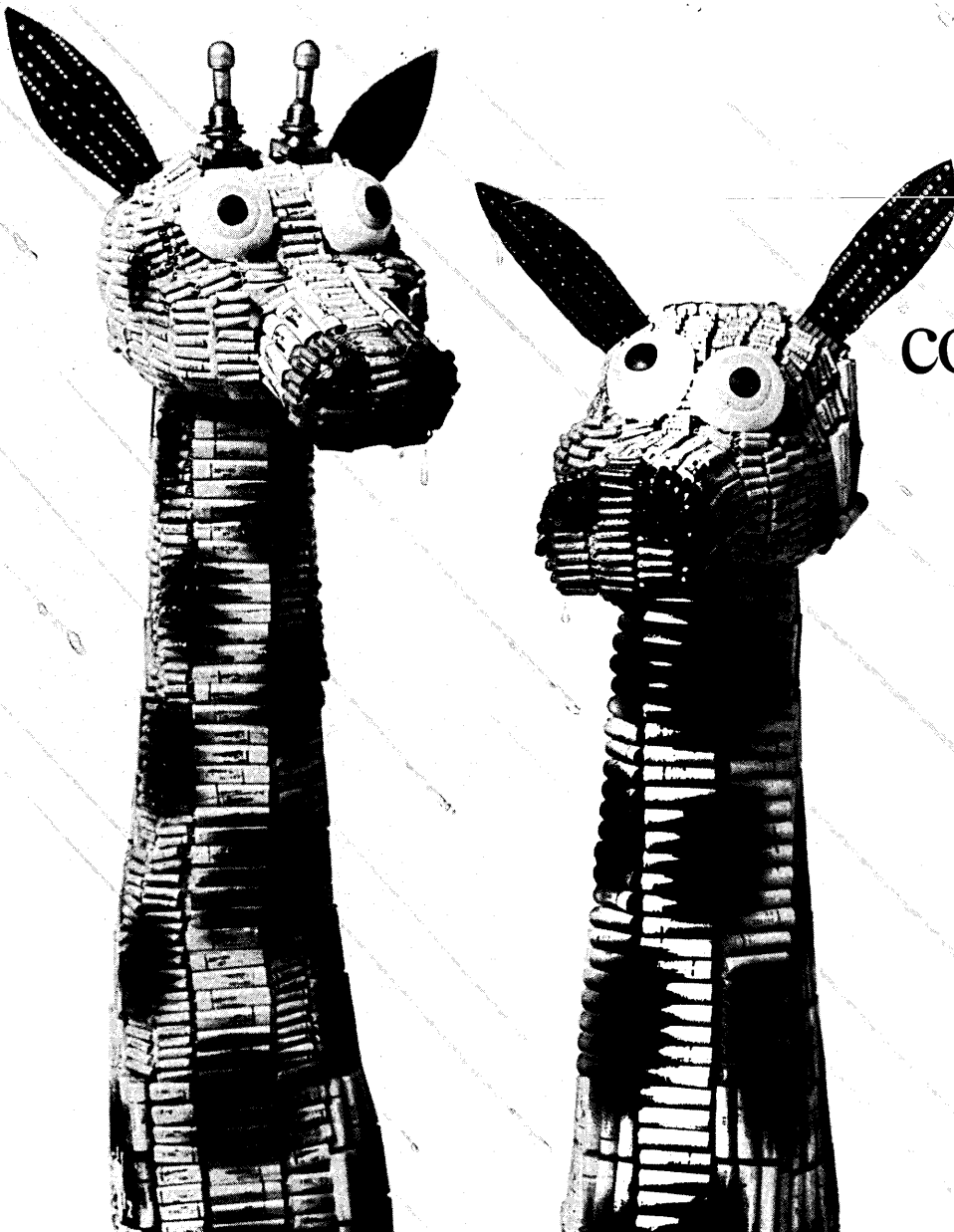

Here's how
 The Other
 Computer
 Company
 covers the care
 and feeding
 of your
 computers.

Data Communications							Media Conversion				
Product Name	Model No.	Speed (bps)	Monthly Rental (1 Yr. Lease)	Purchase Price	Off-Line	On-Line	Product Name	Model No.	Speed	Monthly Rental (1 Yr. Lease)	Purchase Price
Standard Speed Communicator	710	1200 switched; 1800 leased	\$85	\$2,600	Yes	Yes	Card Reader	711, 911	120 cards per min.	\$164	\$4,910
	910	1200 switched; 1800 leased	85	2,600	Yes	No	Line Printer	715, 915	300 lines per min.	505	22,760
High-Speed Communicator	760	2000 switched; 2400 leased	140	4,900	Yes	Yes	Paper Tape Reader	716, 916	270 char. per sec.	117	3,770
	960	2000 leased; 2400 switched	140	4,900	Yes	Yes	Serial Printer	717, 917	15 char. per sec.	177	5,710
Record Type/Size	Formats/Programs		Special Software Provided		Pooling		Output Tape		Special Features		
char. any field size	9 at a time/999 total		<ul style="list-style-type: none"> ■ Simultaneous Data Transfer ■ Operator's Analysis ■ Batch Balance ■ Check Digit Control 		Disk to tape		7- or 9-channel 556-800 bpi		<ul style="list-style-type: none"> ■ 4 displays: 3 numeric plus 1 alphanumeric ■ Supervisor's Console ■ Complete status Panel Display 		

Data entry systems:

Honeywell has expanded its line of highly versatile and efficient keyboard-to-tape data entry equipment. Keytape single-station units now meet a variety of applications in data communications, media conversion and data preparation. For users with large volume input requirements, Honeywell's new Keyplex system accommodates as

many as 64 key-stations simultaneously. The computer-controlled system records the data on a disk for later translation to magnetic tape.

Supplies and Accessories:

Disk packs, magnetic tape, printer ribbon, and accessories are marketed also to fulfill Honeywell's commitments to users' needs.

Terminal systems:

Data communications terminals are fast becoming a part of most new computer systems. And Honeywell is fast becoming a leader with terminal devices for visual display, hard copy, and voice response. Flexible display formats and terminal configurations are available across product lines.

Designation	Type	Rental/Mos.	Transmission Speed	Line Length	Character Set	Special Features
370 Teller Terminal	Remote transaction Recording	\$200. plus \$200. per terminal	1200-2400 baud	Journal tape or passbook width	36 Special Keys	<ul style="list-style-type: none"> ■ On-line Banking Passbook Operation ■ Series 200 Interface
2300 Series	CRT	\$230.	1200-2400 baud	80 Characters (960 Characters Capacity)	43 alpha 16-function	<ul style="list-style-type: none"> ■ Upper/Lower Case ■ Monitor Available ■ Series 200 Interface
VIP 765, 775, and 785	CRT		1200-2400 baud	46 Characters (2024 Capacity)	Standard Keyboard plus function keys	<ul style="list-style-type: none"> ■ Simplified Edit and Format Operation
Audio Response	Voice Answer-Back	\$1300.	110 baud (max.)	—	Voice Records	<ul style="list-style-type: none"> ■ Series 200 Interface
2440 RTT	Remote Batch Entry	\$700-1000.	3000 baud	Data Blocking: 200-400 Characters	—	<ul style="list-style-type: none"> ■ Card Reader and Punch ■ Line Printer ■ Series 200 Interface
DATANET* 730 Series	Teletypewriter	\$110.	110 baud	75 Positions	64	<ul style="list-style-type: none"> ■ Paper Tape Reader Punch
DATANET* 760 Series	CRT	\$620.	1200-2400 baud	46 Characters (2024 Capacity)	Standard Keyboard plus function keys	<ul style="list-style-type: none"> ■ Simplified Edit and Format Operation
TermiNet SRT-301	Teleprinter	\$145.	10-15-30 cps	118 Positions	Full ASCII	<ul style="list-style-type: none"> ■ Upper/Lower Case ■ Paper Tape Reader Punch

*Registered Trademark

The Other Computer Company has something for everyone.

We have an incredible range of products and services.

We have computers, application packages, and OEM equipment, and time-sharing, and information services, and education services, and data preparation devices, and terminals — in a dazzling array of sizes, speeds, and prices.

We have, in fact, everything anyone could want in the way of information systems.

But we offer something more important.

We offer understanding. We understand that you're not buying

a computer so much as you're buying the solution to problems. And we understand that in order for your computer to work, and keep working for you, the way it was intended, takes a little dedication on our part.

That's why Honeywell maintains a ratio of nine technical support people for every sales person.

That's why we've got twice the field support we had only a short while ago.

That's why we have 3,000 field engineers and 5,000 sales, systems and support people.

That's why, in fact, man for man, system for system, we offer the computer user more support than any other computer company afloat.

For more information about a specific product or service, just drop a note to Honeywell Information Systems (MS 261), 200 Smith Street, Waltham, Massachusetts 02154.

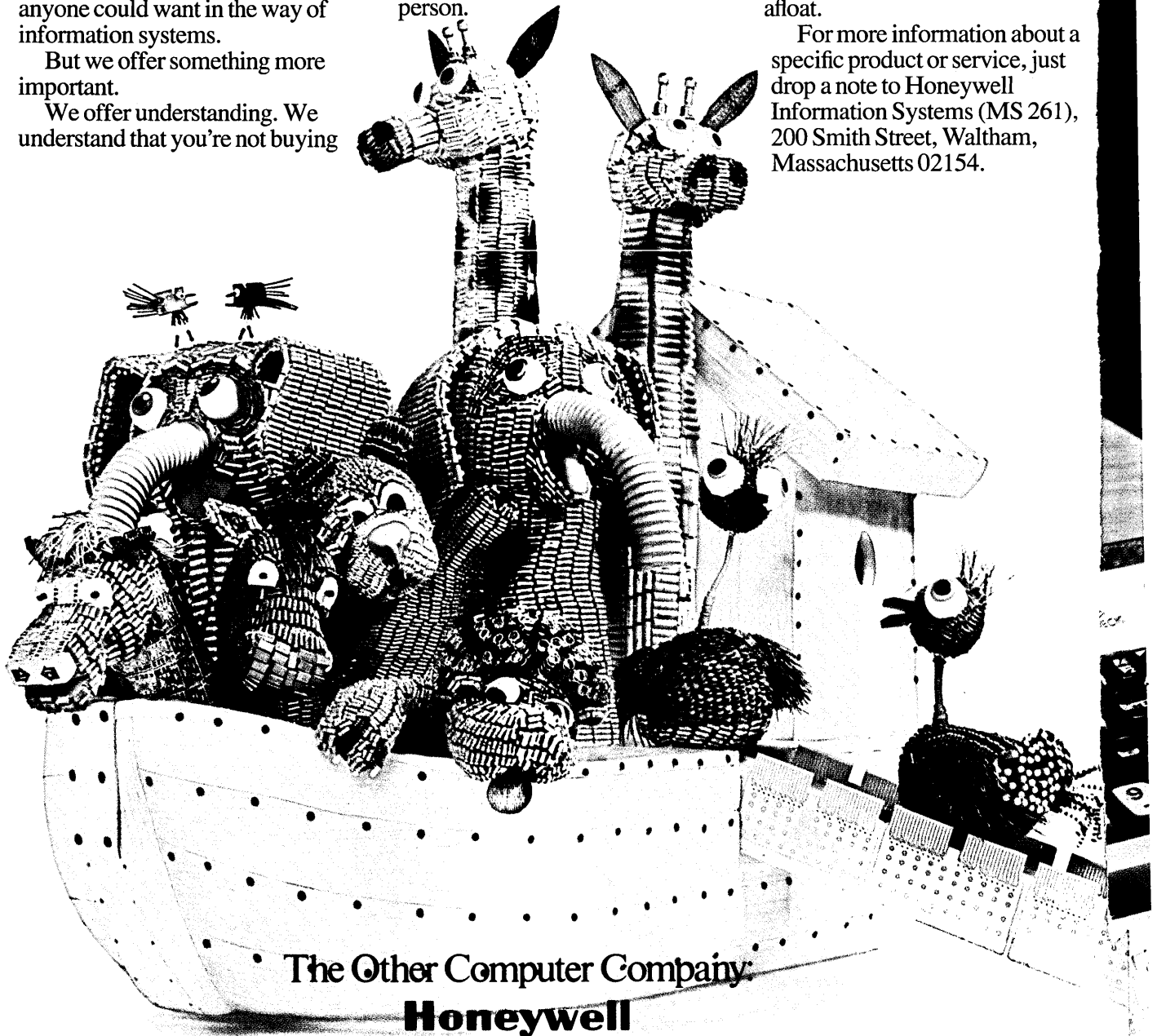

The Other Computer Company
Honeywell

NEWS SCENE

what circumstances, Sicom is to be "detrified." In other words, the ultimate result could be that Sicom remains, as it is today, a regulated communications service. What happens to Sicom is important because it represents the first time a carrier has tried to offer a commercial dp service through an unregulated subsidiary and run into problems at the FCC. Other carriers want to offer similar service on the same basis. This prospect gives many service bureau operators the willies; they don't relish competing with companies that, in many cases, supply them with vital communications services and have far more money in the bank besides.

The desirability of allowing the carriers to offer dp services through unregulated subsidiaries was at the heart of FCC's computer/communications inquiry, concluded last April. The upshot of that exercise was a tentative decision allowing all of the carriers (except AT&T and its subsidiaries) to establish dp affiliates under certain constraints. DP industry spokesmen say the constraints are inadequate.

The basic question at the moment is whether the final decision will be a carbon copy of the tentative one, or be rephrased to answer at least some of the objections raised by industry lawyers. The commission's recent decision on Sicom gives the industry a reason to be optimistic.

The key point is that the commission won't decide whether to detriff Sicom until *after* it has issued a final policy statement in the computer/communications inquiry — i.e., until it has determined whether to let all non-AT&T carriers into the dp services business.

If the commissioners had OK'd Western Union's original proposal, which called for deregulating Sicom on Jan. 1, 1971, the other eligible carriers would have immediately trooped over to FCC with similar plans; the commission — with one approval on the record — could hardly say no to the others. As a result, the key issue raised in the computer/communications inquiry would be resolved by the carriers, not by the FCC.

The most interesting question in this whole complex scenario is why Western Union, last December, proposed to detriff Sicom. Assume for a moment that the company

waited until *after* the final decision in the computer/communications inquiry was announced, and that this decision allowed Sicom to be offered on a loosely regulated basis by a WU subsidiary. Western Union could then unveil its detriffing plans without worrying too much about objections. For, if dp industry lawyers squawked, they would be arguing with the FCC not the carrier.

Instead of waiting, however, WU unveiled its Sicom plan before the commission disclosed its final decision. Bunker-Ramo, ADAPSO, and BEMA, the chief opponents of carrier-operated commercial dp services, promptly filed opposition comments. B-R's statement was especially interesting.

The company accused the carrier of expanding Sicom beyond the limits imposed by the commissioners in 1967, when they allowed the service to be established. In addition, Western Union was charged with unfair competition.

B-R offers several securities infor-

mation services that compete directly with Sicom and depend on WU communication circuits. According to Bunker-Ramo's December statement, Western Union installers and repairmen have been giving B-R customers lousy service.

These charges were filed originally several months ago, in a separate proceeding, so the commissioners probably weren't surprised by what Bunker-Ramo had to say last December. On the other hand, the earlier complaint hasn't proceeded very far through the FCC pipeline, so the commissioners may not have been aware of all the details Bunker-Ramo brought to their attention in December. In any event, Western Union clearly didn't do itself any good by giving B-R, ADAPSO, and BEMA another opportunity to tell their stories to the commissioners.

It's difficult to believe Western Union officials weren't aware of what would happen if they announced plans to deregulate Sicom in December. Yet they went ahead anyway. Did

**1000 Cards Per Minute
for**

\$3395.00 *

SPEAKS FOR ITSELF

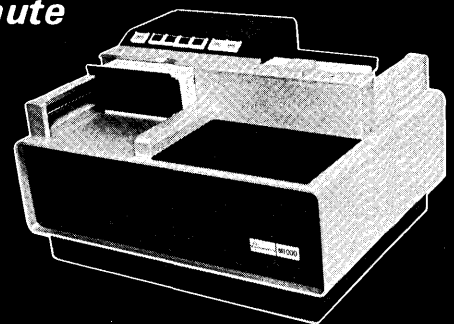

WE'LL SPEAK FOR THE M 1000

Documation built the M 1000 for people who require a card reader to operate. . .

- without jamming
- at a rate of 1000 cards per minute
- with 1000 card hoppers
- month after month, consistently and accurately.

We designed a card reader for people who want to load and

unload on the fly. The M 1000 is for people with new cards who want them to stay new. And for people with old or damaged cards who don't want their card reader jamming.

There's really a lot more to be said about the M 1000, but we think \$3395.00 is a good place to begin.

* unit price.

Call or Write. . .

841 East New Haven Avenue
Melbourne, Florida 32901
Telephone 305/724-1111

DOCUMATION
INCORPORATED

ERROR

INFOREX



**GOOD
NEWS!**

The INFOREX Intelligent Key Entry™ System just caught another error before it became costly.

Every element of this System including the CRT display and flashing red indicator light is designed for faster input with fewer mistakes. The CRT display not only tells the operator when she makes an error, it displays the full record as she enters it. Helps avoid duplicated or omitted data.

Correction is easy. Just backspace and rekey the proper character. Smooth and simple. Any keystation can sight and key verify the work of any other keystation—with the same ease of correction. Result: Even greater efficiency in error detection and correction.

Write for full data to help evaluate the price/performance leadership of the Intelligent Key Entry System in your operation. We would also be pleased to have you check with present users on System performance and service.

Write Inforex, Inc., 21 North Avenue, Burlington, Mass. 01803 or Inforex AG, Dornacherstrasse 210, Basel, Switzerland.

EIGHT KEYSTATION SYSTEM FOR \$120 A MONTH PER STATION

Up to eight keystations input to a memory and logic control unit capable of storing 128 program controls. Any keystation can check the work of any other by full record CRT display or key verification. Completed jobs are transferred to 7- or 9-track computer compatible tape or, with on-line option, directly to a central processor.

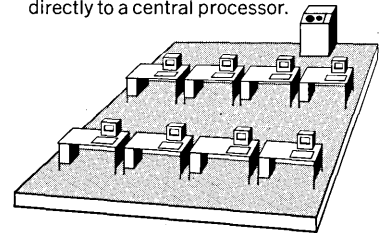

 **INFOREX**

Our Security System was so good, we had to change it.

When we invented a card that took the place of a key, everyone knew we had a great idea. But to make it work for everyone that wanted it required a few changes and improvements.

To make our system as versatile as a regular lock, we developed a flush mount, a glass door mount, a weather proof mount, and even a chain link fence mount.

Then we made it programmable. This means you can change the combination simply by inserting a different program card. And for safe-guarding classified information, our Memori-Lock™ requires a proper sequence of button pushing to open the lock, with or without a CardKey.

We've even made it so it will print the card number, date and time of each entry and exit, and to sound an alarm if a lost or stolen card is used. For more information on how our new improvements can protect you, mail this coupon.

CARDKEY SYSTEMS

Subsidiary of Liquidonics Industries, Inc.
P.O. Box 369
Chatsworth, Calif. 91311
(213) 882-8111

SEND INFORMATION FAST!

Name _____ Title _____

Company _____

Address _____

City _____ State _____ Zip _____

CIRCLE 41 ON READER CARD

they learn privately that the FCC had already come to a final decision in the computer/communications inquiry and that it would be much closer to the industry's wishes than the tentative decision? This seems to be the only logical explanation.

NASDAQ on the Air with OTC Trading System

NASDAQ, the over-the-counter stock trading system and Bunker-Ramo Corp.'s latest endeavor for the financial community, is on the air. It also appears that there will soon be airing of concern for what NASDAQ will carry and what equipment some of its subscribers will use.

One brokerage firm has already filed a court complaint because NASDAQ does not provide quote information on stocks listed by the exchanges. And the vendors of other computer-based quotations systems, Scantlin and Ultronic, are muttering about B-R's prime role in the system.

The concern of the service vendors increased as the system neared completion and centers on B-R being the sole supplier of control hardware and NASDAQ terminals to market makers and stock retailers. However, when they were competing with B-R for the contract, no one found fault with these provisions.

B-R signed a seven-year development and operation contract with NASD (National Association of Security Dealers) in January 1969. It has agreements with around 1200 market makers (level III service) and stock retailers (level II service). All three service vendors, B-R, Ultronic, and Scantlin, provide service to registered representatives (level I) in combination with their existing quotation information. It has been estimated that B-R will realize over \$15 million in annual revenues from NASDAQ.

Of the competitors, Ultronic is the more concerned that it can't supply terminals to levels II and III subscribers. However, it has yet to take any formal action. Scantlin may be reluctant to take the initiative since its president, Milton Mohr, signed the NASDAQ contract when he was president of B-R.

Canadians Prepare for Communications Network

A task force to prepare plans for an integrated network of computer utilities has been appointed by Canada's Communications Dept. Its job: to recommend the policies and institutions that will ensure the orderly development of a trans-Canada computer communications network which has an important element of Canadian ownership.

It will recruit about two dozen experts from government, industry, and the universities with a target reporting date of late 1971. Heading the task force is Hans Jacob von Baeyer, who has resigned as president of Acres Intertel Ltd., a communications consulting firm based in Ottawa. The task force will deal with issues of privacy, Canadian ownership, system flexibility, national availability of services, and timing of new services.

The Trans-Canada Telephone System has also set up its own research group to analyze the role of the telephone companies in a trans-Canada computer communications network.

NEWS BRIEFS

I/O Standards Guideline

The International Standards Organization group on interfaces has accepted as its guide for future work on I/O interface standards a procedure adopted earlier this year by X3T9, the BEMA-sponsored ANSI committee on Input/Output interface standardization. The procedure calls for the development of specific and detailed I/O interface requirements which can be used to accelerate and enhance both the creation and evaluation of proposed standard I/O interfaces. A list of requirements submitted by X3T9 will be an item of discussion at the ISO interface group meeting this fall.

FJCC Call for Papers

Application papers on such topics as urban planning, environmental control, education of the disadvantaged, planning for change in highly industrialized nations, and accelerating pro-

gress of emerging nations are on the most-wanted list for the 1971 Fall Joint Computer Conference to be held Nov. 15-18 in Las Vegas. The Call for Papers was issued in December. Deadline for submission in April 1. Theme of the Conference is "Computers and the Quality of Life." Abstracts and drafts should be sent to Dr. Martin Y. Silberberg, Technical Program Chairman, 1971 FJCC, P.O. Box 11337, Palo Alto, Calif. 94306.

Communications & Banking

The Bank Administration Institute, mid-stream in a joint effort with the Federal Reserve System, Bank Wire, Interbank Card Assn., National BankAmericard, Inc., Special Committee on Paperless Entries (SCOPE) and Tele-Net, to develop communications standards in banking, has published a research study, "Communications Standards for Banks," covering the need for and importance of standards and reviewing current data exchange activity in commercial banking. Copies are available from BAI, P.O. Box 500, Park Ridge, Ill. 60068 at \$8.

Datagen Healthy in Hull

Datagen of Canada Ltd., which is 93% owned by Data General Corp. of Southboro, Mass., is now shipping three minicomputers a week from its new 15,000-sq. ft. plant at Hull, Quebec. The company manufactures Nova and Supernova machines under license from Data General. Close to 60 people will be employed in the new plant by mid-'71, according to company president Juan Monico. "We are making every effort to buy as many of our components in Canada as possible," says Mr. Monico.

Canadian Journal to Bow

"Infor," a three-times-a-year journal on operational research and information processing, will be published this year by the Canadian Operations Research Society and the Canadian Information Processing Society. First issue will be in March with six papers based on disciplines of both groups and a forum section with nontechnical discussions on trends. Subscriptions may be applied for from Infor Journal, P. O. Box 2225, Station D, Ottawa, Ont. Price is \$5 (\$10 for nonmembers).

MERGERS, ACQUISITIONS

A soft economy forced many mini-computer manufacturers to revise their business projections downward, and at the end of last year at least two consolidations had been announced. Both were in Southern California's Orange County. **Tempo Computers, Inc.**, of Fullerton, sold out to **General Telephone & Electronics Corp.**, which made it a part of its GT&E Information Systems unit and announced the company would continue with the same management, headed by J. Edward McAteer, president. In nearby Irvine, meanwhile, **Monitor Data Corp.**, which had been building a \$3,000 computer, was acquired for stock by **Microdata Corp.** of Santa Ana. Microdata, also a minicomputer maker, had been trying since the spring to go public and was in registration at the time of the Monitor buy late last year. Other corporate marriages: **Computer Network Corp.** surren-

dered 600,000 shares of common stock to acquire the computer business of **U.S. Time-Sharing, Inc.** ... **Tracor Computing Corp.**, Austin, Texas, acquired two Canadian firms specializing in consulting and computer modeling for the Canadian petroleum industry: **D&S Petroleum Consultants, Ltd.**, and **Applications Development and Engineering Group** ... **Allied Management & Systems Corp.**, NYC, acquired an 80% interest in **Computer Methods Corp.**, White Plains, N.Y. ... **Leasepac Corp.**, Cleveland, agreed to acquire the computer disc pack division of **Datapax Computer Systems Corp.**, NYC ... **Hathaway Instruments**, Denver, acquired **Century Electronics & Instruments**, a division of Century Geophysical Corp. Among the division's products are digital printers.

(Continued on page 68)

Confused about which Cassette Tape Transport to use?



do what more than 200
manufacturers have done

Get DigiDeck...

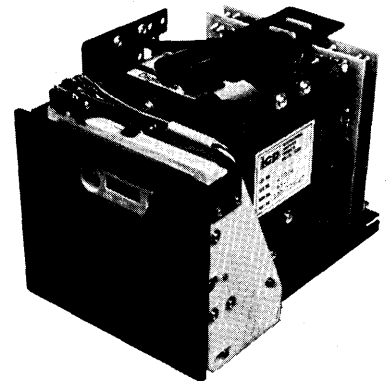

Get

- Read and Write speed over 500 char./sec.
- Complete Interchangeability
- Read and Write electronics, EOT/BOT Electronics
- BMS encoding option available
 - complete error check
 - reverse read capability

Delivery in 30 days ARO
Get the facts. And Specs!

Write

icp INTERNATIONAL
COMPUTER
PRODUCTS, INC.

P. O. Box 34484 • Dallas, Texas 75234
CIRCLE 43 ON READER CARD

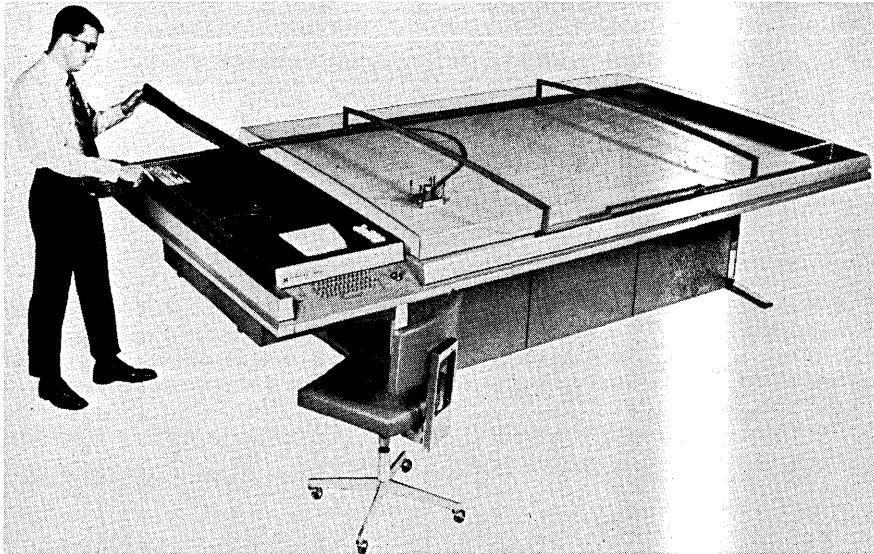

New York architectural firm Saphier, Lerner, Schindler, Inc., is using the Model 1000 computerized drafting system developed by Xynetics, Inc., Canoga Park, Calif. (June '69, p. 123), to do the complete interior space design for Chicago's new 110-story Sears Tower, which will be the world's tallest building. Xynetics says its machine provides drawing speeds up to 40 ips, with repeatability of 0.001 inch. It won't be in the Sears catalog.

NEW COMPANIES

Anticipating a 300-400% growth in the graphics area of the computer industry in the next two-three years, Thomas A. Larson, formerly vp of Delta Data Systems, formed **Applied Computer Graphics**, Washington, D.C., to provide software support, equipment selection studies, system design, programming services, and proprietary computer systems to users of computerized graphic systems ... Computer Horizons Corp., New York City, set up a wholly owned subsidiary, **Rizons Brokerage, Inc.** to handle its time and equipment brokering activities ... **Ampex Credit Corp.** was formed as a wholly owned subsidiary of Ampex Corp. to finance long-term accounts receivable of the Ampex video products division and full payout leases for the Videofile information systems division ... Proprietary Software Systems, Inc. created a new **Systems Div.** to provide a systems integration service for minicomputer users ... **International Mathematical & Statistical Libraries, Inc. (IMSL)**, was organized in Houston to provide services, including an "extensive computer library of mathematical and statistical procedures." ... Operations Research and Computer Corp.

(ORAC) formed a new subsidiary, **Automated Transactions Corp.** to specialize in edp services for retail stores ... In Palo Alto, Calif., **Executive Technology Corp.**, which bills itself as not a software company, service bureau, consulting firm, time-sharing firm, package sales organization, or facilities management company, began offering what it calls "Manufacturing Resource Management." ... And on the international front: **Asiadata Ltd.** was formed by International Computers Ltd., Jardine, Matheson & Co. Ltd., and Barclays Bank D.C.O. to operate a computing service bureau in Hong Kong using an ICL 1902A computer ... **Edutronics Systems International Inc.** established an affiliate in France through an exchange of contracts with **Institut Etude Mejur Productiv (IEMP)** through which it will offer its instructional programs in French and sell them in the French-speaking areas of Europe and North Africa.

Shortlines

A proposal for a domestic satellite communications system with a total capacity of 10,560 voice-grade circuits has been filed with the FCC by

General Telephone & Electronics. The proposed \$27 million multipurpose system would relay telephone calls, facsimile, data, and tv signals between earth stations in California, Florida, Indiana, and Pennsylvania ... A 75-day retrospective review of stock market action is part of a new computerized service for banks, brokerage houses, and insurance companies called **Telprice/70 Historical Pricing File** being made available for from \$4K to \$10K per year by **Telstat Systems Inc.**, New York City ... **Hughes Aircraft Co.** will build a new solid-state ballistic computer system to direct gunfire of the M60A1 tank under a \$1.5 million contract from the Army ... The prototype of the World War II bombing computer that helped make possible "blind" bombing at high altitudes back in 1944 was presented to the Air Force museum by **Harris-Intertype Corp.** whose **Harris-Seybold Div.** developed the device to replace the well-known Norden bombsight in the latter stages of the war ... **Interdata** has sold three of its Model 4 minicomputers to **Pan American Petroleum Corp.**, Tulsa, for \$87K, its first dent in the petroleum industry market ... **Data Card Corp.**, Edina, Minn., producer of equipment for embossing and encoding credit and other identification cards, has moved into the Japanese market via an agreement with **Takachino Koheki**, Tokyo marketing firm specializing in data processing equipment ... Japan's largest securities firm, **The Nomura Securities Co. Ltd.**, moved into full operation of an 1108-based **OLRT** system for updating accounts on 20,000 stock transactions daily ... **Systems, Science and Software (S3)**, La Jolla, Calif., scientific computer software services firm, said it will order a \$2.5 million **Univac 1110** to be delivered late this year ... **General Dynamics' Electro Dynamic Div.**, Orlando, Fla., will analyze application of communications systems and computers for water control purposes under a contract from **The Southern Florida Flood Control District** ... A five-day course covering the latest developments in laser technology and exploring the future of laser systems is scheduled for March 8-12 at **Washington Univ.**, St. Louis, Mo. It is designed for engineers and scientists with experience in a related technology. ■

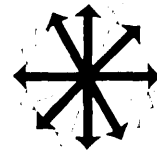

HARDWARE

Small-scale Computer

Groomed for head-to-head competition with IBM's System/3, the Century 50 is upward compatible with the remainder of the Century series, runs "most" of the applications programs that have been running on the other series members, and is programmed in NEAT/3, which also has been around long enough to be checked out. The junior member of the Century series presents an interesting contrast to IBM's approach of making the System/3 incompatible with upward "System" members and necessitating a rewrite of much of the software.

It's back into the thin-film rod memory part bins for constructing up to 32K of 800 nsec memory on the byte-oriented 50, with 16K being standard issue. What can't be stored in memory can probably be accommodated by the 8.4 megabyte dual-disc storage unit. Also standard for



PRODUCT SPOTLIGHT

\$1500/month are a 300-cpm reader, and a 200-lpm printer. Faster versions (300- and 450-lpm models) of

the printer are offered as options. First deliveries are scheduled for this quarter. NATIONAL CASH REG-

ISTER CO., Dayton Ohio. For information:

CIRCLE 310 ON READER CARD

Keypunch, TTY Terminal

The addition of a translator interface between a Teletype unit and keypunch combines the devices into an on-line terminal capable of card and tape punching and reading and hard copy printout.

The combined unit is called the Computertalk terminal. Two versions are available: System 240, a 33 ASR Teletype with IBM 024 keypunch, priced at \$5600 to \$6600; and System 260, which makes use of the 026 keypunch, for \$6900 to \$7900. All Teletypes can be used except the 37 ASR, because of its ASCII configuration.

The translator provides ASCII to Hollerith/Hollerith to ASCII conversion. Conversion of 5-level code to Hollerith or to 8-level code or Touch-Tone and the reverse is also available. The unit can be purchased for use with already installed equipment for \$3200 to \$4200. The Computertalk terminals and the translator are also available on lease. LMC DATA, INC., New York, N.Y. For information:

CIRCLE 321 ON READER CARD

Magnetic Tape Units

Absence of a take-up reel on the model TMY tape unit may bother some people at first, but it's claimed that with the unit's "exact tape path and constant tension" one isn't required. Recording densities of 200, 556, and 800 bpi in IBM-compatible formats are offered for these 7.5 and 12.5 ips mtu's, which are priced at \$2K in batches of 100 (sans controllers).

A bigger brother of the TMY is the TM-8, which uses vacuum columns and a single capstan to control tape at 37.5 and 45 ips speeds. The 7-track version offers any two packing densities from among 200, 556, or 800 bpi, while the 9-track version can be ordered with 1600-bpi phase encoding electronics, as well as one of the other three densities. These units are priced at \$3950 in lots of 250. AMPEX CORP., Culver City, Calif. For information:

CIRCLE 343 ON READER CARD

DEC Peripherals

Among several products recently announced by this vendor is the model vt06 crt, which looks a lot like something Computer Terminal Corp. manufactures, but it is said that extensive modifications were required to allow the vt06 to attach to the PDP-8 family and the PDP-9, 10, 11, 12, and 5 minis. The keyboard has 97 characters (including control characters) for display of up to 1800 characters in 25 lines of 72 characters. The unit is priced at \$4900 and is available 60 days ARO.

Available for PDP-15 users are an 80-column and a 132-column line printer. With a 96-character set, the 80-column printer is clocked at 253 lpm; the speed jumps to 356 lpm for a 64-character set. The 132-column models are rated at 245 and 173 lpm for the 64- and 96-character sets. Prices range from \$14-21K. DIGITAL EQUIPMENT CORP., Maynard, Mass. For information:

CIRCLE 341 ON READER CARD

(Continued on page 70)

TTY Covers

The 1500 series tty enclosures are constructed of wood and noise suppressing foam which, it is claimed, reduces the noise level about 50%. The drop-on unit can accommodate multiple copy paper, and hinged covers provide access to the paper tape reader/punch. Options include special colors, a copy holder, acoustic couplers, etc. The 1501 has a cooling fan and is priced at \$190, while the model 1502 is priced at \$165 without a fan. Clamshell models are also available at somewhat higher prices. DESIGNED ENCLOSURES INC., Inglewood, Calif. For information:

CIRCLE 313 ON READER CARD

Commo Accessory

Installation of a SELECTRICOM communication controller to an IBM 2741 (or other Selectric terminal equipped with the reverse-break feature) adds unattended receive capability to carry on a dialogue with another terminal. The unit also allows sequential lines to be entered into computer buffers by suppressing the dump command. Options include an integral modem for replacing Western Electric model 103s, and a cassette unit. The SELECTRICOM is priced at \$595. TELLOG CORP., San Jose, Calif. For information:

CIRCLE 314 ON READER CARD

Minicomputer Printer

Available for most of the DEC, Data General, and the Univac 1219 computers is the BI-1215 bar printer. Up to 300 lpm are printed using a linear 64-character font mounted on an oscillating lateral carrier—which is said to produce better print quality. The 1215 can also be obtained with 96- and 128-character fonts, and even Japanese. Fonts can be changed in the field in a few minutes, it is claimed. The BI-1215 bar printer is priced at \$9440, and an interface for a PDP-8 costs an additional \$1550. BRIGHT INDUSTRIES INC., San Francisco, Calif. For information:

CIRCLE 315 ON READER CARD

Graphics I/O

One way to input graphic data to a 360 without going through time-consuming xy point location and identification is with the model 9285 digital facsimile scanner. Documents accommodated can measure 54 inches in width and be of infinite length, but only 18" wide sections of the input are scanned—at 5-10 inches/minute. Points of the scanned document are sequentially converted into coding at 96 points per inch ver-

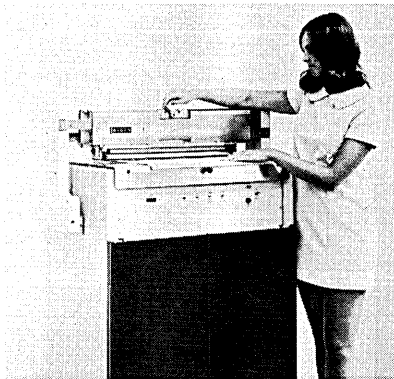

tically. The 9285 then generates the xy location.

After the data has been modified by computer processing, the 9285 can then plot it out on standard facsimile paper. The model 9285 facsimile scanner is priced at \$17K, but interfaces for it might run \$35K. ALDEN ELECTRONIC & IMPULSE RECORDING EQUIPMENT CO., Westboro, Mass. For information:

CIRCLE 316 ON READER CARD

Message Switching

Depending on the amount of message traffic an installation handles, an I-7000 system would have from three to five minicomputers capable of handling 180,000 messages (averaging 200 characters) per hour. Moreover, the I-7000 can be configured specifically for switching messages between up to 14,400 terminals, or can be attached to a large-scale computer for communication processing chores. Half- and full-duplex, synchronous or asynchronous transmission modes can be accommodated.

An interesting feature of the I-7000 is that one of the five minis oversees the performance of the others, and in the event of failure, assumes the role of the defective component. Both fixed- and moving-head disc storage is utilized. Prices for the I-7000 start at \$350K and go up to \$600K for a full five-processor system. INTELECOM, Minneapolis, Minn. For information:

CIRCLE 317 ON READER CARD

Instrument Coupler

One of the possible uses for a DATOS 305 coupler would be as a "go between" for a tty and up to eight laboratory instruments that put out three- to seven-digit BCD coding. Then a user could dial up a computer, set up a program, and then turn the computer over to the instruments to feed in real-time data. The 305 can also be plugged straight into a computer.

Input from these instruments is usually parallel BCD, and by use of a 120-pin connector this coding is then sequentially formatted into either ASCII, EBCDIC, or EIA RS-358 form. The unit is capable of providing operational codes, special characters, and housekeeping functions. The DATOS 305 is priced at \$800. DATA GRAPHICS CORP., San Antonio, Texas. For information:

CIRCLE 311 ON READER CARD

Key-to-Disc

If you are looking for a key-to-disc system but aren't interested in paying as much as \$150K, which some manufacturers ask, consider the model 1140 KEY-DISC system. The basic architecture allows for 10 operator stations, which consist of ASR 33 tty's, and a shared processor. Including basic software, such a configuration would be priced at about \$60K.

Room for expansion up to 32 local or remote stations is there, and terminals need not be tty's—crt units can be fitted easily enough. The processor allows performing preliminary editing and verification, as well as table look-up functions. The edited data is then sent to an IBM 2311-compatible disc. Options for the system include an mtu and printers for hard copy records from the crt terminals. The 1140 KEY-DISC will be available in March. ECLECTIC CORP., Dallas, Texas. For information:

CIRCLE 330 ON READER CARD

Tutorial Terminal

One way to bring computers closer to non-computer-oriented people in the performance of their jobs is to make the terminal so smart that it can tell a user how to run it. That is the approach taken with the model 100 combination badge and card reader information terminal for use with the vendor's model 20 processor.

When an operator begins, the terminal tells him what to do next from a display of 40 message instructions. When an entry is correct, the computer acknowledges it. If the entry is wrong, the terminal informs the operator what to do to correct it. Up to

10 programs are resident in the terminal, and the model 100 has the ability to retrieve up to 100 programs from the computer. Up to 160 of these terminals can be accommodated by a single cpu.

Variable numeric data entries are made through the keyboard, which features 1¼-inch size keys. When the terminal is not in use, the current time is displayed.

The approximate price of a single model 100 is \$5K, or it can be leased for about \$125/month. FRIDEN DIV., SINGER CO., San Leandro, Calif. For information:

CIRCLE 312 ON READER CARD

Mini Discs

These oem disc units utilize IBM 2316 (or equivalent) packs for storing 23.5 megabytes of information. Data is accessed in an average time of 32 msec, and transferred at 312 KB. The 10-instruction command set permits pack formatting, address comparison, address skip, position recalibration, cyclic check, and status check operations. The iss 724 is available approximately 90 days ARO and is priced at \$18K in quantities of 100. INFORMATION STORAGE SYSTEMS, INC., Cupertino Calif. For information:

CIRCLE 318 ON READER CARD

Double-Screen CRT

At first a crt terminal with two screens may seem rather silly, but the vendor has a good pitch ready: The operator can retrieve and display on both screens simultaneously, then update information on one screen with continuing visual access to the original information on the other screen. This should be particularly advantageous in applications requiring frequent and rapid interrogation and update.

And the dual screen provides an extra page in memory that can be fully displayed without interruption, thereby facilitating composition, editing, and transmission of a complete message. Utilization of interactive time may be increased and throughput accelerated even in mundane operations: while data is being received or retrieved on one screen, the operator can key in other data on the other screen, ready for immediate transmission.

The unit uses two 9-inch monitors,

each displaying 20 lines of 40 characters. Code is ASCII, upper case. The keyboard may be either typewriter or teletypewriter format. Features include transmission speed control, mode control, editing, and the ability to dump two independent pages of data to two printers simultaneously. The price is \$4,150 and leases are available. Delivery requires 30 days ARO. COMMUNITYTYPE CORP., New York, N.Y. For information:

CIRCLE 345 ON READER CARD

Printer and Terminal

Lots of interesting things have happened to the Model 4800 printer since June 1969 (p. 170). It has been expanded to an 11-inch width, giving it a full 132-column capability (originally it debuted as an 8.5-inch unit, good for 100 columns) and has been renumbered the 4800-11. The model number of these electrostatic printers is its rating in lpm, and the

unit can also do graphics.

Additionally, the 4800-11 has been made a principal member in the Model 4800T on-line/off-line remote terminal. Basically consisting of a terminal controller, the printer, and an interface, the unit can be expanded to include a crt device, as well as a modem for 2000-baud operation over dial lines, or 2400/4800-baud transmission on leased lines. The 4800T can deal

with ASCII, EBCDIC, or other, non-standard codes, and check for transmission errors. Software packages are available for emulation of most remote terminal configurations, it is claimed. The basic terminal is priced at \$35K; adding a crt boosts the price to \$43K. The 4800-11 printer alone lists for \$10,900. GOULD INC., Cleveland, Ohio. For information:

CIRCLE 339 ON READER CARD

OEM Tape Unit

The model 979 mtu is a synchronous unit available with tape speeds ranging from 15-45 ips, seven or nine tracks, and 200, 556, 800, or 1600 bpi density. A single capstan drive, the 979 is said to be fully compatible with IBM tape formats. The vacuum column unit handles 10.5-inch reels and measures 19 x 24.5 x 12 inches. Prices start at approximately \$3100 in lots of 100. TEXAS INSTRUMENTS INC., Houston, Texas. For information:

CIRCLE 320 ON READER CARD

360 Core

The Mod 30+ will upgrade System/360 Model 30 computers from 16K bytes to 96K and is a plug-in replacement for IBM core. Mod 40+ and Mod 50+ core are also available. Prices of the 30+ are \$32K for 16K core; \$42,500 for 32K; \$74K for 48K, etc., including installation. Delivery requires about six weeks ARO. Rental is available. FABRI-TEK, INC., Minneapolis, Minn. For information:

CIRCLE 344 ON READER CARD

Programmable Coupler

Up to four computers, calculators, teleprinters, laboratory instruments, Data-Phones, or other devices can be run into the 2575A allowing them to talk to each other. Data and control signals from the various devices are converted into ASCII format using plug-in cards. The unit is programmed using either a programming pinboard in the 2575A, via punched tape, or directly from a computer. It is priced at \$1275. HEWLETT-PACKARD, Palo Alto, Calif. For information:

CIRCLE 319 ON READER CARD

It will pay you to have your own personal copy of Datamation Industry Directory...

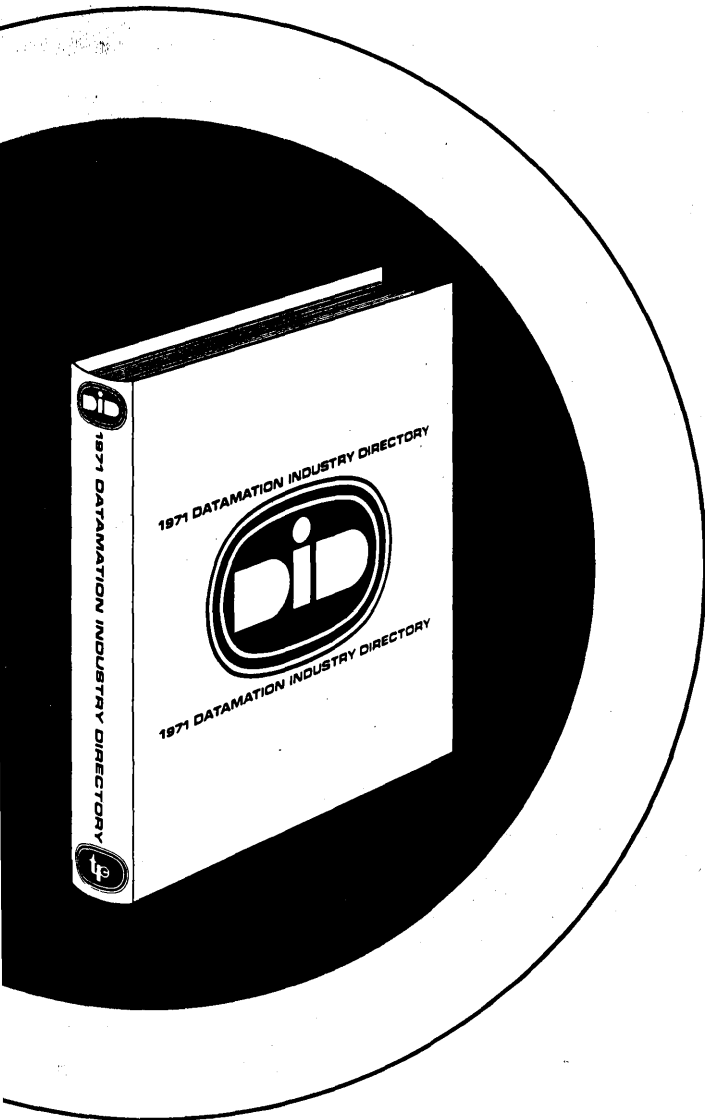

DID will be published by
 Technical Publishing Company
 Publishers of DATAMATION

Order it now!

The new 1971 DATAMATION Industry Directory will place an unprecedented amount of EDP marketing and sales information at your fingertips throughout the year. You can put your name on the cover of your own personal copy and keep it within easy reach. Even when you have to retrieve it from interested borrowers, you will still save many hours of valuable time.

DID will be the most authoritative and comprehensive single source of information about the entire EDP industry in print.

This comprehensive directory will offer basic information on 63 product and service classifications . . . and on nearly 5,000 companies that provide them. It will include all the basic data you need about speed, price, compatibility . . . plus company profiles that will enable you to screen and select those organizations, products and services most likely to meet your individual needs. Clearly organized and completely cross-referenced, the 1971 Datamation Industry Directory will put at your finger tips the vital facts you need to assess the complete range of the EDP industry's bewildering variety of hardware, software and services.

DID listings will be divided into these 11 major categories

1. Computers	6. Communications Equipment
2. Peripherals and Stand-alone Sub-systems	7. Auxiliary Equipment
3. Input Preparation	8. Supplies and Accessories
4. Unit Record Equipment	9. Environmental Facilities
5. Media Conversion Equipment	10. Software
	11. Services

Turn to one of these categories to find names of supplying companies. Reference to the Master Alphabetical Vendor List will quickly provide company address, and other basic information, including regional sales/service coverage. Ads in the DID will provide more detailed information about products and services.

DID will be published in the Spring of 1971

The Datamation Industry Directory will be delivered in May to all important OEM accounts, and to more than 31,000 computer installations selected from DATAMATION's 100% 1-year qualified, 100% requested, BPA-audited circulation. A restricted overrun of copies will be sold for \$25.00 each. Why not fill in the coupon and mail it today to get a personal copy for yourself?

A. Treat Walker, Manager
 Datamation Industry Directory
 35 Mason Street, Greenwich, CT 06830

Here's my check for \$25.00. Reserve a personal copy of DID for me.

Clip and Mail this coupon Today

Name _____ Title _____

Company _____

Address _____

City _____ State _____ Zip _____

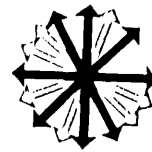

Univac Monitor

Speed-Pak was written by a group of ex-Univac employees who are said to have been associated with the development of the EXEC 8 system. Not surprisingly, Speed-Pak affects 1106s and 1108s running EXEC 8—offering throughput improvements typically of about 20%. What happened to EXEC 8 was that of the 1,000 separate routines that comprise it, 20 have been altered, and two have been thrown out and completely rewritten. The firm doesn't want to name what modules were played with since a patent application is pending, but they will say that Speed-Pak does a better job of handling peripherals, so a job stream that used 202 seconds of cpu time and required 362 seconds to get through an 1108 was able to finish the run in some 298 seconds using Speed-Pak, still using 202 cpu seconds, it is claimed.

After the one day required to get

Speed-Pak on the air, the changes made are said to be transparent to users, and no increase in storage space is required to house the Univac source language monitor.

Speed-Pak can be purchased for \$50K or rented for \$2500/month. During the first year of the lease 100% of the rental can be applied toward purchase. UNITED SOFTWARE CORP., Jenkintown Pa. For information:

CIRCLE 300 ON READER CARD

DEC Operating System

IBM may be in the minicomputer market now, chasing after those hordes of minimakers, but the minicomputer firms are still behaving like piranhas, biting away at the Giant. Now there's a new piranha, an IBM-1130-compatible disc operating software system featuring a FORTRAN IV compiler. The system was designed

to aid PDP-11 users in developing and executing a broad spectrum of software programs.

While a program is under development, the system serves as a software interface with the programs being written. When they are executed, the system provides common I/O device handling routines, loaders, and operator interfaces.

In addition to the FORTRAN compiler, the mini-DOS includes an editor, a symbolic assembler, a file management package, a link editor for linking routines of the assembler or the compiler, and an octal debugging package.

Delivery of the disc monitor will be in February, the FORTRAN compiler in April. The supplier remains bundled, offering software at no visible extra cost to customers. DIGITAL EQUIPMENT CORP., Maynard, Mass. For information:

CIRCLE 306 ON READER CARD

Remote HASP

HASP/RMTDOS is a modified version of HASP/360. Running on a 360/25 or up, the program uses multileaving and BSC to communicate with a central cpu executing HASP. RMTDOS offers essentially the same remote terminal facilities as the program requiring a dedicated computer, but oper-

ates in a 10K or larger foreground partition under DOS (only).

Hardware requirements include the BSC adapter and the appropriate unit record devices for each desired simultaneous read, print, and punch function. These peripherals and the communications adapter are dedicated to the partition in which RMTDOS is executing. Program execu-

tion requires that multiprogramming, multiple wait, physical and specific logical unit addresses for the console, BSC, and unit record devices be included in the supervisor. A 10-year lease is priced at \$2500. VILLANOVA UNIV., Villanova, Pa. For information:

CIRCLE 307 ON READER CARD

Cobol Shorthand

According to the developer, this is a complementary COBOL tool that eases the move to ANS COBOL. The 22K package is the blend of a dynamic table of abbreviations with a pseudo-macro generator. It expands abbreviated statements and processes them and regular COBOL statements either separately or in combination for all divisions of a program.

The resulting programs can be generated on card, tape, or disc in a format acceptable to the following compilers: Univac 1106 and 1108 ANS; IBM 360 D,E,F, and ANS; Spectra 70 COBOL A; Honeywell G, H, I, F, and Y; Burroughs B3500 and B5500.

The \$450 purchase price brings source and object decks plus operations instructions, and updates to the package. ATLANTIC SOFTWARE INC., Philadelphia Pa. For information:

CIRCLE 301 ON READER CARD

Packaged Inventory

Perpetual inventory control is the result of using Total Replenishment Inventory Program (TRIP). The package, developed by a company that has sold out of the machine tool parts distribution business to run service bureaus, is a BAL batch program. It requires a 360/30 and 32K of storage, and in return will automatically keep track of daily turnaround of up to 200,000 items.

A proprietary formula evaluates item usage and projects requirements each time an item is pulled from inventory. Inventory reports with projections are made daily, and a monthly statistical report is generated.

TRIP is available for around \$800 a month with installation and maintenance. POWER COMPUTER SYSTEMS, INC., Rutherford, N.J. For information:

CIRCLE 308 ON READER CARD

Decision Tables

TABTRAN (Table Translator) is a software package for processing decision tables. It is currently available for COBOL programming and will operate with IBM 360 OS and DOS. A FORTRAN version is under development.

The package translates specially formatted decision tables into COBOL source language. The source coding may then be combined with existing COBOL source programs, or it can be linked with the main line program as a decision-making or logical section.

TABTRAN requires 24K of core exclusive of a supervisor, which means the minimum system is on the order of a 32K Model 30. The package is available for \$3200 on a five-year lease. The price covers a source deck, installation, and maintenance. WESTINGHOUSE TELE-COMPUTER SYSTEMS CORP., Pittsburgh, Pa. For information:

CIRCLE 309 ON READER CARD

(Continued on page 74)

Display System

Primarily for use with the vendor's proprietary System '70 mutual fund accounting system is a new visual display module allowing real-time inquiry into shareholder account information and faster alphabetical searches of the files.

An interesting part of this module is a generalized routine much like the second-generation iocs that allows the interfacing of teleprocessing lines to be handled as simple I/O

statements of the application program. This routine is available separately for \$5K and might help develop an on-line system without the problems normally associated with teleprocessing functions. Since it is a macro-generated program, adding new terminals to a given configuration does not necessitate a rewrite of the program—only a recompilation.

Up to eight lines with 64 terminals per line can be handled by the display module without getting satu-

rated, it is claimed. It is basically set up for dos 360 systems and requires approximately 15K plus 1K for each terminal being supported. If it is included with the System '70 program, 45K is enough to handle two storage files and one line with two terminals. The price is \$25K. WESTERN OPERATIONS, INC., San Francisco Calif. For information:

CIRCLE 303 ON READER CARD

Computer Room MIS

The purpose of OMNIS is to inform dp management of what has been done, is being done, and remains to be done in the entire data processing operation. The 120K COBOL package runs under os/360 and is split into five parts: a scheduler for developing daily schedules for all the processing that allows projection of machine schedules, and outputs unusual condition notices and prior day's status report; a set-up module

for producing daily operational work sheets, such as set-up specifications, pull listings, and tape labels, and it also produces slave printing and bursting schedules; a job stream creation subsystem, said to require a minimum of operator response in execution of the day's schedule; a control and interface module that establishes data bases of all jobs and data sets, and runs in batch-processing mode to record jobs like slave printing and bursting; and a library maintenance routine that scans the data

set inventory file to produce the data set inventory and various report listings.

A dp manager controlling a large complex operation which involves thousands of tapes and data sets might find OMNIS the solution for getting the shop under tight control. The turnkey package can be purchased in part or totally, with leasing prices starting at approximately \$1-2K/month for the first year. CNA FINANCIAL CORP., Chicago, Ill. For information:

CIRCLE 305 ON READER CARD



PRODUCT SYSTEMS ENGINEER

BS-EE or computer/information science plus 2-5 years experience in Digital Machine Design and Programming. Duties include analysis, development and design of Firmware and Transaction Programs.

SYSTEMS ENGINEER

BS-MSEE, Computer Science plus experience in computer systems development and use of operations research tools. On-line system design experience highly desirable. Duties would include conception, evaluation and monitor development of advanced product lines of financial systems.

RETAIL PRODUCT SYSTEMS ENGINEER

BS in EE, Math or Physics plus 3-6 years experience in design for systems engineering. Duties include conception, development and preparation of system specifications, product design and recommendation of changes or modifications to our product design group.

Send resume in confidence to:

Mr. Vernon L. Mirre
Executive & Professional Placement
NCR
Main & K Streets
Dayton, Ohio 45409
AN EQUAL OPPORTUNITY EMPLOYER M/F

CIRCLE 504 ON READER CARD

Optical Design

A lens designer enters first-order parameters and specifies whether the lenses are to be singlets or doublets into the OPTICAL SYNTHESIS I program. Further input consists of the chromatic and monochromatic third-order properties desired in the prototype, and the program chooses the optimum glass from a selection, computes curvatures, and presents all the feasible thin lens solutions from which the designer can choose the one that best suits his needs.

A companion program called OPTICAL ANALYSIS I is used for evaluating and editing lens systems. Using this program, a designer performs third-order analysis and ray and fan traces in a conversational mode. Utility features are available for adding and deleting surfaces, scaling, reversing, and saving lenses.

Both programs are written in FORTRAN IV, are set up for time-sharing usage, contain numerous input error messages, and require about 128K bytes. The price of \$5K for both includes the source programs, documentation, and installation. OPTIMIZATION ASSOCIATES, INC., Pittsburgh, Pa. For information:

CIRCLE 304 ON READER CARD

Engineering Programs

Two groups of software packages are available for 8K 1130 or 64K 360 computers. The first group includes a program using the Hardy Cross method for the analysis of water flow distribution in a pipe network (\$5K), a storm sewer design program (\$2500), a Stadii and Theodolite note reduction program (\$2500), and a truss analysis program priced at \$1500.

The second group includes a traverse balance program (\$3K) and a traverse computing program that allows a user to store one or more known coordinates or to use a set of coordinates previously computed by the field note reduction and traverse balancing program, which then may be used as a base to compute the coordinates of other points where the geometric relationships between the established points and the desired points are known (\$3500). A traverse checking program (\$2500), a traverse staking program (\$500), and an 1130 version of the IBM COGO program used for coordinate geometry calculations (\$500) are also offered. A traverse plotting program for plotting coordinates computed by other programs in this group sells for \$2K. Also available are a traverse net balance program for balancing networks of traverses (\$2500), and a program for area segmentation (\$1500).

A discount of 25% for purchase of all the programs in the second group and a 30% off "special" on the entire set includes documentation, installation, and support. The programs are written in BASIC. NORTHWEST COMPUTING, Seattle Wash. For information:

CIRCLE 302 ON READER CARD

Library Maintenance

SLIM (System Library Maintenance) is a 9K BAL package for handling sequentially organized libraries on 360s, allowing individual programmers to maintain the continuity of each source program, preserving all alphanumeric in the sequence field. Users can thus employ their own mnemonic prefixes for program sections and insert alphanumeric suffixes. SLIM is priced at \$400, which includes operating instructions. SYSTEM IMPLEMENTATION CORP., New York, N.Y. For information:

CIRCLE 323 ON READER CARD

Financial Reporting

The user firm's financial reports are completely automated by INFO-TEM, according to the vendor. The system of 35 COBOL programs prepares the balance sheet; profit and loss statement; and produces condensed comparative statements, including current year vs. last year, budget vs. actual, variance analysis, and several other accounting functions. But if

your company isn't ready for the complete \$17,500 system, requiring a 35K 360/25 or larger, modules are available: maintenance, \$3500; P&L, \$2500; budget, \$2500; balance sheet, \$2K; general ledger, \$2K; trial balance, \$1500; departmental expense reports, \$2K; editing, balancing, and initializing, \$3500. COMPUTER RADIX CORP., New York, N.Y. For information:

CIRCLE 326 ON READER CARD

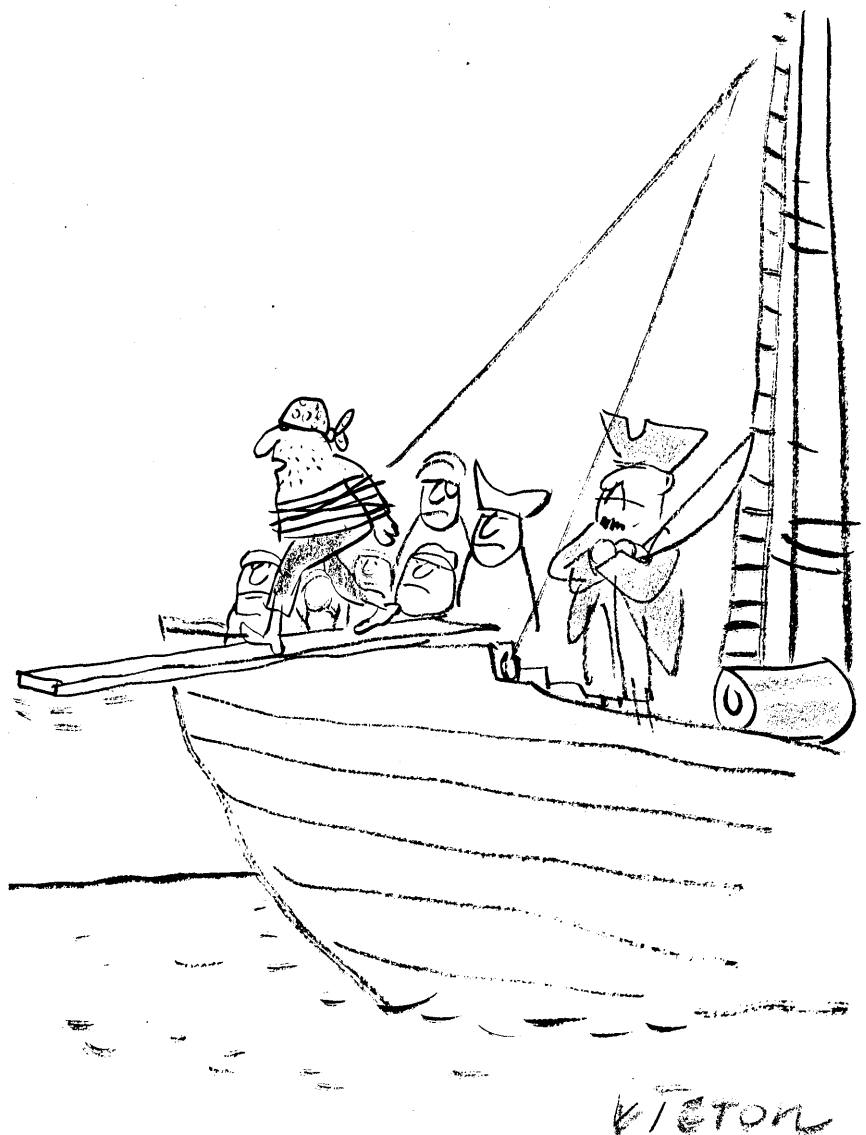

"Well, at least I got that off my chest."

© DATAMATION ©

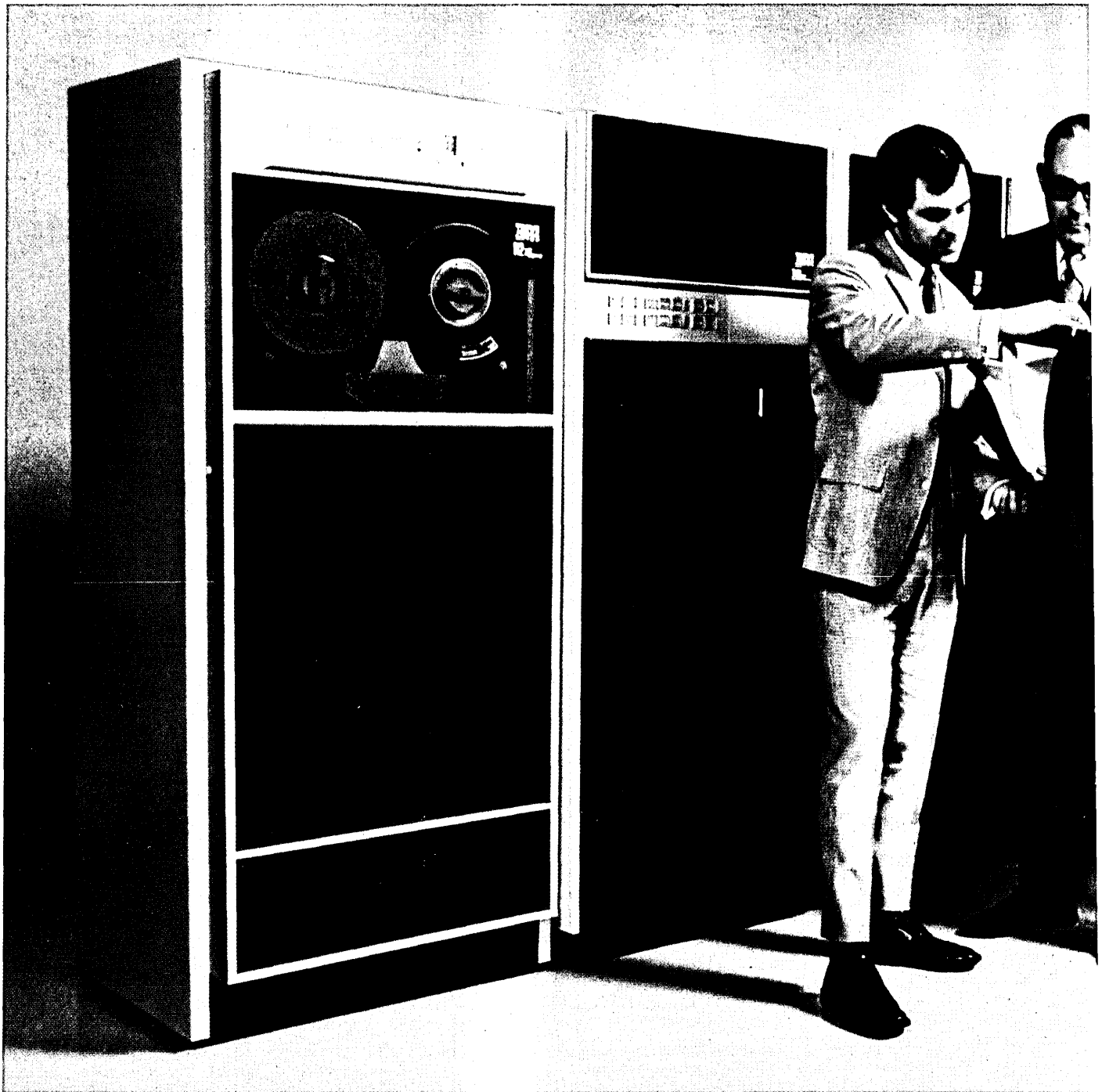

the uncommon the planners, the trainers

*the 3M
COM System
gives you
more than
hardware to
cut computer
output
handling cost*

If COM hardware alone could cut your cost of handling computer output, we'd supply only our uncommon COM.

The 3M COM System with the Electron Beam Recorder (EBR) converts computer output data from magnetic tape directly to microfilm. The electron beam "writes" bold or standard characters at reductions up to 50X on 16mm microfilm at 20,000 lines a minute. Unlike recorders using cathode ray tubes, there is no energy loss in converting

the beam to visible light. Result: Superior image resolution.

On line or off line operation is possible since the EBR "writes" at tape transfer speeds, and because of the *instant dry processing* feature of 3M Dry Silver Microfilm. The system interfaces with your present computer, and includes a separate microfiche capability.

But equipment, no matter how efficient, can't do it all. That's why we include the



com, and the maintainers

services of some very talented people. Take our planners, for example. They analyze specific data handling problems. And help you solve them with a library of output software packages, plus a variety of 3M Microfilm Reader-Printers. We also provide trainers. Specialists who teach your people how to get the most out of computer output microfilm. They hold class in our shop or yours. Our maintainers are included, too. Highly-skilled service

technicians always ready to keep your 3M COM System working perfectly.

The uncommon COM, the planners, trainers and maintainers from 3M: A complete system of hardware and people to help you simplify computer-generated data handling. Save up to 96% of filing space. Cut cost of packaging and handling information. And achieve faster, more efficient data retrieval. For details, write 3M Company, Dept. FDJ-21, St. Paul, MN 55101.

3M
COMPANY

New-and both free.

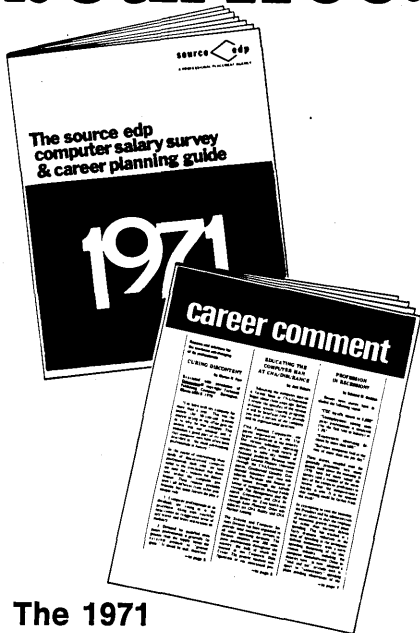

The 1971 Source EDP Computer Salary Survey and Career Planning Guide:

comprehensive analyses by industry and position; strategy and timing in career development; latest nationwide salary figures at all computer professional levels.

Career Comment:

a continuing line on trends and events that affect the "people" side of the computer field.

Both yours from Source EDP, the largest recruiting firm specializing solely in the computer field. For your free copies, write the nearest Source EDP office. Or circle the reader inquiry card.

- ATLANTA**—William G. Barnett, 11 Corporate Square 30329, (404) 634-5127
CHICAGO—Thomas D. Walsh, 100 S. Wacker Drive 60606, (312) 782-0857 and 903 Commerce Drive, Oak Brook, Ill. 60521, (312) 323-8980
DALLAS—Paul E. Dittmer, 7701 Stemmons Freeway 75247, (214) 638-4080
DETROIT—Robert T. Stevens, 24500 Northwestern Highway, Southfield, Mich. 48075, (313) 352-6520
GREENWICH, CONN.—Edward J. Golden, 9 Benedict Place 06830, (203) 661-3344
LOS ANGELES—Wayne B. Emigh, Suite 1404, 3550 Wilshire Blvd. 90010, (213) 386-5500
MINNEAPOLIS—Fred N. Anderson, 801 Nicollet Mall 55402, (612) 332-8735
NEW YORK—Charles T. Stern, 1414 Avenue of the Americas 10019, (212) 752-8260
PALO ALTO—Gordon F. Best, 525 University Ave. 94301, (415) 328-7155
PHILADELPHIA—George P. Ramming, 1700 Market Street 19103, (215) 665-1717
ST. LOUIS—Robert H. Trumbull, Suite 207, 130 S. Bemiston, Clayton, Mo. 63105, (314) 862-3800
SAN FRANCISCO—Richard M. Clark, 111 Pine Street 94111, (415) 434-2410
UNION, N.J.—Daniel A. Mickel, 2204 Morris Ave. 07083, (201) 687-8700

Affiliates in the United Kingdom.
Client companies assume our charges.

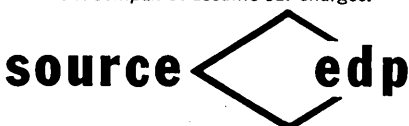

CIRCLE 505 ON READER CARD



PEOPLE

The president's office has been expendable during the economic turbulence of 1970; but vice presidents proliferated. Here are some new ones: **Louis R. Greer** was named executive vp and chief operating officer of Computer Copies Corp., New York manufacturer of multicopy paper for computer line printers . . . **Norman Avrech** was appointed vp/gm of a newly formed Systems Div. at Proprietary Software Systems, Inc., Los Angeles . . . **Mohawk Data Sciences Corp.** named **Horace Van Forsythe**, general manager of its Mark Steel Stamp Div. in Anaheim, Calif., a corporate vice president . . . **Mois Gerson** was appointed vp, corporate operations, for Electronic Arrays, Inc., Mountain View, Calif., and acting general manager of its Semiconductor Div. . . . **Bob Stout** was named vp, operations, for Formscan, Inc., Pasadena, Calif., specialists in conversion services for educational and business computer operations . . . **Harold R. Harding** was elected vice president and a director of Systemation, Inc., Boston consulting and software firm . . . **Robert S. Rosenthal** was appointed vice president of Management Research International, Inc., Austin, Texas . . . **George F. Weinwurm** left System Development Corp. to become Corporate Planning Div. vp for Security Pacific National Bank, Los Angeles.

But there's still room at the top. **Robert R. Russell** joined Computer Financial, Inc., Los Angeles, as president. **William R. Lennartz** moved up to become chairman of the board and chief exec officer . . . **Wendell J. Thompson** was named president of Planning Research Corp.'s engineering and consulting arm, PRC Technical Applications Inc. . . **Boothe Computer Corp.** named **Herbert B. Blodgett** president of its software services subsidiary, Booth Resources International . . . **Edward S. Devlin** was elected president of Independent Programmers Inc., Lafayette Hill, Pa., to succeed **William J. Crowley**, now board chairman.

Ray Smith, who had parlayed highly successful sales management stints into a post as large-scale systems sales manager at Control Data, has been named national sales manager for professional services. He'll work out of the CRM building in Bethesda. ■

personnel-ized

FINANCIAL and EDP

In the personnel field, meaningful personalization must be combined with maximum selection . . . that's why we coined the word *personnel-ized*.

Only the large organization can offer a genuine selection, because they have the quantity to select from . . . more positions . . . more people . . . greater *personnel-ization*.

Robert Half is the largest source in the FINANCIAL and DATA PROCESSING placement field . . . where you select the *best* because you select from the *most* . . . where the service is not only personalized, but is *personnel-ized*.

ROBERT HALF PERSONNEL AGENCIES

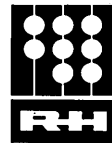

Atlanta: 235 Peachtree St., N.E.	(404) 688-2300
Baltimore: The Quadrangle—Cross Keys	(301) 323-7770
Boston: 140 Federal St.	(617) 423-6440
Charlotte: 907 Baugh Bldg.	(704) 333-5173
Chicago: 333 N. Michigan Ave.	(312) 782-6930
Cincinnati: 606 Terrace Hilton	(513) 621-7711
Cleveland: 1367 E. 6th St.	(216) 621-0670
Dallas: 1170 Hartford Bldg.	(214) 742-9171
Denver: 1612 Court Place	(303) 244-2925
Detroit: 140 Honeywell Center, Southfield	(313) 354-1535
Garden City, N.Y.: 585 Stewart Ave.	(516) 248-1234
Hartford, Conn.: 75 Pearl St.	(203) 278-7170
Houston: 1200 Central Nat'l. Bank Bldg.	(713) 228-0056
Indianapolis: 9 N. Illinois St.	(317) 636-5441
Kansas City: 127 W. 10th St.	(816) 474-4583
Los Angeles: 3600 Wilshire Blvd.	(213) 381-7974
Memphis: 12 S. Main St.	(901) 527-7324
Miami: 1107 Northeast Airlines Bldg.	(305) 377-8728
Milwaukee: The Clark Bldg.	(414) 271-9380
Minneapolis: 822 Marquette Ave.	(612) 336-8636
Newark: 1180 Raymond Blvd.	(201) 623-3661
New York: 330 Madison Ave.	(212) 986-1300
Orange, Cal.: 500 South Main	(714) 835-4103
Philadelphia: 2 Penn Center Plaza	(215) 568-4580
Phoenix: 1517 Del Webb Townehouse	(602) 279-1688
Pittsburgh: Gateway Towers	(412) 471-5946
Portland, Ore.: 610 S.W. Alder St.	(503) 222-9778
Providence: 76 Westminster St.	(401) 274-8700
Rochester: One Marine Midland Plaza	(716) 546-3020
St. Louis: 1015 Locust St.	(314) 231-0114
San Francisco: 111 Pine St.	(415) 434-1900
San Jose: 675 North First St.	(408) 293-9040
Stamford, Conn.: 111 Prospect St.	(203) 325-4158
Washington D.C.: 7316 Wisconsin Ave. N.W.	(301) 654-1850

CIRCLE 503 ON READER CARD

DATAMATION

ELECTRONIC DATA SYSTEMS CORPORATION

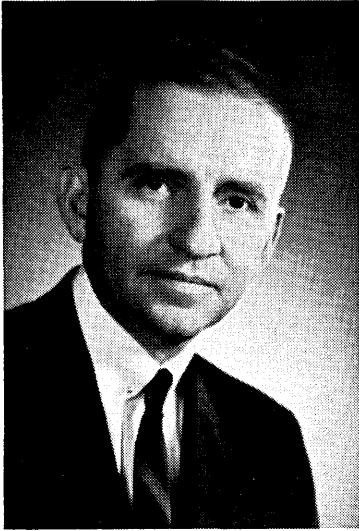

DALLAS, TEXAS 75235

1300 EDS CENTER
EXCHANGE PARK
(214) 358-3171

EDS is a young, growing, successful computer service company that can offer you an outstanding business opportunity now

We are seeking skilled systems engineers, systems analysts, systems programmers, commercial programmers and operations staff.

We are currently designing and installing on-line business information systems utilizing OS/MVT.

EDS is a great environment for individuals with leadership experience and maturity who are trustworthy, unselfish, results oriented, self reliant, and have a record of success.

EDS needs individuals who are willing to do whatever it takes, as long as it is fair and honest, to get the job done. You must be flexible in your working hours and be willing to travel or relocate.

If you are willing to enter an environment where there are no corners in which to hide, an environment where you advance on your ability not seniority, and feel you can contribute to EDS' growth, contact Gary Griggs at the above address.

Sincerely,

A handwritten signature in cursive script, appearing to read "Ross Perot".

Ross Perot
Chairman of the Board

"Eagles Don't Flock . . . You Have to Find Them One at a Time"

YOU ARE INVITED



to become a member of
SIMULATION COUNCILS, INC.

Simulation Councils, Inc. is the only technical society devoted solely to the art and science of simulation. Its purpose is to advance the use and design of all types of computing systems—and of other devices employing mathematical or physical analogies—for the analysis and synthesis of dynamic systems in all areas of human endeavor.

SCi has world-wide membership and regularly holds regional meetings in the United States and Canada and in the United Kingdom.

All members receive the society's technical journal, *SIMULATION*, the only monthly publication in its field. *SIMULATION* is a prime medium for the exchange of information among professionals concerned with modeling and simulation, and is an important reference source for all who use computers to study the behavior of systems. Areas covered by *SIMULATION* are:

- Theory and application of analog, hybrid, and digital techniques and equipment
- Theory, design, and use of models and simulation systems
- Analog, hybrid, and digital simulation software and languages
- Application of all kinds of devices to the simulation of dynamic systems

Contents include major technical articles recording work in progress and documenting important contributions to the art and science of simulation and closely allied technologies. Special sections on *Techniques*, *Technical Comments*, and *Computers in Education* allow readers to share "tricks of the trade" that they have developed to solve their own problems in using analog, digital, and hybrid computers. A wide and interesting assortment of other material serves to keep readers posted on the ideas, problems, solutions, and activities of fellow workers in the field.

SCi is a Scientific Affiliate of the AICA, a Member Society of the American Federation of Information Processing Societies, and one of the three societies that jointly arrange the Spring and Fall Joint Computer Conferences in the United States.

Regular and senior membership is open to qualified professionals in simulation and allied technologies. Associate membership is available to others who are interested in simulation. Dues for regular and associate members are \$18 (U.S.) per year. Student memberships are available at reduced rates. All members receive *SIMULATION*. Applications are available from

SIMULATION COUNCILS, INC.
P. O. Box 2228
La Jolla, California 92037 USA

W RLD ROUNDUP

MACHINE SPECS NEAR
FOR GENEVA ACCELERATOR

Specifications can be expected soon for computing and process control machinery for the new 300GeV accelerator at the European Centre for Nuclear Studies, CERN, at Meyrin, on the outskirts of Geneva. The four main contributors to this centre, supported by 12 European countries--Germany, France, Italy and the U.K.--have at last agreed over the initial spending of \$300 million for an accelerator comparable to that being built at Batavia, Ill. The new research centre, to be known as CERN 2, will incorporate a battery of big processors and on-line controllers.

U.K. POWER STRIKE
SHOCKS DP EQUIPMENT

The vulnerability of dp machines became apparent during a week-long industrial dispute involving the U.K.'s electricity distribution workers in mid-December. Britain's electricity supplies are provided by a national organisation, the Central Electricity Generating Board. Power from its generating stations is distributed by an integrated network covering the whole country. During the dispute, sections of the network were disconnected for periods of four to six hours as workers embarked on a work-to-rule of disruptive action. As a strategic industry, properly organised power strikes are illegal. But during the power cuts, many computer installations were disrupted. Lines of customers formed at banks as on-line terminals went dead, machinery was automatically switched off as air conditioning units stopped, and dp schedules had to be checked as processing units suddenly stopped in the middle of a run.

IF IT'S IBM,
IT MUST BE BELGIUM

IBM is understood to have reached some sort of tacit understanding with the Belgian government over securing its position in the market. This follows the arrangement reached earlier in the year in which the German company Siemens and the Dutch giant Philips had been granted a 25% share each of orders for government and the public sector. A deal of this nature is not unprecedented in Belgium. Some time ago the government gave ITT carte blanche for supplying telephone exchanges and equipment; but ITT is one of the biggest employers of labour in the country. As it happened, the agreement with Philips and Siemens was made at the same time as Burroughs was opening a new factory in Belgium. There are several attractions for investing in Belgium, not the least of which is taxation laws. But it is also the home of NATO headquarters and other influential international organisations. It is also geographically a good location for selling throughout the Common Market countries. Trade discrimination has been raised in another form with objections lodged, mainly via IBM, to get the NATO committee that places embargoes on sales to the Soviet bloc to restrict business being done in Russia by U.K.'s ICL.



H. Levin, MBA, Personnel Management, Member of ACM and DPMA



EMPLOYMENT AGENCY

**for PROGRAMMERS & ANALYSTS
N.Y./N.J./PENNA.**

RSVP will provide employment counseling, develop and circulate your resume, at no cost to you. Call or send resume or rough notes of objective, salary, location restrictions, education and experience to either of our offices:

- **HOWARD LEVIN, Director**
RSVP Services, Dept. M
Suite 714
One Cherry Hill Mall
Cherry Hill, N.J. 08034
(609) 667-4488
- **BOB RAMSEY, Manager**
RSVP Services, Dept. M
Suite 104, Towle Bldg.
1777 Walton Road
Blue Bell, Penna. 19422
(215) 643-5550

RSVP SERVICES

*employment agency
for computer professionals*

CIRCLE 501 ON READER CARD

CUSTOMER ENGINEERS

Commercial Computer Field

CalComp is the world leader in computer graphics. We were first to develop an incremental digital plotter and have continued to expand our product line with random access memory disc drives, mini-computers, controllers, tape units and automated controls for keypunch.

Positions are available in 41 key cities throughout the U.S. for customer engineers with systems field service experience on large scale commercial computers and all related peripheral equipment.

Be a part of this vigorous growth and realize your maximum potential within your career field. You'll need a minimum of 2 years applicable experience.

Write or send resume to request application and/or further information to:

Dave Elling, Dept. D-2
2411 W. La Palma Ave., Anaheim, Ca. 92803



CALIFORNIA COMPUTER PRODUCTS, INC.
An equal opportunity employer

CIRCLE 500 ON READER CARD

ADVERTISERS' INDEX

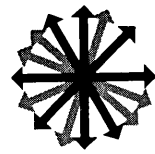

American Society for Information Science	88
American Technological Institute	70, 87
Applied Computer Systems, Inc.	11
Auerbach Info, Inc.	20
Burroughs	16
California Computer Products, Inc.	86
Cardkey Systems, Subsidiary of Liquidonics Industries, Inc.	66
Cybermatics Inc.	10
Datamation Industry Directory	72
DATAMATION Magazine	79
Dataware Marketing, Inc., Subsidiary of Boothe Computer Corp.	12
Digital Equipment Corporation	5
Documation Incorporated	63
Electronic Data Systems	83
Evans & Sutherland Computer Corporation.....	19
Robert Half Personnel Agencies	78
Heugatile Corporation	8
Honeywell	51-62
Inforex, Inc.	64, 65
International Computer Products, Inc.	67
National Blank Book Company, Inc.	14
The National Cash Register Company	74
Novar Corporation	4
Numeridex Tape Systems, Inc.	4
Plessey Electronics	31
Potter Instrument Company, Inc.	6, 7
Precision Instrument	2
RSVP Services	86
Simulation Councils, Inc.	84
Source EDP	78
Southern Simulation Service, Inc.	87
Tally Corporation	1
TEC, Incorporated	39
3M Company	76, 77
Toko, Inc.	90
Varian Data Machines	Cover 2
Varifab Inc.	90
Westinghouse Electric Corporation, Computer and Instrumentation Division	Cover 4
Wright Line, A Division of Barry Wright Corporation	Cover 3

Arthur L. Rice, Jr., President
 Gardner F. Landon, Exec. Vice President, and President, Thompson Division
 James B. Tafel, Exec. Vice President, and President, Technical Division
 Calverd F. Jacobson, Financial Vice President
 Edwin C. Prouty, Jr., Secretary and Director of Data Processing

ADVERTISING OFFICES

<p>Sales Manager & Vice President</p>	<p>JOHN BRENNAN 205 West Wacker Drive, Chicago, Ill. 60606 (312) Financial 6-1026</p>
<p>Eastern District Managers</p>	<p>JAMES M. MORRIS WARREN A. TIBBETTS IRWIN L. WERFEL 35 Mason Street, Greenwich, Conn. 06830 (203) 661-5400</p>
<p>New England District Manager & Vice President</p>	<p>WARREN A. TIBBETTS 112 West Haven Rd. Manchester, N.H., 03104 (603) NAational 5-9498</p>
<p>Midwest District Manager</p>	<p>JOHN M. GLEASON 205 West Wacker Drive, Chicago, Ill. 60606 (312) Financial 6-1026</p>
<p>Western Manager & Senior Vice President</p>	<p>HAMILTON S. STYRON 94 So. Los Robles Ave., Pasadena, Cal. 91101 (213) 681-8486—from Los Angeles</p>
<p>Western District Manager</p>	<p>JAMES E. FILIATRAULT 260 Sheridan Ave. Palo Alto, Calif. (415) 321-1440</p>

It takes only five days to
GET AHEAD



using our intensive courses to qualify for programming in all levels of

SIMSCRIPT AND GPSS

the computer programming languages for simulation and general programming.

COURSES EVERY MONTH. WRITE FOR FREE BROCHURE WITH SCHEDULE.

Consulting services available for program analysis and program assistance.



Southern Simulation Service, Inc.
 POST OFFICE BOX 1155
 TAMPA, FLORIDA 33601
 TELEPHONE (813) 839-5201

CIRCLE 15 ON READER CARD

NOW—prepare for your PROFESSIONAL ENGINEERING LICENSE at home in your spare time

A P.E. license is your open door to higher earnings and a secure future. In many areas it certifies your authority on the basis of legal requirements. The need for licensed engineers today is far greater than the supply.

American Technological Institute specially developed these courses for preparation through home study, the easiest way. You set your own pace — a schedule is worked out to meet your state board test date anywhere in the U.S.

FREE SAMPLE LESSON
in the review course of your choice

Look over this list — check the course that fits your needs. Then send us the coupon today for detailed brochure and free sample lesson and you're on your way to a brighter tomorrow!

BASIC REVIEW

Review courses based on actual problems from E.I.T. state tests. Also planned to increase speed in correct solutions.

STRUCTURES

From Beams to Distributed Load Problems.

GENERAL SCIENCE

Complete review of E.I.T. test problems.

COMBINED BASIC

A combination of the above two courses.

FORTRAN for Engineers and Scientists

A special course in the most widely used computer language in engineering. An understanding makes any engineer more valuable.

ADVANCED REVIEW

Reviews in your special field to prepare for your Professional Licensing examination. Topics are based on frequency of appearance in state tests. Every course also includes Interest and Depreciation, Capital Recovery and Cost Analysis.

MECHANICAL Engineering

Heat Transfer, Machine Design, Nuclear Energy, etc.

ELECTRICAL Engineering

Circuits, AC and DC machinery, Transmission Lines, etc.

CIVIL Engineering

Beams, Columns, Trusses, Frames, Route Surveys, etc.

CHEMICAL Engineering

Fluid Flow, Distillation, Chemical Processes, etc.

Mail to AMERICAN TECHNOLOGICAL INSTITUTE today!
 A Subsidiary of Technical Publishing Company

Dept. DA, 35 Mason Street, Greenwich, Conn. 06830

Send me the free sample lesson for the course I have checked above. There is no obligation and no salesman will call.

Name.....

Address.....

City..... State..... Zip.....

[Cut here and mail]

Approved for Veterans • Accredited Member National Home Study Council

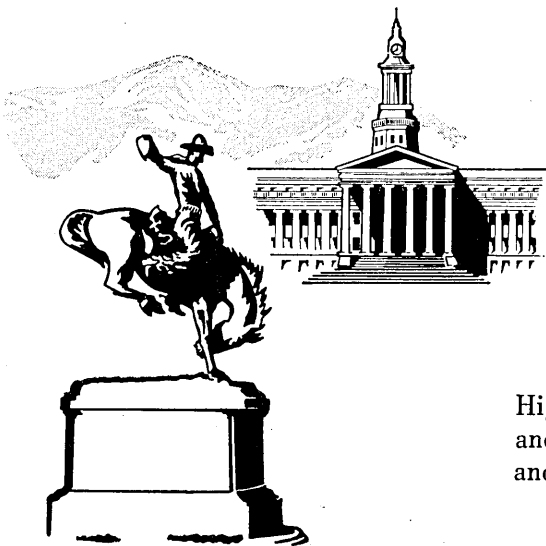

34TH ANNUAL MEETING OF THE AMERICAN SOCIETY FOR INFORMATION SCIENCE

November 7-11, 1971
Denver Hilton, Denver, Colorado

CALL FOR PAPERS

High quality presentations in the field of information science and technology are desired to provide a focal point for discussion, and to summarize or interpret important work.

SUBJECT MATTER: Reports on any new research and developments in the field are solicited, particularly those concerned with "COMMUNICATION FOR DECISION-MAKERS." This theme is to be interpreted in the broadest sense and could include such topics as:

- Information Center management and communication
 - Automation of "housekeeping" information and procedures
 - Decision techniques and Management Information Systems
 - Organizational and interpersonal effects upon information transfer
 - Information in relation to creative environments
 - Communication and sociological problems
 - Education of decision-makers, present and future
 - Information handling for governmental or legislative purposes

CRITERIA FOR ACCEPTANCE: Papers should be aimed at one or both levels of "decision-makers":

1. Immediate and practical applications.
2. Future and broad possibilities or implications.

Papers should be *provocative* (new, innovative), *useful* (informative, practical), *appropriate*, and *terse*.

INSTRUCTIONS FOR AUTHORS: Those interested in submitting a paper should forward a notice of their intention immediately. A typed rough draft of the full paper (or as detailed a description as possible of on-going work with an outline of the proposed paper) must be submitted before **1 April 1971**. Notification of acceptance or rejection of the submitted papers will be made by **15 May 1971**, and camera-ready copy of finished work must be supplied by **1 July 1971**.

Full drafts should not exceed 2,000 words, and figures or other illustrations should be included, if possible. A full title and an informative abstract must accompany each paper. More detailed information will be supplied later concerning the final copy of accepted papers.

TO: Jack M. McCormick Dept. D
ASIS 1971 Convention Chairman
P.O. Box 1262
Boulder, Colorado 80302

This slip indicates my intent to submit a full draft of a proposed paper for the 1971 ASIS Convention by or before **1 April 1971**.

Title or Subject: _____

AUTHOR(s): _____

AFFILIATION: _____

MAILING ADDRESS: Street _____

City _____ State _____ ZIP _____

TELEPHONE: () _____

“A” Compromise Defended

In the Nov. 15 issue of *Datamation* the debate on OCR-A vs. OCR-B continues and more and more nonsense finds its way into print.

First, I would like to make a comment about popular opinion as a factor in designing OCR machinery. The present IBM punch card has rectangular holes—should the shape of the holes be changed to the “golden ratio” so that the holes would be prettier to look at? Should the SST designers ask for public opinion as to the best shape of the aircraft?

I would not imply that the OCR-A is the best possible machine-readable font—this it isn’t—or that it is particularly beautiful. The fact is that the A font was designed as a compromise to fit all existing OCR equipment, while still being easily readable by humans.

I have often (since 1954) argued that characters based on a simple grid are efficient both for machine generation and for machine reading. The fact is that the crt character displays of computers all over the world are almost universally based on the very efficient 5 x 7 grid and nobody seems to object to their shapes.

I think our European friends got themselves out on a limb based on some incorrect technical information and now refuse to change. Mr. Hekimi’s letter is a case in point. He states “Although no technical evidence was presented in support of these objections” to OCR-B, ECMA has decided to make changes in the originally proposed B standard. I would like to correct Mr. Hekimi by pointing out that our committees have made careful measurements of the A and B fonts and found the B font was not suited to OCR use, except in very special cases. The fact that the Europeans have decided to modify a number of characters bears this out. Mr. Hekimi implies that the “number of improvements” are being worked on only to mollify the U.S. committees.

I sincerely hope that this is not so.

I agree with Mr. Hekimi that the modifications proposed to the B font are technically sound and will improve it. I do not agree with him when he says that such modification “cannot be objected to, except on tendentious grounds. OCR-B is already far superior to OCR-A; when improved, it will be even better.” The WAD analysis clearly says that even the proposed B is not as OCR readable as A, unless the improvements are much greater than we have seen so far.

The slur implied in the word “tentious” is certainly uncalled for and is unworthy of Mr. Hekimi. Nor should he say that “Allegations of technical weakness can no longer be advanced.” Technical matters should be discussed openly without *argumentum ad hominum*. So far the only real arguments for the B font were based on esthetics; esthetics should be based on function, not the other way around.

His final statement “It is significant that many American companies operating in Europe offer OCR-B, which further confirms the ideas referred to above” proves nothing technically, except that all companies can build OCR-B machines when they are requested to do so. It simply proves that this font can be read, as we all can read hundreds of other fonts as well. The real question, nevertheless, remains: What does it take to read simple grid characters which have large differences, as compared to “conventional” characters which fit no grid and which need much higher resolution and more expensive OCR machines? And if one assumes machines of equal cost, then what are the error and reject rates?

I think it is high time that the technical decisions be left to people who must base them on technical considerations, and if a customer wants special machines, he should be fully informed as to the possible trade-offs and their cost. We in Control Data

are more than happy to build machines for the B font, or for that matter, for any other font, but the choice of fonts should be based on technical and financial considerations only.

If I, also, allow myself to make a subjective comment I would say that the choice of OCR-A vs. OCR-B should not be based on traditions, national pride, or esthetic prejudice.

The letter from Mr. Frank Brewster is very interesting. Unfortunately, he raises questions for which there are no simple answers. We do know the relative costs of machines that we and our competitors have built. I have never heard anyone deny that it is easier to read one font than two, or that the A is easier to read than the B. We all seem to agree that in a very sophisticated machine the differences in costs are minor. This is undoubtedly true if one reads “very sophisticated” as “very expensive.”

The questions that Mr. Brewster raises about human preferences and ability to read capitals versus lower case are very difficult to answer for several reasons. We are trained over a lifetime to read certain characters, mostly in lower case. We also read words by groupings of characters and by context. Therefore, any short run test of a new font on people trained to read conventional Roman characters would certainly be invalid. If one wanted to really make a comparison between, say, the conventional Roman characters and, say, Hebrew characters, one would have to find people who have never read either (better yet, who have never read anything) and start training them early in life.

There is some indirect evidence that lower case letters are easier to read than upper case letters alone, particularly in reading conventional language. There are at least two good reasons for this. One is that typewriter fonts are designed for lower case letters and the letters are quite easy to distinguish and quite easily

Lift Your Computer Program Off the Launch Pad

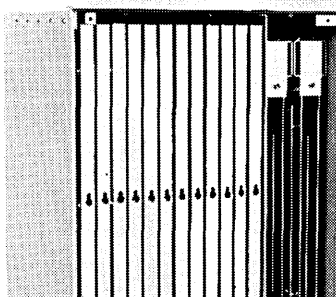

— With Toko's New High-Speed Read-Only Memory System

There's good news for computer users. Toko's new FS-100A Memory System has hit the market! This economically-priced plated-wire memory system is ideal for slow-write/fast-read operations. Check these other hard-to-beat advantages:

- * Electrical changing of stored program
- * Quick and easy removal of write electronics
- * NDRO and non-volatile characteristics

Toko's advanced electronics technology has developed other top-quality computer components, such as memory stacks, pulse transformer and delay lines.

For further information, just call or write



TOKO, INC.

Head Office: 1-17, 2-chome, Higashi-Yukigaya, Ohta-ku, Tokyo, Japan
New York: Toko New York Inc.
 350 Fifth Avenue, New York, N.Y., 10001 U.S.A. -Tel: 565-3767
Los Angeles: Toko, Inc. Los Angeles Liaison Office
 1830 West Olympic Blvd., Los Angeles, 90006 Cal. U.S.A. Tel: 380-0417
Düsseldorf: Toko, Inc. Europe Liaison Office
 4 Düsseldorf, Kolner Straße 246, Düsseldorf, W. Germany Tel: 78-7064

CIRCLE 27 ON READER CARD

A \$795 device will solve your data input problems

Here's the solution to central keypunch errors, work backlogs or that special source data problem. The Vari-Punch Model 402 — a 15 lb. portable electric keypunch that simultaneously prints and punches tab cards at the point of origin. Now anyone who collects data — timekeeper, secretary, salesman, shipping clerk, etc. — can create punched cards ready for your computer or tabulator — on the spot. Vari-Punch users bypass central keypunch bottlenecks . . . save time and money by eliminating hand posted source media. Call (203) 637-1434, or mail the coupon below for complete information and the name of your local dealer.

VARIFAB INC.

1700 E. Putnam Ave.
Old Greenwich, Conn. 06870



DM-3

Name

Company

Address

City State Zip

CIRCLE 35 ON READER CARD

The Forum . . .

separated. Because upper case letters occur infrequently, they are very often made wider than the pitch would allow so that when one types upper case letters only, they run into each other and are very difficult to separate by eye. In book printing, where variable pitch is used, these problems are not as serious, but even here the upper case letters have the same height and do not have as much pictorial information in a word as the combination of upper and lower case. In upper and lower case printing there are ascenders and descenders which provide clues for rapid reading. The above arguments are really only my opinions. People who read languages which are printed in one case only do not seem to have any difficulty in doing so, and if there are differences in speed of reading they may be due to entirely different reasons. My own experience is that it is easier for me to read lower case (of conventional language), but I am a relatively old man and my brain is, alas, quite rigid, although I hope not as rigid as my friendly opponents sometimes imply.

I think that the Lower Case A font is very readable and we have used it (or slight variations of it) in Control Data correspondence for several years and we find we have no problem. Our rather large staff has no problems reading our correspondence and, in fact, if no one calls attention to the font, people never notice there is anything peculiar about it. I have spoken to literally thousands of people about this problem and I can only report that there are a few who dislike the OCR-A, there are a few who like it, and the vast majority don't give a damn. The machines do care, however, and I only wish we had not designed the OCR-A compromise but a font based either on a true 5 x 9 or on a 5 x 7 grid. This would have made the machines even simpler, less expensive, and more reliable.

As I look through the issue of *Datamation* I notice that a great many ads are using fonts without serifs, yet the general text is with serifs. Does this mean the ads are not as easy to read? Obviously, human beings can cope with both. Beauty, here like elsewhere, is in the eye of the beholder.

—J. Rabinow

You'll find a complete line of Tape Storage and Handling Equipment in the Wright Line Catalog



Library storage units, cabinets, desk racks, trucks, carrying cases and Data Bank Safes . . . You'll find everything you need to build an efficient and beautifully styled system for handling and storing tape reels in Tape Seal® Belts, thin-line or standard canisters. Your Wright Line Catalog is the one complete source for information on Tape Storage and accessories for use in disk, eighty column and the new ninety-six column card systems.



It's so easy to solve your data processing accessory needs with the Wright Line Catalog

1. Select from the catalog and mail or phone your orders directly to your local Wright Line branch office or main plant in Worcester. Wright Line's more than 60 offices are listed in the yellow pages.
 2. If additional information is needed when ordering or planning installations, call your local branch office and ask to have one of Wright Line's more than 125 field specialists call on you.
- If you don't have a Wright Line Catalog, we'll be glad to send you one. Write or phone any of our offices or circle the readers' service number below.

Everything for data-processing except the computer.

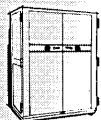

DATA BANK SAFES

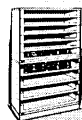

DISK PACK STORAGE



GOLD STAR FILES



TAPE STORAGE



SYSTEM/3 ACCESSORIES



DATA PROCESSING ACCESSORIES

The growing family of Westinghouse Computers

Westinghouse Computer Department, dedicated to the principle that response to customer needs must be paramount, introduces the newest member of its expanding computer family, the Westinghouse 2550 Satellite Processor. It joins the recently-announced Westinghouse 2500 table model and rack-mounted model 16-bit digital computer line. The Westinghouse 2550, one of the industry's first user-oriented modular systems for remote and off line data processing, is available **today** for **today's** user requirements. The basic Westinghouse 2550 configuration incorporates the versatile 2500 computer with 4096 words of memory, control console, data set adapter, card reader, line printer, and supporting software (executive communication system, I/O handlers, data set adapter handler, communication formatter with data compression, and emulators compatible with

IBM, UNIVAC, CDC and other terminal manufacturers).

The Westinghouse 2500 computer line features a 750 nanosecond memory cycle time, 4096 words expandable to 65,536, hardware multiply/divide, a full line of peripherals, and many options that give meaning to systems modularity. Established software features monitors, FORTRAN IV compilers, BASIC compilers, assemblers, linking loaders, cross assembler/simulator and numerous other packages.

The option-oriented approach of Westinghouse Computer Department products offers the customer unusual versatility **plus** the knowledge and experience of Westinghouse Electric Corporation's many years of activity in the computer business. Write Westinghouse Computer Department for detailed literature. You can be sure if it's Westinghouse!

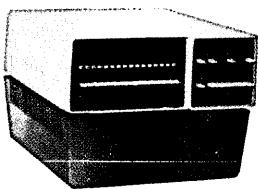

Westinghouse 2500 Table Model

Westinghouse 2500 Rack-Mounted Model

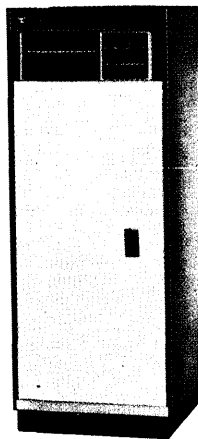

Telephone (305) 843-7030
 Computer Department
 Computer and Instrumentation Division
 Westinghouse Electric Corporation
 1200 W. Colonial Dr., Orlando, Florida 32804

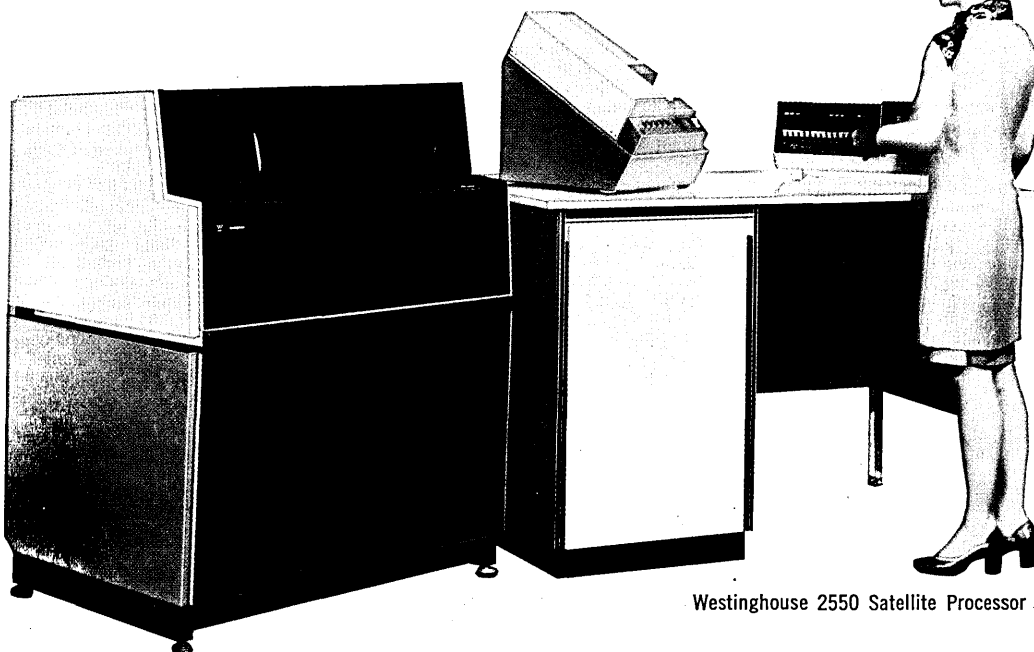

Westinghouse 2550 Satellite Processor

You can be sure ... if it's Westinghouse