

# PATTERNMATION®

September



1603299  
FRED L RICHARD  
CONTROL DATA CORP  
5950 6TH AVE SO SUITE 20 87 296  
SEATTLE WA 98108

8001  
02  
36

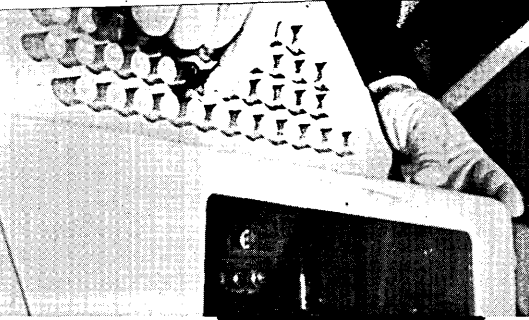

RECEIVED  
SEP 17 1981  
C.A.C. SYSTEMS

computer  
assisted instruction

# Varian Data Machines' new 520/i dual environment computer gives you 2 computers in 1

....almost.

We've designed our new 520/i computer with enough hardware power to handle dual, independent tasks that would often require two computers. That's why we've called it a dual-environment computer.

With its two complete, independent sets of hardware registers, including index registers, the 520/i efficiently runs parallel programs or efficiently processes background and foreground information.

Since each program uses its own set of registers, a single 1.5 microsecond instruction transfers control from one environment to the other. This dual-programming capability keeps housekeeping to an absolute minimum. And whatever your data format or word length, the 520/i performs arithmetic in 8-, 16-, 24-, or 32-bit lengths within the same program! And each program can change its own precision at any time.

So if you think you have enough work for two computers—see if the 520/i will do the job. The new Varian Data 520/i with a 4K memory sells for \$7500. If you would like to know more about it, write for a Varian 520/i brochure.



**varian data machines**

2722 Michelson Drive • Irvine, California 92664  
(714) 833-2400 • TWX (910) 596-1358



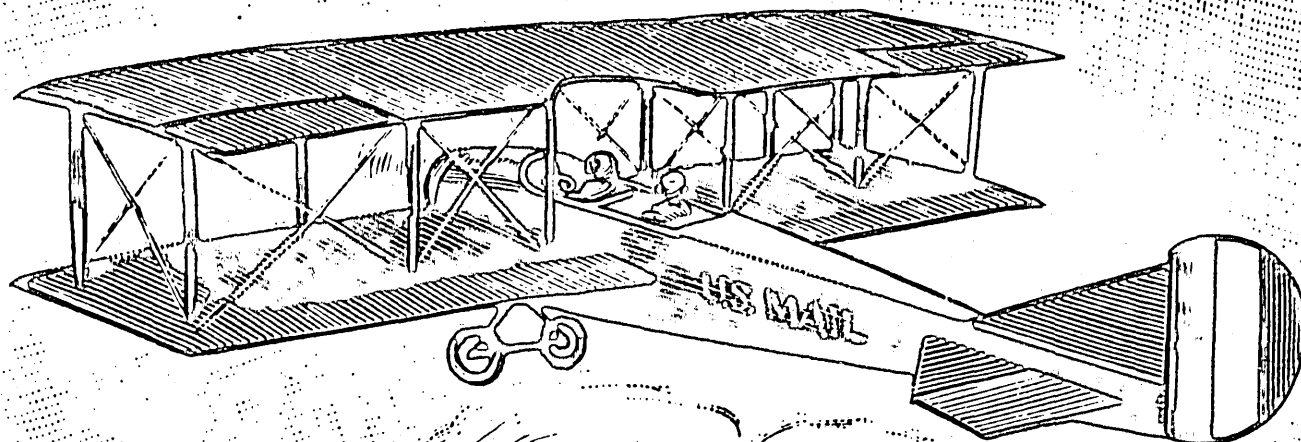

# To move more data faster for less, talk to Tally.

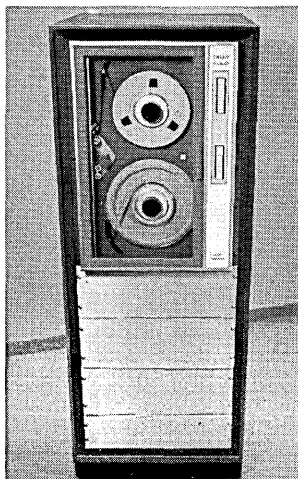
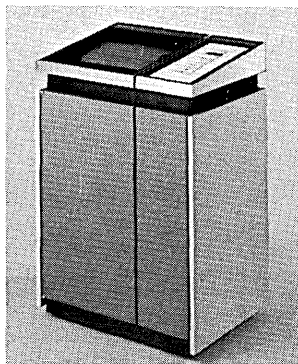
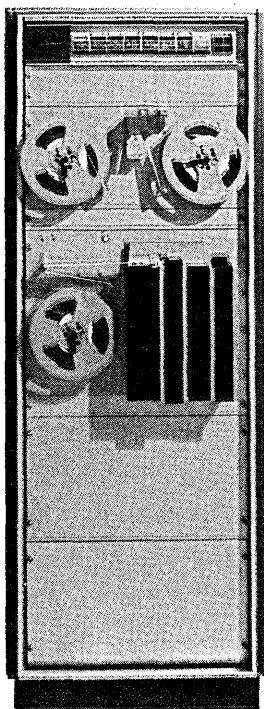

Tally makes the broadest line of data communications equipment on the market today. And if you have a "mixed bag" systems problem which calls for data entry or high speed printout in conjunction with data communications, we have the answer. Tally systems take source data from perforated tape, magnetic tape, or punched cards and transmit it at 1200 words per minute (12 times faster than TWX) over ordinary telephone lines. The new Tally Serial Printer prints out hard copy data at 60 characters per second. The Tally 4021 "stand alone" send/receive 1/2" magnetic tape terminal operates with any Tally transmission system to provide computer compatible tape.

Tally has a nationwide network of service stations working directly with the Seattle Test Center to solve any problem quickly and economically.

For full information, please write or call Tally Corporation, 1310 Mercer Street, Seattle, Washington 98109. Phone: (206) 624-0760, or contact one of the regional offices listed below.

New York: 45 N. Village, Rockville Centre 516-678-4220  
 Chicago: 33 N. Addison Rd., Addison, Ill. 312-279-9200  
 Washington, D.C.: 1901 Ft. Myer Dr., Arlington, Va. 703-525-8500  
 San Francisco: 420 Market St., San Francisco, Calif. 415-989-5375  
 England: 6a George St., Croydon, Surrey MUN-6838

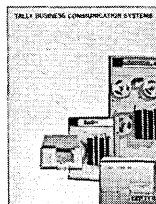

**TALLY**

Computer  
Power  
Booster

**RCA Spectra 70/35  
gives you twice the  
processor power  
of a 360/25...  
for the same price.**

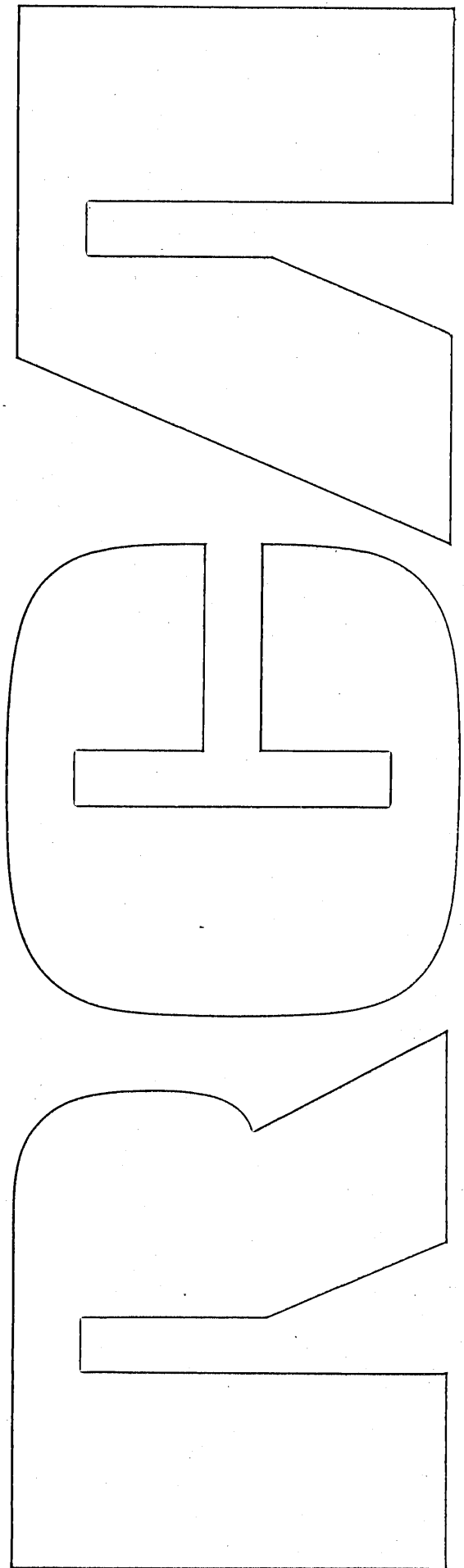

**This simple comparison gives you the facts.**

	SPECTRA	
	70/35	360/25
<b>Monthly rental</b>		
Memory size		
32,768 bytes	\$2560	\$2560
49,152 bytes	\$3410	\$3410
65,536 bytes	\$3990	*
1401 Emulator	\$ 100	\$ 100
<b>Operations per second</b>		
Add full word	52,631	20,202
Add two fields (10-digit)	17,883	8,230
Memory move 6 bytes	39,308	15,873
Branch	94,697	35,842
Compare two 10-byte fields	21,478	8,888
<b>Also . . .</b>		
Registers	43	16
Multiplexor rate (KB)	61.5	30
I/O channels	3	1
Selector channel data rate (KB)	694	30

\*Model not offered

**Here's what you get from twice the power.**

**You save money.**  
The extra speed you get with the 70/35 means you get more work done during an average day. So you have lower operating costs. Another economy is the RCA rental policy. *You can use your computer all day, every day, without paying for extra shifts.*

**Multiprogramming.**  
For more efficient task handling, you can have 6-level multiprogramming. It gives you multi-job streaming with monitor control, an advanced feature that reduces software overhead.

**Software support.**  
Take your choice. You can have COBOL, FORTRAN, Assembler, RPG and Disc Operating System. And with it you can do batch processing. Scientific computing. Or build a communications-oriented system.

**Flexible memory assignment.**  
The 70/35 eliminates a lot of permanent programs that crowd memory and impede processing. Instead, it moves programs in and out of memory as they are needed. So most users can do a thorough job of processing with just the basic 32K memory.

**System growth.**  
Memory expands to 65K. And you can add a lot more peripherals to your original configuration. Tapes, mass random access memories, up to 16 disc drives. And 1401, 1440 and RCA 301 emulation.

**360 compatibility.**  
If you're a 360 user, conversion to Spectra 70/35 is fast and easy. And there's no retraining of personnel. No extensive reprogramming. No disruption of your work load. And you get the total support you'd expect from RCA. Our systems specialists help design your system, train your personnel and bring the system into full operation.

For more details, call or write your nearby RCA sales office.

- ATLANTA  
John J. Murphy ..... 634-6131
- BOSTON  
Paul H. McNamara ..... 536-0880
- CHARLOTTE  
Haines A. Maxwell ..... 377-5971
- CHICAGO—NORTH  
Gordon W. Moore ..... 782-0700
- CHICAGO—SOUTH  
Joseph P. Ganley ..... 782-0700
- CLEVELAND  
C. M. Young ..... 579-0880
- DALLAS  
William T. C. Gaskill ..... 351-5361
- DAYTON  
Frank W. Irvin ..... 293-6907
- DENVER  
William P. Perry ..... 399-1460
- DETROIT  
William L. Bones ..... 356-6150
- HARTFORD  
Dean A. Holdiman ..... 527-4143
- HOUSTON  
M. E. Heisley ..... 529-7601
- INDIANAPOLIS  
Robert J. Clark ..... 546-1188
- LOS ANGELES—NORTH  
Walter L. Brouard ..... 461-9171
- LOS ANGELES—SOUTH  
Charles R. Williams ..... 385-2071
- MIAMI  
Robert B. Henry ..... 445-5487
- MONTREAL-RCA Victor Co. Ltd.  
R. J. Campbell ..... 933-7551
- NEWARK  
Rollin S. Thompson ..... 621-7035
- NEW YORK—DOWNTOWN  
Henry H. Staehling ..... 689-7200
- NEW YORK—UPTOWN  
John A. Hunter ..... 689-7200
- PHILADELPHIA  
Alan L. Reade ..... 568-8150
- PITTSBURGH  
D. H. Arnold ..... 261-1080
- SACRAMENTO  
Loren R. Watts ..... 444-3480
- SAN FRANCISCO  
John A. Kopas ..... 981-5600
- ST. LOUIS  
R. A. Fullerton ..... 726-5322
- SYRACUSE  
Ralph E. Butt ..... 472-9111
- TALLAHASSEE  
C. W. Hartung ..... 224-4188
- WASHINGTON—COMMERCIAL  
Richard J. Gaspari ..... 337-8500
- WASHINGTON—GOVERNMENT  
W. R. Lonergan ..... 337-8500



# You can read us like a book.

Wouldn't it be great if everything that came out of your computer could be read as easily as your favorite book?

If you're presently making copies from line printer output it's no pleasure to read. Or to handle.

If you're using traditional typesetting methods you're concerned with turn-around time, human error and costs.

Now, Alphanumeric offers the solution with a brand new service that combines the speed and accuracy of the computer with the graphic arts quality of type. We call it TAPE-TO-TYPE™.

Now you can add a new dimension of communications effectiveness to your computer generated data. The greatest choice of type styles and sizes. Bold type. Light type. Italics. And you'll save in page count. Time. And printing costs. The risk of typesetting errors is virtually eliminated because data goes from tape to type within the computer.

TAPE-TO-TYPE operating procedures are just as easy as the Tape-to-Print procedures you presently use. Find out for yourself. Write for the Alphanumeric TAPE-TO-TYPE Users Guide. It's free. See how your output tapes can be used to generate graphic arts quality type. Seeing is believing.

## Alphanumeric

INCORPORATED

10 Nevada Drive, Lake Success, N. Y. 11040 (516) 437-9000

Tape-to-Print

TAPE-TO-TYPE

**CONSUMER EXPENDITURES FOR HOUSEFURNISHINGS AND EQUIPMENT**  
ESTIMATED 1966 DISTRIBUTION OF DEMAND BY SELECTED FAMILY CHARACTERISTICS  
BASED ON EXPENDITURES OF NONFARM FAMILIES AND SINGLE CONSUMERS

ITEM	TOTAL	GEOGRAPHICAL REGION			
		NORTH EAST	CENTRAL	SOUTH	WEST
1 HOUSEFURNISHINGS AND EQUIPMENT	100	26.5	27.5	27.5	26.5
2 HOUSEHOLD TEXTILES	100	29.7	31.5	29.7	29.7
3 PILLOWCASES	100	29.7	31.5	29.7	29.7
4 BEDSPREADS, COMFORTERS, QUILTS	100	29.7	31.5	29.7	29.7
5 RUGS, CARPETS, MATS	100	29.7	31.5	29.7	29.7
6 CURTAINS	100	29.7	31.5	29.7	29.7
7 TABLE CLOTHS, PLACE MATS, NAPKINS	100	29.7	31.5	29.7	29.7
8 DISHES	100	29.7	31.5	29.7	29.7
9 TABLES, CHAIRS, SEATERS	100	29.7	31.5	29.7	29.7
10 BATH TOWELS	100	29.7	31.5	29.7	29.7
11 OTHER TEXTILES	100	29.7	31.5	29.7	29.7
12 FURNITURE	100	29.7	31.5	29.7	29.7
13 FLOOR COVERINGS	100	29.7	31.5	29.7	29.7
14 OTHER HOUSEHOLD TEXTILES	100	29.7	31.5	29.7	29.7
15 FURNITURE	100	29.7	31.5	29.7	29.7
16 FLOOR COVERINGS	100	29.7	31.5	29.7	29.7

CIRCLE 6 ON READER CARD

september

1968

volume 14 number 9



Publisher  
Editor

GARDNER F. LANDON  
ROBERT B. FOREST

Managing Editor & Art Director  
Associate Editors

CLEVE MARIE BOUTELL  
WILLIAM J. ROLPH  
AUBREY DAHL

Assistant Editors

WENDY REID  
JANET EYLER

Eastern Editors

F. BARRY NELSON  
ANGELINE PANTAGES  
PHIL HIRSCH

Midwestern Editor

EDITH GOODMAN

European Editor

PEARCE WRIGHT

Contributing Editors

HOWARD BROMBERG  
ROBERT V. HEAD  
PHILIP H. DORN

Washington Reporter

PHIL HIRSCH

Editorial Adviser

ROBERT L. PATRICK

Technical Consultant

LOWELL AMDAHL

Production Manager

MARILEE PITMAN

Director of Circulation

FRANK DeCARLO

Circulation Fulfillment

ALGENE TRAINA

### ADVERTISING OFFICES

Eastern District Managers

JAMES M. MORRIS  
WARREN A. TIBBETTS  
A. TREAT WALKER  
35 Mason Street, Greenwich, Conn. 06830  
(203) 661-5400

New England District Manager  
& Vice President

WARREN A. TIBBETTS  
112 West Haven Rd.,  
Manchester, N.H., 03104 (603) NAional 5-9498

Midwest District Manager

JOHN BRENNAN  
205 West Wacker Drive, Chicago, Ill. 60606  
(312) Financial 6-1026

Western District Manager  
& Senior Vice President

HAMILTON S. STYRON  
94 So. Los Robles Ave.,  
Pasadena, Cal., 91101 (213) 795-9721  
(213) 681-8486—from Los Angeles

### EDITORIAL OFFICES

94 So. Los Robles Ave.  
Pasadena, Calif. 91101

### CIRCULATION OFFICES

35 Mason Street  
Greenwich, Conn. 06830



Circulation audited by  
Business Publications Audit



Member,  
American Business Press, Inc.

DATAMATION is published monthly on or about the tenth day of every month by F. D. Thompson Publications, Inc., Frank D. Thompson, Chairman; Gardner F. Landon, President; Gilbert Thayer, Senior Vice President. Executive, Circulation and Advertising offices, 35 Mason Street, Greenwich, Conn. 06830 (203) 661-5400. Editorial offices, 94 So. Los Robles Ave., Pasadena, California 91101. Published at Chicago, Ill. DATAMATION is circulated without charge by name and title to certain qualified individuals who are employed by companies involved with automatic information handling equipment. Available to others by subscription at the rate of \$15.00 annually, single issues (when available) \$1.50. Reduced rate for qualified students. Foreign subscriptions are on a paid basis only at a rate of \$25.00 annually. No subscription agency is authorized by us to solicit or take orders for subscriptions. Controlled circulation paid at Columbus, O. and Form 3579 to be sent to F. D. Thompson Publications, Inc., P.O. Box 2000, Greenwich, Conn 06830. Copyright 1968, F. D. Thompson Publications, Inc. Microfilm copies of DATAMATION may be obtained from University Microfilms, Inc., 313 No. First St., Ann Arbor, Michigan.

Printed by Beslow Associates, Inc.

This issue 79,047 copies

DATAMATION

# Know why we changed our name from GC Computer to Greyhound Computer Corporation?

We changed our name in order to identify more clearly with the strength and financial responsibility provided by our association with Greyhound. This well-known name and its famous registered servicemark—the dashing Greyhound—will be an extremely valuable factor in our marketing activities. This change should help to eliminate confusion of this Greyhound company with other computer leasing organizations.

We're a full service computer organization. We're America's oldest and largest third-party computer lessor. We offer strategically located computer service centers, and highly experienced project management. We will shortly go nationwide with time-sharing. And we've just announced a new subsidiary, Greyhound Computer of Canada, Ltd.

Offices in principal cities. Or write Greyhound Computer Corporation, 10 S. Riverside Plaza, Chicago, Illinois 60606. Phone (312) 372-7562.

CIRCLE 7 ON READER CARD.



**Greyhound Computer Corporation**

Another growing service of diversified Greyhound Corporation



**The longer you rent a time-shared computer, the more it costs — but if you buy your own, the more you use it, the less it costs.**

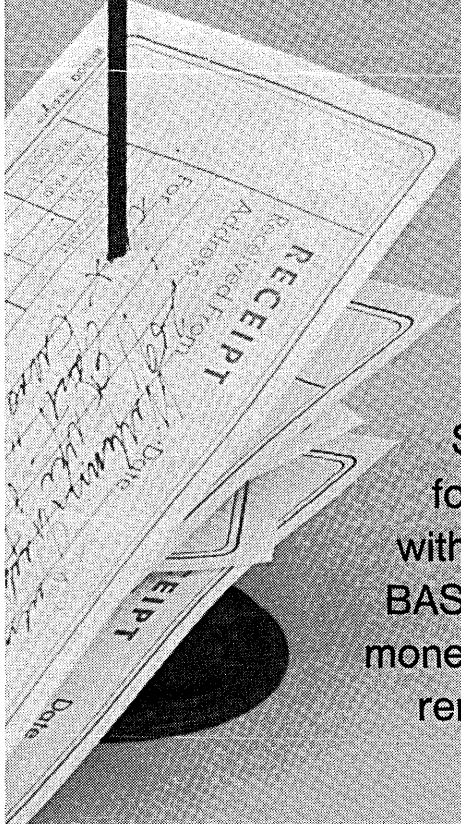

You can have your own Hewlett-Packard Time-Shared System for \$90K. And plenty of room for growth. Sixteen people can work with it simultaneously. In conversational BASIC. The more they use it, the more money it saves. Any idea how much rental \$90K can save you?

The HP 2000A Time-Shared BASIC System\* gives you —among other things—one HP 2116B Computer, 16K memory, expandable disc storage, a control teleprinter and proven time-share software.

The high-speed computer gives the illusion that one has the computer to himself. And integrated-circuit construction means long life without obsolescence.

Disc storage holds about 500 average-size programs, and can be expanded. The program library has two sections: public for all users to draw on, private for individual user programs. Software features include line-at-a-time compiling, extensive diagnostics, and full duplex echoing.

Terminals can be located anywhere. Direct wire connections save on phone charges. But with telephones, any number of terminals can be accommodated—within the limit of 16 at a time.

The genius of the HP Time-Shared System is its Conversational BASIC Compiler, a powerful programming language that you can learn in three to four hours. Yet the computer can also be used in the batch processing mode with Assembler, FORTRAN and ALGOL Compilers, peripheral I/O devices and scientific instruments.

So, when you're tired of paying the high cost of giant time-shared systems, see what \$90K will buy for you. Call your HP field engineer, or write Hewlett-Packard, Palo Alto, California 94304; Europe: 54 Route des Acacias, Geneva.



**HEWLETT  PACKARD**  
DIGITAL COMPUTERS

06821



# DATA MATION 68 <sup>®</sup>

september  
1968

volume 14      number 9

**22 INSTRUCTIONAL USES OF INTERACTIVE COMPUTER SYSTEMS, by Karl L. Zinn.**

*Although the use of computers as an aid to instruction has been studied for about 10 years, the field is still changing fast and there is a need for more investment of money and time.*

**28 CURRENT PROBLEMS IN CAI, by James L. Rogers.**

*Gaps in the instructional process, limitations imposed by systems characteristics, and a shortage of teaching materials are three major problems impeding CAI progress.*

**34 CAI LANGUAGES: CAPABILITIES AND APPLICATIONS, by Charles H. Frye.**

*Several CAI languages have been developed that enable course authors to prepare their own material without a lot of programming lore.*

**38 CAI—THE NEW DEMONOLOGY?, by Joseph H. Kanner.**

*Motion pictures, television, teaching machines, and programmed instruction have all been hailed in turn as the solution to education problems. Is CAI just the latest fad?*

**41 PLANIT—A LANGUAGE FOR CAI, by Samuel L. Feingold.**

*A programming language used for computer-assisted instruction should allow for easy instructor/computer communication as well as student interaction.*

**49 COMPUTERS AND THE LAW OF PRIVACY, by Richard I. Miller.**

*Whether the invader is a government agency or a private organization, the legal definition of privacy needs extension for individuals to cope with the computer.*

**56 INFORMATION SYSTEMS NEED NURSES, by Howard W. Runck**

*A registered nurse takes the pulse of automated hospital information systems and prescribes nurses' aid in their design.*

**62 NEW WIDEBAND DATA COMMUNICATIONS SERVICES, by Robert L. Davis.**

*A continual attempt to design faster and cheaper services for an expanding market.*

**71 DEC'S TIME SHARE—8.**

*The firm modifies the ubiquitous 8 again, this time to offer low-cost time-sharing.*

**73 NEWS SCENE.**

*McCall Corp. seeks direct access to wideband satellite channels . . . Private committee declares CAI costs prohibitive . . . French hope to find their own path to fourth generation . . . Standard security identification number offers hope for beleaguered brokers . . . Dr. Milton Mohr explains Bunker-Ramo's turnaround.*

**112 SYSTEM SPOTLIGHT.**

*A new department highlighting unusual applications and equipment configurations kicks off with a look at on-line analysis of oil well logs at Mobil Oil.*

**datamation departments**

9 Calendar	139 Books
11 Letters to the Editor	145 People
17 Look Ahead	151 World Report
21 The Editor's Readout	157 Washington Report
81 News Briefs	172 Datamart
115 New Products	179 Index to Advertisers
133 New Literature	183 The Forum

automatic  
information  
processing  
for business  
industry & science

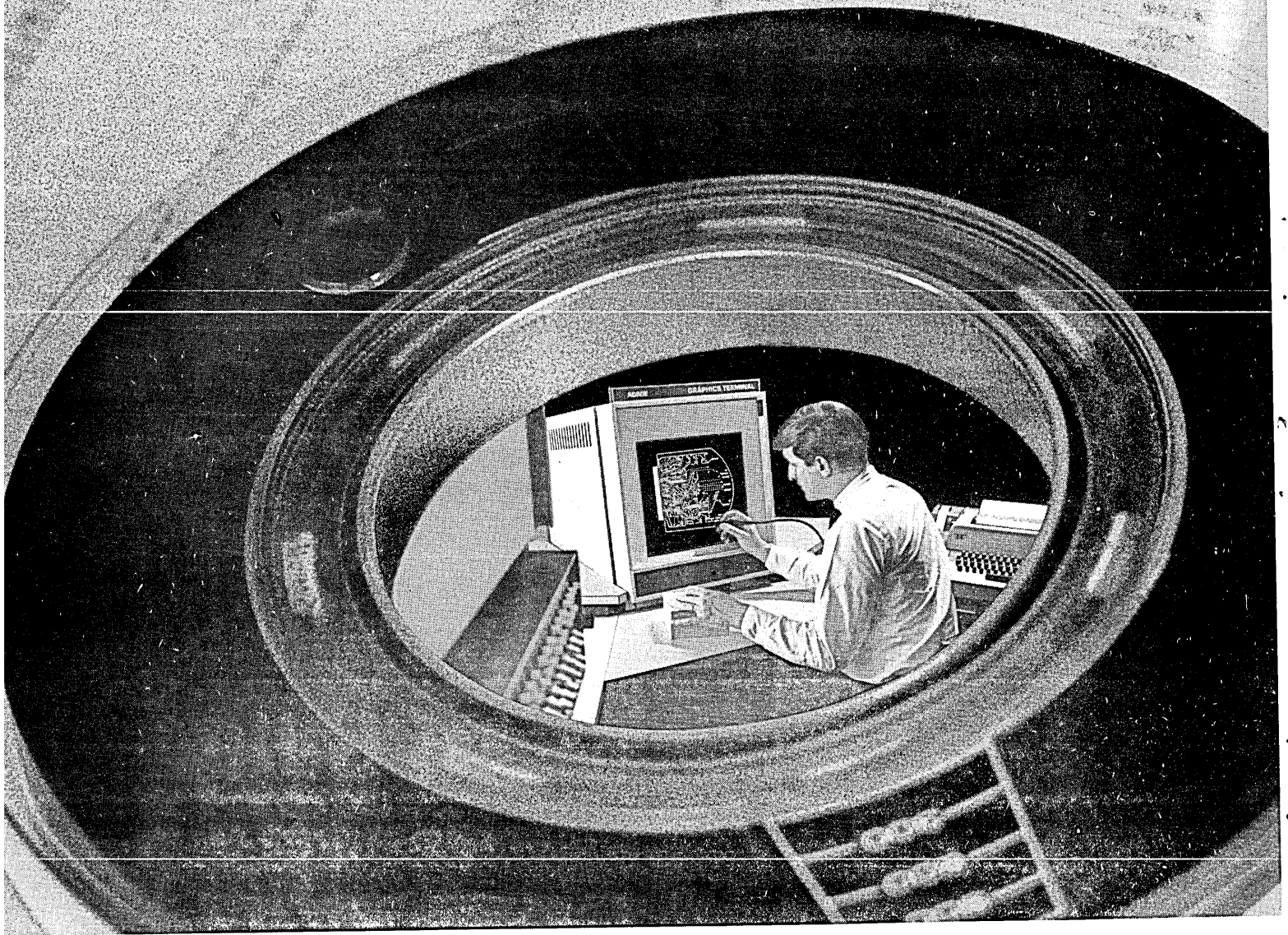

# There's more to interactive graphics than way out hardware

If you're using computer graphics for engineering or scientific simulation, for data analysis, or for machine-aided design, then you need the right kind of software to make your investment really pay off — no matter how great the display-system hardware.

You need a resident monitor that was designed specifically for on-line man/machine interaction. You need a full set of graphics operators so that you can display, construct, manipulate, and store CRT images. You need routines for communicating with the central computer facility, and I/O utilities for peripherals and graphics devices. You need a FORTRAN compiler, and a macro assembler, and an editor.

This is the software package we deliver our customers with every Adage Graphics Terminal. It turns on our way-out hardware.

For a brochure describing our standard software, write D. R. Sudkin, Marketing Services Manager, Adage, Inc., 1079 Commonwealth Avenue, Boston, Massachusetts 02215.

*Adage*  
INC

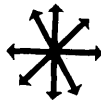
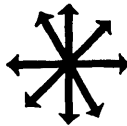

# calendar

DATE	TITLE	LOCATION	SPONSOR/CONTACT
Oct. 6-10	10th Annual EDP Conf.	Montreal, Canada	Nat'l. Retail Merchants Assn., 100 W. 31 St., N.Y. N.Y. 10001
Oct. 18	Symposium: Application of Computers to the Problems of Urban Society	New York	ACM/J.M. Spring, Computer Methods Corp., 866 Third Ave., N.Y., N.Y.
Oct. 20-23	International Systems Meeting	St. Louis	Systems & Procedures Assn., 24587 Bagley Rd., Cleveland, Ohio
Oct. 24-25	Mgt. Conference: Marketing, Manpower, Management	Detroit	ADAPSO, 420 Lexington Ave., N.Y., N.Y. 10017
Oct. 24-25	Symposium: Cybernetics & the Management of Large Scale Systems	Gaithersburg, Md.	Amer. Soc. for Cybernetics/Dr. Carl Hammer, Univac, 2121 Wisconsin Ave., N.W., Washington, D.C. 20007
Oct. 28-31	23rd Annual Conf. & Exhibit	New York	ISA, 530 Wm. Penn Pl., Pittsburgh, Pa. 15219
Oct. 28-Nov. 1	10th Annual Exposition & Conf.	Chicago	BEMA, 235 E. 42 St., N.Y., N.Y. 10017
Nov. 20-22	Seminar: File-68	Copenhagen, Denmark	Danish EDP Council, 1 Vesterbrogade, 1620 Copenhagen V, Denmark
Dec. 2-4	2nd Conf. on Applications of Simulation	New York	SHARE-ACM-IEEE-SCI/Julian Reitman, Norden-United Aircraft Corp., Norwalk, Conn. 06856
Dec. 4-6	Conference: Impact of OCR on Computerized Fla. Information Mgt.	Hollywood,	International Business Forms Industries, 20 Chevy Chase Circle, N.W., Washington, D.C. 20015
Dec. 9-11	Fall Joint Computer Conference	San Francisco	AFIPS, 345 E. 47 St. N.Y., N.Y. 10017
Dec. 9-11	24th Annual National Electronics Conference & Exhibition	Chicago	NEC, 1211 W. 22nd St., Oak Brook, Ill. 60521
Jan. 15-17	2nd Annual Simulation Symposium	Tampa	Simulation Symposium, P.O. Box 1155, Tampa, Fla. 33601
Jan. 22-24	2nd Hawaii International Conf. on System Sciences	Honolulu	Norman Abramson, Dept. of Electrical Engineering, Univ. of Hawaii, 2565 The Mall, Honolulu, Hawaii 96822

MAC  
is coming  
up.

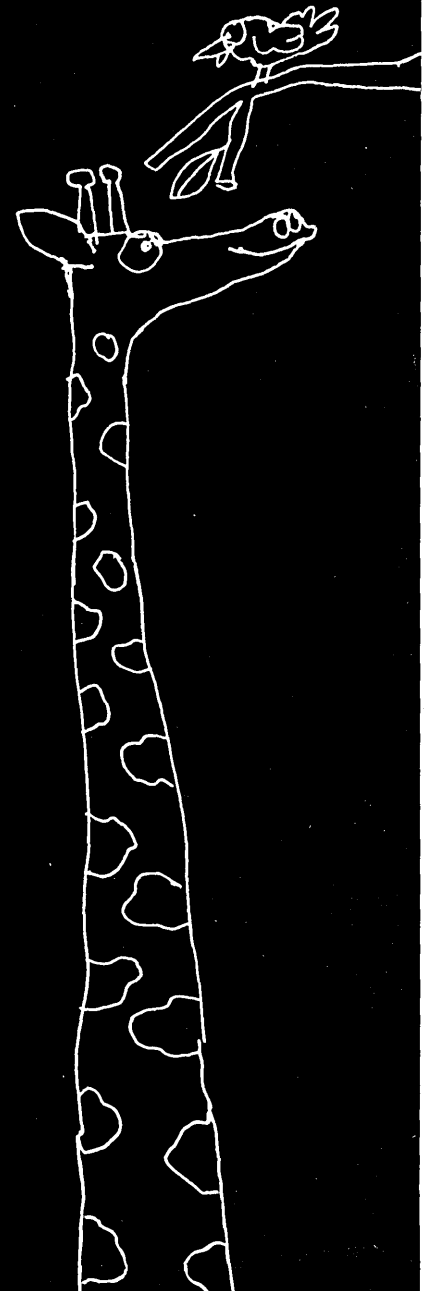

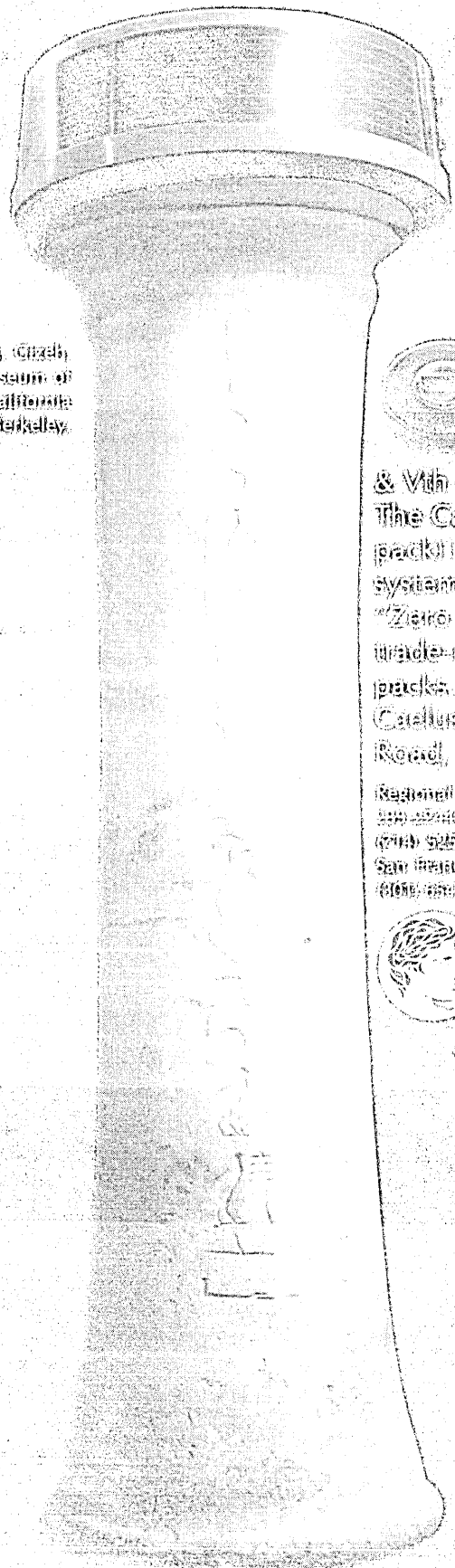

Offering stand of the Cheops period, (ca. 2600 B.C., Courtesy of the Bay Area Museum of Anthropology, University of California at Berkeley.



Objects of unnumbered value were often placed on special pillars during the 11th & 12th dynasties in ancient Egypt. The Carulus CIM XI (11 1/4 high disk pack) is now available for disk drive systems. Only Carulus offers the "Zero Risk" program providing made-in-Canada for CIM XI disk packs. Write for more details. Carulus International, Inc., 9167 Midway Road, San Jose, California 95133.

Regional Sales Representatives: Atlanta (404) 525-1200; Chicago (312) 231-1200; Los Angeles (213) 525-1200; New York (212) 525-1200; San Francisco (415) 525-1200; Washington, D.C. (202) 525-1200.





# letters

## cobol comments

Sir:

Re: "COBOL Versus UNCOBOL" (June, p. 67).

I appreciated Mr. De Blasi's article because as a COBOL programmer I know what he means when he says a program should be intelligible. I for one, however, never thought of using the remarks paragraph to its fullest potential as an aid in documentation and I also think I have learned a little in how to use disc in a COBOL program.

I would, however, like to make a few further remarks which my experience has proven to be of some aid in making a COBOL program more intelligible. First of all, I think that COBOL is much easier to read if in the DATA DIVISION the size clauses are further down the line. For example, 01 RATE-RECORD. (sic)

02 FILLER	SIZE 10.
02 RATE-TYPE	SIZE 3.
88 GROUP-A	VALUE "GPA"
88 GROUP-B	VALUE "GPB"
02 FILLER	SIZE 2.
02 RATE	PICTURE 999v99, SIGNED
02 FILLER	SIZE 5
02 FILLER-DATA	SIZE 35

This facilitates keypunching especially in longer records and I think makes it look neater. I personally tend to leave commas out of this DIVISION. Incidentally, at least in my computer, a SIZE statement automatically assumes alphanumeric, that is, the entire COBOL character set.

My second suggestion would be to have only one sentence of paragraph on a line. For example,

FIRST-STEP.

```

DISPLAY "BEGIN UPDATE RATE FILE"
UPON OPERATOR-CONSOLE.
OPEN INPUT TRANSACTION-FILE, IN-
INPUT-OUTPUT RATE-FILE.
MOVE TODAYS-DATE TO DATE-OF-
LIST.
WRITE PRINT-RECORD FROM LIST-
HEADING.
MOVE ZERO TO TALLY.
  
```

This would facilitate making changes to a program. If a sentence is more than one line its continuation on the next line should be indented a character or two (I tend to make this

homogeneous throughout the program).

IRWIN LASKIN  
Arlington, Virginia

## analysts training course

Sir:

I wish to point out an error of fact in News Briefs (June, p. 98).

ESL, of which I am the managing director, and of which Training Systems International Ltd., is the American marketing subsidiary, devised the Basic Systems Analysts Training Course for the National Computing Centre, and we have also prepared an international edition. We hold the exclusive license to manufacture and sell this package in any country in the world outside the U.K. and whilst we are flattered to read that S.R.A. is to handle the sales of the kit in the U.S.A., this does not happen to be the case. We will be announcing the name of the distributor we have selected and I will be pleased at that time to provide you with the proper information for your records.

R. J. Fox  
Middlesex, England

## a universal code

Sir:

Look Ahead (July, p. 17) mentioned the changing from other codes to ASCII as having slight effect on programs written in higher level languages. If you are thinking of modern systems and complete systems, you should perhaps re-evaluate your statement.

The collate sequence of machines has been ignored in the design of higher level languages; yet if files consist of mixed alphanumeric and special characters, then the sorting of these files and logical processing of them is dependent upon that machine's collating sequence. We don't have to re-program to go to ASCII—we have to re-systemize. We must perhaps re-order or change the control characters within our files and further must re-examine our programs for the insidious one of checking a code and saying, "If a high or low condition exists, then perform some operation." Every "if" statement in a COBOL program should be re-analyzed to make sure that the collating sequence of the machine has not de-

stroyed the current program logic.

I think that the idea of going to a universal code structure is excellent, but not easy—but I suggest an arbitrary structure that interposes special characters before, between and behind the alphabet and the numeric digits is not what we need. Let us not standardize on a system reminiscent of our English based system of weights and measures, but rather let us design a logical system that has some mnemonic value.

T. Y. JOHNSTON  
Sacramento, California

## obsolescent equipment

Sir:

With respect to Robert Patrick's "Let's Reprice Obsolescent Equipment" (July, p. 21) I would like to comment that he has presented a view which has certainly crossed many of our minds. Mr. Patrick was trying to use the laws of economics to arrive at re-

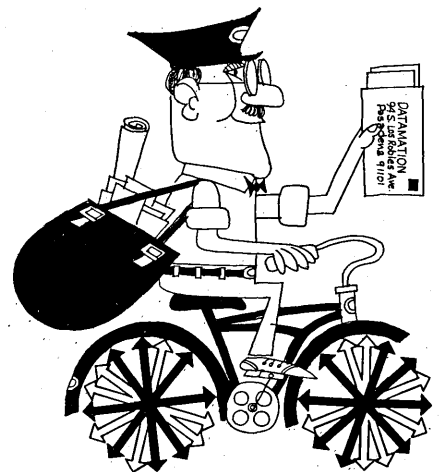

pricing policies for older computer equipment. In applying the laws of economics, Mr. Patrick has overlooked the most basic one: each entity desires to maximize its own economic interest.

The problem with his proposal is that there would be no incentive, and actually a tremendous dis-incentive, for the computer manufacturers to apply it. As soon as any new piece of equipment were announced, every customer using an old piece of equipment would test it and ask to have his old equipment repriced downwards. The manu-

## letters

manufacturer's rental revenue would be severely cut and if the old equipment were completely repriced downward to reflect true productivity as compared with the new item, then there surely would be no incentive for the user to change because the old product would be economically cost effective and would not require any changes in programming or procedures. In addition to a tremendous decrease in revenues, the computer manufacturer would then find a relatively small market for his new equipment.

As things stand now, because the new equipment is so much more cost effective, everyone orders it and the manufacturer's production lines swing into full gear. Many pieces of the old equipment are turned back to the manufacturer (if they were on rent) and he can find a second economic life for most of these pieces in other countries that are willing to settle for less technologically advanced computer systems than the United States. This, of course, solves political problems since we are keeping the most advanced equipment for ourselves rather than passing it on to possible competi-

tors in other countries.

Needless to say, if the equipment were sold instead of rented, then the manufacturer would have even less incentive for repricing the obsolescent equipment downward since this would only more obviously depreciate his older purchased equipment and annoy previous customers who purchased at no possible advantage to the manufacturer.

There is still another factor which we would want to take into consideration. Even though new equipment in terms of basic, raw potential for processing work may have a substantial advantage over older equipment, the fact that the software and systems for the older equipment have been well developed usually keeps it far more competitive in throughput than raw speed comparisons would show. Thus, we can say that the older equipment does not immediately become obsolescent, and in fact, only approaches obsolescence as software development for the new equipment matures over time to make throughput on the latest generation truly more effective. In addition, of course, we have so much trouble measuring throughput standards to compare computers in the same generation that it would be very difficult to arrive at a standard for repricing old

equipment downwards as Mr. Patrick suggests.

To summarize, I think Mr. Patrick presents a point of view that has occurred to almost all of us in the computer field who have any economic training. The problem is that there is no practical way for implementing his suggestion other than by legislative fiat. Were this to happen, there is no question that the cost of computing would drop in the short run, but the long-term effects would be very disastrous since the lower cost of computing would be reflected in lower revenues for computer manufacturers and a significant reduction of the incentive to improve machines and to technologically progress. Unfortunately, therefore, we have to conclude that our only salvation is to standardize on languages that will enable rapid and rather painless conversions from one machine to another and solve the problem of the tremendous waste of scarce manpower that goes into conversion.

GEORGE SCHUSSEL  
Huntsville, Alabama

Mr. Patrick replies: The above letter is worth rereading. It says the users must subsidize the manufacturers to keep factories producing at full capacity. Just how do we cry ENOUGH? To the contrary, if a manufacturer has the choice of longer life at reduced rent or no rent at all, I believe he is rational enough to accept the lesser figure if it exceeds his maintenance costs. It is specious reasoning to believe that just because a computer is new and has a low price that it is profitable to manufacture. The profit doesn't come until the cost has been repaid. While it might seem heretical, the benefits to us as individuals, a profession and as a country accrues only when we fill a need of society. The growth of the field fills that need. The unreasoned replacement of equipment due to an aberration of pricing is not progress when the users stand still for two years while the factories run full. If the mechanism I proposed is unworkable, let us find a way to make it work or propose another — the problem still exists. Magic languages are not the answer for an important class of problems.

### program testing

Sir:

Testing and validating of programs is a time-consuming and demanding part of programming as pointed out by Professor Gruenberger (July, p. 39). I have had to learn the pitfalls and short cuts by trial and error, and would have appreciated some lessons in the technique when I first entered this field.

Even with much experience in testing one still can fall prey to the hidden traps laid by a program. Professor Gruenberger in his discussion on controls mentions "hash totals" and then illustrates testing a payroll file using social security numbers for the hash total. His illustration yields a hash total

## SEEKING SOPHISTICATED INVESTMENT COUNSEL?

*If you are confused as to the best investment counsel firm to handle your portfolio, perhaps we can help. We analyze investment counsel firms and suggest which ones are particularly appropriate given your investment objectives. Our dispassionate view, together with appropriate suggestions, recommendations, and introductions can be useful to institutions and private investors seeking better management for their funds. Inquiries are invited from individuals or trustees whose accounts exceed \$250,000.*

*For further information without obligation please write or telephone Mr. E. P. Mager.*

### SEIDEN & DE CUEVAS INCORPORATED

Members New York, Boston, Midwest, Pacific Coast Stock Exchanges  
Philadelphia-Baltimore-Washington Stock Exchange  
Associate Members American Stock Exchange

110 Wall Street, New York, N. Y. 10005 • (212) 943-2887

D-1

difference of 387093834. He then states, "We then know that we're probably off by one record. . . ."

Depending on how the social security numbers are stored in file, he could have more than one. If stored as xxx-xx-xxx there could be three missing files, such as 129-03-1270, 129-03-1280, 129-03-1284 which would add up to 387-09-3834. If the number were stored as a single 9 digit number then the number missing could just as easily be more.

If Professor Gruenberger's statement had read, "We then know that we may be off by one record . . ." it would have been more accurate.

The number of tests that need be made depend on the complexity of the program and files. In the cited hash total test, a complete guarantee that the files are correct with 0 difference is not assured but is likely.

I was a bit disappointed that Professor Gruenberger had not indicated,



even briefly, his recommendations for the 12 exercises at the end of his article. I would have found it interesting to compare his methods to those I would devise.

**NORMAN A. BONSALE**  
New York, N.Y.

Professor Gruenberger replies: Mr. Bonsall is absolutely correct. His observation points up that program testing is an art, and that there are no set rules for it; each new problem requires its own test and the programmer's ingenuity. It is fun to take the "airtight" tests that students invent and drive a truck through the gaping holes in their logic. For example, if any logical step in the problem's solution can be deleted and their test still seems to work, then it is invalid.

**sales to the east**  
Sir:

I could not help getting the impression that Mr. Perkinson (July, p. 31) is wholeheartedly in favor of East/West

trade. He did not come out and state this, but the tone of his article was such that there could be no mistake about his position.

A number of responsible individuals have serious doubts about the long-range benefits to our country of exporting advanced technology to Communistic dictatorships so that they will be in a position to increase their threat to our way of life.

I recognize that Mr. Perkinson makes his living selling wares incorporating advanced technology produced under a free enterprise system to Communistic dictatorships and that he cannot afford to upset his customers too much or else they may deny him visa, and thus access to his markets. However, I think it is only fair to ask individuals like Mr. Perkinson who believe that it is possible to separate business from politics in dealing with the Communists, to be a little more discreet in their support of this philosophy when they use a technical forum such as DATAMATION.

**F. O. GULBRANDSEN**  
San Diego, California

Mr. Perkinson replies: Mr. Gulbrandsen is quite correct in his assumption that I am in favor of East/West trade, as is the U. S. State Department which has to approve of these transactions insofar as they involve American components or systems. It should be carefully noted, however, that this trade is not without restrictions, in particular with reference to computer system sales. Thus, neither "advanced technology" nor systems useful for solving large-scale scientific problems are offered by Western suppliers. Indeed I do make my living selling to these countries, and need to be concerned with my "image," my personal and business relationships. But for my company, and I am quite certain for my competitors as well, the overriding consideration in each transaction is based on a careful evaluation of the desirability to sell a certain system from the practical, political and economic points of view, not the quota. Of course you can't separate business from politics, but the mutual interests here are quite properly handled at a much higher than my level. And finally I take issue with Mr. Gulbrandsen as to whether or not *Datamation* is an appropriate magazine to publish this article. If indeed, as he suggests and I concur, you can't separate business from politics, then why try? *Datamation* readers are citizens too, and moreover as technical persons they need to be informed about these matters, perhaps especially because they are controversial.

#### library fellowship

Sir:

Students at the School of Library Science, Case Western Reserve University, have initiated a fellowship in honor of Dr. Martin Luther King, Jr. Our aim is to provide financial assistant for cwru graduate students preparing to specialize in library service to disadvantaged people. A foundation

# Problem:

## CONSTRUCTION COSTS



# Solution:

C-E-I-R was called upon to help a building firm which was committed to a large construction project but which was losing money. The complexity of the project, involving literally thousands of activities and hundreds of skilled workers, made precise scheduling and materials allocation by standard means impossible, and coordination difficult. The company was not using manpower or materials efficiently. C-E-I-R used its network analysis techniques to compute a detailed schedule which assured the planning for all jobs, the availability of resources, and the completion of work without delays.

# Results:

Through the schedule provided by C-E-I-R, the builder was able to make the most efficient use of his men and materials, to maintain his building schedule and to save many thousands of dollars. Experience has proved that these techniques can reduce construction cost by 1½% to 3%.

**YOUR PROBLEMS ARE OUR BUSINESS!**  
This contractor was helped by our Project Management Systems Staff.  
Call or Write:

**C-E-I-R INC.**  
THE PROFESSIONAL CONTROL DATA SERVICES CORPORATION  
SUBSIDIARY OF

5272 River Rd., Washington, D.C. 20016  
Phone: (301) 652-2268

# Air Conditioning is okay for people ...but not computers.



Computers need continuous environment control—just the right conditions of temperature, humidity and filtered air—24 hours a day. SES<sup>®</sup> Site Environment Systems, are specifically designed and built to provide these requirements. They create and maintain the ideal ceiling-to-floor, wall-to-wall environment for computer rooms, no matter how large or small. There's a unit or combination of units to meet your exact needs because SES is available in a complete range of sizes—3, 5, 7½, 10, 15 and 20 tons. And they are completely self contained for easy installation. Yet they're so flexible they can easily be changed to up-flow or down-flow air discharge arrangements in the field.

Do your computer a favor and check out SES Site Environment Systems. Write Environment Control Division, Floating Floors, Inc./Subsidiary of National Lead Company, Room 4618, 111 Broadway, New York, N.Y. 10006.

SITE ENVIRONMENT SYSTEMS  
**National Lead**  
Environment Control Division



CIRCLE 13 ON READER CARD

## letters

has offered to match contributions made before January 1, 1969, on a dollar-for-dollar basis, up to \$5,000.

We plan to use money collected to finance at least one student beginning in the fall of 1968, rather than to postpone action to build a capital fund. We feel it is important to enable even one librarian to prepare for this work now.

We believe that persons concerned with the information and communication needs of society will agree that there is an immense need for expansion in the services that librarians can provide to the disadvantaged—from children's libraries and literacy programs to vocational training. We would encourage qualified students from minority groups as well as others to apply for training under this fellowship.

Contributions should be made payable to: M. L. King Library Fellowship and mailed to: Dean Jesse H. Shera, School of Library Science, Case Western Reserve University, Cleveland, Ohio 44106.

JOSEPH C. DONOHUE  
*Cleveland, Ohio*

### plumps process control

Sir:

As the title of your magazine suggests a blending of the words "data" and "automation," it is surprising to find a continuing lack of articles dealing with the segment of the computer industry whose bread and butter is "data" and "automation": the process control computer.

For your readers' information, there are large scale, multi-computer process control systems in operation today which combine the background processing, memory protect features of third generation computers with the massive on-line data collection and control capability of process computers to provide an unparalleled management information system for large industrial processes. As the future points to extensive proliferation of the on-line, real-time computer applications, your magazine will not much longer be able to selectively ignore the process control segments of the industry. The process control field is no longer the Model T workhorse of the computer industry, but is rapidly becoming the streamlined, supercharged profitmaker of American industry.

Your recognition of this fact is long overdue.

ROBERT J. MATHERNE  
*Taft, Louisiana*



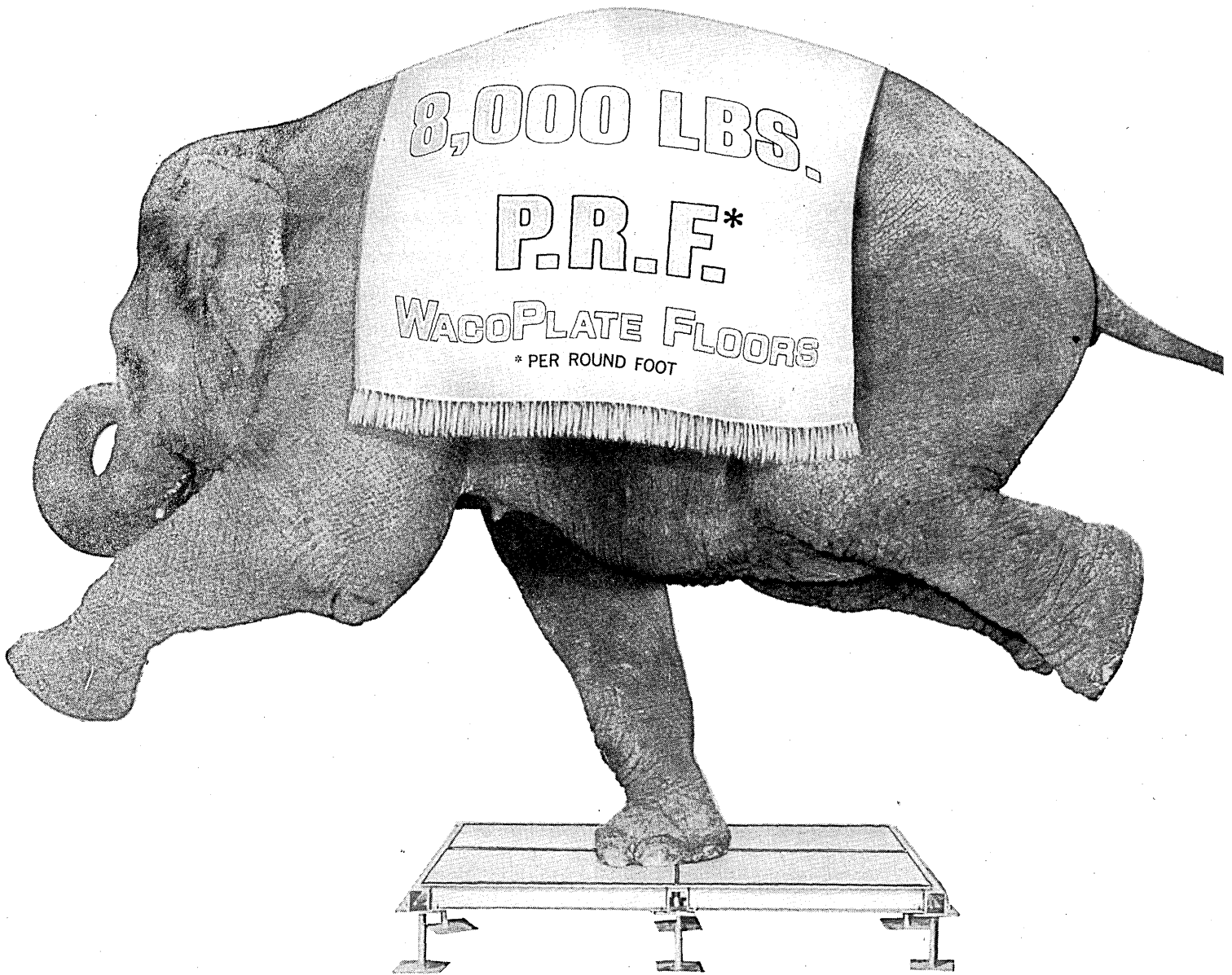

## OK, load our raised floor with 8,000 pounds on one foot!

(but don't try it with any other floor)

WacoPlate Raised Floors provide two advantages you won't find in any other floor. Anywhere.

One is more strength than any other floor. You avoid problems like deflection and dimpling, or costly reinforcement to meet later — possibly unforeseen — requirements.

Why do other floors lack the strength of WacoPlate? Can't be because a weaker floor avoids problems. Or saves you money. WacoPlate prices are competitive.

The second exclusive advantage of WacoFloors is that they provide complete accessibility without sacrificing stability. The explanation is our Snap-Lok Rigid Grid System. The stringers in this grid system give the floor rigidity, strength and stability, yet they are easily removed and replaced. No loose fasteners are required.

**WacoFloors are installed with panels of steel or wood core. For complete details, dial direct or write.**

Stringers are easily removed from the exclusive Snap-Lok Rigid Grid System.

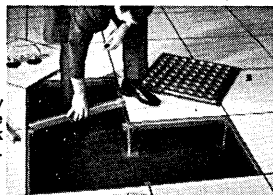

## WACOFLOORS

WASHINGTON ALUMINUM CO., INC.

Knecht Ave. at Penna. R.R. • Baltimore, Maryland 21229  
301 / 242-1000

*There is no equal to a WacoFloor*

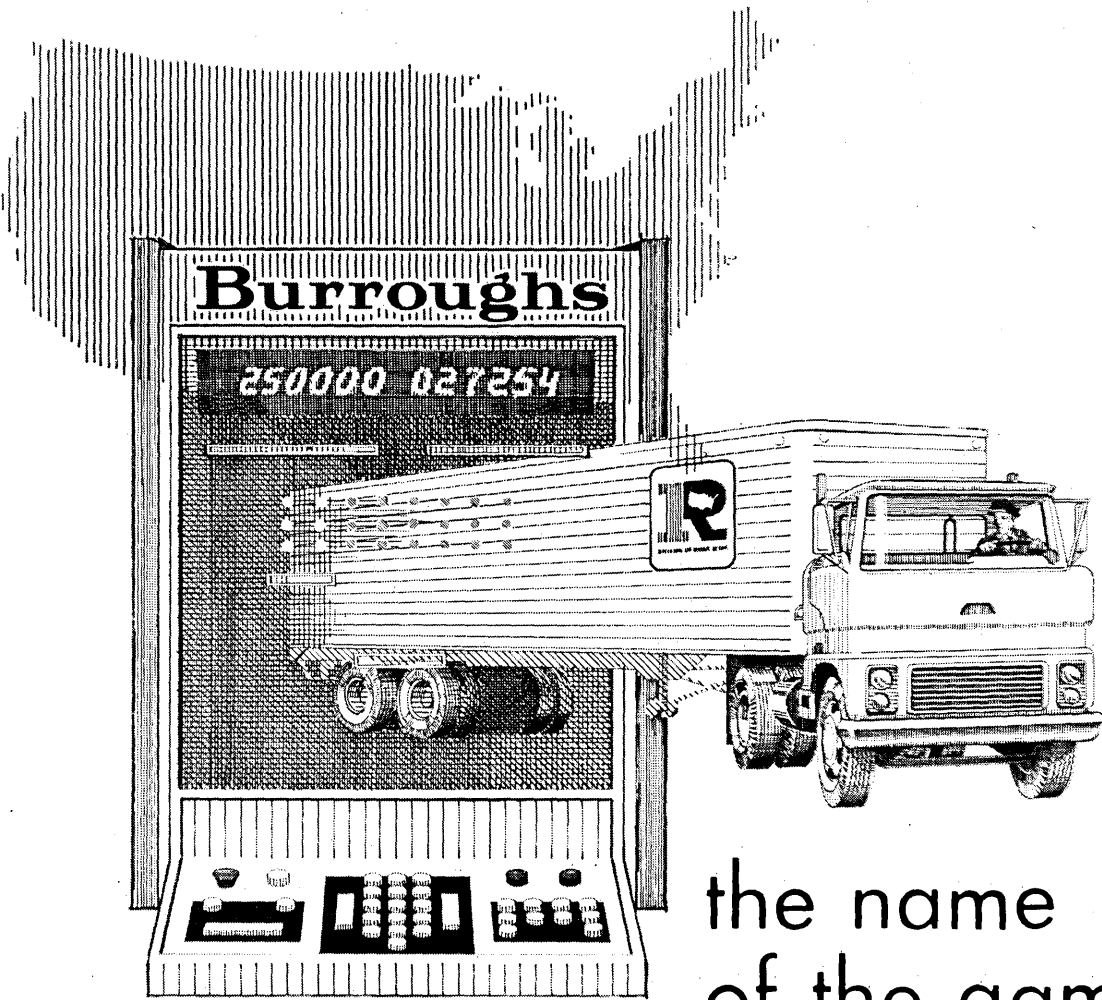

the name  
of the game  
is

# CONTROL

Suppose you had to keep track of 17,000 trucks criss-crossing the U.S. and Canada.

Suppose you had to measure their performance. Schedule maintenance. Develop profit control programs. Pull in operations data from 225 far-flung terminal points.

Suppose you had to solve all kinds of transportation and distribution problems for the world's largest "transportation services" company, a firm involved in everything from short term truck rentals to computerized fleet management.

Suppose, too, your computer handled on-line data communication plus a mix of regular jobs at the same time. And provided in-depth control over your company's fast-paced and expanding operations. And came equipped with the industry's best and best-proven automatic operating system.

Then you'd be working for Ryder System, Inc., of Miami and 209 other cities . . . an exceptional company.

And you'd be working with the Burroughs B3500 . . . an exceptional computer.

Burroughs 

# look ahead

## GRAND OLD NAMES OFFER NEW METRICS SOFTWARE

Beleaguered dp managers seeking ways to measure effectiveness of hardware or software configurations may have help on the way from some ancient and famous names: Boole & Babbage...not the you-know-who's, but a Palo Alto-based software firm founded in Oct. '67.

B&B is offering two sets of programs: PPE (Problem Program Efficiency) samples 360/30 & up OS/PCP, MFT and EMFT programs as they run, extracting information for a separate analysis run to provide histograms and reports indicating relative amounts of time spent on various kinds of activities. The result: isolation of segments where it pays to tighten source code or to redesign the segment. Initial results indicate 15-25% savings in machine times. Soon-to-be-available versions will operate under MFT2, MVT, DOS & TOS.

CUE (Configuration Utilization Efficiency) extracts data and provides reports on channel and peripheral usage, disc arm movement and SVC load activity. The information can be used to improve hardware configuration balance, organization of data sets, and assignment of software segments to residence or secondary store.

Now available under OS/MFT and EMFT, CUE will soon be available for MFT2, DOS and TOS. Both packages operate without altering the user's system and can be purchased or leased. As a demonstration offer, B&B will analyze well-defined card or tape programs with less than five-minute running times on a 360/65 for \$250 plus machine time (\$100-200).

## NOW IT'S KEY-TO-DISC THROUGH A COMPUTER

A new Los Angeles firm, Computer Machinery Corp., will manufacture and market a system called the KeyProcessing System, designed to replace key-to-tape devices by permitting up to 32 keyboards, each connected to and controlled by a small computer, to operate simultaneously in either the data entry or verify mode on up to 32 job formats. Processed data is stored in locations unique to each keyboard on an IBM 2311-compatible disc unit with a 7.25 million character capacity. The data can then be outputted to mag tape, cards, or disc for storage.

The basic KeyProcessing System consists of the small computer, which functions mainly as a multiplexer, six keystations, the disc storage unit, and the system software. It leases for \$1,400 a month, with additional keystations at \$75 a month each. The company claims substantial savings over the Mohawk Data Recorder, with volume operation, and plans delivery in April.

## FANCY MULTI-FONT READER HEATS UP OCR RACE

Scan-Data Corp. is another of the Wall Street wonders whose stock rose from a mere 7½ to over 175 in a few months -- all on the strength of the words "optical scanning." The 75-man Philadelphia company, formed

Name.....  
Address.....  
City.....  
State..... Zip.....

American Technological Institute  
Subsidiary of F. D. Thompson Publications, Inc.  
Dept. D, 35 Mason St., Greenwich, Conn. 06830

Send me your free catalogue by return mail. I understand there is no obligation and no representative will call.



This is the most powerful, yet easiest to use, calculating/computing system available. It's also the most versatile. You can create your own individualized system by selecting true building block modules from a family of peripheral devices larger than all competitive calculating products combined. Start with a basic 300 Series calculator if you like; add accessories as needs grow without worrying about compatibility, obsolescence, retraining or special program languages. The 370 will loop, branch, perform subroutines and manipulate arrays. You can have up to 480 steps of program storage and up to 64 separate data storage registers, also automatic typewriter or teletypewriter output, CRT graphic display and time-sharing basic keyboards for your associates.

**The 370 solves these problems . . .**

for Engineers and Scientists:  
**Inversion of 6 x 6 Matrices,  
 Roots of Equations,  
 Up to 7 Simultaneous Equations,  
 Fourier Analysis.**

for Statisticians:  
**Mean, Variance and Standard Deviation,  
 2nd-order Regression Analysis,  
 Distributions such as:  
 Binomial, Normal Probability, etc.**

And also:  
**General Nth-order Regression,  
 Multiple Regression,  
 Analysis of Variance,  
 Factorial Design.**

These and many other highly-useful programs are furnished free in a 250 page program library. Three volumes of basic calculator programs and a two-volume 370 reference manual are also offered. Call now for complete details.

**Solves problems  
 ordinary calculators can't,  
 full-scale computers  
 shouldn't.**

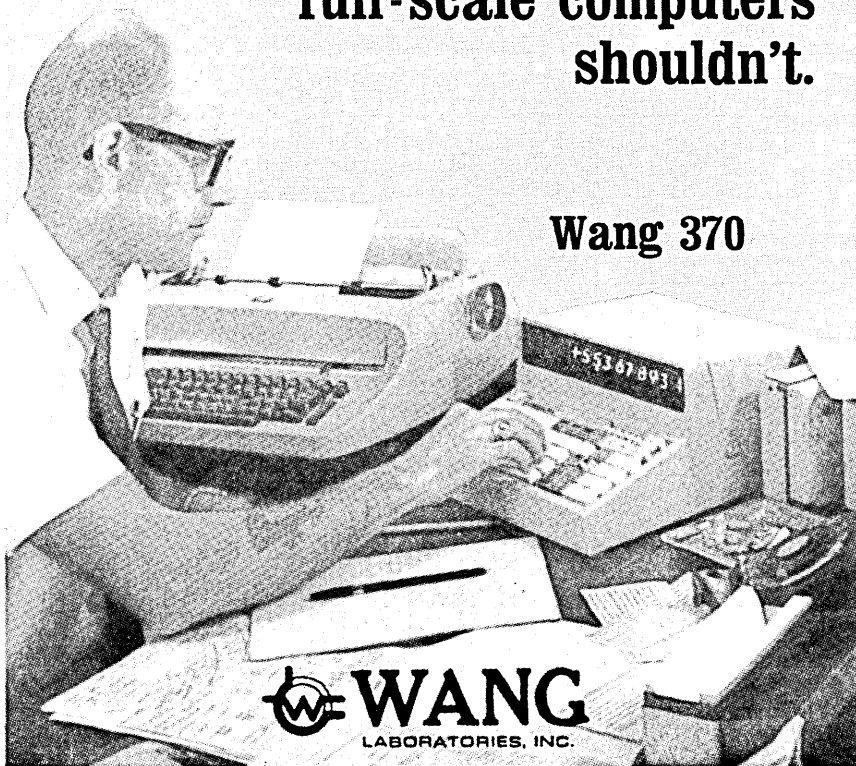

**Wang 370**

Dept. 96, 836 North St., Tewksbury, Massachusetts 01876 • Tel. 617 851-7311

**Call today for immediate trial:**

(201) 241-0250	(215) 642-4321	(309) 674-8931	(412) 366-1906	(601) 982-1721	(714) 234-5651
(203) 223-7588	(216) 333-6611	(312) 889-2254	(415) 454-4140	(602) 265-8747	(716) 381-5440
(203) 288-8481	(301) 588-3711	(313) 278-4744	(415) 692-0584	(608) 244-9261	(717) 397-3212
(205) 595-0694	(301) 821-8212	(314) 727-0256	(504) 729-6858	(612) 881-5324	(805) 962-6112
(206) 622-2466	(303) 364-7361	(317) 631-0909	(505) 255-9042	(615) 588-5731	(816) 421-0890
(212) 682-5921	(304) 344-9431	(402) 341-6042	(512) 454-4324	(616) 454-4212	(817) 834-1433
(213) 278-3232	(305) 564-3785	(404) 457-6441	(513) 531-2729	(617) 851-7311	(901) 272-7488
(214) 361-4351	(305) 841-3691	(405) 842-7882	(517) 835-7300	(702) 322-4692	(916) 489-7326
			(518) 463-8877	(703) 877-5535	
			(601) 234-7631	(713) 668-0275	(919) 288-1695

**NEW**

**ADDRESS?**

We know you want Datamation to follow you. If you're changing your business address, please use the card at the right and mail it to us now. We need your old address label, too. Paste it on the card (see instructions) to facilitate handling.



**NEW AD**

Name \_\_\_\_\_

Title \_\_\_\_\_

Company \_\_\_\_\_

Address \_\_\_\_\_

City \_\_\_\_\_

Your Sig \_\_\_\_\_

**DATAMATION  
 INFORMATION**

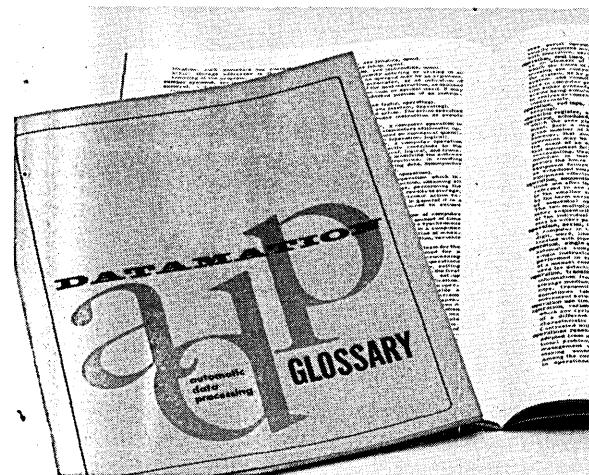

Whatever your work in information processing, you'll find the ADP Glossary. It gives you a ready reference for daily EDP use. It covers the terminology of electronics, communications, systems, and computers.

This glossary has provided students as a reference to systems, and has provided familiarity with the special terminology for customer, prospective, preparing or evaluating proposals.

*Please use the attached coupon.*

*62 pages cross-referenced*

**\$1<sup>00</sup>** each

**75c**

*in lots of 10 to 49 copies*

**50c**

*in lots of 50 or more copies*

**D**

35 A

Please

Name

Address

City

## look ahead

Jan. '66, does indeed have a product, as well as pending patents on recognition techniques and the document feeder. One system is installed and three more will go out before year end. The scanner, a page reader which comes as a model 100 (with software for typesetting applications) and model 300 (software for edp jobs), will be announced with technical details this fall.

The system has the ability to read from four to over 20 fonts; its "multi-level feature extraction" technique also permits reading of hand-printed upper-case letters and numbers (optional). Document size: 6"-12" wide, 8"-14" long; continuous form reading is optional. Scan rate is 400 cps. Recognition Equipment Inc.'s retina reader has a 2400 cps rate, but Scan-Data claims that because of design differences both systems have about the same document throughput rate.

The scanner is controlled by the hardware and software of a small (PDP-8 size) computer. A basic system reading four fonts, with feeder, scanner, cpu, and tape unit, costs \$385K.

### NEW MONEY BRINGS NEW MODELS AT INFO TECH

With the help of some dollar injections, Information Technology (Aug. '65, p. 17; Feb. '66, p. 17) hopes to step up production of its expanded 4900 computer line. A \$100K federal "innovation loan" and another \$100K from private investors will be used to expand facilities for making a new production version of the 16-bit 4900, for which there are 10 orders. The 30-man Sunnyvale, Calif. firm, in the black since '65, has 15 machines installed. It grossed \$250K last year and is shooting for twice that this year.

New versions of the 4900 include the byte-oriented model 10, the 16-bit mod 20 and the 32-bit mod 30. Core memory cycle time is 2 usec, with a 750 nsec access. The firm is also appointing sales reps, is looking for a marketing manager. Current backlog is \$600K.

### MOTOROLA ENTERS MINICOMPUTER RACE

Latest entry into the crowded minicomputer marketplace is Motorola Instrumentation & Control Inc., Phoenix. The firm, whose edp activities so far have been restricted to source data acquisition, will unveil a monolithic i.c. 8-bitter at the FJCC. The MDP-1000 (Motorola Data Processor) will offer 4K words (expandable to 16K) of 2.16 usec cycle core. The 1000 will be in the \$8500-\$10K price range.

### COMPUTER MAKERS AWAIT ASCII DIRECTIVE

Nervous mainframe makers awaiting the feds' ASCII implementation letter -- due out this month, perhaps -- will be happy to note that at least one federal official doesn't think "it's necessary to specify internal operating codes."

The official is Herb Grosch, director of the NBS Center for Computer Science & Technology. But Grosch stresses he speaks for himself, implying others -- at the center and probably elsewhere in the federal adp establishment -- want ASCII extended inside the box.

The letter (actually a directive) will require essentially all federal agencies ultimately to encode all their internal files in ASCII, besides using it for information interchange. First to be affected will be agencies acquiring dp systems for the first time, plus those replacing existing installations. Users who rely on existing files while augmenting older systems will be reprieved until they re-program.

(Continued on page 163)

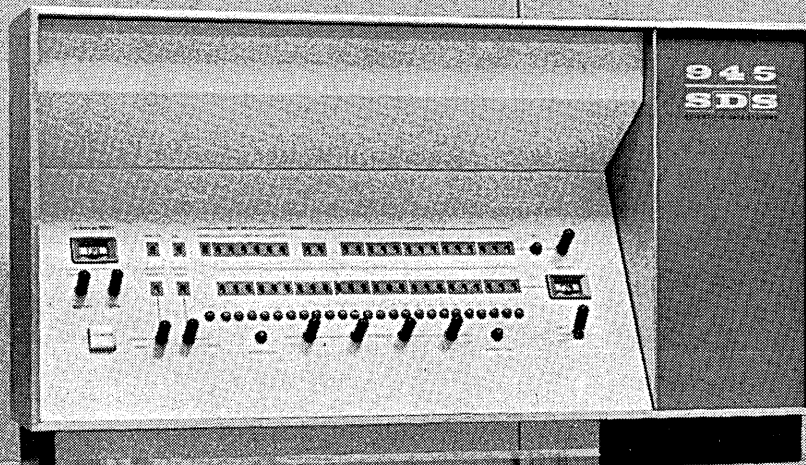

**We put the best time-sharing software you can get in a less expensive box.**

**\$10,000 a month less.**

Anyone who knows much about time-sharing knows that our 940 has the best time-sharing software you can get. Because there's more of it, and it can do more, and because it is working.

But up to now the only way you could get our 940 software was to get a 940, or rent time on one.

Now you can also get it with our new 945 computer. The 945 will cost you less than \$15,000 a month. That's about \$10,000 a month less than a 940. And it's as cheap as renting 5 full time terminals from a time-sharing service bureau. (You get 24 with the 945.)

In fact, the 945 is the least expensive time-sharing computer on the market. It's every bit as fast as a 940, it has the same excellent response time, and it uses the same software.

Which means that the 945 comes complete with Basic, CAL, conversational Fortran, Fortran II, a

two-pass assembler, a text editor (QED), a debug package, a utility package and a complete library of special programs and routines. And even though the 945 is new, the software has been proven by the toughest customers you can find: time-sharing service bureaus.

Then why is the 945 so much cheaper?

Simply because fewer people can use it. The 940 is designed for service bureaus and large companies with hundreds of different users. The 945 is designed for companies and institutions with dozens of users.

The 945 can recognize up to 64 individual users. And up to 24 people can use it at the same time.

That, more or less, is the whole idea of the 945.

Less people can use it and more people can afford it.

**SDS**  
Scientific Data Systems,  
Santa Monica, California

# editor's readout

---

## OVER THERE AGAIN

Two years ago, after a visit to Europe, we wrote an editorial claiming that Europe's social, political and economic barriers were preventing the establishment of a viable European computer industry.

Well, we're back from another brief visit to the U.K. and the Continent and talks with some leading European computer people, and we'd like to report that things have changed a great deal . . . that Europe is readying an effective counter-attack to the American computer invasion, which continues with unabated ferocity.

We'd like to, but we can't.

It's true that the French government is pouring beaucoup francs into *Plan Calcul* in an ambitious attempt to establish an industry there; the British, meanwhile, have knocked some heads together and put some pounds behind ICL, its national entry into the European computer sweepstakes. And giant Philips looms as a possible dark horse as a result of its belated entry into the market. West Germany sleeps on, content to support its own manufacturers with regulations which restrict government purchase of foreign-made computers.

But the attempts of the English and the French to stave off IBM and the lesser assaults of other American firms show severe weaknesses.

ICL, for instance, faces strong pressure from IBM in the low end of its product line (see News Briefs), but receives Ministry of Technology funding to announce a giant machine which will not be available until mid-1972. Meanwhile, Computer Technology Ltd., which looks to have a sure winner in its Modular One (in the Sigma 2 class), has had to go outside the country for financial backing (it's 51% British owned) and is only now anticipating MinTech approval and orders after two years of existence. But CTL is money- and production-bound, probably won't be able to try to crack the American or Continental markets for a couple of years.

Another example of British sluggishness: a major manufacturer was approached by Americans seeking to sell peripherals OEM in the States. Certainly not. The company had a man in New York.

The French, meanwhile, announce this month their new computer, aimed smack at the middle of the most crowded computer market of them all (see News Scene).

An attempt to form a British-French computer development venture is dead for keeps, and efforts to form a multinational European company have never gotten off the ground. Philips, we're told, will move slowly and cautiously.

All of this, we're afraid, plays into the hands of aggressive, well-heeled American companies, who operate across national boundaries, unlike their provincial European competitors.

The French and English efforts appear to us to be too little and too late. An advanced computer technology is not established in three or four years; and intramural marketing efforts lack the scope to provide a production/profit leverage to match the Americans.

If there is to be a successful answer to the American invasion, it must involve the cooperation of two or more European countries, sharing a jointly planned product line, technological R&D, and marketing efforts. Such cooperation in Europe is highly unlikely in the foreseeable future.

# INSTRUCTIONAL USES OF INTERACTIVE COMPUTER SYSTEMS

by KARL L. ZINN

Instructional uses of computers have been under investigation for about 10 years, and the field continues to change rapidly from year to year. The purpose of this overview is to provide a framework, a few specific examples to complement those found elsewhere in this issue, and references to more detailed information. I do not intend to sell a potential user on instructional applications of computers; the cost can be high and the benefits are still in question. I do hope to influence other readers to invest research dollars and personnel resources in work needed to make the systems and teaching strategies more usable. Therefore, I will discuss current problems as much as the potentials for interactive instruction systems which have already been overly praised in most popular journals.

## a brief history

At least three projects can claim to have begun planning in 1958. A demonstration of computer teaching of binary arithmetic was made at IBM's Thomas J. Watson Research Center, Yorktown Heights, N.Y., and was reported by Gustave Rath and others in a book on "Automated Teaching" edited by Eugene Galanter (Wiley, 1959). A research effort begun at System Development Corp. about the same time used the computer as a control unit for a random-access, projection device to provide a flexible teaching machine for research on branching modes of programmed instruction. J.C.R. Licklider and John Swets at Bolt Beranek and Newman were looking at a variety of uses, including the construction of graphs in response to requests made by students in analytic geometry.

A second project at Watson Research Center grew out of William Uttal's work on teaching machines which required more logical capability than was conveniently achieved with special circuits. A project initiated by Donald Bitzer and Daniel Alpert at the University of Illinois at about the same time gave particular attention to the design of convenient learning stations for the student and the curriculum author. A conference sponsored by System Development Corp. and the Office of Naval Research in October of 1961 included a good sampling of work on computer-aided instruction and related fields. The proceedings of that confer-





ence<sup>1</sup> still constitute a standard reference on instructional applications of computers. Perhaps five major projects were reported at that time, and I counted 11 different curriculum packages although more than half of them were short demonstration units.

The number of distinguishable projects and samples of instructional materials probably doubled by 1963. Curriculum packages designed at System Development Corp. and Watson Research Center had been used with rather large numbers of students. A survey I conducted in 1965 showed that the number of projects and materials had doubled again. Many of the curriculum programs were quite substantial and one of them had already been used for regular credit instruction at the Univ. of Illinois.

The problems and potentials of this young technology were discussed at three significant conferences in the fall of 1965. The proceedings of those sessions are readily obtained<sup>2</sup> and together make up a useful collection of examples, opinion and projections. For a current list of sources the reader should see my guide to literature in the area of instructional uses of computers recently distributed by the Educational Media and Technology Clearinghouse at Stanford, California 94305.

Special sessions on computers in education have been presented at recent meetings of IEEE, ACM, and the Fall and Spring Joint Computer Conferences. Patrick Suppes, perhaps the best known figure in the field of computer-assisted instruction, was one of 12 speakers from the U.S. invited to speak at the IFIP Congress in August, and two sessions were devoted to programming languages and systems for use in education.

Another indication of attention being given to this new technology is the number of manufacturers and publishers entering the area, and the increase in dollars being invested. Special-purpose, computer-aided instruction systems have been officially announced by IBM, RCA, Philco-Ford and Technomics. Activity is apparent within Westinghouse, Honeywell, Univac, GE, CDC and Burroughs. Sizeable field studies have been initiated in the public schools in Philadelphia, New York City, and Waterford, Mich., as well as those schools working with Stanford Univ. Use of interactive computer systems to teach computer programming and mathematics is already widespread; two notable ones involve public schools in the vicinity of Boston (Project LOCAL) and both public and private schools near Dartmouth College.

A few conferences and review studies currently scheduled are worth noting here. The College Entrance Examination Board and the Social Science Research Council are sponsoring an invitational conference at the Univ. of Texas in October; the papers and critiques prepared especially for that meeting will be distributed widely next year. The Interuniversity Communications Council (Educom) has a working group looking at programming languages, documentation, and validation problems in instructional applications of computers. The Office of Education has established a pilot project of considerable scope and based on feasibility studies conducted by IBM and General Learning Corp.

### status of the new technology

Many different kinds of computer and software systems are being used by research and development projects today. Some small machines have been programmed for use by one

student at a time executing stored programs, simulations, or designing his own computation routines or computer-based games and test exercises for other students. A Digital Equipment Corp. PDP-7 has been used by Harlan Lane and others at the Univ. of Michigan for training and research on language skills. Systems that are somewhat larger but in a similar way dedicated to interactive instruction have been programmed for simultaneous use by from four to 40 students. Larger systems have been designed which can handle up to 200 students using the same or similar application programs. Of course, up to now it has been difficult to find 200 students who want to use similar programs at the same time and place, and whose administrators wish to pay the price.

Other research and development projects have used general-purpose conversational systems, imbedding the instructional applications among other software packages available to users. Under these conditions, the student may use the same computer for controlled instruction sequences, self-testing, simulation, gaming, and problem-solving. Systems at SDC, MIT and Dartmouth are examples of this general-purpose approach, although the designers of these systems probably did not consider their work to be related to computer-assisted instruction.

Programming languages and systems show even more diversity than seen in hardware. Nearly 30 languages and dialects have been developed specifically for programming conversational instruction but I believe that many of their differences are superficial and some obvious needs of users still have not been satisfied. There is good reason for different languages; at least five different kinds of users have distinguishable requirements: instructors, authors, instructional researchers, administrators, and computer programmers working with any of the first four types. The characteristics of different subject areas also suggest different language features. However, the existing languages do not arrange themselves neatly by user or application.

A working group on programming languages and technical assistance for authors in computer-based, educational systems was established by Educom to assess how well the needs of various users were being met, and to consider common practices in languages and documentation. The group has drafted a set of documents which I discussed at an ACM paper session in August; the work may receive another review at the FJCC in December.

The costs of using these various operational or experimental systems and languages vary considerably. Figures reported by manufacturers or research projects range from \$2 to \$15 per hour. Some of the differences can be attrib-



*Dr. Zinn is assistant professor of psychology at the Univ. of Michigan's Center for Research on Learning and Teaching. He is affiliated with Educom and has served as a consultant for many organizations concerned with CAI, including the Univ. of Illinois, IBM, SDC, Bolt Beranek & Newman, General Learning Corp., and European organizations. He has a doctorate from the Univ. of Michigan in education and psychology.*

<sup>1</sup> Coulson John E. (Ed.) *Programmed Learning and Computer-based Instruction*, New York: Wiley, 1962.

<sup>2</sup> Bushnell, Don D. and Dwight W. Allen. *The Computer in American Education*; New York: Wiley, 1967.

Gerard, R. W. *Computers and Education*; New York: McGraw-Hill, 1967  
Commission on College Physics; *The Computer in Physics Instruction*, The Commission, Univ. of Maryland, College Park, 1966.

## INSTRUCTIONAL USES OF ICS . . .

uted to variations in assumptions about how many effective student hours can be scheduled in a month or a year, whether the equipment is rented, leased or purchased, and how much time will be spent in utility jobs, preventive maintenance, or repair. One research project claims to be able to achieve a figure of 20¢ per student hour at consoles including keyboard, graphic display and image projector. The project plans to be operating a few thousand such consoles over telephone lines by the end of 1972.

Whatever one believes the hardware and communication cost to be, the initial hurdle is investment in curriculum design and validation: from \$200,000 to \$2,000,000 to produce 100 hours of adjunct material for a one-year course. A complete cost analysis must also consider the space, proctors on duty, reorganization of other curriculum or school functions, etc. Useful papers on CAI economics have been published recently by Kopstein and Seidel (*Audio-Visual Communications Review*, Summer, 1968) and Randall and Blaschke (*Educational Technology*, June 30, 1968).

Instructional materials have been written in almost all subject areas and for many age levels: preschool reading, elementary school science laboratory, intermediate school social studies games, high school biology laboratory, college mathematics, German, chemistry laboratory, and professional-school exercises in business management, medical diagnosis, architectural planning, etc. Some of the samples probably make little use of the computer and would be as effective and less expensive in another mode, e.g., a book or film cartridge.

### factors affecting the value of cai

The value of computer assistance for self-instruction depends on many factors, among them the organization of the subject matter, the purposes of the author, the natural mode for presentation of the subject, and the personality of the student. I have made some guesses about what is likely to be important when typical self-study material in text format is adapted for computer presentation. First, the machine evaluates a response constructed by the student against the author's standard, points out discrepancies, and assures accurate scoring or selection of remedial or enrichment material. Second, the machine can conceal and to some extent control the teaching material so that the author can specify greater complexity and assume more accuracy than is possible when the student is expected to find his place in the pages of a large booklet. Third, the computer can carry out operations specified by the student in simple programming languages or design systems. Fourth, the author or researcher obtains detailed data on student performance and perhaps attitude, and convenient summarization ready for interpretation. Fifth, the author is able to modify his text and prepare alternative versions with relative ease.

Uses of computers will be determined by judgments of appropriateness by subject experts, effectiveness observed from records of student performance, and costs which must be met by administrators of schools or training programs. Favorable economics for regular use of automated self-instruction may depend on computer aids for preparation and revision of material, self-modifying strategies of instruction, and automatic assembly of additional teaching samples or testing situations. Some of the limitations involve the cost and unreliability of processing lengthy verbal constructions, sensing complex physical constructions, and interpreting bodily gestures or vocal intonation. One of the most difficult problems to overcome, however, is lack of organization of the subject matter. Somehow human teachers manage to be reasonably successful in spite of undefined objectives and

unorganized material; computers (and educational technology in general) require much greater specificity in directions for instruction prepared by curriculum experts.

I should not have to say to the readers of this journal that machines and automated self-instruction are part of a larger system which includes human teachers. Interactive instruction systems will become increasingly important because of the impossibility of giving students adequate supervision during learning exercises, the desirability of encouraging students to practice independent searching and self-teaching, and the apparent need to monitor and assist the students when they are given difficult or ill-defined tasks. Computer assistance will be used as a tool by curriculum planners, lesson designers, and teachers as well as students to more effectively achieve common educational objectives. The next section describes typical uses in four or five major areas.

### examples of current uses

In a chapter for the *Review of Educational Research* last year I discussed seven or eight modes or uses of computers in instruction with comprehensive listings of references. In these pages I would like to give examples of three major kinds of uses for students and go on to describe computer aids for an instructor, curriculum author, or researcher. Applications for students appear to vary along a dimension of author or program control. At one extreme, the student can do only what the program allows; typically he finds himself more restricted than he is with a textbook or set of dittoed exercises. For applications in a second category the lesson designer has programmed the computer to respond in set ways but leave the initiative to the student, who is encouraged to explore the materials or model by whatever means he finds most efficient or interesting. The third category of uses is characterized by almost complete control given to the student; the computer is programmed to serve him as a tool in the management of information necessary for solving problems. These three are followed by two more classes of uses which instead involve instructors, subject experts and instructional researchers.

### drill, tutorial, and dialogue

These three kinds of computer assistance are most often given the label "CAI." Many student hours at a terminal have been logged with drill exercises because it is easy to assemble large amounts of material, assign it to large numbers of students, and service many simultaneous users on a relatively small machine. However, if economic criteria are important, the users must consider alternate ways of achieving the objectives which can be met by computer-delivered drill exercises. The best known examples of drill in regular instruction must be the elementary school curriculum for mathematics and language skills developed by Patrick Suppes and Richard Atkinson and tested in the Palo Alto schools. These and other materials have been introduced into 15 elementary schools in New York City. Another project which has accumulated many hours of student experience involves language laboratory exercises at the State Univ. of New York at Stonybrook. Recently at Stanford, a course in Russian has been developed which combines computer-delivered practice with other language laboratory exercises and individual meetings with the instructor.

At The Univ. of Michigan a student console was especially designed for use with a small computer for training prosodic characteristics of speech. The aural response from the student is compared with the recorded model just played for the student; the extent and direction of discrepancy in pitch, loudness, or tempo are displayed immediately on a zero-center meter. Progression through the exercises is determined by individual performance of each student. The computer is used to average the signals in order to cancel

out the differences in base pitch or loudness (e.g., a female student responding to a male, native-language speaker), to adjust the tolerance for error in response to student performance, and to convert the audio parameters from physical units to the logarithmic, psychological units more meaningful to the learner.

Many hours of CAI have been generated for tutorial mode probably because it is familiar and comfortable for a college professor interested in educational technology. Much of the work done at Penn State, Florida State, and other university-based projects can be characterized as individualized, tutorial adaptations of lecture or textbook material. Many dollars have been invested in development of a few computerized, programmed-instruction courses; a significant part must be spent for implementation on a particular computer system. The benefits unique to computer presentation and control have not yet been demonstrated. Some advantage is anticipated because the author is able to write instructions for processing constructed responses, branching according to complex strategies, and controlling and concealing material as appropriate for each individual student. However, few lesson designers have made use of capabilities beyond those which can be accomplished with the printed format. Although the computer may have played a significant role in improvement of instruction by seducing the author into more careful organization, testing, and revision of material, in the end his self-instruction package may be presented to students almost as effectively (and with considerably less time and cost) in booklets and audio-visual modules.

Some instructional programs of the tutorial variety are designed to encourage additional initiative on the part of the student, and to provide a relevant reply whatever he may do. Typically, the author of such an exercise has provided in the computer program a set of conditional statements which, for any stage of discussion, make the computer reply dependent not only on the student's current inquiry or assertion, but also on the history of the conversation. A medical diagnosis exercise developed by Feurzeig and others at BBN is characterized by stages of examination and laboratory tests alternated with "discussion" of a tentative diagnosis with an automated mentor. The computer program keeps the student on the right track, and responds to his diagnosis attempts in light of information he has already acquired. Problem solving exercises in physics have been programmed by Edwin Taylor and others at MIT to provide information at the request of the student and eventually to check his description of a solution. The impression of a personal conversation is furthered by the fact that the computer extracts key words and phrases from the student input for use in the reply assembled by the author's program. The language used is an extension of Joseph Weizenbaum's Eliza. A particular advantage of this technique is that the program can be written to confirm each time what was "understood" by the collection of words recognized in the student's message.

### **simulation and gaming**

Applications in this category differ from the previous group in that the conversation between student and program, and the results the student obtains in playing the game or exploring the simulation, did not have to be programmed in detail by the designer of the learning exercise. In other words, the computer program underlying the game or simulation is a model designed to provide some appropriate reply whatever the student may type as input for the model. Such programs can serve a variety of purposes: examination of decision-making skills of a student during training, practice for a professional on problem situations which may not be encountered often enough to maintain essential skills, and theoretical tests of new hypotheses in

abstract situations which, although artificial, may be readily manipulated.

Simulation for military and industrial training usually attempts to achieve maximum fidelity in order to, as much as possible, replace experience in a real plane, space capsule, or business management situation. However, it is sometimes desirable to give students experience in abstract situations which emphasize first one concept or relationship and then another, with little concern for realism. Learning may be more efficient and effective where the content and complexity of a succession of exercises is carefully planned. Computer-based games may place the student in an even more abstract and less realistic situation. Typically a game provides specific payoffs and introduces competition with other students. Applications of both gaming and simulation are found in elementary school social studies, high school career planning, college chemistry and graduate business training. A sample of a student exploring a simple concept in wildlife management is given in the box.

### **aids for information handling**

On-line tools for the organization and retrieval of information should be as useful to the student as they are to any scholar working with a broad base of information. A number of experimental systems show considerable promise but are still rather expensive. Procedures have been proposed, and some of them demonstrated by Ralph Grubb, for student organization and use of large, non-linear files of text which serve as individualized reference and instruction systems. The student can be given tools with which to reorganize and augment his personal copy of the basic file. I believe that in this mode students could accomplish more scholarly work of greater quality during a given period of study, and acquire more skill in searching for and organizing information, than through discontinuous encounters with structured and strictly controlled tutorial instruction interspersed with periods of independent study. I am intrigued by development of curriculum files for this mode because the role of the subject expert is shifted from the detailed writing of a step-by-step introduction for a topic, to the assembly of an appropriate data base for student exploration, and to consultation on the development of powerful aids for exploration and scholarly work within those files of information. What I have in mind can be illustrated by an experimental, text-handling system developed by Douglas Englebart and others at Stanford Research Institute. Although Englebart's system has not been used specifically for instruction, exploratory projects are in progress elsewhere which may soon have interesting results to report concerning his techniques of "augmentation of human intellect applied in education."

Computation mode tends to be overlooked by the planner of the computer-based, instructional system, perhaps because it is such an obvious application, or because it does not look like tutorial instruction. Notable experiments are being conducted in the Massachusetts Public Schools in association with Wallace Feurzeig at BBN which include manipulation of symbols and words as well as numbers. Initially the students used remote computer services via Teletype and phone lines; a new project will put small computers in five public schools for multiple use by students at four or five terminals.

College students and professional staff studying statistics on the System Development Corp, time-sharing system are able to evaluate one-line expressions, to write and execute simple computation routines, and to call on existing statistical packages. As the student moves from simple to complex problems, more powerful computational aids are placed at his disposal. A computation and graphic display system developed by Glenn Culler and B. E. Fried has been used by

**INSTRUCTIONAL USES  
OF ICS . . .**

mathematics and science students at the Univ. of California campuses at Santa Barbara, Los Angeles, and at Harvard Univ. A system described in the *Communications of the ACM* in June (Engvold and Hughes), especially designed for training programmers, incorporates a tutorial mode, a program editor, compilers, and an execution executive into one system. Computers are being used increasingly by artists and scholars to design or conduct research on musical compositions, creative writings, experimental films, and architectural designs. I believe it is important that students

from these areas outside science and engineering be given access to computing capability through well designed study carrels and readily comprehended programming languages.

**aids for instructional management**

It appears that public schools will be able to afford interactive computer assistance for a few instructors and administrators before they can reach each individual student directly. Aiding management of instruction is an appropriate beginning; knowledge gained through semi-automated handling of instructional materials and performance records will contribute to effective implementation of other interactive uses of computers by students directly.

The Oakleaf School project in Pittsburgh began with

**student tries to manage one aspect of a simulated salmon-fishing operation**

*The object of the game is to build up and maintain a population which will maximize the catch taken by the fishery. The size of the run for the coming year is determined by the computer in some way not known to the student, although he does know it depends on the previous year's escapement.*

Conversation  
(Computer in capitals; player lower case.)

Commentary

WHICH MANAGEMENT STRATEGY DO YOU WANT TO ADOPT?

The player has the choice of setting either escapement or catch.

catch

CATCH FOR 1967?

16,000

ESCAPEMENT = 2,000

CATCH FOR 1968?

10,000

The computer supplies the size of the escapement, and asks about the next year.

ESCAPEMENT = 1,000

CATCH FOR 1969

5,000

ESCAPEMENT = 1,000

THE MEN AT THE FISHERY ARE DISTURBED ABOUT THE LOW CATCH.

CATCH FOR 1970?

10,000

The student notes that when 2,000 escape (1967, above), the next year's run is 11,000 (catch of 10,000 plus 1,000 escaping).

NO FISH ESCAPED. LET'S START OVER AGAIN

WHICH MANAGEMENT STRATEGY DO YOU WANT TO ADOPT?

escapement

ESCAPEMENT FOR 1967?

15,000

CATCH = 3,000

THE MEN AT THE FISHERY ARE FURIOUS ABOUT THE LOW CATCH.

The student should have kept the catch down until the population had recovered.

ESCAPEMENT FOR 1968?

15,000

CATCH = 11,000

ESCAPEMENT FOR 1969?

10,000

CATCH = 15,000

ESCAPEMENT FOR 1970?

9,000

The student holds firm because he expects a much bigger run the next year.

CATCH = 21,000

ESCAPEMENT FOR 1971?

9,000

The student graphs the data so far, infers a relationship between escapement and the run the following year, and is ready to switch to a subprogram which will "discuss" with him the optimal strategy.

CATCH = 19,000

YOUR TOTAL CATCH FOR THE LAST FIVE YEARS HAS BEEN 68,000

SALMON — 13,600 PER YEAR.

DO YOU WISH TO DISCUSS THE OPTIMUM STRATEGY NOW?

much teacher-student contact and a large clerical staff grading tests, checking resource tables and arranging lesson materials. Gradually the clerical burden has been replaced by computer programs, and some of the more routine contact with students is being taken over by conversational interaction with computer programs.

### **tools for author and researcher**

Programming languages are needed which are convenient for specifying interactive instruction. The Educom working group mentioned earlier is assembling a set of documents intended to describe various programming languages and to recommend additional requirements which are not presently satisfied. Five or six documents are in preparation; one of the more interesting compares different languages by the code required to accomplish a certain learning exercise.

A preliminary and tentative report of the Educom study which I presented at the IFIP Congress in August recommends increased facility for: expressing complex, conditional procedures; processing quantities of algebraic expressions typed by the student; assembling instructional material from elements of the subject matter and relationships among the elements defined by the subject expert; interactive editing and arranging of materials; automatic summarization and selection of performance data; and integration of automated instruction with computer tools for learning. A final report of the study should be available from Educom in Boston next year.

Some of the present experimental systems provide capability for interactive composition and revision of materials. Programs have been written by Leonard Uhr and others which generate the first draft of a computer-based learning exercise from a specially written text, a set of test papers, which have been graded, or a description of objectives for student performance at the end of the exercise. Existing examples appear trivial; it is difficult to handle sophisticated learning situations now, but generation of materials is one of the trends discussed in the next section.

### **trends and new directions**

A current trend in instructional use of computers appears to be away from the programming of sequences to be delivered by the computer under strict control of the author's sequencing rules. Putting a programmed booklet into a computer may be more a hindrance than a help to a motivated student who possesses reasonable study skills. It appears to me to be more likely that managers of future systems will make the primary sources of knowledge directly available to students through organized files of information and procedures. For this mode of study students will be given the necessary learning tools for information management, computation, and composition. Computers and electronic technology will be used much more widely in the future world of today's students, and the tasks they will be given will require greater skill of information acquisition and decision making than is expected presently. To me this suggests that today we should begin to give students more control over the data bases and tools for learning and productive work.

For certain students and some instructional objectives the effectiveness of a computerized, author-controlled presentation will be sufficiently greater than experience with the same content in textbooks or audiovisual materials to justify the greater cost per unit of instruction. For example, most children lack the verbal skills, discriminations, and attention span that may be needed for independent study without the aid of a computer; students of written and spoken languages in any age group may for similar reasons need computer assistance for diagnostic self-testing of skills.

Expensive, on-line systems will continue to be used for research on learning and teaching and for development of self-instructional programs. Computers and communications are especially important because the training devices can be located in public school classrooms, business offices, and engineering shops or laboratories, through which an information processing system can instruct, answer questions, deliver tests of understanding, record data, and test hypotheses regarding instruction and learning with great detail and over long periods of time. I believe that this capability to introduce experimental control into situations satisfying the real demands of education and training will reduce the present discrepancies between contrived laboratory situations and actual applications of learning principles in training and education.

Research on natural language processing, information structures, and computer aids for human intellect, eventually will produce tools to augment considerably the resources available to authors of computer-based exercises. However I am unable to anticipate the details of such facilities for educational systems, and I do not see how the instructional programmer would write directions for generalized language processing or definition of information structures if today's tools were put at his disposal.

Special-purpose computer programs can be written to assemble instruction materials from elements of a subject and relationships among these elements. A programmer can describe an entire class of problems with one set of statements by which an indefinite number of test or instruction items are generated for presentation to each student as they are needed. For some learning exercises, the writing of a rule which generates sufficient variety will be rather difficult; if the number of examples needed is fairly small, the author will save time by writing out each variation he needs to have available. However, even when the technique does not save time in initial drafting, it will reduce the probability of oversight or error by the author composing the problem set. Furthermore, generative rules are likely to provide more possibilities for individual adaptation than a predetermined sequence of branches through a large pool of specific items.

I expect communication networks to play an important role in permitting the preparation and use of computer-based exercises within existing economic constraints. Expensive, instructional software on computers is not now used with large numbers of students. However, I anticipate that suitable networks will stimulate and assist groups of subject experts who work together on computer-based materials for the same course at different schools. I have argued elsewhere that materials developed on a cooperative basis will be more usable at different institutions than if they were developed independently. Furthermore, guidelines for organization and documentation of computer-based exercises will make adaptation and use at another school easier, especially since the text can be searched and edited readily while producing new copy for local students.

Networks of regional computer services will distribute information processing capability which individual institutions or community education programs could not afford independently. The National Science Foundation has funded experiments having central resources based at Dartmouth, Cornell, and Oregon State. The Educational Information Network project of Educom is establishing directory services and common practices which will facilitate such regional exchange. A group of contractors of the Advanced Research Projects Agency (ARPA) is now forming a network especially for experimentation in exchange of data, programs, and interactive use of computers. Ideally, the resources of entire regions will be made available to enrich and individualize the educational program of each student, no matter what his geographical location. ■



# CURRENT PROBLEMS IN CAI

by JAMES L. ROGERS

Even the reader who only casually keeps up with developments in the data processing field, or in education and training, is aware that computers are being used in elementary and secondary schools, higher education, business, industry, and government agencies to assist in the process of instruction. There are many different points of view from which these activities can be described—one could list the existing installations, or discuss the different applications, or describe the various hardware systems or languages being used, and so forth.

The aim of this article is to consider the progress in CAI to date, identifying some of the difficulties that have been encountered, and suggesting changes needed if matters are to improve. Accordingly, we will describe CAI developments under the following headings:

1. Ways in which computers are used to assist instruction—a list and brief description of six different kinds of computer applications in instruction;
2. Issues and problems—a discussion of some results of implementing CAI;
3. Suggestions for future developments—a discussion of efforts which are needed to help resolve some of the current issues and problems.

## ways computers assist instruction

In this article, we will limit our discussion to those applications in which the computer output produces some readily identifiable effect upon the instructional interaction. Six dif-

ferent categories of such applications are often included in discussions of CAI, and these are shown in Table 1.

In the last category—Interactive Instruction—the computer is used as one agent in the instructional interaction itself, and its effect is direct and immediate. In other categories, the effect of the computer's output may take place through an intermediary, or may be delayed in time. For example, where the learner has access to a computer which he uses as a computational aid, the most readily identifiable effect upon the instructional process may be that the teacher can assign work in areas which simply could not be covered otherwise.

By considering only those cases in which the computer affects the instructional process, we will ignore the many computer applications in education and training which affect other processes. For example, we will not consider the uses of computers to assist school administration (such as class scheduling, staff payroll, test grading, or materials inventory), guidance and placement (such as matching job requirements to student characteristics), nor research (such as item analysis for the purpose of test validation).

The purpose of presenting these categories of CAI applications is not to define CAI, but simply to direct attention to those characteristics of CAI which are most fruitful for the discussion which follows.

Of the many issues and problems—foreseen and not—which have resulted from the different attempts to implement CAI in educational, commercial, and governmental environments, I want to discuss three, chosen because their

resolution is necessary if CAI is to evolve into a useful tool.

### gaps in the instructional process

Perhaps the most widely known applications of computers in education are those which use the drill-and-review materials developed over the last few years at Stanford Univ. At last count, the system, feeding a PDP-1/PDP-8 combination at the Stanford Univ. Computation Center, included approximately 83 Teletype terminals located in elementary schools in California, Mississippi, and Kentucky. A similar system of 192 terminals, connected to an RCA Spectra 70, is being installed in 16 elementary schools in New York City. These installations deserve careful examination because they involve large numbers of students in widely separated parts of the country, and represent an enormous investment of public research funds. Furthermore, RCA's very active marketing of the drill-and-review approach may pressure other manufacturers into announcing competitive systems.

The problem which such applications raises can best be appreciated by describing how the system is supposed to work. During each meeting of a 7th grade algebra class, for example, each student leaves the classroom in order to spend approximately 5 to 10 minutes at a Teletype terminal. When the student signs on, the computer presents him with approximately 20 drill-and-review questions appropriate to that day's lesson. The exercises are arranged into five tracks according to "level of difficulty," and the computer selects the track from which this student's exercise is taken based upon his performance on the previous exercise. The computer then prepares a daily performance summary for the teacher of each class.

The most important problem raised by this approach is the lack of any direct interaction between the system and those classroom practices which result in learning. In effect, the computer is being used to test the students, and to prepare test performance statistics for the teacher, and that is all. The teacher is given the responsibility both of interpreting the test data, and of altering his classroom practices to compensate for whatever instructional deficiencies are revealed by the test data.

What happens when the computer dumps all the performance data on the teachers? Perhaps we can infer from Suppes' remark "... there are so many questions about performance that can be asked and that the computer can answer that teachers, administrators and supervisors are in danger of being swamped by more summary information than they can possibly digest." If the teachers cannot possibly digest the information, one wonders how they can use the information to advantage in the classroom.

One researcher on the Stanford project remarked "The only reason the teachers like the system is because it takes attendance for them." But in all fairness, it should be realized that unless the teacher has been specifically trained to do so, he will not know where to start in using the data to improve his classroom practices. Under the circumstances, the teacher may be very well justified in feeling that the computer's only tangible contribution to events in the classroom is the taking of attendance.

The current drill-and-review applications, then, point up the difficulties encountered when a computer system is installed to do part of the job, and the responsibility to do the rest of the job is left up to teachers who are less than adequately prepared to apply the computer's results to their everyday classroom practices. It would be difficult to find a clearer example of the problem Skinner refers to when he describes efforts which concentrate upon "... measuring the results of teaching while neglecting teaching itself."<sup>2</sup>

### limitations imposed by systems

The characteristics of any CAI system can impose severe limitations upon both the kinds of materials which can be presented to the learner, and the kinds of responses the learner can be required to make. In choosing one CAI system from among those available, and in deciding whether or not to use a given CAI system for a particular instruction task, it is important for the potential user to ask: "What limitations does this system impose upon the material I need to present, and upon the responses I must elicit?" (Again, because our main concern in this article is the instructional interaction, we will not describe the limitations which a CAI system may impose upon other aspects of education or training. CAI system characteristics cannot help but affect the administration of instruction: for example, the system's storage capacity limits the amount of instructional material that can be handled at any one time; the terminals may have to be located within a given number of feet of the central processor, requiring that learners from outlying schools in the district, or offices in the company, would have to be transported to use the system.) Unfortunately, there are few generalizations which are useful in answering this question. It is not useful, for example, to describe the suitability of a CAI system in terms of subject areas, because the limitations imposed by any system affect the teaching interaction at the stimulus-response level, and therefore cut across subject areas. To make matters worse, there are no characteristics common to CAI hardware, nor to CAI software, nor to the kinds of teaching materials used with CAI systems, which can support generalizations about CAI systems with respect to proposed applications.

While a mismatch between system limitations and use requirements cannot be avoided by trusting to generalities, it can be avoided by an analysis which includes a description of the input-output capabilities of the system, and a description of the instructional objectives in terms of the stimuli and responses required.

To show what might be involved in such an analysis, let us consider some representative examples of the kinds of materials we may wish to display to the learner, and of the kinds of responses we may want the learner to make.

1. *Kinds of material to be displayed to the learner.*
  - a. Text: in teaching foreign languages, we may wish to display text including special alphabetic characters; in teaching mathematics, chemistry, and logic, we require special symbols, signs, subscripts, etc., for displaying equations, formulas and expressions.
  - b. Audio: we may want to play back recordings of spoken messages in teaching communication skills,



Mr. Rogers is senior scientist, Xerox Education Division, responsible for the information systems aspects of operations planning. He was Los Angeles district manager for Basic Systems, Inc., at the time of its acquisition by Xerox and was previously with the Burroughs Corp. He has an MA in philosophy from the Univ. of Michigan.

<sup>1</sup> Suppes, P. "The Uses of Computers in Education," *Scientific American*, 215, 3 (Sept., 1966) p. 217.

<sup>2</sup> Skinner, B. F. *The Technology of Teaching*, Appleton-Century-Crofts, New York, 1968. p. 94.

**CURRENT PROBLEMS . . .**

languages or basal reading; and recordings of instruments in teaching music appreciation.

- c. Graphics: we may wish to display maps in teaching history; motion pictures in engineering or science; still photographs in medicine or art; circuit diagrams in electricity; graphs in mathematics or statistics; engineering drawings in blueprint reading; cardiograms in medical diagnosis; and so forth.

At the present time, no operating CAI system (known to this author) is capable of presenting all of the above materials to a learner. Most CAI systems use a typewriter as their interface with the learner, and are not designed to handle *any* of the teaching materials mentioned above. Strum and Ward describe the problems they encountered

- a. State the expression for the area under the curve.
- b. Translate the above sentence into Russian.
- c. Fill in the missing parts of the following table.
- d. Point to the antibodies in the microphotograph.
- e. Outline the temperate zone on the map.
- f. Complete the circuit diagram.
- g. Describe a relationship.
- h. Define a concept.
- i. Explain how something works.
- j. Summarize the speaker's remarks orally.

There are two major sources of difficulty in using a CAI system to teach anything: the system may not have the *hardware* capability to allow the student to make the response, and it may not provide a *language* in which the instructor can specify how to analyze and evaluate the student's response.

Item (a) in the above list requires a keyboard equipped with special mathematical symbols. Item (b) requires a key-

APPLICATION CATEGORY	INPUTS TO THE SYSTEM	SYSTEM FUNCTIONS	SYSTEM OUTPUT
COMPUTATIONAL AID	Values of variables Data from observations	Solves the formula Carries out the analysis	Solutions to the problem (results of the calculation, statistical analysis, etc.)
SIMULATION	Responses to instruction or data in the learning environment (decisions in games, procedures for operating on-line terminals, test cases in laboratories, maneuvers in aircraft, spacecraft, or naval vessel crew training, etc.)	Uses learner inputs to solve a mathematical model of the process (physical, social, organizational, economic, etc.) being simulated	Outcomes of the learner's decisions, sometimes expressed as changes in the computer-controlled parts of the learner's environment.
LESSON MATERIAL STORAGE AND RETRIEVAL	Information which identifies the learner's area of interest (subject, period, area, etc.) or the learner's progress in a particular course of instruction.	Matches identifiers with those of stored lesson or supplementary material.	Lesson (or supplementary) material requested by the learner (language exercises, classroom or homework assignments, etc.)
LESSON PRESCRIPTION	Learner's performance on test administered following last assignment (may be entered by teacher, teacher's aide, etc.)	Matches learner's performance on last test with characteristics of alternative instructional units for next topic.	Assignment of next instructional unit for use in classroom or laboratory, or for homework, outside reading, etc.
TESTING	Answers to drill and review problems	Grades learner's answers (right or wrong); adjusts difficulty level of next problem set; collects data on all students by problem set.	To learner—right or wrong on each problems; % for set. To teacher—summaries of learner performance
INTERACTIVE INSTRUCTION	Responses to questions asked by the system	Analyzes learner's response, and selects next item to be presented to learner.	To learner—for correct answers, indication of correctness, plus next item; for incorrect answers, some dialogue exploring the correct answer. To course designers—error data by item

Table 1. Features of Some CAI Applications

in using typewriter terminals.<sup>3</sup> The difficulties are even greater, of course, if one wishes to prepare hard copy of any of these materials for use and retention by the learner. The ability to present to the learner each different kind of material usually requires a different kind of presentation device, together with instructions in the computer language to operate the device—in other words, each different kind of display capability may involve its own peculiar hardware and software problems.

2. *Kinds of responses to be required of the learner.* The terminal behavior specifications (i.e., the teaching objectives of the course, stated in terms of observable changes in the learner's behavior) for courses in various subjects might include the following items:

board with a complete Cyrillic alphabet. Item (c) can be handled easily on a system which includes crt display, but a system which provides only a typewriter interface requires that the learner reverse line feed until he positions the proper line of typing with the print element. Items (d), (e), and (f) each require special equipment, some of which is now in the prototype stage of development.

Items (g), (h), and (i) pose difficulties of another sort. Using even the simplest available alphabetic keyboard, the student can easily type in his description, definition, explanation, or whatever the question requires him to enter. The

<sup>3</sup> Strum, R. D., and Ward, J. R. "Some Comments on Computer-Assisted Instruction in Engineering Education," *IEEE Transactions on Education*, E-10, 1 (March, 1967) pp. 1-3.



problem is that there are no methods for deciding the semantic equivalence of what Spolsky<sup>4</sup> modestly describes as "... a very large number ..." of sentences. As a result, we cannot, at present, tell the computer how to process a learner's input to decide whether or not his response *means the same* as the model answer we have stored for that response. Instead, we force the learner to respond within the constraints of an artificial language, thus allowing no ambiguity. Or, we allow natural language responses, but we restrict the length of the response to that which rules out the most probable sources of ambiguity. At best, we rely upon features of the response other than its meaning (the presence of specified key words, the order in which they appear, etc.) to determine its match to our "answer" (right or wrong). In all such cases, we allow the tail to wag the dog: it is the specification of the learner's terminal behavior which should determine the characteristics of the response, not our inability to handle problems of meaning, and whenever we modify the requirements for the response in a way that settles for something less than the terminal behavior specification, to that extent we degrade the quality of the instruction.

In everyday practice, this problem is aggravated by the fact that some of the CAI languages which the instructor must use to specify his requirements for acceptable responses do not allow even the primitive level of analysis represented by such procedures as scanning for key words, editing out punctuation, allowing certain flexibility in spelling, etc.

Item (j) presents both hardware and software problems. We do not yet know how to translate spoken words into written words, that is, we cannot speak into one end of a device, and have the text of our spoken words print out at the other end. So we lack this kind of student interface in available CAI systems. But even if such a device were available, we would be just as far from being able to analyze its output as we are from analyzing any other free-form response. Recognition of the meaning of speech therefore involves both a hardware problem which is unique and a software problem which it shares with other kinds of responses.

One revealing question to ask is, "If available CAI systems impose such restrictions as these, how are they being applied to teaching applications?" In other words, how are researchers overcoming the inherent limitations of the CAI systems they are stuck with? Several approaches are being tried, and are worth considering:

- a. Add outside components to perform the functions which the CAI system cannot—for example, if your CAI system cannot present photographs to students, have the photographs reproduced in advance, packaged, and distributed to each student; then at least your course can direct the student's attention to the information, and ask questions based upon the "supplementary" material.
- b. Modify the system—for example, the Slavic linguistics department at Stanford has installed Teletypewriters with Cyrillic keyboards in their introductory Russian course.
- c. Modify your teaching objectives to fit within the capabilities of the system—for example, one of your course objectives may be to teach the student to list the characteristics of something (a chemical compound, a period of a nation's history, a style of poetry, etc.); if your CAI system language will not accept alphabetic inputs, then abandon your original course objective, and substitute another one which can be handled by your computational language—instead of teaching the student to *produce* the list of characteristics, produce each item for him, and ask him to enter numbers which indicate whether or not he *recognizes* that it belongs in the list (your course outline will look the same to anyone who is curious as to what you are teaching).

d. Conclude that CAI is not a fruitful approach, and continue to teach the way you used to.

None of these approaches is very satisfactory: Adding outside components may pose complicated distribution and inventory problems. Modifying the system can be expensive. Modifying one's teaching objectives to fit the hardware capabilities usually results in a deterioration of the good qualities of the instruction. Concluding that CAI is not a fruitful approach is foolish, unless you have investigated all existing systems, and unless you know that future technological developments will never change the situation.

### production of cai teaching materials

Since the earliest experiments with CAI systems, it has been recognized that a major obstacle to the successful application of CAI is the lack of quality course materials. As we will see later on, the shortage of qualified people to produce such materials is an important factor here. This lack is not a great problem for industry, business, or government. Each company or agency tends to develop much of its own instructional materials since course content usually concerns facts about products, services, policies, or procedures which are relevant only to a particular organization.

In contrast, the formal educational establishment tends to produce a smaller portion of the instructional materials it consumes, and relies instead for the bulk of its needs upon the textbook publishers, and upon the manufacturers of supplementary materials (audio-visual aids, kits, laboratory equipment, and so forth). As a result, the availability of CAI curriculum materials for use in formal education is a critical matter, and the means employed to meet this need will have far-reaching effects upon the quality of the instruction, and hence upon the acceptability of the concept of CAI itself. The discouraging example of the unimaginative use of educational television should stand as a warning that the availability of hardware with powerful functional characteristics is not enough to result in improvement of education. Today we face the very real danger that the challenge of applying CAI will be avoided, and that this opportunity for educational improvement will be lost. This danger will persist as long as CAI is regarded primarily as a means of extending traditional classroom practices, or as long as educators remain enchanted by visions of using a CAI system because it allows them to "orchestrate" the presentation of multi-media materials. Students do not learn simply because they know they'll be tested, nor because material is presented to them in four colors, nor because they are bombarded with multi-media presentations.

The computer is the most effective tool yet devised for arranging the stimulus-response-reinforcement contingencies which constitute the learning interaction. How CAI course material is designed will determine whether the potential of the computer will be wasted in simulating traditional practices. There is already some evidence of the bad results which can be expected when CAI users systematically disregard even the most general prescriptions of behavioral technology.<sup>5</sup>

From time to time, with emphasis depending on the source, it has been suggested that CAI course materials will be produced by computer manufacturers, school teachers, textbook publishers, and independent companies specializing in curriculum development for CAI. We will briefly examine each of these suggestions.

The suggestions that CAI system manufacturers would produce curriculum materials have died out, mainly because no computer manufacturer (with one exception to be dis-

<sup>4</sup> Spolsky, B. "Some Problems of Computer-Based Instruction," *Computers in Behavioral Science*, 11, 6 (Nov., 1966) pp. 487-496.

<sup>5</sup> Riedesel, C. A., and Suydam, M. N. "Computer-Assisted Instruction: Implications for Teacher Education," *The Arithmetic Teacher*, 14-1 (Jan., 1967) pp. 24-29.

cussed next) has the appropriate resources to attempt the time-consuming and expensive developmental and marketing efforts involved. The one manufacturer having a recognized and respected in-house curriculum development capability is IBM, which bought Science Research Associates, Inc., in 1964. When the IBM 1500 CAI System was announced two years later, the press release stated that course and supplementary materials in nine subject areas were being developed by SRA.<sup>6</sup> Since then, however, SRA has not published any CAI courses, and it is not now clear when, or if, such materials will be available as standard products to educators. In retrospect, then, it has turned out that computer manufacturers have not been an important supplier of curriculum materials.

An alternative suggestion—that teachers produce their own CAI materials—has enjoyed much greater favor. In fact, faced with the current lack of available programs, there is scarcely any other path open to the would-be CAI user. But there are difficulties in this approach which should be recognized.

First, the time required to produce CAI materials exceeds the time which teachers can reasonably be expected to spend. The accumulated experience in producing programmed instructional materials shows that approximately 100 hours of analysis, programming, and editing effort are required to produce material which occupies the student for one hour.

To this must be added the time required to put the instructional program into CAI form. Strum and Ward<sup>7</sup> summarize their experience as follows: "It has been estimated that the writing of a programmed book absorbs one to two orders of magnitude more effort than is required to write a conventional text on the same subject. The present authors estimate that *another* one or two orders of magnitude separate the computer program from the programmed text." Reynolds states that ". . . fairly careful records we have kept in course development in CAI at Texas Christian Univ. (and other sources as well) indicates a minimum of 300 man-hours per hour of instruction . . ."<sup>8</sup> But even if we assume a conservative 100-to-1 hour ratio, where is the average school teacher or college professor going to get the time to produce CAI material covering any significant portion of a course?

The second difficulty is that there are few people—teachers included—who possess the diverse skills required to prepare self-instructional materials. Such courses are usually produced by a team, combining the skills of:

1. Subject matter experts, who specify content and objectives;
2. Behavior analysts, who apply learning principles to specified knowledge and skills;
3. Programmers, who convert the behavioral analysis into appropriate instructional interactions; and
4. Program editors, who revise and refine the instructional sequences in the light of performance data.

In addition, test subjects, typists, draftsmen, and illustrators may be needed from time to time in the production process.

If we consider the teacher or professor developing material for use in a CAI system, we can probably assume that he will be his own subject matter expert. Furthermore, he probably can use his own students as test subjects. And he may be able to use keypunch operators at his institution's edp center instead of the typists we have listed. But even with these simplifying assumptions, the central problem remains: few people have the skills required to produce instructional material with predictable performance characteristics. Quality CAI material is not produced by simply using the computer to emulate classroom practice, yet many teachers

have little else to guide them when they begin trying to use CAI systems.

### the manufacturers' contribution

Ironically, the manufacturers of CAI systems have little help to offer. (One example of this deficiency occurred when the Philadelphia City Schools were installing a Philco-Ford 16-terminal CAI system, and had to hire an independent consultant to discuss with teachers the strategies of organizing course material for computer input.) All of the CAI system manuals I have seen assume that the user has already solved the problems of behavioral design and testing, that is, they begin at the point at which the user is ready to express his instructional sequences in a particular CAI language. Even SDC's *PLANIT*, which guides the program writer by reminding him of the choices available during his on-line program construction and entry, actually assumes that all of the important pedagogical decisions have been made before the program writer makes his entries.

The user's plight is not helped by the style of CAI systems manuals—all of those I have examined start off as if the reader were thoroughly familiar with edp concepts, terminology, and procedures. There is no evidence that the authors took into account the background that teachers, curriculum writers, training specialists, and others would bring to the task of using CAI systems.

In summary, then, the lack of available CAI course materials, together with the shortage of people with relevant production skills, have forced many teachers into preparing their own CAI materials. The difficulties they have faced in so doing include their own lack of the specialized skills required to produce self-instructional materials, the restraints on the amount of time they can devote to such work and the lack of any effective help from the CAI systems manufacturers.

A third source of CAI course materials is the textbook publishers. To review some of the developments in this area, we must go back to RCA's entry into the CAI field. At the opening of the RCA Instructional Systems offices in March of 1967, the president of Random House, Inc., (an RCA subsidiary) stated, in discussing the new venture, "Our specific assignment is the provision of the instructional materials themselves."<sup>9</sup> Subsequently, it was revealed that the L. W. Singer Division of Random House is adapting *Spelling-Diagnostic Paragraphs* for CAI. In May of 1967, RCA announced an agreement with Harcourt, Brace & World, Inc., under which the publisher would adapt its *Language and Daily Use* series in grades 4, 5 and 6 for use with RCA computer equipment. Later in 1967, Harper & Row also reached agreement with RCA to produce supplementary material for use with their widely used *Today's Basic Science* series.

### the publishers' activities

In a relatively short time, RCA has formed a network of alliances with major textbook publishers which may have far-reaching effects on CAI curriculum development. Such a move is potentially of great benefit to each of the partici-

<sup>6</sup> "Preliminary versions of course materials that educators may use with the new instructional system are being developed by Science Research Associates, Inc., an IBM subsidiary. Course materials are in algebra, computer science, German, and statistics. SRA is also developing supplementary materials that allow the student to use the system to solve problems and perform simulated experiments in the study of physics, chemistry, biology, general science and the social sciences." From IBM Processing Div. press release of March 31, 1966, p. 2.

<sup>7</sup> *Op. cit.*, p. 3.

<sup>8</sup> Reynolds, D. "CAI Within a Systems Approach to Instruction," paper presented to the convention of the Association for Educational Data Systems, May 3, 1968, Fort Worth, Texas; p. 14.

<sup>9</sup> Remarks by Robert Bernstein, President, Random House, Inc., RCA Instructional Systems Conference, March 13, 1967; p. 1.

pants. It enables the computer manufacturer to avoid the costly, unfamiliar job of curriculum development, and yet he can assure his potential customers that reputable publishers are busy producing learning materials for use with his system. The publisher also stands to gain: his textbook salesmen have a distinct marketing advantage when dealing with any school which uses (or intends to use) that manufacturer's CAI system. Such schools will be under heavy pressure to show tangible results from their adventures in CAI, and will find it difficult to turn away a textbook salesman who offers a ready-to-go package of computer-based material which supplements an established text series. If the school is already using that textbook series, the argument will be even stronger.

However, the publisher in such an alliance takes a risk to the extent that he invests in developing programs for a system which may not be well received, or which may become obsolete before he regains his investment. As more different CAI systems are introduced to the market, it will become decreasingly attractive for the publisher to develop materials for any one of them, and increasingly expensive for him to develop materials for all of them. These problems raise the whole issue of a CAI common language, and do so with an urgency which is unique in the development of computer applications. It would not be surprising to find textbook publishers in the vanguard of efforts to establish standards for a common CAI language.

While only secondarily aimed at curriculum material production, several related projects are underway at McGraw-Hill: collaboration with the Univ. of Texas CAI Laboratory in the development of remedial English materials for college freshmen; support of exploratory work at the Univ. of Pittsburgh Learning Research and Development Center relating to innovations in spelling teaching; and collaboration with a major urban school district in preparing curriculum packages in areas yet to be specified. The primary aim of these efforts is to help establish the appropriate roles of authors, editors, and consultants in the CAI production process, and to investigate different modes of a publisher's interaction with teachers, CAI programmers, researchers, etc.

The fourth and last possibility we shall consider is that CAI courses will become available from organizations formed for the specific purpose of producing such materials. The largest and apparently most successful of these companies is Computer Curriculum Corp. (formed by Suppes, Atkinson, and Wilson) which started operations in October, 1967. Their major curriculum contract is with Harcourt, Brace and World to produce drill-and-practice materials for use with Harcourt's *Language and Daily Use* text series, but generalized so that they can be used with other language arts texts. Computer Curriculum Corp. employs about 25 writers, editors, and computer programmers, organized into project teams.

It is far too soon to evaluate the impact of these CAI materials production houses. They face the same shortage of qualified people which their competitors do. They have several potential advantages going for them—for example, compared to the efforts of individual teachers, professors, or consultants, they can presumably apply to any given project a greater variety of the skills which are needed to assure the quality of self-instructional materials.

In summary, the CAI material houses are a development worth watching. Their activities are aimed at filling an obvious need, and their activities may have an important impact upon the application of CAI systems.

### suggestions for future developments

In the previous section, we examined three problems which have arisen in connection with the current CAI appli-

cations. Several of our suggestions for future developments will, then, deal with the problems we have already mentioned.

1. Some of the funds available to schools for the purchase of the hardware used in drill-and-review systems should be spent instead to study what it takes for the teacher to apply the summarized test data to classroom practice, and to develop a vehicle for appropriate teacher training. The emphasis in drill-and-review systems should be shifted, at least temporarily, from the problem of gathering the data to the problem of understanding and applying the data.
  2. Much more work needs to be done aimed at overcoming what Spolsky identifies as "... the present inadequacy or incompleteness of linguistic theory."<sup>10</sup> Ideally, the person writing an instructional program should be able to state a question to be asked of the learner, provide an answer to the question, and then specify that any response of the learner's which means the same is to be treated in the same way by the program. Although we may never attain this ideal goal, any approximation to it will have a significant beneficial effect upon CAI applications.
  3. In his article in this issue, Zinn points out that the "... benefits unique to computer presentation and control have not yet been demonstrated ... few lesson designers have made use of capabilities beyond those which can be accomplished with the printed format." One reason this is the case is that most lesson designers are using CAI systems to prepare specific course material, and the exigencies of such work—deadlines, funding arrangements, contract commitments, available time on the system, etc.—preclude the investigation of untried techniques. To correct this situation, projects should be initiated for the primary purpose of making the computer do that which the text—programmed or otherwise—cannot do.
  4. While recognizing the dangers of too-hasty standardization, efforts aimed at specifying a common CAI language should continue. This work will be most difficult, since it will require reconciling the conflicting interests of such diverse parties as hardware manufacturers; educators (teachers, school administrators, curriculum specialists); textbook publishers; trainers in business, industry and government; and research specialists representing linguistics, behavioral technology, man-machine communications, etc.
  5. The obvious hardware improvements are needed in CAI as well as in other computer application areas: more reliable, less expensive components. Significant advances which promise to improve the performance and to reduce the cost of terminal displays have been demonstrated by the Plasma Display Group at the Univ. of Illinois Coordinated Science Laboratory, and more recently by RCA. Work is also needed to provide CAI system hard copy output devices for graphic as well as alphanumeric information, under both learner and program control.
- Clearly there is much work to be done. One can only hope that those involved in the work will heed Oettinger's articulate warning, "Whatever the setting for educational experimentation, it is vital in our still profound ignorance to shy away from rigid prescriptions of either goal or technique. There is too much rigidity even in the present innovation fad which, ironically, diverts human and financial resources from both basic research and sustained application and evaluation efforts into the most visible quickie approaches that can sustain the illusion of progress."<sup>11</sup>

<sup>10</sup> *Op. cit.*, p. 495.

<sup>11</sup> Oettinger, A. G. "The Myths of Educational Technology," *Saturday Review*, 51, 20 (May 18, 1968) p. 91.

# CAI LANGUAGES: CAPABILITIES AND APPLICATIONS

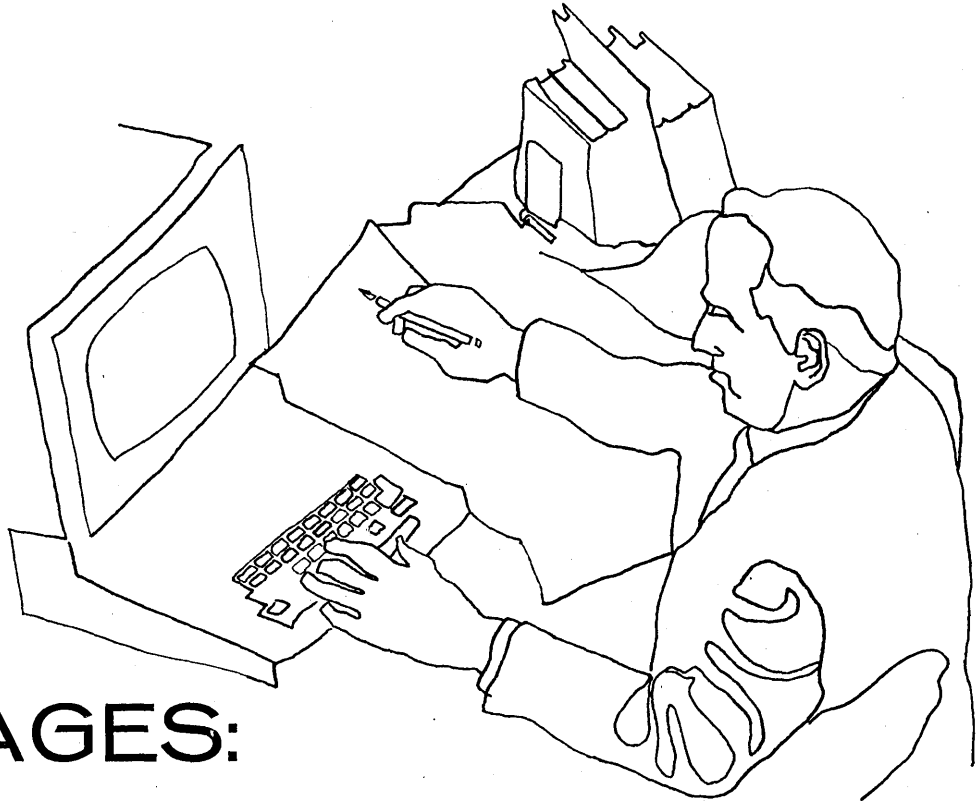

by CHARLES H. FRYE

When computers are used for instruction, it becomes immediately apparent to the course author that the standard computer programming languages are not suitable for course preparation. The intricate formatting requirements for printing the output, and the character manipulation needed for answer matching, require a programming proficiency that course authors seldom have or desire to obtain. While course authors sometimes use the services of experienced programmers, this is usually too costly. As a result, several author-languages have been developed that enable course authors to prepare their own material with minimal training. This article discusses some of these.

The number of extant computer-assisted instruction (CAI) author-languages is growing rapidly. Zinn<sup>1</sup> lists over 20, some of which were only in the planning stages at the time of his writing. New CAI languages have appeared since then. The current CAI systems mentioned in this article are listed on page 37. The state-of-the-art is changing so rapidly and documentation is so sparse that a fully adequate appraisal of the many languages is impossible. Some comparisons between languages have been made, only to be invali-

dated by subsequent revisions of the languages.

It is also difficult to avoid a bias when comparing languages. The two methods most often used in comparing languages are: (1) categorize their capabilities, noting the absence of certain features; and (2) code a sample instructional sequence in each competing language, noting some efficiency measure for each task (e.g., the number of lines of instructions). Among the pitfalls in these comparisons are: (1) the documents used for the comparison of the various languages were not equally current; (2) the categories on which the comparisons were based were taken from one of the languages, thus favoring that language; and (3) the test cases were selected from those particularly suited to one of the languages. Though this author is aware of these pitfalls, he does not guarantee to avoid them completely.

## four classes

The languages being surveyed fall into four general classifications: (I) conventional compiler languages; (II) adapted conventional compiler languages; (III) interactive computing and display languages; and (IV) specially devised instructional author-languages.

Class I includes such languages as ALGOL, COBOL, FORTRAN, JOVIAL, LISP, MAD and OPL. Though these languages are seldom listed among CAI author-languages, they can be used to implement any kind of CAI lesson and can take advantage of any available input or output equipment on

<sup>1</sup> Zinn, K. *Author Languages and Support in Computer-Based Educational Systems: An Outline of Documents in Preparation*. Ann Arbor: Center of Research on Learning and Teaching, The University of Michigan. June, 1967a, 3 pp. (mimeo, unpublished).

the computer. CAI lessons have been so written<sup>2</sup>, but only an experienced programmer can prepare a lesson in these languages. The languages are primarily designed for scientific computing and data processing jobs, but are inefficient for coding many simple kinds of instructional tasks such as printing large amounts of text, simultaneously monitoring a number of interactive consoles, prescribing relevant answers to be anticipated (especially where the match will not be exact), and keeping pertinent student record data from session to session. Few content experts will acquire the requisite programming skills to prepare lessons using these languages. Thus it becomes necessary to hire programmers to do the actual coding. The unsuitability of these languages to instructional needs gave rise to the development of the Class IV languages discussed later.

The Class II (adapted conventional compiler) languages represent an attempt to correct the inefficiencies in the Class I languages by adding certain features that make them more suitable for instructional uses. Thus, MENTOR is an extension of LISP, ELIZA of OPL, and CATO and FOIL are two different extensions of FORTRAN. The usual extensions include such routines as student sign-on and sign-off, answer matching, and record handling. In general, however, this does not alleviate the need for programming experience. It essentially makes the programmer's job easier. Because of their instructional adaptations, these languages usually appear among the CAI author-languages.

Class III (interactive computing and display) languages encompass both CAI and non-CAI oriented systems. These include ADEPT, APL, BASIC, CAL (SDS), JOSS, QUIKTRAN, TELCOMP, and TINT. In this class, one sees more variety than uniformity with respect to CAI applications. JOSS, on the one hand, has not been identified with CAI, while APL, on the other, is described as being a complete CAI author-language.<sup>3</sup> TINT uses the programming conventions of JOVIAL, a Class I language, while ADEPT follows COURSEWRITER, a Class IV language. It is therefore not always clear to which class a given language belongs. However, most of these languages are usually classified together because of their intended use. Zinn<sup>1</sup> calls them "student languages." Dorn<sup>4</sup> refers to them as belonging to CEI (computer extended instruction), rather than CAI, because they extend the students' ability to solve problems. They usually embody no instructional sequence (however, this is not precluded). They do not, as a rule, employ simplified schemes for answer matching, criterion branching, record keeping, session termination and resumption, and numerous other bookkeeping activities that characterize specially devised author-languages. They do, however, provide a great amount of computing power (or graphic display capabilities in the case of ADEPT) that is highly interactive and usually quite easy to learn. They avoid long turnaround times by operating interpretively or by incorporating fast compilers. Instructional problems are usually (though not necessarily) mathematical in nature and results may be in the form of numbers appearing on a typewriter or graphs on a crt display. The problem to be programmed could consist of an instructional sequence, which then suggests author-language capabilities. Unlike the case with Class I languages, programming errors are diagnosed and reported as they are encountered and immediate corrections can be made. Their role is essentially to support the user (student) in his attempt to find solutions to certain kinds of problems.

<sup>2</sup> Frye, C. H., and Rosenbaum, J. *Student's Guide to STAT*. Technical Memorandum TM-2910/000/00. Santa Monica: System Development Corporation, March, 1966. 174 pp. (offset).

<sup>3</sup> Hunka, S. *APL: A Computing Language for the User*. Research Report No. RB-67-2. Edmonton: Division of Educational Research Services, The University of Alberta, November, 1967. 21 pp. (mimeo).

<sup>4</sup> Dorn, W. S. *Computers in the High School*. *Datamation*, 1967, 10(2), pp. 34-38.

Class IV languages, those specially devised as author-languages, include CAL (UCI), COMPUTEST, COURSEWRITER, DIALOG, FOCAL, INFORM, LYRIC and PLANIT. In general, these languages include capabilities for building and administering instructional sequences. They monitor the students' activities, collect performance records, and then make the information available to authorized persons. (COMPUTEST is oriented toward computer administered testing and hence has fewer CAI features than other Class IV languages. INFORM and LYRIC resemble COURSEWRITER in several respects, differing mainly in the spelling and format of command forms.)

To facilitate building courses, the languages provide convenient methods for accepting answers so that many variations of answers can be matched, including selected words, misspellings, numbers within prescribed intervals, and—in the case of one language, PLANIT—even algebraically equivalent answers. The given answer-matching rule that is applied is always under lesson control. Most of the author-languages also provide a means for writing decision rules into the lesson so that the sequence in which the lesson material is executed will depend in part on the performance history of each student. The lesson can be tailored to sense deficiencies in the student's responses and provide remedial help to correct them.

These CAI languages also do the necessary bookkeeping so that a student can terminate a session at any time and resume at the next session either where he left off or at some designated reentry point prior to it.

#### several considerations

When evaluating the merits of these author-languages, several aspects should be considered, including: (1) user orientation; (2) lesson handling; (3) record handling; (4) conditional branching; (5) answer matching service routines; (6) calculation provisions; and (7) communication devices. Even with these criteria and the latest available documentation for each author-language, one could not conclude that any one language was unequivocally superior to the others because each has particular applications for which it is ideally suited. Also, the languages that provide the greatest flexibility usually require larger computers or more expensive terminals, or both. The following discussion uses the above criteria with respect to certain illustrative author-languages.

In general, most course authors would find the least difficulty in learning to use Class IV languages and progressive difficulty as the class number decreases. The ability to write programs in COBOL, FORTRAN, or JOVIAL is a profession in its own right and thus would require that a course author ei-



*Dr. Frye is a human factors scientist at System Development Corp., Santa Monica, and is co-author of the PLANIT author language, SDC's CAI system. His experience includes public school teaching, and research in programmed instruction for the Oregon State System of Higher Education. Dr. Frye received his BA from Whitworth College, and MA and Ph.D. degrees from Michigan State Univ.*

## LANGUAGE CAPABILITIES . . .

ther be cross-trained or that a programmer be employed. By contrast, an author could learn to use COURSEWRITER, FOCAL or PLANIT well enough in two or three hours to begin writing his instructional lessons easily. Another important advantage of the Class IV languages, especially for the new course author, is that error information is interpreted in terms of the lesson being constructed. For example, a Class IV language could inform the author that the appropriate answer was not being matched correctly because of an error in the prescription of the anticipated answers, whereas answer matching is not part of the normal function of most



other languages and hence errors would not be interpreted in an answer matching context. Some languages (e.g., ELIZA and PLANIT) provide helpful lesson building information to the course author on request while the lesson is being built.

An additional feature of the Class IV languages is their ability to try out new lesson segments soon after they have been completed. The distinction is usually whether the lessons are "compiled" or operate "interpretively." For example, COURSEWRITER lessons are compiled, often requiring 24 hours or more before a new lesson can be executed. An example of an interpretive language is PLANIT, which can execute lessons immediately at any point in their development.

A Class IV language will automatically format the output messages (i.e., the computer's messages to the author or student) and set up conditions for inputting a response, since these activities are implied by the structure of the lesson. Languages falling under other classifications usually require additional explicit instructions to accomplish formatting. For example, even the simple typing of a body of text often involves the specification of additional typewriter carriage control symbols.

Normally, the pertinent aspects of record handling are: (1) the relevance of the records that are being kept; (2) automatic maintenance of records from session to session; (3) records that allow designated restart points for session termination or system failure; (4) records useful in the decision structure of the lesson for tailoring the lesson according to individual performance characteristics; and (5) statistical aids for automatically interpreting the student rec-

ord data from completed lessons and summarizing the results. None of the known languages provides all five capabilities but each includes one or more of them.

All CAI languages have some form of conditional branching for altering the sequence of instruction based on student performance. Conditional branching is usually more easily implemented in the Class IV languages. The distinguishing factors are the kinds of performance characteristics that can cause a branch and the amount of prescription necessary to designate the condition. Most languages require the lesson author to anticipate his future conditional branching instructions by identifying the relevant data to be kept as he builds the lesson.

Data slots (counters) are provided where numbers can be temporarily stored. By assigning counters to certain lesson characteristics (e.g., the number of wrong answers), branching decisions can be made to depend on current values of the counters. Some languages (e.g., CAL, FOCAL, MENTOR) also provide for alternate branches to be taken if questions are repeated. Other languages (e.g., CATO, PLANIT) avoid the use of counters by referencing the student records, which are automatically kept as a basis for conditional branching. They provide a variety of branching capabilities that use many facets of the student's performance history.

### some routines

Several answer-matching routines have been found useful. The most common are listed below, together with selected author languages that incorporate them:

<u>Service Routine</u>	<u>Language</u>
Exact match	All languages
Key word match	All languages
Selected character string match	CAL, COURSEWRITER
Percentage match	COURSEWRITER, LYRIC
Partial match	CAL, COURSEWRITER
Phonetic match	ELIZA, PLANIT
Algebraic match	PLANIT
Numeric match (within specified limits)	LYRIC, PLANIT
Calculated numeric match	CATO, PLANIT

These service routines enable the lesson author to allow for the recognition of answers that vary in a predictable way from those that he explicitly lists in the lesson. Briefly, the key word matching routine requires only that the prescribed answer can be found within the student's response; selected character string matching looks for specific characters in the student's response; percentage matching requires that the designated percentage of the characters in the prescribed answer be present in the student's response; partial answer matching informs the student which characters in his response are correct, prompting him to reply correctly; phonetic matching accepts words in the response that "sound" like the prescribed answer, though they may be spelled differently; algebraic matching accepts mathematically equivalent answers as correct; numeric matching considers the numeric value represented in the response, not the characters themselves; calculated numeric matching compares the numeric value of the student's response to the outcome of the computer's calculation of the same or similar problem.

Any of the above answer matching schemes could be explicitly programmed in a Class I or Class II language given sufficient effort and programming skill.

Most of the Class III languages were developed primarily for their computational capabilities. In addition to simple arithmetic, these capabilities usually include definitions and manipulation of both functions and matrices. They also include a variety of computational service routines such as

matrix inversion and selected statistical procedures.

Few languages permit the student to use the computer to do calculations while he is taking a lesson. COURSEWRITER includes a service program called DESCAL that may be used for simple arithmetic. PLANIT incorporates a fully integrated calculation (CALC) mode that can be used, interactively by the lesson author while building the lesson, or by the student while taking the lesson. The CALC mode in PLANIT is comparable to a Class III language in that it includes functions, matrices, several service routines and the more popular statistical tables.

### devices

Availability of communication devices for CAI is a subject for study by itself.<sup>5</sup> The terminals that are accommodated in an author-language are, to a large degree, governed by the equipment available on the computer being used. For example, some languages do not distinguish between upper and lower case characters because their terminals only use upper case. Cathode ray tube displays are often not available and hence not reflected in the language.

The electric computer-controlled typewriter is the device most often used for communication with the student, for both input and output. Other input devices include the light projecting pen (for use with a crt), touch sensitive screens, and the electronic graphic tablet. Output devices, in addition to the computer-controlled typewriter, include crt (both tabular and graphic), audio, and projected image.

Normally, it is not meaningful to consider devices when evaluating the merits of an author language, since this is more a function of the hardware than the language. A message can be sent to a crt as easily as to a typewriter, given the proper hardware. Likewise, the greatest obstacle to widespread use of audio and projected image devices is that fast, reliable random access models are not generally available.

An important exception to this is in the realm of computer graphics. A few languages (e.g., CATO on the PLATO II system) enable the computer to generate pictures on the crt. (Some systems generate pictures on the crt by strategically placing selected characters. This is tabular, not graphic.) In terms of efficiency, close attention must be paid to the amount of work involved in preparing a computer-based picture. Displays that originate in free-hand drawings that are automatically processed obviously require less effort from the course author. This caution also applies to a large extent to audio devices; usually, the preparation of the audio tape is an involved process. The CATO language accommodates the overlay of an image with a computer-generated display, but special PLATO II hardware is required to accomplish this. The DIALOG language provides for very convenient entry of pictorial material into a stored lesson sequence: the author simply places the picture in front of a television camera and presses a button.

The light pen, like the crt, requires little from the author language if it is used only to point out characters that are displayed in a tabular manner. However, if the author desires to identify discrete points within the display via the light pen (identify characters that have been displayed or look for a given point) and use that as a student response, then the language requires a number of additional features.

The graphic input tablet shows promise as a student-response device. PLANIT accommodates one such device that has been modified to project a crt image onto the surface of the tablet.<sup>6</sup> Students respond with hand-printed characters

or symbols that are processed by a character-recognition program and then matched by the usual methods. However, the tablets are too fragile and expensive for general use.

Although vocal response devices would have obvious advantages for CAI, none has yet been developed that approaches meeting the minimum requirements. Research is being carried on that will someday make natural language communication with the computer possible.

### List of Current CAI-Type Systems

System documentation is often informal and frequently revised. The sources listed below will be able to suggest the latest available materials.

Language	Institution or Firm	Contact Person(s)
ADEPT	International Business Machines Corp., Poughkeepsie, N. Y.	K. Engvold J. Hughes
APL	International Business Machines Corp., Yorktown Heights, N. Y. Science Research Associates, Chicago, Illinois	K. Iverson P. Calingaert
BASIC	Dartmouth College, Hanover, N. H. General Electric, Schenectady, N. Y.	J. Kemeny T. Kurtz Information Service Department
CAL (UCI)	University of California at Irvine, Irvine, California	F. Tonge
CAL (SDS)	Scientific Data Systems, Santa Monica, California	
CATO	University of Illinois, Urbana, Illinois	D. Bitzer
COMPUTEST	University of California, San Francisco, California	J. Starkweather
COURSEWRITER	International Business Machines Corp., San Jose, California	Product Publications Department
DIALOG	Technomics, Inc., Santa Monica, California	R. Gray
ELIZA	Massachusetts Institute of Technology, Cambridge, Massachusetts	J. Weizenbaum
FOCAL	The Ontario Institute for Studies in Education, Toronto, Ontario, Canada	D. Ensor
FOIL	University of Michigan, Ann Arbor, Michigan	K. Zinn
INFORM	Philadelphia Public Schools, Philadelphia, Pennsylvania Philco-Ford Corp., Willow Grove, Pennsylvania	Sylvia Charp
JOSS	RAND Corporation, Santa Monica, California	
LYRIC	Educational and Training Consultants, Los Angeles, California	L. Silvern Gloria Silvern
MAD	University of Michigan, Ann Arbor, Michigan	
MENTOR	Bolt Beranek and Newman, Cambridge, Massachusetts	W. Feurzeig
OPL	Massachusetts Institute of Technology, Cambridge, Massachusetts	J. Weizenbaum
PLANIT	System Development Corp., Santa Monica, California	C. Frye S. Feingold
QUIKTRAN	International Business Machines Corp., White Plains, N. Y.	
TELCOMP	Bolt Beranek and Newman, Cambridge, Massachusetts	W. Feurzeig
TINT	System Development Corp., Santa Monica, California	R. Brewer

<sup>5</sup> Glaser, R. *The Interface Between Student and Subject Matter*. Pittsburgh: Learning Research and Development Center, The University of Pittsburgh. 1965.

<sup>6</sup> Frye, C. H., and Williams, T. G. *Instructional Applications of the Graphic Input Tablet*. Technical Memorandum TM-3836/000/00. Santa Monica: System Development Corporation. February, 1968. 10 pp. (offset).



# CAI — THE NEW DEMONOLOGY?

by JOSEPH H. KANNER

Once more the trumpet sound is heard. New promises for the future and ecstatic descriptions of the wonderful world of tomorrow's education assail the ears of the weary educator. Now, it is computer-assisted instruction, clothed in the shining armor of computer prestige and mystery, which will rescue us from the dilemmas and problems of the present day education. Now, it is computer-assisted instruction which will assuredly succeed where programmed learning, teaching machines, television, motion pictures, and other faded promising approaches of the past failed.

But to the tired ears of this listener there is a familiar ring in the language of the advocates of computer-assisted instruction. Most of it has been said before, most of the promises have been made before. It may be strategic, therefore, to review the history of the recent past as a prelude to judging the soundness and validity of the present enthu-

siasm for computer-assisted instruction.

Motion pictures have a long history of research<sup>1</sup>, but during World War II the extensive military use of training films renewed interest in their use in education. In the period following World War II this renewed interest was manifested by the establishment of a number of research programs dedicated to exploring the sound motion picture as a teaching medium. The two most extensive programs were sponsored by the U.S. Air Force and Pennsylvania State Univ., which conducted motion picture research on a contract basis with the U.S. Navy and U.S. Army.

For nearly a decade these major programs explored a variety of problems using the motion picture as the me-

<sup>1</sup> Hoban, C. F., & van Ormer, "Instructional Film Research 1918-1950 (Rapid Mass Learning)" NAVEXOSP-977, Penn State College Instructional Film Research Program, Dec. 1950.



dium. Underlying these programs were the beliefs that the training film possessed the following advantages. It would: permit standardizing teaching materials at a high level of effectiveness; permit the development of distinctive teaching materials for different aptitude groups; help reduce requirements for skilled instructors by assuming critical portions of teaching load; and because of film's ability to capture and present repeatedly, without change, the same material, provide an excellent medium for conducting research and development of new information and insights into the human learning process.

### little result

The results of these various research programs were surprising. The major surprise was the triviality of much that was discovered. Most of the results had little generality beyond the specific films which were being studied. Of the few studies where results appeared valid, there flowed the conclusions, for example, that showing a film more than once was probably the most effective way of improving student learning from the film; or that a terminal review was probably the most effective way of improving student retention of film content. Nearly all else was lost in a mass of indecisive findings, or "no significant differences."

It is apparent that no striking insights or conclusions concerning human learning were developed by any of these programs, and it is not surprising that many film makers ignored the findings either because they were not known to them or because of the claim that they had arrived at the same conclusion about film effectiveness long before the studies were made. A mountain of film research produced mouse-like results.

During the early 1950's, educational television appeared on the horizon. Interest in film research declined. Efforts were channeled in the direction of developing television as a teaching medium. The early enthusiasm for television was based on the belief that it would serve as a mass instruction medium. This was before the development of the video tape recorder and when all television transmission was "live."

Therefore, the most efficient use of television would lie in reaching as many students as possible at the same time. Again, this period of initial television development was accompanied by many promises about the revolution in education which would result from the full time employment of television. Some speculated that formal classrooms would disappear and a student would obtain his education at home watching television. But educational institutions stubbornly refused to revise their teaching schedules to accommodate television and prior to the invention of the video tape recorder a period of disillusionment was setting in.

In 1955, however, with the appearance of the video tape recorder, it was no longer necessary to attempt to schedule all classes on the same subject at the same time. The video tape permitted television to adapt to any existing educational structuring format. Television had some advantages for the educator which film did not possess. Among these were the ability to more rapidly produce educational programs and to review or correct them much more quickly. These advantages would also be employed, it was said by the researcher, to gain new insights and information concerning human learning.

Nevertheless, it has taken more than 15 years, within the armed forces, to adapt television to teaching requirements. Among the problems in adaptation was the avoidance of techniques which were useful in one medium but unnecessary in television. For example, the nature of motion picture film production requires the "shooting" of small segments lasting a minute or less. In television productions, however, it is possible to shoot for as long as 30 minutes or an hour

without stopping because the producer can immediately see on the television monitor what he is obtaining and can also play back the video tape. Nevertheless, many television personnel persist in the segmented motion picture production style.

Traditional educational practices also reduce the effectiveness of television. While it has been established that television can present entire courses effectively without an instructor (as witness university courses offered entirely by television, e.g., "Sunrise Seminar"), many educators are reluctant to use television other than as a brief supplement to classroom instruction. But the major point here is that it has taken at least 15 years of trial and error to gain an acceptable adaptation of television within armed forces education. During this period the promises of new insights or knowledge about human learning did not materialize. The advantages of television lie in such simple factors as permitting more people to see what is going on and to capture, for later repeated showings, the teaching efforts of good instructors.

### another new method

With the rapid decline in film research which occurred in the late 1950's, there also appeared a "new approach" called programmed learning. The 1925 work of Sidney Pressey which had fallen into obscurity was revived under the major stimulation of the work of B. F. Skinner. Skinner, a research psychologist, had demonstrated great skill and ingenuity in teaching pigeons unusual skills. Underlying his approach were exotic patterns for giving the pigeon food reward. His success in animal training led to the belief that similar principles applied to human learning might provide a major breakthrough in developing more effective teaching procedures. To describe the flavor and fervor and atmosphere which surrounded the explosion of interest in programmed learning would require the skill of H. L. Mencken in describing a Bible Belt revival. In many ways the logic and emotion were similar.

In 1959, the writer participated in a symposium and made the following observations:

"This writer's estimate of the potential of automated teaching books and machines may be summarized as follows: (1) Their proponents have issued many promissory notes for value and effects, but adequate evidence does not now exist to back up these claims; (2) The cost of these kinds of equipment is high, running in one instance to about \$6,000 a machine, although increased production efficiency may reduce these costs. Cost is unimportant if something of importance can be accomplished with these machines and not

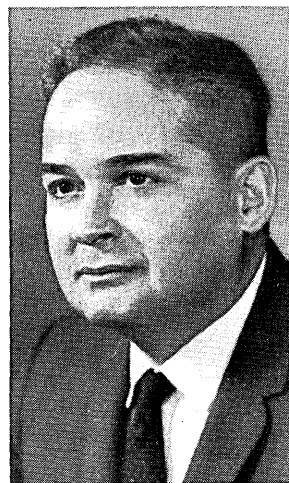

*Dr. Kanner is special assistant, Office of the Assistant Chief of Staff, Communications-Electronics, U. S. Army and the Army's representative to industry for CAI development. He has designed and conducted most of the Army's studies in educational television since 1953. He has a doctorate in psychology from New York Univ.*

## NEW DEMONOLOGY? . . .

by other less expensive methods. There is not enough evidence that this is now the case.

"What is needed is a comparative study between teaching machines and other instructional methods, including film and television, using an adequate sampling of subject matter, and taking into account such factors as equipment and programming costs. The following question would be important: 'If the amount of time spent in planning and programming for automated devices were spent on conventional teaching methods, what would be the result?'"<sup>2</sup>

I might as well have commanded the tides to stand still. There was no limit to the predictions and promises made by some advocates of programmed instruction. I recall a Pentagon briefing when one of these advocates hinted darkly that the Russians were using programmed instruction and that if the U.S. did not keep on its toes in this field, we could expect some dire consequences from this Russian interest. While the specifics of these consequences were not spelled out, you gained the impression that unless this individual's particular private firm received extensive monetary support from the U.S. government, there was a possibility of some national disaster.

In the nearly 10 years which followed, most of the promises about the superiority of programmed instruction, about gaining new knowledge and insights into human learning and about achieving new breakthroughs in educational processes, have proven to be empty and exaggerated. A period of disillusionment has developed among educators with respect to programmed instruction and the associated hardware referred to as teaching machines. Educators were again the victims of overzealous salesmanship and, in my opinion, the abandonment of responsibility by some researchers and research organizations in not providing objective critical evaluations of the claims made for programmed learning. Time and again I have encountered many studies in which programmed instruction was compared with conventional instruction. In these comparisons, major effort was made in the development of the programmed version while the conventional instruction remained unimproved.

Despite this, programmed instruction would prove to be no better for student learning than the conventional instruction. One would think that after this type of result was obtained often enough the conclusion would be reached that there was no point in spending further research funds and efforts on programmed instruction. But this logical approach reveals an ignorance of the thought processes of many researchers. Rather than discouragement, many of them revealed optimism over these negative results and solicited further funds to explore programmed instruction.

### now comes the computer

But you can fool the public for only so long. It probably became evident that the time was ripe for diverting attention from the shortcomings of programmed instruction. During the decade of the 60's the computer had reached new heights in prestige and mystery. Inevitably, the concept of combining the computer with the teaching processes was developed. And a skeptic might reasonably conclude that it would be a master stroke to jump to the computer as a means of reviving hope in the possibility of achieving the goals previously set for programmed instruction and diverting attention from the major failures of programmed instruction in meeting these goals.

The advocates of computer-assisted instruction are re-

peating the history of their predecessors in motion picture, television and programmed instruction. There has already appeared a voluminous literature which outstrips in number the actual valid findings made in the uses of CAI.

In a recent Department of Defense seminar on computer-assisted instruction, 11 different armed forces sponsored projects in the field were identified and it is not difficult to estimate that the number of projects supported by other agencies equals or exceeds the Department of Defense sponsored efforts. It is also interesting to note that the participants in the Department of Defense seminar began to voice, even at this early state, the need for certain standards in CAI research. Among these were:

a. The need to develop standards and criteria for measuring the educational effectiveness of instructional software and various media.

b. The need to develop computer education systems with instructional software which are not limited in nature and do not serve only to validate the system hardware.

If the experiences of the past are to serve as a guide to the future, I think an evaluation of the effectiveness of CAI and its place in education of the future must be based on the following considerations:

a. It is an unhappy fact that our knowledge of human learning is primitive. We have no general laws or hypotheses comparable to those in the fields of physics or chemistry. What we do have are fragmentary bits of empirical knowledge. For example, we know that repeating something increases the probability of the learner remembering the information. We know that telling the learner immediately that he is right or wrong also facilitates learning, and there are a few other isolated insights of this type. Therefore, no one can guarantee, except on a trial and test basis, that a particular sequence of instruction will be effective. Further, the techniques used to make a sequence of instruction effective in one subject matter may not be applicable in another subject matter. It is this lack of knowledge about human learning that has accounted for the numerous failures among motion picture, television, and programmed learning researchers in their attempts to improve over conventional classroom methods. Computer-assisted instruction possesses no superiority over the other approaches in its knowledge of human learning. It, too, will have to proceed on a trial and error basis.

b. Standards for the continuance or rejection of computer-assisted instruction research should be established. These standards should include such factors as student learning, administrative costs, equipment costs and requirements as compared to other existing methods of presenting educational material.

As I did in 1960 when programmed instruction was approaching a crest in popularity in research effort, I am again making a similar plea to the proponents of computer-assisted instruction to observe certain cautions. These include a moratorium on promises not yet supported by facts; the establishment of criteria describing limitations as well as the reasonable implications of research efforts and the recognition that computer-assisted instruction is in competition in the market place with long-established alternative methods of teaching. Therefore, the future use of computer-assisted instruction must be based on the possession of advantages economic, administrative and learning, which these other existing methods do not have. There should also be the recognition that favorable research results are only a preliminary to many long years of adaptation and acceptance within current educational practices. As someone who has experienced the cycle of research and the problem of gaining acceptance for television as a promising new way of teaching, I would like to encourage and offer my best wishes for success to those who are engaged in the exploration of computer-assisted instruction. ■

<sup>2</sup>"New Teaching Aids for the American Classroom," pp. 120-121. The Institute for Communication Research, Stanford, 1960.

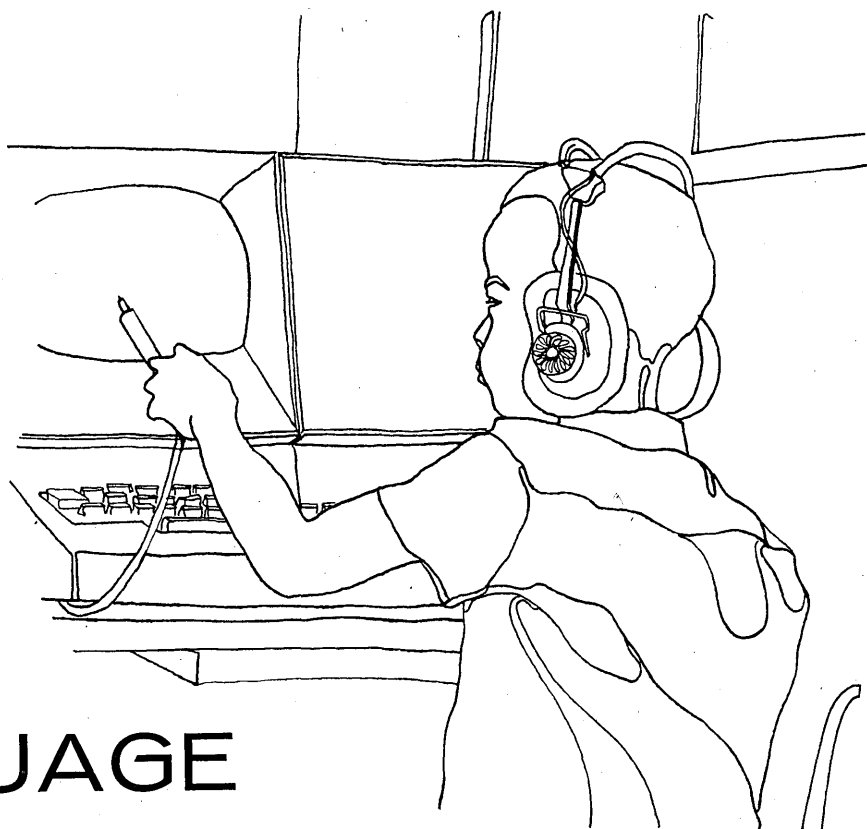

# PLANIT— A LANGUAGE FOR CAI

by SAMUEL L. FEINGOLD

CAI—computer-assisted instruction—means using the computer to control or monitor the presentation of some portion of information. The sequence of presentation is not necessarily a function of the student's response to the information received; an electronic slide projector operating with an automatic timer is a simple example of an analog computer presenting information independently of the student's response. The limitations of such a device as a means of instruction are obvious. For instance, the slide projector has no knowledge of the student's grasp of the material presented. It knows not if the material was too tough or presented too fast nor can it vary the presentation even if such student response information was available. A more complete definition would include the notion of interaction.

"Interaction" is the sequence of operations in which the computer presents some information, the student responds, and the computer, on the basis of his response, presents more information. The computer's ability to *interact* with a student is fundamental to the achievement of meaningful instruction whenever the instruction is such that it can vary according to the student's performance. When the computer's ability to save or record the student's responses is added to the capability for interaction, the computer can maintain a complete record on the student. It can record his path through the material, the answers he gave in response to questions, how much time he took, and the number and types of errors he made.

A variety of devices can be used for the controlled pre-

sentation of CAI information. Films, slides, teletypewriters, cathode ray tubes (with light pen interaction), RAND Tablets, touch-sensitive devices, and tape recorders have all been used, in various combinations, for CAI. The two devices in most common use today are the teletypewriter and the cathode ray tube (crt).

While it has always been possible to use a computer for



Mr. Feingold is a computer systems specialist at System Development Corp., where he was co-author of PLANIT. He has worked on software systems ranging from time-shared, interactive educational programs to large command-and-control systems. He has a BS in mathematics from Brooklyn College.

**General  
Electric is  
demonstrating  
the only  
3-dimensional  
information  
system**

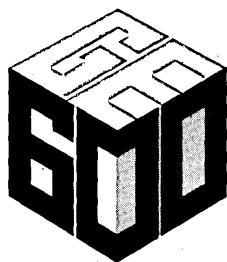

Maybe you're already doing batch processing, remote batch, and time-sharing. But you're using several independent computers. Watch what happens when you replace them with a single GE-600, the *only* information system today that can operate in all three dimensions of information processing:

**You'll improve throughput.** The GE-600 can handle 63 jobs concurrently through multiprogramming. With multiprocessing, you can handle these jobs even faster.

**You'll do more with less system.** The GE-600 can flex itself to handle any variety of workload — from 100% batch processing to 100% time-sharing, and any combination between. You don't need several systems, all big enough to handle specialized peak loads. The GE-600 adapts to your changing job mix.

**You'll save money at satellite facilities.** Compact GE-115 computers and keyboard terminals at your remote operations link up with the central GE-600. This gives your small satellite systems big system capability.

**You'll put your organization on line.** All your files are contained in a common data base. Every computer, every terminal, in every mode has access to it. With time-sharing, you can give your technical people fingertip access to an on-line computation capability.

You can give management immediate access to the facts of the business.

You can give your salesmen their order-entry system . . . your warehouses their dynamic inventory system.

**You'll put your programmers on line too.** They can develop their programs at time-sharing terminals. They can maintain their source program files in the system. They can initiate time-sharing or batch-mode jobs in debugging mode or for production processing.

No waiting for key punch, collation, and batch-mode turn-around.

Discover the three-dimensional world of the GE-600. Ask your General Electric Sales Representative for a demonstration. Or write Room 912, 2721 N. Central, Phoenix, Arizona 85004.

290-25

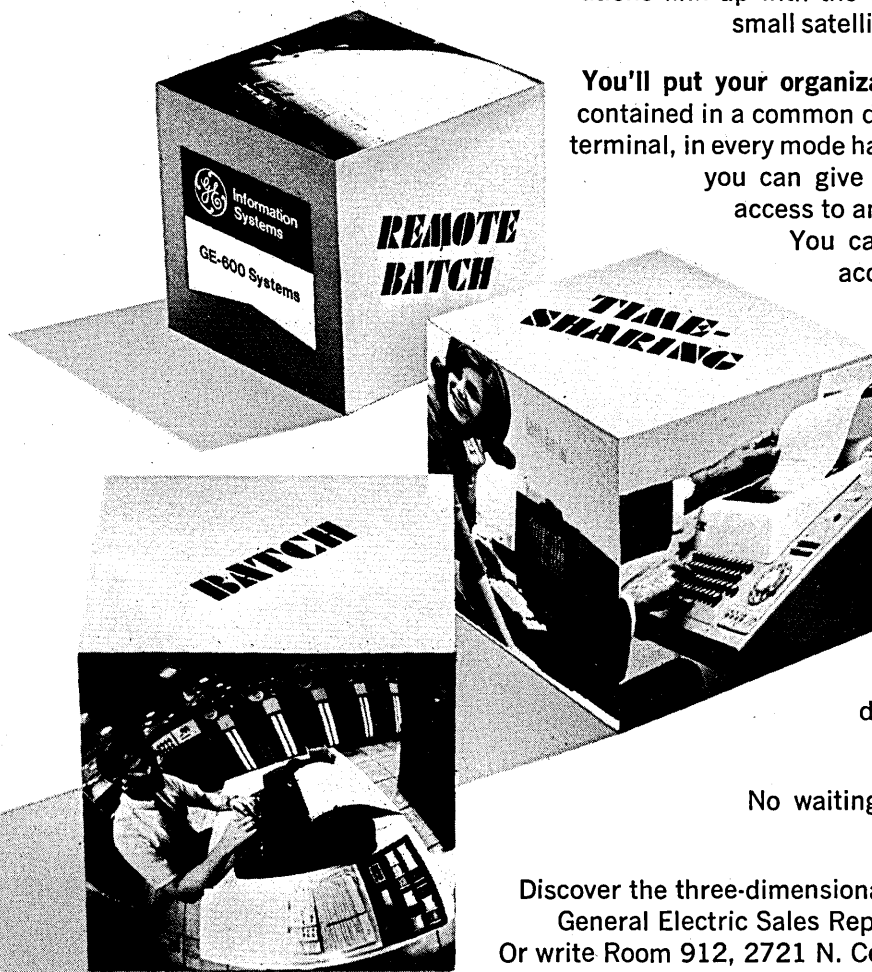

GENERAL  ELECTRIC

instruction, the cost of such an operation was prohibitive until time-sharing systems became operational realities. With the advent of time-sharing, on-line use of computers will become economically feasible for the average user; and on-line with him will be a wealth of utility support never before available. Before time-sharing, only fragmented CAI could take place unless large blocks of computer time (costing large sums of money) were dedicated to individual users and, during such costly interaction, the computer was idling most of the time, waiting for the user input.

### the need for special languages

The main distinctions between programming languages are the uses for which they are constructed. COBOL, for example, is business oriented; FORTRAN is scientifically oriented. In the same sense, CAI languages are oriented to writing lessons for interactive discourse between the student and the computer. Just about any language that allows the user to interact with the computer, or to write programs that will interact with a student, can be used for CAI. FORTRAN, QUIKTRAN, JOVIAL, TINT, and BASIC, which are all general-purpose languages, have, in fact, been used in this manner. However, although they are general purpose and, hence, can be used to write any kind of program, they are not CAI languages. They do not make it easy for an instructor to communicate his instructional logic to the computer, nor can they express any situation in such a way that the expression is naturally conceived, simple to write, and easy to read.

Suppose the instructor—whom we will call the lesson designer—is tackling the problem of what to do, considering the student's past performance, when the student reaches a particular criterion point in the lesson. The lesson designer may say to himself, "If the student saw information frames 5 through 7 and gave more than six wrong answers on the frames whose labels are Test 1 and Test 10, I want him to go to the frame whose label is REVIEW. On the other hand, if he spent more than 30 minutes on those test frames and gave less than, or equal to, a total of seven right answers out of frames 12 and 15 through the frame whose label is FIN5, then I want to feed back the message LETS LOOK AT SOME OF THESE PROPERTIES AGAIN and branch him back to frame 5."

Using PLANIT, the lesson designer would express this situation, in the decision frame, as follows:

```
IF SEEN 5-7 AND GR 6 WRONG TEST1-TEST10 B:REVIEW
IF GR 30 MINUTES TEST1-TEST10 AND LQ 7 RIGHT 12,15-
FIN5 F:LETS LOOK AT SOME OF THESE PROPERTIES AGAIN.
B:5
```

Granted, you could accomplish the same decision branching in most other languages, but it would not be as readable, it would not be as easy, and the lesson designer would have to consider these questions well in advance of their execution by setting the proper values into the right counters—that is, by coding. In PLANIT we transfer much of the coding to the computer. Of course, we can also set counters in PLANIT. In fact, we can set over 2,200 of them per student, and we can do it as a function of the student's answer, in natural algebraic notation, employing all the common trigonometric functions as well as statistical tools such as rank, factorial, combinatorial, etc. But, since the lesson designer has to phrase the question anyway before he can translate it into counter-setting code, why not let him just write it down in the form in which he thinks of it, and only at the place he needs it? This can be done in PLANIT because all student interaction is monitored. This capability

greatly enhances the power of PLANIT and is an example of a language specifically designed to provide the user with a facility for dealing with the problem of student history and performance.

Our goals in developing PLANIT, then, were to provide a powerful and flexible tool for entering course material into the computer, changing it, presenting it to the student, and describing the behavior of the computer in executing a sequence of instructional contingencies that would be responsive to student performance. In addition, we wanted the language to be simple enough that it could be used by a nonprogrammer. While there were a number of languages around that could satisfy some of these goals, we found none that satisfied them all. Rather than compromise our ambitions, we decided to build our own.

### description of planit

The initial design of PLANIT started in January, 1966; by June, PLANIT was operational. It was written in JOVIAL and used the IBM AN/FSQ-32V computer via an interactive console under the SDC time-sharing system.

Our original purpose was to have a language that would enable a lesson designer to build instructional material in statistics. However, since computer-based instruction in statistics requires so much flexibility and power, we discovered when we were through that we had more than we expected: We had a language designed to assist a lesson designer in building not only mathematical and related material, but such courses as history, spelling, psychology, etc.

PLANIT comprises not only a language but also a program, developed for time-shared use. The system operates in four modes: lesson building, editing, execution, and calculation. The first two modes permit the lesson designer to construct and edit lesson frames in various formats and store them in designated sequences for later presentation to the student in the execution mode. The calculation mode is particularly oriented to mathematical subject matter and can be used as a calculation aid for the lesson designer when he is building the lesson, or the student when he is performing the lesson. The student has access only to modes EX (execution) and CALC (calculation); the lesson designer may use all four modes.

**Calculation Capability.** PLANIT has an on-line calculation capability that allows either the lesson designer or the student to perform calculations involving trigonometric functions, elementary algebraic functions, and matrix declarations. In addition, the calculation functions of PLANIT can be tied in with the lesson. The lesson designer can request the student to compute some data and can specify that the student's answer be compared with the results of evaluating a previously defined function. The lesson designer can use the CALC mode to define the function when preparing the lesson; during lesson execution, the CALC mode can be used again to "test" the student's answer.

**Criterion Branching.** The PLANIT language allows the lesson designer to specify conditions for branching based on the student's performance over any portion of the lesson.

Conditions for branching may include:

1. Response latency on any one answer or group of answers.
2. Number of errors made on any group of questions.
3. Help received from the CALC mode (functions used or not used).
4. The actual path taken through the lesson up to this point.
5. Any combination of the above four points.

**Service Routines.** PLANIT also provides the following service functions for evaluating student answers that depart from the responses anticipated and specified by the lesson designer:

1. **PHONETIC Comparison.** This routine gives the student credit for his answer even though it is spelled incorrectly as long as it is phonetically equivalent to one of the lesson designer's answers. For example, PLANET and FONETIC are acceptable wrong spellings for PLANIT and PHONETIC.
2. **KEYWORD Match.** This routine instructs PLANIT to search for a set of words in the student's response as the KEYWORDS of his answer. Furthermore, if the lesson designer wishes, he may specify that the answer will be evaluated as correct only if these keywords appear in a prescribed order.
3. **FORMULA Equivalent.** This routine will allow the student credit for his answer as long as it is one of a subset of expressions algebraically equivalent to any one of the lesson designer's answers. For example, if one of the lesson designer's anticipated answers is  $5/9 * (F-32)$ , then  $(5 * F - 160) / 9$  or  $5 * (F / 9) - 160 / 9$  or  $(-32 * (5) + 5 * F) / 9$  would be equivalent and therefore acceptable. The lesson designer can have any combination of these three routines turned off and on during lesson execution (even between actual occurrences of anticipated answers during student interaction with the lesson).

### illustrations

A lesson is composed of a set of frames; frames are composed of groups; groups are composed of lines of information such as textual material, questions, anticipated answers, actions, etc. There are five frame types: Problem, Question, Multiple Choice, Decision, and Copy. The Q (Question) frame will be illustrated below. The P, M, D, and C frames will be discussed briefly to point out their capabilities. In this illustration (and in practically all PLANIT dialog), data entered by the lesson designer follow an asterisk typed out by PLANIT. All data are entered interactively via Teletype.

#### (Q) THE QUESTION FRAME

```
FRAME 1.ØØ LABEL=* HIST
2. SQ.
*?
2. SPECIFY QUESTION.
*WHO INVENTED THE ELECTRIC LIGHT?
*
3. SA.
*A+THOMAS EDISON
*B ALEXANDER BELL
*
4. SAT.
*A F: THATS VERY GOOD B:3
*B R: HE INVENTED THE TELEPHONE, TRY AGAIN . . .
*-R:
*-C:
```

#### explanation of frame 1

**First line.** All frames are, automatically, serially numbered by the program. Here the lesson designer chooses to label the frame HIST. (If he chooses not to label the frame, he will merely strike the space bar and the carriage return and pass on to Group 2. Group 1 consists merely of the frame label.)

**Group 2: SQ.** The lesson designer, not sure what SQ means, types in the question mark. PLANIT immediately repeats the group number, 2, and elaborates. The lesson designer then types in his question WHO INVENTED THE ELECTRIC LIGHT? PLANIT returns with an asterisk, waiting for more lines of input. Since PLANIT has no way of knowing when the lesson designer is through with the question group, it returns with an asterisk for each next line. The lesson designer ends the group by striking the space bar once and then the carriage-return key. (There is no theoretical limit to the number of lines that can be entered in each group. We do, however,

have a practical limit of 63 lines for the entire frame.)

**Group 3: SA.** PLANIT is asking the user to SPECIFY ANSWER. The lesson designer now enters all the anticipated answers, tagging the first one A and the second B, etc. the plus sign (+) next to the A indicates to PLANIT that this is the correct answer. The lesson designer then indicates the end of the group by striking a space bar and carriage return.

**Group 4: SAT.** The lesson designer is requested to SPECIFY ACTIONS to be TAKEN, depending upon which answer the student gives.

There are four types of commands in the action group:

**F:** What follows is the feedback message that is to be presented to the student. If no message follows F:, PLANIT will choose one randomly from its stored list of feedback messages, according to whether the student's answer was correct or incorrect. The lesson designer can thus enter F: by itself, knowing that the student will not get a monotonous YES or NO when he enters an answer. (Responses are usually one-word messages such as FINE, YES, CORRECT, NO, WRONG.)

**R:** This command instructs PLANIT to wait for another answer without printing the question again. It can be entered with an appropriate feedback message—in this case, the student receives the message HE INVENTED THE TELEPHONE, TRY AGAIN; PLANIT then waits for another answer. **R:** by itself instructs PLANIT to print out a fixed message (WRONG, TRY AGAIN) and wait.

**C:** This command used alone instructs PLANIT to print out the fixed message: THE CORRECT ANSWER IS, followed by the correct answer (indicated by the plus sign in Group 3). C can be followed only by another command—F:, R:, B: or a CALC statement. For example, c: COUNT=COUNT\*1 or c:X=FACT(3). This puts PLANIT in the CALC mode. COUNT is an item in CALC, as is X. Here COUNT is to be incremented by one and X is set equal to FACT(3)—i.e., the factorial of 3.

**B:** This instructs PLANIT to branch (B:3 means BRANCH TO FRAME 3). All frames are numbered; they can also be labeled, and a branch can be made to any numbered or labeled frame. In addition, B:LSNAM (where LSNAM is the name of another lesson) means that the lesson LSNAM will now be brought into PLANIT and executed as a part of the current lesson; the student will never know the difference. Upon completion of the lesson LSNAM, PLANIT will continue with the next frame in the original lesson. **B:** by itself causes PLANIT to return to the calling lesson. For example, if during lesson AA the command B:BC is encountered (where BC is a lesson name), lesson BC will be called and run until the command B:, in lesson BC, automatically returns PLANIT to lesson AA. Similarly, B:PROGM means branch to the program whose name is PROGM. When PROGM relinquishes control, execution continues with the next frame in the calling lesson.

The first input in Group 4 is read as follows: If the student gave answer A, print out the message: THATS VERY GOOD and branch to Frame 3.

The second input is interpreted as follows: If the student gave answer B, print out: HE INVENTED THE TELEPHONE, TRY AGAIN . . . and wait for another answer.

The third input, prefaced by a minus sign, indicates an action to be performed if the student's answer did not correspond with either A or B—namely, for any unanticipated response, wait for another answer. In this case, since nothing appears after the R:, PLANIT then prints out the fixed message: WRONG, TRY AGAIN, and waits for another answer. The lesson designer terminates the group and thereby the frame by striking the space bar and the carriage return key.

The space bar and carriage return alone on any line will terminate the group. The dollar sign (\$) and carriage re-

## PLANIT— . . .

turn alone on any line will terminate the frame. If, for example, the lesson designer (in the middle of Group 3) decided to end the frame and proceed to the next frame, he would only have to enter \$ and strike the carriage return alone on a line and PLANIT would respond with: P/Q/M/D/C.

The lesson designer may then build a new lesson, as follows:

```
*Q
FRAME 2.00 LABEL=*MATH
2. SQ.
*LETS SEE WHAT YOU REMEMBER ABOUT TEMPERATURE.
*USING F FOR DEGREES FAHRENHEIT AND C FOR DEGREES
*CENTIGRADE, WRITE THE FORMULA FOR CONVERTING FROM
*DEGREES FAHRENHEIT TO DEGREES CENTIGRADE. \
*HINT: F=9°C/5+32 CONVERTS FROM CENTIGRADE TO
FAHRENHEIT.
.
3. SA.
*Ø FORMULAS ON.
*A+C=(5/9)*(F-32)
*B F=9°C/5+32
*C C=(5/9)*F-32
.
4. SAT
*A F: B:7
*B R: YOUR ANSWER IS THE SAME AS THE ONE I GAVE YOU,
TRY AGAIN . . .
*A F: NOW YOU'VE GOT IT. B:15
*B R: YOU'RE STILL CONVERTING FROM CENTIGRADE TO
FAHRENHEIT, TRY AGAIN . . .
*BC F: NOTE THE DIFFERENCE. C: B:OUT
*-R:
*-C:
.
```

### explanation of frame 2

First line. The lesson designer labels this frame MATH.

Group 2. SQ. The lesson designer enters his question. Notice the back slash (\) after CENTIGRADE on the third line. This instructs PLANIT to skip a line after printing out CENTIGRADE—to set off the following HINT. The “\” can be used anywhere in group 2.

Group 3. SA. This group illustrates the algebraic matching ability of PLANIT (activated by the expression: Ø FORMULAS ON). The student can type in any equivalent algebraic form of the correct answer and get full credit for it—e.g.,  $C = (F - 32) * (5/9)$ ,  $C = 5 * (F - 32) / 9$ ,  $C = (5 * F - 160) / 9$ , etc., are all equivalent and therefore acceptable forms. If FORMULAS is not turned on (or is deactivated by the expression: Ø FORMULAS OFF), then only the exact form as typed in by the lesson designer would be looked for in the answer. (This, of course, is not true symbol manipulation; we merely employ a technique that—in part—includes performing algebra on the student's answer.) The matching technique is not restricted to correct answers; it works for all anticipated answers in Group 3.

Group 4. SAT. This group illustrates the repeated use of a frame. The first time through this frame, if the student's answer corresponds to:

A—he receives a (randomly selected) feedback message followed by a branch to Frame 7.

B—he receives the feedback message: YOUR ANSWER IS THE SAME AS THE HINT I GAVE YOU, TRY AGAIN . . .

C—he receives: NOTE THE DIFFERENCE. THE CORRECT ANSWER IS:

$C = (5/9) * (F - 32)$  . . . followed by a branch to the frame whose label is OUT.

If he gives an unanticipated answer (not A, B, or C), he receives the message: WRONG, TRY AGAIN.

The second time through the frame, if the student's answer corresponds to:

A—he receives: NOW YOU'VE GOT IT. PLANIT then branches to Frame 15.

B—he receives: YOU'RE STILL CONVERTING FROM CENTIGRADE TO FAHRENHEIT. TRY AGAIN. . . .

C—he receives the same message as in C above.

If no match (second unanticipated answer), he receives: THE CORRECT ANSWER IS  $C = (5/9) * (F - 32)$ . PLANIT will then go on to the next frame in the sequence.

If the student goes through the frame a third time, or more, and gives an answer corresponding to:

A—he receives the same feedback as for A the second time through.

B or C—he receives the same feedback as for C above.

If he gives an unanticipated answer, he receives the same feedback as for unanticipated answers the second time through. (Note: Several commands [F: C: R: B:] occurring on one line are performed in the order of their appearance from left to right.) If there is no Group 3, then all commands in Group 4 will be executed, and there will be no pause for the student's answer.

Another example frame illustrates the PHONETIC and KEYWORD routines.

```
P/Q/M/D/C.
*Q
FRAME 3.00 LABEL=*PRES
2. SQ.
*WHO WAS THE FIRST PRESIDENT OF THE USA?
.
3. SA.
*Ø PHONETIC ON
*Ø KEYWORD ON
*A+GEORGE WASHINGTON
*B ABE LINCOLN
*C+G. WASHINGTON
.
4. SAT.
*A F: B:SOMEPLAC
*B R: HE WASN'T THE FIRST, TRY AGAIN . . . C:COUNT=
COUNT+1
*C R: SPELL HIS FIRST NAME.
.
```

### explanation of frame 3

First line. The lesson designer labels it PRES.

Group 3. SA. Two different correct answers are designated above by the letters A and C. This is perfectly acceptable to PLANIT. However, when the command C: is used, the correct answer printed out will always be the last one with the plus sign. This group also illustrates the use of the phonetic and keyword matchers. The phonetic matcher encodes all answers into their phonetic equivalent. The keyword function looks for the answer or answers designated by the lesson designer anywhere in the student's response. Both phonetic and keyword are turned on, as shown in Group 3. The zero in front of PHONETIC ON and KEYWORD ON tells PLANIT to perform this function before any answers are matched. Their combined use would cause PLANIT to accept the following answer as correct: I THINK IT WAS JEORGE WASHINGTON. KEYWORD does not accept the answer in reverse order; i.e., WASHINGTON GEORGE would not be accepted. However, if FORMULAS was turned on too, then either order would be accepted.



### (M) THE MULTIPLE CHOICE FRAME

The M frame is built exactly the same as the Q frame. The only difference is that during the execution of the lesson, the choice of answers (in Group 3) is printed out.

### (P) THE PROBLEM FRAME

The use of this frame is rather specialized. Three kinds of information may be inserted here by the lesson designer:

Probability distribution parameters for generating data in the form of random samples—e.g., means, variances, and correlation coefficient for a bivariate Gaussian (normal) distribution. The random data would actually be generated for student use during the execution—for example, of a statistics lesson (the lesson designer can also specify headings and format for the actual printing of the data).

Steps to the solution of a problem in which the random data will be used (the student receives one step at a time in response to his request "STEPS").

Controls over the mathematical functions that shall (or shall not) be made available to the student when he attempts to solve a particular problem.

There is another, less specialized, use for this frame. The lesson designer may insert here the names of files (data bases) that can be used by PLANIT to search for answers to questions posed by students.

### (C) THE COPY FRAME

The Copy frame is more of a building aid than a frame in its own right. It allows one to copy and modify any frame previously built in the same lesson and to include it in the frame presently being built.

### (D) THE DECISION FRAME

As previously illustrated, all branching decisions are made as a function of what actions have taken place during execution of the frame. The Decision frame affords the lesson designer the opportunity to consider branching decisions (and other forms of program behavior) as a function of the student's past performance—that is, as a function of what has taken place during the execution of a set of frames. Since our goal is to provide the lesson designer with a language for handling—quickly, naturally, and easily—the kinds of problems that one encounters in CAI, we devised a "language" for describing patterns of past performance. This language takes two basic forms.

The first form, called the pattern form, allows one to inquire whether the student took a particular path through the material. For example, let us imagine the student went through Frame 1, answered A or C, and followed it by Frame 5 (in which he responded incorrectly), and then followed that by Frames 10 through 15, where the student was correct. An inquiry concerning whether or not the student went through that pattern exactly with no deviations can actually be written in the language pretty much as it has been stated. For example:

```
IF 1, AC 5,- 10-15,+
```

This, then, is the form of the pattern question. If the query is answered affirmatively, one can then use any combination of the three action commands—F, C, and B:

The second form of this "language" permits queries about summarized student performance over a set of frames. For example, one may want to know whether the student got less than or equal to five right out of Frames 10 through 22 and Frames 30 and 33. This can also be written, almost as stated, in the following manner: `IF LQ 5 RIGHT 10-22,30,33`. Similarly, if these conditions are satisfied, any of the three commands can then be executed. In place of `RIGHT`, one can substitute `WRONG`, `SEEN`, `MINUTES`, `USED`. With `USED`, one can have any function like `FACT` (factorial), `SIN`, `COS`, etc. For example:

```
IF GQ 5 MINUTES 10-15 B:10
```

```
IF USED SIN 6 B:7
```

means: If the student spent at least five minutes on Frame 10 through 15, then branch to Frame 10. The second "if" statement reads: If he used the function `SIN` in Frame 6, then branch to Frame 7. Also, in place of `GQ`, one can substitute `LS` (for less than), `GR` (for greater than), or other relationals such as `LQ`, `NQ`, `EQ`. Finally, one can use "if" statements to query the contents of items set in the calculation mode. `IF IQ LS 50 B:WORK` means: If the item whose name is "IQ" contains a value less than 50, branch to the frame whose label is "WORK."

All these forms can be connected as one large statement by `AND` and `OR`, e.g.:

```
IF 1, AC 5,- 10-15,+
```

```
OR GQ 5 MINUTES 10-15 AND USED SIN 6
```

```
AND IQ LS 50 B:WORK
```

The above examples illustrate only a few uses of PLANIT. In the calculation (`CALC`) mode, these same capabilities can be turned to mathematical subject matter. `CALC` provides a powerful computing capability; arithmetic expressions can be instantly evaluated, mathematical functions can be defined, and a number of stored functions (such as the generation of pseudorandom numbers) and primitives (e.g., `FACT(N) = N!`) are available to teacher and student. If, for example, the student is operating in the execution (`EX`) mode and working on a lesson frame that requires him to perform computation, he may enter the `CALC` mode by typing a left arrow, instruct the machine to perform the desired operation, and receive an immediate answer, as illustrated:

Dialog	Explanation
User: *FUNCTION A(X,Y) = X*Y	Defining of function A(X,Y) to be equal to the product of X and Y.
System: IN	
User: *A(5,4)	Using the function with arguments 5 and 4.
System: 20.0	
User: *A(7,FACT(3))	Using the function with arguments 7 and the factorial of 3.
System: 42	

### current and future uses

PLANIT produces instructional sequences in statistics (aimed at students of the social sciences enrolled in a first course in statistics), spelling and vocabulary (for children three to eight years), and economics (for undergraduates). Agencies who have used or are using PLANIT are: System Development Corp., Southwest Regional Laboratory, Univ. of California at Los Angeles, Univ. of Southern California, Univ. of California at Irvine, U.S. Naval Personnel Research Activity (San Diego, Calif.), New England Educational Data System, and Lackland Air Force Base.

In view of PLANIT's interactive and evaluative capabilities, one can readily employ the system for other applications. For example, it is currently being used in the development of a computer-based vocational counseling program. The language is now more looked upon as one for writing computer human interactive (CHI) discourse, which includes CAI as a subset. The system is now operating on SDC's Q-32 time-sharing system, and will soon be available for use on the IBM 360/65. In the near future, we will be developing PLANIT to operate on an IBM 360/40 or an equivalent (or larger) system that will handle between 50 and 100 students simultaneously. It will be able to operate by itself as a dedicated system, or in connection with an operating system, or under the control of a time-sharing system. ■

# HEAD WEAR TEST RESULTS

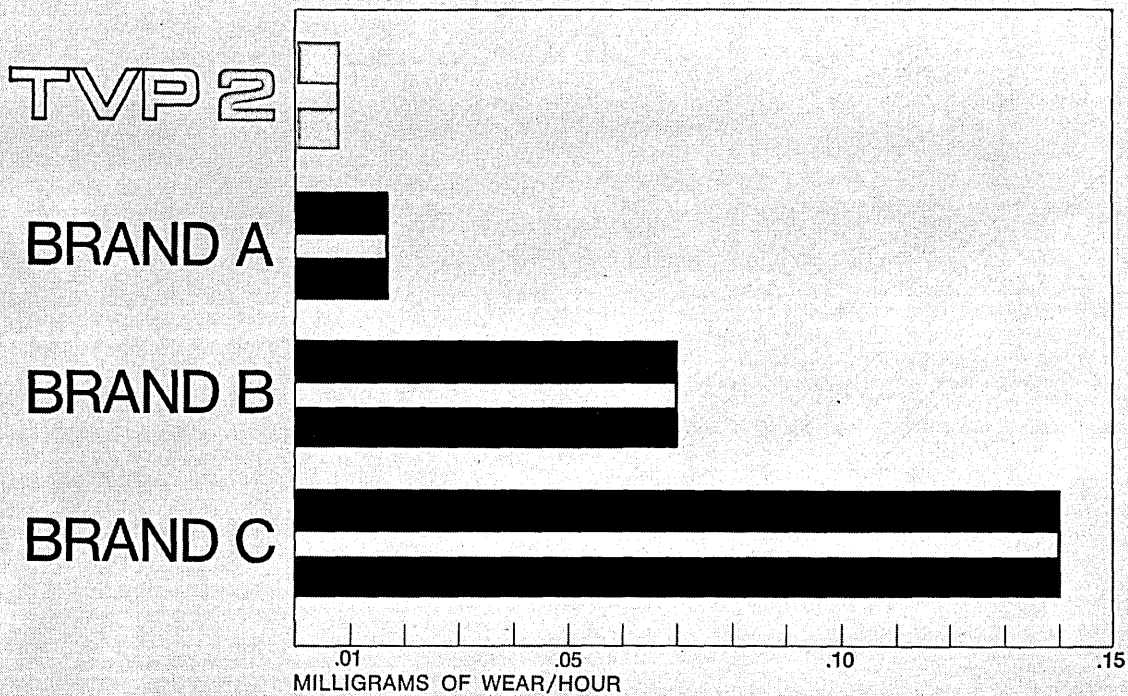

# NOW... pick your computer tape

- Head wear was one of the characteristics measured in a series of laboratory tests conducted recently on three leading brands of "premium" computer tape, and BASF Computron's new TVP2.
- Should the results have a bearing on the tape you choose?
- Perhaps not if there were only small percentage differences in relative wear, but where the amount of head wear can be shown to vary by factors of 2 to 20 times, this becomes significant.
- The replacement of read-write heads invariably means expensive computer downtime, even if you, the user, rent your equipment. Furthermore, head characteristics change when the head wears and your tape can be damaged as a result of changing head surface characteristics.
- We don't suggest that you select your computer tape on the basis of low head wear alone. Pick your tape on the basis of Total Value Performance. Watch for comparative test results on other important characteristics in the months to come.

#### TEST METHOD:

A continuous, 20-meter loop of tape is driven at a constant velocity of 1 meter/sec., with tension accurately controlled within  $\pm 8$  gms. A precision mu-metal disc, simulating the recording head, is cycled transversely across the tape, under constant pressure, thus limiting the contact exposure to any given tape segment. Wear is taken as a measure of weight loss, in milligrams, produced on the disc during a 1-hour continuous run.

Results of repeated trials were found to be reproducible within  $\pm 5\%$ .

## TVP 2

## BASF Computron Inc

CROSBY DRIVE, BEDFORD, MASSACHUSETTS 01730

# COMPUTERS AND THE LAW OF PRIVACY

nowhere to hide

by RICHARD I. MILLER

It has by now become commonplace to observe that Americans leave a trail of records behind from the moment their birth is happily recorded on their parent's income tax return until the day the Social Security death benefit is paid. In addition to such non-governmental files as those maintained by banks, credit services, insurance investigations and the like, county, state and federal agencies have our school records, property holdings, licenses—for dogs, businesses and marriage—military records, income, public claims and court records. They are on file cards, microfilm, punched tape and magnetic storage media. They are scattered through hundreds of records centers in the commercial, governmental, educational and military systems. In an age in which life races ahead of art and science outstrips fiction, little imagination is required to postulate a society in which the record centers speak to one another in a common language. And intuitively the individual feels trapped in the web of his own history.

The reason that the relationship of the computer to the right of privacy is so profoundly disturbing is that it is quite dissimilar to the relationship of any other device or technique to the right of privacy. Unlike the vest-pocket TV cameras, snooperscopes, and sophisticated surveillance devices, the computer does not "invade." It does not look. It does not take blood or analyze body fluids. It cannot even be used as a device to improperly gather evidence. Rather, it stores information that is given to it, correlates it with other information in its memory, and retrieves it at the request of the operator. And because the prospect of a machine which knows all and never forgets fills many with dread, that is quite enough to compel a re-examination of the entire concept of "privacy."

Let us first look at the operations of the computer with respect to that concept. Secondly, let us briefly examine the concept of privacy as it is evolving in American case and statutory law and, finally, propose a few recommendations about how the law may help us to live with the Biggest Brother of all.

## information for sale

The acquisition and sale of data is a lively business: credit, insurance and personnel investigations are burgeoning. Organizations such as Retail Credit Company and Associated Credit Bureaus are unhampered by state or federal regulations. The clerk of court will send a certified copy of any court record for a nominal fee. Large retail credit investigating companies assure clients that any search can be strengthened by drawing upon reports made in previous investigations. Lawyers' services exist to acquire public documents of all kinds. But it is still true that compiling a complete dossier on any individual who is not in military service is a time-consuming, expensive proposition. Therefore, there has been some consolation in the knowledge that a sem-



*Mr. Miller is a senior consultant at Harbridge House, Inc., and a member of the New York and Massachusetts bars. He has also been associated with MIT's Lincoln Laboratory and is known for his lectures and publications concerning the relationship of law and science. He has a BA from the Univ. of California and an LL.B. from Yale Law School.*

blance of privacy is preserved by the inefficiency of methods of data retrieval.

Until now the unauthorized use of data or the redistribution of data was held at tolerable levels, such as the rental and sale of subscription lists. That is changing with the advent of giant computers which increase the investment in, and the value of, personal data. A typical credit file contains a person's address, family status, place of employment, approximate salary, credit income, charge accounts, payment income and even, in the case of insurance company files, medical and hospital records and "moral hazards"—extramarital affairs, homosexuality, heavy drinking or other social observations which could affect the risk. It is no longer a question of "whether" total documentation on the lives of every individual in the country will be quickly and inexpensively available, but "when," "by whom" and "under what circumstances."

It is equally apparent that although public attention has been fixed on a "National Data Center" concept introduced by the Statistical Standards Office of the Bureau of the Budget, the federal government is not the only party interested in personnel data storage and retrieval. Even if, as it now appears, the BOB concept has been aborted by the House Committee on Government Operations and the Senate Judiciary Committee, the rate of personal data distribution is rapidly accelerating in the private sector of society. All too often, a higher standard of conduct is expected from government than from the governed. If privacy can be violated by indiscriminate access to a personnel data center, whose records are not subject to verification, it is as truly violated by a creditor or a litigant as by a public servant. It is not enough to draft regulations curbing the excesses of government alone. Rather, the legal concept of privacy must be woven into a chain of mail which will protect the individual from onslaughts from any quarter.

Computer experts draw a line between (1) statistical information systems and (2) intelligence systems. In theory, the former produces information that only identifies characteristics relating to a group of individuals or "populations," whereas the latter generates data about individuals as individuals. A statistical question might be: "What proportion of the residents of Roxbury earn an income of less than \$3,000?" An intelligence question would be: "What is the income of John Doe?"

There are those who argue that a statistical information system can be designed and administered in such a way that it cannot be used as an intelligence system. They point to the Bureau of the Census, which is legally forbidden to disclose confidential statistical data, as an example. Other experts challenge the distinction and argue that as the speed of computers goes up and the cost comes down, it becomes more efficient to store raw data in a statistical system which can then be probed for intelligence purposes. There must always be at least a coded identity for any longitudinal study. Thus, the earnings of a Roxbury resident in 1968 must be linked to the earnings of the same resident in 1967 to abstract information about earning trends for a sub-population.

To a layman it would appear that if the analyst is satisfied that he has derived all possible statistical information from the raw data, then the contention of separate systems is supported. But there is always a new way to cut the deck. A good analyst is constantly probing his data for novel and useful correlations. The fact that it is easier to do so with the larger machines suggests that the complete separation of statistical and intelligence systems is, at best, a receding goal.

Prior to a famous article in the Harvard Law Review by Warren and Brandeis in 1890, there simply was no legal right to "privacy" in American law. The notion of a concept of privacy was *implied*—as, for example, in the search and seizure provision of the Constitution, in the common law of privileged communications, in the law of trade secret, and of defamation—but the invasion of privacy as a distinct, actionable wrong was not recognized by the courts. It is still not a right which can be simply delineated. In fact, it has been analyzed as four distinct, rather unrelated legal actions:

1. Intrusion of physical solitude.
2. Publication of private matters violating ordinary decencies.
3. Creating a false public image, as by forging a letter attributing to a person views that he does not hold.
4. Appropriating some element of a personality for commercial use without permission.

In each of these forms, the "right" of privacy emerges as a right to be let alone, to be free of prying, peeping and snooping. This is also characteristic of legal subjects in which the individual's claim to a private personality is couched in doctrine other than "privacy." Thus, in search and seizure cases, the Supreme Court recently condemned all sorts of sophisticated electronic, optical and acoustical devices which are used to improperly intercept private communications. It stated in *Katz vs. United States* that "... The Fourth Amendment cannot be translated into a general constitutional 'right to privacy' . . ." but the protection of a person's *general* right to privacy—his right to be let alone by other people—is, like the protection of his property and of his very life, left largely to the law of the individual States.

Legal problems raised by the computer are different. They involve the accuracy or improper use of information voluntarily communicated rather than the improper taking of protected information. As the Court observed in the case above, "What a person knowingly exposes to the public, even in his own home or office, is not a subject of Fourth Amendment protection." Thus, the local laws of privileged communications and defamation are a bit more pertinent to the issue at hand.

In the former case, the law may not compel a party to divulge a protected communication, as between husband and wife or lawyer and client. Although one spouse may not legally restrain another from disclosing a communication, at least the applicable principle is that voluntary communications may be protected because of the relationship between the communicants, rather than because of the way the information comes into the hands of a third party. Defamatory statements are defined as tending to expose a person to hatred, ridicule or contempt in the minds of any considerable and respectable class in the community.

Most of the cases involve a balance of the right to privacy against the freedom of the press. Happily the law does not require a physical intrusion of any sort. But these cases typically involve statements *about* the plaintiff rather than statements *by* the plaintiff. Thus, the courts will enjoin the publication of an unauthorized biography of a private person, but will not even award damages for the publication of a private telephone conversation by one of the parties to it. Yet, this is as far as the common law has developed with respect to the kind of "privacy" which is violated by the computer. If one would look to the evolving case law for protection, it offers scarcely more than a fig leaf.

#### two related problems

Statutory law is developing in two directions at once: we are, at one and the same time, concerned with the growing power of the government to accumulate information and

# We've been had

by Allen-Bradley, Anaconda, Armstrong Cork, Atlas Chemical, Beckman Instruments, Bendix, Civil Aeronautics Board, Eastman Kodak, El Paso Natural Gas, Equitable Life, Ford, General Dynamics, Genesco, Getty Oil, International Industries, the U.S. Marine Corps, National Dairy, Northern States Power, Ontario Dept. of Education, Prudential, Spiegel, Standard Oil of Indiana, Standard Oil of New Jersey, and Texas National Bank to drop a few names.

They like our product. MARK IV. They're using it. It's a ready to go now

general purpose file management system. It works on IBM System/360's, under DOS or OS. It works on a remarkable range of problems. And it saves money. Jobs can frequently be done in half the time or less.

You can buy it outright. Or, if you're a tad skeptical about our claim, you can lease it for a short time.

Another thing, MARK IV isn't a buy-goodbye piece of software. Once you own one, we're there to show you how to get every inch of use out of it. And we stick around to show you other tricks. (That doesn't cost you an extra

dime.) You're also eligible for a chair in a users organization, the IV (that's I-Vee) League where you get together and bounce new application ideas around.

If you order MARK IV now, you'll be surprised how fast we'll have it operating for you. Just contact Gordon Utt. He answers questions too, but unfortunately that takes a lot, lot longer. Business is that good.

Informatics Inc., 5430 Van Nuys Blvd., Sherman Oaks, California 91401 (213) 783-7500.

MARK  
iV FILE MANAGEMENT SYSTEM®

informatics inc.®



CIRCLE 19 ON READER CARD

FOR AMPEX CIRCLE 20 ON READER CARD →

Introducing:

# The catt

It's a completely new computer tape from Ampex. We call it CATT not only because it's Complete-Area-Tested Tape, but also because it's smooth, clean and long lived.

CATT tape is 100% error free when you get it because we test all data tracks for drop-outs, as well as all the space between the tracks. An all new formulation makes the tape wear longer, highly resistant to contamination and redeposits, and greatly reduces headwear. For more detailed information, send your computer specifications to Ampex Corporation, 401 Broadway, Redwood City, California 94063.

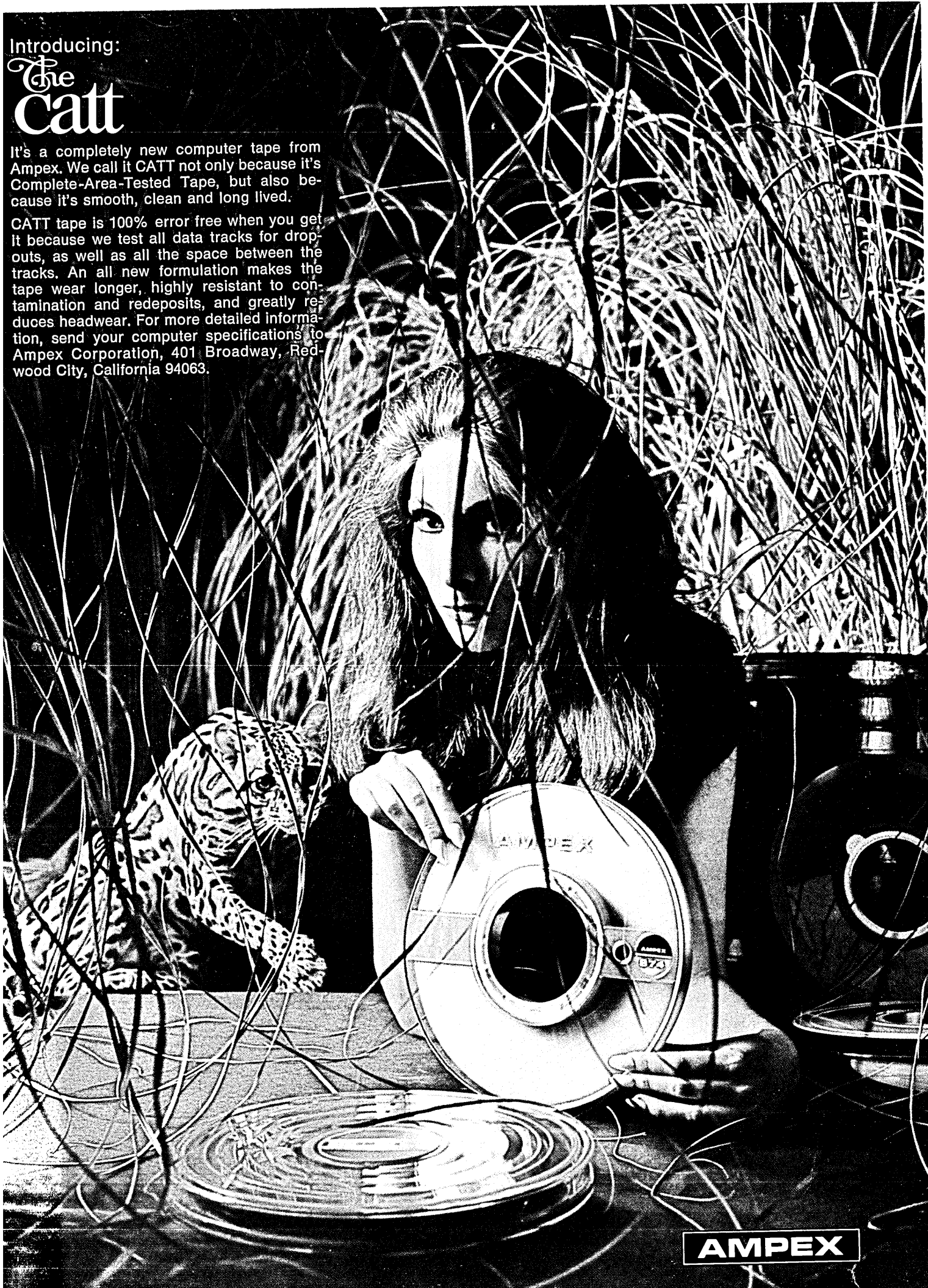

**AMPEX**

PHOTOGRAPH BY [unreadable]

# The CATT: COMPLETE-AREA-TESTED TAPE

Every time your computer stops due to a parity error, valuable computer time (and money) is lost. And at the higher bit densities developed by third-generation computers and the new ultra high speed NRZ formats, the minutest foreign matter can cause costly errors. That's the reason for CATT tape: to assure you the tape you use is 100% error-free when you receive it and that it runs cleaner as you use it.

Tape which bears the CATT label has been fully tested across the entire width of tape on every reel—this means all recording tracks plus all the space between the tracks. During final tests, the tape is recorded and read back at its certified packing density. If a single uncorrectable error or dropout occurs, the entire tape is rejected.



Staggered 9-track heads test Ampex computer tape across the full width of tape on each reel.

## THE CATT: A Ferrosheen® tape that protects heads, prolongs tape life, eliminates errors

Our exclusive surface finishing process not only levels out the microscopic hills and valleys that might cause dropouts, but it also prevents shedding and lowers head wear.

CATT computer tape also bears the trademark Ferrosheen®—an exclusive, controlled, surface finishing process that provides an ultra-smooth surface with a minimum amount of oxide exposure.



## THE CATT: Supercleaned for error-free operation

Just before we package Ampex computer tape, we wash it in an inert fluid to eliminate all surface contamination or loose oxide particles that could cause problems. We call this procedure Supercleaning because it totally eliminates from the tape all foreign matter that could cause costly parity errors.

Ampex computer tape is passed through a special Supercleaning process during final winding.

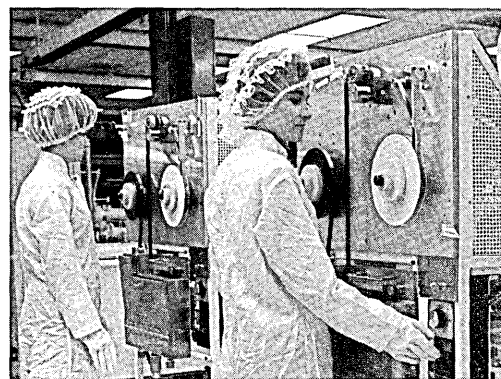

## THE CATT: A new formulation for long tape life and fewer errors

The Ampex new, exclusive coating formulation produces a tough, smooth surface that's highly resistant to the impacting of particles that could become embedded in the tape and cause permanent errors and costly "write skips."

We have run exhaustive comparative tests of computer tape for endurance. Hundreds of thousands of passes have shown that Ampex CATT tape has the lowest error buildup rate of any tested tape. Costly read errors and data reconstruction problems are, therefore, greatly reduced.

Ampex computer tape comes in 7- and 9-track formats, with bit packing densities from 556 cpi to 1600 cpi/3200 fci.

For complete information and specifications, fill out and mail this coupon:

Gentlemen:

Here are some facts about my computer operation. Please tell me more about CATT tape.

Type of computer(s) \_\_\_\_\_

Number of computers in operation \_\_\_\_\_

Type of tape presently used \_\_\_\_\_

Bit density certification \_\_\_\_\_

NAME \_\_\_\_\_

COMPANY \_\_\_\_\_

ADDRESS \_\_\_\_\_

CITY \_\_\_\_\_ STATE \_\_\_\_\_ ZIP \_\_\_\_\_

Mail to: Ampex Corporation, 401 Broadway, Redwood City, Calif. 9406

# Is she for you or against you?



FORTUNA—GODDESS OF FORTUNE

Fortune smiles on those enterprises which are managed best—and the best-managed enterprises today make optimal use of automated Management Information Systems. In designing these systems, Planning Research distinguishes *information* from the *raw data* that formerly took days or weeks of processing to be useful to the decision-maker. *Real* information can now be available in hours or minutes, not buried in voluminous tab runs. You can *manage* with it.

The payoff is increased profits.

When we structure a Management Information System, we examine the total environment in which it will function. We begin by defining the objectives you want to achieve. We survey your organization and define its information needs. We define both the economic implications and the technical specifications of the system. We design it to respond to *all* the people who use it. We select and procure the most effective hardware (we

make no hardware of our own). We select or create the software. We train your operations personnel. More important, we train your users. This total approach ensures that the system arches across your enterprise, interacts successfully with your people, and works with maximum efficiency.

We can do all this because Planning Research is a unique group of professionals. In addition to the computer sciences, disciplines include economics, business administration, behavioral psychology, most branches of engineering, the classical sciences, and mathematics. These disciplines, representing more than thirty areas of knowledge, are skillfully blended on project teams to form the most powerful analytic tool yet developed for the solution of computer systems problems.

To find out how a Planning Research system can let you manage information for your benefit, contact Mr. J. N. Graham, Jr., Vice President and General Manager, Computer Systems Division.

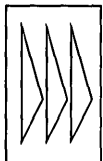

## PLANNING RESEARCH CORPORATION

Home office: 1100 Glendon Avenue, Los Angeles, California 90024

*An Equal Opportunity Employer. Candidates are invited to write to the Administrator for Professional Staffing.*



## AND PRIVACY . . .

keep it from the people, and disturbed lest it disclose information extracted by force of law or voluntarily offered for particular purposes only. So there are "freedom of information" laws to ensure the availability of information and "privacy" laws to inhibit its availability.

To advance the right to know, Congress passed a "freedom of information" law to give every citizen a right to learn what goes on in official Washington. The act theoretically opens the books to all but:

1. Defense classified documents.
2. Federal Bureau of Investigation files.
3. Income tax returns.
4. Patent applications.
5. Executive branch memoranda.
6. Trade secrets and industry financial data.

It is most unlikely that all agencies will readily comply with the law; in fact, it is a virtual certainty that certain records will not be disclosed without litigation. These would include Veterans' Administration records, agency tests of commercial products, Food and Drug Administration new drug applications and Civil Air Board complaint letters, among others. On the other hand, the Department of Agriculture, in an unusually cooperative spirit, announced that it will now let anyone see a thick dossier of the names of all farmers who received more than \$5,000 in government payments during the preceding year. Of particular relevance was the agency's explanation that the disclosure of these records (which theoretically have always been in the public domain) ". . . is not the result of the new law but of the Department's new computer, which for the first time permits a national compilation of farm subsidy data previously available only at the county level."

The other side of the coin is illustrated by the privacy statutes which are springing up to extend the case law noted above. The New York privacy statute, for example, prevents ". . . the appropriation and use in advertising or promotion of the sale of goods (by the use) of another's name, portrait or picture without his consent." Although the interests protected are primarily economic in nature, the trend is towards infusing social and moral considerations in the administration of justice.

### balancing rights and protection

The most important statutory developments affecting "privacy" in the broad, rather than the technical, sense are, of course, those pertaining to the propriety of securing evidence through wiretapping, compulsory physiological examinations, polygraph use by public agencies and the like. In these instances, the right of the individual to privacy is weighed against the right of a society to protect itself against crime. These issues do not involve the disclosure of voluntary communications by the recipient and hence are not directly related to our subject. It is important to note, however, that the areas of greatest statutory activity are not related to the computer's particular assault on our claim to a private personality.

Experience in the product liability field, particularly the design of automobiles, has taught that the law can only effectively regulate technology by controlling its form as well as its use. It is not enough to test, license and control the driver. The law must affect the design of the vehicle itself. The notion of product regulation to protect public interests other than health and safety, such as air and water pollution, is expanding. Let us, therefore, recommend a few technical safeguards which can be built around the use of computers for storing and distributing personal data:

1. Minimal cryptographic protection for transmission lines which carry personal data has been devised and should be utilized so that eavesdropping may be a bit more complicated and expensive than tapping a telephone line is today.

2. Personal data should never be filed in a "clear" state, so that a simple access to storage will, in a sense, open every safety deposit box in the vault at once.

3. Auditing of computer programs that store personal data, to be certain that no programmer has deliberately or inadvertently short-circuited access routes, should become as standard as the audit of bank records.

4. Recording devices should be built into computers to verify and record the source of requests for personal information interrogation.

These suggestions will undoubtedly raise the cost of computers, as seat belts and padded dashboards raise the cost of automobiles, but if one accepts the proposition that computers are destined to play a significant role in our society as automobiles, the time to build in the additional cost is *now*.

In order to extend the legal definition of privacy, it is not necessary to wait for the first defamation cases to arise out of the dissemination of false information in a data center, or the malicious use of true information. Professor Charles Reich of Yale Law School has observed that the authors of the Constitution protected privacy in every way in which it was understood in those times: they protected speech, religion and incriminating knowledge. They protected people against unwarranted search and seizure and forbade the quartering of soldiers in homes. Even the right to bear arms can be considered as an extension of privacy, as then known. Extending their concerns to today's world, should we not consider at least these few modest propositions?

### extending legal rights

First: Any government agency or private individual or firm which gathers personal data from several sources for the purpose of distributing that data to third parties should be required to:

a. Give notice to individuals that such data is being collected about them.

b. Afford access by such individuals to the data for the purpose of verification.

Second: Public authorities should not be authorized to purchase or use edp equipment for the purpose of storing and distributing personal data to third parties unless a satisfactory plan is filed with the highest administrative office in the agency, or a board reporting to him, disclosing the agency's program for protecting the privacy of individuals. It is expected that standards would be gradually created and adopted appropriate to agency operations and equipment.

Third: Public agencies and firms, and their agents and employees, engaged in the business of gathering and distributing personal data, should be liable to injured parties for the dissemination of false data or the knowing transmission of true data for defamatory purposes. The injured party should have a right to enjoin the transmission of such data.

If the observation of totalitarian societies, hospital or prison life, has taught us anything, it should be that an individual's life ought not be an open book—unless he chooses to make it so. Society has a right to demand that the pages be exposed from time to time, but anyone who wants to compile the book by collating the pages and publish the contents without the permission of the author must accept responsibility for its accuracy and proper application. Nathaniel Hawthorne and the Concord transcendentalists observed in the nineteenth century that it was a most serious crime to probe the secret heart. If we fail to protect ourselves against the reach of our own technology, there may well be no secret hearts to probe. ■

# INFORMATION SYSTEMS NEED NURSES

by HOWARD W. RUNCK

In its role of caring for the ill, the American hospital is in serious trouble today. Not only is there an acute shortage of doctors, nurses and medical technologists, but most hospitals are obsolete in terms of physical buildings, equipment, treatment and hospital information requirements. Expanded government programs, population changes and accelerated research projects have added to a situation that almost seems to defy solution. Still another dimension to this dilemma is the hospital information system, with its awesome load of paper work. Yet, the modern hospital is not only committed to the care of the ill, but is expected to improve the quality of this care.

Basically, a hospital information system has several goals. Not only must it collect, record, store, retrieve, summarize and transmit patient information, but it also involves extensive business applications for cost-accounting purposes in payroll, patient billing, inventory and so forth. The amount of paper work in such a broad information system in a large medical center is massive and unwieldy.

Hospitals, governmental agencies and computer manufacturers have been involved in numerous studies to develop computer-assisted hospital information systems. Hospital management first began using the computer in business office applications, but there is an increasing trend toward automation in the storage, summarization and retrieval of patient data. Most attempts to develop a "total on-line system" must be considered experimental at this time, but several large medical centers have demonstrated some initial areas of application.

One of the principal objectives of an automated hospital information system is better patient care for each dollar

they have patients

spent on the system. And when a workable total system becomes a reality, not only will faster and more accurate information be available on patients, but doctors and nurses will be relieved of much of the clerical work that distracts from medical care.

In hospital reporting and record-keeping, an integral role is played by professional staff nurses. The recordings of their observations of the patient are vital to the physician. Their entries of drugs administered and treatments given



*At present, Mr. Runck is the Nursing Coordinator for the Dept. of Nursing, Los Angeles County-USC Medical Center in the development of automated information systems. He holds a BS from Union College, Lincoln, Neb., and an MA in health education from Cal. State at Los Angeles.*

*The art of practical programming*

*traditionally involves*

*three distinct activities. These are:*

*(1) Design & Analysis, (2) Programming,*

*(3) Testing & Documentation.*

*Our COBOL Aids*

*provide substantial savings*

*in each of these specific areas.*

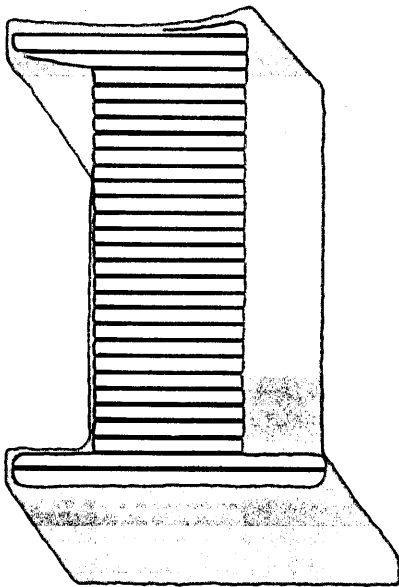

the advanced Decision Table Processor that converts decision tables to COBOL. You achieve computer-independent system definition, improved man-machine communication and the 3-C's of useful and valid system description—clearness, conciseness and completeness.

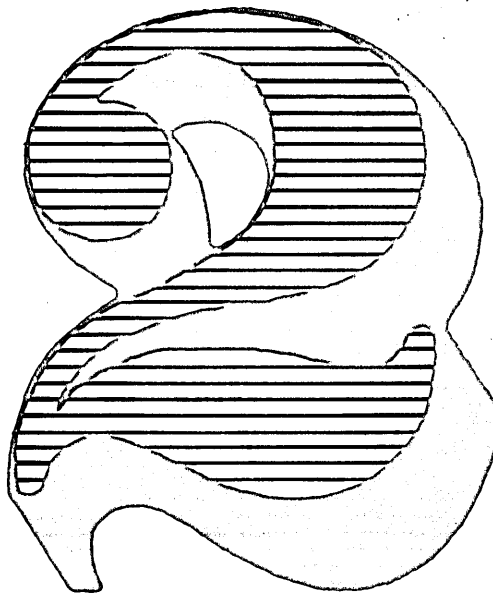

the Multipurpose and Generalized Interface to COBOL. You save programmer time through use of a COBOL shorthand abbreviation and a syntax checker to catch clerical errors, achieve language control by informing MAGIC of your installation's COBOL standard and receive well-formatted COBOL programs as output.

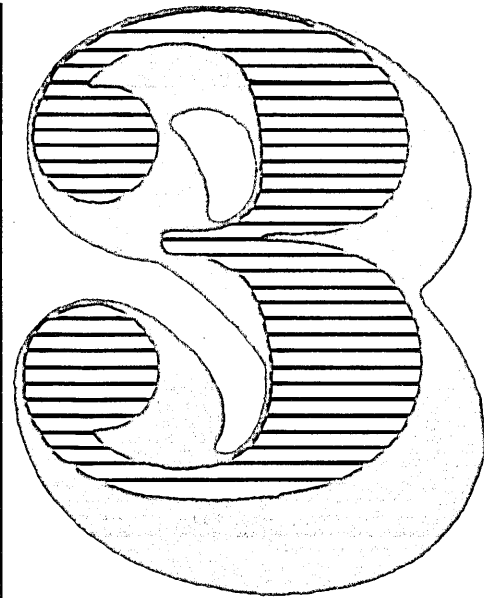

the Test Data Generator that creates all the input files required to check out COBOL programs. You gain an easy, economical method of accurately and thoroughly testing COBOL produced programs with complete user-determined data generation flexibility. TDG significantly shortens the man and machine time required to place a program in production status and gives you greater confidence in its complete operational capability.

**MAGIC** **COBOL**

MAGIC MANAGEMENT INCORPORATED

447 Battery St. □ San Francisco, Calif. 94111 □ 415/981-2645 □ 663 Fifth Ave. □ New York, N.Y. 10022 □ 212/355-7455

## INFORMATION SYSTEMS

### NEED NURSES . . .

are essential. Their ordering of supplies and drugs is necessary to keep the ward functioning. Nurses are the "keepers of the keys" and yet are expected to keep abreast of all medical advances. Ward supplies, diet requests, patient location lists, assignment schedules, medicine tickets and repair orders are but a few of the seemingly endless list of written communications generated from the ward nursing station. Recent studies show that the professional nurse spends from 40% to 80% of on-duty time performing clerical functions.

Ward clerks and ward secretaries have been hired by many hospitals to give some relief to the nurse in this increasing flood of ward paper work. This has allowed the nurse to devote more time to the patient, but certain functions such as medications given and vital nursing observations still require the registered nurse or a licensed practical nurse to make the record entries. Also, the nurse in charge of a hospital ward is usually responsible for writing nursing care plans on individual patients, writing out work assignments for nursing staff and making time schedules. Other areas of time-consuming record-keeping for the nurse involve making anecdotal notes and writing performance evaluations on the ward nursing staff. Even though a nurse has been highly trained in the care of the ill, he or she often must give direction to lesser skilled persons to do direct patient care because of the large amount of time the nurse spends on writing, sorting and retrieving records.

#### by computer

The computer industry has shown that the technical knowhow and hardware are available for automating many areas of hospital record-keeping. However, in applying digital computer principles to complex hospital ward situations, progress has been a rather slow process.

As the automation of hospital information systems increases it is apparent that drastic changes in ward record-keeping and approaches to patient care are inevitable. But it is disturbing to note a lack of participation by nurses in the planning of these changes. Physicians have taken the initiative and are suggesting and demonstrating methods of developing computer systems for use in medical diagnosis, hospital medical records, laboratory analyses, patient monitoring and research. The computer industry has realized the value of these suggestions and many joint projects are being undertaken by systems engineers and physicians. In fact, even ward applications for nursing patient records are being studied by physicians. But what has happened to the nurse? What role does he or she play in developing new patient information systems?

Dr. John H. Knowles, general director of Massachusetts General Hospital, declares, "The nurse has become the central figure on any floor in the hospital devoted to patient care . . . who at the present time has to be all things to all people in the hospital." It seems reasonable to assume that, if the ward nurse is such a central figure on the health team and also has the responsibility of maintaining a large portion of inpatient records, he or she should be the logical resource in defining the feasibility of converting these records to a computer system.

The lack of participation by nurses in this area is not entirely the fault of the computer industry. A large portion of the blame can probably be given to nurses themselves. One reason appears to be that most nurses do not really understand a computer's function in record-keeping. Nor are they united as a group in their acceptance of the com-

puter's role in a hospital information system. It is ironic to note that the area where nurses need the greatest relief is an area they fear most to bring about change. Some nursing leaders have even stated that automation will tend to "dehumanize" their relationship with the patient, not realizing that such assistance by machines would allow them to spend *more* time with patients.

It may be true that objectively automating *all* patient recordings could lead to some "dehumanization" of the patient, but relief in many areas of record-keeping would allow the nurse to spend more time in certain subjective areas of patient observation and recording. For example, the physician's order for medication is an objective communication that is rewritten many times before it is discontinued. The nurse or the ward clerk recopies this order on a "medicine ticket," then in a Kardex entry that summarizes all current therapy the patient is receiving, plus a medication record sheet and often a pharmacy supply order or requisition. A nurse must record each time the medication is given. Added to this, the medication order may be rewritten several times outside of the ward environment for pharmacy inventory control, patient billing and so forth. These multiple recordings come from a single written communication, the physician's order for medication. And each time it is recopied, there is a chance of human error. Diet, activity, and diagnostic requisitions and results are other examples where there is a common flow of patient data to several records from a single source. Random access storage of such data by computer could alleviate a great deal of time spent in recopying.

In providing good nursing care for the ill, the professional nurse on the ward must have direct contact with those patients under his or her charge. From these contacts, the nurse is able to make some judgments as to individual patient's needs. Ideally, the nurse writes an individual "nursing care plan" to best utilize the various levels of skill of the ward nursing staff to meet these needs. But too often, the nurse is kept away from the bedside with other clerical and management duties and such nursing care plans are only superficial, if written at all.

#### most familiar

The reluctance of hospital administration to involve nurses in hospital computer planning is another reason contributing to their lack of participation. By tradition, the nursing profession has been charged primarily with the care of the patient, while others do the planning and manage the hospital operations as a whole. This is as it should be, except for one factor. Which hospital department personnel spends the greatest amount of time with the patients? Who is most familiar with ward operations and patient records? It is obvious the nursing staff and the registered nurse are the answers. By virtue of their vast experience in day-by-day hospital activities, nurses have much to offer. Yet, in architectural planning and initial installation of equipment, nurses are seldom consulted as to which building designs and types of equipment would be most functional.

This attitude by hospital management has been evident to some degree in the design of computerized information systems. Very few of the larger medical centers experimenting with real-time information systems are calling on nurses for consultation. Physicians appear to be the real advocates of automation in the hospital, as evidenced by the many papers and books published on bio-medical research and medical information systems. No doubt the physician is more research oriented than the nurse and is freer to explore new methods in diagnosis, treatment and rehabilitation of the patient. Also, in large university-connected medical centers, research and publication by physicians are not only important to the individual, but are the life-blood of medical progress.

Nonetheless, many of these new methods do involve nurses, particularly in the collection and recording of patient data. Therefore, nurses do need to get involved. In fact, they must! It's a matter of professional independence and survival.

Individual physicians and hospitals have approached nurses for assistance in research projects. But many of those involved in systems development do not realize the valuable experience possessed by the nurse—an experience with patients and patient care in a detailed perspective not experienced by physicians or any other member of the health team. Some recent computer hospital information projects have systems analysts studying and defining manual systems, determining which subsystems of ward record-keeping are feasible for conversion to edp methods. However, the development of a satisfactory real-time system at the ward level has been slow and disappointing. Also, it has been noted there is a tendency by systems analysts and hospital administrators to use ward nurses as the interface between doctor and computer. Thus, the same old system of patient record-keeping responsibilities assumed by the nurse is perpetuated. Even though edp methods have proved to be more efficient and accurate, there is no supporting evidence that the nurse would have more time available for patient care.

### **brighter prospects**

However, brighter prospects are evident at several hospital computer systems projects. Massachusetts General Hospital, Monmouth Medical Center, New Jersey, and Los Angeles County-University of Southern California Medical Center are examples indicating progress toward eventually achieving efficient, real-time hospital information systems at the ward level. One factor in all three projects is the involvement of various hospital department personnel in defining current subsystems and analyzing the feasibility of conversion to edp methods. In other words, instead of systems analysts defining and determining what records to automate, those most involved in manual systems have been doing much of the ground work and recommending to the analysts which records they feel should be adapted to edp methods. Of course, a basic knowledge of computer systems is essential for these hospital personnel to make such determinations.

Los Angeles County-University of Southern California Medical Center, one of the largest general hospitals in the world, has been working very closely with the various hospital departments in providing systems training for the department representatives. This institution is developing a comprehensive, computer-based system that will eventually handle total health information processing requirements for the nine Los Angeles County hospitals, the Bureau of Resources and Collections (County hospitals' billing and accounting system), and other Department of Hospitals agencies.

This edp system is being developed in three stages, with the first stage now in progress. An on-line admissions program, with the automation of patient identification files for the Los Angeles County-University of Southern California Medical Center, is a large part of this stage. With over two million names in the patient files, a DOS/indexed sequential file retrieval system is being tested at this time. The initial hardware includes an IBM 360/40 with a 128K cpu and a series of 28 remote terminals being installed in the admitting areas and pharmacy dispensing points. These terminals are IBM 2260 crt's and IBM 2740 printers.

Patient files are being built on the data bank concept and, as the system moves into hospital service departments such as the laboratory, X-ray, dietary and patient wards,

the individual file will be expanded vertically in separate modules or components. That is, each record of a patient's file can be retrieved independently without retrieving the entire file.

The second stage of the system will see an expansion of remote terminals to all service and patient areas, with 175 to 200 terminals within the LAC/USC Medical Center being in direct communication to an enlarged cpu with more random access storage.

The third or final stage will result in a total system connecting the eight other Los Angeles County hospitals into a central system. Staff members of these hospitals, as well as department representatives at the LAC/USC Medical Center, are involved in the planning now.

This writer has attended a series of basic programming courses at the IBM Educational Center, Los Angeles, as well as participated in the Hospital Computer Center's in-service training programs. The head nurse and some of the staff nurses on a pilot ward have also had special training in edp methods. Even though the hospital has an overall macro-outline for the total system, we, as nurses in this hospital, are doing a large amount of the planning at the ward level, with the nursing department insisting on control of implementing all nursing systems. The Hospital Computer Center and the IBM systems engineers are relying heavily on our judgments and recommendations in this area of record-keeping.

Even though nurses on just one ward were involved in the initial planning of the system, it has not been restricted to a select few. Lecture series, IBM-programmed self-study courses, nursing computer feasibility committees and testing of new forms on a pilot on-line ward are involving all categories of nurses and nursing personnel. The interest in the hospital computer project by nursing personnel is rapidly gaining momentum, with requests for classes and committee involvement occurring at a faster rate than it is possible to satisfy. This department's interest, as well as the interest exhibited by the admitting, pharmacy and laboratory departments, is beginning to have a "snowballing" effect.

### **conclusion**

In conclusion, we are several years away from having an effective, on-line system of record-keeping at the ward level. But nurses at LAC/USC Medical Center are defining data and work flow of records and determining what can be converted to edp methods *now*. And if nurses are to play an important role in developing automated hospital information systems, it is imperative that they follow this example and start planning *now!* Automated patient records will some day be available to even the remotest small hospital in the United States on a time-sharing basis. And with such a widespread impact, nursing service must begin defining its own areas of record-keeping before edp personnel do it for them. In other words, the nurse must lead the edp people in developing automated ward record-keeping systems. Otherwise, there is a grave danger of the nurse becoming handmaiden to the computer, rather than the computer being a means of relieving nurses from clerical functions.

The interest and activity exhibited by nurses at Los Angeles County is but a small measure of what nurses have to offer in the planning and development of a hospital information system. It is true that nurses must become more knowledgeable of computers and unified in their acceptance of them in the hospital. We are making a start at this by publishing several articles in our own nursing journals. But we must let others know, particularly hospital administration and the computer industry, that we have a great deal of knowledge and experience in patient record-keeping—and that we can be of help in the planning of hospital information systems. ■

# meet the 1200 WPM computer tutor

The tick, tack, click'ty clack is missing in this new data communications terminal. It's the Inktronic® terminal. An electronic printer. Another economical answer from Teletype R & D for moving data at high speed.

In a second this new Inktronic terminal can jet 120 characters to the page. Ink jets trace out each image—one by one—through electrostatic deflection. Without wasting time on "fill" characters and buffer storage. You can print one letter, one number, or symbol as readily as a few words or an entire line. And place data exactly where you want it to appear on the page.

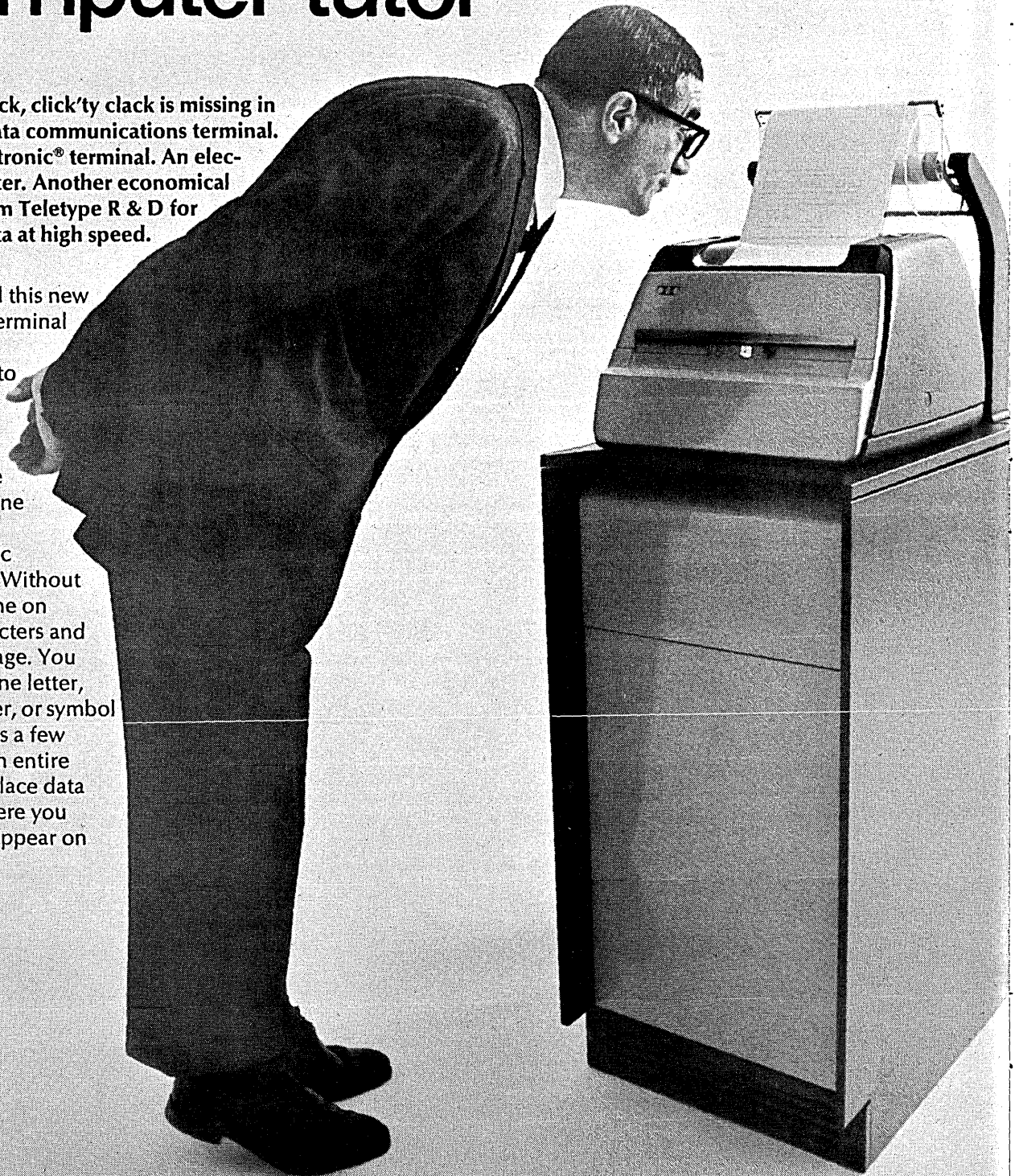

The Inktronic RO (receive-only) set—first of a new line which will include KSR (keyboard-send-receive) and ASR (automatic-send-receive) sets. Future plans call for even higher speeds for complete utilization of voice grade channels.

**machines that make data move**



**Look at it this way (shown half size) . . .**

	1	2	3	4	5	6	7	8
1	2	3	4	5	6	7	8	9
1	2	3	4	5	6	7	8	9

THIS IS AN EXAMPLE OF WHAT THE NEW INKTRONIC TERMINAL CAN MEAN TO YOUR DATA COMMUNICATIONS.

SEVENTY-TWO OR EIGHTY CHARACTERS CAN BE PRINTED ON A LINE

...AND YOU CAN START PRINTING ANYWHERE.

ON THE LEFT	IN THE MIDDLE	ANYWHERE
IN A SECOND, ONE HUNDRED AND TWENTY CHARACTERS JET TO THE PAGE.	THAT'S AS MANY	
LETTERS AS THIS PARAGRAPH CONTAINS.		

	YOU CAN PRINT NUMBERS	12345
		67890

OR SYMBOLS . . . \*%&'()\*!?:/0

IN A CHOICE OF CODE: 5-LEVEL OR ASCII

AND BEST OF ALL, THE INKTRONIC TERMINAL DOESN'T COST VERY MUCH!

```

$$$$$$$$$$$$$$$$
$          $
$      . . .      $
$      . . .      $
$          $
$$$$$$$$$$$$$$$$

```

**High-speed, on-line computer input-output**

The 1200 wpm capability of the Inktronic printer makes it great for computer input or interrogation, especially in time-sharing systems where the line time is so important. And as a computer output device where large volumes of data are needed in a short period of time. It is also a practical machine for monitoring high-speed tape-to-tape systems.

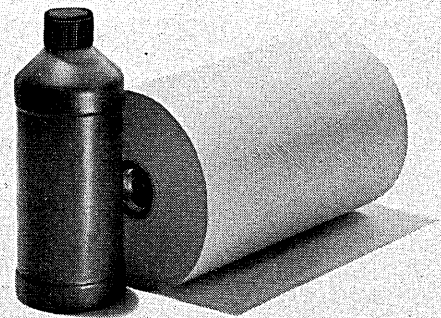

**A few words about ink and paper**

The Inktronic printer uses ordinary teletypewriter paper. *Inexpensive paper.* An 8 1/2 inch wide standard roll provides about 400 feet of space to fill. The ink it uses is inexpensive, too. One pint will deliver about 80,000 feet of data. Of course if you don't fill up every line you stretch the pint even further. With 1200 wpm capability this is an important point to consider. And since no ribbon is involved—impressions are made electrostatically—print is never faded. It's always clean, clear, sharp and well defined.

This highly magnified view shows how ink is drawn through metering and deflecting electrodes to form the image on the page. Ink supply and guidance system has *only one moving part.*

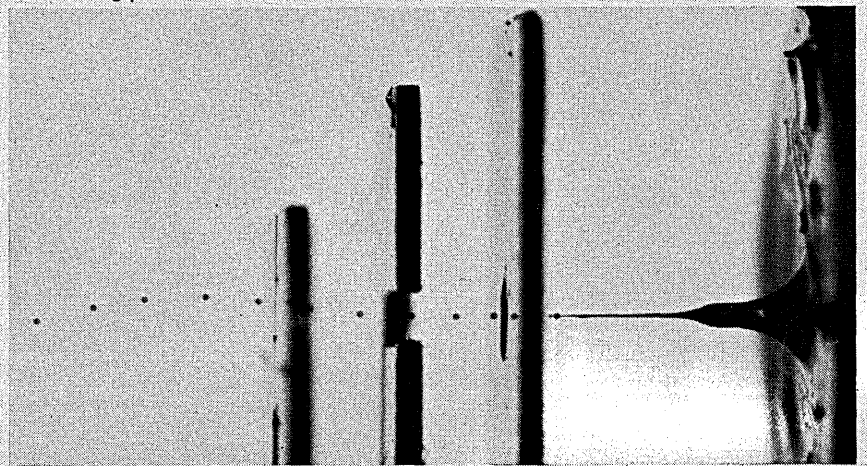

The Inktronic terminal is one of many exciting moves being made by Teletype R&D in *moving data at very little cost.* That's all we're really concerned with. Providing equipment that moves data the way you want it moved. Data you can see, touch, and talk about—data you can move a mile, thousands of miles, or just down the hall. Always quickly, precisely, and at very low cost.

If you would like to know more about the new line of Inktronic terminals, write Teletype Corporation, Dept. 81J, 5555 Touhy Avenue, Skokie, Illinois 60076.

# NEW WIDEBAND DATA COMMUNICATIONS SERVICES

number, please

by ROBERT L. DAVIS

Wideband data services require frequent review and improvement to meet the changing and expanding needs for data communications. This article discusses a major new wideband data service designed to keep pace with these changes, and also considers other new wideband data services being studied.

A new common usage switched wideband data service, called DATA-PHONE 50®, was recently announced by the Bell System. This service is being provided on a three-year trial basis pending FCC approval. A subscriber can now dial a call and send data at speeds up to 50,000 bits per second, a 25-fold increase over the top speed presently being offered in the "voiceband" DATA-PHONE® service. Put another way, a five-hour voiceband data call is equivalent to only 12 minutes of transmission in a wideband data call. As in voiceband DATA-PHONE service, only the local access lines are assigned to individual customers. All other transmission and switching facilities used in the wideband network are shared among all users.

Prior to this service, wideband data service has been available only on a private line basis where transmission and switching facilities are dedicated full time to meet the service needs of individual customers. For many customers, the economies of a common usage switched service can mean significant savings compared to the cost of private line service.

The Bell System has provided wideband data transmission services for a number of years, so that the transmission

concepts are not new. The novelty is in the provision of this common usage switched network. The implications of this will be clearer if we explore the state of the art in wideband data transmission, examine the reasons for a switched service and look at the associated technical and economic problems. With this background, we can take a brief look at



Mr. Davis is supervisor in the data transmission planning department at Bell Telephone Laboratories, Holmdel, N.J., in charge of a group concerned with wideband data planning. He has a BS in electrical engineering from the Univ. of Virginia, and an MS in EE from New York Univ.



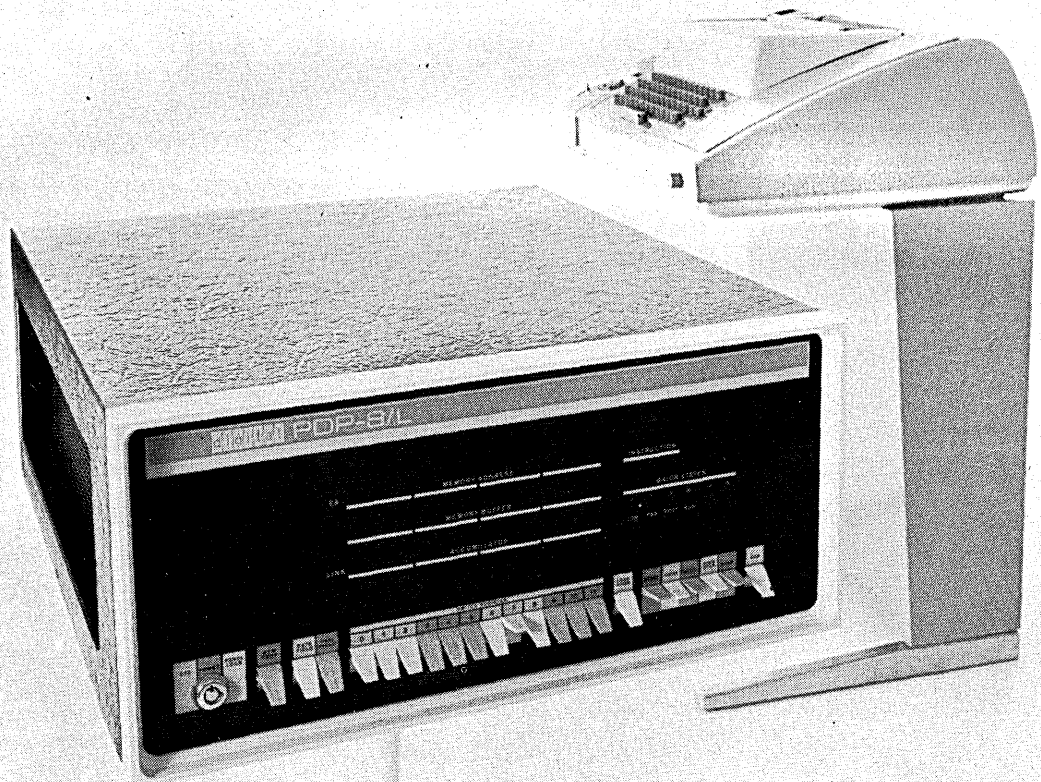

# The world's lowest cost, full scale, general purpose computer. \$8,500 complete.

## PDP-8/L

Complete. With teletype. With software 4096 12-bit words. 1.6 usec cycle time. All integrated circuit. On-line, real-time. Expandable.

PDP-8/L is the latest achievement in the history of a company that introduced the first under-\$100,000 computer, the first under-\$50,000 computer, the first under-\$20,000 computer, the first under-\$10,000 computer.

PDP-8/L is based on the family of PDP-8 machines, thousands of which have been sold and delivered — to scientists in laboratories, instrument

builders, manufacturers of process control equipment, industrial users who have automated their machinery. The PDP-8 family is, without question, the most successful set of small computers ever built. Bar none.

To those of you who have never used computers before, because of price, write to us. A large part of our background is in introducing people to their first computers. We can be extraordinarily helpful.

To those of you thinking of incorporating a computer in another system, or another instrument, write to us. Quantity discounts are available. And our experience includes selling more

computers as built-ins than any other company in the world.

**digital**  
COMPUTERS • MODULES

DIGITAL EQUIPMENT CORPORATION, Maynard, Massachusetts 01754. Telephone: (617) 897-5111 • Cambridge, Mass. • New Haven • Washington, D.C. • Parsippany, Palisades Park, N.J. • Princeton, N.J. • Rochester, N.Y. • Long Island, N.Y. • Philadelphia • Pittsburgh • Cleveland • Dayton • Huntsville • Cocoa, Fla. • Chicago • Denver • Ann Arbor • Salt Lake City • Houston • Albuquerque • Los Angeles • Palo Alto • Seattle. INTERNATIONAL, Carleton Place and Toronto, Ont. • Montreal, Quebec • Edmonton, Alberta, Canada • Reading and Manchester, England • Paris, France • Munich and Cologne, Germany • Oslo, Norway • Stockholm, Sweden • Sydney and West Perth, Australia

## NEW WIDEBAND...

some possible future wideband data services being studied at Bell Telephone Laboratories.

### what is wideband transmission?

Quite simply, wideband data transmission systems displace more than one voice channel in a telephone transmission system in order to transmit data at a higher speed than is practical on a single voice channel.

Why this practical limit on data speed on a voice channel, and how is a wideband channel formed? Voice carrier

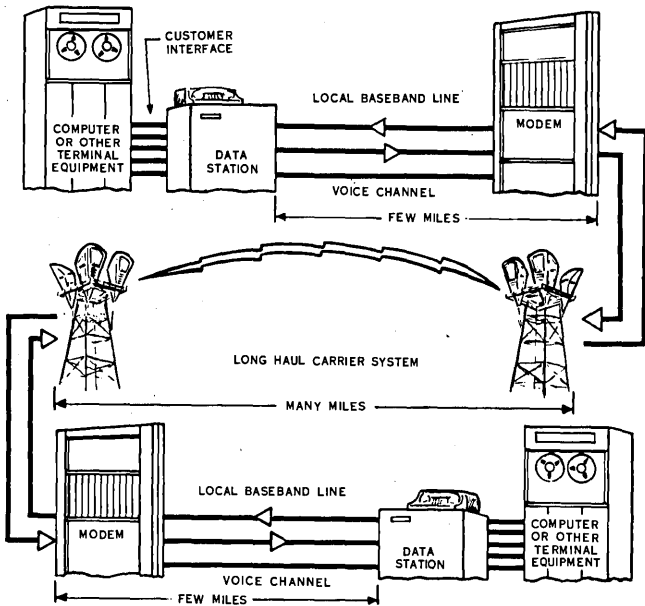

Fig. 1. Typical private line wideband data system.

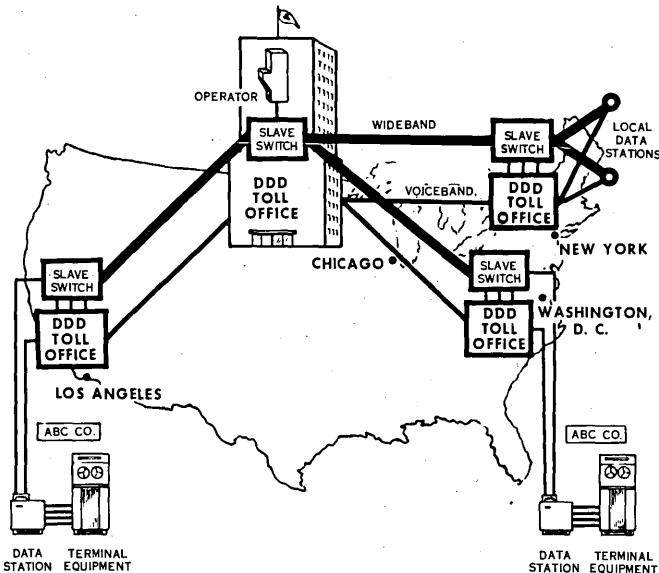

Fig. 2. Initial Data-Phone 50 serving network.

systems stack voice channels in 4 kilohertz (kilocycles) slots of frequency spectrum (bandwidth) in order to multiplex more than one voice channel on a pair of wires. A typical multiplex, called a "group" multiplex, puts 12 voice channels in a bandwidth of 48 kilohertz. An individual voice channel is therefore restricted to less than 4 kilohertz of bandwidth since a small guard band is used between chan-

nels. There is also a noise floor in practical transmission systems. The data power must be kept significantly above this noise power to minimize data errors. On the other hand, the upper power level and the power in each part of the spectrum must be rigorously controlled to prevent crosstalk and intermodulation interference into other voice channels. In practice then, bandwidth, noise and maximum power constraints limit data speeds to the order of 10 kilobits per second or less using voiceband telephone channels. The noise power and maximum signal power constraints are extremely difficult to change. A wider bandwidth is the solution to a significant increase in data speeds. The increased bandwidth is achieved simply by removing a voiceband multiplex, say the 12 channel "group" multiplex mentioned previously, and replacing the multiplex with a data modulator/demodulator (modem) which places the data signal in this wideband slot.

### existing wideband data services

The above techniques have been used for over five years to provide private line wideband data services. A groupband service at 40.8 kilobits per second was the initial standard offering.

Recently, wideband service was broadened to provide a much wider range of speed offerings: speeds up to 50 kilobits per second on a type 8800 channel (groupband of 12 voice channels); and speeds up to 230.4 kilobits per second in a type 5700 channel (supergroup band of 60 voice channels).

Fig. 1 shows a typical point-to-point wideband data transmission system. The data station interfaces with a computer or computer-associated equipment on the customer's premises and conditions the customer's data signals for transmission over telephone plant facilities. In addition, it provides a voice channel and telephone equipment necessary to coordinate the data transmission at each end. A short baseband (not modulated) line brings the wideband signals into a nearby telephone office where a modem modulates the data signal and the voice coordination channel into the proper frequency spectrum for application to a long-haul telephone carrier system. At the distant location, the signal is demodulated in a modem and brought to the distant data station through another baseband line where it is processed for entry into the distant computer equipment. Note that the system allows simultaneous data transmission in both directions.

Point-to-point and switched wideband data services have been available on a private line basis for some time, but a common usage switched service was not available until the advent of DATA-PHONE 50 service.

### the next step

Fig. 2 gives a view of how DATA-PHONE 50 service is provided. Initially, 50 kilobit per second switched service will be provided within and between the four cities of New York, Chicago, Los Angeles and Washington, D.C. in the trial. Transmission and station equipment are generally the same as in the point-to-point service shown in Fig. 1. Switching is accomplished using a wideband switch which is "slaved" to the regular voiceband switching equipment in the local telephone office in each serving city. When a call is placed over the voice coordination channel, the slaved switch sets up a corresponding path for the wideband channel. Local calls are dialed directly, whereas intercity calls are placed with an operator in Chicago (more about this later). All stations will use TOUCH-TONE® calling and except for operator placement of long-distance calls, calls will be dialed much the same as in voiceband DATA-PHONE service.

Briefly, user charges<sup>(1)</sup> for the system are based on a

<sup>(1)</sup> From the trial tariff as filed with the FCC.



# The world's first medium size computer at a small computer price. \$19,900 complete.

Never before has a computer with the power of the PDP-9, the 18-bit word length of the PDP-9, the programmability, the multi-channelling, the expandability of the PDP-9 been available at a price near the price of the new PDP-9/L.

PDP-9/L is a leaner version of the PDP-9, but it's a medium size computer by any standards. Expandable 4K memory, with 1.5  $\mu$ sec cycle time.

Teletype. Standard I-O bus. Eight built-in high-speed data channels. Devices interface directly to the I-O bus by inexpensive FLIP CHIP modules.

And it can be expanded to 32K memory. When you reach 16K, background-foreground programming becomes available. But even the 4K software includes assembler, editor, debugging aids, math package, and utility programs.

If your investigations require a medium size computer, but you simply couldn't afford one before, write us. The new PDP-9/L is designed for you.

**digital**  
COMPUTERS • MODULES

DIGITAL EQUIPMENT CORPORATION, Maynard, Massachusetts 01754. Telephone: (617) 897-5111 • Cambridge, Mass. • New Haven • Washington, D.C. • Parsippany, Palisades Park, N.J. • Princeton, N.J. • Rochester, N.Y. • Long Island, N.Y. • Philadelphia • Pittsburgh • Cleveland • Dayton • Huntsville • Cocoa, Fla. • Chicago • Denver • Ann Arbor • Salt Lake City • Houston • Albuquerque • Los Angeles • Palo Alto • Seattle. INTERNATIONAL, Carleton Place and Toronto, Ont. • Montreal, Quebec • Edmonton, Alberta, Canada • Reading and Manchester, England • Paris, France • Munich and Cologne, Germany • Oslo, Norway • Stockholm, Sweden • Sydney and West Perth, Australia

monthly station and line charge plus a charge of \$.50 per minute for calls under 50 miles up to a maximum charge of \$3.25 per minute for calls over 2,000 miles.

The major computer oriented applications of wideband data service have been the on-line transmission of data by computers and the transmission of information from magnetic tape. Future applications seem to be more on-line computer oriented. Computer load balancing, remote file access, program exchanges and operation with remote wideband terminal equipments will be possible if data transmission is made fast enough and inexpensive enough to meet the needs of these applications. DATA-PHONE 50 service is certainly a move in this direction. Some other services being considered will be discussed later.

### why switched wideband data?

In voiceband data applications, the user can choose between private line service and DATA-PHONE service, depending on distance and data volume considerations. The longer the distance, the higher the data volumes must be to justify a private line service. DATA-PHONE service has typically proven economical where there is not enough total volume of data traffic to justify private line service. Based on the present tariffs, for instance, the economic break-even point for New York to Chicago 50 kilobit-per-second traffic would be about three hours per day. If a customer desired to send data only between New York and Chicago and had less than about three hours (about half a billion bits) of traffic, based on economics alone, he would choose DATA-PHONE 50 service. This is of course only one specific example and many other factors, such as the possibility of data traffic to other points, must be weighed in considering the choice of data services by a customer.

Prior to the introduction of DATA-PHONE 50 service, this economic choice between public switched service and leased private line service had not been available to potential wideband data users. In practice then, only users with relatively large data communications needs could economically justify a private line wideband data service. DATA-PHONE 50 service provides an attractive alternative, especially for customers with lower volumes of data to transmit over long distances. Other users who have been operating at voiceband speeds will also find DATA-PHONE 50 service an attractive alternative.

### initiating the service

The four cities chosen initially are those with sufficient potential data traffic to justify providing the service. As demand grows for switched wideband service, the number of cities served will increase. This in itself will increase the value of the service.

The initial number of trunks (transmission paths) in an intercity trunk group or route must obviously be greater than one to provide a reasonable grade of service, but any more than two would need to be justified by the actual traffic. In fact, to make the cost of providing the service reasonable, the intercity trunk groups must operate at a fairly high occupancy. To obtain a reasonable occupancy on intercity trunks, operator service is provided initially. The operator queues calls on these trunks to keep them operating at a reasonable efficiency and eliminates the need for users to dial many times to set up a call during busy periods.

The increase in traffic on intercity trunk groups will result in a build-up of trunk group size. The efficiency of the larger trunk groups will reduce the need for an operator in

providing a good grade of service. At an appropriate point in time, the service can be converted to full dial operation.

### future wideband data possibilities

Looking beyond present services, it may be useful to speculate on some possible future directions in the wideband data field in both common usage switched and private line areas.

In the common usage switched service field, it is hoped that the costs associated with providing PICTUREPHONE® service will be sufficiently attractive to permit its introduction and widespread use within the next decade. The facilities used for PICTUREPHONE service should be capable of supporting wideband data transmission at speeds of about 1 megabits per second. It is planned to introduce limited commercial PICTUREPHONE service in the early 1970's.

In the private line field a need exists for a lower cost, megabit-per-second speed service for relatively short distances only. One application for such a service would be for use on college campuses or industrial complexes, to tie small computers or human interaction terminals into a large central time-sharing computer. A new type of service under study at Bell Laboratories, called limited distance wideband service, is aimed at this type of application. One of the implementations being explored is the use of an existing digital transmission system called T1 Carrier. T1 carrier was developed as a short-haul voice carrier system to interconnect telephone central offices. Since its introduction in 1961, the 24-voice-channel T1 carrier system has been used extensively in metropolitan areas for the provision of new interoffice telephone trunks in the 10-50 mile range. Data transmission at speeds up to about 1.3 megabits per second could be provided on a single T1 carrier system. For the time being, there may be many applications which could be served by existing T1 carriers on a limited-distance basis. Other techniques of providing a limited distance wideband service are also being studied, but due to its rapid growth since 1961, T1 carrier seems to be an attractive alternative.

One potential application of the T1 system in a limited distance wideband service was explored in recent tests conducted jointly with the American Newspaper Publishers Association Research Institute. In the tests, full-size newspaper pages were transmitted successfully by facsimile techniques in about six minutes at a data rate of 460.8 kilobits per second using the T1 system.

The availability of this service could bring about two significant changes in metropolitan newspaper publishing. First, newspaper composing could be centralized. At present, local copy for suburban editions must be either composed locally or transported to a central location for composing. Second, the cost and time involved in transporting newspapers to the suburbs could be reduced by establishing data transmission to remote printing plants in the suburbs. Also, several suburban newspapers could transmit copy to a centralized publishing plant and share printing plant equipment costs.

In the future, these megabits per second services could be extended in distance by using medium-haul and long-haul digital transmission systems now being planned. The next entry in the digital transmission system hierarchy will be a medium-haul system called T2 carrier, designed to span circuit distances up to several hundred miles. T2 carrier operating at about six megabits per second will carry nearly 100 voice channels per system and should be available in the early 1970's. A digital carrier system for cross-country circuits, which will carry thousands of telephone channels per system, is also being studied. Cross-country digital transmission will not only extend distances that megabits per second data can be sent, but will reduce the cost of providing data services over that which would be incurred if presently available transmission systems were used. ■

**We don't think being good  
is good enough.**

Roytype and Litton Industries  
are partners in developing great business  
supplies—and occasionally some good  
ones.

We're not happy till we make the  
good ones better.

We don't think being good is good enough

**ROYTYPE®**   
DIVISION OF LITTON INDUSTRIES

**Take a good look  
at this label.  
It's on our new "Scotch" Brand  
777GP Computer Tape.**



# should you buy or lease your data sets?

**NOW YOU HAVE THE CHOICE.** Many Rixon modems are compatible with the Bell DATA-PHONE data sets. This gives you the alternative of purchase and helps cut your communications costs. Leasing dollars can quickly add up and exceed the purchase price.

The Rixon FM-18 data set single unit purchase price, for example, is \$444. Leasing the equivalent Bell data set, you exceed the purchase price of the FM-18 in less than 15 months. The lower price of an OEM configuration or other versions cut the pay off period to just a few months. Once your initial costs are covered, you can regard the set as being free and you're free of monthly leasing costs.

Rixon data sets are available in a variety of configurations. You can select either PC card modules for OEM installations, rack mounted versions, or packages designed for desk and shelf mounting. To the basic modem you can add options, such as clock for synchronous transmission. We also offer data sets for data transmission above 2400 bps.

Write us for our data set catalog. It will help you to answer the question of whether to buy or lease your data sets.

Rixon Data Set	Maximum Speed	Line Requirement	Common Carrier Equivalent
FM-300	300 bps	Type 3002 Channel	Bell 103
FM-18	1800 bps	Unconditioned	Bell 202D
PM-24B	2400 bps	C2 Conditioning	Bell 201B
PM-24C	2400 bps	C2 Conditioning	Bell 207

**RIXON ELECTRONICS, INC.**  
2120 Industrial Parkway, Silver Spring, Maryland 20904 301-622-2121  
Rixon is licensed under patents of Western Electric Co., Inc.

From 3M...

# “Scotch” Brand 906 Disk Packs

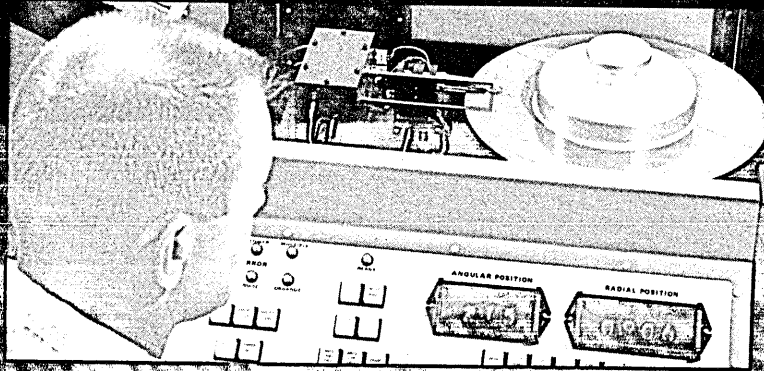



# DEC'S TIME SHARE-8

 Digital Equipment Corp. thinks it has come up with the dream system of time-sharing utilities and computer-hungry schools. It's a small general purpose time- and resource-sharing system that can handle 8-24 users; offers the ability to use several languages, including machine and assembly language; can be interfaced with the PDP-10 and other large t-s systems, and is said to be cheaper than anything on the market. Price ranges from about \$55,000 for a basic system to over \$150,000 for a large multi-peripheral configuration.

Yes, it's the PDP-8, modified and called the TIME SHARE-8. The first system, 8K version, will go out this month to the Lexington, Mass., school system. General deliveries begin late fall. And soon thereafter a PDP-8I version will be offered at about \$10-\$15,000 less.

Although DEC envisions uses for the system in every industry, Norman Doelling, market manager for education, sums up the primary market this way: "It is conservatively estimated that time-sharing utility sales are currently running at about \$75 million annually and increasing at a rate of about 50 per cent a year." The 8, he says, will expand this market further by opening it up to small groups of businessmen and programmers with less capital than now required. Further, it will supplement the systems of larger utilities. In education, Doelling notes that "today only the nation's largest universities have their own time-sharing systems, and more than 400 educational institutions have purchased varying amounts of time from commercial time-sharing utilities." Now, he implies, almost any school can own a system.

These are the basic configurations:

1. At the low end, an 8K (12-bit) word cpu (1.5 usec cycle) with 500K-word disc, communications interfaces for data phone and Teletypes, including the DEC 680 communications system operating in simplex or duplex mode, and a 300 cps paper tape reader. Said to handle 6-10 users simultaneously (degradation in user patience depends on application). The executive system occupies 4K core, about 4K more resident on disc. The user program is executed in the remaining 4K of core. No capability for handling additional peripherals. Cost: about \$55K.

2. 12K-word cpu with same peripherals. Handles 6-10 users. Additional 4K is for monitor, permitting addition of tapes, card reader, and other peripherals, and resource-sharing them. Basic cost: over \$60K.

3. 16K-word cpu with same peripherals as above, plus paper tape punch. Handles about 24 users, with 32-user maximum. Additional 4K is for swapping in second user, while first program is executed. Basic system cost: about \$67K. The \$150K configuration would include the basic system above, plus 300 card/minute reader, 300 lpm printer, eight DECTape transports (and controller), four 500K discs (with controller), and a data channel multiplexer. Other peripherals available on the larger systems include storage tube crts, plotters, and standard mag tape units.

## some limitations

The credibility of the system is best viewed first in terms of its limitations. Obviously, it will only run those problems which can be done in 4K of core, plus about 32K of disc storage. There's no overlay scheme, and the software it uses—from the PDP-8 and thus compatible with it—has been written for a system with this storage allocation. It offers

two FORTRAN compilers but the user can't do much "number-crunching" in this space. Other software includes PAL-8 and PAL-D, DDT (dynamic debugging technique), FOCAL (Joss-like language), MACRO VIII, and a text editor; BASIC will be available about December.

DEC is, however, working on 24K and 32K systems, which will probably provide the additional core in blocks of 4K to permit swapping in more users or will split up the user core into 8K blocks. The latter would permit use, say, of an 8K FORTRAN.

Too, one time-sharing expert feels that the 16K and larger systems would be the most viable, since the smaller versions would be hamstrung by no look-ahead capability (swapping in the second user while the first executes) and, in the case of the 8K system, having much of the monitor on disc and lacking peripheral-handling capability. DEC agrees that the business community may find this to be true, but feels the educational institutions will more readily accept longer response time for lower cost and the unique features offered by a system of this size.

## a choice of languages

So much for major drawbacks. As said, DEC is touting the machine as one which will permit a user to employ several languages—including machine and assembly language for production of his own compilers and programs. This is a capability that only the larger t-s systems, like PDP-10, SDS 940, and Project MAC have offered, says DEC. It is accomplished through I/O transfer traps in hardware (long used on many machines, but not on one of this size), which permit the user to work at this level while protecting other users and the monitor from destruction. The monitor will not let the user go outside his 4K of core, although he can self-destruct (with monitor notification) if he tries to do this. ("Suicide, not murder," quips Doelling.)

The TIME SHARE-8 has a "simple" command language which permits the user to call up any compiler and any of his files or a list of them, to indicate "save" or "not save" on a program, to issue executive commands, etc. Other important features are that the user does not have to re-compile a program each time, since the system will store both source and object code. There is also a file protection scheme which permits the user to mark his program in many variations to be read or read and modified by only himself, by a particular group (such as his firm), or by all users.

Another good feature is the capability for two or more terminal users to converse with the computer on the same problem at the same time. The 8 also permits resource-sharing and, in this connection, the user can call the operator to have him mount a DECTape or standard mag tape for his use. The monitor contains an accounting system which will log the user number and cpu and connect time.

Scheduling on the 8 system is on a "round-robin fair basis." In other words, each user is allotted an equal time in core, and if not through, he will be bumped to the end of the queue and receive the same amount of time the second pass through. Response time with 16 users on is estimated at about one-three seconds for trivial commands, but such figures must vary from installation to installation depending on use—and its importance is really measured in how impatient the user gets, waiting.

One time-sharing aficionado's opinion of the DEC specifications: "For me, if they can do it, the system at 16K (core) is a lot of machine for the price." ■

# name,

Ampex has it! — A quarter of a century of excellence and leadership in the magnetic recording field is behind us. We introduced the first professional audio recorder, first videotape recorder, first commercial digital recorder. We also introduced the single-capstan tape drive which gives users in the computer field freedom from excessive downtime and tedious adjustments. The latest entry in the digital field from Ampex is the TM-16. It combines accrued single capstan knowledge with new features that assure the system user of optimum performance-to-dollar ratio in his system.

# design,

The TM-16 features a computer-compatible tape path and improved tape handling to assure compatibility between machines with minimal dropouts. Electrical adjustments have been reduced to an absolute minimum and interface compatibility with previous members of the Ampex family is assured.

#### THE TM-16 HAS ALL THESE FEATURES

- SINGLE-CAPSTAN DRIVE
- COMPUTER-COMPATIBLE TAPE PATH
- LESS THAN  $\pm 1$  MICROSECOND DYNAMIC SKEW
- MINIMAL SPEED VARIATION
- CLOSED-LOOP CAPSTAN SERVO AT NO EXTRA CHARGE
- SPEEDS FROM 75 TO 150 IPS
- IN-CHAMBER, SERVO-CONTROLLED REWIND, TO ASSURE UNIFORM TAPE PACKING
- 200, 556, 800, & 1600 BPI

# mtbf.

The TM-16's technical excellence assures you of maximum reliability with virtual freedom from non-predictable downtime. This will substantially reduce your service costs and expensive callbacks.

If you're looking for increased data performance, you'll want to find out more about the new TM-16. Write today for our fact-packed brochure: Ampex Computer Products, 401 Broadway, Redwood City, California 94063.

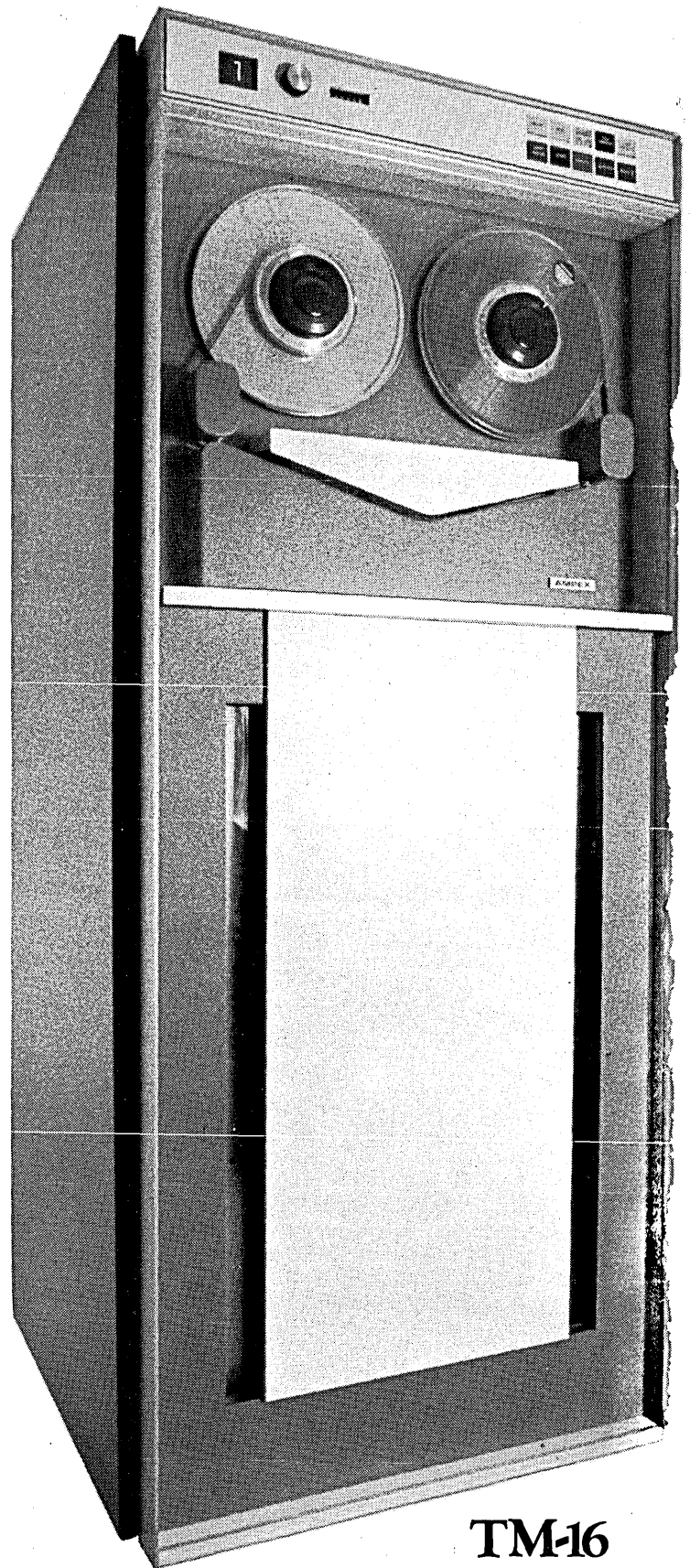

TM-16

**AMPEX**

**DATAMATION**



# news scene

*an interpretive review  
of recent important  
developments in  
information processing*

## **McCALL FIRST IN LINE IF COMSAT GETS ITS SATELLITE PLAN APPROVED**

If the Federal Communications Commission approves the Comsat proposal for a pilot domestic satellite program, McCall Corp. is hoping to have use of a full channel for tv programming and data and graphic (editorial copy) transmission. McCall is said to be the first to apply to the FCC for one of the 13 wideband tv channels that would be available under the experimental five-year project, due to be operational in 1971 at the earliest.

Both the proposal and the application involve a number of "ifs." Actually, Comsat made the application for the two-satellite program over a year and a half ago. An FCC spokesman could not say when a decision was due (observers say year-end), except that the conclusions of the report of the President's Task Force on Telecommunication Policy would be a major factor.

This was started in August 1967 and was due out in mid-August 1968, although it was rumored to be two to four weeks late. Should the approval come, because this is an experimental project aimed at establishing the uses, costs, and problems of domestic satellite transmission, it may not be subject to all the restrictions and decisions that a full-scale satellite program will require. For example, channels on the international satellites must be obtained through international common carriers, except for "authorized" users, such as the Defense Department. It is possible that the domestic channels may fall under similar rules, but not necessarily for the Comsat experiment. Ground station ownership is another question that must ultimately be decided, but Comsat has offered to build and operate the stations as a trustee for the pilot and permanent programs until ownership is established. The pilot is limited to 30 ground stations in the pacific and mountain time zones.

In any case, since there are several other satellite and land-line proposals before FCC, McCall feels that if Comsat is permitted to launch the experimental birds, it will be a "big leap forward" for them toward a full-scale effort. And McCall wants to help dem-

onstrate the great economic breakthrough afforded by satellites for tv and data transmission. In its application to the FCC, McCall has stated it wants direct access to the channel through Comsat, and not through a common carrier licensor like AT&T. William Schubert, McCall senior vice president of planning, estimates that if Comsat runs it and is permitted the normal FCC-determined rate of return, the cost of wide-band transmission could come down on the "order of 20:1." (Should AT&T or any other carrier be licensed to rent lines, the rates will have to be coordinated with land and microwave rates and would undoubtedly be higher.)

### **the plan**

McCall's computer-related plans are as follows. A division, McCall Information Services Co., already has computer centers in California and Ohio which involve facilities management for commercial firms and dp operations for the Univ. of Dayton and a consortium of colleges in that area. Expansion of these activities is planned. Experiments would involve computer-computer transmission of service bureau data, education projects such as computer-assisted instruction, and ultimately perhaps transmission of general reference information from a data bank to the home.

Through its Graphics Research Lab in Princeton, McCall has been using the Videocomp phototypesetting system with a Spectra 70 computer and has developed special keyboard-to-tape units for transmission of copy from editorial offices to the computer (for hyphenation, justification, layout, etc.). Ultimately the publishing house envisions a central computer facility which would receive editorial data and transmit coded copy via satellite to Videocomp units located in the firm's nine printing plants.

Mr. Schubert provided comparative figures on graphic transmission costs over 3,000 miles of Telpak D and satellite (should Comsat have full ownership):

Under Telpak D, it would take 90

minutes to transmit 150 pages with 33.66 megabits/page over a 960 KH bandwidth at 920,000 bits/second. The Telpak D rate is \$45/mi./month; and for 3,000 miles, the cost per minute (20 hours a day, 30 days) is \$3.75, or \$337.50 for 90 minutes of point-point transmission.

For satellite cost, McCall has computed on the basis of a 12% return to Comsat on 13 channels, or \$20.8 million revenue/year. Channel cost would thus be \$133,000/month or \$3.70 minute, about the same as Telpak D. But over the 5 MH bandwidth of a tv channel, a tv scan would be at the rate of 30 pictures a second, or 15.75 megabits/second. Based on 33.66 megabits in a page, it would take 5.32 minutes to transmit 150 pages and thus cost \$19.68.

### **figures not set**

It should be emphasized that these figures are theoretical, based on the 12% return and the idea that Comsat would have full ownership and lines would be directly accessible from it, rather than another common carrier. They also do not include land-line or microwave costs from the ground station to the final destination (as there will not, of course, be ground stations at all locations). Even so, there is a \$217.82 difference between Telpak D and the minimum satellite costs for the bulk of the transmission distance. This provides some idea of the economics of satellite transmission even at five or more times the minimum cost. It also gives an idea of the impact such rates would have on other carriers should Comsat have full ownership—and of the ferocity of the battle the common carriers would wage if Comsat achieved it. (AT&T has an interesting conflict, owning part of Comsat.)

To summarize this confusing situation, the experimental project is to show what satellites can do. It *may* be approved without final settlement of major issues of ownership, licensing, etc., to expedite the experimenting. McCall is the only one to apply so far and feels it has a good chance since it can demonstrate so many vital applications of the system. Should there be a great number of applications for channel use, an FCC spokesman said it is doubtful that any one user would be given permanent and exclusive access to a full channel. According to Comsat, other firms in the computer and other industries can petition the FCC to participate, but FCC advises that they wait until a decision is made on the project. —ANGELINE PANTAGES

## ECONOMIC DEVELOPMENT COMMITTEE SAYS CAI COSTS PROHIBITIVE

A recommendation for the creation of a commission on research, innovation, and evaluation in education, and the conclusion that the cost of large-scale use of computer-assisted instruction in public schools is prohibitive at this time, are contained in a report on education by the Committee for Economic Development.

"If computer-assisted instruction were to be extended to the 16,000 school systems representing the bulk of the nation's public school students, the annual costs could range from \$9 billion to \$24 billion a year." The total public school expenditure for 1967-68 was only \$30 billion, according to the report, making the cost of CAI "too large an expenditure in relation to possible benefits."

The report, "Innovation in Education: New Directions for the American School," covers instruction in elementary and secondary schools, and broad-brushes the area of audio-visual and computer-based aids. It was issued by the Research and Policy Committee of the CED, which is a non-profit organization comprised of 200 businessmen and educators.

The committee established costs for CAI based on the use of two modes:

"A *drill-and-practice mode* built around a central processing unit serving 1,200 students daily through 200

terminals, at an annual rental of \$480,000. Programs are relatively simple, involving a set of repetitive exercises dealing with one learning event with which the student is already familiar. One hour of software costs about \$5,000 to produce and \$35 to rent. Assuming a reasonable mix of rental and production of programs, the annual software cost would be about \$765,000 versus \$20 million for hardware rental after discounting for cost reduction through mass production. About \$6 million for other services would also be required, making a total of about \$27 million for the 100,000-student system.

"A *tutorial mode* built around a cpu serving only 210 students daily through 35 terminals at \$210,000 per year. Programs are relatively complex, involving a combination of programmed instruction and drill-and-practice, with the additional capability of random access. One hour of software costs about \$30,000 to produce and \$210 to rent. With the same assumption as for drill-and-practice, annual software cost would be about \$5 million, hardware rental about \$50 million and other services \$17 million for a total of about \$72 million."

In discussing CAI, the report noted, "Only a gradual acceptance of computers in instruction is realistic and

then on an experimental basis, especially since this technology is rapidly changing." But the committee expects that "costs will be brought down in this field" soon, opening the door to broader use of CAI as experiments to demonstrate its capabilities and potentials for education.

The committee found that large-scale use of tv in the schools, ranging up to \$1.5 million, "can be accommodated within the present range of expenditure," however. The report concludes, "We strongly recommend that broad-based studies be made of the costs and benefits that can be expected if the various technologies involving audio-visual equipment, television, computers, and other devices are applied to instruction in the schools on a wide scale."

Toward this end and other educational developments, the committee proposed "the creation of a Commission on Research, Innovation, and Evaluation in Education, established under charter by Congress as an independent, nongovernmental agency . . ." In its research function, the commission "should project studies to determine areas of needed research and should coordinate research activities in the interest of economy and adequate coverage." In the area of innovation, it "should encourage the schools in innovative and experimental activities . . ." In evaluation, it "should authorize and fund appropriate evaluations of the product of the schools and the effectiveness of innovation in improving that product." —F.B.N., A.P.

## FRENCH INDUSTRY PREPARES FOR "OWN WAY" FOURTH GENERATION

CII—Compagnie L'Internationale pour L'Informatique—will display its new P1 computer this month at SICOB (the equivalent of the American BEMA show). It's supposed to be the first truly French computer since the government gave up on Bull, allowing that company to be sold to an American firm.

The medium-scale core-memory business machine will probably offer few surprises or breakthroughs. CII, the company formed under *Plan Calcul* (an ambitious government-backed five-year program to develop a viable French computer industry) still isn't ready to develop products significantly different from IBM's.

But in the long run, CII and its parent company—CITEC (Compagnie pour l'Information et les Techniques Electroniques de Controle)—hope to be able to develop their own design

philosophy. "Now," says CITEC president Robert Remillon, "we produce SDS computers or those close to the IBM philosophy. So far we have gone with computers not completely incompatible with IBM."

But, says Remillon, that will change: "We will take our own path . . . be one of the three or four companies in the world with our own way."

### r & d program underway

The ability of CITEC and the French to select their "own path" will depend to a great extent on the results of research and development in components, now six months along. The French government will be pumping around 700 million francs (roughly \$140 million) into R&D for computers, peripherals and components, with the latter two receiving about 100 million francs apiece.

The convergence of the results of the three-pronged R&D effort should occur some three to four years from now, according to Remillon. But he admits that timing may determine either ". . . success or turning back to the standard philosophy of another company." That latter disagreeable alternative, he suggests, would mean "entering into agreements" with other companies . . . a path he has unsuccessfully pursued in the past with ICT and other European manufacturers.

Right now, computers made under a licensing agreement with Scientific Data Systems account for approximately 50% of CII's sales volume. But the licensing agreement is scheduled to end Jan. 1, 1970 . . . with another two years allowed to fulfill commitments.

That date (end of 1972) coincides neatly with the end of the five-year *Plan Calcul*, which hopes by that date to see a national computer industry strongly under way. The date also coincides with M. Remillon's target

**JEEPERS, MR. SMEDLEY—MY OWN  
NATIONAL PROGRAM DOCUMENTATION  
KIT! YOU SHOULDN'T HAVE!**

**TUT, TUT, DEAR BOY!  
I'VE SEEN YOUR  
PROGRAMS—  
I HAD TO!**

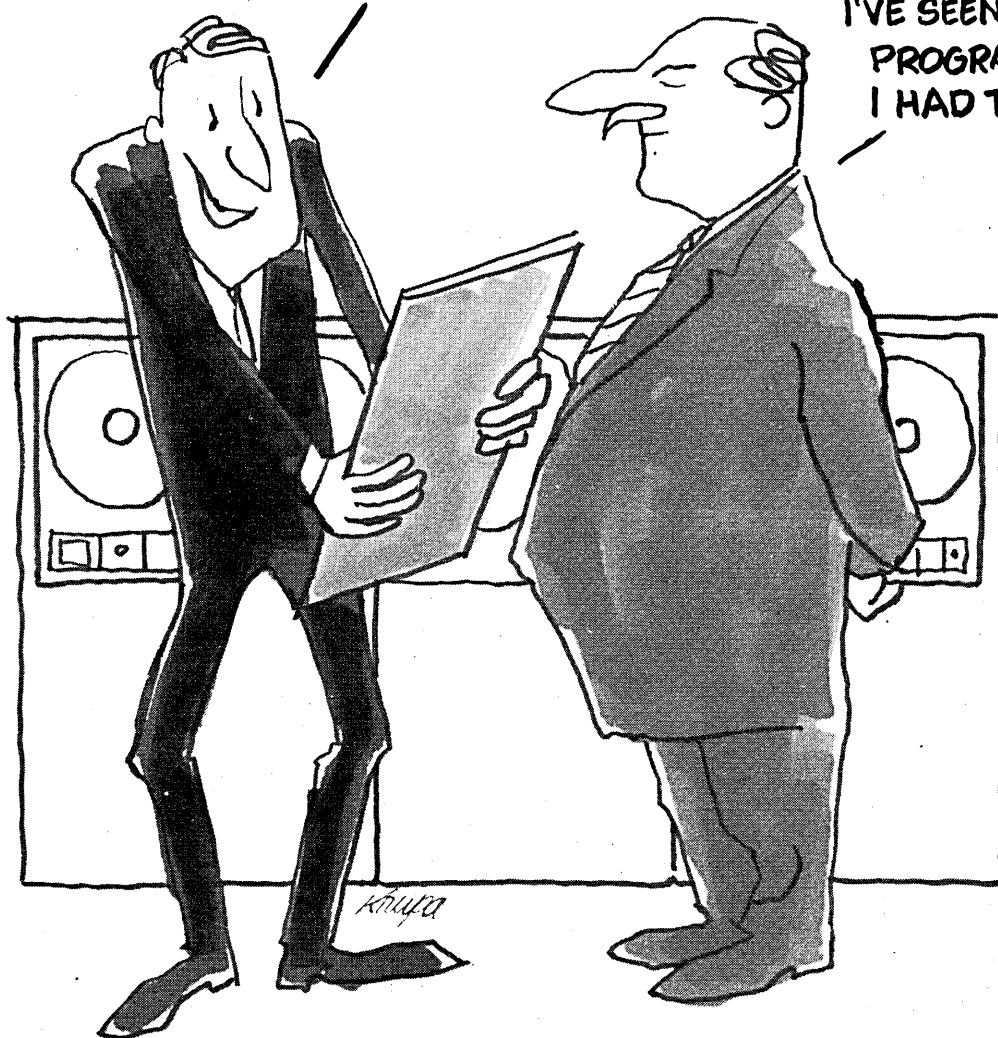

**Designed especially for programmers, the new National Program Documentation Kit holds all working elements you need in a compact, neatly arranged form: listings, source information and control cards. Protects and houses each individual program. The kit consists of the following:**

- Genuine pressboard data binder in Pacific Blue with styrene channel and nylon posts.
- Clear vinyl documentation envelope with three pockets in front to hold control cards, tapes or notes and a large pocket in back to hold the documentation folder.
- Documentation folder with copper reinforced indexes. Removable so program documents can be kept confidential.
- Indexes for listings with Mylar\* reinforcing.
- Pressure sensitive labels for quick, easy identification.
- 65 pre-printed insertable titles plus blank inserts for special needs.

\*Mylar is the DuPont name for its brand of Polyester film.

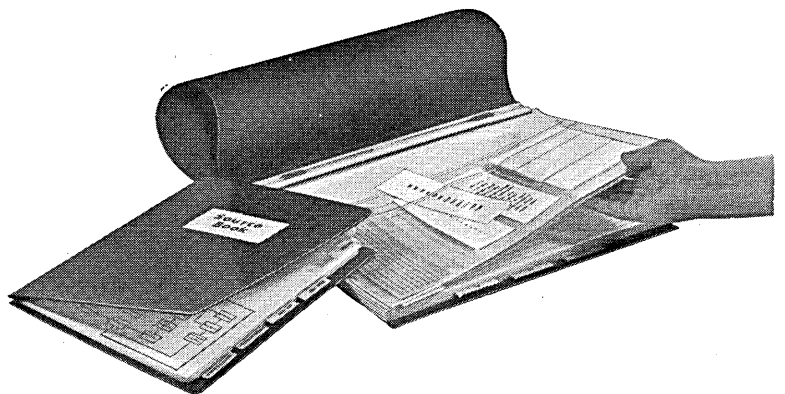

	<b>NATIONAL BLANK BOOK COMPANY, INC.</b> HOLYOKE • MASSACHUSETTS • 01040 NEW YORK CHICAGO LOS ANGELES ATLANTA DALLAS SAN FRANCISCO		
	Please send me complete information on your "Products for Programmers."		
Name _____	Title _____		
Firm _____			
Street _____			
City _____	State _____	Zip _____	

is  
this  
SCERT®?

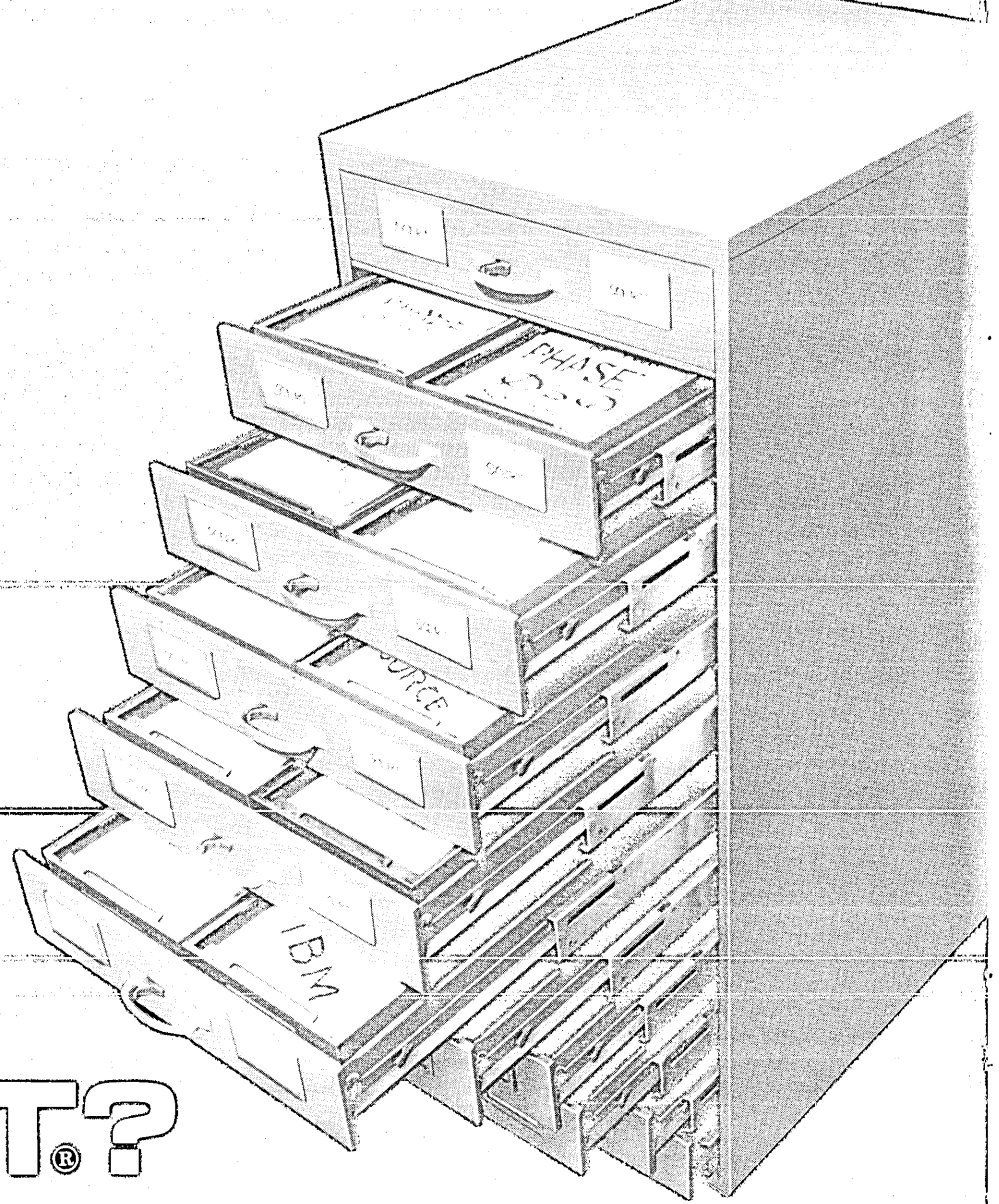

Yes, and more. As the industry's accepted standard for simulating computers and their associated software, a card file really doesn't seem very dignified, does it? Especially when the results SCERT\* produces are so very sophisticated.

That's why SCERT usually travels in the more dignified form of disc or magnetic tape. They're much more manageable than the 42,000 cards containing the 50,000 program steps of SCERT. Then, when you add the 2,500,000 cards of our factor library, (everything worth knowing about any computer) you start to get an idea of the power SCERT provides as a management tool.

SCERT builds a system model, integrates your processing requirements with computer capability, then simulates to determine cost and performance . . .

now you "change it," "compare it," "measure it," and then decide. This is SCERT!

SCERT lets you see ahead by taking a closer and more organized look at where you are right now! Look at your new system designs, manufacturer selections, hardware/software configurations, system efficiency, and see what you really have, at both management and technical levels.

SCERT provides an objective and detailed profile of your total involvement, identifying any element of chance you would risk in making a change, or failing to make a change.

Ask the computer manufacturers, or the leading firm in your industry about SCERT. They use it—SCERT . . . the accepted standard.

\*Systems and Computer Evaluation Review Technique

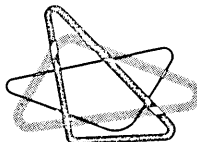

COMRESS

2120 Bladensburg Road, N.E. Washington, D.C. 20018

Offices: New York, Los Angeles, Chicago, Philadelphia, Pittsburgh, Boston, Ottawa and London

## news scene

date for development of a non-me-too systems design philosophy.

### the P-series plan

In the meantime, CII will follow the P1 with a P3, a scientific/business machine with time-sharing, multiprogramming and multiprocessing capabilities . . . probably fitting in somewhere between the 360/65 and /75. And, presumably there will be a P2. The P-series will range from around \$40K to \$3 million.

The series as now envisaged does not include a P4 . . . a number-crunching supercomputer being "discussed" at IRIA (Institut de Recherche en Informatique et Automatique), the research wing of *Plan Calcul*.

The selection of a medium-scale business system as CII's initial venture was the result of a compromise. The government wanted to start out in business data processing . . . to in-

crease the efficiency of its own services and because they think that's where the rewards lie.

Assessing its experience and strengths, CII wanted to kick off with a real-time system for scientific, industrial and military markets. Such a machine would match the experience and size of their marketing staff (about 1000 strong now). Certainly they wanted to avoid the small-scale business machine rat-race.

But, points out one observer, the compromise lands them smack in the middle of the most crowded market of them all. CII will now lock horns not only with massive IBM, but with Burroughs, Honeywell, ICL, Philips, RCA and Univac . . . to name only major contenders.

And if the P1 is no more than an interim me-too machine, it may not sell well enough to enable the company to forge ahead on its "own path" for the fourth generation . . . or to encourage the French government to pour more francs into hardware development.

—R. B. F.

ready begun compiling the directory and expects to complete it in the first half of 1969. The directory will cost about \$500. Other services that may be offered are a weekly updating service, a machine-readable master file "designed to facilitate the conversion process in individual banks," and a daily updating service primarily for other financial service organizations. S&P has already spent about \$1 million on development of the service, but its rewards will come in the myriad of services that it will be able to offer as a central repository for this information.

### certificate standards

The NASD is developing the broker identification and confirmation numbers. The standard for the physical size of the certificate is being developed by the ABA Security and Imprinting and Processing Task Force, which contains representatives from the exchanges and other areas of the financial community. Certificates have been of varying sizes and contain different information and type styles. Standardizing format means the chance for machine-reading—and that's what it's being designed for. The task force investigated current optical scanning technology to determine ability and cost of reading certificates in 8 x 12 inch size (this is standard for NYSE certificates). Three of seven OCR companies responded that they could provide page readers at costs ranging from .5 to 1.2 cents per document, with a fourth, Cognitronics, offering remote service at 4 cents a document. All seven, however, could handle a punch-card size document at a higher rate and lower cost. This size document is probably what will be adopted, if the exchanges concur.

Such a certificate may contain the CUSIP number, certificate number, shares or principal amount, date of issuance, stockholder's id number, a control number and possibly other data. Certain fields of the card would also be reserved for punching of limited information—providing some mechanization benefits to smaller firms that cannot justify OCR equipment.

Also being investigated is a magnetic layer in the punched-card certificates for encoding the information, which would help secure the document against counterfeiting. This development, of course, would open up a new market for OCR-equipment makers, when one considers the several thousand brokers, transfer agents, and registrars involved in the transaction process. It is conceivable that some of these tasks could be undertaken in central facilities, such as the New York Stock Exchange Central Certificate Service, which is providing computer-

## NEW STANDARDS TO HELP BROKERS GET OUT FROM UNDER THE PAPER MESS

Wall Street critics say the brokerage community has been unbearably slow to move an eye off the quickly spewing ticker to the serious problem that has afflicted them in the back office. So slow in fact, that a few houses have suspended operations or closed their doors, while others have been driven into merger talks.

It is taking the warnings of the Securities and Exchange Commission, strong advice from the exchanges, the leadership of others, such as the involved banking community, and indeed the fear of extinction to make all the houses take a more serious look at automation as something other than the source of glamour stocks.

The problem is most exemplified by the "fails" (inability of a broker to deliver certificates to buying houses within a five-day period), which have reached billions of dollars because of the paperwork logjam. The ultimate solution to the problem is automation of the whole security transfer and accounting process.

In this context, the recent adoption of a standard number for security identification by major forces in the financial community is a very significant—but long-range—move. It is the first of several steps toward standards, which include development of a standard-size certificate (probably punch-card size), a standard broker identification number, and a broker confirma-

tion number. These standards are all due to be completed by early 1969.

### identification numbers

It was late in July that the New York and American Stock Exchanges, the National Assn. of Securities Dealers, the Assn. of Stock Exchange Firms, Investment Bankers Assn. of America, and the American Bankers Assn. all endorsed the uniform security number and the plan for automating securities handling.

This first standard had been developed over four years by the ABA-established Committee on Uniform Security Identification Procedures (CUSIP). It is composed of eight numbers—six to identify the issuer and two for the particular issue. The number will be applied to about 30,000 individual issues of stock, bonds, and other securities of 22,000 corporate issues; 500,000 to one million issues of municipals, originated by up to 40,000 issuers; and U.S. government issues and the most actively traded foreign securities.

Standard & Poor Corp.'s subsidiary, Standard Statistics Co., has been awarded the contract to compile directories of these issues, and will operate under the CUSIP agency. This agency will be under the wing of the ABA and directed by a board of trustees consisting of 15 members of the financial community. Standard Statistics has al-



# What has sixteen legs, eight waggly tongues and costs you at least \$40,000 a year?

Eight keypunch operators that one Digitek 70 will replace—and then some. This optical scanning system costs only \$30,000 and is a better, faster and more accurate way to feed your computer. It simply eliminates keypunching.

This versatile system reads pencil marked (original) documents at the rate of 2500 per hour and transfers information directly to magnetic tape—ready for the computer. The Digitek 70 not only saves labor, time and space, it also reduces errors, speeds the movement of data and adds to the efficiency of your whole computer operation.

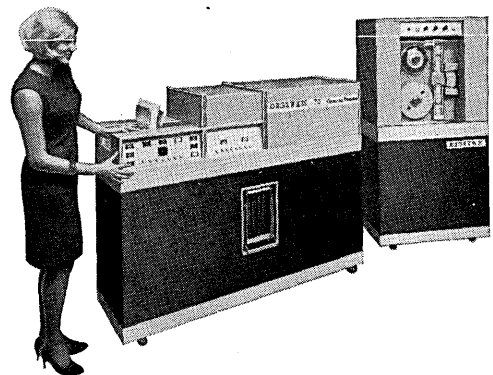

Keypunching can account for as much as 35% of the total cost of your computer operation and up to 90% of time delays. We'll be happy to tell you how the Digitek 70 is solving this important problem for others.

Write today for information on this and other Optical Scanning systems that read a variety of hand- or machine-printed source documents.

## OPTICAL SCANNING CORPORATION

Newtown, Pennsylvania 18940 Phone (215) 968-4611



## news scene

ized transfer of stock ownership for member firms.

Another effect of the change of the certificate will be on the manufacturers of such certificates, such as American Banknote and Security Columbian Banknote Co. If the standard is adopted, it means a change of operation for each, and the chance for other firms to come forth and bid for the business.

The ultimate goal, however, is the certificateless society, if stockholders can be convinced to forego the pleasure of holding a piece of paper (it's almost like getting people to give up money). This would result in no handling of paper, but a completely automated flow of the transaction from brokers, transfer agents, and registrars.

## HOW I LEARNED TO STOP WORRYING AND MAKE BUNKER-RAMO A SUCCESS

When a major company shows a net loss of over \$12 million in one year, as Bunker-Ramo did in 1965, comes back with a \$1 million profit the next year, triples that the following year, and then combines with a company three times its size, it seems reasonable to think that the man who took over as president during the dark days had something to do with this.

So we asked Dr. Milton Mohr how he did it. Mohr has a rather modest office in one corner of the Canoga Park facility. He looks like a real company president—balding, bow tie, medium size, quick-moving—a pre-computer, pre-Texas-company president.

For example, why did you cut off the process control operation? Didn't you have about half the market?

"Yes, but there's no margin to it. You get snared in the customer's business and start taking on systems problems without getting paid for it. After they get the computers they want to use them for other jobs too."

What about the machines already installed?

"We're supporting them. In fact, now everybody likes the 30. You remember that small, fast machines were coming along then and that's what everyone wanted. That's why we had to go out and get the DDP-116. And then it looked like we would have to go ahead and design machines to keep up. We'd have to get all the way into the computer business or get out. But it was already a big loss area.

"We still have some enthusiasts around here so we looked at it again

This is, however, placing faith in the infallibility of on-line systems.

### a long wait

In any case, it will be at least five years before most of the certificates are changed over to the standard size and numbering system. In the meantime, the brokers must be content with interim measures to curb the fails and ease the paperwork: closing one day a week, cutting down on some transactions, as in the cheap \$5 stocks, and other practices. Strangely enough, a very few service bureaus have expanded Wall Street operations to rescue the brokers. Automatic Data Processing, which has over 25 customers now and many more "banging on the door," is opening up another center, and according to one broker it has a market for 300-400 more clients in this community. —A.P.

about six months ago . . . I still think we would have to go all the way into the computer business and we're not going to do that."

Doesn't numerical control have some of the same problems?

"Some . . . but you don't get involved in systems too much . . . you don't have to try and solve all the customer's other problems. In process control, every installation turns out to be unique. It's not that way with numerical control. Also, the market is mostly straight sales. Now the tool machine manufacturers are getting involved and we can sell directly to them.

### furniture factories need help

"You know, an interesting market for numerical control is furniture factories. They're just getting into it. I went into this place where they had a machine automatically cutting out a design in a piece of wood and a guy was standing up to his knees in sawdust frantically trying to get the next piece of wood clamped down in time for the machine to start on that while another guy was shoveling sawdust out the door. We can help these people. They need a vacuum cleaner, for one thing."

But when the losses were piling up, did the Defense Systems Division come in for any cutting?

"We reduced annualized costs by about \$2½ million there."

How?

"Took out a layer of management. They did \$33 million last year, ought

to do about \$43 million this year. We stopped off-the-shelf computers there too."

"What if the war ends?"

"Well, we don't make bullets and shoes or other disposable items. The defense division should continue to do better. We work on data handling for strategic and technical systems."

We turned to more pleasant topics and Mohr demonstrated the Telequote 70, the latest version of Bunker-Ramo's on-line display terminal for financial houses. It sits on one end of his work table, silently reporting stock exchange sales and quotes as soon as they happen in New York and elsewhere.

"When we first brought out the Telequote III, the market estimate was 4,000 desk units. There are already 15,000 installed and we're turning out 60 a month."

This is one of the products of the Business and Industry Division and it's tied into the Telecenter in New York, said to be the largest on-line financial data bank in the country.

"There was a time two years ago when the financial people wondered how long we'd be in business. We hadn't introduced any new products. We put in a system at Reynolds [the brokerage house] and it just didn't work. We used the technological resources of the whole company in order to assist in the solution of that program and it is now operating completely satisfactorily."

Will the recent trends in communications regulation, such as the Carterfone decision, help this kind of on-line data handling?

"There are obviously forces at work to make the telephone company just supply pipes for communication. We're making progress . . . when the group was called Teleregister, they had to go through punched tape at each end.

"Business and Industry should be the division with the best growth. But at first we *increased* the costs there—bringing in high quality systems people and raising salaries. We have a major installation in New York, about 500 support people. And we're looking into other kinds of services—hospitals now . . . industrial automation . . . industrial processes . . ."

Mohr paused to think about that.

"Maybe we'll get back into process control in another way."

### Amphenol merger effects

What will be some of the effects of the Amphenol/B-R combination? (Amphenol is a substantial company, with sales in 1967 of \$163.7 million. Noted especially for connectors, it's pretty thoroughly diversified in electronics, textile products, instruments,

electrical signs, CATV cable, microwave components, etc. And it has operations in Canada, England, Germany, Belgium, France, Mexico, and Japan.)

"Well, the old Bunker-Ramo was barely in this volatile technology. But Amphenol has a solid production base and a good marketing and distribution set-up. With the technology we have here . . . we can help develop products that can be marketed better through Amphenol outlets. Also, I see a real possibility for expansion through Amphenol's foreign operations."

With these prospects in mind, Bunker-Ramo is now planning new facilities in Westlake Village—a new industrial/residential community even further out in the San Fernando Valley that is being built from scratch, including the lake, and is also the new home for Burroughs' peripheral products manufacturing.

On the way out we asked Dr. Mohr why his company badge said "temporary."

"Oh, I lost mine somewhere and had to get this one this morning. The 'temporary' has no significance."

It was announced July 24 that Dr. Mohr has been promoted to chairman of the board. —BILL ROLPH

DATA DUMP

late afternoon

After such storage, what retrieval?

Returning, should one generate flowcharts of perfected fury, update stale inventories of mortified remains?

One could draw up sub-routines of shame or fetch hostility magnetically encoded: biting bits of addressed argument randomly accessible to blame.

But then this twilight time-sharing of binary griefs too long revived means combat in a graveyard hand to hand or brawling in a sewage sump of filed decay. The system broken down.

Display of those late facts at data terminals would make them worse.

The better program calls for conduct more strategic that does not iterate the built-in wrongs and put through pain.

It means instructions from some fresh design bypassing memory, avoiding loops . . . new algorithms aiming, through division's end, at some long overdue net gain.

—SAMUEL IRVING BELLMAN

The DAC 300 Series ACOUSTICAL COUPLERS

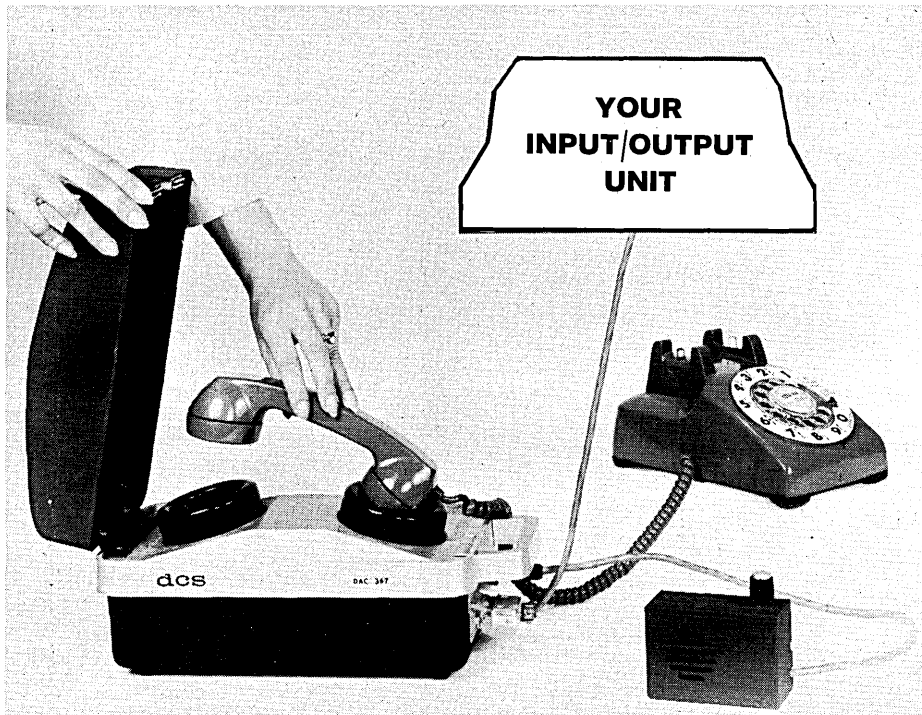

The DAC 347, originate-answer model, or the DAC 337, originate model, couplers readily connect any conventional telephone line to your input and/or output terminal device.

Second generation integrated circuits in a unique logic makes possible superior rejection of unwanted signals for error-free operation.

A separate circuit monitor speaker allows the operator to audibly monitor transmission when the coupler is operating. This adds to: ease of operation, reliability and convenience.

des

DATA COMMUNICATIONS SYSTEMS, INC.

4230 CENTRAL AVE. N.E.  
MINNEAPOLIS, MINNESOTA 55421  
(612) 788-9295

# news briefs

## CAN AT&T AND WU FIND HAPPINESS IN THE RUINS OF THE WU/CSC ENGAGEMENT?

In May, University Computing Co. tries to buy 10% of Western Union's stock.

Within days, Western Union and Computer Sciences announce merger agreement, resulting in the end to the UCC effort.

In August, AT&T announces that it will halt the negotiations on sale of TWX to Western Union until it can determine the shape of the firm after merger and how it will affect TWX customers.

Western Union and CSC immediately agree to end merger efforts.

AT&T "reappraises the situation" and announces resumption of negotiations.

This chain of events has kept the industry in a whirl of speculation. The merger was most definitely not a ploy to keep University Computing from buying into Western Union, according to a WU spokesman. It was a serious effort evidenced, he said, by the tremendous amount of work from May to the end of July, when a voluminous proxy statement on the merger was submitted to the Securities and Exchange Commission. Very simply, the major reason for the merger halt was that Western Union could not afford the prospective loss, or at least the long delay, of the TWX acquisition, which would add an estimated 45,000 TWX subscribers to the Telex network. The latter alone has 25,000 subscribers and is grossing \$40 million annually for WU.

Too, the merger apparently was taking much longer than the two firms expected. Technically, the Federal Communications Commission would have to approve, as would of course the New York State Public Service Commission and the Internal Revenue Service. Then there were the vague questions of how the merger of a common carrier and a computer services company would impact the issues of the FCC communications/computer inquiry. And if the merger would take many months, the suspension of AT&T talks could obviously run well beyond that and possibly never be resumed, barring FCC intervention.

The TWX negotiations have been

going on since early 1966, the result of a recommendation in the October 1965 report of the FCC's Common Carrier Bureau. Both firms say it has taken this long to iron out the complex technical details of the transferral of the service (lines, terminals, concentrators, maintenance). WU intends to expand its Telex switching system to accommodate TWX. The rate structure and selling price are other issues. Where the talks stood at suspension was not revealed; Western Union sources have been saying since at least last fall that the finalization was "imminent."

Whether the CSC merger could be resumed after and if the TWX negotia-

tions are settled is not known. "Anything can happen," says a WU spokesman, emphasizing that the break for now is definitely final. The original agreement had called for the exchange convertible preferred stock of CSC for each two shares of Western Union held. The preferred stock was convertible into 1.54 shares of CSC common on the basis of \$65 a share of CSC common. Since the latest developments, the prices of both companies' stock have slumped.

## RECOGNIZING THE END OF THE TUNNEL

Recognition Equipment, Inc., which has combined record growth with record net losses, shows every sign of finally turning the corner.

The company has been supported from the beginning by faithful stockholders—snapping up recurrent new issues. Meantime, REI turned in red ink reports. Samples: a \$2.9 million loss in '66; a \$3.7 million loss in '67. For the first half of this year, however, the loss is down to \$364K—although the company notes that they have had

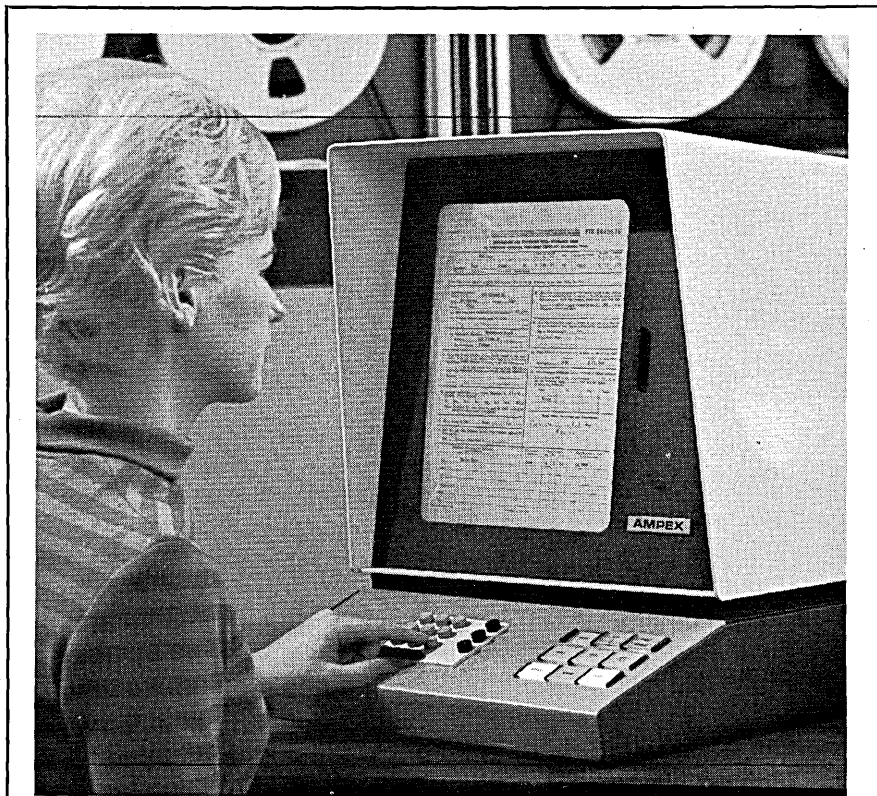

## INSURANCE COMPANY GETS VIDEOFILE FOR POLICY RETRIEVAL

The Ampex Videofile, which has been a slow mover in the marketplace (it was announced about three and a half years ago with ample hoopla), now seems to be fully launched. One of the first, at Southern Pacific in San Francisco, was recently demonstrated for the press and the company now has 10

orders, totaling about \$10 million, for the unusual system. It uses television recording techniques to record the content of paper documents on video tape, retrieves by display or hard copy reproduction. This one is at American Republic Insurance Co. and will deal with about 15,000 documents per day.

## news briefs

an unusually large number of outright purchases of their Electronic Retina Computing Reader and Bar Code Reader/Sorter.

But the company, not known for rosy predictions, now expects to show a profit by the end of this year and during '69. The reasons are substantial orders from oil companies and other big credit-card users, plus success with the huge postal banks in Sweden, Germany, and the U.K. As a further faith-in-the-future note, REI is doubling its plant size, has increased employment by 200 in the last few months to 1100, and just bought another piece of land—106 acres—for later expansion.

### KUBIE AND REYNOLDS LEAVE CUC AS PROFITS SLUMP

The sudden resignation in July of Computer Usage Corp. founder/president Elmer Kubie and of Carl Reynolds, president of CUC's biggest subsidiary (Computer Usage Development Corp.) came as a surprise. But the tipoff may have appeared in a May 1 note to stockholders, which admitted unexpectedly high second-quarter losses for subsidiary Computer Usage Business Services and same-period revenue "substantially below anticipated revenue and profits" for CUC.

The note concludes: "Corrective action is being taken, and it is hoped that we will return, reasonably soon, to our past pattern of profitable growth."

Kubie founded the pioneering software firm in 1955 with John Sheldon (who has since resigned), but has seen it bypassed by such brash newcomers as Computer Sciences Corp. (formed in 1959, CSC grossed \$37 million); Computer Applications, Inc. (grossed \$18.8 million first six months of this FY). Even late latecomer (1966) Computing & Software Inc. grossed \$12.3 million in its last six months, compared to \$7 million for CUC for the same period (ending Mar. 31).

CUC did not release specific second quarter figures, but first half figures revealed that the second quarter did not match up to first quarter performance. And their latest quarterly report had this to say:

"During the third quarter, each of our operating subsidiaries failed to meet its profit objectives, resulting in an over-all loss to CUC. We have recently instituted a definite plan of action that will provide a more economic use of our existing facilities. It is hoped this plan, together with our intensified marketing and recruiting activities, will return us to a profitable position at least by the first quarter of the fiscal year beginning October 1."

A comparison, then, of the two nine-month periods showed income up to \$10.7 million from \$9.9 million in the '67 report, but net down to \$154K from \$411K (58¢ vs. 20¢ a share).

Nevertheless, CUC and Kubie make it clear that his resignation has nothing to do with recent financial results. For several years now, Kubie has expressed a desire to teach high school physics. The plan was delayed until the company reached \$10 million . . . and again until additional financing could be secured.

The resignation of Reynolds seems unrelated to that of Kubie. Reynolds, former 360 software manager who joined CUC in February '66, evidently resigned over his failure to achieve certain policy and organizational changes. Reportedly, he resigned before he was aware that Kubie had found a successor to whom he felt he could turn over the company.

What Kubie sought in a successor, according to reliable CUC sources, was a man who combined general executive and management ability (with profit and loss responsibility experience) and marketing experience.

They chose Charles Benton, 55, first president of IBM's Federal Systems Division. After a successful tenure as manager of FSD, Benton was also given federal government marketing responsibility for IBM. He combines, it is said, an enthusiasm for the future of the software industry and CUC's role in it.

### SPERRY RAND SAYS UNIVAC IS THE REAL NUMBER TWO

The inference by the "other computer company," Honeywell, that it is number two in the business apparently stimulated Sperry Rand into breaking out the revenues of the Univac Division for the first time.

The revelation that Univac had grossed over \$451 million in fiscal '68 (ending Mar. 31) places this firm ahead of the Honeywell computer group (calendar '67: \$207 million). Neither company provides computer activity earnings, although Sperry claims that Univac's is higher than Honeywell's and all others except, of course, IBM.

Speaking at the Sperry Rand annual meeting July 30, J. F. Forster, president and chairman of the board, also disclosed that 1968 Univac revenues will "well exceed" \$500 million, and "we expect that it will be at the top of our divisions in earnings." Order backlog "is at record levels." Comparing past years, Forster said Univac had closed in fiscal '65 with a \$290 million gross (but was in the red), and it was in '66 that "Univac moved into a solidly profitable operation."

Forster further fed the hungry computer-field statisticians with the information that the gross rental base of Univac computers was \$331 million. "After the reserve for depreciation against this of \$205 million, we have a net rental account of \$215 million. Older generation machines have been substantially removed from this rental base, either by conversion sales or full reserve and the net amount is conservatively stated as the result of accelerated depreciation introduced three years ago."

A Sperry spokesman told DATAMATION that the Univac revenue increases are not attributable to a higher percentage of purchases such as IBM has been experiencing. The Univac rental/purchase ratio has remained fairly constant at 70:30.

Sperry's total revenues were \$1,563,000,000 with profits of \$64 million. Remington Rand Division, unprofitable in '65, "has not had the same profit improvement as Univac," said Forster, but "new products have been introduced and more are on the way. Orders for its new electrostatic copier, electronic calculator, and information equipment are at high levels. Outdated and excess plant capacity conditions have been corrected and more modern facilities provided." The SR president also noted profits in Sperry Flight Systems Division, declines in the Gyroscope Division Long Island operation, and "unsatisfactory profitability" in Remington Electric Shaver.

Forster also commented on the 1967 establishment of corporate councils in the areas of purchasing, manufacturing, marketing, personnel, public relations and advertising, controllership, planning, research and development, and international. These councils, each with 6 to 12 persons and coordinated by a staff vice president, represent a pooling of expertise in each area to help solve various common cost reduction and quality problems. The effort has shown up particularly in the reorganization of the international operations, beginning in 1967. All divisions previously operated separate subsidiaries abroad, but now are under one Sperry Rand company in each country.

Forster also noted that Sperry is investigating acquisitions, though trying to "avoid being caught up in the current merger fever . . . In our acquisition views, we are not ruling out further diversification, but we are giving priority to those industries or companies in which there would be in one way or another synergistic effect for the acquired company and ourselves."

(Continued on page 85)

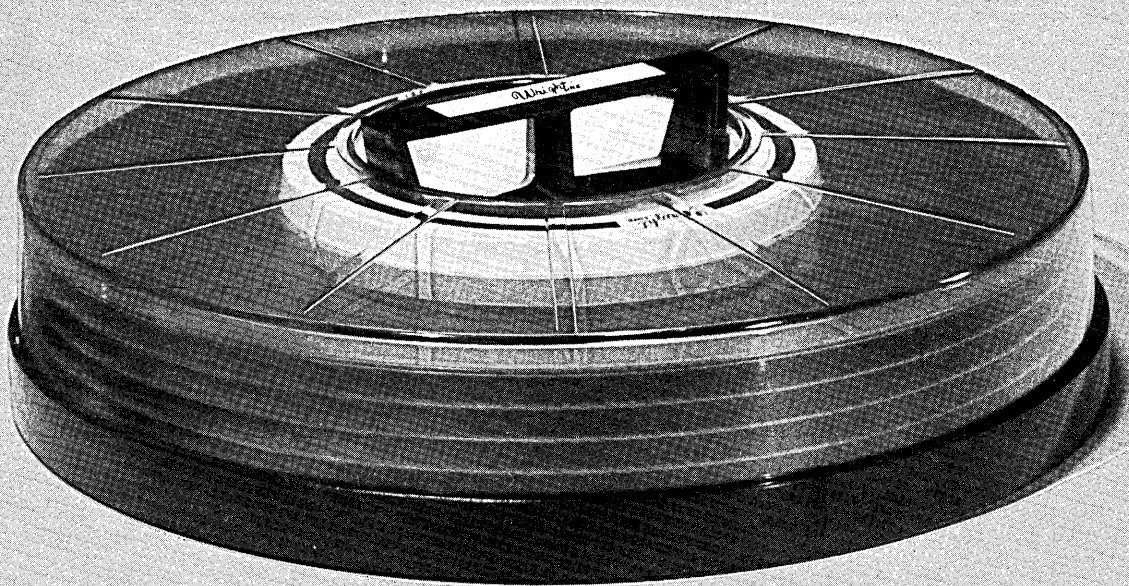

**An Unbeatable Disk Pack Combination**  
**DATA COAT SURFACE PLUS WRIGHT LINE SERVICE**

When one of America's leading computer manufacturers teams up with Wright Line, the results have to be good. Wright Line Disk Packs are made with a special smooth, flat, tough magnetic surface coating that assures high performance and reliability. Every Disk Pack must pass tests that far exceed industry standards.

And... they are sold by Wright Line, the company that brings you not only Disk Packs but a complete line of equipment for safe storage and handling including UL listed safes, library storage and full suspension drawer cabinets.

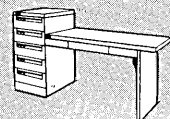
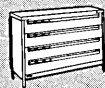
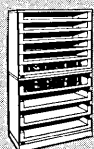
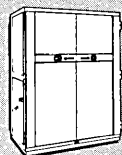

**Wright**  
**LINE**  
DATA PROCESSING ACCESSORIES

# WRIGHT LINE . . . everything for data processing . . . except the computer

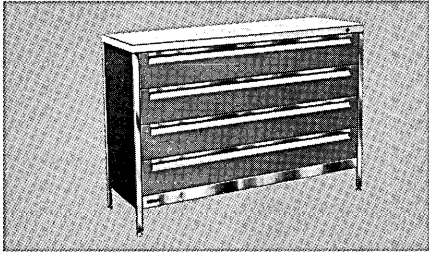

## DISK PACKS AND DISK PACK STORAGE

Now available "Data Coat Surface" Disk Packs as well as a complete line of storage units to give you maximum safety and protection for both 4" and 6" disks. Counter height cabinets have plastic-laminate tops.

For More Information, Circle Reader Service Card No. 102



## GOLD STAR FILES

The most beautiful and most versatile card files available today. Line includes counter top model with plastic laminate surface, truck and transfer files.

For More Information, Circle Reader Service Card No. 103

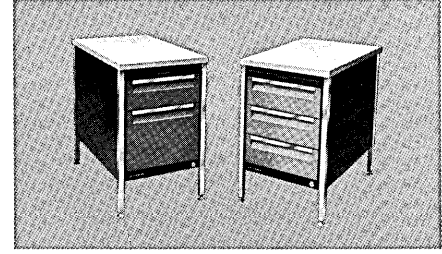

## KEY PUNCH DESKS

Provide complete work stations by adding work surface and drawer space at the key punch machines. Attractively styled units for use with all key punches.

For More Information, Circle Reader Service Card No. 104

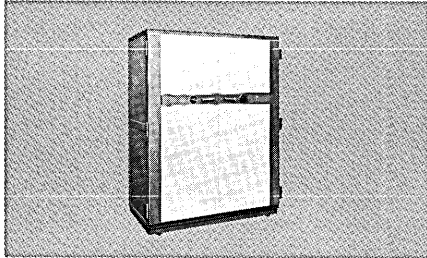

## DATA BANK

A "double safe" vault for the protection of vital records stored on tape or disks. It carries an Underwriters 150°, two hour label. High capacity at low cost per unit stored is provided.

For More Information, Circle Reader Service Card No. 101

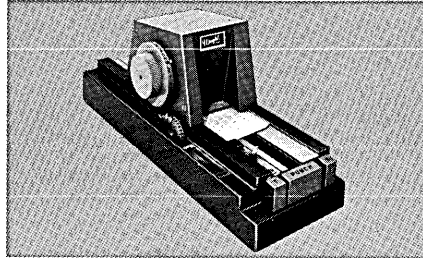

## PORTABLE CARD PUNCHES

Models for punching only or for punching and simultaneously printing. Printing punch has tab stops. Plastic card punch for Hollerith and other coding in plastic badges and cards.

For More Information, Circle Reader Service Card No. 105

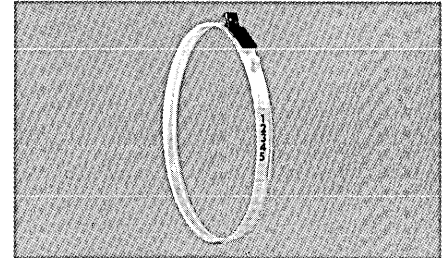

## TAPE-SEAL® SYSTEM

The safest, easiest handling, most economical method of storing tape. Complete line of Tape-Seal cabinets, trucks and accessories is beautifully styled to compliment computer equipment.

For More Information, Circle Reader Service Card No. 106

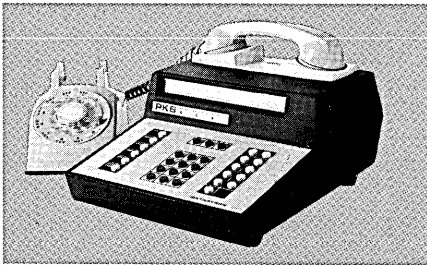

## MATHATRON

Much more than just a calculator, Mathatron has the capability to solve complex problems that are written directly with the keys. Mathatron can also be programmed and can make logical decisions.

For More Information, Circle Reader Service Card No. 107

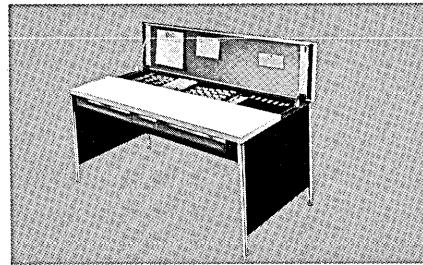

## DATA STATIONS

Specifically designed for data processing applications, Data Stations combine the best features of a desk and a tub file with custom storage for cards and supplies. One of a complete computer accessory line available.

For More Information, Circle Reader Service Card No. 108

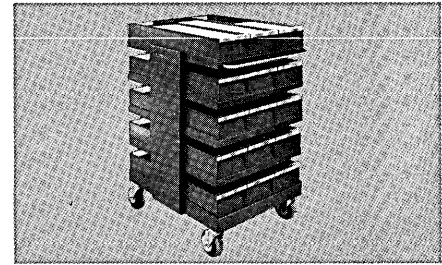

## TRUCKS

Custom trucks for transporting cards, tape, disk packs and all other data processing supplies. Trucks combine straight tracking with easy turning and ramping.

For More Information, Circle Reader Service Card No. 109

## . . . and other products:

• TUB FILES • GUIDES • CONTROL PANELS • PANEL STORAGE • BINDERS • DATA-CELL STORAGE • SORTING RACKS • Wright Line serves the data processing field exclusively with full-time Wright Line field specialists in all areas of the United States, Canada and throughout the world.

160 GOLD STAR BOULEVARD, WORCESTER, MASSACHUSETTS 01606  
A DIVISION OF BARRY WRIGHT CORPORATION



DATA PROCESSING ACCESSORIES



# The Memory Machine That Grows and Grows

This is no fairy tale. We're talking about the Fabri-Tek modern-day "memory machine", the Model 470 Standard Core memory system. And how it grows and grows—true field expansion in both word and bit length, to 32,768 words. With access time of 750 n.s.

Integrated circuits and modular printed circuit board design are used for improved reliability and package density. Expandability is by installation of additional modules. No addition of special interface expansion circuitry is needed.

Of course there's lots more to this story. And it can have a happy ending for any computer manufacturer looking for an expandable system at a sensible price. For a first edition copy of "THE MEMORY MACHINE" story book, write Bob Rife at our home office.

 **FABRI-TEK**

5901 So. County Road 18, Minneapolis, Minn. 55436  
Phone 612-935-8811 • TWX 910-576-2913

# Remember Larry Frisbie...?



He's the fellow who seldom got home for dinner because his computer was bogged down with time-consuming print chores.

*Larry went off-line...  
with a*

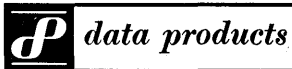

*off-line print station!*

*For a sure-fire recipe for  
cutting computer time,  
WRITE FOR DETAILED LITERATURE  
... Larry did.*

\*Trademark of data products corporation

Now his computer isn't print-bound by a conventional on-line print system. His LINE/PRINTER\* is giving him quality results . . . on time, at speeds of over 1300 lines-per-minute. Now he's showing his boss the straightest lines in the industry, upper and lower case characters, and print quality better than any competitive system.

If you've been sharing your dinner with a computer lately, speed up **your** data processing, reduce expensive computer time, and eliminate delays in producing quality printout from your operating system.

**Data Products Sales Corporation**

A subsidiary of

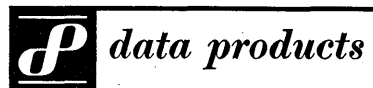

8535 WARNER DRIVE, CULVER CITY, CALIFORNIA 90230  
Phone: (213) 837-4491 / Cable: DATAPRO / Telex: 674734



## news briefs

### COM-SHARE SOUTHERN HEADS EAST, WEST AND NORTHWEST

One of the fastest moving of the new commercial time-sharers is Houston-based Com-Share Southern, now about one year old and striking out in all directions except due north.

The company was formed by president Bill Mercer in a deal with the original Com-Share; the latter would keep the northern half of the U.S. as their marketing territory and the new-comer got the southern half plus the west coast. In addition, they got the rights to use the first Com-Share's programs and techniques, agreeing to exchange developments for a four-year period. C-S Southern has recently opened offices in Denver, Los Angeles, Tulsa, New Orleans, and a third in Texas at Midland, expects to push up the west coast to Calgary and then Alaska by the end of the year—besides its earlier branches in Dallas, Huntsville, and Tampa.

Mercer, a former branch manager for SDS, has a pair of 940's, another coming soon, and will "probably get two more." The company is all out for marketing and promotion (big billboards around Houston announce "The Computer That Understands" and that's what the girl at the switchboard says when she answers the phone). Pricing is by connect time only, with declining rates of \$30/hour down to \$10, according to amount of time used per month.

With a successful stock issue just completed, Com-Share Southern will go after acquisitions, is showing interest in hardware (they now offer Univac card readers, and plotters from neighbor Houston Instruments, for remote use by customers).

### SERVICE BUREAUS LOSE SECOND BATTLE TO BANKS

The banking industry fears that regulatory agencies and the courts would put new shackles on their expanding activities seem to be dissipating somewhat. July brought the second Federal District Court decision denying a service bureau the right to sue a national bank or the Comptroller of the Currency to prevent a bank from engaging in dp service sales to customers.

The U.S. District Court of Rhode Island in Providence, under Judge Edward W. Day, ruled that service bureau Wingate Corp. lacked standing to sue to void a contract under which the Industrial National Bank of Rhode Island is providing total dp services for the City of Providence. In January, virtually the same decision was made in St. Paul, Minn., in the case brought

by the Association of Data Processing Service Organizations and co-plaintiff Systems Inc., against the Comptroller and the American National Bank and Trust Co. This has been appealed, and the Rhode Island decision is expected to be appealed.

ADAFSO indicated at the outset of its fight against the banks that the case would be taken to the Supreme Court if necessary. But if both appeals (should the second decision indeed be appealed) are denied, it is doubtful that the Supreme Court will review the issue. There are two questions really involved under the over-all contention that data processing services are not "incidental" to banking services.

One involves the Comptroller and the immunity of his regulatory decisions. *American Banker*, an industry newspaper, reports that the Rhode Island decision is the "third ruling by a Federal District Court this year upholding the Comptroller's contention that his regulatory decisions on the power of national banks are free from court attack by companies which would face increased competition as a result of the decisions." Besides the Minnesota ruling, a suit by Massachusetts travel agents against a bank offering travel services was also found to lack standing.

There are, however, several other cases in which this immunity was not given the Comptroller. Thus it is too early, says one lawyer, to concede victory to the Comptroller on the service bureau and other issues.

The other question raised in both service bureau cases involves the Bank Service Corporation Act of 1962, which restricts the service company to performing data processing services only for affiliated banks. Judge Day disagreed with the plaintiff's contention that the Act and its legislative history show a "clear recognition by Congress that national banks are not authorized to engage in the business of providing data processing services for the public at large." The statute, he said, deals only with the service corporations, and "cannot properly be construed to limit the activities of national banks generally."

The American Bankers Assn., filing a brief as an amicus curiae, documented proof that the Congress, in consideration of the bill on the Act, was "explicitly informed that banks were at the time performing data processing services for other banks and business firms."

The ABA noted that the Federal Reserve Board, which recently lent strong support to the banks in their burgeoning credit card activity, has also shown that it does not consider the Act as protecting service bureaus from

bank competition.

### CARTERFONE DECISION STAYED, PETITIONED

In July, the phone companies asked for, and received, a stay of the Federal Communications Commission decision on foreign attachments (Carterfone case), which ruled in late June that the tariff prohibiting non-phone company devices on common dial-up lines is and has been illegal. Further, AT&T, GT&E Service Corp., and the U.S. Independent Telephone Assn. have all filed petitions with the FCC for reconsideration of the decision—apparently under threat of court battle.

At the same time, AT&T president Ben Gilmer, in a letter to the FCC, stated that AT&T had been working on new regulations involving customer phone devices and would have them ready for filing "within a reasonably short time." He said, "These new regulations will provide for the connection of customer provided terminal devices through service-protective arrangements. Also they will provide that where network control functions such as signaling, switching, and charging are required, these functions will be performed by means of telephone company network control equipment." AT&T has not yet determined exactly what terminal equipment, including data sets, can be customer-owned. Clearly, switching systems will be barred from public lines. AT&T criticized the FCC in its petition for taking action when the carriers were making "serious efforts" on the question.

The petitioners fired at the FCC from all sides. Re the terminal devices, AT&T argued that not only are standards for them difficult to agree on, but proper installation and maintenance and enforcement of these standards is next to impossible to ensure—and it would be prohibitively expensive for the phone companies to assume responsibility for such enforcement.

The interconnection implications seemed to bother the petitioners most. Gilmer also wrote FCC Chairman Rosel Hyde that "The matter of general interconnection of customer provided communications systems involves serious and complex problems which go beyond those involved with the connection of technical devices," and requires "more consideration and exploration" by industry and commissions. The general complaint was that although the FCC would not permit AT&T and other phone companies to discuss more than the Carterfone issue in the hearings (on which the decision was based), it nevertheless made a decision which went way beyond this. GT&E put the matter most strongly,

can you  
number  
the rest  
of the  
squares so  
that each  
row, column  
and diagonal of three squares totals 15?

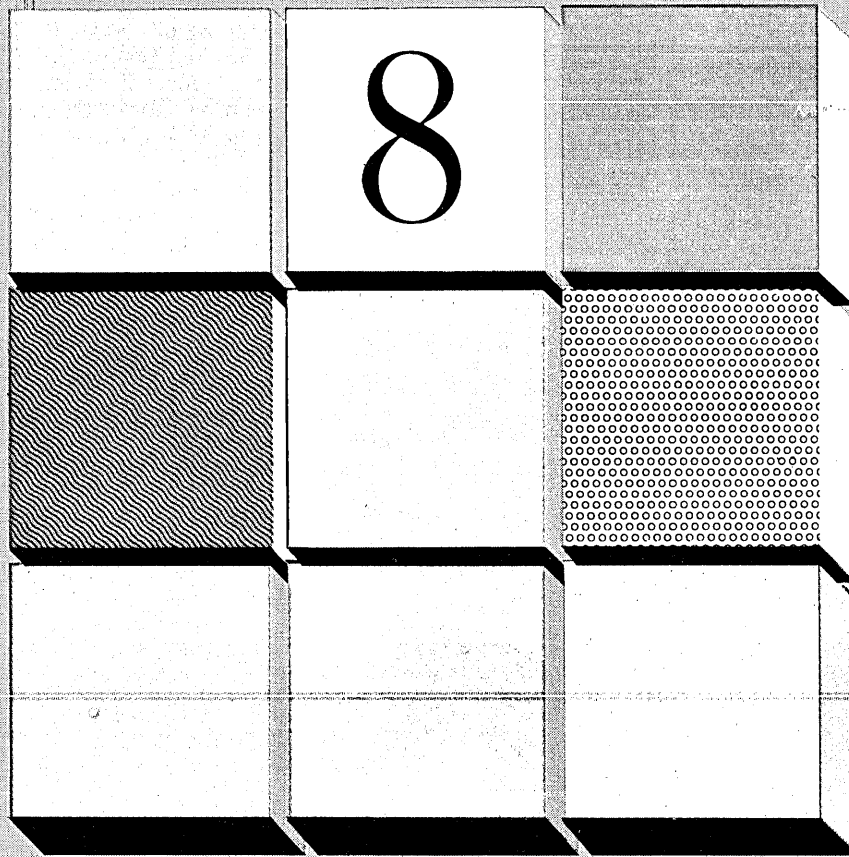

(NO NUMBER MAY BE REPEATED)

*Here's a clue. Don't assume the nature of the number system you can use.*

*Assumptions about companies—companies who may be looking for systems design, analysis and programming people like you—can be equally misleading.*

*Take American Can Company. From our name you might incorrectly assume we make only cans.*

*Would you believe we make dress patterns? (We recently acquired The Butterick Company.)*

*And textbooks? (Printing Corporation of America, another recent acquisition.)*

*Just in brushing your teeth in the morning you could run into at least three*

*things we make. A unique new toothpaste tube, the stannous fluoride in the toothpaste, and the Dixie Cup you rinse with. After 67 years of diversification, packaging is just a fraction of our product line (now over 1700 items long).*

*All of which poses some problems. Problems we'd like to give to our 3rd generation computer equipment (real time systems and in-house, working time sharing systems). So we need programmers and systems designers to figure out how. Specifically, people with a background either in commercial systems design and programming, or scientific analysis and programming.*

*You'd tackle a variety of interesting—nay, fascinating—assignments, in our Data Center in Metuchen, N.J., our present headquarters in N.Y.C., or our new corporate headquarters presently under construction in Greenwich, Conn.*

*If you can solve the above puzzle, send your answer and resume (if you can't solve it, forget it) to Mr. James Roberts, American Can Company, 100 Park Avenue, N.Y., N.Y. 10017. An Equal Opportunity Employer.*

*Thinkers Welcomed.*



## news briefs

saying that in not stopping with Carterfone and private mobile systems, the FCC "presumably has opened the door to customer ownership of telephone handsets, to direct electrical connection of other devices, and to interconnection of privately owned telephone systems, microwave systems, and other communications facilities. In doing so, the Commission violated the due process requirement and the provisions of the Communications Act and the Administrative Procedure Act."

Further, the petitioners complained that the decision upsets the total inter- and intra-state tariff structure drawn up around the original prohibition of foreign attachments—a tariff the Commission, the courts, and state commissions have variously upheld during the last 60 years.

Said GT&E vitriolically, "In the final analysis, the decision seems more concerned with creating a market for private manufacturers of equipment which might be used with the telephone network than with the general effect of the decision on the using public."

On the other hand, the FCC members who dissented on the 4-2 decision to stay remarked that "at least the Tennessee Public Service Commission, an intervening party to the case, which also urges the stay, had the candor to say that the decision disturbs standing rate-making patterns, which have been found in the public interest and would result in a loss of revenue to the company."

The FCC has promised to expedite its action on the reconsideration petitions, and turned down further petitions for extension of the stay by 60 days should the reconsideration petitions be denied. The foreign attachment decision had been due to go into effect July 29.

Tom Carter, president of Carter Electronics and developer of the Carterfone, has been playing Don Quixote to the AT&T windmill since January, 1960, when he first produced his clever attachment. Since that time, he's been able to sell some 5,000 Carterfones, he claims, principally to major oil and pipeline companies and also to federal agencies such as Defense, Agriculture and the Office of Civil Defense. But it's been an uphill fight all the way since the telephone companies have been united in their opposition.

"The big oil companies and the government, they can't do too much about," said Carter, "but the small businessmen, they harass. They threaten to terminate his service, and in

some cases they have." Such allegations are the basis for a \$1,350,000 antitrust suit against AT&T Carter has currently pending in Dallas Federal Court. Though now in "very limited production," the Carterfone has an immediate market potential of some 300,000 to 500,000 sets, according to Carter.

That is, if the telephone company opposition can be squelched. Carter also notes, however, that recently the phone companies have been making noises about developing their own Carterfone-like device should the FCC finally and unequivocally rule that they have to accept Mr. Carter's creation.

### ELEVEN CITIES INITIATE JOINT EDP VENTURE

A Municipal Data System (MDS), in the planning stage since 1966, is now officially underway in California's San Gabriel Valley. Said to be the first organization dedicated to the joint development of data processing facilities in cities, MDS has received the first \$60K of a \$210K Carnegie grant, and has retained the consulting services of Isaacs-Dobbs Systems, Inc., of Los Angeles under a \$275K contract. Lin Conger of IDS is manager.

The first (30-month) goal of MDS is development of systems in utility billing and financial planning, land use management, general file management and police statistics. The police system will be organized to be compatible with other regional developments, such as the California Justice Information System and L.A.'s want and warrant system. The Carnegie grant will pay for development and installation of the general file management system.

The eleven participating cities (Covina, Monterey Park, Montclair, Pomona, Westminster, Monrovia, San Dimas, Arcadia, La Puente, Claremont and Ontario) will support the more specific applications. Their share of the project, including cost of computer equipment and programming, will total \$339K over the 30-month period. During the first year, the cost to each member city will be approximately 4.9¢ per capita; in the second 18 months, cost will be determined by various factors: size of city budget, number of (utility) accounts, type of applications. (Cities may participate in any or all of the four main applications.)

MDS hopes to go on-line in early 1970 with a remote terminal in each city hall linked to a central computer complex. Bids will be sent to prospective vendors within the next month; according to MDS president Leonard Soper, a Montclair councilman, the board expects award rental contracts

by February '69.

### WEST GERMANY NOW SECOND BIGGEST COMPUTER MARKET

West Germany is second to the U.S. as a world computer market, according to the July 1968 *Overseas Business Reports*, a U.S. Dept. of Commerce publication. As of Jan. 1, 1967, West Germany had 2,963 computer installations vs. 39,516 in the U.S. This is 30% more than the U.K. (2,252), 50% more than France (2,008), and 120% more than Italy (1,360). For West Germany, it represented about a 29% increase in installations since January, 1966, a slight decrease from the 32% growth of 1965.

Despite its lead in number of computers, West Germany has much room for expansion of edp applications. The *Reports* states that in "computer density per million working population" West Germany lagged far behind, being surpassed by Sweden, Switzerland, and France as well as the U.S. Using an over-all population yardstick, in 1967 the U.S. had four times as many computers installed per million population as West Germany. Orders were reported to be growing rapidly; January 1968 installations were estimated at 3,800, with potential requirements by 1970 expected to be about 6,000 units.

(Ed. note: the report is jammed with figures on various aspects of West Germany's computer and business machines market, but the reader should be warned that they are not all current and some are ambiguously stated. Some figures are for Jan. 1, 1967, others are for 1965, and still others quote mid-1967 facts. For example, the breakdown by manufacturers is for 1965 and this includes Eurocomp as a U.S. firm. It was partly owned by Litton, but has since been taken over completely by West German companies.)

The West German market is dominated by foreign firms as a result of the government's failure to protect the West German computer industry, according to the *Reports*: "In the U.S. about 70% of development costs of new computers are covered directly or indirectly by military orders, while the West German government has given little thought to the problem and has, moreover, squeezed the capital market." Of 24 major computer firms in the West German market, only Siemens, Eurocomp, and Telefunken are of West German ownership, and they have less than a 10% slice of the market.

As elsewhere, IBM reigns. In 1965, the latest year for which the Dept. of Commerce has established a breakdown by firms, IBM accounted for

Someday it may be possible to store the medical records of every American in the space of a cold capsule.

Or the tax records of the nation may fit in one file cabinet.

All this, and even more extraordinary things may become possible, because Univac is experimenting with a process called photochromism, a molecular phenomenon involving color changes with light.

Univac has developed a non-fatiguing photochromic material (so unique we've applied for patents on it) that can be used as a reservoir for

computer information. Exposure of this material to ultraviolet light records the information.

The information can then be read with a low-intensity light beam and, when desired, erased with a high-intensity beam.

The advantages of photochromism for computer systems are multiple. Theoretically, present computer information storage space can be reduced enormously.

Some of Univac's plans for the application of photochromism may lead to color information displays that will

retain images for hours, and interchangeable information cartridges that could give one computer the information diversity of fifty.

Photochromism is just one of many advanced ideas in Univac research and development laboratories.

Other advanced ideas can be found in today's UNIVAC® computer systems.

## UNIVAC

Univac is saving a lot of people a lot of time.

SPERRY RAND

CIRCLE 35 ON READER CARD

# The white ones are the men and the yellow ones are the women.

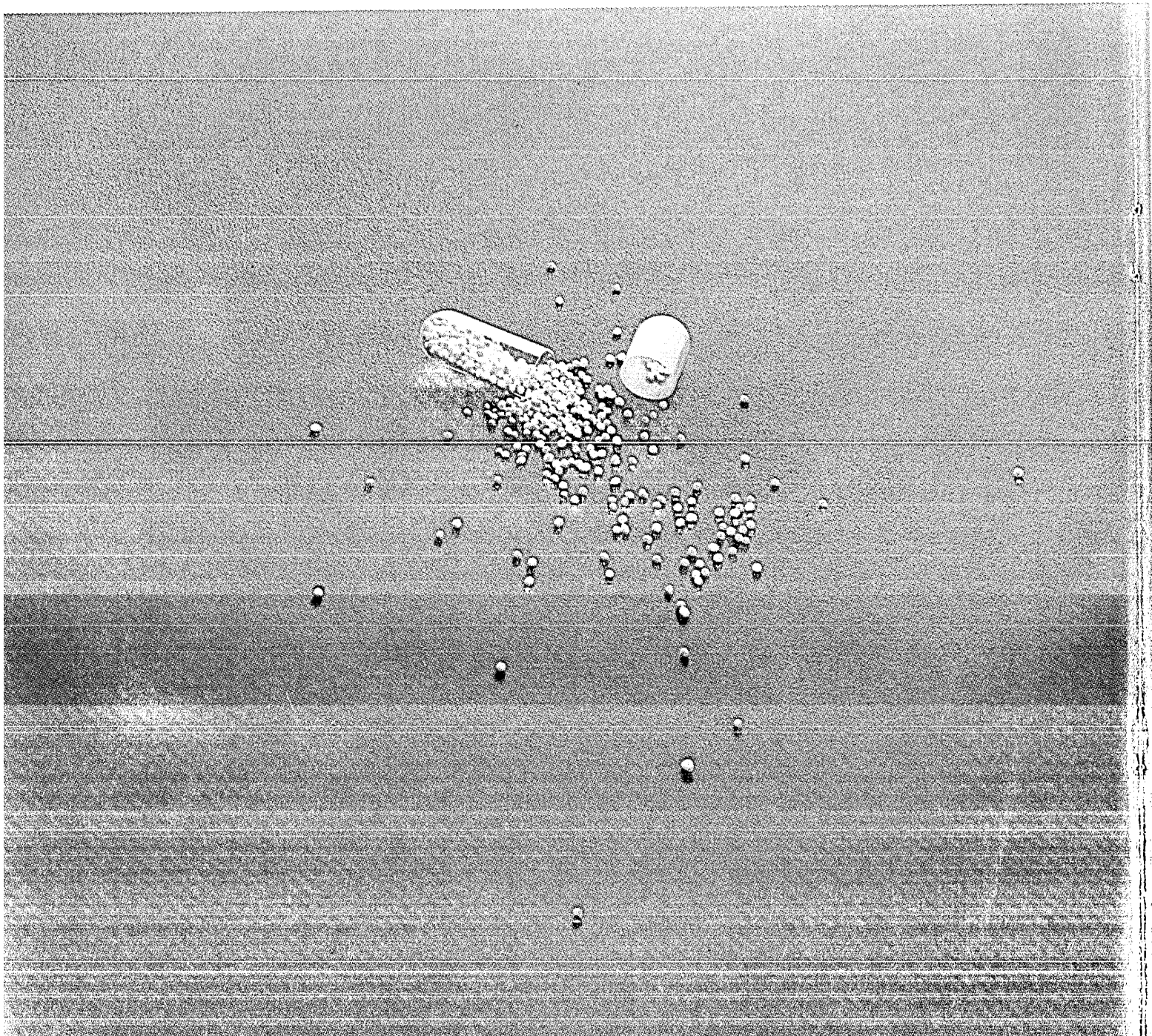

## news briefs

72.5% of the total dollar value of installations in West Germany, followed by Siemens with 6.6%, Univac with 5.9%, and Bull-GE at 4%. About 85% of the computer installations in West Germany were supplied by eight U.S. companies: IBM, Univac, Bull-GE, NCR, Control Data, Burroughs, Honeywell, and, at that time, Eurocomp. Of these firms, Honeywell, IBM, Univac and Eurocomp owned plants in West Germany, while the others supplied the market through imports. These U.S.-owned plants caused the U.S. share of the import market to decrease in 1966, though total imports from the U.S. increased slightly. Notably, 50% of all business machines imported were edp equipment.

The *Reports* emphasized that "internationalization" of computer firms was one means to survival in the European computer market. The American firms have been most active in foreign expansion and acquisitions, for example, GE's purchase of Bull and Olivetti. Some European industrial giants are also going over national boundaries; the Dutch firm Philips now has a range of computers through its takeover of Electrologica and has a 40% interest in a West German business machine manufacturer, Siemag. European firms are expected to "turn the tables and buy up American firms or potential subcontractors."

The publication describes the demand for edp equipment in West Germany as broadly spread among commercial and industrial firms, scientific institutions, and universities. One-fourth of the computers, however, are in the metal industry. Other branches of the processing industries with high computer utilization are chemistry, textiles, and food. Service industries have one-eighth of the computers, with most extensive utilization in banks and insurance agencies. "In mid-1966 the installed equipment was worth about \$625 million and by mid-1967 had increased by 28% to \$800 million."

The size of equipment being installed has followed discernible trends. From January 1965 to January 1968 small computers (under \$3K/month) increased their relative share of total installations from 34% to 50% and annual growth rates are amounting to about 50%, according to the *Reports*. In medium-sized installations (\$3-25K/month), however, a declining trend is evident because larger firms were quick to equip themselves with medium-sized edp equipment at an early date and the market now tends to be saturated. Larger computer in-

stallations (over \$25K/month) are experiencing a rapid growth, however, following a decline similar to that now affecting medium-sized installations. "This equipment is used chiefly for scientific and technological research, and government promotion of such research will sponsor more large installations. At the same time, technological developments such as long distance transmission of data and time-sharing are contributing to a utilization of larger central computers by industry.

*Overseas Business Reports* is available for 15¢ per copy from the Superintendent of Documents, U.S. Govt. Printing Office, Washington, D.C. 20402.

### WRAP DEVELOPED BY WAYNE STATE, LICENSED TO IBM

Wayne State Univ. has developed a remote access t-s system which uses OS/360 from terminals with almost no restriction on the kind of terminal used.

WRAP (Wayne Remote Access Processor) was developed last year at WSU, which recently granted IBM a non-exclusive license for further development and distribution. WSU is to receive \$85K from IBM for this.

WRAP's versatility is being tested by Michigan Bell and IEIS (Integrated Educational Information System), a federal project under Title III to develop a standard processing and telecommunications system for the schools in Detroit and in the counties of Wayne, Oakland and Macomb.

IEIS is modifying WRAP as control software for secondary schools. The first district is in Pontiac with a Mod 40. IEIS is largely concerned with administrative applications with large input (up to 36K items) and has little need for conversational mode, except for inquiry, so the approach is modifying WRAP to a batched teleprocessing system. IEIS uses six 2780's and 2740's and is getting an 1130; it has also added touchtone telephones.

Michigan Bell has completed a message switching system under WRAP for its 65. Special service orders (TV circuits, etc.), at the rate of 300-400 messages a day, are switched to 83 Teletypes and input on six Sanders crt's. The Teletype module will identify the source as crt, 1050, etc., and switch the message to its proper system. Later an administrative Teletype system will be added to operate with WRAP.

### ICL ANNOUNCES NEW BIG PAPER TIGER

Britain's newly spawned main frame house, International Computers Limited, has declared its hand in the big machine market. Details have been disclosed of ICL's 1908A costing from

\$3.6 million. This is the system which has been in limbo awaiting the completion of all formalities in the government-backed merger of ICT with English Electric Computers. Announcement of the 1908A was sprung on the world at the IRI 68 meeting in Edinburgh at the beginning of August.

The biggest system to come off U.K. drawing boards since Atlas, its basic specs are dual processor with a thin film main store that is interleaved four ways in modules of 128K (24-bit) words with a 330-nsec cycle time. The system can be twinned with 1906A processors which are now in production. Operating system for the 1908A is derived from George 4 which is in hand for the 1906A. Both these facets for upgrading the current big system are expected to tide ICL over the fact that single-cpu 1908A configurations will not be ready till mid-1972.

Logic for the new beast will be fabricated in ECL one-nsec circuits. There will be additional high-speed buffer and operand slave stores to the main memory and a mass store in blocks of 512K words. With govern-



A. L. C. Humphreys, Managing Director

ment participation and taxpayer money going into the formation of ICL, the company has not surprisingly guaranteed orders. Although two orders, one for a university and another for a science research service centre, are agreed, negotiations for at least 12 systems are believed in hand for departments such as the Meteorological Office, a government Business Statistical Office and several other schemes under development among central institutions.

Following hot on the heels of the 1908A comes the regrouping of the product ranges of the new company. Essentially this is a realignment of the roles of former ICT's 1900 and the now defunct EEC's System 4.

Briefly, the 1901 to /4 maintains the small to medium dp market. (The 1900-series, based on a 7-8-year-old Ferranti-Packard 6000 technology, has rung up some 900 orders, but the 1901 has accounted for 200 of those, and the 1901 through /3 accounts for 60% of the series' sales. How long the line can stand pat in the face of pressure

## news briefs

from the new 360/25, the improved /20 and the forthcoming /10 is a question ICL must answer. Soon.) But a big push is to go into the System 4 model 70 area for scientific and real-time applications around the million-dollar-plus class. With an eye on a direct alternative eight bit byte to IBM in its sensitive 360 model 50 and 65, the System 4 is likely to be strengthened with a 60 version below and a model 80 and 82 above.

Official vesting day for ICL was August 11. At that witching hour the company employed 34,000 with an annual turnover of \$250 million. It held 45% of the U.K. market and exported one-third of its edp products. The log of progress of mergers in the U.K. which eventually led to the British government sinking \$40 million into the formation of ICL is as follows:

1959—British Tabulating Machine Company and Powers-Samas Accounting Machines merged to form ICT.

1962—ICT bought the commercial computer division of EMI Electronics Ltd.

1963—ICT took over the computer department of Ferranti Ltd.

1963—J. Lyons and English Electric merged their interests in Leo Computers and the data processing and control division of English Electric to form English-Electric-Leo-Computers.

1964—J. Lyons sold control of EELM to the English Electric company. At the same time English Electric brought other computer activities from its radar and communications group in the Marconi Company to EEL-Marconi Computers.

1967—EELM formally changed its name to English Electric Computers. English Electric took over the whole of Elliott Automation and siphoned Elliott's dp. and scientific computing to English Electric Computers.

1968—ICL was formed by merging ICT with English Electric Computers.

In a complex financial arrangement the company is owned by International Computers (holdings) Limited. Ownership of the holding company is: English Electric, 18%; Plessey, 18%; Ministry of Technology, 10.5%; Vickers, 12.6%; Ferranti, 5.7%; some 22,000 other individual shareholders, 35.2%.

### COMPUTER METHODS, TIME SHARING SERVICES TO MERGE

Computer Methods Corp., New York based services firm that has recently been pushing its educational film/text package, is taking over Time Sharing Services, a Los Angeles company that isn't in the time-sharing business.

TSS, under president Jim Foust, has developed some proprietary program packages—including a COBOL-to-COBOL converter to simplify the changeover to new equipment. They're best known for a programming test package widely used at aerospace installations. It's said to save lots of time and many dollars in testing new programs and turning up the flaws. (An interesting and perhaps unique feature is inclusion of code and secret keywords that generate a message on demand noting that this program is the property of TSS. It's scrambled in such a way that the user can't get it out of core.)

Computer Methods is a 60-man outfit in consulting, feasibility studies, facility management, and other services. A recent notable contract: calculating the new rate base for AT&T's presentation to the FCC. The company is owned by Coburn Corp. of America, headquartered in Long Island. It's another of those cash-laden insurance/finance firms that wants a piece of the computer action.

The new, post-merger west coast operation will be headed by N. Louis Senensieb, with Foust as vp for software development. It will be known as CMC Computer Corp. and deal in systems and programming consulting, proprietary software development, and marketing of the CMC tutorial film set. Plans call for a hefty budget to be plowed into the software package area.

### AMBASSADOR COLLEGE BOASTS OLRT CIRCULATION FILES

*The Plain Truth*, "A Magazine of Understanding," has a monthly circulation of 1,250,000 copies, and is published in English, German, French and Spanish; on its masthead it asks its readers to send in their old and new addresses when moving, and to allow four days for the updating process. Sometimes the magazine reaches the new home before the people do.

People who read *The Plain Truth* write letters to the editor; the publishers, Ambassador College of Pasadena, Calif., claim they receive more mail than the President. Each letter is answered personally; since *The Plain Truth* reflects the theological tenets of the World Wide Church of God, the questions are often of a personal spiritual or Biblical nature. The letter-answerers never forget that Alice of Wichita has arthritis and lives with her grandmother, or that Mr. Wilson of Gardena wrote in last year to ask when Noah was born.

The data processing installation that supports this atypical application is a utopian example of organization and efficiency, run by manager Keith Hun-

ter and a staff of 40 which includes five programmers and eight systems analysts. (Nearly all of the employees are either graduates of Ambassador or are working students; there is essentially no turnover.)

The IBM-red-and-grey machine room can be entered when the secretary releases the electronically-locked door; in the midst of perfect order, a control unit is missing its side panels. (Delivered *blue*, it had to be repainted.) The adjacent stockroom has shelves that open from both sides and hold the forms specially printed for Ambassador's unique applications by their own printing facility that also prints *The Plain Truth* and the other free literature Ambassador distributes.

The early days of computing at Ambassador began in '61 with the installation of 407 unit record equipment to use on the subscription list; when it became apparent that this was less than adequate, the dp staff naively decided to upgrade to a real-time circulation system utilizing crt's on-line to mass storage files. In late '66, a 16K 360/20 and a 64K/30 were installed; this last April, these machines were joined by a 128K/50. The /30 and the /50 now share the peripherals (including two 2.5-million-byte 2314's and a 400-million-character Datacell) via a control unit; they also share an operating system. ("We didn't see any reason why they *shouldn't* share an operating system," explained Hunter, "and although IBM was skeptical, they ended up helping us to achieve it.")

A master terminal linked to the /50 controls 16 other 2260 crt displays located in another room; each terminal faces a young girl who busily opens the mail and enters address changes, comments from letters, requests for literature, etc., directly into the files. The files contain over a million names.

The program for this updating and retrieval is written in assembly language (some of the work done on the /20 is in RPG) and utilizes expanding parameters: a name, address or other fragmented information on a subscriber or correspondent can be retrieved from the files by as small a piece of data as the first number of their street address, their first name, or one number of their Zip Code. (By making one master file of Zip Codes, and referencing each individual address to it, Hunter claims they saved 80K characters of core.)

Since Ambassador College is a non-profit institution, the dp center occasionally donates computer time to other less well-endowed organizations, like neighbor CalTech, who, until it receives shipment of the /75 it has on order, is definitely a poor relation. The computer center also processes student

# What's happening today in keyboards is what's happening at MICRO SWITCH

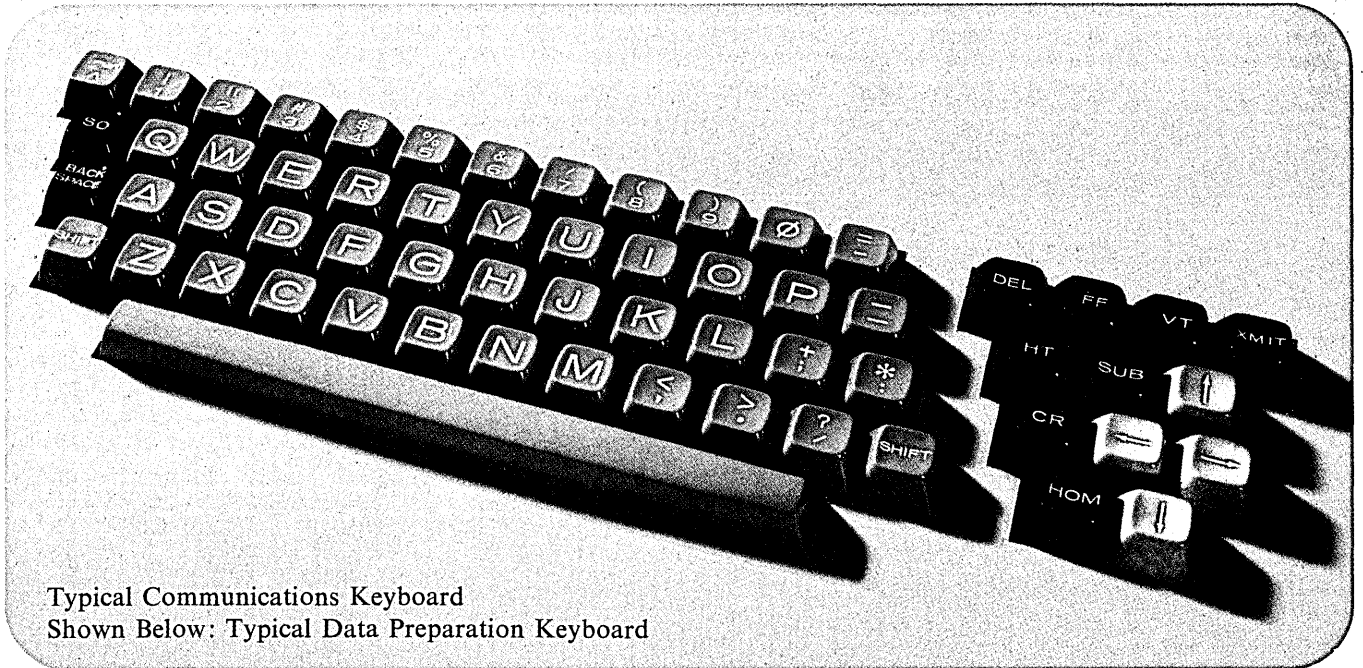

Typical Communications Keyboard  
Shown Below: Typical Data Preparation Keyboard

An important key to future keyboard design is what's happening at MICRO SWITCH.

Already we have successfully launched Happening No. 1: Introduction of complete wired and encoded keyboards ready to interface with your equipment.

Shown here are two typical keyboards. Each gives you dry reed switch input, solid-state-encoding, and a variety of exclusive options.

And they provide a flexibility that is unavailable elsewhere. You get a customized keyboard. Key array, format, added options, code change—you select the features required for your system.

Options include strobe and electrical monitor outputs, bounce gates and shift. For example, two interlock options are provided to improve operator speed and efficiency. An electrical monitor output triggers a detector circuit for blocking data or initiating error signals. A unique two-key rollover option permits typing at "burst" speeds without generating erroneous codes.



But that's not all. Coming very soon is Happening No. 2. Through advanced design concepts, complete engineering facilities, innovative assembly techniques, and unique quality assurance procedures, MICRO SWITCH is preparing to supply your every keyboard need. This means new reliability and flexibility in mass-production quantities with attractive customized appearance giving new sales appeal to your equipment.

Make no decisions on keyboards until you see what's happening at MICRO SWITCH. Call a branch office or call us at Freeport: phone 815/232-1122.

## MICRO SWITCH

FREEPORT, ILLINOIS 61032

A DIVISION OF HONEYWELL

HONEYWELL INTERNATIONAL • Sales and service offices in all principal cities of the world. Manufacturing in United States, United Kingdom, Canada, Netherlands, Germany, France, Japan.

CIRCLE 36 ON READER CARD

## news briefs

records and administrative work from the college proper, but this is a minor part of its operation since enrollment at Ambassador is stabilized at 500.

Remnants of the eam operation and keypunch equipment are being phased out at Ambassador; on order are ten 2740 keyboard terminals and two more 2.5-million 2314's. And looking for new projects, the systems analysts are working on a real-time accounting system. So while big business thrashes in the mire of data banks and real-time information systems, Ambassador College will quietly continue on, doing what it thinks computers ought to be able to do, and succeeding.

### INTERDATA 3 USED AS CONTROLLER WITH 360/67

Dr. Ottis W. Rechard, head of the computer center at Washington State Univ., uses an Interdata Model 3 as a terminal controller with a 360/67 (IBM's time-sharing machine) and is able to put 32 Teletype terminals on-line to the computer.

The system is restricted to one speed—Teletype—and does not have the 3-speed capability of the IBM 2702, but it gains in flexibility because the controller is a computer and can be programmed, and is more economical because there is no need for the 103 data set.

The computer is programmed with a specially designed read-only memory that takes 2K bytes of core (out of 8K bytes). This will be replaced with a larger read-only memory in October when the system is updated. It will then have an Interdata Model 4 with 16K bytes of core, and be able to accommodate 64 Teletype terminals. This program to develop interactive terminal systems, controller and interface is supported by the Office of Naval Research.

### USC'S SHOCK RESEARCH UNIT MOVES AND IMPROVES

The Shock Research Unit of USC's School of Medicine is phasing out its relationship with L.A. County General Hospital and is moving to the new Center for the Critically Ill at Hollywood Presbyterian Hospital. The reason for the move, according to a USC source, is "new funding" which emphasizes operations research and the attempt to evaluate on-line monitoring of patients in a controlled environment—and the Center for the Critically Ill offers environmental advantages not readily available at LAC General because of the latter's immensity. Coordinator of the new center is Dr. Max Harry Weil, who is also director of the

Shock Unit.

The 51-bed center consists of five units: intensive care, coronary care, post-anesthesia recovery, concentrated patient care and an emergency unit. It is expected to handle some 2,800 patients annually.

The major portion of the center (49 beds) will use off-line computer processing of patient information. The core of the Shock Research, however, is the emergency unit, which includes two instrumented beds directly connected to the computer for on-line monitoring of patients critically ill from circulatory shock. (According to medical authorities, fewer than half of shock patients now survive. If shock occurs after a heart attack, fewer than 10% survive.) Funded by a \$2.5 million research grant from the U.S. Public Health Service and a \$330K grant from the John A. Hartford Foundation, the Shock Research Unit is a continuing study to improve these patients' chances of survival.

The system that will be operating at Hollywood Presbyterian (final check-out will be completed in October) differs in many ways from the original system (based on a 20K IBM 1710) established in 1962 at LAC General. Describing that system in a September '65 DATAMATION article, authors Robert L. Patrick and Marshall A. Rockwell, Jr., noted: "The input problem has yet to be solved . . . manual input units now in use are numeric, use rotary dials for input, are bolted to the wall and are bulky . . . the output problem is almost as serious. An electric typewriter and a point plotter . . . presently installed . . . are too noisy . . . Various forms of projection displays have been considered so that the physician may view the printout from across the room . . . The computer procured was single channeled and unbuffered; this is a limitation."

Most of these problems have been overcome by the system now being installed. The computer is a buffered 24K Sigma 5 with random access disc capacity of three million bytes, an increase of 50% over the previous auxiliary memory. The "noisy" peripherals have been replaced with SDS keyboard display and entry units; these units, located next to the instrumented beds, will allow hospital personnel to review and graph the progress of the patient at the bedside. Output will be viewed on Tektronix graphic and oscilloscope displays; physicians will be able to read patient information from across the room via closed circuit televisions with large monitors.

The Shock Research Unit has also undergone a major change in emphasis in the last few years. Formerly concerned primarily with the acquisition

of data that would illuminate the disease process, it now is more interested in developing methods that will allow the physician to deal with disease in an effective real-time environment.

This objective necessarily includes the prospect of more direct computer control of patient care. An example of this is computer-controlled analysis of blood chemistries, an application that will be in operation early in '69. In this particular situation, catheters are placed into one artery and one vein; valves are attached to the catheter. Previously, the valves would be manually controlled to allow blood to enter a syringe. In the new system, opening and closing of the valves will be computer controlled; blood withdrawn will be diverted into a device that measures pH, and blood chemistries and gases. As the system is further developed, the computer will eventually decide, by the results of this measurement, when tests ought to be conducted, thereby optimizing the occurrence of blood tests in regard to the patient's condition, and eliminating the less effective random testing now in practice.

In January, when Shock's affiliation with LAC General is officially terminated and, with its more advanced equipment, it is settled into the smaller, more tightly-integrated center at Hollywood Presbyterian, the Research Unit hopes to provide a conclusive demonstration that on-line monitoring of patients is, indeed, saving lives.

### NEW FIRM ALREADY KNOCKING DOWN WALLS

Computer Planning Corp., Torrance, Calif., software and systems firm that opened the door in Jan. '68, is expanding its facilities to accommodate additional personnel, now numbering 50, and to house a 360/50 (to go with its /30).

The acquisition-minded company, headed by Harold F. Jensen (formerly of IBM), is already in the black, recently acquired 4 "J" Numerical Control Co. and On-Line Sciences, both of LA, and is on the lookout for an outfit with good peripheral capability.

The firm currently bills \$55-60K a month and projects \$1½ million for the next year. It plans a European operation beginning in early '69 and is funded for that effort to the merry tune of over \$100 million. Offices will be in London and Brussels, and the company will be called Integrated Computers & Leasing, dealing not only in computer leasing but other equipment as well.

### ONE MORE MINICOMPUTER

A new challenger to the small comput-



*On the occasion of the Postal Cheque and Clearing Service's 50th anniversary the Netherlands PTT has organised an*

# International Automation Contest

*A method is sought by which it is possible to interpret handwritten numerical information direct by machine.*

The Netherlands Postal Cheque and Clearing Service is an institution that facilitates money traffic by offering a quick, simple and easy manner to make payments. Its customers make cashless money transactions by means of transfers.

For some years the booking process has been completely automatised. But the handwritten data provided by the account-holders on their transfer cards (account-number and amount) have to be converted by coding-typists before being processed by machine. For the over 1,500,000 account-holders (one third of all families and almost all enterprises) a method is sought by which the numerical information can be supplied on the transfer cards in such a way by pen or ballpoint that these cards - there are nearly one million a day - can be read direct by machine, that is, without human interference.

Participants are invited to write for a free brochure that contains detailed information about the problem and its backgrounds, general regulations, owners' rights and the criteria for the judgement of designs, to be applied by the jury. The brochure is available in the English language at PTT-headquarters, 12, Kortenaerkade, The Hague, Netherlands, if desired with a supplementary French or German translation of the most essential facts.

Entries that are of a sufficient quality and meet the general regulations may be awarded with the first prize of Dfls. 25,000.-, the second prize of Dfls. 15,000.- or the third prize of Dfls. 5,000.-. Entries should be dispatched before 1st July, 1969; the jury's decision will be communicated to the senders of entries within seven months after that date.

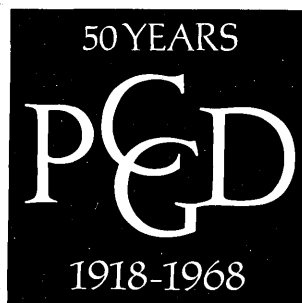

POSTAL CHEQUE AND CLEARING SERVICE

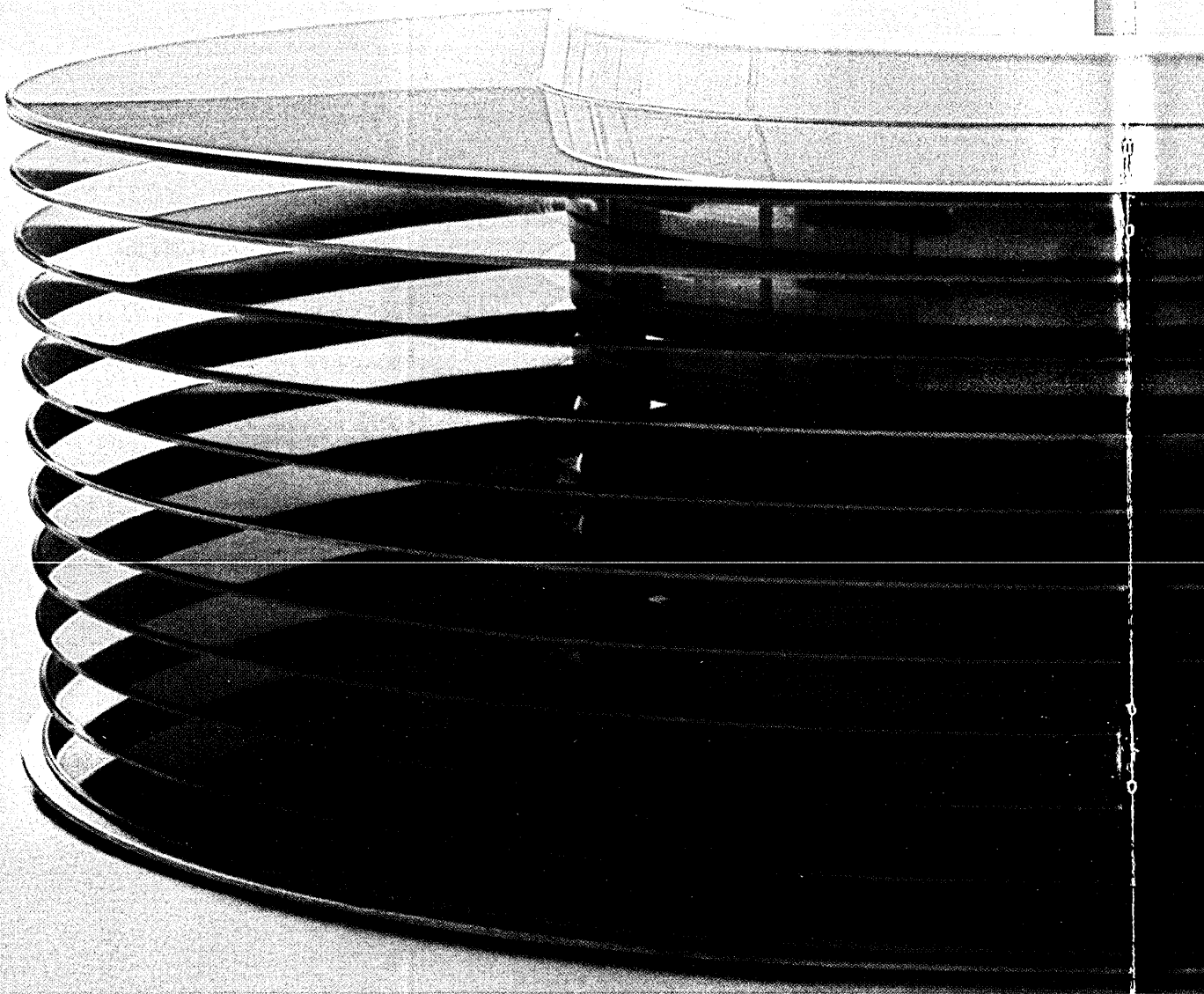

# Memorex introduces the

The Mark VI is a new 20-surface disc pack built to the same exacting standards as the Memorex Mark I.

The Mark VI is fully compatible with the IBM 2314 drive, as well as the new Memorex 660 drive.

In addition, all Mark VI packs are initialized be-

fore shipment, with the home addresses and record zeros (this to save you time and trouble and permit immediate VOL and VTOC assignments).

Mark VI has been extensively field tested and is now being delivered in production quantities.

tor  
Pa  
N

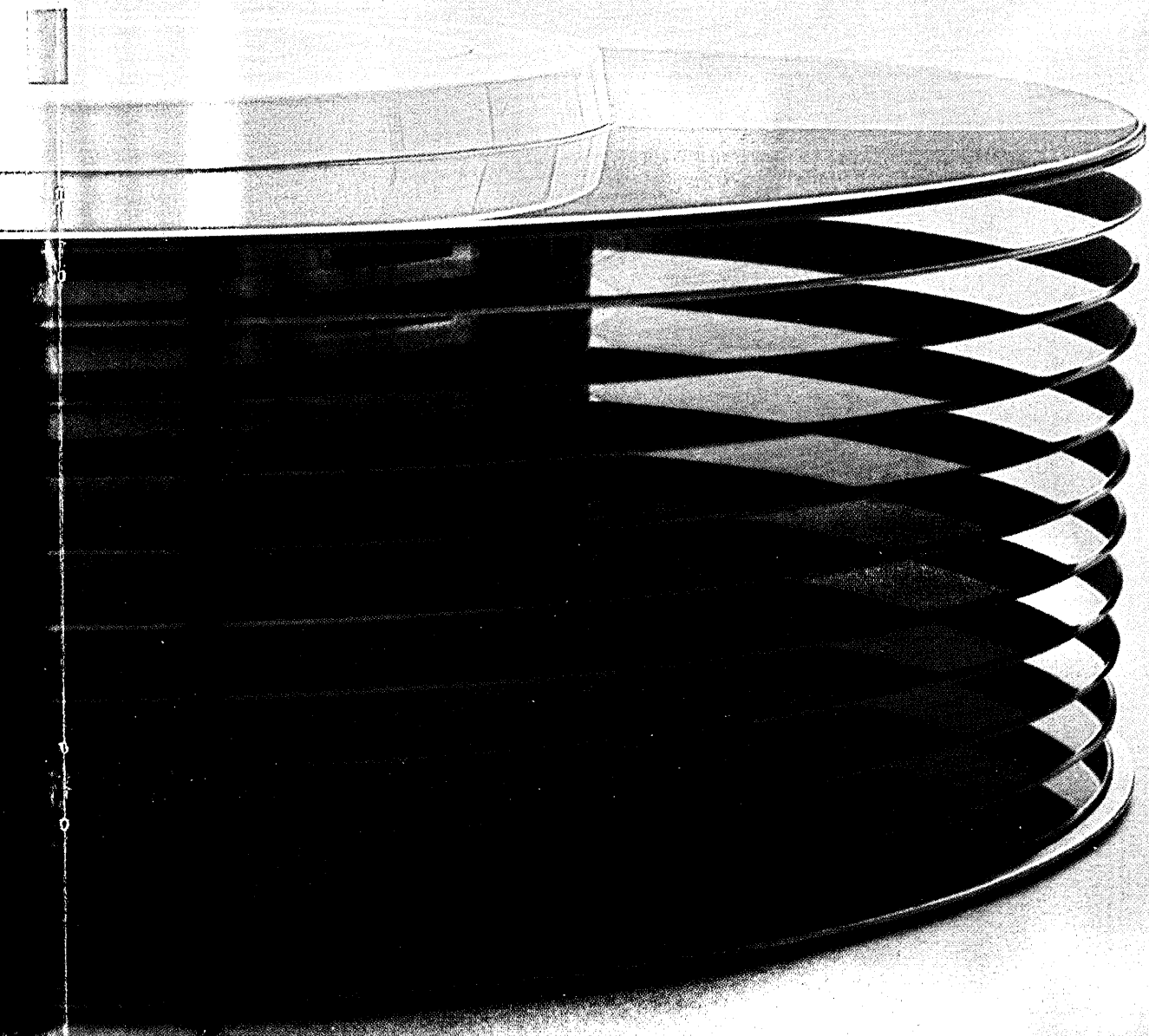

# Mark VI.

Call your man from Memorex in any of our 50 factory sales/service offices or write: Memorex, Memorex Park, Santa Clara, California 95050.

**MEMOREX**

# New Method Prints Out Computer Information 15 Times Faster

*Announcing a great new way of getting information out of your computer and distributed.*

*One that is both fast.  
And economical.  
It's called Micromation.*

**The New Speed.** *Micromation systems translate computer output into readable text and print the information on film—at speeds up to 20,000 lines a minute! Throughput rate is at least 300 standard size computer pages a minute! One employee can easily turn out 100,000 pages in an 8-hour shift!*

*Micromation printers operate 15 times faster than the fastest impact printer—breaking at last the information jam that has been clogging your EDP department and submerging your company in paper.*

**The New Medium.** *Micromation prints on film. Film provides the permanency of paper, but costs about 1/8 as much, only takes up to 2% as much space, and is many times easier to distribute.*

*Your people get information*

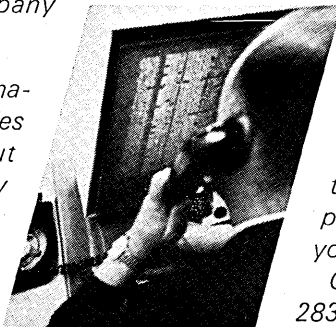
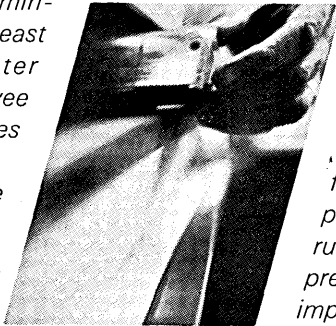

*sooner—and it's more accessible because the film can be viewed at Inquiry Stations where any one of thousands of pages of information can be located in seconds. And when you need paper copies, Micromation provides them at the rate of two per second.*

**The New Opportunities.** *Certain Micromation printers even convert digital data directly into graphic art—changing computer codes instantly into: bar graphs, diagrams, curve plots, PERT charts, etc. And every printer has the capability to merge business forms with alphanumeric computer output during the printout run—eliminating the expense of pre-printed forms necessary with impact printers.*

*First came the computer—and from the information it produces, new opportunities for growth, productivity and increased profits. Now comes Micromation—a significantly better way to get that information out of the computer and distributed throughout your organization.*

*Give us a call at (714) 283-6531. We're delivering now.*

**Moving  
more information,  
more places,  
on time.**

**Stromberg Datagraphics, Inc.**

A Subsidiary of General Dynamics

MICROMATION SYSTEMS

P.O. Box 2449 • San Diego, California 92112

CIRCLE 39 ON READER CARD

## news briefs

er market is Gamco Industries, Inc., of Big Spring, Texas; its entry is the DataMate, a 16-bit 4K (expandable to 32K) word processor, competitive with the Varian 620/i and Raytheon's 703.

Gamco, recently purchased by Siboney Corp. of Dallas, had garage beginnings in 1955 when George A. McAlister, Jr., decided to develop some mathematical teaching aids—primarily special types of chalkboards—later known by the name of Math-Master. In the succeeding 10 years, sales increased to the point where the company could diversify; in 1965 it purchased Creative Visuals of Dallas. When, in late '66, it purchased Educational Computer Products of Salem, Ore., the company officially entered the dp field.

As a division of Gamco, Educational Computers manufactures the ECP-18 series of classroom computers. The ECP-18A, described in DATAMATION's New Products (Nov. '67, p. 119) is installed in many school districts as a mathematical instructional laboratory.

Gamco began development of the DataMate when it became apparent that the ECP-18 series had some features which limited it almost exclusively to educational applications: a drum memory, a "fairly inflexible" I/O structure that would not readily permit I/O devices other than a single Teletype to communicate with it, and a memory capacity that would not allow use of standard languages, such as FORTRAN. (The ECP-18 uses a specially developed language, Easy-Code Programming.)

The one-usec DataMate has eight 16-bit I/O channels of multi-level priority, and is expandable to 64 (16-bit) channels, each with its own priority assignment. The unit can be adapted to nearly all standard peripherals, including multiplexors, crt displays and modems. Basic software includes a symbolic assembler, I/O subroutines, and a utility package. Expanded software offers FORTRAN, an executive routine and applications packages.

First production models will be completed next month; deliveries are scheduled to begin in February '69. For information:

CIRCLE 239 ON READER CARD

**I.C.I. STUDIES OUTLINE AUSTRALIAN COMPUTER MARKET**  
Computer orders in Australia are taking an upturn in the current calendar year after a two-year slump, according to a study made by International Computers Pty. Ltd. A research group in the Australian subsidiary of the Brit-

Ever wonder what  
everyone's doing... on each job  
... each hour... and how much  
it's costing you?

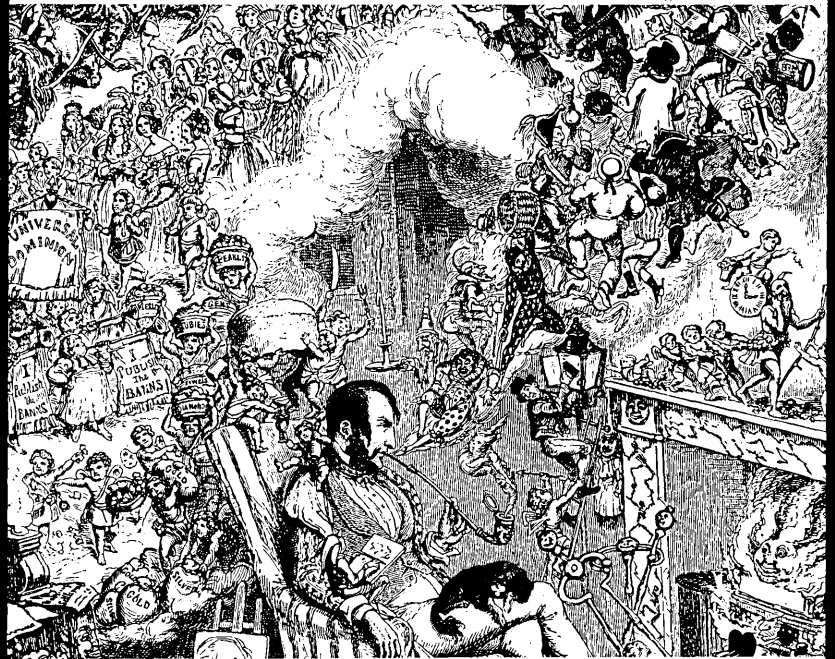

with **PROMPT**  
you can stop wondering  
... You'll Know!

PROMPT, or Program Monitoring and Planning Techniques, is the new management control package developed and application-proved by ARIES Corporation. PROMPT provides detailed computerized reports to all levels of management so that they know exactly what's happening at any phase of the program cycle . . . down to the most basic task performed by each man, every hour of the day. Effective implementation of PROMPT will drastically reduce expensive cost, manpower and schedule overruns since it can accurately pinpoint these problem areas sufficiently in advance to enable rapid correction.

**PROMPT** is adaptable to any computer operation.

**PROMPT** assures that all levels of management get the information they need, when they need it, so that any problem can be quickly and efficiently corrected.

**PROMPT** optimizes deployment of available resources, and feeds back historical data for estimating costs and evaluating individual performance.

**PROMPT** provides maximum return on your management investment while being easy to use and economical to run.

If you're looking for a better way to plan, monitor and control your projects, look into PROMPT. For complete information, write or call Mr. W. Miller, Vice-President:



## ARIES CORPORATION

PRODUCTS DIVISION Westgate Research Park  
McLean, Virginia 22101 • Phone: (703) 893-4400

CIRCLE 40 ON READER CARD

## news briefs

ish computer supplier has calculated that about 125 machines will be ordered this year. This compares with about 110 in 1966 and 100 in '67. The peak year in the short history of computer usage in Australia was 1965, when about 155 computers were ordered. This followed a rapid rise in the rate of ordering from about 35 in 1962 to about 85 in 1963 and 135 in 1964. The I.C.L. researchers explain that the figures are necessarily approximate because the exact order date of each computer is not known. The slump after 1965 has been attributed mainly to the uncertainties created among potential buyers of equipment over the effects of the changeover to decimal currency.

The study puts the likely total of computer orders placed in Australia by the end of this year at around 750. These are shared among four market sectors: 519 commercial, 146 government, 39 educational, 46 scientific. The total includes replacement orders which have not added to the number of installations. Actual installations so far slightly exceed 670, according to the study. About 500 of these are in the commercial sector and about 120 in government.

In an analysis of how orders were shared among the 10 companies supplying general purpose computers in Australia, the I.C.L. group finds a decline in the leading position of International Business Machines. IBM is credited with about 40% of the value of the orders placed in the financial year 1967-68, compared with 48% in the previous year. Numerically, the market leader's share rose from about 28% to about 31%, indicating that IBM is selling an increasing proportion of smaller machines.

I.C.L. puts its own value share of the orders in the last financial year at about 24%, compared with about 8% in the previous 12 months. The numerical percentage rose from about 9% to about 18%.

In the I.C.L. study, Control Data is credited with a rise in value percentages from about 9% to 13%, although its numerical percentages in the two years remained steady at around 4%. This rise is accounted for by the \$4 million contract from Broken Hill Proprietary Co. Ltd. towards the end of the last financial year. In this, the largest single non-government computer order placed in Australia, the company will supply four machines each valued at about \$1 million. Control Data Australia had its most successful year since incorporation in 1963—a net profit for 1967-68 of \$702,719, com-

pared with a loss of \$167,016 for 1967.

Other orders in 1967-68; according to the study, were shared among National Cash Register, with about 7% of the value, and Australian General Electric, Digital Equipment, Honeywell, and Australian Computers, each with about 4%. The market shares given to the various companies are necessarily approximations because the I.C.L. group based its calculations on the average value of the different computer systems ordered.

The study shows that Australia has 76 computer installations for every million non-agricultural workers in the population. This compares with 386 in the United States, 123 in Switzerland, 95 in Sweden, 60 in France, and 7 in Spain.

The I.C.L. group believes the computer market in Australia can be valued at a minimum of \$40 million in the current financial year. It estimates the ratio between computer power and price has expanded by an average of 200% in the last four years and in some cases by up to 300%.

### EASTERN IMPLEMENTS NEW RESERVATION SYSTEM

What is said to be the world's largest and most modern computerized reservations system was phased into operation in July as Eastern Airlines' Miami facility was put on-line to an IBM 360/65. The planning, designing, building and testing of the system, a joint Eastern/IBM effort, involved more than 2,000 man-years of time. Within the next 11 months the other nine Eastern regional offices will be converted to PNR (Passenger Name Record System), beginning with Charlotte, N.C.

Regional offices will be linked to three 65's in Miami via 2,250 IBM 2915 airline reservation terminals—desk-top crt's with standard keyboards and 27 special function keys. Each cpu has an internal storage capacity of 524K bytes, with an additional 6 million bytes of storage space in three 2361 mass core units. An auxiliary memory network of 16 IBM 2314 disc units can hold more than 3 million bytes of information, and each unit can record more than 200 million bytes on eight 2316 disc packs, with a 75 msec access time.

A Univac 494 in Charlotte now stores seat inventory and keeps the 65 up to date on seat availability. After all records are transferred to the IBM system in Miami, Charlotte will become the company's Operational Data Center—the 494 will handle the transmission of the more than 3.5 million Teletype messages transmitted each month to 150 locations throughout the Eastern system; in addition, it will contin-

ue to serve the reservations needs of such local carriers as Allegheny, Mohawk, North Central and Ozark.

Complementing PNR will be the Houston Fearless CARD (Compact Automatic Retrieval Display) microfilm information retrieval system. The system holds 73,000 pages of information (formerly contained in 20 separate reference manuals) on fares, other airline schedules, airline codes, customs requirements, etc., all stored on 750 microfiches, any page of which is available to the agent within five seconds on the screen of a unit positioned alongside his crt. Eastern will be the first airline to provide its telephone sales people with both crt's and the CARD system—resulting in a reservation operation that will become literally "paper free." The combination of the systems will allow the agent to respond to a particular query an average of 20 seconds faster than by the previous methods.

Eastern sees PNR as only the first phase of a long-range program which will include automated ticketing and fare quotation, and eventually a system under which many customers will make their own reservations, acquire their tickets, and check and claim their own baggage.

### NEARLY 4000 ATTEND IFIP 68

The castle glowers down on the grim grey granite of dour old Edinburgh, where nearly 4000 information processing specialists from 46 countries gathered last month at IFIP Congress 68 to try to hear 250 papers, see the usual spate of exhibits and take in "auld reekie's" attractions.

Blessed by a heat wave—three days running of spectacularly unusual sunny 70°F weather—and by Her Majesty Queen Elizabeth II (patron of the conference), the specialists did their best in a city not ideally suited to a conference of this size.

Housing was, to be kind; scattered . . . some people commuted from Glasgow, a good hour's drive away. Lecture halls were not *that* scattered, but an Olympic Games distance runner would have been challenged to make an immediately following session a half mile away. Taxis were scarcer than in Manhattan rush hour.

England opened the conference royally with a welcoming speech from Admiral of the Fleet, the Earl Mountbatten of Burma, OM, FRS. An electrical engineer and a past president of the British Computer Society, Mountbatten twitted IFIPers for their technical jargon, at conflict with the goal of expressing "ourselves more simply . . . to communicate with each other in easily understandable terms." He was



## Introducing Honeywell Series 32

**Computer systems with the golden touch...  
that work for pennies**

First member of the Honeywell Series 32 family of 32-bit real-time I/C computer systems, the H632, is 850 nanoseconds fast. A high-performance system for real-time scientific and control applications, like: ground support/checkout, trainers/simulators, hybrid computation, message switching/data retrieval, and general purpose scientific.

It not only costs less per instruction than any other medium-scale machine, but has an advanced concept of modular system integration and design that makes it shine in multiprocessor/multiprogrammable configurations. Of course, its software package is extensive, and a complete line of peripherals and

subsystems is ready to meet almost any requirement.

The H632 can grow with you... from a minimum 8K memory with one central processor and one input/output processor to a maximum system of 131,072 words of memory, four central processors, and four input/output processors. I/C construction throughout adds to system reliability (we're I/C people from way back).

Because the H632 does so many things so well for so little, we call it "the computer with the golden touch... that works for pennies." Want to learn more about the H632? Write for our new summary brochure. Honeywell, Computer Control Division, Old Connecticut Path, Framingham, Massachusetts 01701.

# Honeywell

**COMPUTER CONTROL**  
DIVISION

## news briefs

unable to understand such conference paper titles as "Partial Isomorphisms in Graphs and Structural Similarities in Tree-like Organic Modules," and found himself "in sympathy with the Czechoslovakian paper entitled 'Unambiguity and Ambiguity of Context-Free Grammars and Languages.'"

It is doubtful that IFIP conference planners, evidently less down to earth than their American ACM counterparts, will heed him. The proceedings indicate an overwhelming interest in the intellectually esoteric and theoretical aspects of the business. One American systems programmer who has been out of the States for a couple of years looked at the program and almost fled. Another complained that there were no papers on the hottest topic of the moment: PL/I.

If you ever have to try to wade through the mountainous proceedings, you might concentrate on the Invited Papers, generally acclaimed as excellent.

Many complained about the dismal presentation of the papers, read in the best plodding academic fashion. Papers delivered in non-English were translated into English, but English papers were not translated into anything. Said one bloke: "I mean, there really isn't any other language, is there?" He may find out if he attends IFIP '71, scheduled for Yugoslavia.

The exhibits were dominated by the big systems manufacturers; American firms showing minicomputers—Hewlett-Packard and Varian Data Machines—were joined by Britain's Computer Technology Ltd. and by Israel's Elbit Computers Ltd. There was much less emphasis than at American shows on communications and displays, although Information Displays Inc. and Sanders drew good crowds.

The two "official" French computer companies—CII (see News Scene) and Sperac (main frames and peripherals, respectively)—had equipment-less booths.

If the papers and the exhibits were in general uninspiring, the conference undoubtedly gave specialists a chance to meet their counterparts from other lands. Perhaps future Congresses can be organized and situated to make this important conference goal easier to achieve.

### MEMOREX MAY ACQUIRE TECHNICOLOR, GETS BIG DISC ORDER FROM SDS

Memorex Corp. has announced an agreement in principle to acquire Technicolor, Inc.'s photographic products business, a merger that will pro-

duce, according to the company, a business whose annual rate of sales will exceed \$150 million—placing it among "The 500." The agreement is subject to approval of both companies' boards of directors and shareholders.

The proposed transaction calls for Memorex to issue to Technicolor  $\frac{1}{4}$  share of its common stock and  $\frac{1}{2}$  of a new issue of 4% convertible preferred stock with a liquidating value of \$100 per share for each share of Technicolor common now outstanding. Memorex would issue more than 900K shares of common and over 700K shares of the new preferred. The preferred will not be callable for five years and will be convertible into Memorex common at the rate of 1.15 shares of common for each share of preferred.

The Technicolor business to be acquired includes the manufacture of theatrical and TV print films, photographic equipment for consumer and A/V markets, and labs for photographic developing and printing services.

Also announced last month was the sale of nearly \$2.5 million worth of Model 660 disc drives to Scientific Data Systems. The discs were manufactured by Memorex subsidiary Peripheral Systems Corp., and the sale represents the first such contract for Memorex from a major computer manufacturer.

Memorex sales in '67 were \$34 million with a net profit of \$3.8 million; in the first six months of '68, net profits were \$2 million on sales of \$25 million. Traded on the NYSE, Memorex has had yearly highs and lows of 80 and 61½. At time of writing, it was selling at 70%.

### INTEGRATION OPENS DOORS TO COMPUTERS

A hotel and motel reservation service, which was not practicable before civil rights laws ended segregation policies in public accommodations, goes into operation this month. (Previously, many hotels and motels refused advance reservations of any sort.) The National Accommodations Reservations Service, Inc., Orlando, Fla., intends to fully implement a nationwide network handling 24 million reservations a year within the next 2½ years. The service will include credit validation, reporting, and accounting programs as well. NARS has entered into a \$15 million contract with Burroughs and expects total value of all equipment, communications and programming development over the next five years to approach \$100 million.

NARS was established in 1962 but was primarily involved in intensive market research until late '66. As of July, a nucleus of 17 persons comprised the company. Initially, several

problems made computer reservations unfeasible. Among these were a lack of adequate computer capabilities and concepts for using edp in such an application, in addition to racial discrimination practices then prevalent.

Although approximately 9% of the hotel and motel industry is already being served by reservations systems, only a few are computerized. NARS does not intend to be in competition with these services, but will supplement them, providing wider access to reservations information by interfacing with them. For example, NARS is negotiating with the Holiday Inn motel chain to interface with the Holidex computerized reservation system; NARS would then be able to accept and transmit reservations for Holiday Inns and, in turn, accept their overflow. This may not be done on-line, however. NARS says it has two contracts with national motel chains and is talking to other chains and referral organizations (dues paying groups of otherwise independent concerns), as well as independent hotels and motels.

As the system is extended, service will be expanded into allied areas such as car rental agencies, airlines, and oil companies, though emphasis will remain on accommodations. NARS will not store airline seat or auto inventories, but may interface with airlines systems and/or perhaps the travel agent system, ATARS. In addition to serving oil company travel and tourist services, NARS will also store or interface with oil company credit files; credit validation will be provided in cases where hotels and motels have agreements to honor oil company credit cards, preventing unauthorized use of stolen or forged cards, or pyramiding of excessive bills (this is expected to be implemented within a year). NARS is also offering to receive supply orders from gas stations, transmit them to distributors, and do the billing.

The present NARS network is utilizing about 25 operator centers. The centers, located throughout the country, provide reservation service from local and foreign exchange lines at no cost to persons placing the calls. About 100 centers are anticipated by next March as business increases. A total of 600 TC500's will eventually be installed, primarily in customer offices.

Customers' TC500's are to be used only in hotels and large motels, but specifications are being developed for a terminal to be used in smaller hotels and motels for reservations and credit validation. These include a keyboard with special-purpose function keys and Teletype printer and a special-purpose keyboard with a standard crt. Both will be buffered. At present, standard crt and Teletype are being



## news briefs

used with the TC500. NARS expects 4-5000 terminals to be installed over the next three years.

Two B500 computers are in operation in Orlando and plans call for two more, as well as one in the eastern and another in the western parts of the nation, to be installed by January. Fifteen disc drives of 9.6 million characters each are planned. Of the four cpu's in Orlando, three will be dedicated to on-line reservations, sharing disc files, and the fourth will be used for back-up. By 1970, two more computer centers may be established, in the West and Midwest, and a pair of 65K-word B6500's, or possibly the unannounced 3-cpu B7500, will replace the present Orlando configuration. Service is now said to be on-line 18 hours a day, 7 days a week, but may be extended to 20 hours a day.

NARS is renting the computers, but purchasing the 600 TC500's at a cost of \$7.8 million. Software is being developed with the aid of independent software firms as well as Burroughs, with total cost for programming and debugging estimated at \$1.5 million. The "fixed-fee" for NARS service will vary with the volume of use and the type and quantity of terminals employed; there will also be a charge per reservation.

### MANAGEMENT OF INTERFACES KEY TO MODULAR SYSTEMS

At the recent National Symposium on Modular Programming, a panel of experts concluded that effective control of communications interfaces in the structure and layout of a structural design with careful attention to interfaces are major keys to developing large, highly modular software systems.

Nearly 200 computer professionals attending the symposium in Boston in July heard the lively panel discussion which highlighted the program. The panel was headed by symposium vice chairman Larry L. Constantine and included George Mealy, a consultant well known for his role in OS/360, Joel D. Aron of IBM Federal Systems Div., and Malcolm M. Jones, assistant director of MIT's Project MAC.

Some 13 technical papers were presented, including a survey of segmentation and design strategies for modular programs, a paper on problems of implementing module management under OS/360, a description of a mathematical model for modular programming systems, and proposals for hardware assistance to program modularity.

The symposium placed a heavy em-

Be  
ready for  
MAC.

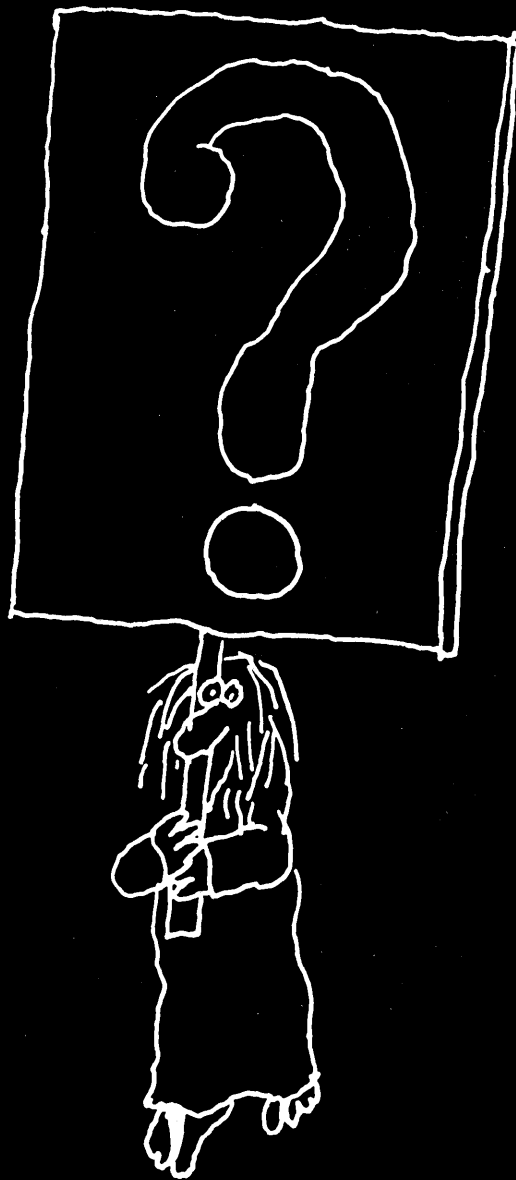

## news briefs

phasis on modularity as a measure of independence and separability of individual modules; comments from the floor brought out the importance of imparting the concept of effective modularity as a key part of programmer professional education.

The symposium was sponsored by the Information & Systems Institute, Inc., a Cambridge-based educational and consulting organization. The papers presented at the symposium as well as discussions will be combined with 15 additional papers referenced in the symposium papers, and the final volume will be published in book form by the Information & Systems Press under the title *Modular Programming*.

### VARIAN EQUIPMENT CAN BE LEASED FROM GRANITE

The Varian Associates product line, including its computers, will be available for leasing as the result of an agreement with Granite Equipment Leasing Corp.

Varian, Palo Alto, Calif., expects that most leases will be for their line of scientific instruments since their computer line is at the low end of the price scale (about \$14K for the 620/i, \$7.5K for the 520/i). Granite, which

has a computer leasing subsidiary dealing primarily in IBM 360's, will purchase Varian equipment and systems and offer leases of varying length and terms.

Additional Varian products include scientific instruments ranging from spectrometers to gas chromatographs, recorders and other laboratory equipment.

### SERVICE BUREAU TAKES SEABORNE CUSTOMERS

Although the drive-in computer service bureau is not yet with us, Computer Center of Santa Barbara notes that their new branch scheduled to open in Marina Del Rey Sept. 7 can take customers arriving by boat.

This is the first branch for CCSB. Now a subsidiary of General Research Corp., the company was started about three years ago in Santa Barbara, Calif., and has a CDC 6400 system. Specializing in scientific jobs and selling both time and services, the 23-man company did about \$1 million in the fiscal year just ended. The southern branch will start out with six or seven people, headed by Stan Garrish.

The home office equipment also has the only known on-line CDC 915 page reader; supported by home-grown software. With it for input, the firm has just snagged a good-sized contract

with the Santa Barbara public library to handle cataloging.

### PRINCETON WILL GET ONE OF THE FEW 360/91'S

Princeton Univ. will install a 360/91, to replace the present IBM 7094 and 360/67 next May when its new computer center building is completed. The university recently announced a \$92 million program for academic development, of which \$15.5 million is sought for the computer area over the next five years to endow four professorships, establish fellowships, extend research interests of faculty and students in all divisions of the university, and for construction and building maintenance. A National Science Foundation grant of \$1.2 million will be spent on student and faculty computer use over a three-year period.

The 91, one of a limited edition of 16 built by IBM, at an educational discount will cost \$2.7 million for purchase of the cpu and half-million-word main memory. Peripherals worth about another \$2½ million will be leased: satellite computers, consoles, crt's, tape drives, printers, etc. The computer center will provide 25,000 sq. ft. of floor space for the computing equipment; the center building will cost \$2,190,000.

### CONVERSION PROBLEMS CLIP PIGEON STUDY

The uncanny navigational ability of homing pigeons is being studied at Bowling Green State U.

Dr. Louis Graue, Chairman of the Math Dept., hopes to discover the secret of pigeon navigation so that it may be duplicated electronically for use in aircraft. (He points out that radar was essentially a man-made duplication of the method used by bats to fly at night.) The dedicated Dr. Graue has been investigating homing pigeons for the past 18 summers under several government grants, the present being about \$7K/year from the Office of Naval Research. No definite conclusions are yet reported, however.

Helicopters have been used to follow pigeons short distances but the study primarily involves observation from the ground. Individual pigeons are liberated at distances up to 500 miles from their home lofts, their headings are observed and exact vectors are calculated. This is a vital area of the investigation in that any pattern followed by the pigeons may provide clues to their method of navigation. Previously, these calculations took so long that only one vector per pigeon was calculated. With a computer, vectors have been quickly calculated for 20-second intervals of the flights of each bird until it disappears from

## A little BIT of LOGIC for COMPUTERS

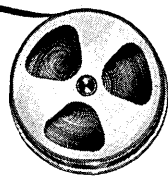

### Maintenance Service by RCA For Computer Peripheral Equipment

Reduce downtime and service headaches—with a planned service program from RCA's specialists on communications, control, and data processing equipment maintenance. Select the leading service; it even can help you close the sale!

- Nationwide facilities
- Skilled technical manpower
- Lower over-all costs

Contractual plans for the account of the manufacturer and large user. Emergency and per-call service, too. Write or phone for details.

RCA Service Company  
A Division of RCA  
Technical Products Service  
Bldg. CHIC-225  
Camden, N. J. 08101  
Phone (609) 963-8000, ext. PH-311

# RCA

## news briefs

view, usually about a five-minute period when observed from the ground. Dr. Graue emphasized the great contribution of the computer, saying that "the task of analyzing the data that took three weeks with a desk calculator takes a few minutes using the computer."

One drawback—the same one that's plagued everyone else—has been conversion to a new computer. Dr. Graue complained that the old IBM 1620 had been adequate for his calculations and that he had gotten very efficient in its use over the past five summers. This summer he discovered to his dismay that edp matters had been complicated by a newly installed 360/40. So the pigeons continue to fly home, undaunted and unexplained by man or machine.

### NEW YORK HAS INSTANT LICENSE REPLACEMENT

Until last month, an unfortunate New York State driver who misplaced his license might have waited several weeks for a replacement, but now remote terminals in Motor Vehicle Department branches will provide a new license in less than 10 seconds. The system uses 70 terminals at five locations in New York City and three in the Albany area, utilizing an IBM 360/65 with IBM 2321 Data Cell drives located in Albany. Special buffered terminals were designed by IBM specifically for this application, said to be the first of its kind.

To duplicate a license, a clerk need only type an individual's name, birth date, and sex on the keyboard, then insert a blank license form into a special holder on the terminal. If this information is in order, seconds later the unit types an exact duplicate license, including the record of traffic violations. If the license has been revoked or suspended, or no license is in effect, the terminal types this explanation. The system also amends licenses and issues licenses to new residents who hold valid licenses from other states.

If there is no license on file meeting the description typed at the terminal, the operator will telephone the Albany center where 24 IBM 2260's are used to access full records. There, several variations on the data, say, a name, can be tried until the license is found and transmitted to the terminal. The crt's will also be used for quick access to information requested by police.

The system is scheduled to be fully implemented by the end of next year, at which time there will be 270 terminals at 93 locations throughout the state and 60 crt's in Albany. Service

will also be expanded to provide duplicate vehicle registrations. Total cost of the system is expected to be about \$100K/month. Much paperwork and file searching by Dept. of Motor Vehicles personnel will be eliminated and a "significant reduction" in employees is expected.

### FEDERAL RESERVE SYSTEM STUDY FAVORS BANK CARDS

The Federal Reserve System has given its blessing to the expanding bank credit card trend and predicts an even larger share of the consumer credit industry for commercial banks. These were among the findings in a study released last month by the FRS on bank involvement with charge cards and check-credit accounts (special checking accounts extending a line of credit).

By September, 1967, when data for the study was collected, banks had captured 6.7% of the "plastic credit" industry—valued at \$633 million—with another \$483 million extended through the check-credit plans. Banking industry observers in Washington expect the FRS endorsement to encourage more banks to offer the credit plans.

The study found the charge plans profitable for even small, country banks; though it noted that paper work was more extensive than expected—especially on card plans involving retailer tie-ins and monthly billing. It concluded that the credit card competition would stimulate greater use of electronic money transfers by banks—speeding the advent of the "checkless society."

The study predicted further inroads by the bank-sponsored plans into finance company business and in-house credit systems of retailers. In particular, small merchants may switch to bank-operated plans for their 30-day charge accounts—since these can compete favorably with the "revolving credit" used by major department stores and mail-order houses.

Credit cards and check-credit plans are also good vehicles for 25% to 30% of the consumer loan business now conducted by banks.

Though big-ticket items—autos and appliances—might bump dollar debt ceilings in the bank plans, many other short-term loans could suitably be charged, the study contended. With the Fed looking on benevolently, expansion into the consumer loan area (where banks currently have \$41 billion outstanding) would imply tremendous growth for bank card systems.

In an accompanying document, the Federal Reserve Board asserted its existing supervisory powers over state

member banks are sufficient to deal with any "unsound practices" that may arise in the charge card and check-credit fields. The board went so far as to say that legislation forbidding unsolicited mailing of the cards would be both "unnecessary and undesirable." (Supervisory authority over national banks is vested in the Comptroller of the Currency—who is also considered sympathetic to the growing bank involvement in "non-bank activities," including dp service centers.)

The study ruffled feathers on Capitol Hill, however, particularly in the House Banking Committee where Chairman Wright Patman is a persistent gadfly of the Federal Reserve and commercial banking interests. One Congressman, who preferred to remain unidentified, called the report a "whitewash." Patman's staff said the report was another example of the "snowballing economic power" of the banks. They suggested that the spreading interests of commercial banks—which now provide such diverse services as data processing, auto loan insurance, travel bureaus, as well as credit cards—may require a thorough Congressional review next year.

The study covered bank credit card plans ranging in size from that of a rural bank, with just 230 cardholders, to the giant BankAmericard with its 8.2 million cardholders, 211,000 participating merchants, and 9000 subscriber banks.

### NEW COMPANY TO PROVIDE COMPUTER USE EDUCATION

Edutronics, Costa Mesa, Calif., is a recently formed company that has inaugurated a system called ACE (Animated Computer Education) for the training or updating of edp personnel with a one-on-one technique involving a film cartridge, a viewing screen, a set of headphones and a student. This plug-in type of instruction eliminates minimum class requirements, the need for classroom facilities, and scheduling problems. The firm's films are in eight-minute concentrated segments dealing with all standardized edp staff jobs in the areas of systems analysis, programming and operations, for beginners to managers. The courses have been designed by computer specialists, educators and psychologists, are updated periodically, and are presented in living color. With the ACE films, the company supplies viewing and listening equipment, workbook, textbook and test materials, and a "Career Development Guide." The courses, including equipment, are available on a \$420 per month lease basis. For information:

CIRCLE 240 ON READER CARD  
(continued on page 104)

## news briefs

### INDIAN RESERVATION TO HAVE MEDICAL INFORMATION SYSTEM

Bell Aerosystems' Arizona Operations in Tucson found they had computer time on their hands when they updated their equipment to a CDC 3300 and have instituted a medical information system, under the direction of the Health Program Systems Center of HEW's Division of Indian Health, to automate all medical, environmental and sociological fields for each of the 8,500-member Papago Indian community near Tucson. The system will be developed under a \$160K contract to Health Research Inc. of Buffalo, N.Y., to provide a basic operational system within 18 months.

The cpu will be accessed via remote terminals at the three clinics serving the Papago's. The system will provide physicians, public health nurses and environmental specialists with a single data base that is current, complete and immediately accessible regardless of the location at which the patient is being treated. It will also provide the means of detecting and analyzing health problems on a family and community basis in a timely manner, allowing optimum application of health resources to prevent or contain the outbreak of communicable diseases.

### SERENDIPITY MOVES INTO BUSINESS DP

Serendipity Assoc., heavily government-contract-oriented total systems house (full-time staff of 20 in the Pentagon), has formed the Computer Technology Div. through the acquisition of Hal Lyvers & Assoc., Los Angeles software firm specializing in process control applications. Work is done on a contract basis, although a package (for calculating sags and tension in overhead conductors) is in the mill.

The new division, intended to take the company into business data processing, is already doing a feasibility study for the San Fernando Valley (Calif.) Board of Realtors and plans to expand its activities into total systems jobs for banks, insurance companies, and hospitals. Hal Lyvers will head the division, to be located in the company's Chatsworth, Calif., headquarters.

### SINGLE DISC PACK OFFERED BY MAC PANEL

Mac Panel Co. has shipped over 300 of its 11-disc Mac Pack Type 2316 disc packs and has announced a new addition that completes the line, the Mac Pack Type 2315, a single disc cartridge with top and bottom recording surfaces. The cartridge is designed for

use with the IBM 360/44, the 1130 and the 1800. Recording capacity is over eight megabits, and the list price for minimum orders is \$90. The company claims to be the first independent to offer the three pack sizes, 6, 11, and single and has orders for over 100 of the cartridges. Of the independents, Memorex, for one, has no plans at present to follow suit on the single-disc pack.

● Computer Time-Sharing Corp., headed by Donald O. Bade, is a Palo Alto-based "full service company" that provides third party leasing and installation and systems management as well as time-sharing facilities. In operation only four months, the firm has offices in Sacramento and L.A. and opened its doors in Seattle and Houston on Sept. 1. It has a Univac 9300 and a Honeywell 200 in Palo Alto, and equipped its branches with 1108's for remote batch services. The company has 45 employees and about 30 clients thus far.

● Digital Scientific Corp., San Diego, has announced completion of its design and development of an automated remote ticketing terminal for Ticket Reservations Systems, Inc., which has installed terminals in the Los Angeles Forum, American Express and other agencies in Los Angeles. The company will build 100 terminals for TRS; Di-An Controls another 100; Franklin Electronics still another 100, and Control Data Corp. 1,300.

● If and when the FCC's foreign attachment ruling takes effect, Milgo Electronic Corp. expects to be a prime beneficiary. The company's MODEM 4400 data set uses a "narrow-band" technique that gives it the capability to transmit computer data over voice-grade telephone lines at speeds up to 4,800 bps, compared to Bell's Data-Phone, which transmits at a maximum of 2,400 bps. Prior to the ruling, a 4,800 bps transmission rate was available only over privately leased lines. Milgo maintains that maintenance on the higher speed data set is minimal.

● Alphanumeric Inc., Lake Success, N.Y., has announced a patent cross-licensing agreement with IBM under which either party obtains "certain rights under patents of the other in the field of photocomposition." It was revealed that the rights Alphanumeric receives are on a "royalty-free basis while the rights received by IBM are on a royalty-bearing basis." Information on which patents are involved could not be obtained because of a clause in the agreement which prohibits disclosure of its terms. Alphanu-

meric holds patents on its high speed photocomposition system, which is being used in a service bureau and also supplied to IBM for use with 360's. IBM's information department disclosed that IBM holds a "large number" of patents in this field.

● What is said to be the first toll-free conversational t-s service to a CDC 6000 series system will begin operations early next year. United Computing Systems, Kansas City (subsidiary of United Utilities, Inc., the country's third largest telephone company) begins installation of the system in October. Nationwide toll-free capability (anywhere in the continental U.S.) will link customer remote teletype-writers via multiplexed telecommunication circuits leased by UCS. Initially low-speed lines will be used, with additions later of medium-speed remote batch processing terminals to accommodate large amounts of I/O data.

● Three Univac 1818 Avionics computers, part of ILAAS (Integrated Light Attack Avionics System—Navy), operated without failure for 100 hours each at temperature cycles between  $-65^{\circ}$  and  $+160^{\circ}$  F, with periodic vibration. The 1818's, with military designations of CP-914 and CP-915, are 18-bit, general purpose, medium scale, digital computers with 12K words of memory, designed for airborne applications: radar data processing, navigation, inertial navigation, and weapon delivery calculations. The test program, said to be more severe than currently used by the military, covered arithmetic and control, memory and destructive read-out memory stack, I/O and controls. It required execution of more than 120 billion memory references and more than 60 billion instructions during the combined 300 hours.

● NCR will market QUICK-DRAW under exclusive rights from National Computer Analysts. This program for automatic computer flowcharting outputs machine-printed flowcharts and printed reference documentation of the program. It is supplied to the user in punched card form. The program automatically provides cross-references by section paragraph and data name. QUICKDRAW works directly from source statements in COBOL, FORTRAN, or basic assembler languages.

● Last year the Univ. of Miami (Fla.) offered a unified medical sciences course to engineering students; this fall it will offer unified engineering sciences for medical students. This is the first medical school in the country to offer a one-year package on the engineering aspects of biomedical engi-

## news briefs

neering. A dozen students and six staff members will take the first course. The sequence begins with orientation in computer sciences at the Computing Center, to enable the students to use the computer in further course work.

● A Southern California section of the Urban and Regional Information Systems Assn. (URISA) has been formed in Los Angeles. The new group, which has over 50 members, is the first in a series of regional sections that will be formed throughout the U.S. urisa was established in 1965 as an international association to encourage and advance planning, designing and operation of urban information systems. Projects of the Southern California section will include a series of meetings, a newsletter and an information exchange program. Interested persons should contact: George Pilmanis, Section President, 1540 Addison Road, Palos Verdes, Calif. 90274.

### shortlines . . .

Data Research, a new Tulsa firm, will begin operation this month with the installation of a CDC 6400. DR is a wholly owned subsidiary of Ozark-Mahoning Co. The 6400 will be used primarily for scientific and engineering applications, but is expected to expand services to the medical field and provide remote terminals for customer use . . . Sheik Zaid bin Sultan al Nahayan of Abu Dhabi is getting an NCR Century 100 . . . Canada's first supercomputer, a CDC 6400, has been installed at McMaster Univ., Hamilton, Ont., for teaching, research and administrative applications. 19% of the time will go to outside users . . . Technical Advisors, Wayne, Mich., t-s firm for surveyors, will install a second Varian 620/i in November. TA, which had 36 clients in 14 states at the turn of the year, is now serving 70 clients in 19 states.

### call for papers

**Conference on Computer Graphics**, Univ. of Illinois, Urbana, March 30-April 2, 1969. Papers are invited on topics related to computer graphics and display: hardware, software, theory and applications. Deadline is Oct. 15, 1968. Send to: Prof. C. W. Gear, Program Chairman, Univ. of Illinois, Urbana, Ill. 61801.

**MEDIA Symposium** (Man's Environments Display Implications & Applications), Arlington, Va., May 27-29, 1969. Tutorial and research papers are solicited; they should identify specific aspects of man's environment in which

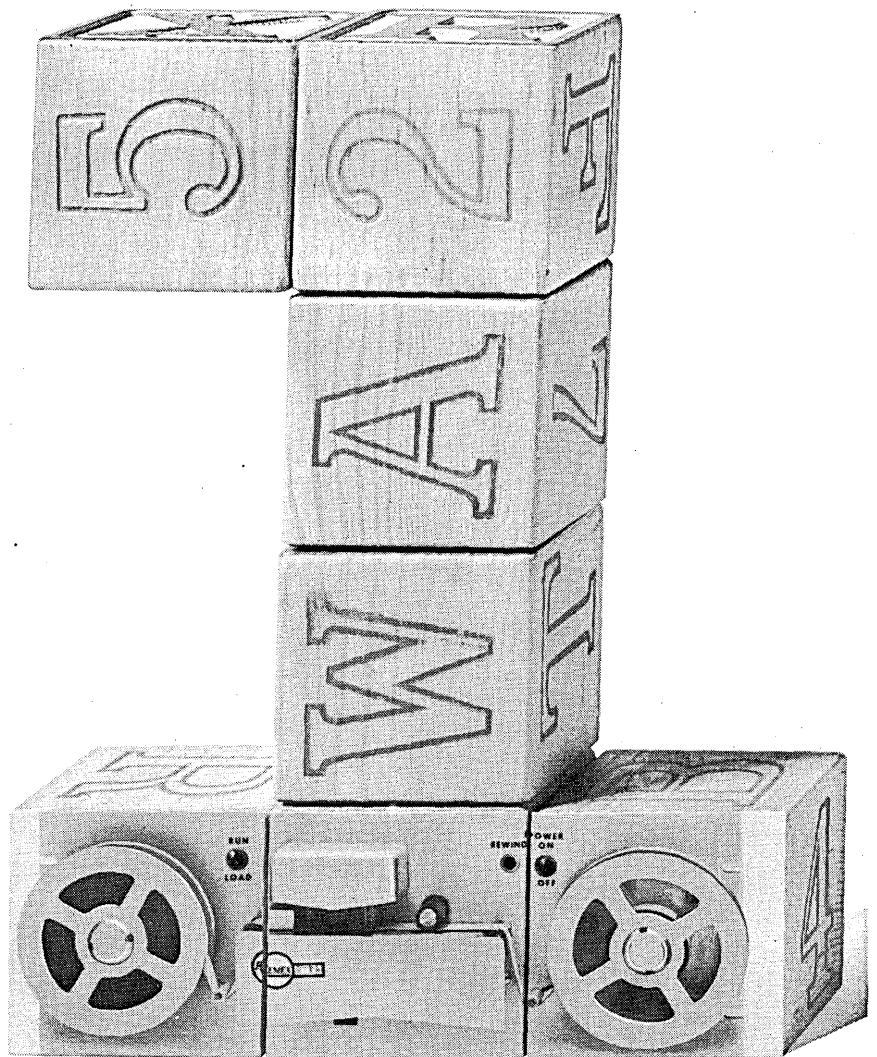

# Good for you

Sound, reliable Remex readers. Made that way through "building block" construction. Which means simply that whether you order one of our standard readers or ask us to build you a special one, we use the same basic components to put it together. Tried-and-true components that have withstood countless tests of reliability by our customers. And come out on top. Number one. That's probably why we sell more readers than anybody else. It's also a pretty good reason for you to check out Remex readers for yourself.

Call us at 213-772-5321 or write: Remex Electronics, 5250 W. El Segundo Blvd., Hawthorne, California 90250. Remex readers. If you know what's good for you.

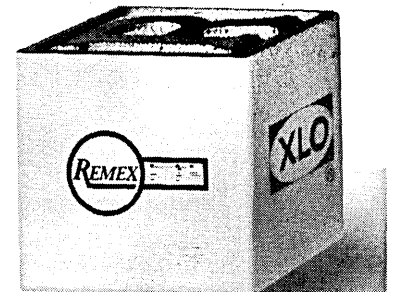

# Who buys EMR?



## *The company that needs multiprocessing capability at an economical price.*

Everyone uses the computer these days. The engineer, the research scientist, the pure mathematician, to name three. Trouble is, they all want to do their processing at the same time. That calls for a multiprocessing system. Systems with multiprocessing capabilities can be very expensive, as you probably know. You're talking over \$500,000 in no time.

Now consider the ADVANCE 6130 system from EMR. For around \$300,000 you get all the following: 16K CPU, typewriter, disc, printer, card and tape equipment, priority interrupts, communications controller, A/D converter, and ASSET, our own real time executive, with batch processing and FORTRAN IV. This works out to about 23 cents per minute on a lease basis. That's a real bargain for the fastest \*16-bit computer available today, and the only one with multiple asynchronous

*\*Adam Associates "Computer Characteristics Quarterly".*

memory bus structure to give an I/O rate of better than 5 megawords per second.

A well known drug manufacturer will be using this 6130 system in acquiring analog data from 32 lab experiments and converting it to digital values. When experiments are completed, the 6130 calls in application programs to process the acquired data and also continues receiving raw data from other experiments. Simultaneously other departments use the 6130 system to transmit and receive regular business messages from distant IBM Systems. In short, the 6130 system keeps everybody happy—at a price that gladdens the heart!

Interested? Write or call our marketing manager for more information about the ADVANCE 6130.

**EMR** COMPUTER

EMR DIVISION OF WESTON INSTRUMENTS, INC • A SCHLUMBERGER COMPANY  
8001 Bloomington Freeway, Minneapolis, Minnesota 55420 • Phone (612) 888-9581

## news briefs

information display can produce benefits and consider the actual and probable improvements which can be engendered through information display technology. Five draft copies and five copies of a 100-150-word abstract are due before Dec. 15 to: H. T. Darracott, Society for Information Display, 3325 Mansfield Road, Falls Church, Va. 22041.

**Joint Automatic Control Conference,** Univ. of Colorado, Boulder, Aug. 5-7, 1969. Full-length papers (no abstracts) dealing with all aspects of automatic control engineering and science are due by Nov. 15, 1968. One copy is to be sent to: Prof. W. E. Schiesser, Program Chairman, 1969 JACC, Dept. of Chemical Engineering, Lehigh Univ., Bethlehem, Pa. 18015; five review copies should be sent to: Prof. J. B. Lewis, Dept. of Electrical Engineering, Pennsylvania State Univ., University Park, Pa. 16802. All copies should indicate the society to which they are submitted. Sponsoring societies are: American Institute of Aeronautics and Astronautics, American Institute of Chemical Engineers, American Society of Mechanical Engineers, Fluid Power Society, IEEE, ISA and Simulation Councils, Inc.

**International Joint Conference on Artificial Intelligence,** Washington, D.C., May 7-9, 1969. Papers are requested in the areas of theoretical foundations of artificial intelligence, heuristic problem solving, theorem proving, pattern recognition, computer "understanding," linguistic research, integrated systems, man-machine symbiosis, hardware, software, applications, and psychological and physiological modeling. Manuscripts are due Jan. 15, and should be submitted to: Dr. Donald E. Walker, Program Chairman, IJCAI, The MITRE Corp., Bedford, Mass. 01730.

**Symposium on Information Processing,** Purdue Univ., West Lafayette, Ind., April 28-30, 1969. Papers are invited on all subjects concerning new results in information processing and related areas. Prospective authors should submit a title, 50-word abstract, and a rough draft of the paper by Jan. 15 to: Dr. John C. Hancock, Chairman, Purdue Centennial Year Symposium on Information Processing, School of Electrical Engineering, Purdue Univ., Lafayette, Ind. 47907.

**1969 IEEE Computer Group Conference on Real Time Systems,** Minneapolis, Minn., June 17-19, 1969. Subjects

of interest cover the spectrum of real-time considerations, including real-time systems for process control, message switching, inventory control, time-sharing, command and control, and biomedical computing. Papers are solicited describing new developments in software, languages, system organization and interface design, including peripheral equipment, special purpose systems, system models and analysis, and hardware. Potential participants are requested to submit for consideration a 50-word abstract suitable for publication in the *Computer Group News* and a 1000-word illustrated digest suitable for publication in the *Conference Digest*. Four copies of each must be submitted by Jan. 10,

1969, to: Donald L. Epley, Technical Program Chairman, 1969 IEEE Computer Group Conference, Dept. of Electrical Engineering, Univ. of Iowa, Iowa City 52240. ■

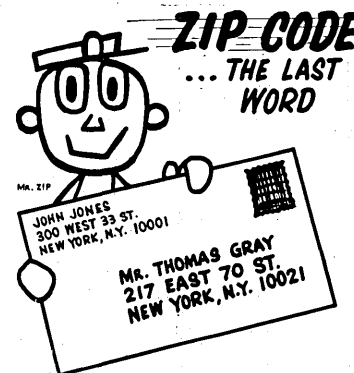

## A leased computer can save your company money.

(You can solve your computer leasing problems  
by coming to Talcott.)

There is a difference between computer leasing organizations. And Talcott's difference can mean big benefits to you. Talcott Computer Leasing is a division of James Talcott, Inc., a national, 114-year-old company with broad experience in all phases of corporate finance and equipment leasing.

In addition to data processing specialists who can help you evaluate your require-

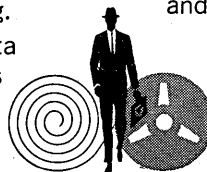

ments and obtain the equipment you need, Talcott Computer Leasing has the solid backing of over half a billion dollars in resources. That's important. Because it means when you lease with Talcott, you can be sure of financial responsibility and service, now and in the years to come.

For quick action, contact Truman F. Rice. The number to call: (212) 956-4123.

### TALCOTT COMPUTER LEASING

A Division of James Talcott, Inc. / Founded 1854  
1290 Avenue of the Americas, New York 10019 • (212) 956-4123  
Current resources: in excess of half a billion dollars

# O.K. So you're going to build a system...

## ANALOG & DIGITAL MODULES

There are more than 60 in the line, all compatible with each other, with our analog instruments and with the 703 IC systems computer. You design the logic; we'll produce a wire list and wire wrap, assemble and deliver checked-out hardware.

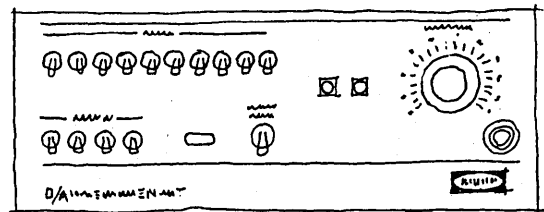
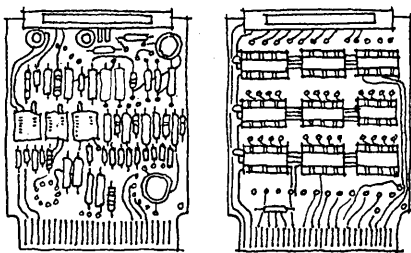

## DIGITAL-TO-ANALOG CONVERSION.

Several versatile digital-to-analog converters. You select number of channels and resolution. Built-in test and calibration.

## ANALOG-TO-DIGITAL CONVERSION

Multiplexing, sample-and-hold and analog-to-digital converters. With our **MULTIVERter**® and **MINIVERter**,™ all you do is choose number of channels, resolution and speed.

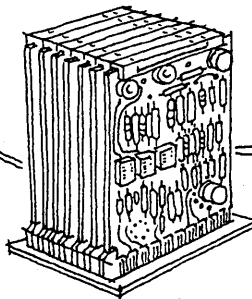



**Raytheon Computer can supply a powerful, inexpensive IC system computer, analog and digital IC modules and packaged analog instruments.**

These compatibly-engineered system components mean your system design, assembly and acceptance is accomplished in less time, at lower cost and with less work and worry.

If you want life to be more profitable, write or call today.

Raytheon Computer, 2700 South Fairview Street, Santa Ana, California 92704, Phone (714) 546-7160. Ask for Data File CB-160.

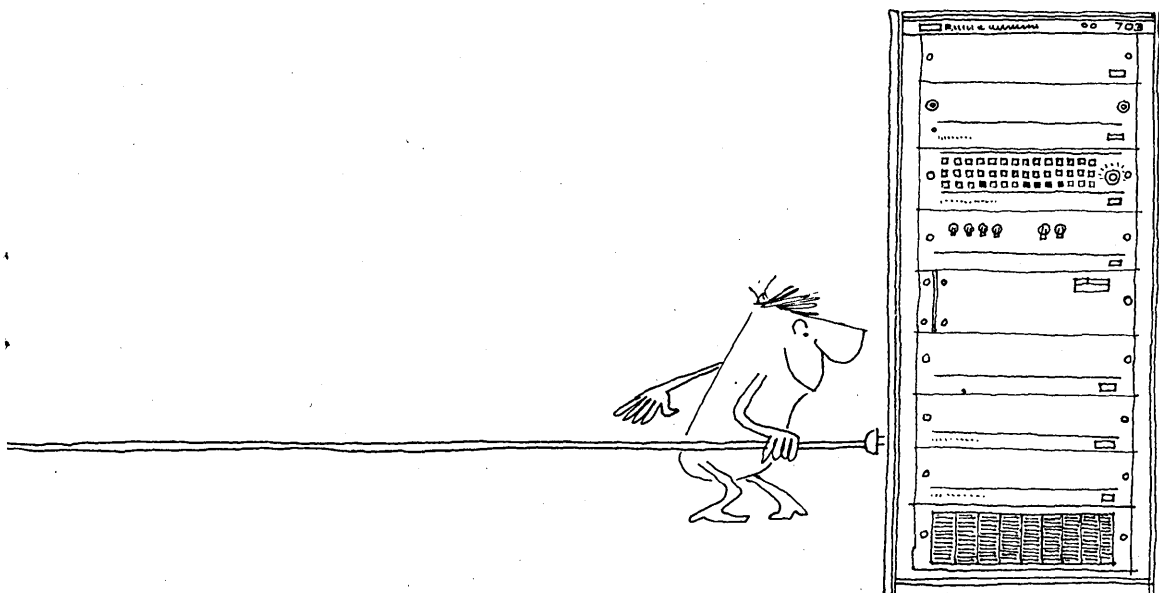

**703 IC COMPUTER**

The \$15,000 computer with \$1.50 spares. The 703's central processor is a single wire-wrapped master module board with plug-in IC's. A unique self-diagnosis locates circuit malfunctions, tells which IC to replace.

- 16-bit word length
- 1.75  $\mu$ sec cycle
- Up to 32K Memory
- Word and byte commands
- Wide range of peripherals
- Software includes executive, real-time monitor and real-time FORTRAN IV.



# image processing oil well log analyzing system

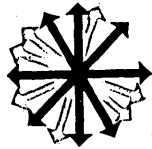

## system spotlight

*with this issue*

Datamation begins a new feature series—System Spotlight—that will describe briefly current computer applications of general interest. Each system discussed will be new, but we will include only those already installed and in operation. Information for the series is compiled by Compata, Inc., consultants in digital systems, logic design, and applications programming.

### MOBIL OIL Dallas, Texas

#### computer and peripherals

Information International visual image processing system. The programmable film reader includes:

Digital Equipment Corp. PDP-9, with 1 usec. cycle time, 8192 18-bit words of core storage

Datamec tape drive: 200, 556, 800 bpi; IBM compatible; 45 inches/sec.

Digital Equipment Corp. paper tape reader/punch: 300/50 cps

Teletype keyboard/printer

#### application

The oil industry collects a mass of data

in the form of well logs that must be analyzed to determine the amount of oil still available for recovery. This job has been done manually, but Mobil Oil Corp.'s Geophysical Services Center in Dallas has installed a computer-based system to process both new and historical log data.

At Mobil Oil, microfilmed copies of oil well logs containing as many as seven traces are analyzed and interpreted by a Programmable Film Reader (PFR) developed by Informa-

Graphics console and DEC computer, (below)



tion International, Los Angeles. The logs are recorded on graph paper with amplitude and depth scales. The program identifies and tracks each of the seven curves and separates them from the grid background. The depth scale markers are identified and used to establish the depth location of the digitized output. The amplitude scales are measured and used to calibrate the curve amplitudes.

### film reading rates

The PFR differs from "flying spot" scanners in that the latter scan an entire film frame in a rectangular pattern and store the resulting data from all points of the matrix. The PFR scan is under control of a stored computer program which locates and tracks only the data of interest. It can access over 150 million bits of information in each film frame. Logs recorded on film can be read at the rate of 3,000 log feet per minute.

### reading process

The film reading process involves the selective scanning of film by a rapidly moving, programmable light point generated by a cathode ray tube. Logs to be read are transferred to 35 mm sprocketed microfilm and inserted in the film handling unit of the PFR. A source of light is produced at a programmed x-y location on the face of the programmable light source, and then divided into two beams (see block diagram).

One beam passes through a lens and is focused on the microfilmed oil well log.

For comparison, the other beam is passed through a second lens along a path which does not include the film being read.

The two signals pass through a difference amplifier for density measurement. A 6-bit number representing the density is then transferred to the stored program control unit.

The oil well log reading program evaluates the data, eliminates grid and extraneous marks, determines the location of the trace and determines the location of the next light point.

### software

Software used in the Mobil system consists of four main packages: 1) applications programs, 2) utility programs, 3) systems programs, and 4) functional subroutines.

The application programs include oil well log analyzer and recorder routines and graphics recorder program. The utility package provides an image digitizer and magnetic tape display program. The systems programs involve a scope editor, assembler, paper tape

debug, and routines for magnetic tape and paper tape punching and reading. There are eleven functional subroutines. They are the microscan program, the film scanner package, light pen tracker, text display and window display, a knob position reader and parameter read-display, CAL handler, interrupt routines and magnetic tape loader and dumper.

### hardware

The PFR system consists of an optical/mechanical unit, a graphics console, and a stored program control unit (DEC computer) with magnetic tape input/output.

#### Optical/mechanical unit

- Film: takes 70, 35 and 16mm film full frame advance or reverse 35mm pull down: 40 ms
- frame positioning: 0.001 inch
- Programmable resolution: 16,384 x 16,384 programmable positions
- Light Source: 0.00018 inch between positions
- addressability:  $2^{14} \times 2^{14}$  (16K x 16K)
- spot size: film plane—16mm: <4 microns
- 35mm: <8 microns
- 70mm: <16 microns
- tube face—<18 microns
- 1/4000 minimum diameter, full scan
- measurement resolution:  $\frac{1}{2}$  spot position (+1 part

- in 16,384)
- accuracy: .05%
- linearity: .05%
- repeatability: 1 spot diameter
- positioning time: 5  $\mu$ s minimum, adjacent points
- 50  $\mu$ s maximum, extreme point separation

read time: 15  $\mu$ s  
Scanner Modes: point scan or TV raster scan

#### Graphic Monitor

- Type 21 inch phosphor crt, 11 x 11 inch display programmable; slave to precision light source
- Resolution 800 TV lines
- Input light pen keyboard digital shaft encoders



Console display of log as read by film reader (above). Scanning system is shown below.

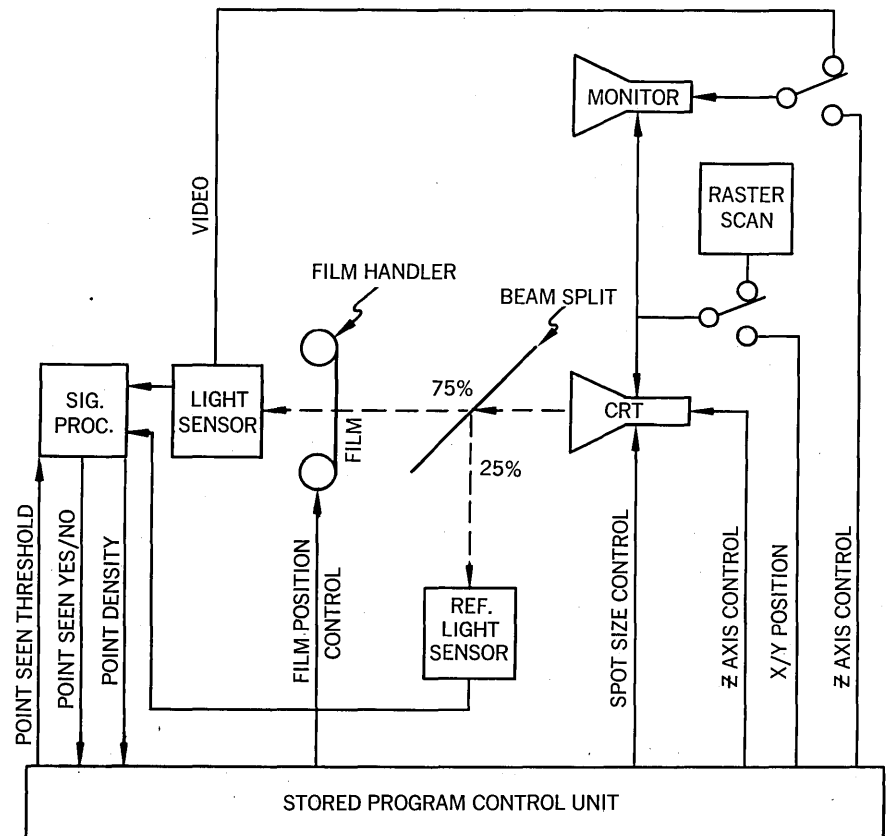

**Here comes**

**with a radical  
new answer to  
training your  
entire EDP staff**

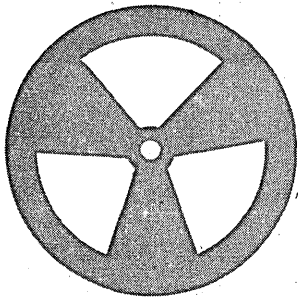

The answer is Edutronics' Animated Computer Education (ACE), a radical new technique of distilling concepts into easily grasped form on motion picture film.

Not a filmed lecture — not a filmic demonstration of equipment — ACE employs animation, sound, time, and color in a powerful new way to teach concepts and relationships... on a one-to-one basis... in a structured learning environment... more rapidly and with greater comprehension than any other technique known today.

But the method is only the beginning. Edutronics will offer a complete curriculum of ACE courses on film for every EDP staff job — in systems analysis, in programming, and in operations — from trainee levels to management... films are cartridge-loaded for utter mechanical simplicity.

These courses are complete — with projection equipment, workbook materials, and our comprehensive Career Development Guide — for use as you need them, at your convenience.

We'll tell you more about specific courses, availability, and pricing in our new ACE brochure. Write today.

**edutronics**

2790 Harbor Boulevard, Costa Mesa, Calif. 92626  
(714) 546-1144

CIRCLE 50 ON READER CARD

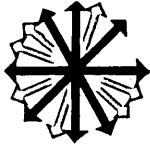

# new products

## logic laboratory

The Model 401B Logic Laboratory is a flexible system for breadboarding and teaching logic design. It consists of a 32" by 18" Logicboard, a set of 60 Logicubes and 150 patchcords. Power from an internal, regulated supply is applied to the Logicubes when they are placed anywhere on the board in any one of four orientations. Each cube has a replaceable indicator lamp for each output, eliminating the need for continuous checking with a voltmeter.

Each Logicube performs a single logic function, indicated by the symbol on its face. Among the 25 available functions are: AND, OR, NAND, NOR, JK FLIP-FLOP, FULL ADDER, BCD COUNTER, NIXIE COUNTER, and 4-BIT PARALLEL

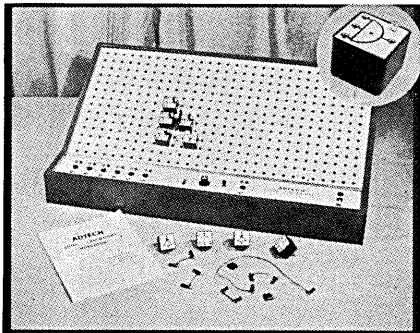

ADDER. TTL IC's are used throughout the unit, and circuits built with the Model 401B are identical to their logic diagrams, which eliminates the need to "translate" between circuit and diagram and leaves a student free to concentrate on fundamentals. The system may also be used for feedback checking and debugging. The complete Logic Laboratory is priced at \$1,547. Additional Logicubes are available from \$12-\$15. ADTECH, INC., Honolulu, Hawaii. For information:

CIRCLE 160 ON READER CARD

## optical page reader

The IBM 1288 optical page reader can read printed alphanumeric characters and handwritten numbers. The unit is said to translate information into 360 language at a rate of about 840 single-spaced typewritten pages an hour. Smaller forms, such as utility bills, can be read at about 19,600 an hour. The machine can read unformatted data,

such as typewritten text, as well as formatted items. The 1288 reads documents ranging in size from 3x6.5 to 9 x 14 inches.

The letters and numbers read by the

1288 are from the USA Standard Character Set for Optical Character Recognition. This type face is produced by certain electric typewriters, including the IBM Selectric. Hand-printed numbers, a numeric Gothic font, and pencil marks in pre-defined document areas can also be recognized. The 1288 is designed for use with 360/25, /30, /40, /50. It operates under 360 DOS and TOS.

Initial deliveries are slated for the first quarter of 1970. Rental is \$4.9K a month, purchase \$230.3K. It was also announced that full alphabet-reading capability, similar to that of the 1288,

## PRODUCT OF THE MONTH

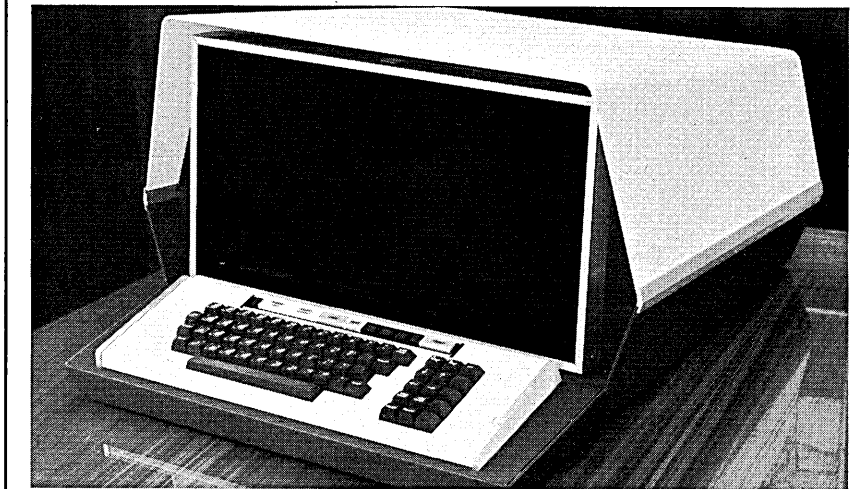

The DATA-SCREEN Display Terminal is a self-contained unit that includes a crt display, I/O logic, character generator, refresh core memory and an electronic keyboard. The crt has a 7½" by 9½" viewing area and is horizontally oriented, allowing characters to be displayed in 16 rows with 32 characters per row for the 512-character model and 64 characters per row for the 1,024 character model.

The terminal is designed to operate over communications circuits at any serial rate up to 4,800 bps. High-speed parallel interface is also available for direct computer access. The unit features a detachable keyboard that has provisions for up to 30 editing and special function keys, as well as a standard typewriter-style alphanumeric section. Editing features include complete cursor maneuverability and insert/delete functions to aid text composition. The DATA-SCREEN has a segmented transmission capability for conversational mode applications that lets the operator and computer transfer a message while the remainder of the displayed text remains unaltered.

Fixed and variable field text allows the user to respond to formatted information by "filling in the blanks" and then transmit only the variable text, reducing communications link usage. A tab function allows rapid formatting of special forms and text organization.

The company's DATA-PANEL-R display system may be utilized as an integral part of the DATA-SCREEN terminal. A darkened glass panel is placed in front of the crt and forms the viewing surface of the terminal, providing heightened character display contrast. It also forms the viewing surface for the DATA-PANEL-R system modules, which are attached to the panel on either side of the crt viewing area and employ film to present status or fixed format information in color.

The terminal is self-contained but can be supplied without the enclosure for 19" relay rack mounting or mounting in the user's console or enclosure. The unit is priced from \$5K to \$7K, depending on options. TRANSISTOR ELECTRONICS CORP., Minneapolis, Minn. For information:

CIRCLE 161 ON READER CARD

# The Wraparound that doesn't Wriggle.



*The way we look at it, it's the tape reel that should be moving, not the wraparound case.*

*Our case opens just so far and stops — to release tape or receive it. Lift reels out. Drop in. The case holds itself in a circle — still connected at the latch. And the patented shelf all around supports the reel, aligns it with the recessed dust seal in the case when you snap it shut.*

*Of course ours meets the basic requirements, too. It's got the new thinness, the hook for suspension storage systems, finger grip for roll-in storage, and plenty of toughness to survive drops.*

*But it doesn't cost any more.*

CIRCLE 88 ON READER CARD



**Data Packaging Corporation**  
205 Broadway, Cambridge, Massachusetts  
Tel. (617) 868-6200 TWX: 710-320-0840

## new products

will be available as an option for the 1287 optical reader in the second quarter of 1969. This feature can be installed at the customer's site. IBM DP DIV., White Plains, N.Y. For information:

CIRCLE 162 ON READER CARD

### data link

The Model 1000 Datacoupler is a data acquisition interface with insertable printed-circuit-card options that tie it to a digital magnetic recorder, a computer, a printer and other automated equipment. Typically, with the recorder option, the Model 1000 links the tape recorder in record or playback with multichannel analog or digital sources, computers, telephone data sets and Teletype equipment. Data format to recorders consists of up to 999 3-digit files, each containing from 1 to 999 records programmable by the operator. Any record contains from 0 to 999 programmable scans, each of which has a variable number of words, dependent on the number of input sources. Words have two to six characters, and selectable character rates range from 1 cps to 100K cps.

Options include analog multiplexor,

A/D and D/A converters, digital multiplexor, intervalometer, playback mode and search. Circuitry is entirely solid state, and the basic unit allows for insertion of up to 18 option cards. Price ranges from \$3K to \$10K, depending on the options selected. Delivery is 60-90 days. DATATRON, INC., Santa Ana, Calif. For information:

CIRCLE 163 ON READER CARD

### small keyboard

The Multiple Page Keyboard (MPK) is a device that enables the operator of a computer-oriented system to control a



total of 327,360 functions through the use of removable books of 10 plastic pages. The keyboard will accept a maximum of 1,023 books (one at a time), each providing control of 320 functions. When a book is placed in position, the 32 keyboard buttons protrude through the appropriate holes in the pages, above which adhesive labels indicate the function the button (in combination with other buttons) controls. The unit works in conjunction with a crt and is designed for installation in the operator's console of control systems for the military and for industrial systems such as pipeline transmission and distribution of water, gas and oil, manufacturing and process control and inventory control. PHILCO-FORD CORP., Houston, Tex. For information:

CIRCLE 164 ON READER CARD

### data control units

Honeywell's control units transfer data between display units and a Series 200 computer at 42K cps for instant display of 768 characters of data on 7" x 9" crt's called Visual Information Projection (VIP) units. This transfer rate is 140 times as fast as the current 300 cps with the equipment, and information can be sent directly to the same computer from several VIP units with

## ComChart from COMRESS \$195

ComChart is a proprietary program developed by COMRESS which automatically "draws" assembly language and design level flowcharts for 360 Systems.

Chart "A" draws flowcharts from existing 360 assembly programs. The source deck is the input—no modifications are necessary.

Chart "D" lets you sketch in narrative form, the logic of programs in the design stages. It uses a free-form input language which can be learned in less than one hour. From this design-level input flowcharts are automatically produced on the computer.

ComChart operates on any 360 with 65K memory under OS or DOS. ComChart has hundreds of uses in program design and analysis, testing, maintenance and training, as well as increasing overall programming efficiency.

For a descriptive brochure and sample charts write to:



# COMRESS

2120 Bladensburg Rd., N.E. •  
Washington, D.C. 20018 • (202) 529-0360

CIRCLE 53 ON READER CARD

September 1968

## COMPUTER SCHEDULED MAGNETICALLY

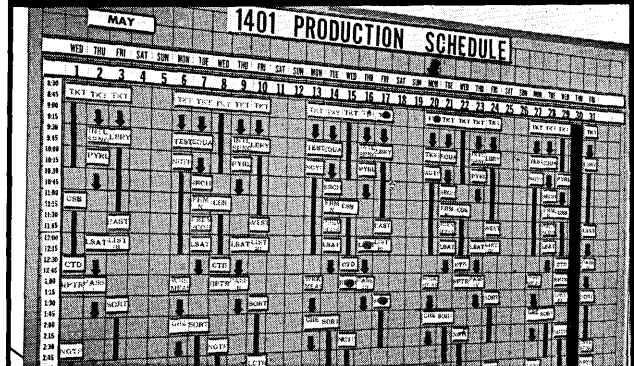

- Keep your computer running—not idle.
- Schedule in 6, 10, 15 & 30 min. cycles, for daily, weekly or monthly periods.
- Know in advance when slack periods or heavy work loads are coming.
- Make changes & additions immediately.
- Every hour saved saves you \$20-\$40-\$60.

Write for FREE 28 Pg. Illustrated Catalog— DA9

**METHODS RESEARCH CORP.**  
70 Willow Ave., Staten Island, N. Y. 10305

CIRCLE 52 ON READER CARD

# Link's APD-5000 Microfilm Plotter, more information per frame, per dollar.

The Link APD-5000 Microfilm Plotter has a 4096 x 4096 resolution that allows the recording of more information per frame.

Computer-generated information is recorded at 100,000 points per second with variable line widths. Both whole value and incremental plotting are a part of the plotter's operation. The comparatively low purchase price includes a third generation hardware unit with third generation software.

For details, write: Advanced Technology Sales, Department D, Link Group, 1077 East Arques Avenue, Sunnyvale, California 94086, or phone (408) 732-3800.

**LINK GROUP**

**GENERAL  
PRECISION  
SYSTEMS INC.**



# Straight talk to decision-makers who cannot afford to compromise on reliability in selecting a disk pack.

The new "Scotch" Brand 906 Disk Pack is made for those who demand the ultimate in reliability and dependability in random access data storage.

It is a product of 3M Company's 21 years of technological experience in the development and perfection of magnetic coatings . . . a result of the same advanced technology that produced the standards for computer tapes: "Scotch" Brand 777 and 777 GP.

Here are some of the reasons "Scotch" Brand 906 Disk Packs belong in your data processing system:

**1.** 3M Company manufactures its own oxide, binder and substrate. This single-source technology assures consistent quality control at all stages of manufacture to consistently produce a uniform product.

**2.** "Scotch" Brand 906 Disk Packs surpass all industry standards for performance. They are guaranteed error-free when used on IBM 1311, 2311 or equivalent drives.

**3.** The oxide concentration and the coating thickness on each "Scotch" Brand Disk is electronically regulated to control the critical level-of-output factor (Read Pulse Amplitude). Too thin a coating, even with the proper amount of oxide in the dispersion,

results in too little output. Too thick a coating or too high an oxide content will produce excessive output.

**4.** Every "Scotch" Brand 906 Disk Pack is *total area* tested. This goes far beyond conventional initialization procedures: every recordable area that can be reached by a head is tested for possible error-producing coating flaws.

**5.** The polymers and oxides used are the finest quality available. They are specially prepared and blended in a unique formula, and are applied to the substrate by a 3M-developed coating technique.



**Uniform coating**

**6.** The surface waviness of the substrate and the coating thickness on "Scotch" Brand 906 Disk Packs are held to minute tolerances to assure consistent flying altitude of heads and minimize undesirable signal modulation.

**7.** "Scotch" Brand 906 Disk Packs are finished by a process that assures radial as well as circumferential smoothness. In many finishing processes, to assure that the finishing marks are parallel with the recording track geometry, radial surface smoothness is often sacrificed.

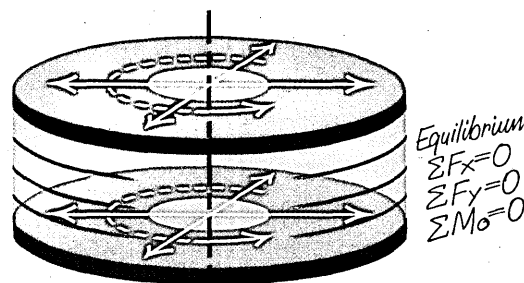

**Dual-plane balanced**

**8.** "Scotch" Brand 906 Disk Packs are dual-plane balanced. Dual-plane balancing produces conditions of equilibrium within each pack that eliminates the problems of vibration and wobble possible with less sophisticated, single-plane balancing systems.

**9.** The rigid center mounting in "Scotch" Brand 906 Disk Packs is engineered to prevent shifting of disks from their balanced position, thereby avoiding wobble or vibration in subsequent use.

**10.** Each "Scotch" Brand 906 Disk Pack comes in a strong, durable LEXAN® canister that assures safe transportation and storage. A built-in foam rubber seal keeps the contents dust free.

**11.** "Scotch" Brand 906 Disk Packs are available for sale or lease.

For more information on "Scotch" Brand Disk Packs, see your 3M representative, or write: Market Services Department, Magnetic Products Division, 3M Company, 3M Center, St. Paul, Minn. 55101.

"SCOTCH" IS A REGISTERED TRADEMARK OF 3M CO. "LEXAN" IS A REGISTERED TRADEMARK OF GENERAL ELECTRIC COMPANY.



# Who said a computer shouldn't get promoted from within?

All day long you manage a computer installation, and what happens? Management thinks the computer's a genius and you're its assistant.

This situation could go on indefinitely unless you do something a computer couldn't possibly do. Like promote a better deal on computers to your management.

For example, you can buy "used" computers for as little as 25% of new cost, perhaps saving your company hundreds of thousands of dollars.

Machines are available with known technical ability that have huge, easily accessible libraries of programs. And with hundreds of people already trained in their operation and programming.

IBM recently announced a new policy that brings hard security to machines as they move from user to user. It pro-

vides subsequent owners of IBM machines with the same maintenance, education, Programming Systems Maintenance and site planning as the original buyer. Other manufacturers aren't far behind.

Certainly, there are jobs that require the unique capabilities of Third Generation equipment. We can even help there. But, if you're to get everything out of these new machines that they have to offer, using a low-cost Second Generation satellite system represents an important economy—for example, excess printing load and/or periodic management reports.

If what you need is more capacity and/or capability for your present Second Generation system, there's no more efficient way to get it than through The Computer Exchange.

Even those contemplating their first computer should examine this new alternative.

Talk to us, and the only problem you'll have is how to spend the extra

money you'll be saving to build your department.

What about surplus equipment? That's no problem either. Because The Computer Exchange operates like any other exchange, commodity or stock. If it has value, we'll buy it.

So if you'd like to know what you should buy or what you should sell, or what the right market price is for equipment, or how to lower cost and increase performance, or what's available, or anything and everything about "used" computers, you can't find a better informed group of computer people who talk your language.

Give us a call. Or stop in. Or let us stop by to see you. We'll help you promote a computer and outsmart it at the same time.

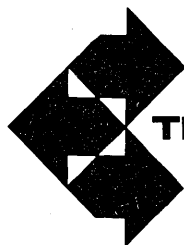

**THE COMPUTER EXCHANGE INC.**

30 East 42nd Street, New York, N.Y. 10017

(212) 661-5870

# This is 3M's Guaranteed Performance\* Tape that makes costly roll-by-roll certification obsolete.

What is "Scotch" Brand 777GP? A new Guaranteed Performance computer tape designed specifically for use on third generation computers—an extension of the high reliability "Scotch" Brand 777 Computer Tape except that it does not require roll-by-roll certification.

\*What performance can I expect from 777GP? With 777GP there are no read errors. In this critical area you will receive the same long term reliability as with certified "Scotch" Brand 777 Computer Tape. (For detailed specifications and performance characteristics ask your 3M representative for specification sheet M-CL155.)

How can 3M assure such performance? Because 3M's exclusive binder formulation has eliminated oxide re-deposits that cause read errors, and today's third generation dual-gap head computers now compensate for minor tape flaws with no loss of data. In addition, 3M's advancements in manufacturing technology have reduced minor tape defects to the point where roll-by-roll certification is no longer a valid investment.

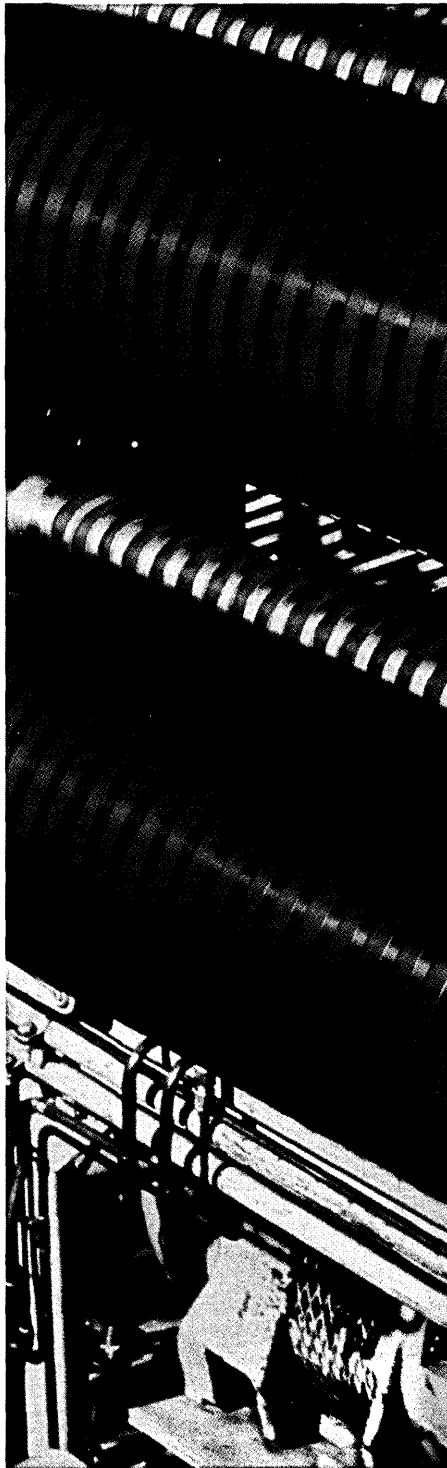
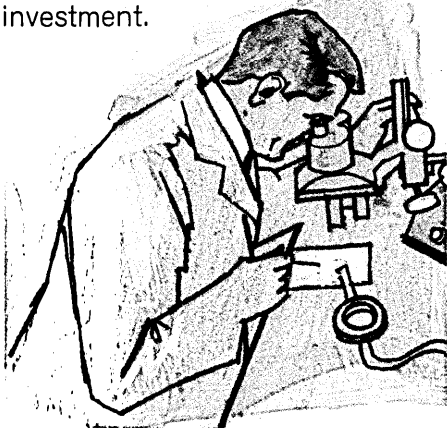

How is 777GP quality assured? There are more than 100 distinct quality control checks in the manufacture of every roll of 777GP. We have replaced outmoded roll-by-roll certification with automated in-process electronic testing. You can't "inspect" quality into a tape, it has to be there to begin with.

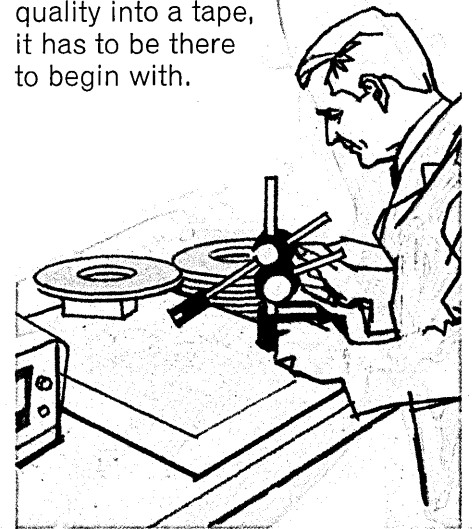

For what performance capabilities is 777GP recommended? 777GP performs at all bit densities to 1600 bpi (3200 fci).

Is "Scotch" Brand 777 certified computer tape still available? Yes, for those who feel the added cost of certification is warranted because the information being recorded or stored is irretrievable and even the remotest chance of a write-skip cannot be risked.

I'm interested in trying your new "Scotch" Brand 777GP Computer Tape. What do I do now? See your 3M representative. Or write: Market Services Department, Magnetic Products Division, 3M Company, 3M Center, St. Paul, Minn. 55101.

Who knows more about computer tape than  
the people who perfected it?

Magnetic Products Division **3M**  
COMPANY

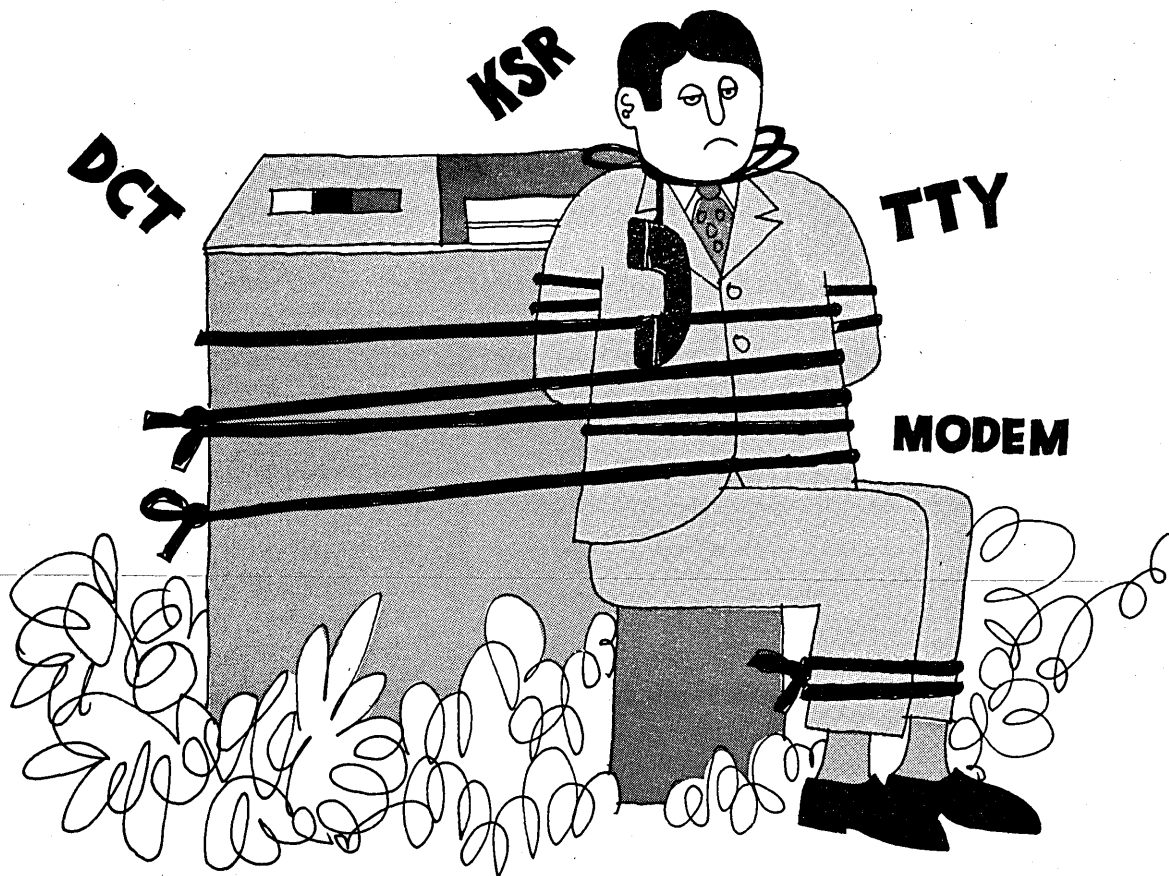

## Are you tied up in communications problems? Let SCC untie you.

There is an economical way to get out of this communications tangle... SCC's **NEW 4700, 16 BIT, 920 NANO-SECOND**, Digital Computer gives you that complete **REMOTE CAPABILITY** at a price you can afford! It's

- Fully buffered communications
- Enters data directly into core without CPU intervention
- Interfaces to DC loop
- Data line drivers for short haul transmission without Modems
- ASCII Compatible
- RS 232 or MIL 188B Interface
- 32 full duplex lines per channel

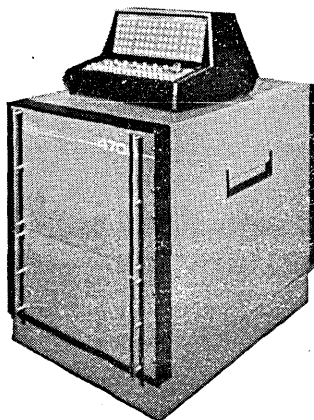

the first small machine with a high throughput rate and a systems capability to handle **ALL** your communications requirements.

*Take a look at a few of these capabilities:*

- Wide variety of speed dependent and user oriented remote devices
- Modular construction permitting system tailoring to specific user needs
- Microprogrammed — to implement use of optional instructions
- Hardware for double precision and floating point arithmetic
- Full Software package — including FORTRAN IV and Real Time Monitor

**"THE COMMUNICATORS" FROM SCC... Whatever Your Computer Application — Be Sure You Talk With SCC Before You Buy.**



## Scientific Control Corporation

P.O. Box 34529 • Dallas, Texas 75234 • 214 — 241-2111 • TWX 910-860-5509

**EASTERN REGION**  
7100 Baltimore Ave., Suite 105  
College Park, Maryland 20748  
301 - 779-2510

Holiday Office Center, Suite 96  
Huntsville, Alabama 35801  
205 - 881-8805

1222 Route 46, Suite 217  
Parsippany, New Jersey 07054  
201 - 335-3001

2024 Riverdale Street  
West Springfield, Massachusetts  
01089  
413 - 781-0063

**CENTRAL REGION**  
612 Exchange Bank Building  
Dallas, Texas 75235  
214 - 358-1331  
400 Brookes Lane, Suite 125  
Hazelwood, Missouri 63042  
314 - 848-3500  
3110 S.W. Freeway, Suite 12  
Houston, Texas 77006  
713 - 526-5721

**WESTERN REGION**  
780 Welch Road, Suite 208  
Palo Alto, California 94304  
415 - 328-8980

306 Hirschmann Building  
9550 Flair Drive  
El Monte, California 91731  
213 - 443-0143

## new products

only  $\frac{1}{4}$  sec. maximum delay. The high-speed system involves three units: (1) a Type 335 high-speed interface that connects to a Type 323 universal control unit; (2) a Type 386 high-speed control unit for the Series 200 computer to allow connection of the Type 335 interface; and (3) a Type 386-1 channel adapter to permit the addition of seven more Type 323/335 universal control and high-speed interface units. The first units will be installed at Children's Hospital Medical Center, Boston, this fall, and first delivery on following units will be in April, 1969. HONEYWELL EDP, Wellesley Hills, Mass. For information:

CIRCLE 165 ON READER CARD

### mass storage drums

Three mass storage head-per-track drums for use on medium- and large-scale Honeywell Series 200 computer systems can, according to a company official, increase throughput on—for example—an 8200 computer system by 55%. Type 265 drum stores 2.1 million characters, has a transfer rate of 300K cps, and 512 read/write heads. Type 266 has 1,024 read/write heads, and stores 4.2 million characters; transfer rate is also 300 K cps. Type 267 differs from the 266 only by the transfer rate: 1.2 million cps. Average access time for all three units is 8.6 msec. Deliveries are scheduled for mid-'69. HONEYWELL EDP, Wellesley Hills, Mass. For information:

CIRCLE 166 ON READER CARD

### multiplex system

GE's DigiNet 150 series can multiplex up to 15 simultaneous full duplex time-sharing data communications channels onto a single voice-grade telephone circuit. The equipment will enable the communications processor to transmit

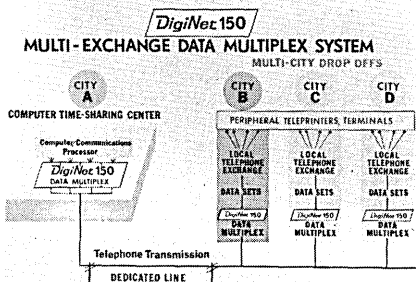

and receive data from remote switched network data sets, such as Western Electric's 103A and 103C or GE's DigiNet TDM-111, through a single 3Khz telephone channel at up to 150 bps. Up to nine 150 baud and up to twelve

## Introducing...



# ...the all-new 1- $\mu$ sec memory with the best margins in the business.

Take all the features you want in a high-speed core memory system, package them in 5 $\frac{1}{4}$ " of rack space, and you've got the new VersaSTORE III from Varian Data Machines.

The VersaSTORE III gives you 1- $\mu$ sec cycle time, 450 nsec access time. Storage capacity is from 256 to 4096 words up to 36 bits, or 8192 words up to 18 bits. In addition, it is expandable to 16,000 words up to 36 bits with our Party Line feature. It is furnished fully wired for its highest storage capacity, allowing quick memory expansion by plugging in a large core stack and additional data cards.

VersaSTORE III's servoed current drive system compensates for temperature changes; gives it unmatched

margins at elevated temperatures. In addition, the new memory provides easy interfacing and great I/O flexibility, with input levels of  $\pm 0.5V$  and 2.5V to 24V, output of any voltage from 1V to 15V, and drive current up to 80ma.

Front panel display is provided for all registers, and it comes with timing and control flags, test points, and optional self-test for simplified system checkout. Matching power supplies are available.

VersaSTORE III is the third, most advanced, and newest of our highly successful VersaSTORE designs. We've prepared an equally new brochure full of vital information about our new memory—we'll be glad to send it to you, just call or write.

 **varian data machines**  
a varian subsidiary  
2722 Michelson Drive • Irvine, California 92664  
(714) 833-2400 • TWX (910) 596-1358

CIRCLE 58 ON READER CARD

# **EMR** wanted a high-speed printer that their customers could forget!



## ...so they chose the ***P* data products** LINE/PRINTER\*

■ The Computer Division of EMR wanted a high-speed printer that would complement their exceptional 6000 and 6130 Computer Systems... a printer that would operate day after day without downtime and without stopping for periodic adjustments. They wanted *proven* reliability, the finest print quality available, and ease of maintenance.

Mission impossible? Not at all! The LINE/PRINTER is famous for providing these features to meet the rigid requirements of OEManufacturers... and more.

Data Products' exclusive one-piece print hammer is virtually friction-free, and requires no periodic adjustments. Freedom from wear reduces maintenance and downtime to a bare minimum. Controlled hammer flight time, short dwell time, and clutchless paper feed contribute to the sharp, non-smear print out that our customers' customers love to see.

Keep *your* customers printing... not adjusting. Write Data Products, 8535 Warner Drive, Culver City, Calif. 90230, for our latest LINE/PRINTER literature.

**Data Products manufactures LINE/PRINTER™, DISCfile®, Core Memories, Tape Cleaners, Off-Line Printer Systems, Card Readers & Punches**

***P* data products**

*"the peripheralists"*

\*Trademark of data products corporation

## new products

110 baud signals can be multiplexed on an unconditioned 3002 telephone channel.

When a time-sharing user wishes to access the system, he places a local phone call into his area's telephone company's exchange. This alerts a rotary that scans the data channels for an open circuit. When one is found, the user's call is sent over that channel to a data set connected by wire to one of four remote buffer units. After appropriate conditioning, the signal, which could be one of many, is transmitted via a dedicated transmission line to a corresponding computer interface unit at the computer center. There it is detected and forwarded to the time-sharing system. The communication path is full duplex, with the output information following the reverse path back to the user. GE COMMUNICATION PRODUCTS DEPT., Lynchburg, Va. For information:

CIRCLE 167 ON READER CARD

### automated lab system

LIMS (Laboratory Information Management System) is designed for medical labs, which now number over 17,000 in the U.S. and seem a fair market target, and comprises a proprietary software program and compatible hardware (currently an SDS 940). The lab is connected by teletypewriter to the remote computer using time-sharing principles, and communication is in "everyday" terms with minimal personnel training. The system handles both medical tests and accounting tasks, is capable of flagging entries, and has 1K tests in its test code dictionary. Lease cost for an average lab is \$700 per month for the basic system, and the company believes it can halve this cost in one to two years. DATA-MED, INTELLECTRON, INC., Sherman Oaks, Calif. For information:

CIRCLE 168 ON READER CARD

### design system

TLS (Total Logic Solution) is a hardware/software package designed to enable systems engineers to go immediately from paper design to prototype testing through a combination of computer-aided design and numerically controlled wiring techniques. A design is fed into a computer—using free field programming techniques—and the machine searches its memory for optimum, standard IC's (or discrete component analog and power functions), and then couples these together, forming the system. The computer then generates a wiring list on paper tape,

# Close the efficiency gap between your computer and the mailbox

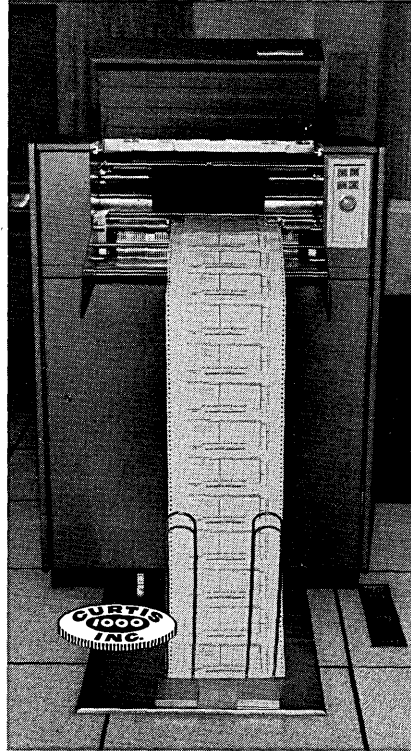

CHAIN-O-MATIC CONTINUOUS FORMS-IN-ENVELOPES

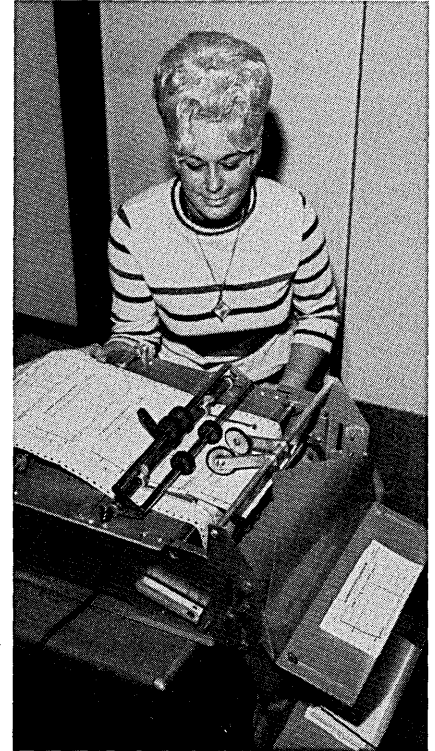

NO INSERTING OR SEALING JUST STRIP AND MAIL

When you make mailings of computerized information such as billing, follow-up notices, verification of accounts, and 1099's, you'll save time and errors by printing out on Curtis 1000's CHAIN-O-MATIC continuous forms-in-envelopes. Information, name, and address are printed out on these units, which have a carbonless form preinserted and presealed inside each envelope. Only the name and address show through the envelope window. Strip the forms-in-envelopes and mail. That's all there is to it!

Sound like a better way to handle your periodic mailings? It is. In fact that's the way it is with all Curtis 1000 products. We continually look for better ways to make each of our envelopes and business forms more useful to you. Help you do a job better, faster, more economically.

Interested? Use the reply card or write to Curtis 1000 Inc., Box 28154, Atlanta, Georgia 30328.

## CURTIS 1000

making envelopes and forms  
more useful to you

CIRCLE 60 ON READER CARD

# Lockheed's new bulk-capacity memory system costs just a little bit a bit.



1½¢

Seems a bit hard to believe, but it's true. Based on 1 million words at 32 bits, Lockheed's CM-300 costs as little as 1½¢ per bit. □ Lockheed built the CM-300 to fill the memory system gap. It's a new class of random access, EDP peripheral storage system. It couples bulk capacity (up to 32 million bits) with the speed of some smaller systems (full cycle time—2 to 4 microseconds). Inherently high operating margins are provided by its 2½D, 2 wire organization. And this, combined with Lockheed's worst-case design criteria, makes the CM-300's peripheral storage capability the most reliable today. □ Take the first step toward filling your memory system gap. Inquire about the new CM-300 now. Write: Memory Products, Lockheed Electronics Company, 6201 East Randolph Street, Los Angeles, California 90022. Write for "Bulk Core Memories."

**LOCKHEED  
ELECTRONICS  
COMPANY**

A DIVISION OF LOCKHEED AIRCRAFT CORPORATION



## new products

which is fed into a numerically controlled wiring machine that wires a TSL back plane. The company claims that small volume manufacturers can save 20 to 30% in design costs. DATA TECHNOLOGY CORP., Mountain View, Calif. For information:

CIRCLE 169 ON READER CARD

### systems computer

The Decade 70/2 is a 16-bit machine with a 4K word memory, expandable to 16K words, and provides multiply and divide, decimal as well as binary arithmetic, direct memory access, memory protect, memory parity, and automatic power shutdown and re-start. It has a 900 nsec cycle time and the software includes FORTRAN IV, a one-pass assembler and utilities. The machine is designed for scientific and engineering application. Price is \$16,700. DECADE COMPUTER CORP., Huntington Beach, Calif. For information:

CIRCLE 170 ON READER CARD

### digital recorder

The Model 60 digital tape recorder is the smallest IBM-compatible recorder using side-by-side standard 6" reels, each with 200' of tape providing a packing density of 200 bpi. It is designed for OEM, but can be purchased complete with optional case and control buttons. It accepts asynchronous data rates from 0-100 cps, and synchronous rates to 1,000 cps, provides rewind and sensors indicating begin-

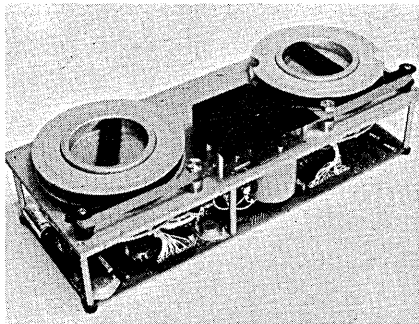

ning and end of tape. It operates on either AC or 12V DC, and generates all the IBM-compatible markings, gaps, and vertical and horizontal parity. Price is \$1,550, or \$1,850 with case and control buttons. CIPHER DATA PRODUCTS, San Diego, Calif. For information:

CIRCLE 171 ON READER CARD

### rax for /44

In another move to compete with GE's time-sharing setup, IBM's Remote Access Computing System (RAX), of-



## Comput-A-Phone

WE NEED YOUR ...

First Universal Alphanumeric Translator  
operated from any standard telephone ...

10 or 12 button Touch-Tone® or rotary dial!!!

**CTC** Comput-A-Phone

**ALPHANUMERIC or NUMERIC**  
(Both with TWIN TONE commands)  
**PHONE-TO-KEYPUNCH or COMPUTER**

# TRANSLATORS

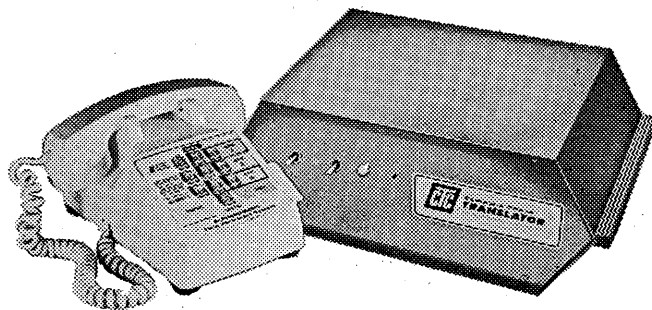

Non paperwork data entry systems and fast data transmissions are now possible with the CTC Comput-A-Phone Alphanumeric or Numeric phone-to-keypunch or computer TRANSLATORS, with Twin Tone control commands; a major breakthrough in remote, low cost, computer data entry. Computer Telephone Corporation's unique, *patented* capability to transmit data beyond the numerics to include alphabetical data and control signals ... with a tailored template placed on any Touch-Tone telephone immediately converts the phone to a miniature control console or multi-purpose keyboard for your special data entry being done ... any job from order entry to credit checking ... from banking transaction to shopping by phone.

HERE IS HOW TO GET IN TOUCH WITH US ...  
DIAL 301/345-7400

**CTC** COMPUTER TELEPHONE CORPORATION  
A SUBSIDIARY OF

**PHOTO MAGNETIC SYSTEMS, INC.**

10759 TUCKER STREET, BELTSVILLE, MARYLAND 20705

#### COMPUT-A-PHONE APPLICATION SURVEY CARD

If you are interested in having a Computer Telephone Corporation representative call on you to discuss the advantages of direct phone-to-keypunch or computer data entry via the *NEW* Comput-A-Phone Translators, please send the following information.

NAME OR ORGANIZATION \_\_\_\_\_

YOUR NAME \_\_\_\_\_

TITLE \_\_\_\_\_

STREET \_\_\_\_\_

CITY \_\_\_\_\_ STATE \_\_\_\_\_ ZIP CODE \_\_\_\_\_

AREA CODE \_\_\_\_\_ PHONE \_\_\_\_\_

#### ACTION DESIRED:

- PLEASE SEND LITERATURE  
 WE CAN SEE YOU AT ANY TIME  
 COME PREPARED TO DISCUSS  
(Fill in application information)

DATE \_\_\_\_\_

\*TOUCH TONE IS A REGISTERED TRADEMARK OF THE AMERICAN TELEPHONE AND TELEGRAPH CO

CIRCLE 62 ON READER CARD

## new products

ferred in '67 for /360/30, /40, and /50, will be available for the 360/44 in the fourth quarter of '68. A /44 with a 256K byte memory will support up to 63 IBM 1050 data communication terminals and 2260 display stations (a maximum of eight 2260's can be attached). FORTRAN and assembly language programs can be compiled, modified and executed, and programs stored in the RAX library may be used. IBM DP DIV., White Plains, N.Y. For information:

CIRCLE 172 ON READER CARD

### tape dispenser

The TAPEMATE mobile storage dispenser for mag tape comes in four models, the largest of which has a capacity of 164 tapes in four tape chambers. The top tape in each chamber is automatically positioned for efficient handling. AMF OPWARE DEPT., Essex, Conn. For information:

CIRCLE 173 ON READER CARD

### disc storage drive

The M2500 disc storage drive is interchangeable with the IBM 2311 but is 23% cheaper and 35% faster, accord-

ing to the manufacturer. It has a capacity of 7.25 million bytes and a transfer rate of 156K bytes per second. The maximum access time is 65 msec, with an average random access time of 48 msec. It features a "direct-seek" actuator that positions heads in a single mechanical action. Price is \$19,750. MARSHALL LABORATORIES, Torrance, Calif. For information:

CIRCLE 174 ON READER CARD

### punched tape reader & spooler

The RR-1002 photoelectric punched tape reader and the RS-1000 tape spooler operate at reading speeds of 1000 cps and rewind or search speeds of 2000 cps. The units are available in uni- and bi-directional models with 10½" diameter reels with tape storage capacities of up to 2,040'. Delivery is eight weeks ARO. REMEX ELECTRONICS, Hawthorne, Calif. For information:

CIRCLE 175 ON READER CARD

### language translator

The Model 180 Master Translator converts data flow between automated business machines ("old or new equipment—regardless of make or model") to the American Standard Code for In-

formation Interchange (ASCII). It will handle from 1 to 1,000 or more inputs, each having 1- to 7- (or more) bit words plus parity, and convert to the system common language. Parallel to serial conversions, and the reverse, are provided as required, and the operational modes include off-line, on-line, transmit, receive, duplex, and multiplex, with mixed speeds up to 50 KHz on an asynchronous basis. ADVANCED SPACE AGE PRODUCTS, INC., Alexandria, Va. For information:

CIRCLE 176 ON READER CARD

### program loader

The 1346 adds automatic program loading to the PDP-8, -8/S, and -8/I computers. The simple-to-operate device (see photo) will load a program up to 56 words long and will also start the computer at any location if de-

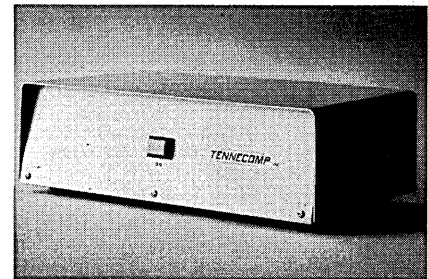

# If you don't have one... let's hope you never need it

Valuable taped data can be erased or partially destroyed by unexpected exposure to magnetic fields... generated by electrical equipment, electronic gear, air transport instrumentation, electrical storms, etc. Such loss is costly and inconvenient. The data may even be irreplaceable.

### Avoid these hazards

#### Use NETIC Tape Preservers

for storing and transporting your valuable tape data. They provide ideal insurance against such potential hazards. Available in numerous sizes and shapes to fit your needs.

Delivery from stock. Request catalog No. TP-1

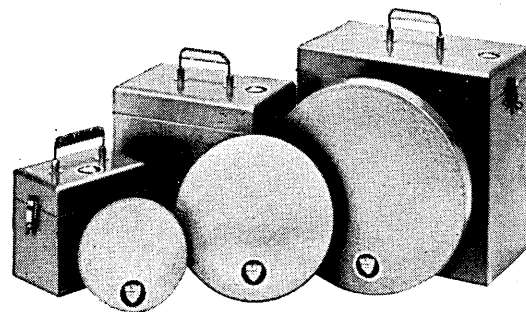

#### WEST COAST STOCKING REPS

Tech Rep Distributor Co.  
10606 W. Pico Blvd.  
Los Angeles, Calif. 90064  
213, 836-6806 • 213, 871-0055

Frauman Associates  
P.O. Box 969  
Menlo Park, Calif. 94026  
415, 322-8461



## MAGNETIC SHIELD DIVISION

Perfection Mica Company

1322 N. ELSTON AVENUE • CHICAGO, ILLINOIS 60622

Phone: 312, EV 4-2122 • TWX 910 221-0105

sired. Applications include the reading-in of basic program-loading routines and the bootstrap loading and starting of complete programs. An external ground signal allows remote operation. TENNECOMP, INC., Oak Ridge, Tenn. For information:

CIRCLE 177 ON READER CARD

#### circuit tester

The Model AUTO-256 is an automatic, solid state, digital IC tester for flat packs, dual in-line and TO-5 packages, and any IC family up to 16 pins. The tester requires no programming and has a test time of 5 ms. It is systems oriented and rack mountable, and all data available at the front panel is also available through a rear panel connector for integrating the unit into high speed handling devices. ARITECH CORP., Boston, Mass. For information:

CIRCLE 178 ON READER CARD

#### disc memory

The Model 10128 is a disc memory, 10" in diameter, with 128 data tracks, 32K flux reversals per track. The average access time is 8.4 msec, and the unit features automatic head lifters, which are coordinated with the start-up and shut-off speed of the disc, eliminating scrape at beginning and end. It has 1 to 16 parallel data lines, operates on 115 volts a-c single phase, and requires no erase current. Price is around \$3,500 in small quantities. ALPHA DATA, INC., Tarzana, Calif. For information:

CIRCLE 179 ON READER CARD

#### automated flowcharting

Dynachart is a computer-generated flowcharting system similar to Auto-flow, although the company claims twice as much logic per page as Auto-flow. Dynachart works in COBOL, permits a reasonable number of changes to be made without affecting page alignment, and is programmer-oriented and controlled. Page size, logical break points and maximum size of logical box may be controlled by simple input parameters. APPLICATIONS PROGRAMMING CO., Moorestown, N.J. For information:

CIRCLE 180 ON READER CARD

#### interactive graphics software

Adage, Inc., has developed a comprehensive software package for use with the Adage Graphics Terminal interactive computer graphics systems, including models AGT/10, 30 and 50. The new software, designed as an in-

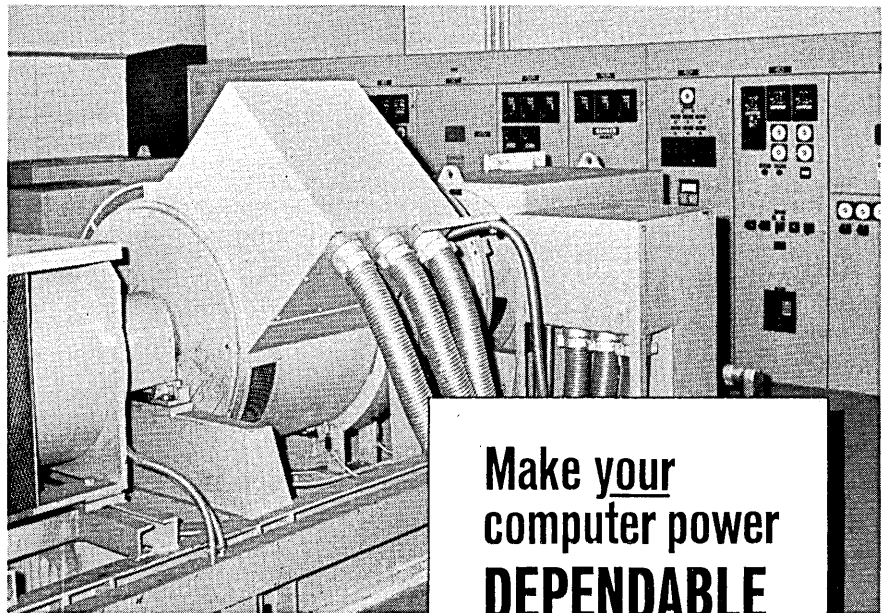
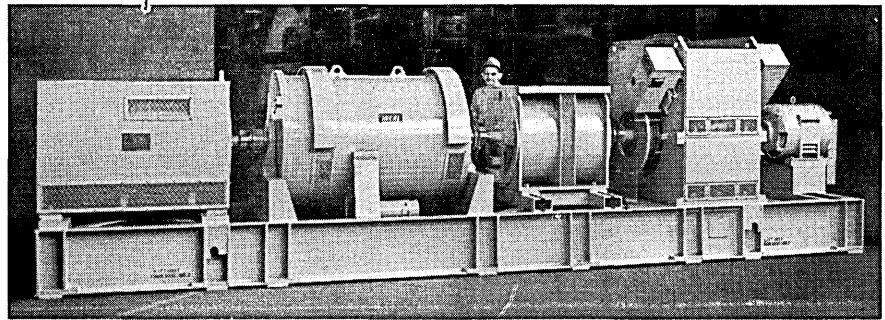

**AIR LINE RESERVATION COMPUTER**, installed in Chicago, supplies dependable reservations and information because it gets uninterrupted power from two Ideal Electric CF (Constant Frequency) Systems. A complete power system is shown above as it appeared before shipment from the factory. The view below shows a part of the CF System after connection to the computer, with the control panels in the background. This system can furnish 640 KW (640,000 watts) of dependable power to the computer.

Make your  
computer power  
**DEPENDABLE**  
with a patented  
**IDEAL ELECTRIC**  
no-break  
**CF SYSTEM**

Computers will not operate dependably if there is the slightest disturbance in the electric power supply. So if you want **No-Goof** computer performance, you need an Ideal Electric **No-Break** CF Power System.

These patented systems supply regulated voltage and constant frequency—**without batteries or other external power**—to carry over short power interruptions up to 30 seconds or more, or to provide time to transfer from preferred power to auxiliary or stand-by power. They are available in two basic types with several variations, and in ratings from 2.5 KW through 1000 KW.

If your computer gets its orders on-the-spot, an Ideal Electric CF System can save valuable time. If data is transmitted to your computer from remote locations, it can prevent disaster. Whatever your special power problems might be, we invite you to use our abilities and experience in solving them.

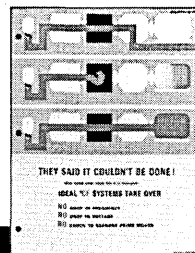

For more information on how we can serve you, and for a copy of our bulletin on CF Systems, telephone us at (419) 522-3611 or write The Ideal Electric & Mfg. Co., Mansfield, Ohio 44903.

**IDEAL ELECTRIC**

CIRCLE 64 ON READER CARD

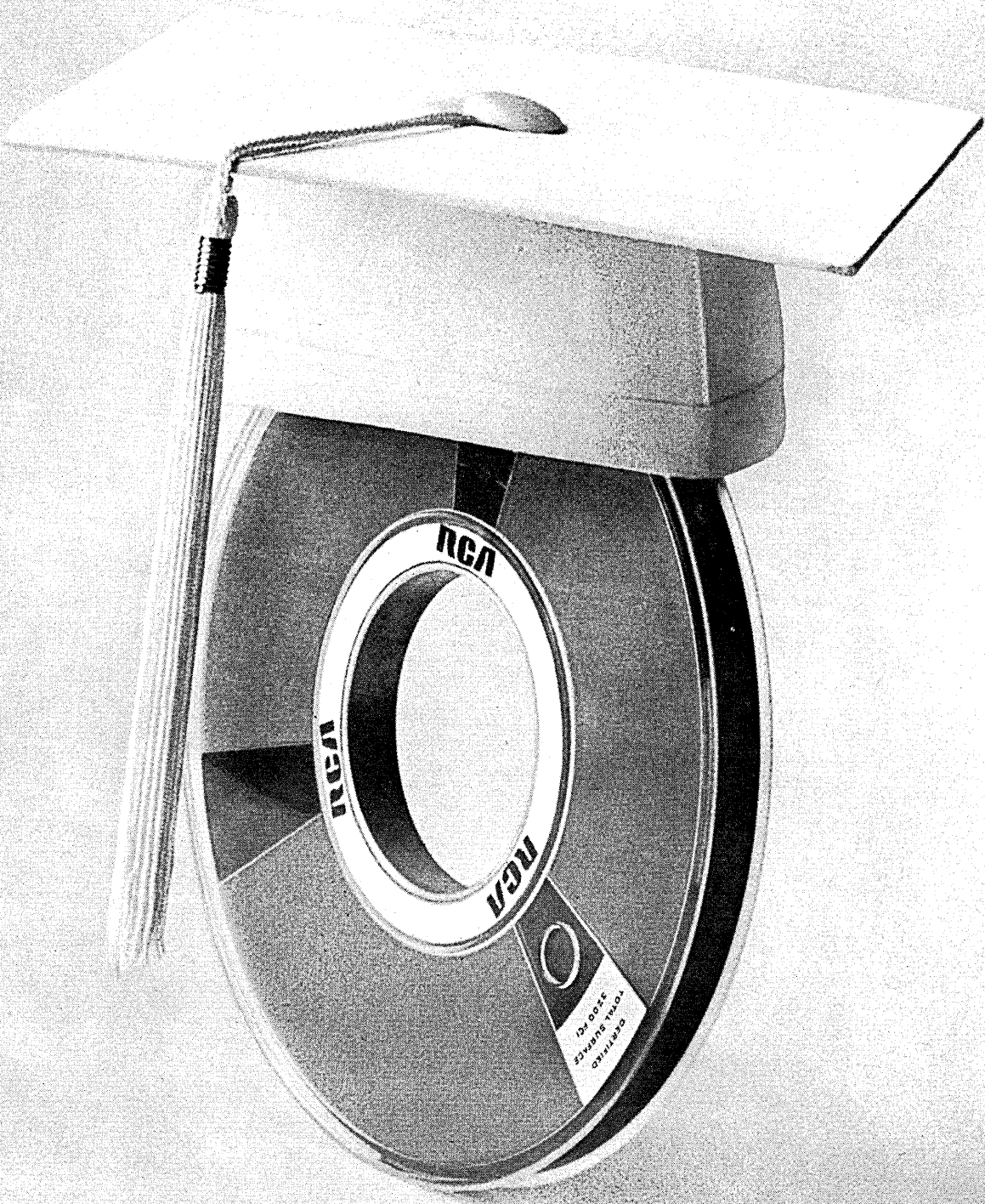

## RCA computer tapes pass world's toughest tests.

At RCA, statistical testing isn't good enough. Every reel of RCA industry-compatible computer tape is 100 percent tested to assure freedom from dropouts. Only then is it ready to go to work for you.

From raw film to finish, the tape moves through the manufacturing process in the industry's cleanest environment—under rigid, laminar-flow white room conditions.

This attention to detail is typical of the lengths to which we go to insure that RCA-manufactured tape is the finest-quality tape it is possible to make.

Each reel is a balance of the best: the best raw materials and the finest finishing and fabrication. And RCA computer tapes are now in use throughout the world.

RCA also manufactures video, audio and instrumentation tape.

May we tell you more?

RCA Magnetic Products Division  
15 East 26th Street  
New York, New York 10010

In Canada: RCA Magnetic Products  
c/o RCA Victor Co., Ltd. 1001  
Lenoir Street, Montreal 30, Canada

# RCA

CIRCLE 65 ON READER CARD

## new products

tegral part of the graphics terminal, makes it possible for the user to construct, display and manipulate complex three-dimensional images. Included are: a monitor; FORTRAN compiler; macro-assembler; text editor to allow entry and modification of source language programs; graphics operators to allow for displaying, constructing, manipulating and storing images; subroutines for digital and graphics I/O devices and communications interfaces; and graphics applications programs, which are available for signal, processing, simulation, math modeling, and machine-aided design. ADAGE, INC., Boston, Mass. For information:

CIRCLE 181 ON READER CARD

### perspective software

The Three-D software system enables a computer user to generate perspective drawings of surfaces, "walk around" a surface in successive drawings, produce a stereoscopic view of a surface, and produce animated films automatically with the company's Model 835 microfilm plotter. The package is a set of FORTRAN subroutines for drawing a three-dimensional view of any surface that can be expressed as a single-value function of two variables. Surfaces can be drawn opaque or transparent. The system is priced at a one-time lease charge of \$3K. CALIFORNIA COMPUTER PRODUCTS, INC., Anaheim, Calif. For information:

CIRCLE 182 ON READER CARD

### typeout projector

The Mark III TyProjector mounts on a teletypewriter and projects typeouts on an ordinary movie screen, displaying the line being typed as well as the 19 preceding lines. It requires no modification of the teletypewriter and provides a variation of image size and light intensity. The TyProjector is intended for demonstration and instruction on the use of time-shared computer terminals, and in other classroom situations. It's priced at \$745, which is somewhat cheaper than equipping each student with a crt. DATA EQUIPMENT DIV., BOLT BERANEK AND NEWMAN, INC., Santa Ana, Calif. For information:

CIRCLE 183 ON READER CARD

### transmission controller

The TM113 is a software-supported communications multiplexor for the

IBM 1130 that simultaneously connects any combination of up to 15 teleprinters, or IBM terminals such as the 2741/1030/1050, to any model of the 1130. The terminals can operate concurrently and at different speeds with the execution of any 1130 program, and the software permits FORTRAN calls to communicate directly with terminal equipment. Lease prices include both hardware and software and start at \$275 per month plus \$25 per line. Delivery is within 90 days. WESTERN TELEMATIC, INC., Arcadia, Calif. For information:

CIRCLE 184 ON READER CARD

### lab computer system

A clinical laboratory computer system capable of recording and interpreting data simultaneously from 15 clinical analyzers, and that allows a medical technician to define his own testing parameters, is available (delivery in 90 days) for \$43K. The basic system configuration includes the company's LINC-8 computer, with a 4K word core, a teletypewriter, paper tape punch and reader, A/D converter, oscilloscope and a dual mag tape unit. The computer is expandable to 32K words and will accept all LINC-8 options. The system uses English-based conversational language and meets hospitals' recurrent demand for the least amount of training. It is capable of printing out diagnostic warnings when it detects deviations from previously established test standards. DIGITAL EQUIPMENT CORP., Maynard, Mass. For information:

CIRCLE 185 ON READER CARD

### graphics software

Continuing its policy of finding new applications for the 1130 (and thus selling more of them), IBM has come up with GLEAM (Graphic Layout and Engineering Aid Method), an experimental program that partitions the 1130 into several "virtual machines" that execute the tasks of specialized processors within the computer. These elements can include a display processor, artwork processor, precision device controller, communications processor, I/O processor and a conversational terminal on one 1130 computer. The program is designed for circuit design work, network analysis, simulation control, printed circuit layout, component placement, flow analysis, logic drawings, and the processing of schematic diagrams. IBM SYSTEMS DEVELOPMENT DIV., Kingston, N.Y. For information:

CIRCLE 186 ON READER CARD

**Finally.**  
**You can computerize**  
**your personnel department.**  
**If you dedicate your**  
**entire EDP dept**  
**(including an in-house genius)**  
**for 1.75 years.**  
**Pick up the tab for \$250,000.**  
**And maybe get**

## **CSC's** **PMI system**

The first taped ready-to-install Personnel Management Information system. Deals in: employee records, benefits, compensation, manpower planning. Provides quick response in any criteria selection because data base generates 30 standard reports plus infinite number of specific reports via simple English language input. For 3rd generation computers. Eliminates time, costs, demands on present personnel to develop your own system. (See above.)

Call: Charles Sullivan (213) 678-0592.  
Computer Sciences Division,  
650 North Sepulveda Blvd., El Segundo, Calif. 90245.

**Computer Sciences Corporation**

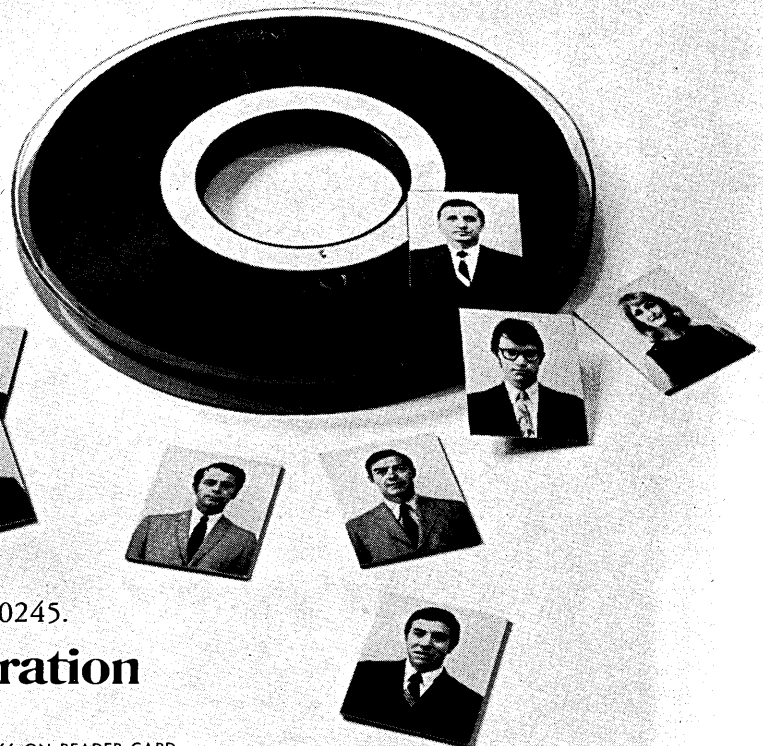

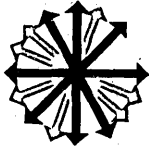

# new literature

**DATA ACTIVITIES STUDY:** A study of scientific and technical data activities in the U.S. has been conducted by Science Communication, Inc., Washington, D.C. Volume I (AD-670 606, 266 pages) presents a plan for study and implementation of national scientific and technical data systems concepts developed by the Task Group on National Systems of COSATI. Volume II, Parts A & B (AD-670 607, 433 pages), presents scenarios of data activities in ten selected fields of science and technology, covering characteristics of data, data flows, formal data efforts, and representative data-related problems or issues identifiable with the field. Results from probes of data activities in selected areas are summarized. Volume II, Part C (AD 670 608, 489 pages) consists of a preliminary census of 226 formal data efforts which are representative of those currently operating in the U.S., including data service centers, data-document depositories, data program development and coordination, and data handling and service operations. Cost for each is \$3; microfiche, \$.65. CLEARINGHOUSE, U.S. DEPT. OF COMMERCE, Springfield, Va. 22151.

**T-5 SOFTWARE:** Eight-page brochure describes software that will implement the time-sharing capability of the Sigma 5 and 7 computers. BTM-1 (Batch/Time-Sharing Monitor), now operational, offers eight users the benefits of interactive and on-line time-sharing without disrupting normal batch processing operations. SCIENTIFIC DATA SYSTEMS, Santa Monica, Calif. For copy:

CIRCLE 220 ON READER CARD

**DATA SYSTEMS EDUCATION:** Fifteen-page reprint of a speech delivered at the 1968 DPMA Conference gives a practical approach for involving management in the development of their own data systems. BARNETT DATA SYSTEMS, Rockville, Md. For copy:

CIRCLE 221 ON READER CARD

**DOCUMENTATION GUIDE:** Brochure describes DOCU-PAK computer documentation guide, a 200-page manual avail-

able for a variety of configurations, including System/360 and Honeywell 200 series. The manual includes specifications for documenting the implementation effort and incorporates documentation review and maintenance procedures. Detailed standards for system flow charts, program diagrams, decision tables, layouts and COBOL and assembly language coding are specified. SYNERGETICS CORP., Burlington, Mass. For copy:

CIRCLE 222 ON READER CARD

**COMPUTER LAB WORKBOOK:** 200-page workbook, designed for use with the company's Computer Lab digital logic teaching device, contains a complete course in digital logic. The workbook contains 46 experiments and over 160 illustrations, tables and diagrams covering chapters ranging from an introduction to the binary concept through

Boolean algebra and serial adders to digital system design and techniques. DIGITAL EQUIPMENT CORP., Maynard, Mass. For copy:

CIRCLE 223 ON READER CARD

**SOURCE DATA RECORDING:** Data sheet describes Tempapunch 500 series of source data recording machines which accept input from embossed plastic templates and an operator-controlled variable keyboard, producing imprinted forms and punched cards in a single operation. Machine can be used by any employee to create machine-readable input at the source. THE ENTWISTLE CO., Santa Monica, Calif. For copy:

CIRCLE 224 ON READER CARD

**DISPLAY SYMPOSIUM:** Proceedings of the 9th National Symposium on Information Display, Info 68, sponsored by the Society for Information Display, is available from the publisher for \$15. WESTEN PERIODICALS CO., 13000 Raymer St., North Hollywood, Calif.

**PLOTTER SOFTWARE:** Twelve-page brochure explains the General Purpose Contouring Program (GPCP), used to automatically plot functions of two in-

## FOR:

- FILM RECORDERS
- FILM READERS
- FLYING SPOT SCANNERS
- BUBBLE-CHAMBER EXPERIMENTS
- VIDEO RECORDERS
- SCAN CONVERTERS
- HARD-COPY PRINTERS

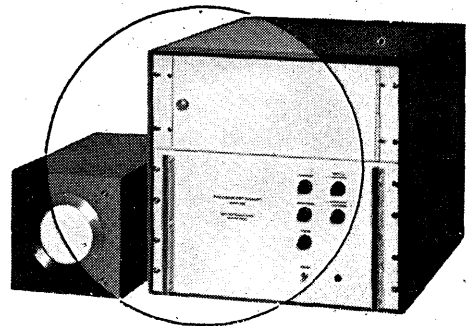

# PRECISION X-Y CRT DISPLAYS

3 Model Series available —  
**PD900** low cost  
**PD1100** high performance, moderate cost  
**PD1200** highest resolution



Send for Engineering Data Sheets

**Beta Instrument Corp.**

377 ELLIOT ST., NEWTON UPPER FALLS  
 MASSACHUSETTS / TEL. 617 • 969-6510

CIRCLE 67 ON READER CARD

# The generation gap

Soon after the first announcements of integrated circuit computers, it was apparent that the new generation had a major split down the middle. The third generation had brought a fourth right along with it. Both represented far more power than earlier machines of equivalent size; both scored major new achievements in cost, performance and reliability. But the similarities stopped right there. The third generation switched from transistors to integrated circuits. The fourth generation did that and more. It switched to a whole new concept in computer design: a computer controlled by its own inner computer. The operating characteristics of the overall system are controlled by micro-programming the inner computer. Accordingly, the user can adapt the logic design of the computer to optimize the system for different types of problems. The tremendous flexibility of fourth generation computers derives from their machine language independence and their high degree of problem adaptability. In practical terms, the computer-within-a-computer delivers significant performance advantages at a much, much lower cost.

We were the first company to announce and ship a fourth generation computer. So far, we have shipped more of them than anyone else.

We didn't bridge the gap; we created it.

# Standard

STANDARD COMPUTER CORPORATION 1411 West Olympic Boulevard, Los Angeles, California 90015 (213) 387-5267





IC-4000—  
one of Standard's fourth generation computers  
500 nanosecond control memory compiles up to  
4,000 FORTRAN statements per minute — other  
models offer time sharing—optimized problem  
adaptation.  
Full information and documentation on request.

# Computer

# 492 of the Fortune '500' use our data processing seminars

(Can the other 8 be using our competitors?)

Technical people gain the knowledge needed to make a computer as wondrous as it looks. Management people gain insights into what the new EDP-oriented tools can do.

Few months go by in the world of EDP without some advanced procedure suddenly becoming obsolete. Continuing education is the only answer. And C-E-I-R's 2 to 5-day seminars have proven a practical solution.

Over 30 courses are offered at various cities throughout the country. These are designed for business and technical management, and cover computer sciences, management sciences and mathematical and statistical sciences. And in-plant seminars can be arranged to fit your need.

Free catalog lists courses, dates, cities, costs, details.  
For your copy, call or write Dept. D-1.

INSTITUTE FOR ADVANCED TECHNOLOGY

# C-E-I-R<sup>INC.</sup>

THE PROFESSIONAL SERVICES SUBSIDIARY OF **CONTROL DATA CORPORATION**

5272 River Rd., Washington, D.C. 20016 Telephone: (301) 652-2268

CIRCLE 69 ON READER CARD

## new literature

dependent variables in the form of contour diagrams or maps. Written in FORTRAN IV, the program can be used with any CalComp drum or flatbed plotting system in the 500, 600 and 700 series, on- or off-line. CALIFORNIA COMPUTER PRODUCTS, Anaheim, Calif. For copy:

CIRCLE 226 ON READER CARD

**FEDERAL INFORMATION CENTERS:** 196-page directory contains an index of federally supported information analysis centers, including subject areas covered, names of center directors, and a list of organizations. PB-177 050. Cost: \$3; microfiche, \$.65. CLEARINGHOUSE, U.S. DEPT. OF COMMERCE, Springfield, Va. 22151.

**TAPE TERMINALS:** Four-page bulletin describes series MT 3000 magnetic tape terminals which receive, record, read and transmit data serially over voiceband or broadband communications lines. The series includes a seven-level tape drive compatible with the IBM 729 tape format and a nine-level drive compatible with the IBM 2400 series. ULTRONIC SYSTEMS CORP., Moorestown, N.J. For copy:

CIRCLE 227 ON READER CARD

**DATA SET:** Sixteen-page manual describes functional specifications, interfaces and applications of TDM-210 private line data set designed for transmission of binary digital data over a typical voice channel at speeds up to 1200 bps and on specially conditioned voice channels up to 1800 bps. The data set operates full-duplex over 4-wire circuits or half-duplex over 2-wire circuits. GENERAL ELECTRIC CO., Lynchburg, Va. For copy:

CIRCLE 228 ON READER CARD

**TERMINAL SOFTWARE:** Eight-page brochure describes standard software systems (AMOS) for the company's graphics terminal. The system provides communication with a remote cpu and local control of displayed images, allowing on-line interaction between the operator and his computing facility. Descriptions of the resident monitor, compiler, macro-assembler, and the display editor, graphics operator routines, graphics applications programs, and utility and service routines are included. ADAGE, INC., Boston, Mass. For copy:

CIRCLE 229 ON READER CARD

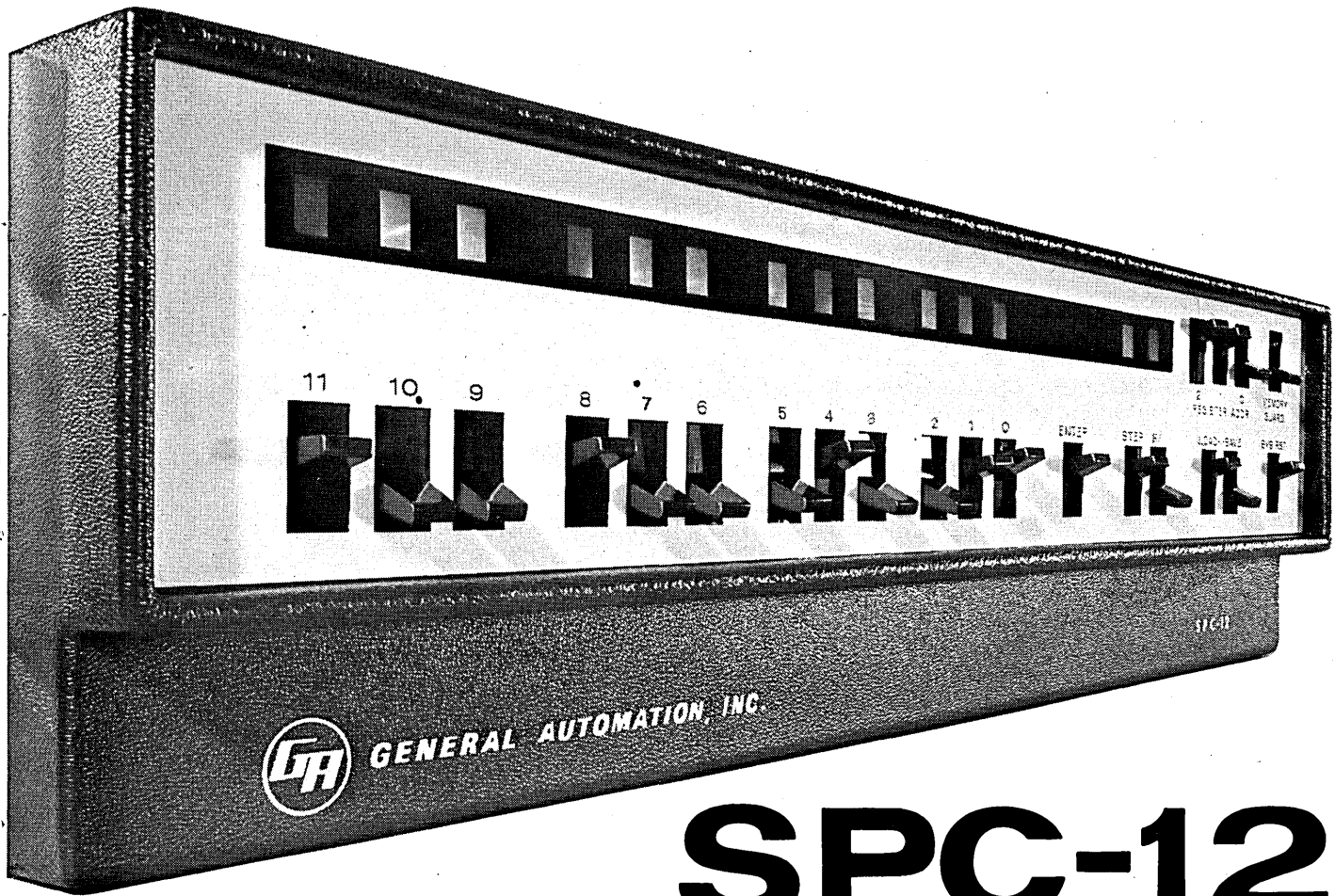

# SPC-12

## the new automation computer

The SPC-12 is a new automation computer designed for economical use in dedicated automation and control functions.

The SPC-12 is powerful—with six programmable 12-bit registers, a 2-microsecond (4K to 16K) memory of 8-bit bytes, and a unique memory saving "shared command" concept. Fully IC'd for reliable 'round-the-clock' operation. \$6400, *including* a teletypewriter interface, control panel, and real time clock, console lock, optional power failure restart, and optional direct memory transfer.

That's just half the story. Most computers require expensive engineering and black boxes to work in a control system. Not the SPC-12. It comes with economical functional modules which adapt the SPC-12 easily to instrumentation, computer peripherals, keyboards and displays, sensors and communication networks. With these functional modules and its power, the SPC-12 achieves a new cost/performance ratio and makes computer control practical in your system today. Programming aids and application software of course. Call or write for more information about the SPC-12—the new automation computer.



**GENERAL AUTOMATION, INC.**  
Automation Products Division

706 West Katella, Orange, Calif. (714) 633-1091

# The lethal label.



With proper handling, computer tapes can be "scratched" and reused almost indefinitely. However, careless removal of previous labels can

crush reel flanges against tape edge, and kill a good tape.

**Moral:**  
**Hold flanges away from tape when removing labels.**

Antidote for tape problems: Audev. Whether you use our series 61 or premium K-68, you're in good company. These are the tapes used by the top U.S. companies.



FOR A FREE POSTER-SIZE REPRODUCTION OF THIS AD AND THE OTHERS IN THE SERIES, WRITE DEPT DA-9 AUDIO DEVICES, INC., 235 EAST 42ND STREET, NEW YORK CITY, NEW YORK 10017.



# books

**COBOL Simplified**, by Mario V. Farina, Prentice-Hall, Inc., 1968, 528 pages.

Some time ago I received a call for aid from Recordings for the Blind, a philanthropic organization that records technical books on tape on request from blind students. RFB was having trouble meeting requests for books on computing (they'd done fine with the RCA tube manual, mind you) and in particular with books on COBOL. How does one read aloud a book on



COBOL, especially with the funny drawings with the squares and diamonds and arrows? They had selected four COBOL reference manuals to show me, to illustrate their complete frustration. Besides the normal troubles of trying to verbalize any programming reference manual, these books had another common fault: they were not typeset.

A book on COBOL necessarily fluctuates between descriptions of COBOL statements (which are in technical English) and the statements *in* COBOL, and the latter must be read virtually character by character. This distinction is hard to convey (even to a sighted reader) in the limited range of a typewriter. The wide range of expression possible through intelligent typesetting is highly desirable, if not necessary. If a COBOL book must be rushed into production by offset from typescript, it already has one strike against it.

Farina's book has the appearance of typewriting, unjustified, about 12 points high, giving it somewhat the

appearance of a third grade reader. The style of writing matches this appearance, apparently directed at a not-too-bright juvenile audience. All of this is not helped by the inclusion, at the end of each chapter, of a set of puerile questions.

The book has other faults, too, but let's get to the point: it is an amazingly good book about COBOL. It is organized in logical order; it covers every possible topic about this rich and viable language; it includes a thorough index; and Farina obviously knows COBOL from working with it. In fact, he is obviously infatuated with the language, to the point of referring to assembly languages as "bit fiddling."

COBOL is rapidly becoming a language of great breadth. Anyone wishing to use it, or simply to learn about it, can probably find no better exposition than in this book. It is all there, presented both as a text and a reference manual.

Where it is necessary to refer to a specific implementation, Farina uses the GE 635, and the operating system with which he is familiar. Some of this is obtrusive (especially references to internal GE documents), but it insures reality and immediacy. The book contains a wealth of coding examples and thoroughly worked-out routines. The

printing format and style are unfortunate, and will make the transcription by Recordings for the Blind an exceptionally difficult task.

—FRED GRUENBERGER

## book briefs

*(For further information on the books listed below, please write directly to the publishing company.)*

**Computer Applications in Stratigraphic Analysis**, by J. W. Harbaugh and D. F. Merriam. John Wiley & Sons, Inc., New York, N.Y. 1968. 282 pp. \$14.95.

An introduction to the major applications of computers in stratigraphy, sedimentology and petroleum geology, written for geologists who may have little or no knowledge of computers.

**An Introduction to FORTRAN Computer Programming for Business Analysis**, by Donald L. Raun. Dickenson Publishing Co., Inc., Belmont, Calif. 1968. 318 pp.

A soft-backed book which is, according to the preface, "designed to provide the business student with a basic understanding of how to employ the computer for business applications, rather than engineering, mathematics

*Is CAI Economic Now? How Can Top Management be Interested? What About Programs? Funding? Configurations?*

FIND ANSWERS IN

## CAI NEWSLETTER

8 Issues \$12

or **SAMPLE COPY FREE**

Circle 85 on Reader Card or write

**INSTITUTE FOR COMPUTER-ASSISTED INSTRUCTION, INC.**

Dept. D9, 42 East Court Street  
Doylestown, Pa. 18901

### MEETINGS

Oct. 17, Washington & Nov. 21, New York  
One-Day Briefing on CAI

Oct. 14-16, Washington  
Briefing Session on Curriculum & Training Strategies, and  
Managing the Creation and Adaptation of  
CAI Instructional Programs

Nov. 18-20, Plattsburgh  
Annual CAI State-of-the-Art Review

### ICAI STAFF & CONSULTANTS

(Affiliations for identification only)

Alec Kyle, President; Donald Reynolds, Vice President & Technical Adviser; Wm. Fitzgerald, Director of Program (CAI, Inc.); Donald Bitzer, Consultant (University of Illinois); H. L. Wilson, Consultant (Stanford University); Lewis Ward, Consultant (Harvard Graduate School of Business); Karl Zinn, Consultant (University of Michigan).

# 1,000 Steps per second/800 bits per inch! and this elegant Incremental Recorder is SYSTEM/360 compatible too.

## Born to Win

This new incremental/continuous tape recorder was born to be a winner. While last year's tired entrees are busily being "hyped" up to meet the 9 channel 800 bpi requirement, this simple new model from PERIPHERAL EQUIPMENT CORPORATION breezes along in pre-conceived IBM SYSTEM/360 compatibility.

You see, PEC offers a single capstan velocity D.C. servo drive system with optical accuracy. This unusually wide bandwidth, low inertia drive employs printed circuit motors and single shaft coupling. That's how the truly incremental rates of 350, 500, and 700 steps/second are easily met, with 1,000 steps/second an available option.

You can say goodbye to those obsolete tired old stepping motor types of incremental recorders that are self-limiting in speed and accuracy.

## The Taming of the Skew

This elegant PEC recorder has conquered skew exactly like the *very expensive* computer tape transports.

Do you benefit? You bet you do because you are guaranteed that a magnetic tape written on

an inexpensive PEC recorder will read perfectly into your computer transport.

PEC tames the skew in three important ways. With a single capstan drive that eliminates pinch rollers (and skew) . . . with

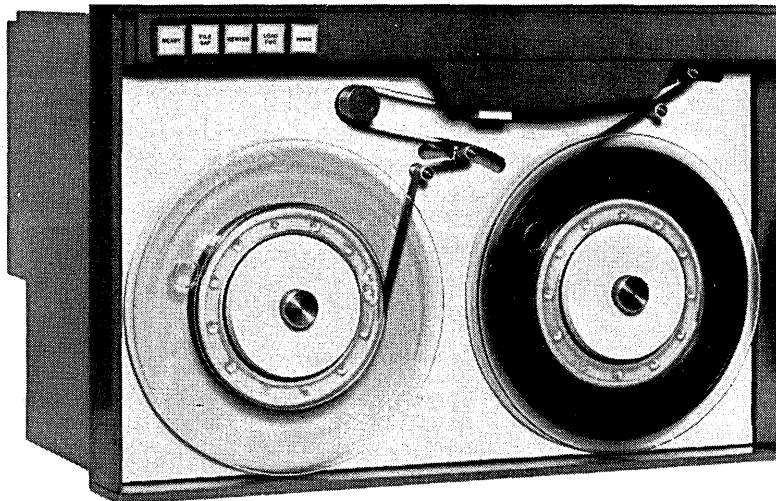

an optical capstan position encoder which precisely positions data bits . . . and with electronic deskewing at 800 bpi (just like the big boys). A feature which is possible because PEC writes on the fly! And we even guide tape with IBM configuration and tape tension.

## Racing Through the Gap

Another time saving advantage. You can race through the inter-block gap in 60 ms (50 ms for SYSTEM/360 compatibility). The gap time is independent of data density and doesn't cost you a penny more . . . compliments of our wideband servo drive.

## Elegance in Emptiness

It's the little things that PEC has left out that count. (Those troublesome little things like gear trains, pinch rollers, and other mechanical linkages.) Using IC logic, we have figured out how to design "expensive" circuitry inexpensively. You are the winner. Both on initial cost and continuing maintenance.

## Continuous, Too

Not only can this revolutionary recorder prepare SYSTEM/360 compatible tapes at packing densities of 200, 556, and 800 bits per inch *incrementally*, but it can

also operate as a continuous recorder or reproducer at any speed up to 25 inches per second. The price saving over the big machines is considerable . . . the performance is even better.

## Design PEC in

Data acquisition . . . computer peripheral . . . integrated circuit testers . . . digital plotters . . . pulse height analyzers. If you are designing any of these systems the new PEC incremental/continuous recorder will make your job easier. Phone or write us today.

**PEC**

PERIPHERAL EQUIPMENT CORPORATION

9551 Irondale Avenue ■ Chatsworth, California 91311 ■ (213) 882-0030  
SEE US AT FJCC BOOTH 104

## books

or science applications." The text may be used by students or instructors who have no prior knowledge of computers or programming.

**Essentials of Simulation**, by Joe H. Mize and J. Grady Cox. Prentice-Hall, Inc., Englewood Cliffs, N.J. 1968. 234 pp. \$9.

An introduction to the concepts of Monte Carlo simulation methodology as applied to the analysis and synthesis of systems; for readers with limited background, the book also contains introductory reviews of the basic material. FORTRAN examples are included and random number generation, probability theory and statistics are discussed.

**System 360/20 RPG Programming**, by J. A. Saxon. Dickenson Publishing Co., Inc., Belmont, Calif. 178 pp. 1968.

A self-instruction text, organized into seven units and six appendices. The 36 lessons each include definitions, examples and problems in a workbook format.

**Principles of Programming the IBM 1620**, by William J. Claffey. Dickenson Publishing Co., Inc., Belmont, Calif. 1968. 319 pp.

This book is intended as a student text; its objective is to present business-oriented studies of theory and applications emphasizing use of 1620 machine and Symbolic Programming System languages, rather than FORTRAN. Also included is an explanation of 1620 operations.

**Computer Methods in Power System Analysis**, by Glenn W. Stagg and Ahmed H. El-Abiad. McGraw-Hill Book Co., New York, N.Y. 1968. 426 pp. \$15.50

The expensive text describes the application of digital computers to planning, design and operation of electric power systems. Each chapter contains problems and solutions and a bibliography. It is written for advanced power system courses for prospective engineers.

**Sequential Machines and Automata Theory**, by Taylor L. Booth. John Wiley & Sons, Inc., New York, N.Y. 1967. 592 pp. \$18.50.

Written for the systems engineer and the computer scientist, this book is an introduction to analysis techniques developed to represent and evaluate discrete parameter systems. Each chapter includes problems (selected solutions are in one of the four appendices), and lengthy lists of references.

September 1968

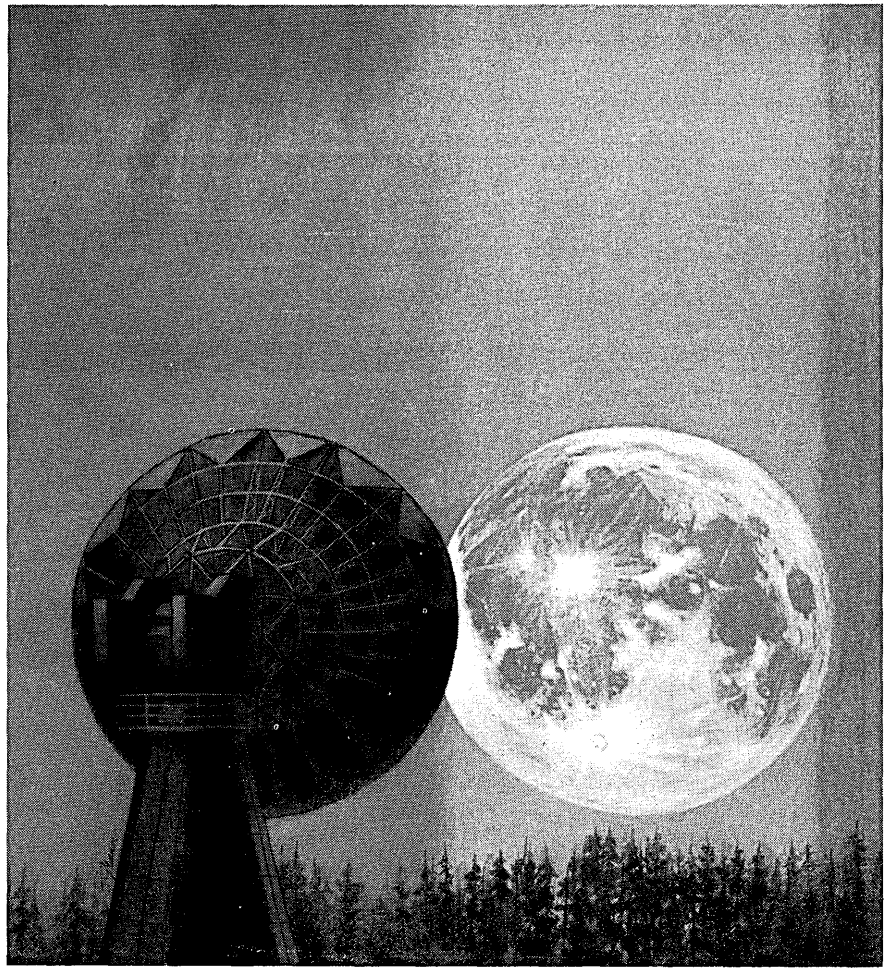

## The moon is a squashed tangerine.

Or is it? Although man has gazed at the moon since time immemorial, we still don't really know its precise shape. Or consider this problem: "At this instant, where is Quasar 3C 273 in relation to the observatories at both Cerro Tololo, Chile and Mount Palomar, California?"

Scientists are now using sophisticated computer systems designed and implemented by Logicon to answer questions such as these.

Logicon is a computer sciences company working on diverse kinds of advanced computer-centered systems. For example, one Logicon system realistically simulates hundreds of constantly moving airborne, surface and subsurface targets—so that Navy combat direction teams can be more effectively trained. Still others help plan/build housing tracts and mathematically simulate the activities of the human heart for medical research.

Logicon is different from other computer companies. First, it provides complete computer services—analysis, design and implementation—all in a single organization. Second, prime emphasis is placed on cost effectiveness in relation to each customer's individual working environment. Last, but

certainly not least, is Logicon's unique simulation techniques that curtail the common "trial by error" shakedowns that so often haunt new computer installations.

With this experience and philosophy, it's not surprising that Logicon has grown rapidly. The company has maintained a growth rate of over 40% every year and has achieved an especially high rate of repeat business from "satisfied customers."

For more information about Logicon, you are invited to contact Mr. James Fisherkeller, Director of Marketing, at our corporate headquarters.



Los Angeles, San Diego, Washington D.C.  
Corporate headquarters: 255 W. Fifth St.,  
San Pedro, California 90731

**PROGRAMMERS, SCIENTISTS AND ENGINEERS**  
—In addition to a stimulating environment, Logicon offers unique profit sharing/stock purchase opportunities. To inquire about positions in the Los Angeles, San Diego or Washington, D.C. areas please write to Mr. G. A. Kellenberger at the corporate headquarters office. (An equal opportunity employer.)

# Moore New Ideas for Data Processing

**No more confusion  
about back orders**

With a single writing at the same time you write up an original order, your ADP equipment can process all the documents required for filling the order, acknowledging missing items, and automatically scheduling the backordered items for shipment "when available." Moore has form designs to do this.

**Save people a  
tedious job**

Tap more of the output potential of your ADP setup. One way: the Moore Multiweb Decollator. With one pass it can strip carbons from as many as eight parts. At the same time it can remove either or both margins and refold the parts for subsequent operations.

**Paycheck privacy  
without buying or  
stuffing envelopes**

A single pass through your computer and a Moore Speedisealer unit gives you payroll checks signed, sealed, and readied for delivery. Moore payroll checks become heat-sealed envelopes as they run through the Speedisealer unit. There's nothing else to do but deliver them.

**Ship and bill  
the same day**

Speed up billing operations by leaving out time-wasting steps: sorting, folding, inserting, addressing. A special Moore form speeds through your printer and comes out a self-addressed mailer, ready to go. You not only save time, overtime costs, envelopes, you get more value out of your ADP investment.

**Dial Moore  
for ideas**

More than 2400 Moore business systems specialists are in constant touch with businessmen throughout North America. There is a continuing flow of ideas among these men. Ideas for better control. For making information more accessible. For making less paper work harder. One Moore idea may be what you need. Find Moore in the Yellow Pages.



**MOORE® BUSINESS FORMS, INC.**

Over 675 offices and plants, 2407 salesmen in North America



# Breakthrough in recordaputers

Here comes a man with a reel of mag tape and an innocent-sounding request. What he has is 2400 feet of parts lists in digital form, and what he's asking for is a film strip of selected portions of these records in readable, reproducible, enlargeable form.

He'll have plenty of time to wonder what he said wrong while he's waiting for the film. Eventually he will learn that it's bad news to ask for a selective, ordered output, which involves computer sorting and a new mag tape before the film making ever begins.

That's why we developed the FR-80, a film recorder that does all of this in one pass, either from mag tape or on line. And the resulting film has a resolution of 80 line pairs per millimeter — nearly twice as high as from any other equipment.

Do parts lists need this kind of sharpness? Sometimes, yes. High-quality alphanumeric images yield high quality reproductions. What's more, the next customer may well have a digital tape of engineering drawings, and *his* film will make E-size enlargements that are needle sharp. No other film recorder can match this.

We're in the business of visual information handling in other ways, too, with systems that interpret images under program control. Our delivered products are analyzing seismograms and oil well logs, cleaning up soiled engineering drawings, reading oscilloscope wave forms, interpreting medical x-rays, extracting information from theodolite photographs.

Manipulating images as computers manipulate arithmetic — that's the inevitable, and that's our mission. Your inquiry will help push the inevitable.

Information International,  
545 Technology Square,  
Cambridge, Mass. 02139  
(617) 868-9810;

1161 West Pico Boulevard,  
Los Angeles, Calif. 90064,  
(213) 478-2571.



INFORMATION INTERNATIONAL

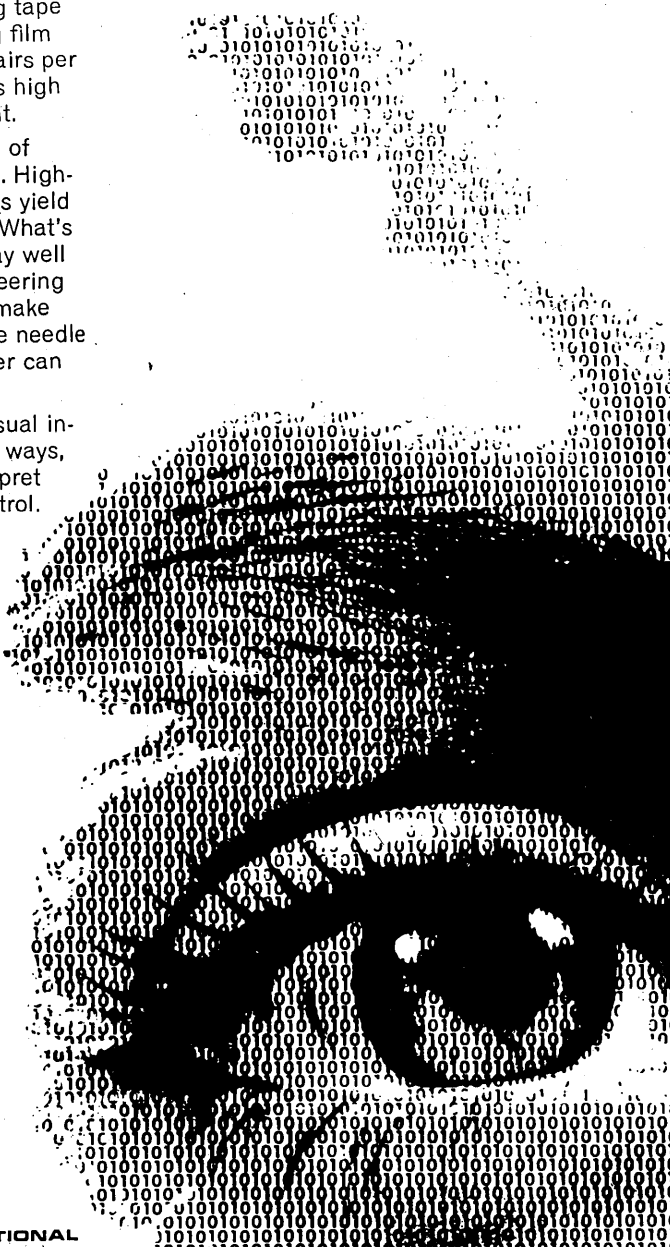

**CAPROCON**  
FAIRBANKS MORSE CORPORATION  
DESIGNED IN THE U.S.A.

**The Fairbanks Morse  
Caprocon system speeds  
the processing of cargo—  
automatically,  
for United Airlines.**

**A key to the system  
is Kleinschmidt**

For high speed in automated communications, there's only one answer: Kleinschmidt.

Take the Fairbanks Morse CAPROCON™ system. At United Airlines Cargo Terminal in Los Angeles, Caprocon, aided by Kleinschmidt data printers, brings new speed and efficiency to the processing of random parcels.

Working at a rate of 800 parcels per hour, Caprocon weighs and measures parcels instantly. It feeds the information on cubage and density to Kleinschmidt data printers. Bills, labels, and shipping instructions are printed out automatically. Result: more efficient palletizing, more economical aircraft loading, faster service than ever before.

Kleinschmidt 311™ Data Printer works at speeds up to 4 times faster than most other teleprinters. And, with 70% fewer moving parts, it's extremely reliable.

Like other Kleinschmidt data printers, the 311 is compatible with *all* makes of telecommunication equipment. You can fit it directly into your present system or into one being designed for you.

If you have a problem in telecommunications, shouldn't you communicate with Kleinschmidt?

CIRCLE 76 ON READER CARD

**KLEINSCHMIDT**  
DIVISION OF SCM CORPORATION  
DEERFIELD, ILLINOIS 60015 • TELEPHONE: 312 945-1000

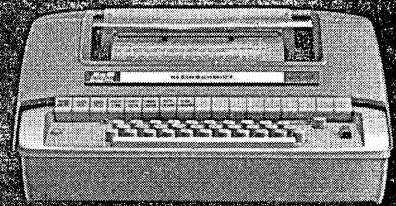

# IF YOU'RE BLOCKED IN YOUR CAREER

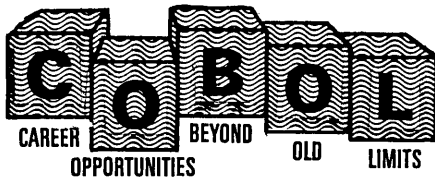

Albert, Nellissen's language to get you further faster through the logical application of our in-depth knowledge of the computer marketplace. Not just a job! But a challenging rewarding opportunity for creative personal progress.

## CAREER OPENINGS EUROPEAN AND NATION WIDE \$10,000—\$40,000

- Software Development
- Time Sharing Systems
- Logic/Digital Design
- Management Sciences
- Real Time Systems
- Sales and Marketing
- Scientific Computation

Unique opportunities exist in the \$9000-25,000 class for Managers and Men who can accept management responsibility and professional growth.

## DIRECT SALES/MKTG Hardware & Services TO \$30,000

All expenses are assumed by our client companies

Write in confidence, including present salary, acceptable locations or call (Collect) Mr. Nellissen (Area Code 212) PLaza 9-1720

# a&n

**ALBERT, NELLISSEN, INC.**

*Leading Consultants to Management in the Data Processing Field*

510 MADISON AVE., N.Y., N.Y. 10022

CIRCLE 301 ON READER CARD

September 1968

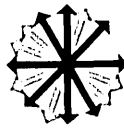

# people

**Dr. Robert R. Brown**, most recently director of computing & data systems services at the Space Div. of North American Rockwell, has been appointed special assistant to the president of Arcata National Corp., Palo Alto. Arcata, a \$100 million/year firm, owns three subsidiaries: Arcata Redwood; J. W. Clement (sixth largest printing house in the country); and Butler Data Systems. A replacement for Brown has not yet been announced. . . . **DATAMATION** editorial adviser **Robert L. Patrick** has been elected president of the Los Angeles Traffic Commission. . . . **Bill Lonergan** has been named vp, government marketing, for RCA Information Systems, Washington. **Don Stevens** replaces him as vp for product and programming planning at Cherry Hill edp headquarters. . . . **Marvin Kashan**, former exec vp of Computer Progress, Inc., has formed Software Applications Corp., NYC, which will specialize in merchandise control systems for chain store retailers. . . . **Bill Ross**, former Fabri-tek European rep, has joined Costello, Little & Co. as European manager. . . . **Harry Marcowitz**, granddaddy of SIMSCRIPT, is leaving Planning Research to join Consolidated Analysis Centers, Inc. (CACI), Santa Monica. . . . **William E. Cleaver**, formerly with Research Analysis Corp., is the new director of systems develop-

ment for VIP Systems of Washington. . . . **Morton C. Wolff** has been named president of Datalogics, Inc., new subsidiary of Globe Life Corp., Cleveland, which will provide time-sharing, contract programming and consulting services to businesses in the Ohio area. . . . **Frederick S. Hammer**, formerly vp and assistant to the chairman of the board of Bankers Trust, NYC, has been appointed president and chief operating officer of Leasco Systems & Research Corp., headquartered in Bethesda, Md. . . . **Paul D. Spindel**, professional engineer and former internal consultant to IBM's real estate and construction division, will head the company's new engineering applications group, NYC, formed to provide systems and programming support to clients in civil, mathematical, chemical and electronics engineering. . . . **John A. Gosden** and **Warren S. L. Moy** have been promoted to associate department heads of the Information Systems Dept. at Mitre Corp. . . . **Frederick J. McKee** will become president of Digital Industries' new Data/Comm Services Div., Encino, Calif. . . . **John E. Parker**, chairman, and **Matthew L. Devine**, president and chief executive officer, have resigned from Bunker-Ramo but will continue as directors. **Dr. Milton E. Mohr**, president and chief executive officer of Bunker-Ramo

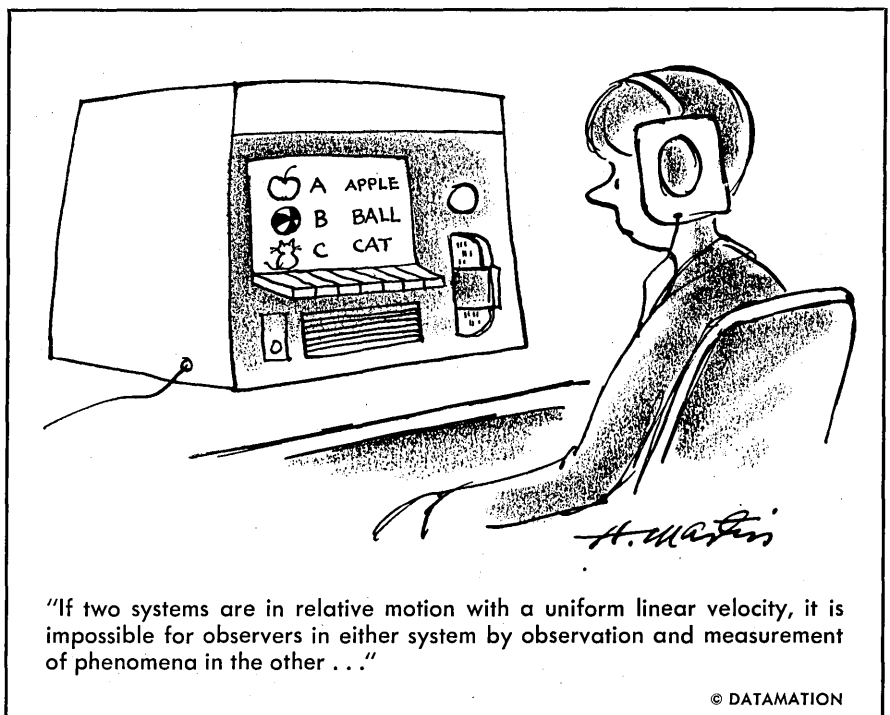

"If two systems are in relative motion with a uniform linear velocity, it is impossible for observers in either system by observation and measurement of phenomena in the other . . ."

© DATAMATION

**Back up data on the  
smallest, fastest military memory weighs  
more than the  
smallest, fastest military memory.**

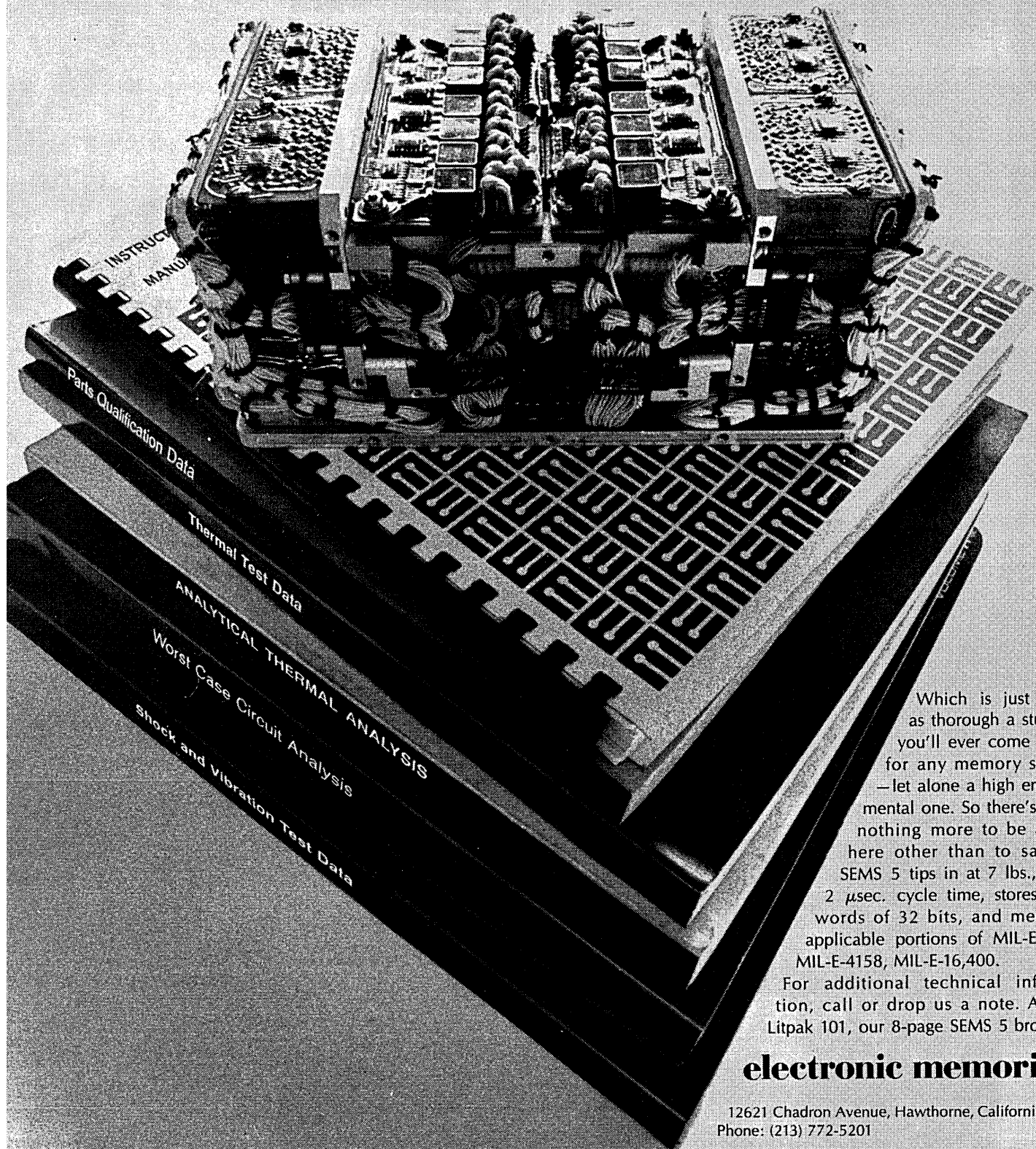

Which is just about as thorough a study as you'll ever come across for any memory system — let alone a high environmental one. So there's really nothing more to be added here other than to say our SEMS 5 tips in at 7 lbs., has a 2  $\mu$ sec. cycle time, stores 4096 words of 32 bits, and meets all applicable portions of MIL-E-5400, MIL-E-4158, MIL-E-16,400.

For additional technical information, call or drop us a note. Ask for Litpak 101, our 8-page SEMS 5 brochure.

## **electronic memories**

12621 Chadron Avenue, Hawthorne, California 90250  
Phone: (213) 772-5201

## What do you want most?

- |                                      |                                   |
|--------------------------------------|-----------------------------------|
| <input type="checkbox"/> Respect     | <input type="checkbox"/> Title    |
| <input type="checkbox"/> Money       | <input type="checkbox"/> Location |
| <input type="checkbox"/> Challenge   | <input type="checkbox"/> Security |
| <input type="checkbox"/> Opportunity | <input type="checkbox"/> Fringes  |

Our nationwide survey in the Financial & EDP field revealed that employment desires were in the order listed above.

We can assist in finding exactly what you want in Financial or EDP employment. That's all we handle... we're the largest specialized source.

### Fees Paid By Management

MGR. DATA PROC. ....	\$30,000
Process Industry	
MGR. CORP. SYSTEMS .....	\$25,000
Accounting and D.P.	
SR. ANALYST .....	\$25,000
T/S, communications	
OPERATIONS RESEARCH .....	\$22,000
Modelling, statistics	
MANAGER SYSTEMS .....	\$20,000
Hvy retail exp.	
MANAGEMENT SCIENCES .....	\$20,000
Commercial Scientific	
SYSTEMS PROGRAMMER .....	\$20,000
Large Time Sharing System	
DIRECTOR DATA PROCESSING .....	\$18,000
Engineering consulting firm	
SCIENTIFIC PROGRAMMER .....	\$18,000
360, 7000 series, or U 1108	
SYSTEMS ANALYST .....	\$16,000
Methods, Procedures	
DIRECTOR SYSTEMS .....	\$15,000
Manufacturing & Accounting	
PROGRAMMER .....	\$15,000
Real Time/Random Access	
TELEPROCESSING ANALYST .....	\$15,000
BTAM-QTAM/Switching	
SYSTEMS ANALYST .....	\$15,000
MIS — Major University	
OPERATIONS MANAGER .....	\$14,000
Multi-computer installation	
INVENTORY SPECIALIST .....	\$14,000
Systems — knl. D.P.	
FORTRAN PROGRAMMER .....	\$13,000
Scientific Applications	
SYSTEMS ANALYST .....	\$13,000
No prog. required	
PROGRAMMER .....	\$12,000
COBOL/BAL or PL 1	
GENERAL SYSTEMS .....	\$12,000
Methods, Procedures	

Mail resume to your nearest R-H office.



Atlanta: 235 Peachtree St., NE	(404) 688-2300
Baltimore: One Charles Center	(301) 837-0313
Boston: 140 Federal St.	(617) 423-6440
Chicago: 333 N. Michigan Ave.	(312) 782-6930
Cincinnati: 606 Terrace Hilton	(513) 621-7711
Cleveland: 1367 East 6th St.	(216) 621-0670
Dallas: 1170 Hartford Bldg.	(214) 742-9171
Detroit: 1114 Guardian Bldg.	(313) 961-5430
Garden City, N.Y.: 585 Stewart Ave.	(516) 248-1234
Los Angeles: 3600 Wilshire Blvd.	(213) 381-7974
Miami: 1107 Northeast Airlines Bldg.	(305) 377-8728
New York: 330 Madison Ave.	(212) 986-1300
Newark: 570 Broad St.	(201) 623-3661
Philadelphia: 2 Penn Center	(215) 568-4580
Pittsburgh: 429 Forbes Ave.	(412) 471-5946
Portland, Ore.: 610 S.W. Alder St.	(503) 222-9778
St. Louis: 1015 Locust St.	(314) 231-0114
San Francisco: 111 Pine St.	(415) 434-1900
Stamford, Conn.: One Atlantic St.	(203) 325-4158

World's Largest Financial & EDP Personnel Specialists.

## people

before the merger, was elected board chairman. William H. Rous, former president of Amphenol, was named president and chief operating officer. Both Mohr and Rous had been vp's and directors in the merged company. . . . Stanley Jones, former product manager for computer systems in the business machines group, has been promoted to corporate product manager for computer systems at Burchoughs, Detroit. . . . Nick Mayo, vp and national director of marketing, is now president of CSC subsidiary Computicket Corp., replacing Robert Beals. . . . Jack Brand has been promoted to vp at UCC subsidiary D. R. McCord and Assoc., petroleum consulting firm specializing in applying mathematical models using computers to the study of underground reservoirs. . . . Alan Glasser has been appointed manager of systems engineering for Raytheon's Space and Information Systems Div., Sudbury, Mass. . . . Lee Amaya, most recently assistant director of information processing at Lockheed Missiles and Space, has joined Atar Computer Systems (see July, p. 85) as vp/operations. Leonard Klarich, one of the founders of the company, has been elected vp/marketing, a new position. . . . John P. Kraus has been elected president and director of Programming Techniques, NYC software consulting firm specializing in numeric control and scientific applications. He had been marketing manager for Management Assistance, Inc. . . . N. Louis Senensieb, will head Computer Methods' new Los Angeles facility, CMC Computer Corp., which will be engaged in systems and programming consulting, proprietary software development, and marketing of CMC tutorial films on the West Coast. Senensieb was most recently vp and director of Universal Data Systems, L.A., and is a past international president of the Systems and Procedures Assn. . . . Until his death July 4 at the age of 38, Mal Perry was director of systems and programming for American Airlines, which included SABRE as well as the Tulsa, Oklahoma City and New York City installations. He had joined the company eight years ago specifically to head up the programming effort for the SABRE project and was instrumental in the development of most of the original software. Through his efforts the SABRE system has been expanded to handle functions other than reservations on a real-time basis.

# CAREERS

COAST TO COAST  
EUROPE

# TOP 20%

EXCLUSIVE!

The unique personal and confidential relationship we establish with you and our clients permits us to offer you outstanding job opportunities, many not found anywhere else. If your potential or abilities are above average and you are looking for a challenge, our unique service provides 49 state and international coverage.

### PARTIAL LIST COMPUTER CAREERS SALARIES \$10,000 — \$35,000

- Marketing/Sales
  - Management or Computer Consulting
  - Operations Research/Management Science
  - Time Sharing/Real Time Systems
  - Computerized Process Control
  - Management Information Systems
  - Systems Planning/Development
  - Business Systems, Programming
  - Applied Mathematics
  - Scientific Computation
  - Logic/Digital and/or Circuit Design
  - Software/Applications Packages
- (From Junior to V.P. and Director Levels)

Our clients assume all expenses

Write in full confidence to

Joseph Albert or phone 212/679-5688

Indicate salary and geographic requirements.

Member ACM

Career Consultants in the Data Processing Field



210 Fifth Ave., New York, N.Y. 10010

CIRCLE 302 ON READER CARD

Positive Air Pressure Tape Loop  
(Patented)

Dual Inertia Drive  
(Patented)

Capstan Design  
(Patented)

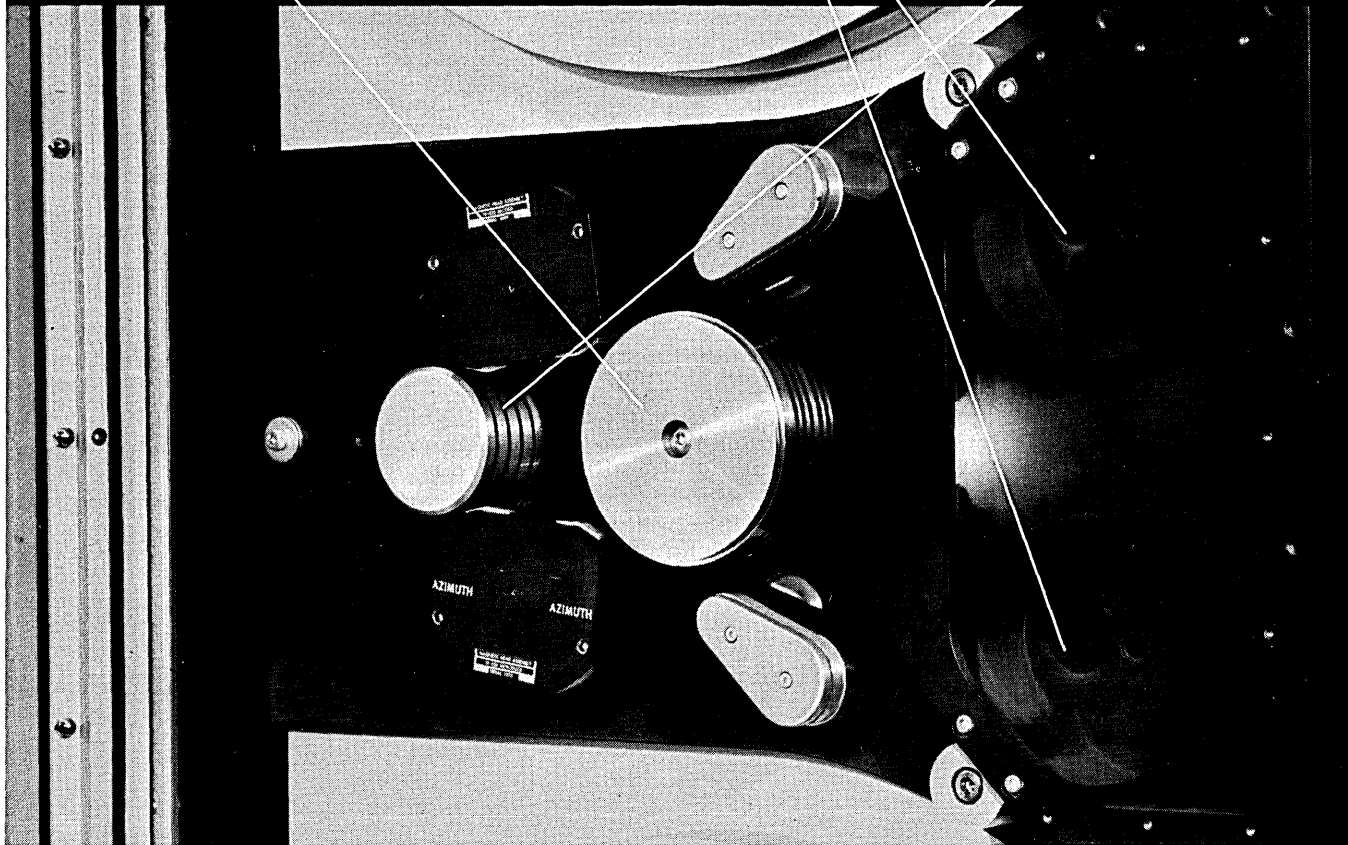

## Patently your best recorder

We're referring, of course, to the new VR 5000.

Today, instrumentation recorders have reached such a degree of efficiency that a single, patentable improvement is considered a "breakthrough". So you can imagine what happened to the state-of-the-art when CEC achieved *three* patentable improvements with *one* recorder.

And here are the three advances that did it:

**1. DUAL INERTIA DRIVE**—which provides high mass recording and low mass reproduce. Result: a flutter correction capability *demonstrably* more efficient than that of the next best recorder now available.



**2. POSITIVE AIR PRESSURE TAPE LOOP**—which assures reel perturbation isolation and eliminates the chronic problems of vacuum buffers and pinch rollers.

**3. CAPSTAN DESIGN WITH EXCLUSIVE O-RING SURFACE**—which produces tracking superior to any other recorder yet tested.

**NOW ADD ANOTHER ADVANTAGE**, a *time base error of  $\pm 200$  nanoseconds*. Which means that the ultimate in real-time restoration of data is now possible. And tapes made on data acquisition recorders under severe environmental conditions can be successfully reduced with correct time base restored.

For a complete performance report on the VR 5000—and all the facts—call your nearest CEC Field Office. Or write

Consolidated Electroynamics, Pasadena, California 91109. A subsidiary of Bell & Howell. Ask for Bulletin VR 5000-X3.

CEC also offers a complete line of other DATATAPE® recorders for mobile, laboratory and aerospace use.

**CEC/DATA INSTRUMENTS DIVISION**



**BELL & HOWELL**

**DATAMATION**

## TP/6 DISK PACK

# 98 reasons why the world's largest DP accessory company should supply and service your disk pack needs:

Delivery: immediate. Performance: unsurpassed. Warranty: full three years. Service: right at hand from the nearest of Tab's 94 Sales Offices (Akron, Albuquerque, Anchorage, Atlanta, Baltimore, Birmingham, Boston, Buffalo, Calgary, Alta., Charlotte, Chicago, Cincinnati, Cleveland, Cocoa Beach, Columbia, Columbus, Dallas, Darien, Davenport, Dayton, Detroit, Denver, Des Moines, Edmonton, Alta., El Monte, Fort Wayne, Fort Worth, Grand Rapids, Greensboro, Greenville, Hartford, Hickory, Honolulu, Houston, Huntsville, Indianapolis, Jackson, Jacksonville, Kansas City, Knoxville, Lansdale, Little Rock, Los Angeles, Louisville, Lubbock, Memphis, Miami, Milwaukee, Minneapolis, Mobile, Montreal, Que., Nashville, Newark, New Orleans, New York, Oceanside, Odessa, Oklahoma City, Omaha, Orlando, Ottawa, Ont., Pensacola, Philadelphia, Phoenix, Pittsburgh, Portland, Raleigh, Regina, Sas., Richmond, Roanoke, Rochester, Sacramento, Salt Lake City, San Diego, San Francisco, San Jose, San Juan, Savannah, Schenectady, Seattle, Silver Springs, South Bend, St. John, N.B., St. Louis, St. Petersburg, Syracuse, Toronto, Tulsa, Vancouver, B.C., Virginia Beach, Washington, D.C., Wilmington, Winnipeg, Man., Winston-Salem). And Tab has a complete line of disk pack handling and storage equipment.

Matter of fact, we can't think of a single reason why you *shouldn't* use the Tab TP/6. Can you?

Computer Companions by

# TAB

PRODUCTS CO. 633 Battery St., San Francisco, California 94111

CIRCLE 79 ON READER CARD

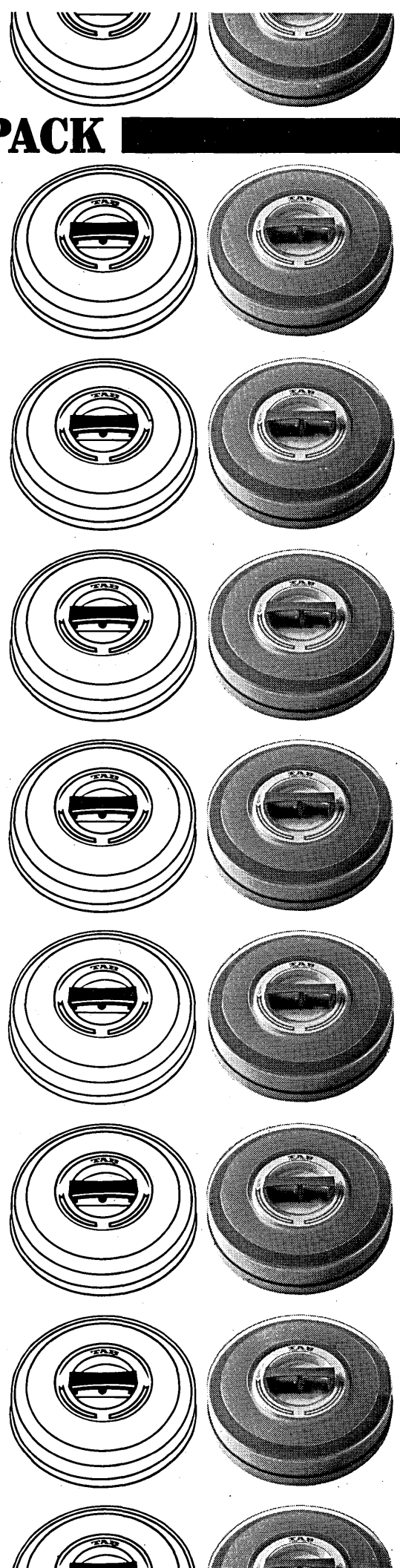

Colt-360 is Aim's revolutionary new COntral Language Translator that writes error-free JCL for OS and DOS at high speeds. Lets you work with easy-to-use, equipment-oriented forms.

Saves programmer and computer time. Obsoletes continual programmer manual referencing. Ends "let's run it and see" 360 job.control.

Aim automatically tailors Colt-360 JCL for your individual equipment configuration and default options.

Further, your existing JCL can be converted back to Colt. This allows you to run a cataloged program on alternate equipment without "reJCLing." Or, you can use cataloged programs in a variety of contexts.

And, this is only the beginning.

Write for Aim's Colt-360 brochure today.

Automatic Information Management,  
16033 Ventura Blvd., Encino, California  
91316. Aim is a broad-capabilities  
software organization.

## Aim Colt-360

CIRCLE 80 ON READER CARD

// COLT-360 CUTS JCL: OS, DOS.  
// TRANSLATES JCL TO COLT-360.

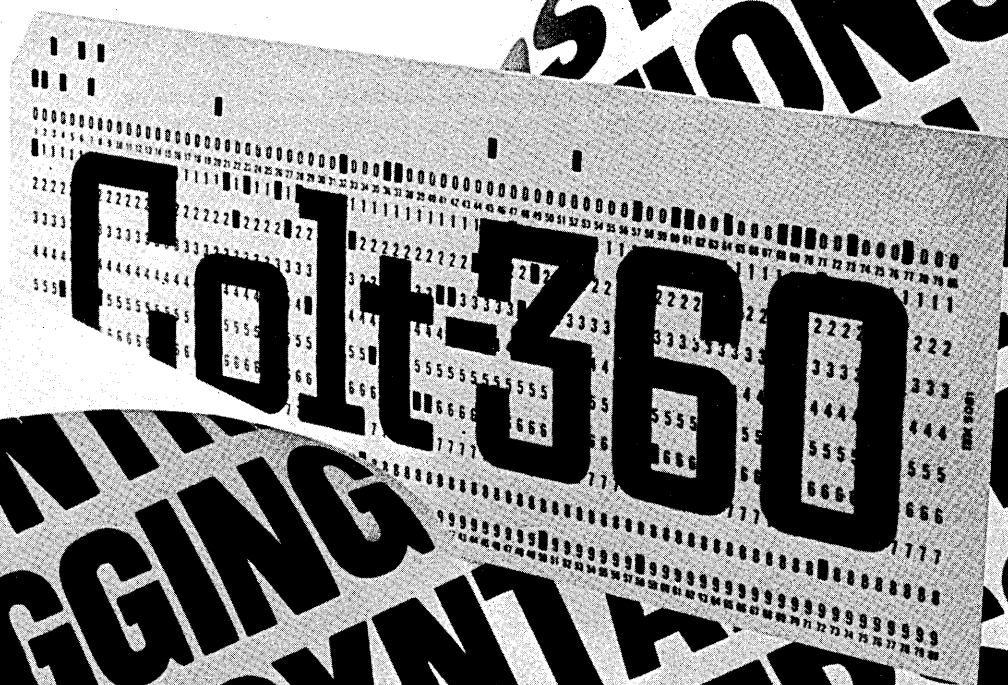



# world report

---

## FRENCH WARM TO BURROUGHS AS UNIVAC WITHDRAWS

Happenings at the French Department of Social Security give one of the first glimpses of how Plan Calcul will shape up over the next two to three years. As one of the plum contracts, this will develop from a three megabuck job that is mainly storage and retrieval work with minimal processing. Until recently, Univac has been a prime contender with yet another 1108 and a host of peripherals and displays hooked on real-time. After putting a 40-man team on the system, Univac has faded into the background to allow Burroughs to step in. Although a B6500 was expected to win out, an alternative scheme on twin B3500's has apparently turned into the big attraction. Curiously enough, this configuration has also brought satisfaction to CII, the conglomerate which has been formed under Plan Calcul to keep the French computer industry flag waving.

CII puts the first of its wares on show shortly at the French business equipment exhibition, Sicob, held in Paris in the fall. Sticking to the small- to middle-range of dp processors, CII reckons it can soon oust comparable American equipment currently installed by central institutions as soon as production is in full swing.

## SALES TO EAST BOOST ICL REVENUE

More business from Eastern Europe has brought International Computer Ltd.'s sales to the socialist bloc to nearly \$30 million. The latest contracts worth \$2.5 million include two 1900's for the International Labour Office's Management Training Centres in Budapest and Sofia. These are financed through a \$1.3 million United Nations' development programme. The Bulgarian Institute for Constructional Cybernetics in Sofia has also listed for a System 4-40. Other machines are slated for Polish and Yugoslav state-operated industries.

## FREIGHT TRANSIT TRADE ENTICES FRENCH, ENTANGLES UK

In the UK, the Post Office's National Data Processing Service has got into troubled waters through little fault of its own. In a helping hand to another state-backed organisation which has no computer capability of its own, the NDPS took on the job of advising the British Airports Authority about the equipment and systems needed to control the import of freight through London's Heathrow Airport, a job for which \$5 million has been earmarked.

Almost from the word go, the project has deteriorated into a most glorious wrangle of politics

# By the time an ECPI student writes 21 programs like this, you know he's been pretty well de-bugged.

You know that it takes lots of hard work and hands-on experience to become a skilled programmer. And since we know it too, that's exactly what an ECPI student gets. If he can take it.

We run the toughest obstacle course in the business because we know you need programmers who've been toughened the hard way. So when you interview an ECPI graduate, you know he's been over the hurdles. He's sweated through hundreds of hours of programming classes and several hundred more of homework. He's struggled with 5

KEY	LINE	PROGRAM NAME	DESCRIPTION	LINE
011	BRIDGE	BRIDGE	BRIDGE	01
012	BRIDGE	BRIDGE	BRIDGE	02
013	BRIDGE	BRIDGE	BRIDGE	03
014	BRIDGE	BRIDGE	BRIDGE	04
015	BRIDGE	BRIDGE	BRIDGE	05
016	BRIDGE	BRIDGE	BRIDGE	06
017	BRIDGE	BRIDGE	BRIDGE	07
018	BRIDGE	BRIDGE	BRIDGE	08
019	BRIDGE	BRIDGE	BRIDGE	09
020	BRIDGE	BRIDGE	BRIDGE	10
021	BRIDGE	BRIDGE	BRIDGE	11
022	BRIDGE	BRIDGE	BRIDGE	12
023	BRIDGE	BRIDGE	BRIDGE	13
024	BRIDGE	BRIDGE	BRIDGE	14
025	BRIDGE	BRIDGE	BRIDGE	15
026	BRIDGE	BRIDGE	BRIDGE	16
027	BRIDGE	BRIDGE	BRIDGE	17
028	BRIDGE	BRIDGE	BRIDGE	18
029	BRIDGE	BRIDGE	BRIDGE	19
030	BRIDGE	BRIDGE	BRIDGE	20
031	BRIDGE	BRIDGE	BRIDGE	21
032	BRIDGE	BRIDGE	BRIDGE	22
033	BRIDGE	BRIDGE	BRIDGE	23
034	BRIDGE	BRIDGE	BRIDGE	24
035	BRIDGE	BRIDGE	BRIDGE	25

rugged exams during the life of the course, and then passed a gruelling three-hour final.

But we know it takes more than just the best textbooks to learn programming. So we make sure

our students get the practical experience they need. We make them write 21 programs in third-generation languages. And then give them time on third-generation equipment to verify what they've written.

That's a pretty tough test for even a veteran. But the student who gets through it has got something going for him.

Because by the time he's done, the knowledge is in. And the bugs are out.

© 1968, Electronic Computer Programming Institute, Empire State Building, N. Y., N. Y.  
**ECPI ELECTRONIC COMPUTER PROGRAMMING INSTITUTE**

The  
toughest  
obstacle course  
in the business.

## world report

and inter-industry rivalry. To start with, London Airport has traditionally carried the bulk of freight in transit to and from Europe, as well as handling normal UK traffic. For two years, the workload on customs and freight men has gradually been burying them in ever-increasing paperwork.

On the other side of the Channel, the French airport men have cast envious eyes on the freight transit trade which could net the French an extra \$100 million a year if carefully syphoned off from London. With their new airport at Orly, the French have been moving toward a real-time control system with which to entice more business through their runways. To match this, the UK accepted tenders for a system with 250 display terminals.

At the turn of the year, the scene was set in London for a choice between Univac and IBM cpu's with Ferranti supplying the terminals. Apart from being the outfits with the most credible experience, the two American firms have supplied the computer systems for both BEA and BOAC. The airport system has to be plugged into the airlines' networks sooner or later.

As time passed, the specs took one of those mysterious shifts that tend to occur on dark nights. An expected quick decision receded, and recently the newly painted ICL emerged around the corner with some interesting propositions -- if the tender were changed from a 12-month delivery with payment only on work, to a regularly phased implementation and payment plan. Although ICL has most uncharacteristically "soft sold" on this project, there are civil servants only too acutely aware of the government's \$40 million stake in ICL, and of the fact that ICL has need to draw blood in the real-time dp ring.

### NEW INTERNATIONAL ADP GROUP MAY BE FORMED

Support is gathering for a body to be called the Inter-Governmental Committee for ADP. Mooted at a pre-IFIP meeting held ahead of the August jamboree in Edinburgh, the Inter-Governmental project emerged from an Israeli group. The idea is to get agreement and coordination on the way that statistical information is handled by international agencies such as UNO, the OECD in Paris, and independent government departments. In practice, the scheme is to ensure that groups working on economic, social and industrial development can obtain relevant data. Whereas most comparable ideas aim at cutting duplication, this one is dedicated to preventing the harbouring of information which could be of value elsewhere. Some powerful advocates look like they're rallying to the cause. In the UK, the Treasury O&M men would like to see it succeed, and in the United States, Herb Grosch, of the Bureau of Standards' Center for Computer Sciences and Technology, has returned from Europe with enthusiasm for the scheme.

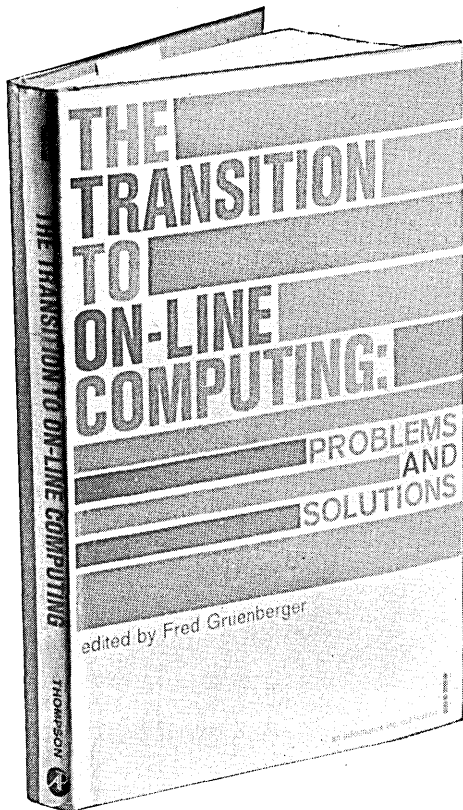

JUST PUBLISHED  
220 PAGES  
ILLUSTRATED  
\$9.00

AN  
**informatics inc.**<sup>®</sup>  
PUBLICATION



You need to know now because

**BY 1975  
NEARLY ALL  
COMPUTERS  
WILL BE  
"ON-LINE"**

Whether the development of "on-line" systems has been evolutionary or revolutionary, it is estimated that by 1975 nearly all computers in this country will be "on-line" in the sense of being part of an electronics system, or attached to instrumentation such as communications and display devices.

Thus there is a great need for knowledge about "on-line" systems . . . and much basic information in this new book, "The Transition to On-Line Computing."

Written, not by remote observers, but by working experts, it includes papers written by eleven of the technical staff members of Informatics Inc., leader and specialist in "on-line" systems.

It covers such subjects as: What is On-Line? . . . Time-Sharing and Multiprocessing Terminology . . . On-Line Software—the Problem . . . Display Software Technology . . . Hardware for On-Line . . . Conversational Computing . . . Cost Effectiveness of Time-Shared Computing Systems . . . Survey of CRT Display Consoles . . . Terminal-Oriented Software . . . How the Computing World Went On-Line (A History of 1967 through 1978) . . . Experiences in Offering On-Line Computing Power.

Because of the growing importance of the "on-line" world, this book will be a well-thumbed addition to your library.

**THOMPSON BOOK COMPANY**  
National Press Building, Washington, D. C. 20004

Please send me ..... copies of  
"The Transition to On-Line Computing" @ \$9.00

Check  Cash  Money Order Total \$.....

Name .....

Address .....

City ..... State ..... Zip .....

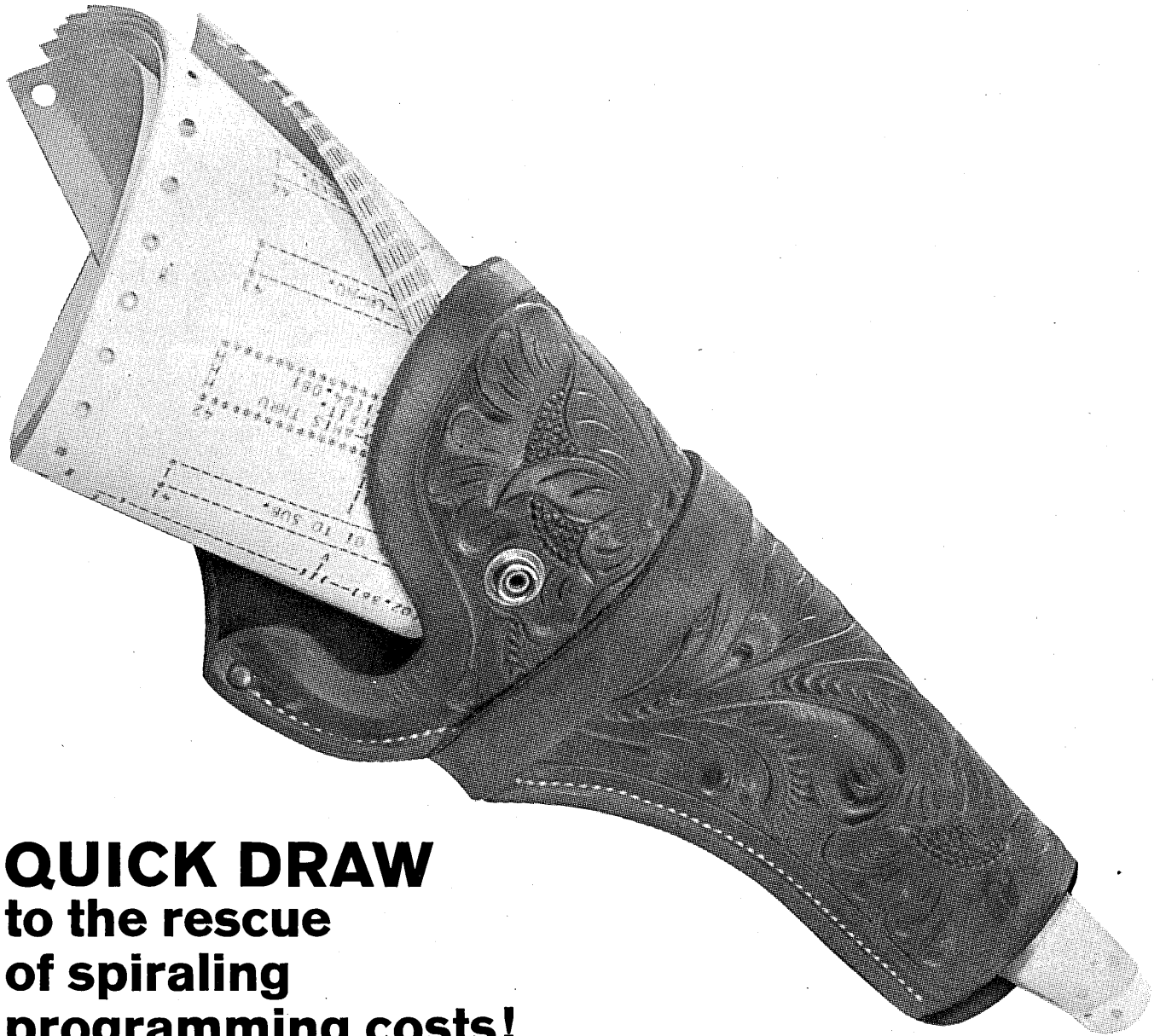

## QUICK DRAW to the rescue of spiraling programming costs!

General Custer didn't have a chance.  
You do.

It's simple enough to call for reinforcements. By return mail we'll rush a copy of a Quick Draw Management Report that shows how spiraling programming costs can be halted.

Quick Draw is a newly announced programming tool for most computer users that standardizes program documentation. It actually frees your programmers from the burden of documenting their programs. You simply use the power of your own computer and save up to 30% of present programming costs.

Your programmer does nothing. In a matter of minutes, your computer prints out a flow chart, a reference format listing, a cross reference to data name and a cross reference to paragraph name.

You can use Quick Draw to automatically document new and current programs (or even incomplete ones), for standardizing documentation, for efficient program maintenance and for dollar saving debugging. And all with complete accuracy from your source program decks and tapes. Whether they're written in COBOL,

FORTAN, BAL or other assembly languages.  
Sound interesting?

Just clip, complete, send this coupon  
and learn why. No obligation.

**NCR**<sup>®</sup>

Mail to: QUICK DRAW  
The National Cash Register Company  
Box 111, Walnut Street Station  
Dayton, Ohio 45412

Help! I want to know more about Quick Draw and  
how it can rescue spiraling programming costs

NAME \_\_\_\_\_

TITLE \_\_\_\_\_

COMPANY \_\_\_\_\_

STREET \_\_\_\_\_

CITY \_\_\_\_\_

STATE \_\_\_\_\_

ZIP \_\_\_\_\_

CIRCLE 83 ON READER CARD

## **PROGRAMMER'S PROGRESS AT XEROX:**

# From system to system, with your career in view.

At Xerox, programmers are involved in virtually every phase of business operations. As the need arises, depending upon your background and career goals, you'll be concerned with programs that may range from marketing research to business modeling to manufacturing to accounting to engineering.

Providing people with this kind of varied exposure helps develop a strong, innovative staff for us, and helps you to develop broad experience...which is the best preparation for better things to follow. As a point in fact, that's one reason why most of our programmers are called programmer/analysts.

Since our most important product is better customer service, we are looking for



talent that can utilize EDP and systems thinking in their broadest sense to provide practical, business-like solutions to multi-faceted problems. It's the kind of talent that is going to help direct our operations in the future.

If you have a Bachelor's degree and/or experience with an IBM 360 or 7000 system, or a Univac 1108, using COBOL or AUTOCODER, there could be a future management opportunity waiting for you at Xerox. To find out more about the opportunities on all levels, send your resume, including salary, history and requirements, to M. H. Hartigan, Dept. MZ-27-J1, Xerox Corporation, P.O. Box 1995, Rochester, New York 14603.

An Equal Opportunity Employer (m/f).

# XEROX

**DATAMATION**

# washington report

## GOVOPS DEMANDS A-76 HAVE COST COMPARISON CRITERIA

Cost comparisons -- not government-wide personnel ceilings or civil service laws -- should determine whether a support service contract should be performed in-house, the House GovOps Committee recommended last month. Their report demanded that the Budget Bureau revise or rewrite Circular A-76 to provide specific criteria for determining cost comparisons, and to clarify the cost-savings necessary to justify contracting-out for support services.

The committee, headed by Congressman Porter Hardy of Virginia, recommended limiting cost comparisons on a trial basis to direct labor costs and fringe benefits, except in unusual circumstances. "Common costs," which some contracting agencies also include at present, should be ignored.

The GovOps report also supported efforts to relax the recently imposed cutback in federal employment to '66 levels -- a reduction some officials feel will force greater use of outside service firms.

## JEC REVIEWS POLICIES ON PROGRAM BUDGETING

Head Start and Upward Bound are finding planning-programming-budgeting useful, OEO ass't director Robert Levine told the Joint Economic Committee last month. The Bureau of Public Roads, however, told committee chairman Sen. William Proxmire it does not now, nor in the future, plan to implement PPB.

Proxmire called the hearings to consider a "consistent" PPB policy for all agencies -- one that would permit comparisons between similar programs and establish priorities for public expenditures.

Meanwhile, GAO is continuing its inquiry into PPB in government to determine agency compliance with Budget Bureau directives, and the cost and variety of internal procedures implementing PPB. Findings won't be available until January.

## '69 CONTRACTS CONCEDE GSA NEGOTIATION CLAUSE

GSA has won some major contract concessions from equipment manufacturers. All suppliers are expected to sign FY'69 contracts this month. Probably the most significant change is a "maximum order limitation," allowing a federal agency to contract for the purchase of one cpu (with associated peripherals) on its own, but requiring multiple-unit acquisitions to be negotiated by GSA. IBM led unsuccessful industry efforts to weaken this new arrangement.

Long-term leasing clauses were included in the bulk of the contracts for the first time, offering a wider variety of percentage reductions and time periods. The warranty clause has also been strengthened; it holds the supplier responsible for all representations in his proposal...including sales literature claims.

## CAPITOL BRIEFS

Sponsors of the Intergovernmental Cooperation Act -- which would permit federal departments and agencies to provide technical services for state and local governments -- will attempt to slip the measure through the House late this month; similar legislation passed the Senate earlier this year...COMNET will open a NYC office next month and should have a B5500 in operation by November; Joe Melick, former GE t-s manager in NY, will head the new office...The Justice Dept. has asked IBM for price, cost and anticipated revenue data on Call/360, to determine if the company is trying to monopolize the commercial t-s market, and violating the '56 consent decree. Sen Gaylord Nelson had suggested as much earlier (Aug., p. 87).

1850's—the Gold Rush  
was in California.

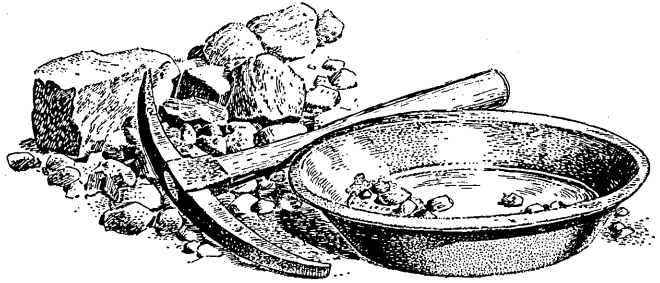

1880's—the Land Rush  
was in Oklahoma.

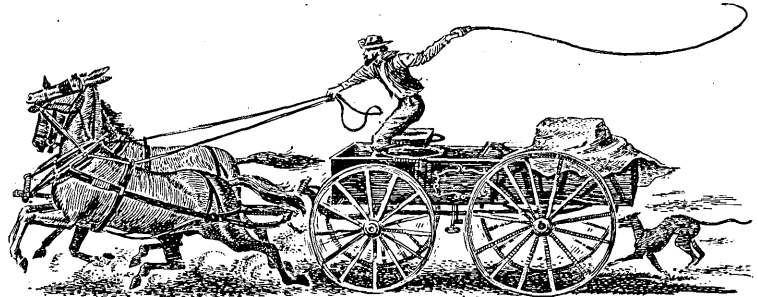

1970's—the Space Rush  
is in Houston.

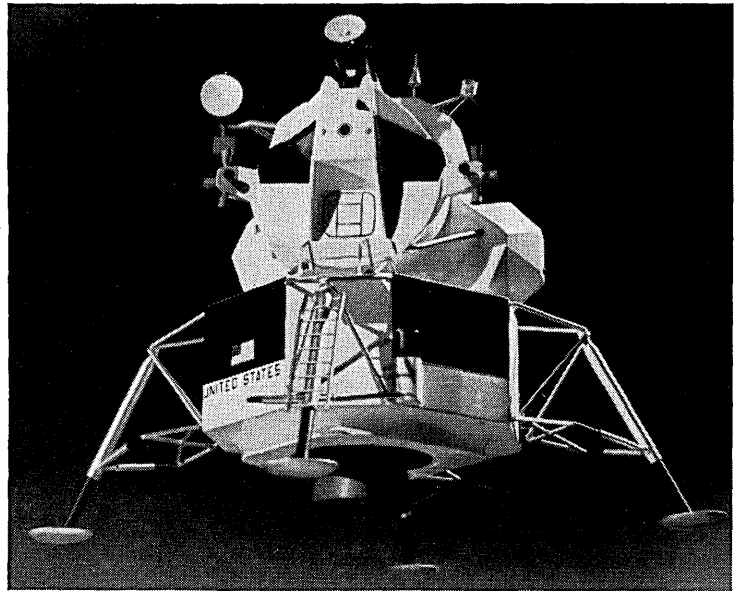

## Ready to pioneer? Rush to Houston!

If you're the kind who can't sit still when a rush is on, Houston is the place for you.

Here at Lockheed Electronics. At NASA's Manned Spacecraft Center.

Here is where things are happening. Where knowledge is being pushed right over the boundaries.

You can help develop programming systems and advanced numerical and computing techniques utilizing digital, analog or hybrid computers for scientific computation, data acquisition, transmission and processing. Or you can analyze flight and static test data engineering to determine performance of vehicle sub-systems. To mention just a few facets of our overall mission: The successful exploration of outer space.

You'll get all the responsibility you can handle, and plenty of encouragement to do individual work.

You'll have the opportunity, too, to advance your education

—in company sponsored courses or in graduate work at nearby colleges and universities.

We have regular management training programs in which we enroll key management and potential management people.

You'll find housing both plentiful and reasonable, just minutes away from your work. And sailing, golf, theatres and museums are only a few minutes further away.

Schools are excellent. In 1966, nearly 10% of the high school seniors in our school district were semi-finalists in the National Merit Scholarship tests, compared with the national average of 1/2 of 1%.

So if challenges appeal to you . . . if you want to work right at the center of America's aerospace effort, Lockheed Houston is interested in you.

Send a note outlining your experience and qualifications to Dean Pearson, Employment Manager.

Do it today.

**LEC LOCKHEED**  
ELECTRONICS COMPANY

A Division of Lockheed Aircraft Corporation  
16811 El Camino Real, Houston, Texas  
An Equal Opportunity Employer



• PROGRAMMERS AND ANALYSTS •

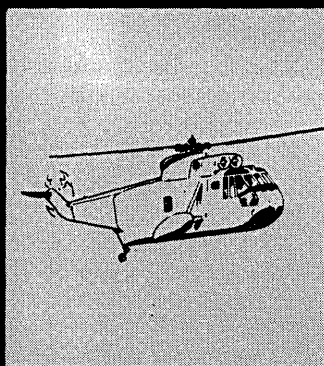
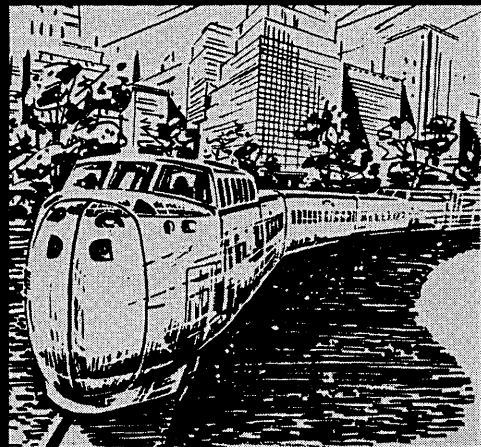
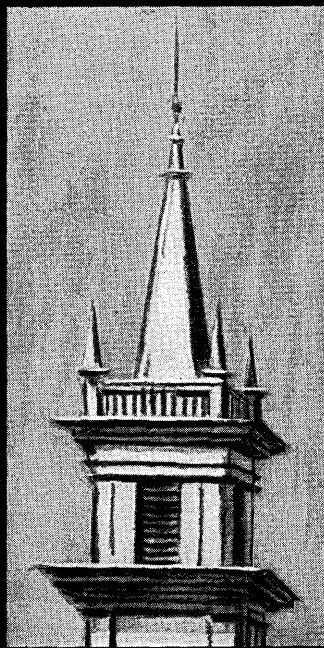

# Sikorsky Aircraft

DIVISION OF UNITED AIRCRAFT CORPORATION

U  
A

STRATFORD, CONNECTICUT

An Equal Opportunity Employer

... in our  
**SCIENTIFIC & COMMERCIAL  
COMPUTER-BASED  
ANALYSIS &  
DESIGN SYSTEMS**

You can. You'll like what you see at Sikorsky Aircraft—a company dedicated to producing the most advanced VTOL airborne and surfaceborne transportation systems.

And you'll like working with a select group of stimulating, top-talent people . . . on abundant and provocative challenges. You would be applying your professional talents to specifying, designing and implementing advanced computer-based technical and commercial systems.

Our current equipment includes Univac 1108's and IBM 360's with Graphics and Teleprocessing.

Current and planned applications include—

**Scientific:** Man/Machine Interactive Graphics in Engineering Analysis and Design.

Development of Batch Programs and Systems in all engineering disciplines.

**Commercial:** Data Base and Real Time applications in Accounting, Manufacturing, Purchasing, Inventory Control and other related areas.

We have exceptional assignments at all levels of experience for:

**COMPUTER SYSTEMS  
PROGRAMMERS AND ANALYSTS  
FOR BOTH COMMERCIAL  
AND SCIENTIFIC FIELDS**

You and your family will find the unique cultural and recreational advantages of pleasant Connecticut to be abundantly satisfying. And our interest in your continuing professional development is exemplified by our corporation-financed Graduate Education Programs. They are available at these fully accredited schools: Bridgeport • Brooklyn Poly • CCNY • Columbia • Connecticut • NYU • Rensselaer (Hartford Grad. Center) • Stevens • Trinity • Yale.

Send your resume in confidence, stating salary requirements, to Mr. Leo J. Shalvoy, Professional Employment.

# Programmers, if you're ready to give more to the present, you're sure of a solid future at RCA.

RCA is as interested in your present progress as you are. It's not altogether an unselfish motive. We want to keep up our record in programming accomplishment much as we have in hardware technology—producing faster higher-capacity machines. You can help our present and future record in the programming area. For instance, here are two RCA divisions that are leading the way.

**Information Systems Division** is in a period of unprecedented growth as a direct result of the success of the Spectra 70 product line, a true third generation computer system. Here EDP professionals can find unmatched opportunities for career development.

Systems Programming projects include time sharing, executive systems, random access, compilers, utility systems, information retrieval and other areas. Other career opportunities exist in management information systems, field systems support, special industry applications, product planning, engineering and EDP sales.

Openings are at all levels for those with a minimum of 2 years experience. Location is in Cherry Hill, New Jersey, and other areas throughout the United States.

**RCA Graphic Systems Division** is busy adding the speed of electronics to typesetting.

At this division we've combined computers with new electronic typesetters that can set the text for an entire newspaper page in less than two minutes. Together, they do the complete job: store and recall manuscripts, size and lay out pages, and set the type.

These assignments require exceptional programmers who combine experience and competence with imagination.

It isn't easy, but it's fascinating; requiring bold creative effort in return for personal recognition and reward.

Openings are at all levels for those with a minimum of 2 years programming experience. Location is Princeton, New Jersey.

*To find out more about these major areas of programming at RCA, write to: Mr. T. Beckett, RCA, Dept. SW-9, Bldg. 2-2, Camden, New Jersey 08102. We are an equal opportunity employer.*

634  
05  
764

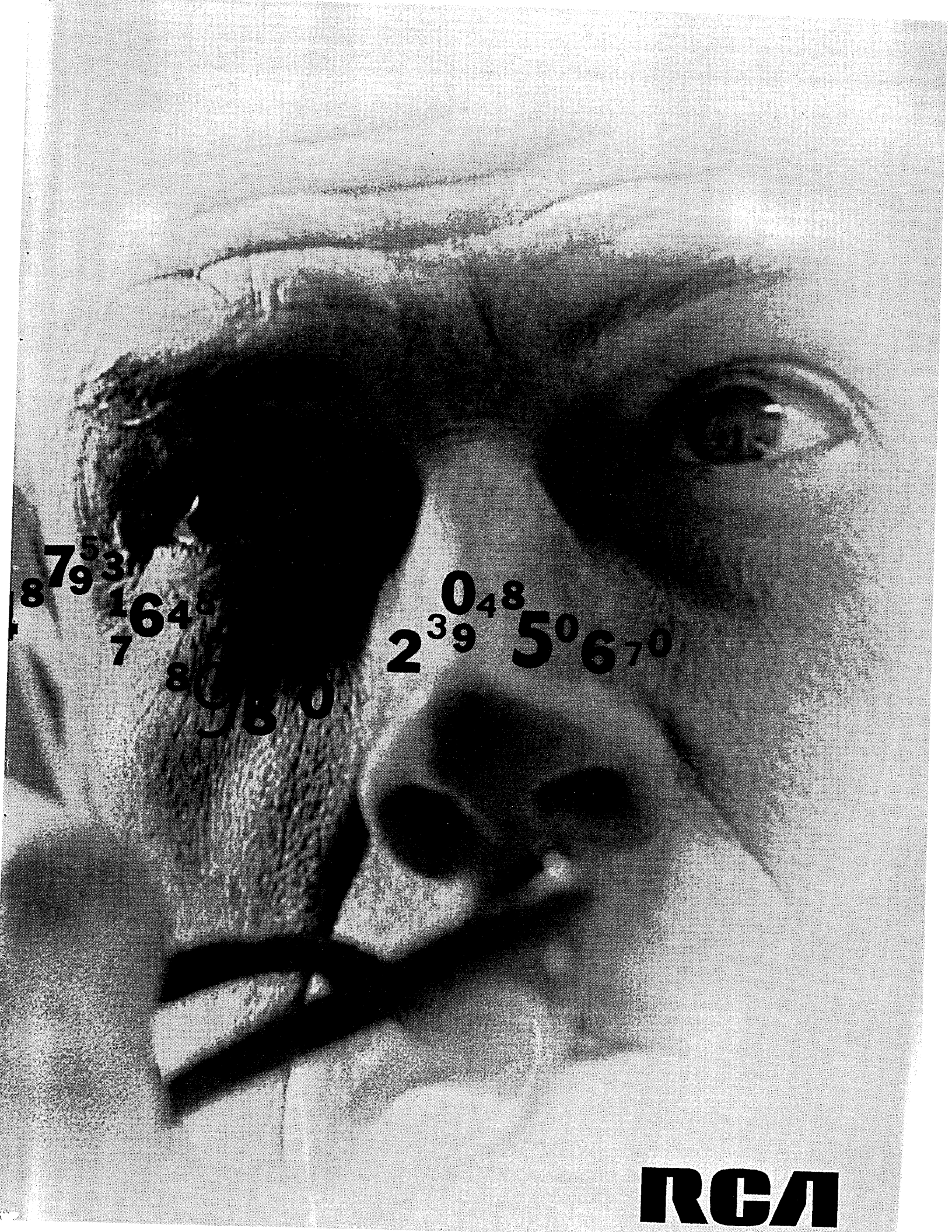

8 7<sup>5</sup> 9 3  
1 6 4 8  
7  
8 0 9 8 0  
2 3<sup>9</sup> 0 4<sup>8</sup> 5<sup>0</sup> 6 7 0

**RCA**

# T

**MORROW'S BEST CAREER OPPORTUNITIES ARE IN**

## **REAL-TIME APPLICATIONS REMOTE-ACCESS TIME-SHARING**

*Take Advantage of Them TODAY at LEASCO*

LEASCO SYSTEMS & RESEARCH CORPORATION is expanding dynamically in two of the most promising areas of hardware/software technology — real-time and remote-access time-sharing. To help staff these growing operations we are offering exceptionally attractive career opportunities to individuals with solid third generation computer background who are experienced and capable in any of the following:

- TECHNICAL MANAGEMENT
- SYSTEMS PROGRAMMING
- APPLICATIONS ENGINEERING
- MARKETING AND SALES

Most positions are at our attractive suburban Washington, D. C. headquarters, with some openings in other major cities. Salaries and benefits are excellent, and so is the growth potential. Qualified candidates are urged to write: Mr. Oliver Bright.

### **LEASCO SYSTEMS & RESEARCH CORP.**

4833 Rugby Avenue  
Bethesda, Maryland 20014

An equal opportunity employer



CIRCLE 310 ON READER CARD

## **SYSTEMATION CONSULTANTS, INC.**

Houston-New York

### **Management Science Director**

Profitably expanding \$200MM Texas based growth company with top management in their 40's seeks Manager of uncommon enterprise and experience. Require technical experience in Management Science/Operations Research and also prefer additional experience in Management Systems activities including commercial computer applications. Ambitious objectives for new department combine with progressive top management to offer outstanding opportunity —starting salary to \$20,000 range plus incentives—Dallas.

### **Systems Engineer**

Probably the fastest growing listed company in their industry seeks BSEE capable of assuming total systems project responsibility in the development and implementation of computer control/data acquisition systems. Require hardware experience in such areas as digital logic/circuit design, A/D and D/A converters, DDC or Supervisory control systems, etc. and prefer some software interfacing experience. Ground floor opportunity with company moving into new growing market practically untouched by major CPU manufacturers. Starting salary to \$17,000 range—Southwest.

### **Programmer Analysts**

Recent operating company merger resulting in greatly expanded systems department has created growth opportunities for two programmer analysts with 360 commercial applications experience. Prefer 360 BAL, COBOL, and DOS or OS and must be capable of assuming creative applications and configuration analysis responsibilities. Large sophisticated hardware systems with multiprogramming environment combine with progressive management to offer professional and rewarding position. Starting salary to \$14,000—Houston.

### **NO FEE**

The above positions are only a small sampling of the exceptional hardware and software opportunities within the activities of systems design/programming, process control, scientific/commercial applications, etc. as well as marketing, Operations Research, and other associated activities of our client companies in various domestic and international locations—both jr. and sr. positions available. Your current employer will not be contacted without your permission. Send resume in confidence or request our resume form. A call to our Houston Director—J. L. Gresham, BChE, MBA—for further information is also invited.

1616 West Loop South

Houston, Texas 77027

(713) NA 2-1370

CIRCLE 307 ON READER CARD

## **PROGRAMMERS ENGINEERS**

Washington, D.C. • New York • New Jersey • New England • Philadelphia • Chicago • Minnesota • Texas • Ohio • Florida • Arizona • California • Southeast Asia

If you have a B.S., M.S. or Ph.D. and you are experienced or interested in any of the following, contact us immediately for free career counseling and an objective analysis of your position in today's market.

### **PROGRAMMERS**

- Management Info Systems
- Information Retrieval
- Command & Control
- Aerospace Applications
- Real Time/On Line
- Systems Simulation
- Software Development
- Communications

### **SYSTEMS ENGINEERS**

- Reliability Analysis
- Digital Computer Systems
- Digital Logic Design
- Digital Circuit Design
- Digital Communications
- Systems Integration
- Soft Ware Analysis
- Oceanography

Salaries range from \$8,200 to \$25,000.

Our client companies assume all fees.

Forward resume in confidence, or call (collect):

Mr. Martin E. Sheridan  
Area Code 703) 524-7660

### **SHERIDAN ASSOCIATES INC.**

1901 North Fort Myer Drive  
Suite 614  
Arlington, Virginia 22209

(Just over the Potomac from Washington, D.C.)  
Personnel Consultants to the Computer Industry

CIRCLE 306 ON READER CARD

### **PROFESSIONAL**

## **COMPUTER PERSONNEL**

Washington, D.C.

\$7,000 to \$20,000

- SCIENTIFIC PROGRAMMING
- SYSTEMS ANALYSIS
- SYSTEMS PROGRAMMING
- BUSINESS PROGRAMMING

ALLOW US TO ARRANGE A PERSONAL INTERVIEW WITH THE WASHINGTON AREA'S MOST DESIRABLE EMPLOYERS.

Our service is confidential and personal. We are one of the oldest and most effective E.D.P. placement specialists in the East.

*All fees and expenses paid by employer*

## **SYSTEMAT**

9525 Georgia Ave.  
Silver Spring, Md. 20910  
301-587-3650

We  
Unscramble  
Computer  
Careers

CIRCLE 308 ON READER CARD

**DATAMATION**

## look ahead

Other exceptions are likely -- notably some 64-character set scientific users; but they may have to adopt the full ASCII code if their systems are likely to be used partly for administrative applications.

Questions regarding packed numerics, sign conventions, subset and superset standards will be resolved after the letter is distributed.

NBS hopes to establish a central programming-testing facility to support ASCII conversion efforts of agencies which lack enough programmers of their own.

Industry reaction: IBM remains inscrutable while CDC and Burroughs squawk. A key question is whether the directive will give 6-biters time to redesign. Honeywell has already started, apparently; it is reported to be developing an 8-bit machine meant for public unveiling in about two years. The federal attitude toward this problem is philosophic: "you can't make an omelet without breaking eggs," as one key official puts it.

Another says that once the directive is adopted, ASCII will be extended to related applications -- e.g., state and local governments; private users of census and other government statistics; contractors and universities that acquire dpe with federal money.

### STEADILY DROPPING PRICES GET TO THE CORE OF THINGS

Adding to the increasing trend toward a decrease in core memory prices, Standard Memories, Santa Ana, Calif., firm, will make available in October two new memory systems for OEM at a cost of around \$450 for a 128 X 18 bit unit and \$600 for one twice the size, a 4.5K bit item. Both named the "ecom-small," the two memories measure 7" by 16" by 1" high, are heavily circuit-integrated, have a 2.5 usec cycle time and include mating connectors.

Core stack prices have also dropped in the last six months -- by about 20%. The reason apparently is not because of any breakthrough in manufacturing techniques, but is due to purchase of stacks in volume quantities -- several hundred to a thousand -- by the small computer makers, led by DEC. This enables the stack manufacturer to place a portion of the wiring job at foreign locations (e.g., Hong Kong, Formosa, the Philippines, Portugal) with cheaper labor rates. The manufacturer can also take smaller orders for the same stacks, tack them on to a large order and produce them all in the same run, bringing down production costs. The cost per bit on 4K stacks has dropped from 1.5¢ to 1.2¢ and seems headed down.

Price war, anyone?

### EMR SNAGS WEATHER BUREAU JOB, ADDS MORE BIG ORDERS

EMR Computer, which will announce a faster version of its 6130 at the FJCC, is jubilant about having just beat out Lockheed and IBM on a \$1,670,000 contract with the Weather Bureau for the Data Handling System. To be installed about next June at the National Environmental Satellite Center, Maryland, will be two 6130's, two 6050's, and an intercomputer link from one 6050 to the Bureau's CDC 6600. Other causes for EMR joy include a follow-on order from the Royal Aircraft Establishment for two 6130's for the Black Arrow Project (England's spy-in-the-sky satellite) for all telemetry control, order for two 6130's for McDonnell-Douglas to go in Oct., and a 6130 order from the Lawrence Radiation Laboratory.

The EMR plant tripled its space last spring and the company is closer to showing a profit than previously. There have been 47 installations of the 6000 series, with an additional 10 on order; 19 6130's are installed and 20 on order. These run about 60% sales and 40% leases.

(Continued on page 165)

# NO TWO PEOPLE ALIKE.

"A truism," you say. Certainly. But at URS we put this truism to work—the ideas and aspirations of the individual are important, the humanistic approach is stressed. And we accord the same respect to our clients.

"But what does URS do?" you ask. Principally, we help people make effective use of computers, from concept to operation—analysis, design, programming, and implementation and operation of computing and management information systems.

We are, for example, prime software contractor for the Army's Combat Service Support System which will ensure more efficient use of men and material. (We also tackle a variety of problems in the physical and engineering sciences.) As for our performance, a client

recently told us, "Happiness is a contract with URS."

In the future we will be devoting an increasing portion of our efforts to improving the quality of man's environment. A look at the world about us suggests a limitless challenge.

Can you help? If so, send a resume to, or request application from: Mr. Jack Davis, Information Sciences Division, URS Corporation, 201 Lincolnia Rd., Alexandria, Virginia 22304.

We have openings now for experienced programmers, analysts, software marketing men and communications engineers in our offices in the Washington, D.C. area; San Francisco; Killeen, Texas; Kansas City, Missouri, and Petersburg, Virginia. In your letter let us know which of these locations interests you.

**URS**

■  
CORPORATION

1700 South El Camino Real, San Mateo, California 94402  
an equal opportunity employer—by choice!

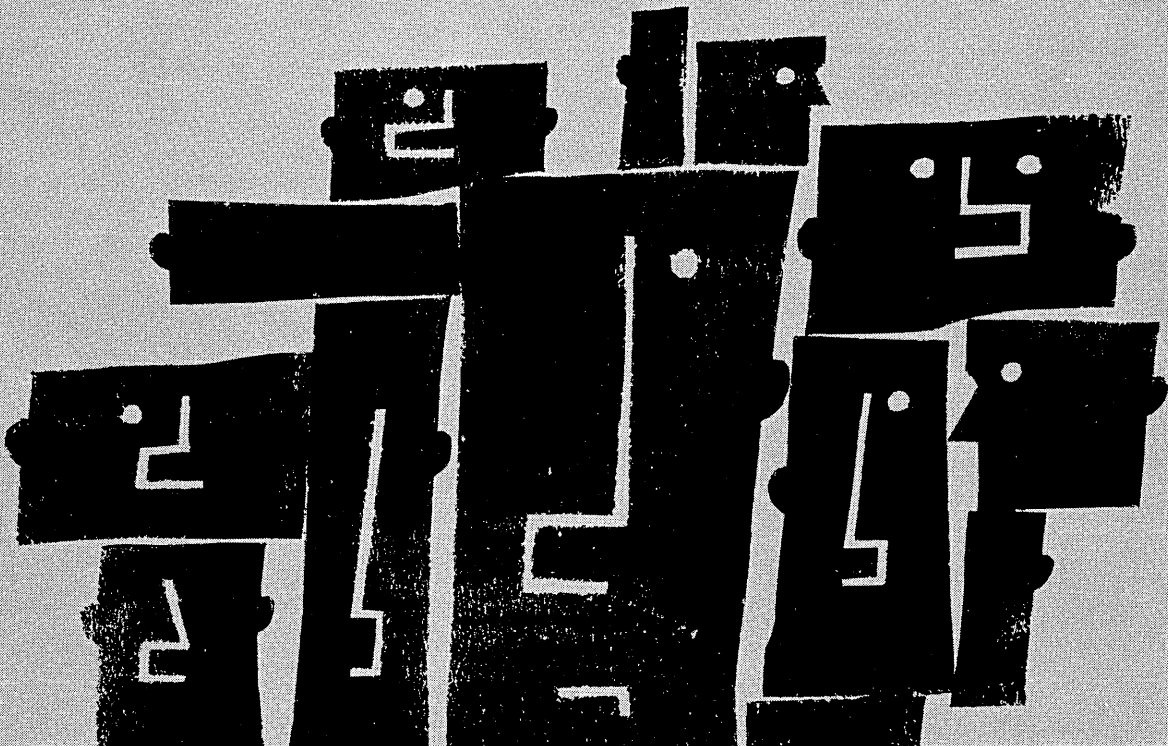

## look ahead

### SENATE COMMITTEE GOES AFTER CHIEF-HEAVY GOVERNMENT DP

The Senate GovOps committee is hiring a blue-ribbon team of experts to staff an in-depth investigation of federal dp management. The staff will be borrowed from GSA, GAO, and the Library of Congress. The study will begin next January, under Sen. Joseph Montoya. One aim, reportedly, is to replace the present dp directorate (BOB, GSA, and NBS) with a more powerful commission placed higher in the Executive Branch. A commission bill, introduced several months ago by Montoya, will be rewritten and re-introduced.

Knowledgeable sources say the investigators will also try to prove that far more joint utilization of equipment is needed; that federal dp operations employ too many chiefs relative to the number of Indians; and that federal standardization efforts must be drastically re-focused to concentrate on system applications rather than data elements and codes.

### BRYANT TO ANNOUNCE NEW LOW-COST DRUM AS BACKLOG SPINS UP

Bryant Computer Products will announce next month their CLC-1 (Compact Low Cost Series 1), a small drum system with 1.2 million bit storage. The head-per-track system includes write-read-select electronics and will cost \$4,800, or \$3,700 in quantities of 25 or more. Access time is 8.5 msec.

Bryant will also announce their Disc File II-4000 as compatible with the 360/30 and above (OS) and with 2311 and 2314 disc drives. A built-in interface adapter-controller simulates and emulates the 360's drives when the unit is plugged into the IBM 2841 controller.

### RUMORS AND RAW RANDOM DATA

BEMA has written to Patents Commissioner Edward Brenner for "clarification" of his office's policy on computer program patents. Key question is whether the one granted to ADR is a precedent or a special case... Latest hot-rumor candidates to acquire SDC are Gulf Oil and Arcata National Corp. Arcata's three subsidiaries include Butler Data Systems and J. W. Clement, nation's fourth largest printing firm. And the company will be in the \$100 million class this fiscal year... An association of time-sharing service bureaus is being formed, with an organizational meeting to be held this month. One objective: a look at the competitive implications of Call/360... The banking community has delayed plans for a checkless-society pilot project in an unnamed city, wants to do more research first. The American Bankers Association will soon set up a "blue chip" senior committee on payment systems to direct a series of task force groups... Next computer announcement from Burroughs should be the B 1500, due within a year. Users are also talking about the 7500, described as a three-cpu 6500... The airlines, through the Ticketing and Baggage Committee of the Air Transport Association, have adopted format specs for a computer-produced ticket and have independently begun work with manufacturers toward development of a ticket-issuing terminal. Though not in the current specs, a magnetically encoded stripe (for security purposes) may ultimately be on the ticket... GSA's next interagency service center, in Huntsville, is scheduled to open Nov. 1; its rates will be about one-third less than those of local commercial houses. The Los Angeles center, to be run by the Veterans Administration, is scheduled to begin operation early next year; it will offer system design and programming, as well as machine time.

Keep your eyes peeled for MAC.





# PROGRAMMERS

Teach it to talk before it's invented.

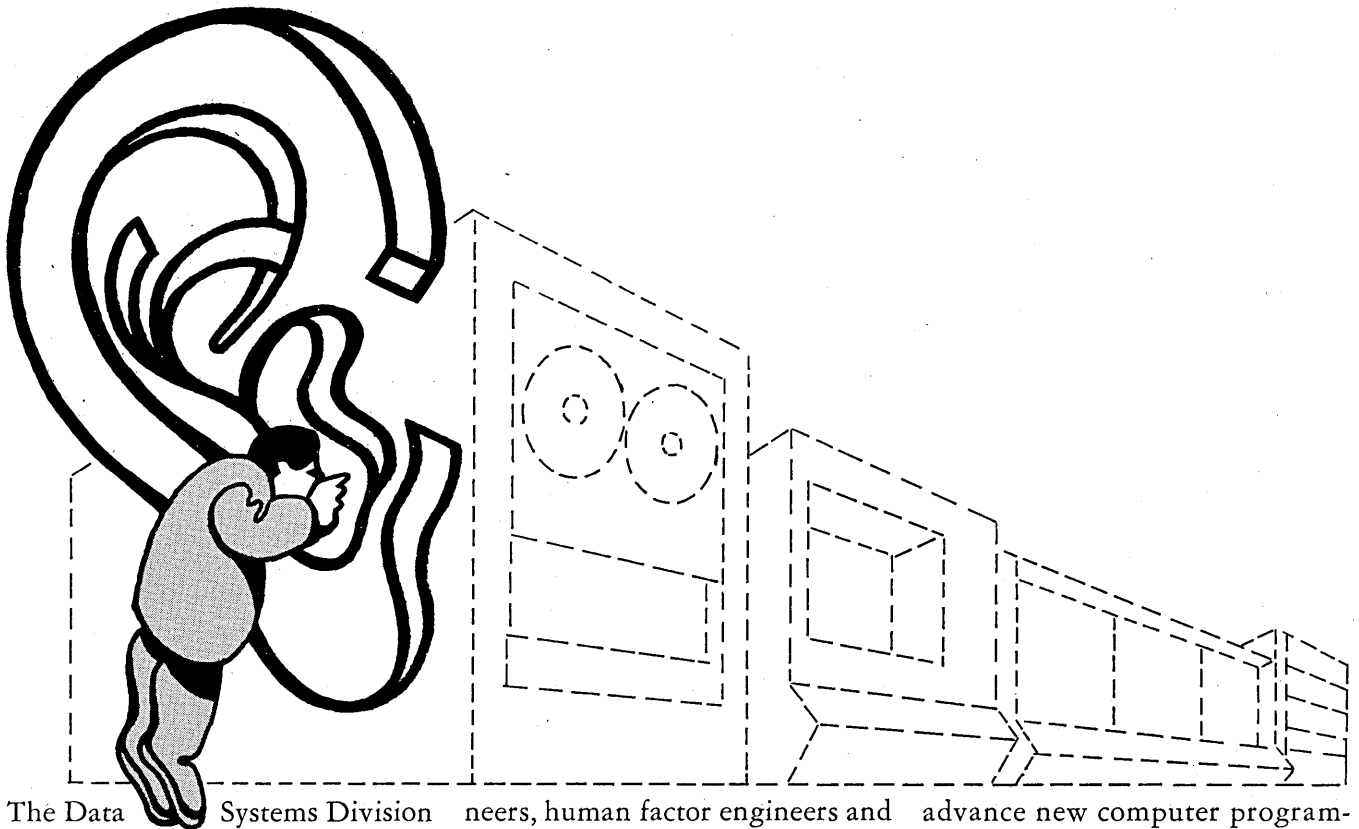

The Data Systems Division of Litton Industries is looking for above-average programmers with capabilities to match those of our fast-moving professional group—a group that enabled DSD to earn an incentive award by completing the Tactical Procedure Oriented Language (TACPOL) Compiler *ahead of schedule*. This industry first makes it possible for DSD to develop software for the TACFIRE Program *while* our new L3050M computer *is being developed*.

As a member of this talented group, you'll have the distinct advantage of working with system engi-

neers, human factor engineers and hardware specialists in developing complete third generation systems for our newly-acquired TACFIRE, DTAS, AWACS, LHA, DX and other programs. Our computer applications directorate provides advance programming expertise for all divisional projects—including the design and development of our general purpose computer line.

Our major programming accomplishments have all contributed to the rapid growth of Data Systems Division, a leader in Tactical Data Processing, Communications and Display Systems. Come learn and

advance new computer programming technologies with us. Program projects include: OPERATING SYSTEMS • DIAGNOSTICS • COMMAND/CONTROL SYSTEMS • SUPPORT SOFTWARE SIMULATORS • MATHEMATICAL MODELING.

For direct management contact and information, call Mr. T. D. Marley at Area Code (213) 781-8211, collect. Or send resumé to DSD, 15800 Strathern Street, Van Nuys, California 91406.

 DATA SYSTEMS DIVISION  
LITTON INDUSTRIES

— an equal opportunity employer —

# datamart

Address all replies to box number advertisements as follows:

Box .....

DATAMATION

F. D. Thompson Publications, Inc.  
35 Mason Street  
Greenwich, Conn. 06830  
Classified Advertising

## EQUIPMENT FOR SALE PURCHASE OR LEASE

Wanted: IBM 1301 Disk 7631 File Control & 1442 Model 3  
L. Reichman, Schering Corporation  
1011 Morris Avenue, Union, New Jersey  
Phone (201) 351-2700

## OUTSTANDING VALUES IN EDP EQUIPMENT selling/purchasing/leasing

Computer Sales Inc., Dept. 20, 128 Woodland Ave.,  
Yonkers, N.Y. 10703 914-423-0688

## Computer Equipment — For Sale

Disc file and controller, 113 million chara, 7.3 million bits, 1200 KC transfer rate, 12 extra discs. Two DDP 516 computers, 12K, 8 interrupt lines, ASR teletype, 48LS logic, 2HS logic, other features. Box 9-1

## FOR SALE

IBM 7094 I AND 4 K 1401  
13 TAPE DRIVES (9 729 VI's; 4 729 V's)  
For full specifications and further information write: Assistant Director, Computer Center, Columbia University, New York, N.Y. 10027

For Sale  
**MAGNETIC DATA CELL STRIPS**  
For IBM 2321 Data Cell Drive  
10 Cells Available — \$400 Per Cell  
L.D.S. Church Computer Center  
70 East South Temple  
Salt Lake City, Utah 84111  
(801) 364-2511 Ext. 2622

TLW CORPORATION  
P. O. Box 29763, Atlanta 30329  
404/451-1895

We Buy—Sell—Lease IBM  
Unit Record & Computers  
Our Equipment Is Completely  
Reconditioned & Under M/A

## SERVICES

**ENVIRONMENTAL IMPLEMENTATION**  
**UNINTERRUPTIBLE POWER SUPPLIES**  
Lighting Air Conditioning Raised Floors  
Complete Installations for all DP Centers  
**AMPELECTRIC COMPANY**  
17 Amherst Road, Hicksville, N. Y. 11801  
516-931-7035

## OPTICAL SCANNING

Each month we convert over 1 million records to magnetic tape by typing and scanning. We format your finished tapes per your requirements. High quality work. Write or phone Ken Benson, Input Services, 111 E. 4th Street, Dayton, Ohio 45402 (513) 222-2721.

## HELP WANTED NON-PROFIT INSTITUTIONS

Instructor of Data Processing position open at Weber State College, Ogden, Utah. Masters Degree and experience in programming and systems work desired. 360 installation using COBOL, BAL, FORTRAN. Salary commensurate with experience and education. Contact L. A. Nicholas, Department of Data Processing, Weber State College, Ogden, Utah 84403.

## COMPUTER CENTER DIRECTOR

Position open immediately for a person to establish, and manage a new computer center. Salary range of \$15,000 to \$18,000 depending on experience and qualifications. Desirable candidate would have a minimum of Bachelor's Degree, Data Processing management and technical experience, previous employment as manager, director, or assistant director of large computer center. Send resume and credentials to:

President

Illinois Central College

P. O. Box 2400

East Peoria, Illinois 61611

## DATAMATION

### Classified Advertising

The classified section is open for the following advertising categories: Used equipment; positions wanted; help wanted; educational institutions; maintenance services; professional cards; hobby products; business opportunities and educational courses. Rates are based on total number of insertions used within each contract year.

For further information please contact: DATAMATION Magazine, Classified Advertising Dept., 35 Mason St., Greenwich, Conn. 06830 (203) 661-5400.

## REAL TIME PROGRAMMERS

TRW has opportunities for Real Time Programmers who are interested in a multitude of digital systems applications. Positions require MS in EE, Math or Physics, or BS with 2 years experience with real time systems.

Problems will encompass specification development, system definition, computer sizing, interface definition, programming, simulation development, customer liaison, test planning, programming validation, program evaluation, systems integration, flight test support, post test analysis, and planning for future systems.

We need professionals to work on LM Abort Guidance System, Minuteman, Apollo, Centaur, Atlas, Sentinell System Test Program, Redundant Sensors, Reentry Measurements Program Phase B and many other interesting projects.

Send resumé including salary history to:

MR. ALLAN COY  
Room 1901-I  
TRW Systems Group  
One Space Park  
Redondo Beach, California

# TRW®

An equal opportunity employer

# At Digital, we define half the job.

## You define the other half.

If this kind of responsibility interests you,  
then you interest us.

Professional opportunities exist for experienced Sales Engineers • Pre- and Post-Sale Software Support Specialists • Memory Design Engineers • Systems Design Engineers • Circuit Design Engineers • Systems Programmers • Marketing Engineers • Reply to Mr. P. T. Koch, Digital Equipment Corporation, 164 Main Street, Maynard, Mass. 01754. Digital is an equal opportunity employer.

# digital

# We have new openings for Sales and Systems Analysts in 156 cities

NCR's Century Series systems' success has created new positions from coast-to-coast. So wherever you live or wherever you'd like to live, we may have the Sales or Systems Analyst position for you.

**Sales:** Experienced EDP salesmen and trainees. We offer a twelve-month accelerated Sales Training Program. On-the-job training. Four intensive weeks of training at corporate headquarters. A balanced program of Sales Training, Retail Management, Systems Requirements of industry, hospitals, government, schools, contractors, route control, financial, commercial and competition. Upon completion of training we offer you

a guaranteed territory to profitably operate.

**Systems Analyst:** Customer representative. Two or more years experience in programming with related systems analyses in commercial applications involving medium-to-large scale magnetic tape and random access systems. After initial period of orientation, you'll handle selected accounts for installation of EDP equipment and sales support.

For consideration in any area of the country, send resume and salary requirement in complete confidence to one of the following division offices.

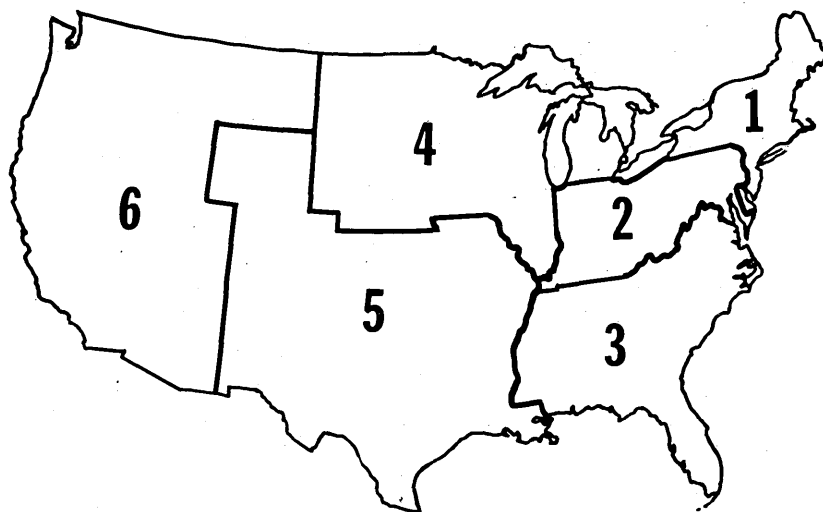

**1. NORTHEASTERN DIVISION**

Thomas L. Budd  
The National Cash Register Company  
619 Fulton Avenue  
Hempstead, L.I., N.Y. 11551

**2. CENTRAL DIVISION**

Robert A. Ackerman, Jr.  
The National Cash Register Company  
1324 South Patterson Boulevard  
Dayton, Ohio 45409

**3. SOUTHEASTERN DIVISION**

T. P. Hannan  
The National Cash Register Company  
3001 North Fulton Drive, N.E.  
Atlanta, Georgia 30305

**4. NORTHERN DIVISION**

Charles N. Jones  
The National Cash Register Company  
223 North Michigan Avenue  
Chicago, Illinois 60601

**5. SOUTHERN DIVISION**

Bill J. Beckworth  
The National Cash Register Company  
3300 West Mockingbird Lane  
Dallas, Texas 75235

**6. PACIFIC DIVISION**

James R. Moses  
The National Cash Register Company  
851 Burlway Road, Suite #700  
Burlingame, California 94010

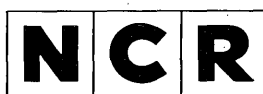

THE NATIONAL CASH REGISTER CO., DAYTON 45409

An equal opportunity employer

CIRCLE 315 ON READER CARD

about the direction  
of your career?  
Take heart.

Are you  
**multi-  
plexed**  
or just  
**per-  
plexed**

Our personnel specialists know WHERE the action is. They are the marketplace where your talents and the world's leading corporations meet.

The MANAGEMENT SCIENTIST consultant utilizes imaginative research, thorough analysis and depth evaluation techniques to put your objectives in realistic perspective. Most important, he works ACTIVELY on your behalf and no time is wasted in directing you to the most rewarding career opportunities.

At present we are recruiting for talented professionals in

- TIME SHARING/REAL-TIME
- SOFTWARE DEVELOPMENT
- OPERATIONS RESEARCH
- SYSTEMS DESIGN
- BUSINESS/SCIENTIFIC PROGRAMMING

Send us your resume, in confidence, including salary history and geographical preference. We will do the rest.

**Management  
Scientists, Inc.**

101 Park Avenue—Dept. 9-68  
New York, N. Y. 10017 (212) 532-7710

Exclusively: DATA PROCESSING & MANAGEMENT SCIENCES  
Career Planners—Recruitment Specialists

CIRCLE 317 ON READER CARD

Realize your Professional  
Potential

Pomeroy Associates  
can guide you to  
the future TODAY!

Through us, many challenging positions in the  
\$10,000 to \$30,000 range are available.

If your professional specialty is:

<i>Engineering</i>	<i>Programming</i>	<i>Marketing</i>
Digital Design	Software Design	Sales
Memories	Business	Systems
Power Supplies	Scientific	Architecture
Circuits	Information	Reliability
Logic	systems	Manufacturing
Systems	Operations	Consulting
Communications	research	
Design		
Automation		

Forward your resume in confidence to:

**POMEROY ASSOCIATES**  
Professional Search Consultants  
21 N. York Road, Suite 202  
Willow Grove, Pa. 19090  
All fees paid by client companies

CIRCLE 318 ON READER CARD

It's free. The new 1968 Edition.

## Our National Computer Salary Survey and Opportunities Analysis.

This is it. The all-new 1968 edition of Source Edp's FREE 20-page Computer Salary Survey and Opportunities Analysis. It's a summary of computer salaries by 24 separate levels of professional and managerial experience ranging up to \$75,000. Plus a comprehensive analysis of current trends in computer employment.

All of this information has been compiled, analyzed and put together by some of the most knowledgeable people in the business. The people at Source Edp. Source Edp is the only placement firm staffed by computer professionals for computer professionals. It's their business to know the data processing field.

To get your free copy of the 1968 Edition of Source Edp's Computer Salary Survey and Opportunities Analysis just circle the reader inquiry card. To speed delivery write directly to:

source  edp

Where computer professionals place computer professionals

Chicago—David D. Grimes, 100 S. Wacker Drive (312) 782-0857  
Detroit—Charles T. Walther, 2990 West Grand Blvd. (313) 871-5210  
Los Angeles—Robert A. Davis, 3470 Wilshire Blvd. (213) 386-5500  
Minneapolis—Fred N. Anderson, 801 Nicollet Mall (612) 332-8735  
New York—Edward T. Golden, 1414 Ave. of the Americas (212) 752-8260  
San Francisco—Richard M. Clark, 111 Pine Street (415) 434-2410

Client companies assume our charges.

CIRCLE 316 ON READER CARD

engineers - analysts - programmers

# GROW

IN THESE NATIONAL POSITIONS FROM 7,000 TO \$25,000

■ CIRCUIT DESIGN ■ DIGITAL OR LOGIC DESIGN SWITCHING ■  
COMMUNICATIONS ■ MANUFACTURING ■ RELIABILITY ■ SOFTWARE  
DEVELOPMENT ■ SCIENTIFIC PROGRAMMING ■ REAL TIME SYS-  
TEMS ■ BUSINESS SYSTEMS ■ COMMERCIAL PROGRAMMING ■ OPS  
RESEARCH

NATIONAL CHOICE: NEW ENGLAND ■ NEW YORK ■ PHILADELPHIA ■ WASHINGTON  
MIDWEST ■ SOUTH ■ CALIFORNIA ■ TEXAS ■ FLORIDA ■ AND OTHER AREAS

**FREE: CAREER OPPORTUNITIES BULLETIN**

For a complete listing of outstanding positions with National Companies circle subscriber service card using home address only.

Free custom service. All expenses paid by client companies (fees, interviewing & relocation.) Send resume in confidence with present salary and geographic preference. No obligation.



**La Salle Associates**



PROFESSIONAL SEARCH DEPT., 2136 LOCUST STREET, PHILA., PA. 19103

CIRCLE 319 ON READER CARD

**DATAMATION**

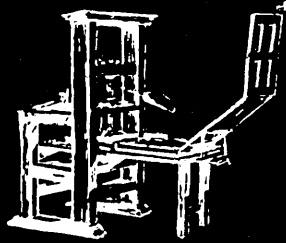

## Like Johann Gutenberg

After Gutenberg invented the movable type printing press, the world was never the same. His invention gave man the ability to inexpensively mass produce written information.

Producing information is no longer the problem. Rapid, effective use of information has replaced it and that's just what we of the Honeywell EDP Technology Center are working on. We're improving the speed, reliability and accuracy of present and future generations of Honeywell computer systems. And we're looking for help. If you have the mind of a Gutenberg — the ability to define problems and develop revolutionary solutions — you've a future at the Honeywell Technology Center.

### SENIOR ELECTRO-MECHANICAL PROJECT ENGINEER

An opening exists in the computer peripheral area for a senior project engineer with a strong background in the design of electro-mechanical equipment. The applicant must have demonstrated project responsibility for the development phase of a program with emphasis on electronics and/or logic design. MSEE or MSME preferred with 6-10 years of related experience.

### DEVELOPMENT ENGINEERS (Electrical)

Openings exist for intermediate to senior electrical engineers to advance a future development program in small peripherals. The work requires the ability to conceive new and simplified design concepts and carry them through to the design of feasibility models. A BSEE and a minimum of 3 years' experience is required, preferably in any or all of the following areas: servo systems, position transducers, actuators, logic, solid state and integrated circuits.

### LOGIC DESIGN ENGINEERS

To perform central processor design and/or I/O interfacing. Prior background should include 1-3 years' experience with a BSEE or the equivalent in experience.

### MECHANICAL ENGINEERS

We are seeking Mechanical Engineers to investigate developments of high performance tape drives. Responsibilities will involve component design, automated operation and structural design of new tape drive units. Prior experience should involve approximately 5 years minimum in the design and development of Data Processing Equipment. BSME or equivalent.

### ELECTRONIC ENGINEERS — Tape Drive

To be involved with high density magnetic recording techniques, read-write circuit design, low inertia motors and their associated controls. Objective will be the continuing development and improvement of high performance tape drives. EE with 3 or more years' experience in peripheral equipment design.

### ELECTRONIC ENGINEERS — Mass Memory

Intermediate and senior openings exist for engineers to work in advanced development of mass storage devices including magnetic drums and discs. Openings exist in all areas of mass memory storage development including magnetic recording techniques, read-write circuit design, electro-mechanical servo systems, magnetic head design, packaging and tests. Requirements are 2-5 years' experience in magnetic recording devices or related areas with BS in EE or physics.

### SYSTEMS ENGINEER — Remote Terminal Communications

This is an opening for a senior level communications systems designer who is familiar with remote terminal devices and their operating characteristics; is familiar with the problems of traffic control of data at the remote site and familiar with the details of communications link control procedures. Experience in any or all of the following types of systems would be desirable — Batch Transmission, Transaction Systems, Inquiry/Response Systems. Background should include some hardware (logic design preferred) or software. BSEE or MSEE.

### SYSTEMS ANALYSIS

Responsibilities will involve evaluating and measuring the performance of planned and existing hardware/software system structures using hardware monitoring, simulation and analytic techniques. General experience should include at least 4 years' experience in hardware and/or software systems design. More specific experience should be in one or more of the following areas: application of advanced statistical techniques in systems analysis — particularly queuing and sampling theory; experience in simulating data processing system structures; key responsibility for logic design of general purpose data processing systems.

### CIRCUIT DESIGN — Memory Development

Engineers with 1-3 years' circuit design experience will find a great interest in our memory development and design group. Prior experience in memory drive and sense circuitry would be preferable, but other circuit background is completely acceptable. Please forward your resume to Mr. Jack Wermuth, 200 Smith Street, Dept. D-9, Walltham, Massachusetts 02154. Opportunities exist in other Honeywell Divisions. Send resumes to F. E. Laing, Honeywell, Minneapolis, Minnesota 55408. An Equal Opportunity Employer.

The Other Computer Company:

# Honeywell

# computers are people

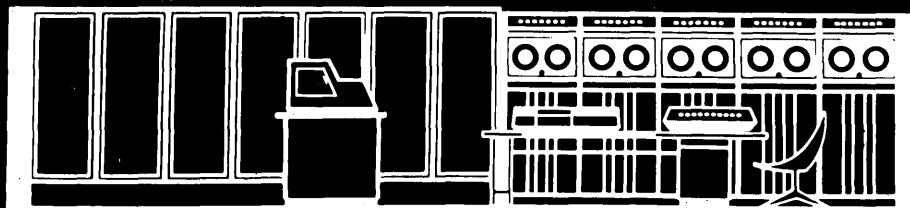

# Pick your spot at McDonnell Douglas:

## East, Midwest, or West.

We have immediate openings for data processing professionals in St. Louis, Southern California, New York, and Washington, D.C. Just indicate your location preference on the coupon, and we'll do the rest.

We're looking for systems analysts, programmers, math modelers, information system specialists, computing engineers, engineering and business consultants, accountants, sales engineers, computer-oriented marketing representatives, and other experienced data professionals.

You'll find what you're looking for at McDonnell Douglas: R & D programs; real-time, on-line systems; business, scientific and software programming; and management information systems — to name just a few activities.

You'll find opportunities in commercial data service at our McDonnell Automation Company Datadromes and in engineering, scientific and business computing and data processing at Douglas Aircraft Company, and in our Information Systems Subdivision.

To arrange an interview, mail the coupon today; please attach your current resume, if available.

Mail to: Mr. W. R. Wardle, Professional Employment, Box 14308, St. Louis, Mo., 63178  
or: Mr. M. V. Kilgore, Professional Employment, 3000 Ocean Park Blvd., Santa Monica, Calif. 90406

Name \_\_\_\_\_

Home address \_\_\_\_\_

City & State \_\_\_\_\_ Zip Code \_\_\_\_\_ Phone \_\_\_\_\_

Education: BS \_\_\_\_\_ MS \_\_\_\_\_ PhD \_\_\_\_\_ Major Field \_\_\_\_\_  
(date) (date) (date)

Primary experience area \_\_\_\_\_

Present position \_\_\_\_\_

Area choice: East  Midwest  West  Best Opportunity

**MCDONNELL DOUGLAS** 

An equal opportunity employer D/9

CIRCLE 322 ON READER CARD

# EDP NY YOU & DREW

... that's the 4-part program that spells success in data processing. New York offers rapid advancement because there's a critical shortage of Programmer Analysts here with salaries from \$8,000 to \$20,000. YOUR skills are needed and wanted.

DREW, the largest EDP personnel placement organization in the city, is in constant touch with more than 300 nationally known corporations who have hundreds of job openings NOW. Here's how we tell you about them: When your resume is on file with us we call you wherever you are in the U.S. and give you full information on jobs suited to your abilities and background. Opportunity doesn't knock—it rings!



Scores of major companies look to Drew to provide EDP personnel in the areas of applications programming, systems programming, systems design, software systems and management information systems.

### TO START DREW WORKING FOR YOU

Simply send us your resume. We'll take it from there—start immediately to match your skills with job openings on file and coming in every day, call you on the phone to discuss salaries offered, responsibilities—and everything you need to know to grow in EDP. Drew will arrange for a client company to fly you to New York for a personal interview at no cost to you. Everything will be handled in confidence, of course. Let's get started—send your resume today.



## DREW

Personnel Placement Center  
160 Broadway, New York, New York 10038  
(212) 964-8150

CIRCLE 321 ON READER CARD

# • national • international opportunities



## HAWAII

A rare opportunity to relocate to our most beautiful state. Prefer individuals with experience in one of the following: 360; COBOL; JOVIAL, COMMAND/CONTROL. This large international firm will pay excellent salaries, relocation costs plus benefits, and a 17% cost of living differential.

## EUROPE

A large international firm is seeking senior technical individuals (\$18-\$30,000) in the following categories: 1. London—on-line banking systems; 2. Paris—real time communications or reservations; 3. Switzerland—real time banking systems; 4. Algeria—petroleum systems; 5. Madrid—banking systems. A marketing personality and communications in the native tongue would be helpful but not necessary.

## SAIGON

A rare chance for high earnings and tax-free benefits is offered by this international organization. High salaries, excellent per diem, plus 75% cost of living and additional overtime; this is a two year assignment, and is tax-free. Experience on IBM 360/40/50/65, or COBOL or COMMAND SYSTEMS will qualify. Your choice of stateside assignment after your tour is complete. Many programmers can have \$60-80,000 saved by the time they return.

## MANAGEMENT

Over 30 of the nation's leading computer manufacturers, users and consultants are currently seeking managers in a diversity of applications. Salaries range from \$18,000 to \$75,000, from project leaders to vice presidents; many also offer liberal stock options and executive benefit plans.

## TIME SHARING

A large chain of data centers is currently being established in 30 major cities. Prefer programmers with non-scientific applications who desire to be trained on time-sharing applications. All management is staffed internally; rapid professional and financial advancement is virtually assured.

## INFORMATION SYSTEMS

A large computer-oriented company with an international network of data centers is seeking computer personnel: junior programmers, senior programmers, systems analyst, designers, and managers to staff their rapidly growing systems. Opportunities exist in 17 states and 8 foreign countries. Salaries range from \$8,400 to \$24,000. This is a chance to participate in total systems design and implementation from the ground up. Outstanding benefits.

## BUSINESS

Several programmers and analysts who have experience in manufacturing industries are needed to staff a new and rapidly growing multi-computer complex. Areas such as accounting, inventory/production control, and general manufacturing applications would be helpful. This progressive firm pays excellent salaries and gives their professionals 4½ weeks vacation and liberal bonuses, plus a fully company-paid benefit package.

## SCIENTIFIC

Should have a degree in Math, Physics or Engineering, and a knowledge of FORTRAN. Apply your academic background to all facets of the latest state-of-the-art advances. This is a large, non-profit organization paying outstanding salaries, 4 weeks vacation, and extended academic leave in a stimulating university-affiliated environment.

Never a cost or obligation to you at any time, as we are a professional recruiting firm sponsored by the computer industry. All replies held in strictest confidence.

# free:

Hot off the press! Our brand new Summer 1968 Professional Advancement Brochure—40 pages packed with detailed job descriptions representing over 4,000 computer opportunities in all 50 states and 35 foreign countries and the latest wage and salary surveys for eight different categories of computer specialists.

## EAST COAST

1025 Connecticut Avenue, N.W.  
Washington, D.C. 20036  
(202)-296-0340

## WEST COAST

1212 Wilshire Boulevard  
Los Angeles, California  
(213)-481-7461



# COMPUTER PROFESSIONS, Inc.

# Systems Programmers and Systems Analysts: Give IBM a hand and we'll try to make it a free one.

If predictable thinking were what we wanted, we'd just program it. But what we're looking for are imagination and ingenuity. If you have these qualities, and you qualify for a job with IBM, you can be sure you'll get to use them.

## Immediate openings

We have immediate openings in these areas of data control:

**SYSTEMS PROGRAMMING**—You could work close to the system, very much into its own particular nuances and idiosyncrasies, and adapt programs to maximize the data processing potential of the computer. Or write entirely new programs to link the actual problem to its solution.

Or you could develop symbolic

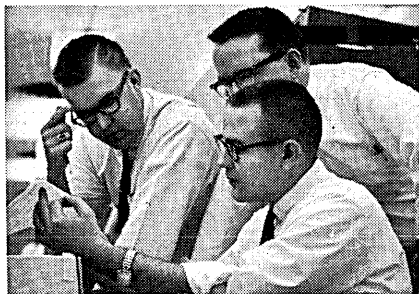

IBM programmers and systems analysts work in small teams on an IBM System/360 computer.

**An Equal Opportunity  
Employer**

languages for both commercial and scientific use, and concern yourself with computer performance, serviceability, systems analysis, component evaluation, and the development of diagnostic programs.

**SYSTEMS ANALYSIS**—Because you're close to the problem, its thorns and its kinks, your job is creating an overall data processing strategy that solves it. The problem itself could be just about anything: payroll, inventory control, process control, long-range financial forecasts—to name a few.

A Bachelor's degree and one year's experience are required for the above positions.

## Grow with IBM

Today's major growth industry is

information handling and control. And IBM is a leader in that field. As a result, the professional challenges at IBM are more demanding, more sophisticated than ever. Our job is to help our customers solve their information-handling problems. And IBM people are at work helping them solve a myriad of problems from diagnosing a strange disease to urban redevelopment.

So if you're a problem-solver who wants a personal sense of achievement and recognition for your hard work in an exciting growth company, consider IBM.

## Write us now

Jerry Hinkley is the man to talk to; write to him at IBM Corporation, Department BJ 1015, 24th Floor, 425 Park Avenue, New York, New York 10022.

**IBM®**

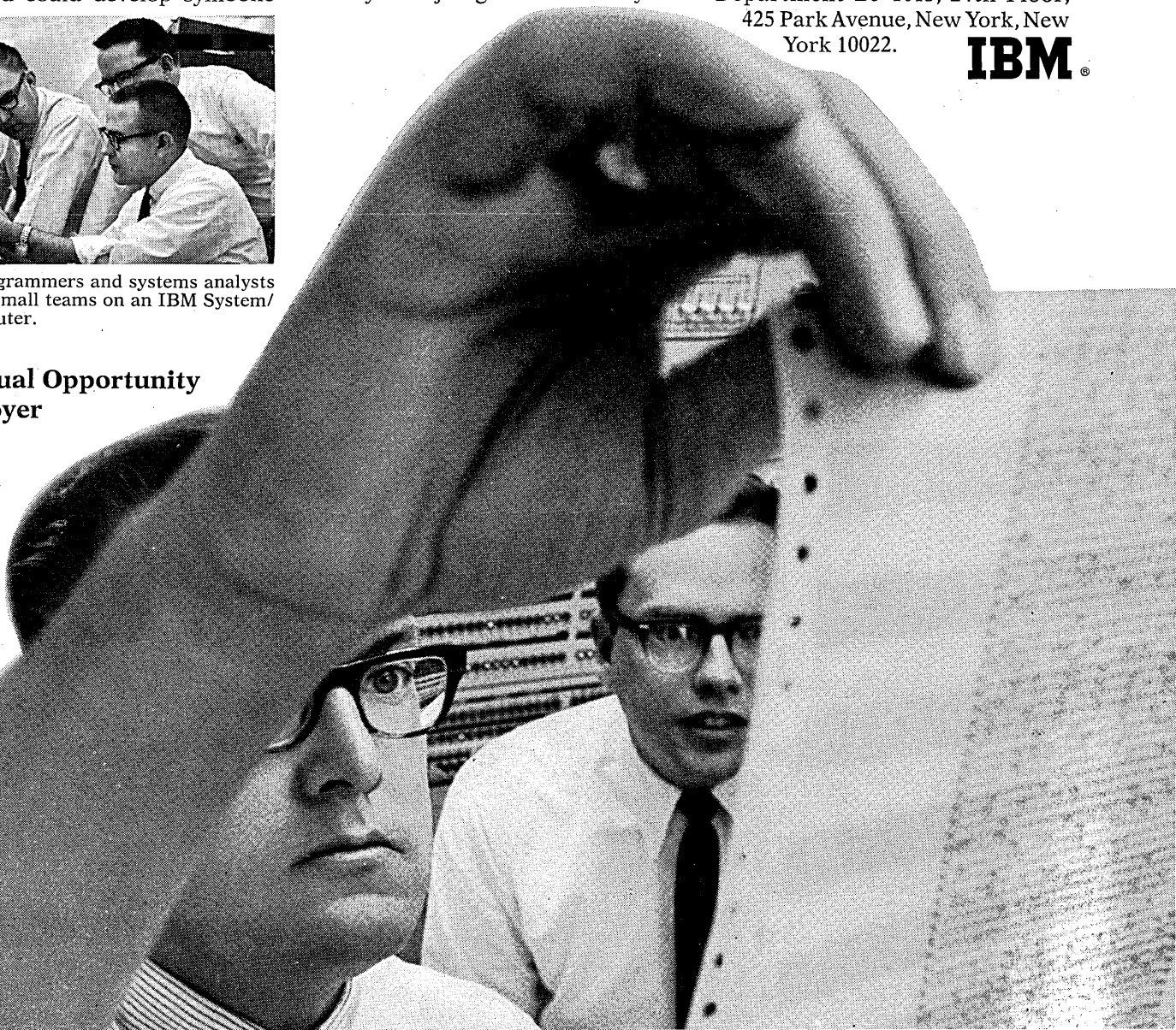





# advertisers' index

Adage, Inc. ....	8
The Aerospace Corporation .....	186
Albert Associates .....	147
Albert, Nellissen, Inc. ....	145
Alphanumeric Incorporated .....	4
American Can Company .....	86
American Technological Institute .....	170
Ampex Corp. ....	52, 53, 72
Aries Corporation .....	97
Audio Devices, Inc. ....	138
Automatic Information Management .....	150
Avco-Lycoming Charleston Plant .....	182
Beta Instrument Corp. ....	133
Blue Cross .....	179
Burroughs .....	16
Cadillac Associates, Inc. ....	181
Caelus Memories, Inc. ....	10
C-E-I-R Inc., The Professional Services Subsidiary Control Data Corporation .....	13, 136
The Computer Exchange Inc. ....	70
Computer Professions, Inc. ....	177
Computer Sciences Corporation .....	132, 184, 185
Computer Telephone Corporation, A Subsidiary of Photo Magnetic Systems, Inc. ....	127
Computron Inc. ....	48
Comress .....	76, 117
Consolidated Electrodynamics, A Subsidiary of Bell & Howell .....	148
Curtis 1000 Inc. ....	125
Data Communications Systems, Inc. ....	80
Data Management Services, Inc. ....	180
Data Packaging Corporation .....	116
Data Products Corporation .....	124
Data Products Sales Corporation, A Subsidiary of Data Products Corporation .....	106
DATAMATION Magazine .....	167
Digital Equipment Corporation .....	63, 65, 172
Drew Personnel Placement Center .....	176
Dunhill Personnel Agency, Inc. ....	179
Edutronics .....	114
Electronic Computer Programming Institute .....	152
Electronic Memories .....	146
EMR Computer, EMR Division of Weston Instruments, Inc. ....	108
Fabri-Tek .....	105
Ferroxcube .....	Cover 4
Fox-Morris Associates .....	182
General Automation, Inc. ....	137
General Electric .....	42, 43
Greyhound Computer Corporation .....	5
Robert Half Personnel Agencies .....	147

## SYSTEMS ANALYSTS AND PROGRAMMERS

### Increased data processing capabilities!

We need ambitious and creative programmers and data processing oriented systems analysts.

People who want to work in a dynamic growth environment.

People who want to be involved in:

- LARGE-SCALE HONEYWELL H-2200  
THIRD GENERATION EQUIPMENT
- REALTIME CAPABILITIES
- TELECOMMUNICATIONS
- DISC STORAGE
- CRT's
- ADVANCED OPERATING SYSTEM-MOD 2

People who will take advantage of the advancement opportunities offered at Blue Cross.

2 years' minimum experience required for systems analyst positions. COBOL or H-2200 experience required for programmer and senior programmer positions.

## BLUE CROSS

4777 Sunset Blvd., Los Angeles, Calif.

An equal opportunity employer

CIRCLE 324 ON READER CARD

## EDP SPECIALISTS

We know the EDP field from your desk as well as ours. Your technical experience coupled with our counselors' backgrounds and personnel expertise enable us to give you an objective analysis of your position in today's data processing market. Programming, Systems and Marketing openings in commercial and scientific environments.

Our clients pay all fees. Send resume or telephone K. Bonner. Replies held in strictest confidence.

**Dunhill**  
PERSONNEL AGENCY, INC.

1 East 44th Street  
New York, N. Y. 10017  
212-986-0100

A National Computerized Personnel Service



CIRCLE 325 ON READER CARD



# INFORMATION PROCESSING

The right job helps to make a better way of life . . . especially in the data processing and accounting fields. Contact us for the right opportunities from \$8,000 to \$35,000, fee paid.

In further service to the information processing industry, our newest office is open at:

380 Boston Post Road  
Orange, Conn. 06477

6538 Collamer Road  
Syracuse, N. Y. 13206

200 Boylston Street  
Chestnut Hill, Mass. 02167

345 No. Main Street  
West Hartford, Conn. 06117

Garden City Concourse  
Cranston, R. I. 02920

94 Auburn Street  
Portland, Me. 04103



# ROMAC

AND ASSOCIATES  
PERSONNEL CONSULTANTS

CIRCLE 327 ON READER CARD

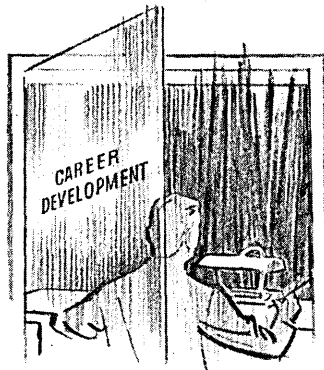

## what's a nice guy like E. B. Schultz doing in a place like this?

In his formative years, "E. B." had a four square job as Employment Manager for one of the biggest computer builders in the world. His name became synonymous with integrity, reliability, and mild-manneredness. Now he's VP in charge of "Career Development" at DMS, and some eyebrows have been raised. True, this is a euphemism for plain old head-hunting . . . but this is also the same old E. B. Schultz: low key, low pressure, dealing in low volume placement of strictly high type personnel. He's made for the job, because at DMS head-hunting is sort of a top-level sideline . . . a little something extra in the basic EDP package\* we provide for our company clients. So when E. B. has an opening, you can be sure it's something very special. If you're also very special as an applications or systems programmer, systems analyst, or salesman, E. B. Schultz can put you on to the rare kind of job nobody else ever hears about. Send a resume or pick up the phone. (215) KI 6-0901

\*Research and Planning, Educational Programs, Programming Services, Equipment Acquisition

**DATA MANAGEMENT SERVICES, INC.**

# DMS

CORPORATE OFFICES: 1515 LOCUST STREET, PHILADELPHIA, PENNSYLVANIA 19102  
NORTHEAST REGIONAL OFFICE: 31 LEWIS STREET, HARTFORD, CONNECTICUT 06103

CIRCLE 326 ON READER CARD

# SLAC

## MATHEMATICIANS

## SCIENTIFIC PROGRAMMER

30 miles south of San Francisco, the Stanford Linear Accelerator Center scientists are conducting basic research in high energy physics, using spark and hydrogen bubble chamber targets.

### Mathematicians

Will organize and administer large codes, peripheral systems, and interface with other programs.

### Programmer

Will link our analysis program to the new computer system.

You can contribute to our research and become involved in developing and optimizing new and existing data programs and systems. Degree required and minimum 1-2 years' experience, using IBM 360 and FORTRAN IV.

Operated by Stanford University, this international center offers the same progressive benefits enjoyed by all professional employees of the University.

Please send résumé to:  
G. F. Renner, P.O. Box 4349,  
Stanford, California 94305.

## STANFORD LINEAR ACCELERATOR CENTER

An Equal Opportunity  
Employer

CIRCLE 328 ON READER CARD

**DATAMATION**

## advertisers' index

Heffelfinger Associates, Inc. ....	182
Hewlett Packard .....	6
Honeywell .....	175
Honeywell, Computer Control Division .....	99
IBM Corporation .....	178
The Ideal Electric & Mfg. Co. ....	129
Informatics Inc. ....	51
Information International .....	143
Information Management Incorporated .....	57
Institute for Computer-Assisted Instruction .....	139
Everett Kelley Associates .....	181
Kleinschmidt Division of SCM Corporation .....	144
La Salle Associates .....	174
Leasco Systems and Research Corp. ....	162
Link Group, General Precision Systems Inc. ....	118
Litton Industries, Data Systems Division .....	171
Lockheed Electronics Company, A Division of Lockheed Aircraft Corporation .....	126, 158
Logicon .....	141
MAC .....	9, 101, 166
MAC Panel Company .....	Cover 3
Magnetic Shield Division, Perfection Mica Company .....	128
Management Scientists, Inc. ....	174
McDonnell Douglas Corporation .....	176
Memorex .....	94, 95
Methods Research Corp. ....	117
Micro Switch, A Division of Honeywell .....	91
Moore Business Forms Inc. ....	142
National Blank Book Company, Inc. ....	75
The National Cash Register Company .....	155, 173
National Lead Company, Floating Floors, Inc. ....	14
Optical Scanning Corporation .....	78
Peripheral Equipment Corporation .....	140
Planning Research Corporation .....	54
Pomeroy Associates .....	174
Postal Cheque and Clearing Service .....	93
Radio Corporation of America, Staff Employment .....	160, 161
Raytheon Computer .....	110, 111
RCA Information Systems .....	2, 3
RCA Magnetic Products Division .....	130, 131
RCA Service Company, A Division of Radio Corporation of America .....	102
Remex Electronics, A Unit of Ex-Cell-O Corporation .....	107
Rixon Electronics, Inc. ....	67
Ro-Mac & Associates .....	180
Roytype Division of Litton Industries .....	119
Scientific Control Corporation .....	122
Scientific Data Systems .....	20
Seiden & DeCuevas Incorporated .....	12
Sheridan Associates Inc. ....	162
Sikorsky Aircraft, Division of United Aircraft Corporation .....	159

## WHAT IS YOUR TRUE WORTH?

# FREE Data Processing Opportunities Bulletin

Every month, in the privacy of your own home, you can evaluate the nation's finest openings in the data processing field. Cadillac, the nation's largest executive and professional placement service, represents the majority of the nation's top companies. Their best jobs at salaries from \$6,000 to \$75,000 appear in our monthly Data Processing Opportunities Bulletin.

Our placements show that the average data processing man is worth 10% to 20% more than his present income. The Bulletin helps you evaluate yourself in today's market. Both the Bulletin and our *confidential* placement service are free. Client companies pay all costs.

For your free Bulletin, without any obligation circle Subscriber Service Card No. 309. Please use *home address only*.



LON D. BARTON, *President*  
**Cadillac Associates, Inc.\***

29 E. Madison Bldg. Chicago, Ill. 60602  
Financial 8-9400

\*"Where More Executives Find Their Positions Than Anywhere Else in the World."

CIRCLE 309 ON READER CARD

## CAREER MEMO

To PROGRAMMERS/ANALYSTS/ENGINEERS

From EVERETT KELLEY ASSOCIATES, INC.

If your present position lacks professional motivation . . . NOW is the time to let us program your professional future . . .

Consult our staff of experienced specialists who are at your disposal. They will open doors and arrange favorable interviews with selected clients. Utilize your total professional capability in:

- Scientific Programming
- Real Time Systems
- Software Development
- Operations Research
- Applied Systems
- Systems Design
- Consulting
- Digital or Logic Design
- Circuit Design
- Commercial Programming
- Mathematics
- Development Engineering
- Communications
- Sales/Marketing

Salary range: \$8,000-\$30,000. All expenses paid by client companies (fees, interviewing and relocation).

Submit your resume in strict confidence, including salary requirements and geographic preference, directly to Mr. R. L. Keilholtz or Mr. Donald Wayne or write for our composite resume form A.



**EVERETT KELLEY ASSOCIATES**

*Consultants to the Computer Industry*

121 So. Broad Street (Suite 1300)  
Philadelphia, Pa. 19107

Placement of Computer Professionals since Binac.



CIRCLE 329 ON READER CARD

## DATA PROCESSING PROFESSIONALS

HAVE YOU HEARD OF

# CASES

Let our 360 evaluate your qualifications against all orders in CASES (Computerized Applicant Search, Evaluation and Selection) for one year. Positions are located in all areas of the country.

Send us a resume along with your geographic restrictions and salary requirements and CASES will search for you.

If you don't have a resume send us your address and we will forward you a simplified INPUT form. No cost or obligation. All replies strictly confidential.

J. J. MC NICHOLS



**FOX-MORRIS ASSOCIATES**  
*Personnel Consultants*

1500 Chestnut Street Philadelphia, Penna. 19102

CIRCLE 332 ON READER CARD

## PLANT EXPANDING ... EMPLOYMENT DOUBLING

In just two years of operation, our employment has reached 2,000, and we need 2,000 more employees immediately.

### SYSTEMS ANALYSTS

Prefer Management Information Systems background.

### SENIOR PROGRAMMERS

3-5 years experience with some 360 DOS background.

**Generous fringe benefits. Vacation atmosphere throughout the year in Charleston, South Carolina.**

**Now is the time to get in on the ground floor in our giant expansion program.**

Contact Ed Blake

Avco Lycoming—Charleston Plant

P. O. Box 10048, Charleston, S.C.

Tel. (803) 554-1071



**LYCOMING-CHARLESTON PLANT**

An equal opportunity employer

CIRCLE 330 ON READER CARD

Thinking of exploring new career opportunities?

With a little bit of luck,  
some company name gathering,  
& a lot of resume sending,  
you *may* get a position  
that really interests you.

## Why not make sure...

If you are an imaginative programmer, analyst, or engineer interested in a stimulating career position in New England or the Northeastern U.S., forward your resume, with your objectives, directly to Heffelfinger Associates.

Heffelfinger Associates — specialist in computer technology placement — has valuable up-to-date knowledge on some of the most interesting positions available. Salaries range from \$10,000 to \$40,000.

Client companies assume fees.



**heffelfinger**  
**associates, inc.**

Computer Personnel Consultants

888 Washington St., Dedham, Mass.

CIRCLE 331 ON READER CARD

## advertisers' index

Source EDP .....	174
Sperry Rand Corp., Univac Division .....	88
Standard Computer Corporation .....	134, 135
Stanford Linear Accelerator Center .....	180
Stromberg Datagraphics, Inc., A Subsidiary of General Dynamics .....	96
Systemat .....	162
Systemation Consultants, Inc. ....	162
Tab Products Co. ....	149
Talcott Computer Leasing, A Division of James Talcott, Inc. ....	109
Tally Corporation .....	1
Teletype Corporation .....	60, 61
Thompson Book Company .....	154
3M Company .....	68, 69, 120, 121
TRW Systems Group .....	172
URS Corporation .....	164
Varian Data Machines, A Varian Subsidiary .....	Cover 2, 123
Wang Laboratories, Inc. ....	18
The Washington Aluminum Co., Inc. ....	15
Wright Line, A Division of Barry Wright Corporation .....	83, 84
Xerox Corporation .....	156

**DATAMATION**

# the forum

The Forum is offered for readers who want to express their opinion on any aspect of information processing. Your contributions are invited.

## CERTIFICATION AND ACCREDITATION

In recent articles in *Datamation* (April and May, 1968), Edward Markham indicated the problem of the proliferation of substandard edp schools. This problem is merely part of the larger problem of certification of professionals and accreditation of institutions in information science. The solution to the larger problem may prove distasteful to those who are in a position to implement the solution. Lack of a solution from within the science will result in a solution imposed from without.

In several fields, lack of professional and industrial standards has prompted the government to establish standards. This is true in such sectors as automotive safety, programming languages (COBOL), and investment banking (through the SEC). A government-imposed standard for accrediting edp schools is indeed possible. If a state can set standards for certifying attorneys, a state, or the federal government, can impose standards for certifying computer consultants. As there is still much debate within the field of information science as to its scope, what it is that makes its practitioners professionals, and whether it is even a science, the desirability of imposing legal standards of certification and accreditation is doubtful.

How then can certification be done? With a broad base of membership, a society of professionals would be able to set and enforce standards of certification for those who claim to be in that profession and of accreditation for schools who claim to educate those professionals. A broad base would give such a society the power to persuade in-

dustry to give proper regard to the society's standards when hiring personnel and retaining consultants. Also, a broad base would give the society a universalist view of the profession. For example, language design would not be slighted in favor of business system design; certifying technicians would receive as much attention as certifying independent consultants.



The nucleus of a broad-based society exists now: the American Federation of Information Processing Societies. Through its constituent societies, AFIPS includes the members of those societies as individuals. The societies are the Association for Computing Machinery

(ACM), Institute of Electrical and Electronic Engineers (IEEE), Simulation Councils, American Documentation Institute, and Special Libraries Association; there is non-voting representation from the Association for Machine Translation and Computational Linguistics (AMTCL). However, AFIPS does not include the Data Processing Management Association (DPMA) or any organization of technicians (e.g., operators, maintenance engineers); this lack prevents AFIPS from having the necessary broad base. Further, the organization of AFIPS does not lend itself to certification activities. AFIPS is designed to present semi-annual conventions (the joint computer conference, SJCC and FJCC). As a result, it is an organization of societies—not of people.

To enter into the activity of certification, AFIPS should expand its scope. The DPMA should be invited to join; the AMTCL should be made a full member, and a Guild of Computer Technicians should be fostered. Then AFIPS should be modified to be an organization of people; a member of a constituent society would also be a member of AFIPS (compare the case of a citizen of Illinois who is also a citizen of the United States). The scope of AFIPS could then be expanded to encompass certification and accreditation. The operations of AFIPS could be funneled by a per-capita assessment levied against the constituent societies. Dual memberships (e. g., one person belonging to both the ACM and IEEE) could be eliminated by offering associate memberships in a society at a low cost to members of the other societies; no per-capita assessment would be paid to AFIPS for such associate memberships. If each society were to establish professional certification programs with high standards, AFIPS could then set general, basic standards without invading the autonomy of the societies. If high standards were required for becoming a member of a society (as in the American Medical Association or American Institute of Architects), membership and certification would be equivalent. Each society in AFIPS should recognize the standards of the other societies. Most schools, however, cover such a broad area (or try to) that no one society should provide for accreditation; this activity rightly belongs to AFIPS.

Enforcement of certification programs could extend to blacklisting



**CSC is looking for somebody.**  
But not just anybody.



The challenge is at the interface of the information sciences. Where it happens. Where CSC is. If you need to be where it happens. If you're something special in the way of a Systems Programmer or Command & Control Programmer or Systems Analyst. If you want to meet the challenge in the U.S. or Canada or Europe or the Pacific area. Then call Don Schenkél: (213) 678-0592. Or write him at Computer Sciences Division, 650 North Sepulveda Blvd., El Segundo, California 90245. An equal opportunity employer **Computer Sciences Corporation**

CIRCLE 333 ON READER CARD

## the forum

those firms who retain non-certified consultants and employ graduates of non-accredited institutions, but this is an extreme action which can be avoided. Instead, high standards of certification would guarantee to industry highly competent personnel. Industry has long decried the lack of quality among computer technicians and been confounded by the question of professional standing of the multitude of consultants; industry should gladly accept compliance with a certification program. Permitting certification of individuals who choose not to join an AFIPS society will allay fear of restrictive technical unions that afflicts many firms; it will also answer objections of those who claim that organizing a union is not a professional action. By allowing non-members to be certified, civil service systems in local, state, and federal governments may be encouraged to recognize the certification program; the program would also permit the government to judge more accurately which consultants are qual-

ified to bid on government contracts. A school accreditation program established by the expanded and reorganized AFIPS might provide a basis on which states and local governments could move against the edp diploma mills and the federal government could move against fraudulent advertising in the mails by such schools. It could also serve to rate the quality of degree programs in computer sciences offered by various universities and colleges.

Opposition to certification programs through an expanded AFIPS is to be expected from the constituent societies. The ACM especially seems to be a strong source of potential opposition. Although ACM claims to be a professional society, it performs few of the functions of such. It has no standards of professionalism. Its standards of membership merely require that an applicant have a bachelor's degree (in any major) and be friendly with two members who will sign his application. Its standards of conduct (CACM; 10 (2); February, 1967, p. 129) provide for no enforcement; an ACM member who is requested by a client or employer to act in violation of the standards has no

recourse to the ACM. In general, the IEEE has the same failings as the ACM, except for possibly tighter membership requirements. Some members prefer this form of organization: they can claim the status of belonging to a professional society while, behind the facade, they are free of the restraint of professional standards.

Other opposition to an AFIPS certification program will revolve around the need for a representative organization of technicians (a Guild of Computer Technicians). Operators are not professionals; why should they participate in the functions of AFIPS, a federation of professional societies? They should participate in order to justify the role of AFIPS in establishing a program for accrediting technical schools. Computer and information processing professionals have an overriding interest in insuring that the technicians with whom they work exhibit a high level of competence and follow some standards of technical ethics analogous to a professional code of ethics. However, the professionals cannot impose certification on technicians and their sources of technical skills. Through an expanded AFIPS, which includes the DPMA and a Guild of Computer Technicians, each group would be able to set its own standards. AFIPS would, as a whole, provide accreditation of schools, set general interdisciplinary standards, and enforce reciprocity between the societies with respect to recognition of each others' certification. Further, AFIPS would then be in a position to promote compliance with the certification programs by industry.

A solution to the problem of accreditation of edp schools is included in the solution of the more general problem of certification of professionals. AFIPS, with a reorganization, could become the agency to solve this problem—but only if its constituent societies take stronger positions with respect to enactment and enforcement of standards of professionalism. Beyond certification, AFIPS could become a more meaningful organization by coordinating the operations of its constituent societies. Reciprocal agreements to provide membership benefits of one society at a nominal cost to members of other societies could be implemented. Publication activities could be shared. Redundant conferences could be eliminated. Much duplicated effort would cease.

—DAVID E. ROSS

## The Aerospace Corporation needs programmer/analysts

We have completed our conversion to IBM system/360. Now we need senior Business Systems Programmer/Analysts to develop on-line direct-access administrative information systems.

We offer career positions to individuals with two to six years of computer experience. You'll be involved in advanced computer concepts such as our IBM 360 material-control teleprocessing system which utilizes peripheral CRT display.

We prefer college graduates but will carefully consider all experienced applicants.

The Aerospace Corporation, in El Segundo, California, performs systems engineering and provides technical direction for the U.S. Government on military space and missile programs.

To apply for these senior-level positions, please send your resume to:



A. J. Wilkey  
P.O. Box 95085  
Los Angeles, California 90045

The Aerospace Corporation - An Equal Opportunity Employer

CIRCLE 334 ON READER CARD



# ALL THREE ERROR-FREE OFF-THE-SHELF!

# MAC PACK

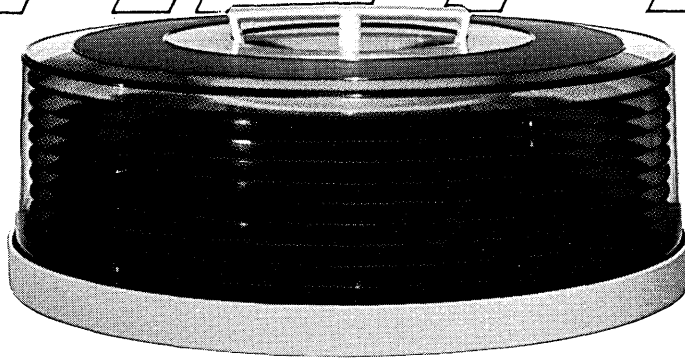

## 1. Type 2316 ERROR-FREE

MAC was the first independent to deliver the "high stack" ... over one thousand installed ... immediate delivery!

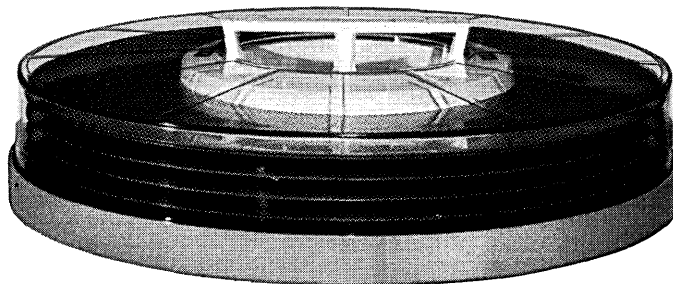

## 2. Type 1316 ERROR-FREE

MAC was the first independent to deliver the basic disk pack ... thousands installed ... immediate delivery!

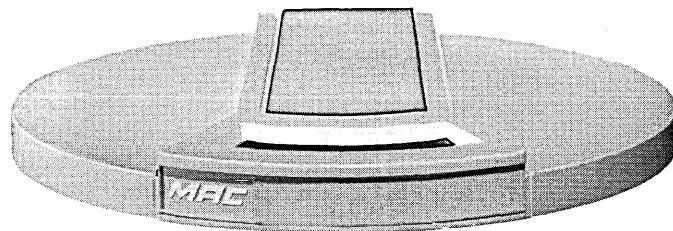

## 3. Type 2315 ERROR-FREE

MAC is the only independent to offer the disk cartridge ... hundreds installed ... immediate delivery!

Each MAC PACK is guaranteed to meet or exceed specifications and performance standards of all other disk packs. The MAC guarantee against defects in materials or workmanship extends for an unlimited time.

MAC high density disk oxides and precision spin coating techniques are the results of years of intensive research and development. This advanced technology makes MAC the leader in the production of magnetic memory products ... it is the reason MAC offers error-free disk packs unequalled by the rest of the industry.

Purchase and lease plans available. See your MAC representative or write MAC Panel Co., Box 5027, High Point, N. C. 27262.

CIRCLE 2 ON READER CARD

# Want a fast 2½ D stack? We'll jet it to you in just 8 weeks

(Our secret lies in the "take-off")

At Ferroxcube, we "take-off" from standard designs and deliver 2½D stacks in as little as eight weeks. Now, that's pretty unusual in itself...but in addition we've manufactured more 2½D stacks than just about anyone you could name in our industry. And that's significant. Couple this with the fact that our 2½D stacks offer full-cycle times that are practically unbeatable as far as the state of the art goes, and you begin to get a picture of

Ferroxcube memory stack capability. Actually, we can also give you other 2½D, 3D, mil and commercial off the shelf designs in the same short time—or even faster in some cases.

And you can't beat the Ferroxcube experts for quality. We control every vital stage of manufacture from the formulation of the powder for the cores to the planes and stacks that go out the door.

We're ready now with our 700 series

2½D units, in a variety of 20 mil core versions. Sizes to 16K x 37 currently available. And don't forget in addition to our fast "take-off" the speed on this stack is 700 nanosecond full cycle time.

Contact your friendly Ferroxcube experts for advice and service. We've logged more hours on 2½D than anyone in the industry.

**Ferroxcube** 

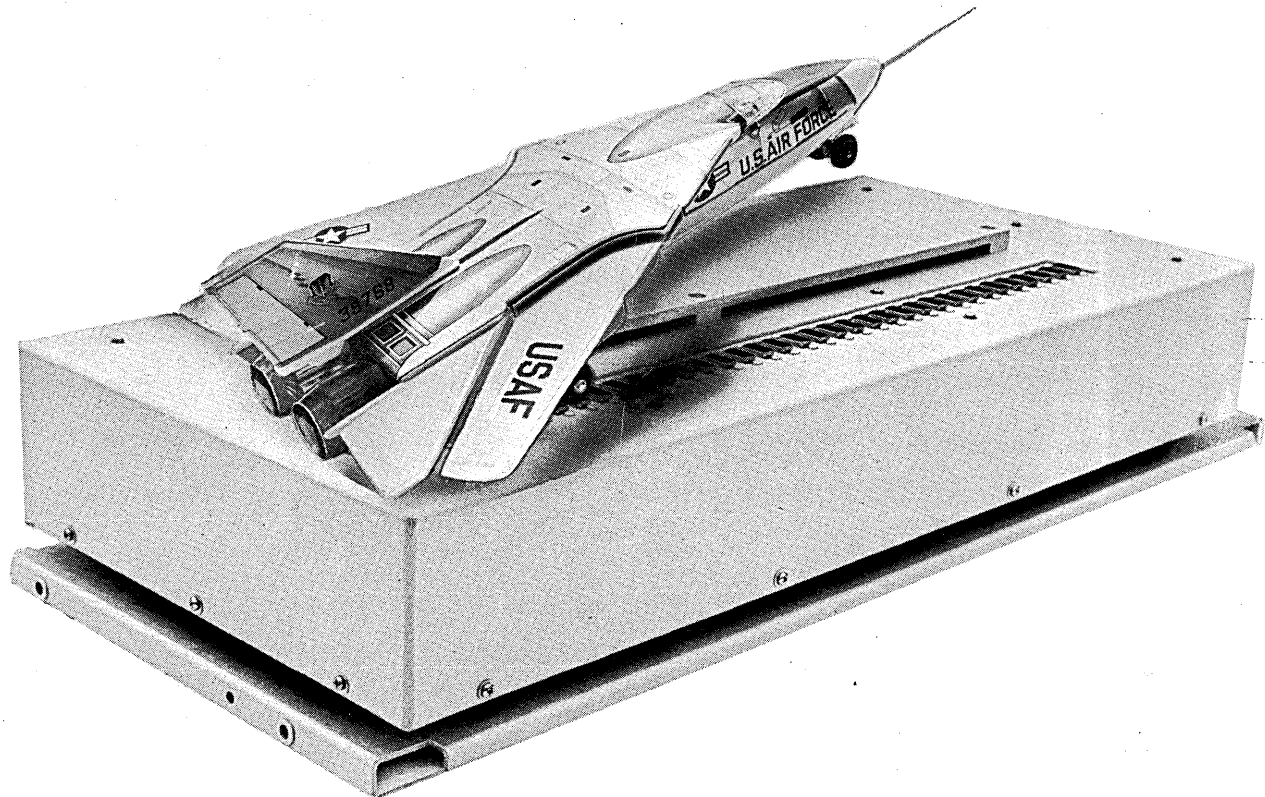

Albuquerque—Electronic Enterprises, (505) 256-1585; Baltimore—Eastern Components, (301) 322-1412; Burbank, Calif.—(213) 849-6631; Englewood, Col.—(303) 771-2000; Houston—Noakes Engineering, (713) 529-6213; Irving, Texas—Noakes Engineering, (214) 255-0441; Lansing, Mich.—(517) 482-7140; Minneapolis—(612) 920-7955; Northlake, Ill.—(312) 261-7880; Philadelphia—Eastern Components, (215) 927-6262; Phoenix—(602) 264-3120; San Francisco—Wm. J. Purdy Agents, (415) 863-3300; Saugerties, N.Y.—(914) 246-2811; Union, N.J.—(201) 964-1844; Waltham, Mass.—(617) 899-3110; Winston Salem, N.C.—(919) 725-6306; Toronto, Ontario—Philips Electron Devices, Ltd., (416) 425-5161.