

Computer Systems Dept  
R.C.I.  
21 Crutcher Rd  
11-16

*Handwritten signature*

# PROBLEM

Form inner product of two vectors U and V:

$$IP = \sum_{i=1}^n u_i v_i$$

step (i);

# BALGOL

IP=0; FOR I=(1, 1,N);  
IP=IP + U(I). V(I);

IP=0.  
DO 21 I  
21 IP=IP +

# FORTH

# PROBLEM

Form inner product of two vectors U and V:

$$IP = \sum_{i=1}^n u_i v_i$$

IP=0  
THROUGH  
IP=IP + U

# ALGOL

IP = 0; for i = 1 step 1 until n do  
IP = IP + u(i) × v(i) ;

# FORTRAN

IP=0.  
DO 21 I=1, 1, N  
21 IP=IP + U(I)\*V(I)

IP = 0; for i = 1  
IP = IP + u(i) × v

# GOL

IP = 0; for i = 1 step 1 until n  
IP = IP + u(i) × v(i) ;

THROUGH BETA, FOR I=1  
) \* V(I)

# MAD

IP=0  
THROUGH BETA, FOR I=1, 1, I.G. N  
BETA IP=IP + U(I)\*V(I)

# RTRAN

IP=0.  
DO 21 I=1, 1  
21 IP=IP + U(I)

IP=0; FOR I=(1, 1,N);  
IP=IP + U(I). V(I);

**EVERY-  
BODY  
TALKS  
ABOUT  
1.5  
MICRO-  
SECOND  
CORE  
MEMORIES**

# **AMPEX SHIPS THEM**

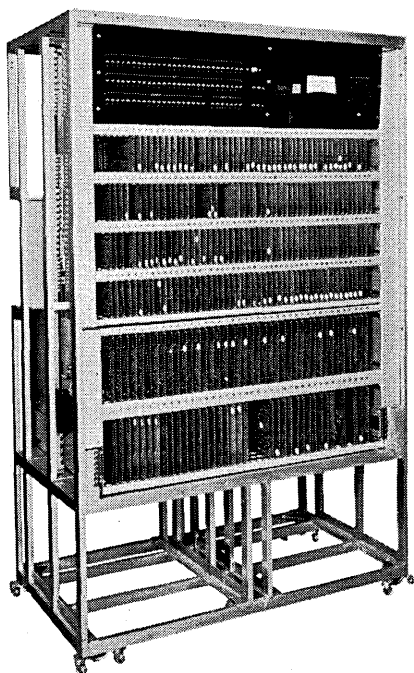

**Truth is stranger than fiction. And here's the honest truth about the world's fastest, commercially available, random access core memory.**

Ampex is delivering production line models of the new LQ ferri-te core memory. The LQ executes a complete memory cycle in 1.5 microseconds. (Access time  $1.0\mu$  sec.) Capacity of standard models is 8192 or 4096 words up to 56 bits in length.

Bear in mind that the LQ is no hand-built mock-up, locked away in an R&D lab. Production line units, specifically designed, tested, rated and priced for commercial computer applications, are running, on line, in existing computer systems.

Right now Ampex is quoting deliveries of the LQ. Better write today for complete specifications and descriptive literature: Ampex Computer Products Co., P. O. Box 329, Culver City, Calif.



# IF

- *you're weary of matching one assembler instruction per one machine language instruction*
- *you're spending half of your machine time translating compiler programs into machine language programs of questionable efficiency*
- *you're using up time and money with hunt-and-peck machine language debugging and reprogramming*
- *you're tired of seeking, teaching or even becoming a bilingual programmer—fluent in both problem and machine languages*
- *you're fed up with programming methods that are cumbersome, time-consuming and costly*

---

Then, you'll be interested in Burroughs B 5000, a new kind of information processing system which is the result of a total departure from traditional computer design concepts. A system in which *software* dictates equipment designs and specifications to bridge the communication gap between man and machine

As a problem oriented system, its software capa-

bilities accept ALGOL and COBOL statements directly because its logic matches the logic of problem-language programming. Instead of an instruction-address-instruction-address sequence, there's a continuous flow of instructions with table references when addresses are required. Addresses are independent of instructions.

The system language is designed to implement the problem language for extremely rapid translations allowing program translation each run. Object programs, as efficient as those written in machine language, can be created far faster than with the most advanced conventional computers.

The need for the programmer to know both problem and machine languages is eliminated. Now for the first time, the programmer is free to concentrate on the processing problem itself. Free of the gymnastics he used to employ to make his problem acceptable to the machine, he merely states the problem and the Burroughs B 5000 provides an efficient, rapid solution.

Burroughs—TM

*Burroughs Corporation, Detroit 32, Michigan*

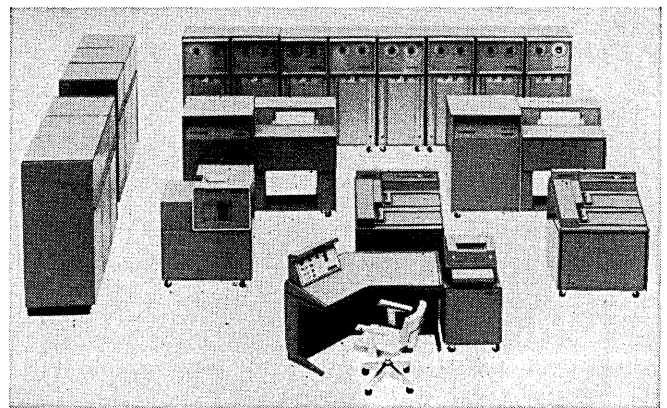

**Burroughs Corporation**



# NEW CONTROL DATA

Technical Information Series #1  
The 160-A Computer

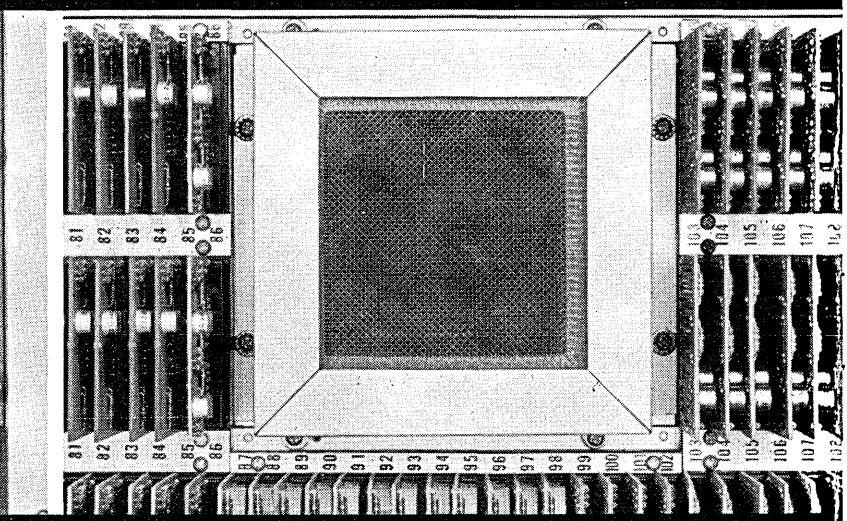
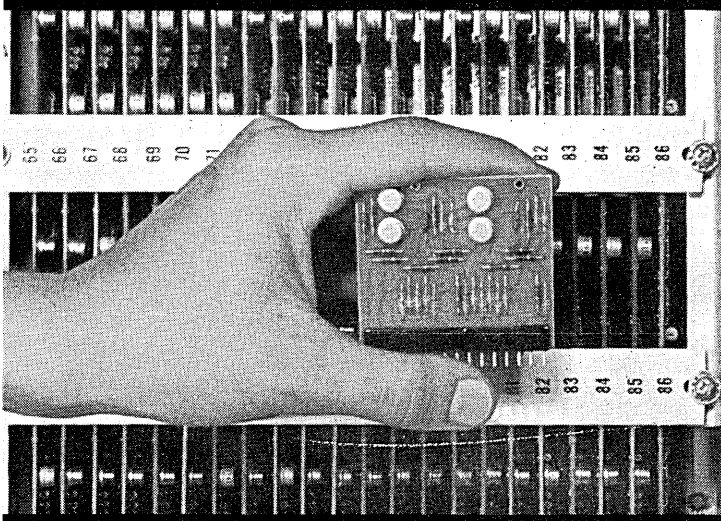
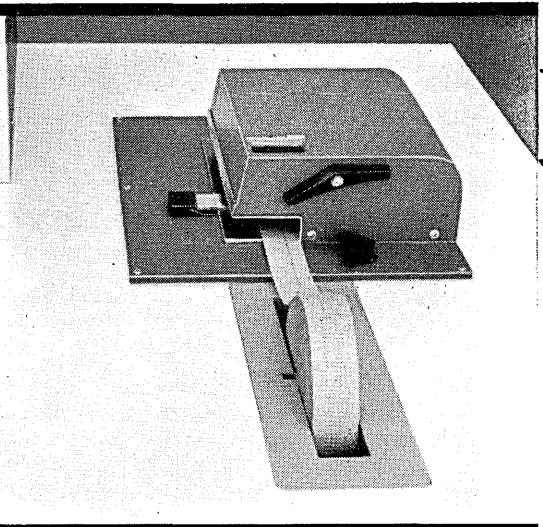
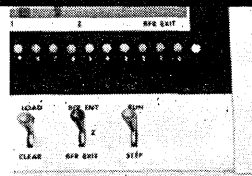
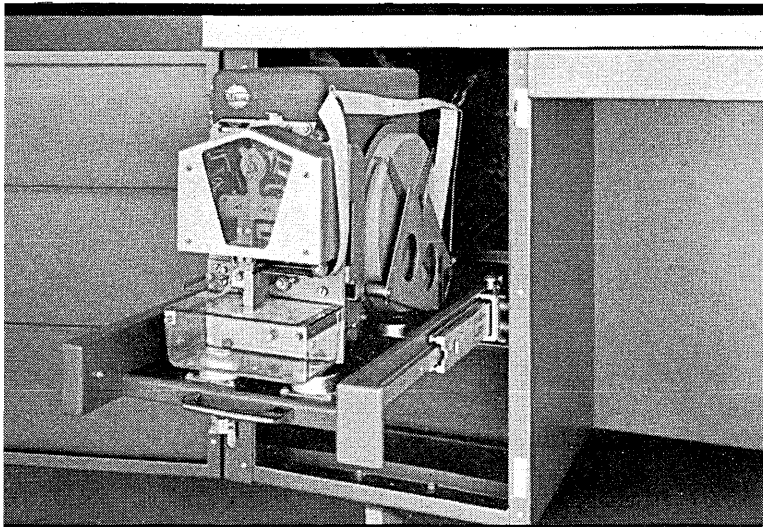
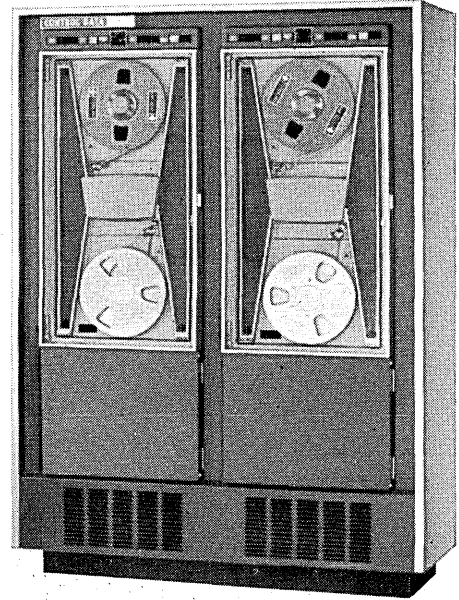
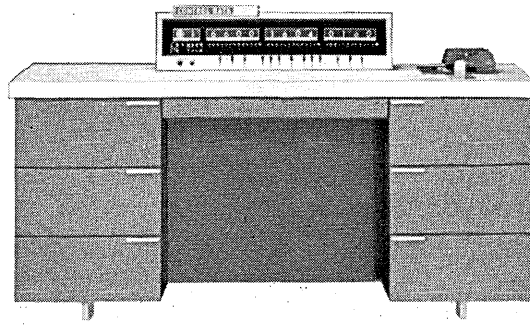
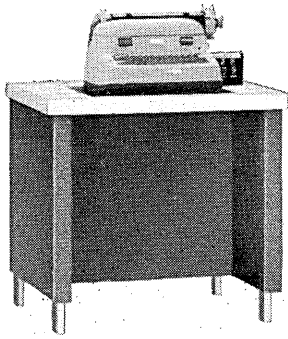

# 160-A COMPUTER

## SMALL-SCALE COMPUTER WITH LARGE COMPUTER CAPABILITIES

The 160-A is a parallel, single address data processor. Basic memory consists of two banks of magnetic core storage, each with a capacity of 4096 words and a **storage cycle time of 6.4 microseconds**. This basic memory can be expanded in modules of 8192 words up to a maximum of 32,768 words. Instructions with 12-bit operands are executed in one to four storage cycles, with execution time varying between 6.4 and 25.6 microseconds. Average program execution time is approximately 15 microseconds per instruction.

Other features of the 160-A Computer include:

- **Buffered** input/output
- Internal and external **interrupt**
- External **multiply and divide unit**
- Control Data 350 Paper Tape Reader
- 110-character/second paper tape punch

The 160-A weighs 810 pounds and is 61 $\frac{5}{8}$ " long by 30" wide by 29" high . . . the size of an ordinary office desk. It requires 16 amps, 110 volt, 60 cycles.

A basic 160-A Computer System can be expanded to include the following external equipment:

- Up to 40 magnetic tape handlers
- Input/output typewriters
- Punched card readers and punches
- Low-speed line printers (150 lines/minute)
- High-speed line printers (1000 lines/minute)
- Plotting and digital display devices
- Analog-to-digital and digital-to-analog converters

### TYPICAL APPLICATION AREAS FOR THE 160-A COMPUTER

The 160-A is a general purpose computer and can be used in an almost unlimited number of applications including:

#### REAL-TIME APPLICATIONS

The 160-A exchanges data with input-output devices at any rate up to 70,000 words per second. This transfer rate, an average instruction execution time of 15 microseconds, and the capability of buffering data while computing or while the operator manually enters data (whether the computer program is running or stopped) make the 160-A ideal for real-time applications.

#### OFF-LINE DATA CONVERSION

The 160-A is capable of controlling a variety of off-line peripheral equipment. Available service routines permit: 1) card-to-magnetic tape, 2) magnetic tape-to-card, 3) paper tape-to-magnetic tape, 4) magnetic tape-to-paper tape, 5) magnetic tape-to-printer, and 6) plotter output operations.

#### COMMERCIAL DATA PROCESSING

Along with the capability of buffering input-output devices, the 160-A Computer system includes accessories for reading 1300 cards per minute, printing 1000 lines per minute, or filing 30,000 characters per second.

#### DATA ACQUISITION AND REDUCTION

The input-output circuitry in the 160-A Computer permits direct communication with analog-to-digital conversion equipment. Following transmission, the data can be converted, reduced, or formatted by a stored program and written on magnetic tape for later analysis if desired.

#### ENGINEERING-SCIENTIFIC PROBLEM SOLVING

The high-speed, buffering, and interrupt features of the 160-A make it exceptionally useful in engineering-scientific applications.

#### COMMUNICATIONS AND TELEMETERING SYSTEMS

The 160-A Computer, used as a high-speed, parallel processor with decision-making powers, can be the principle element in communication and control networks. Proven reliability of the 160-A is a prerequisite for such application.

#### CONTROL DATA SATELLITE COMPUTER SYSTEM

The desk-size 160-A Computer is an integral part of the Control Data Satellite Computer System. Working with the large-scale 1604 Computer and the 1607 Magnetic Tape Sub-System, the 160-A presents a new dimension of computer power added to its own speed and versatility.

The Control Data 160-A is a small-scale computer with the speed, capability, and flexibility of many large-scale computers. For more detailed information, write for the **160-A Programming Manual**.

**CONTROL DATA**

**CORPORATION**

COMPUTER DIVISION

501 PARK AVENUE, MINNEAPOLIS 15, MINNESOTA

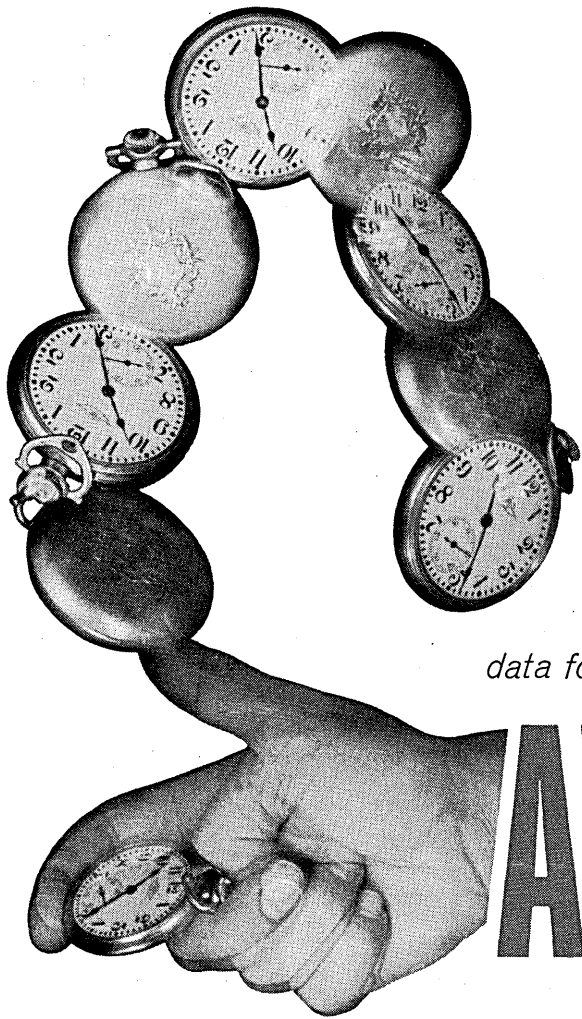

*data for timely decisions*

# AVAILABLE:

## IBM 704 COMPUTER TIME ANY SHIFT, \$275 PER HOUR

Schedule your computational problems on the newly installed 32,000-word core storage IBM 704 in the Computer Center of Litton Systems, Inc. The rate for computer and peripheral equipment is \$275 for each hour, **regardless of shift**. Programming consultation by an expert staff is also available. Litton participation in SHARE gives the client access to over 1800 programs and routines for multiproject scheduling, forecasting, manufacturing, and research and development. The FORTRAN II Compiler is available. For complete information, contact Litton Systems, Inc., Computer Center. Telephone collect: Diamond 6-4040, Ext. 2016.



**LITTON SYSTEMS, INC.**  
**COMPUTER CENTER**  
5500 Canoga Avenue • Woodland Hills, California

**DATAMATION**

## Staff

*Publisher* **FRANK D. THOMPSON**

*Vice President & General Mgr.*  
**GARDNER F. LANDON**

*Publication Manager*  
**RICHARD W. NIELSON**

*Editor* **HAROLD BERGSTEIN**

*Managing Editor & Art Director*  
**CLEVE BOUTELL**

*News Editor* **VALERIE GORSEN**

*Contributing Ed.* **DR. HERB GROSCH**

*Technical Consultant* **DON B. PRELL**

*Production Manager*  
**MARILEE CORPIS**

*Circulation Mgr.* **ALGENE TRAINA**

*Editorial Advisers*

**DANIEL D. McCracken**

**C. L. WANLESS**

**ROBERT L. PATRICK**

### Eastern District

**RICHARD W. NIELSON**  
141 E. 44th St., New York 17, N.Y.  
MUrray Hill 7-5180

### New England District Manager

**WARREN A. TIBBETS**  
112 West Haven Rd.,  
Manchester, N.H., NAional 5-9498

### Midwest District Manager

**GILBERT THAYER**

### Midwest Representative

**JOHN BRENNAN**  
201 N. Wells St., Chicago 6, Ill.  
Financial 6-1026

### Western District Manager

*& Vice President*  
**HAMILTON S. STYRON**  
10373 W. Pico Blvd., Los Angeles 64, Cal.  
BRadshaw 2-2643

### EDITORIAL OFFICES

10373 W. PICO BLVD.,  
LOS ANGELES 64, CALIF.

## Articles

- 24 BALGOL at Stanford, by *Bob Forest*
- 27 MAD at Michigan, by *Bruce W. Arden and Bernard A. Galler*
- 29 Basic ALGOL, by *Daniel D. McCracken*
- 30 Meso-Programming, by *R. L. Hooper and L. A. Raphael*
- 32 How to Make Money in Computing, a corporate profile of Control Data, by *Harold Bergstein, Editor*
- 38 From Code Card to Punch Tape
- 42 The Computer Chooser's Quandary, by *John A. Gosden*
- 45 The 1206, For Real-Time Control
- 47 The Thought Process: A Definition Before Simulation, by *P. M. Beatts*

## Departments

- 8 Important Dates in Datamation
- 10 Letters to the Editor
- 13 Datamation in Business & Science
- 21 The Editor's Readout
- 53 News Briefs in Datamation
- 61 New Products in Datamation
- 65 New Firms & Mergers
- 67 New Literature in Datamation
- 69 People in Datamation
- 71 Advertisers' Index

THIS ISSUE — 39,890 COPIES

## Cover

Four solutions to a simple problem are stated in a typographic mosaic on this month's DATAMATION cover by Art Director Cleve Boutell. Advantages of each language are carefully expounded and comparisons tightly drawn and measured in three highly readable articles beginning on page 24.

Circulation audited by  
Business Publications Audit



Member, National  
Business Publications



DATAMATION is circulated without charge by name and title to qualified manufacturers and users of automatic, information-handling equipment in all branches of business, industry, government and military installations. Qualified individuals in the United States and Canada are invited to request application on their company letterhead, stating job function and firm's business. Available to others by subscription at the rate of \$10.00 annually; single issue, \$1.00 when available. No subscription agency is authorized to solicit or take orders for subscriptions in the United States, Canada or overseas.

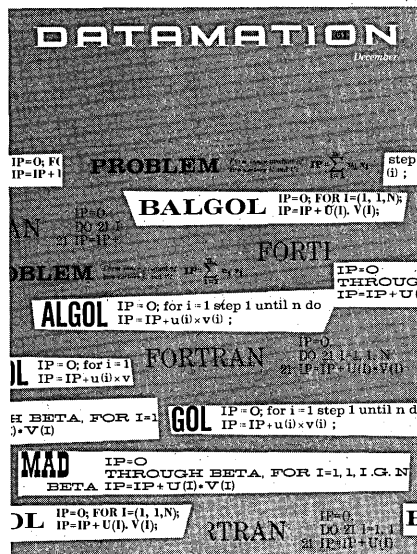

# MAC PANEL *computer tape* . . . ASSURED PERFORMANCE

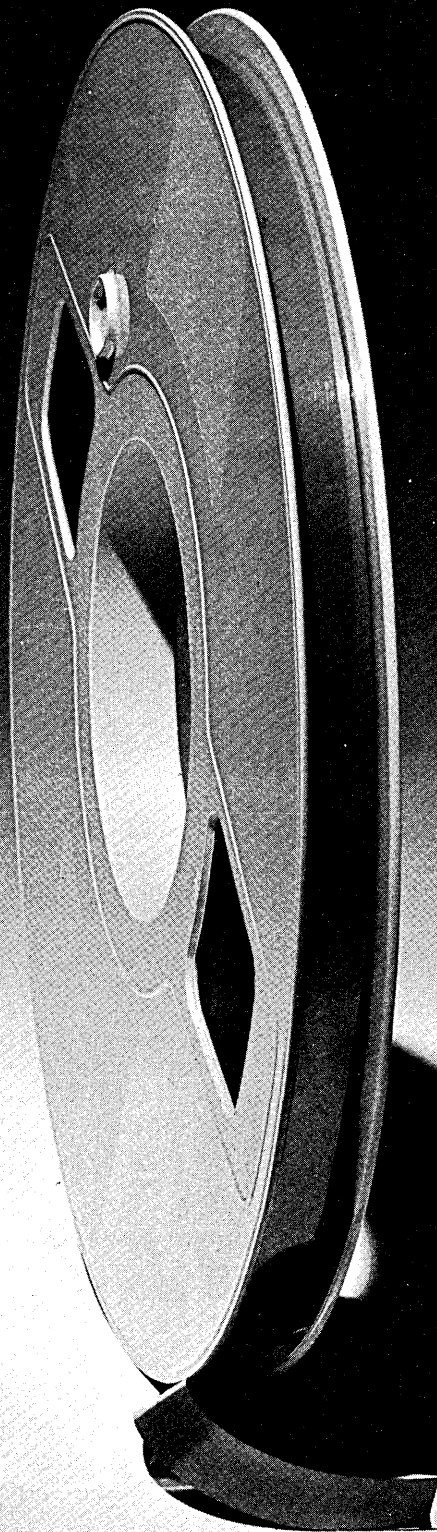

Division of Adams-Millie Corporation

MAC Panel Computer Tape is produced under rigidly controlled, scientific conditions to give you assured tape performance. *Manufactured for Performance* through the use of an improved oxide formulation that insures the presence and retention of the most critical magnetic properties as well as the prime physical characteristics: permanent coating adhesion . . . hard shell toughness . . . and flexibility under all conditions. *Tested for Performance* using procedures that far exceed the normal criterion for attention to detail. Every element in the new oxide



formulation is tested before and after blending . . . every reel of tape produced is subjected to thorough tests which insure the quality of MAC Panel Computer Tape. *Packaged for Performance* in clean, dust-proof containers hermetically sealed inside a plastic envelope. This entire unit is shipped to you in a specially designed, shock absorbing package that features a "handy-handle" for carrying convenience. *Write for Free Booklet:* "MAC Panel Computer Tape . . . Assured Performance."

**MAC PANEL COMPANY ■ High Point, North Carolina**



CIRCLE 6 ON READER CARD





**Photocircuits'  
exciting new  
tape reader  
design  
throws out the  
transmission...**

***... gives you greater reliability at less cost!***

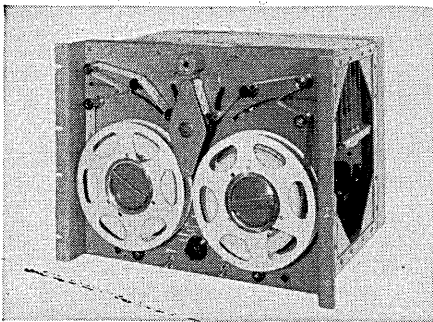

Using the revolutionary PMI printed motor, Photocircuits' line of Photoelectric Paper Tape Readers eliminates brakes, clutches, pinch rollers, solenoids — and trouble. Result: reliability that conventional readers can't match! Plus quieter

operation, reduced tape wear, rapid reading and sustained trouble-free, error-free performance with maintenance at a minimum.

Photocircuits' readers offer you, at no additional cost—easy loading, jam-free operation over splices—tight tape and no tape protection—bi-directional reading—fast rewind in both directions— asynchronous reading at up to 300 characters per second—free running at 400 characters per second with the ability to stop on a character — and *magnetic switching*, which eliminates metal-to-

metal contact in electrical switching of the reel servo motors.

Technical literature on the 300 R and the other Photocircuits' readers is yours for the asking. Get all the facts about how Photocircuits' advanced Tape Readers can perform for you and save your company money at the same time.

***Photocircuits***  
CORPORATION  
TAPE READER DIVISION  
GLEN COVE, LONG ISLAND, NEW YORK

# THINK... High Density

242,000 to  
450,000 BCD Digits/Sec

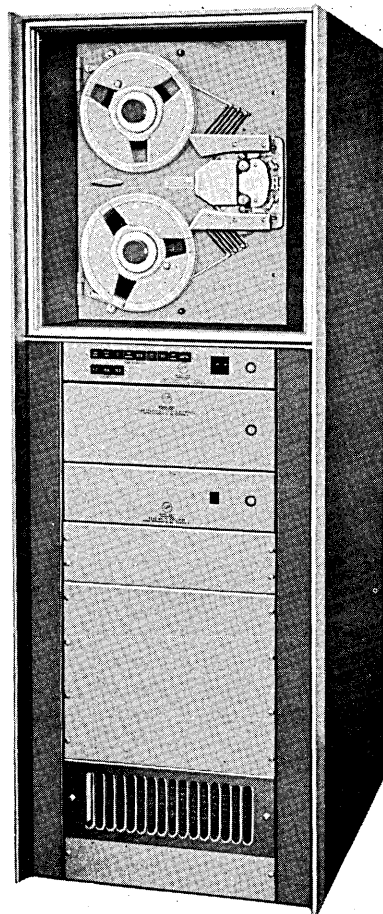

Available from  
**POTTER**  
Today!

Potter High Density Tape Systems provide reliable performance for any computer system... and at bit packing densities higher than any other digital magnetic tape system available now. Each reel of 1-inch tape recorded using the Potter High Density technique holds as much data as eleven reels recorded by the most common systems. This break-through in the art provides data transfer rates of 242,000 to 450,000 BCD digits per second... with a guaranteed recovery of at least 99,999,999 out of 100,000,000 bits recorded at the higher transfer rate.

*There's much more to our story. So much more that we've produced a fact-filled brochure called "The Topic is...HIGH DENSITY." It's designed to answer your questions regarding this advanced recording technique...why not send for your copy today?*



**POTTER INSTRUMENT CO., INC.**  
Sunnyside Boulevard • Plainview, New York

T.M.

CIRCLE 8 ON READER CARD

## important DATES

- A symposium on Optical Character Recognition is scheduled for Jan. 15-17 jointly sponsored by the Information Systems Branch of the Office of Naval Research and the Research Information Center of the Bureau of Standards. Meetings will be held in the Dept. of Interior Auditorium, Washington, D.C.
- The Office of Naval Research, Information Systems Branch, is sponsoring a symposium on Redundancy Techniques for Computing Systems which will be held on Feb. 6-7 in the Dept. of Interior Auditorium, Washington, D.C.
- Management of Science Information Centers will be the theme of the Fourth Institute on Information Storage and Retrieval to be held Feb. 12-16 at The American University, Washington, D.C. For information contact Dr. Lowell H. Hattery, Director, Center For Technology & Administration, The American University, 1901 F. St., N.W., Washington 6, D.C.
- The New York Management Symposium of the Assoc. of Data Processing Service Organizations will be held on Feb. 19 at the National Cash Register Computing Center in New York City. For information write to W. H. Evans, ADPSO, 1000 Highland Ave., Abington, Pa.
- A Symposium on Interactions Between Mathematical Research and High Speed Computing will be held April 16-18 at the Chalfone-Haddon Hotel, Atlantic City, N.J. It is sponsored by the American Mathematical Society and the ACM.
- The Spring Joint Computer Conference (formerly known as the Western Joint Computer Conference) will be held May 1-3 at the Fairmont Hotel, San Francisco. Conference chairman is G. A. Barnard, Philco Corp., Palo Alto; vice chairman is H. D. Crane, Stanford Research Institute, Palo Alto and program chairman is R. I. Tanaka, Lockheed Corp., Palo Alto.
- The 1962 IFIPS Congress is scheduled for Aug. 27-Sept. 1 in Munich, Germany. For information write to Dr. E. L. Harder, Westinghouse Electric Corp., East Pittsburgh, Penna.

**DATAMATION**

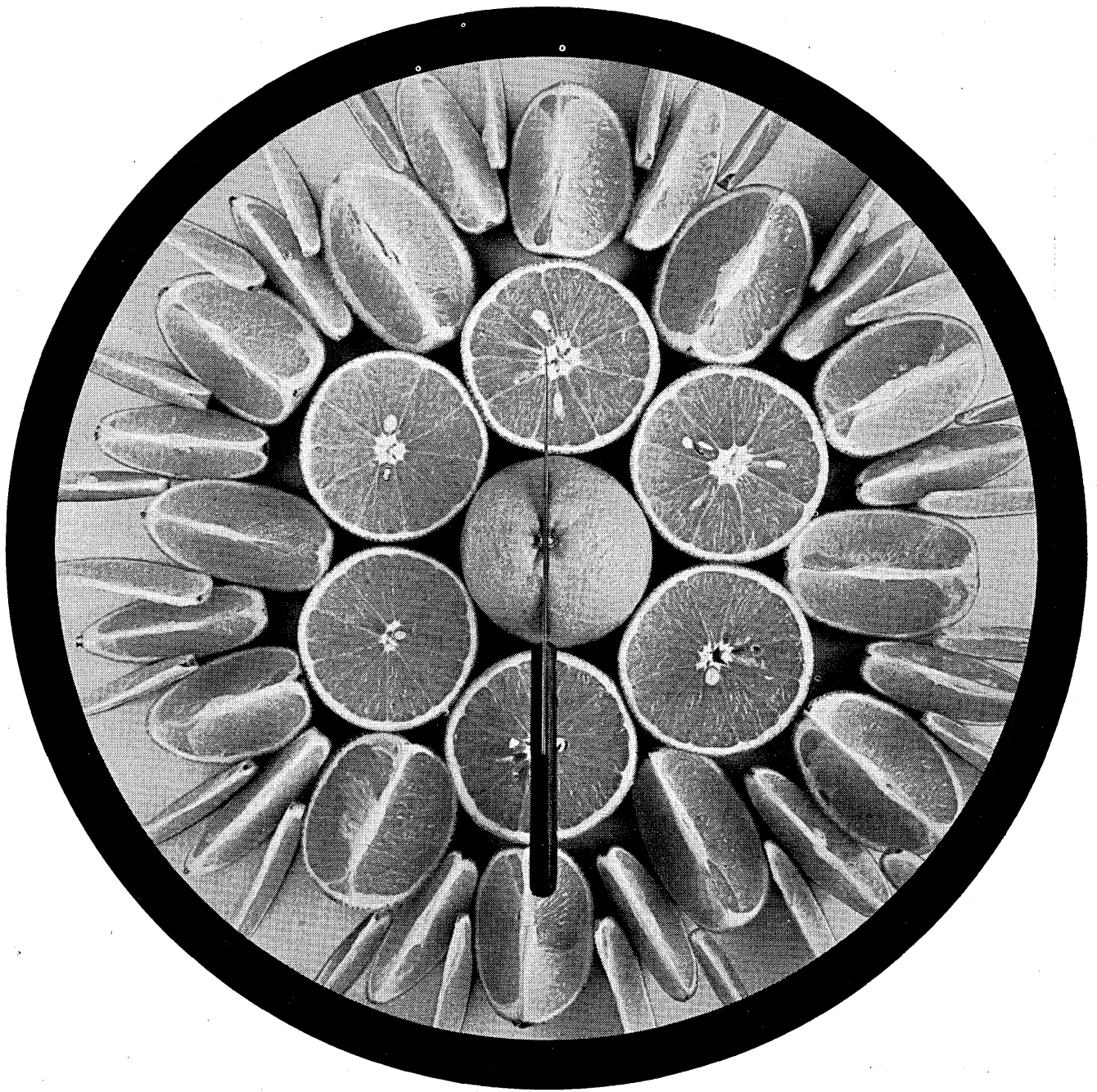

## AD INFINITUM

You can solve your computer problems quickly and economically by using our 32K-word storage IBM 704. Whether you need long or short runs, they can be readily scheduled on our machine at the same attractive rate for every shift—\$275 per hour, including all peripheral equipment and the services of our experienced operators ■ Bring your program to us and work in our Client's Room between runs—or mail us your program with instructions for running it and we will mail back the printout within 24 hours—or simply leave your entire problem in the hands of our capable mathematical analysts and programmers whose skills can be relied upon ■ If you need pipe stress, structural stress, flow analysis, or curve fitting, one of our general programs might well be just what you are looking for ■ To take advantage of our prompt, efficient computer services, call us collect, New London, Conn., Hilltop 5-4321, Ext. 1449. Wire or write: Electric Boat, Groton, Conn.

**GENERAL DYNAMICS | ELECTRIC BOAT** **G**  **D**

# letters

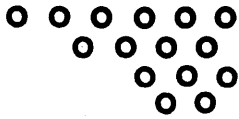

## a confusing precedent

I would like to suggest that the starting of a precedent in which "information retrieval" is referred to as IR might be confusing inasmuch as IR has referred to infra-red for many years.

S. E. BONWIT

*Applied Physics Laboratory  
Johns Hopkins University  
Silver Spring, Maryland*

## NAACP for edp

Having just read "ALGOL: a critical profile" in the October 1961 issue of *Datamation*, I would like to add my comments.

I feel that the major difficulty in establishing a universal computer language is the lack of responsible action on the part of those involved. Several attempts have been made to take the initiative but they have failed because others would not cooperate.

There are three major groups in the computing industry and their actions and motivations are quite dissimilar although they should not be. The manufacturers make machines to be used by commercial customers and the universities are "making" computer programmers for the same commercial customers. Any one of these groups could possibly come up with a universal computer language that they could ram down the throats of the other two if they could cooperate within their own group. However, I propose they form jointly a National Association for the Advancement of Computer Programming. I believe that such a group could be supported by voluntary contributions from the various parties concerned. It should be an organization of well qualified, paid employees who would not owe allegiance to any one faction. They could set standards for the computer manufacturers, they could write (and maintain) universal computer languages and they could prepare the instructional material needed to educate the users of the language.

We all agree that it is impossible to write a single language that will work on all machines. This is where stand-

ardization enters in. I am *not* proposing that all machines be made the same but rather that all machines be categorized and several languages, or versions of one language, be written to handle all categories. For example, in order that a given computer be rated say class A1, it would have to be able to handle the most sophisticated universal language available. This would imply certain other requirements such as eight magnetic tapes, on-line printer, etc. Perhaps a class A2 computer could compile the same programs as a class A1 computer but could not execute certain commands such as I/O. Similarly a class B1 computer might be restricted to a less sophisticated version of the same language or it might require an entirely different language.

These standards would help the buyers of equipment because they would then be able to determine the limitations of various machine configurations without detailed studies. A manufacturer could advertise that the minimum configuration of a given machine type was rated class A4 and that in other configurations could be upgraded to all classes up to and including A1. There would still be room for competition in other areas, such as operating speed, because the standards would only set minimums required for given classifications.

One might argue that the ACM should assume this responsibility. Maybe they should. The important point is that the state of the art is progressing so rapidly that the only way to get caught up and get ahead is to have a full-time, paid staff working in this area.

Another possibility, which I am not recommending, is the intervention of government. We also have ample precedent for this, namely, the control of transportation and communications.

My suggestions may not seem practical to some readers but are we being practical in our present approach? The answer is clearly that we are not.

ROBERT LAFARA

*Numerical Mathematics Staff  
U. S. Naval Avionics Facility  
Indianapolis, Indiana*

## ACM revisited

I noted "ACM Revisited" with interest in the October *Datamation*. As they say, I should like to set the record straight with regard to the exhibit's space management.

In the first case, I think we owe a debt of gratitude to the Encyclopedia Britannica and Americana who were flexible enough and had sufficient interest and confidence in the Associa-

tion to take, at the last minute, the most expensive booth in the show. Clearly in an industry show of this nature, it would be very desirable to have a manufacturer of EDPM equipment or a more directed organization displaying in the most prominent booth; however, because that booth's contracted occupant elected to withdraw at the very last moment, it was necessary to fill the booth with anyone who could a) foot the tab, and b) have the flexibility to move. As you know, we were not overwhelmed with requests for booth space such that we could immediately assign a pertinent alternate when cancellations occurred.

I dislike intensely airing the underlying principle suggested by the situation but it seems important in this case, not for the purpose of "passing the buck" but rather as a criticism to be constructive to the management of ACM. The major difficulty encountered by the exhibits committee in selling booth space at the show was that potential exhibitors were entirely unaware of ACM. Typically, potential exhibitors asked, "Who is ACM?" "What do they do?" "Who are your people?" etc. Clearly this reflects strongly on the public image of the Association. Whether the ACM wishes to assume the proportions of a leader among professional societies (as we, indeed, are) is still a bit nebulous to me; however, it would appear that the latter is necessary in order to be discriminating in matters of this nature.

In conclusion, I feel that an excellent lesson was learned by the Association. I feel, too, that the lesson ACM learned should result in a substantial effort to include in future editions of the various encyclopedias the terms "computers," "computology," "cybernation," etc., adequately treated.

E. FLOYD SHERMAN

*Chairman, Exhibits Committee  
1961 ACM National Conference.*

## help!

We, the programming staff of the G. C. Dewey Corp., are interested in obtaining information regarding the special uses and the limitations of all the existing compiler languages for digital computer programming. . . We would appreciate it if you would air-mail to us any information that you have on this matter.

ALICE B. COPLAND  
*G. C. Dewey Corp.  
New York City*

(Editor's note: According to their letterhead, the above mentioned firm consults in Operations Research, Systems Engineering, Computer Programming and Communication Theory.)

# GUARD AGAINST DOWNTIME WITH RELIABLE TAPES OF MYLAR®

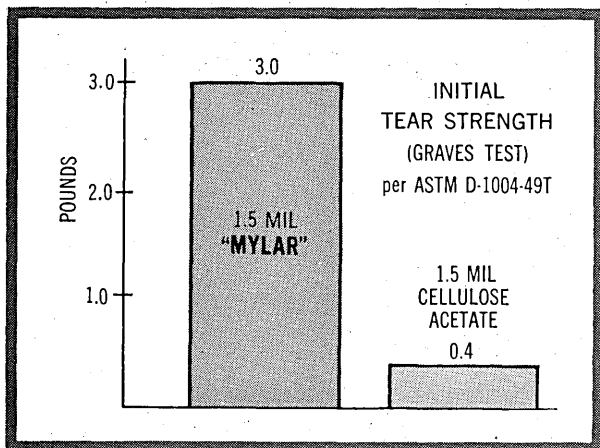
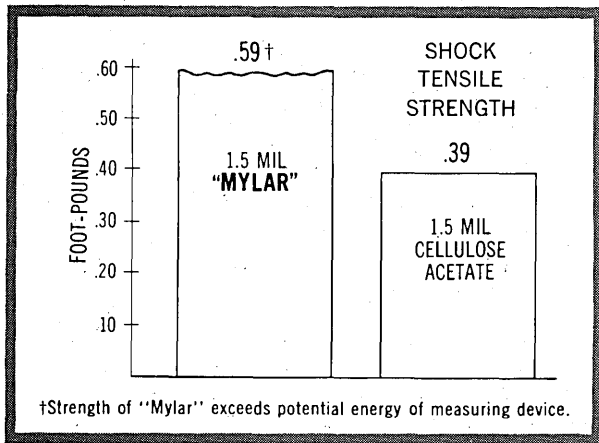

Every minute of downtime costs you dollars. That's why the reliability of your magnetic tape is so important. Tapes of Mylar\*, resist breaking from sudden starts and stops since they have high shock-tensile strength . . . and they have 7 times the initial tear strength of acetate tapes.

"Mylar" adds to the reliability of playback. It resists the cupping, swelling and shrinking which can reduce intimate head contact and cause read/write errors. Age, storage conditions and repeated playbacks won't affect "Mylar" either.

The cost of the data . . . the cost of the equipment . . . the cost of time *all* demand reliability. Get it with tapes of "Mylar". Send coupon for free booklet of comparative test data and judge for yourself. Du Pont Company, Film Department, Wilmington 98, Delaware.

\*Du Pont's registered trademark for its polyester film.



REG. U.S. PAT. OFF.

Better Things for Better Living . . . through Chemistry

DU PONT  
**MYLAR**®  
POLYESTER FILM

E. I. du Pont de Nemours & Co. (Inc.)  
Film Department, Room #12, Wilmington 98, Delaware

Please send free, 12-page booklet of comparative test data to help me evaluate magnetic-tape reliability.

Name \_\_\_\_\_ Position \_\_\_\_\_

Company \_\_\_\_\_

Address \_\_\_\_\_

City \_\_\_\_\_ Zone \_\_\_\_\_ State \_\_\_\_\_

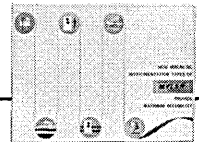

CIRCLE 10 ON READER CARD

*Ramo-Wooldridge designs and produces data processing systems, computers, display devices, man-machine communication consoles and related peripheral equipment.*

**P  
R O  
G R A M  
M I N G** is  
the science  
of getting com-  
puters and users  
to talk to each other.

**TOP** is for  
programming

At Ramo-Wooldridge, programming is considered to be a science. Understanding the problem, the user's needs, and the hardware—in their fundamental aspects—is the starting point for a scientific programmer. Mere coding is not his job.

Ramo-Wooldridge believes that the major advances in computer design over the next ten years (call them "breakthroughs" if you will) are going to result from innovations in software design as much as from new hardware concepts. R-W's "back to fundamen-

tals" approach has brought national distinction to its programming staff and won a position of leadership in such fields as

- *Stored Logic Computer Design*
- *Multi-Computer Installations*
- *Large-Scale Information System Design*
- *Man-Machine Communications Techniques*

If you have three or more years of professional experience, you are invited

to inquire about immediate openings on Ramo-Wooldridge's expanding programming staff. All qualified applicants will receive consideration for employment without regard to race, creed, color or national origin.

Address inquiries to  
Mr. R. J. Krempfle at



**RAMO-WOOLDRIDGE**

A DIVISION OF

**Thompson Ramo Wooldridge Inc.**

8433 FALLBROOK AVENUE, CANOGA PARK, CALIFORNIA

DATAMATION!

NUMBERS  
AND  
ANNOUNCEMENTS

WHO'S  
IRST?

If there is one subjective judgment most frequently made by virtually all manufacturers and erudite users, it involves a ranking of the leading contenders according to their present dollar volume in the computer market. Common to such opinions is a high probability of error. However, in the absence of a statistically authoritative projection, DATAMATION offers its own guesstimate based on a) a private poll of 25 of computing's leading citizenry; b) a compilation of 7 surveys pointing toward this end, and c) a DATAMATION formulation based on an extension of typical monthly rentals of general purpose computers presently delivered and on order. Process control, special purpose and analog devices are excluded.

Rated by percentage of the total market are the following:

IBM-31.2%; RemRand-6.6%; RCA-3.1%; HCR-1.2%; Burroughs-1.6%; Philco-1.0%; Control Data-1.4%; Honeywell-.8%; G.E.-.5%; Autonetics-.4%; Royal McBee-.25%; Packard-Bell-.2%; Monroe-.1%; Alvac-.05%.

ANNOUNCEMENTS  
A RECAP

The "Numbers game" has a meaning unique in the computer field which simply implies the exchange of gossip and occasional facts on unannounced hardware. To clear the air at least temporarily, DATAMATION offers the following current collection of forthcoming numbers and ultra-brief explanations:

IBM: 7090D & E (a new series under development and ranging in power and price from the 709 to a 1 microsecond memory); 7950 (a STRETCH-class machine with high-speed tapes also known as Harvest); 3100 series (presently on the shelf).

CDC: 924 (a 24 bit 1604 for business applications); 6600 (STRETCH-class hardware with core storage of 256K and less than 1 microsecond memory).

BENDAM: G-25 (successor to the G-15 temporarily shelved); G-21 (a polymorphic arrangement of G-30s).

BURROUGHS: D825 (a large scale, thin film computer featuring Polish Notation, basic 65K core memory with 1 microsecond access time); D850 (a super-STRETCH-

FIRST CLASS  
Post No. 10190  
New York, N.Y.

FIRST CLASS  
Post No. 10190  
New York, N.Y.

FIRST CLASS  
Post No. 10190  
New York, N.Y.

class thin-film computer with access time in the nanosecond range).

**RAMO WOOLDRIDGE:** CM403 (a large scale successor to the 400 a considerable distance from announcement); RW 130 (15 bit version of the AN/UJK-1); RW 350 (18 bit version of AN/UJK-1).

**PACKARD-BELL:** 350 (a successor to the 250. The designation and specs are presently being revised due to the recent shift in management at PB. As the 350, a 24 microsecond basic core memory of 4K words was featured).

**MONROE:** MONROBOT XIII (allegedly twice the speed and about half the price of the XI).

**EL-TRONICS:** ALWAC IV (solid state version of the III still on the drawing board).

IBM's  
ALGOL QUANDARY

Frankly acknowledged by many IBMers as a far superior processor to FORTRAN, ALGOL development is nevertheless far from practical in the eyes of IBM management. The problem is not one of money but largely the lack of experienced programmers to meet present commitments for over 35 FORTRAN processors as well as numerous other dialects promised to IBM customers. In addition, scrapping their present investment in FORTRAN would involve an enormous risk for IBM with no national or international body providing the needed authority for a definitive explanation of ALGOL.

Other companies such as Burroughs with no previous investment in FORTRAN, have made successful inroads in ALGOL development and pressure to drop FORTRAN has been keenly felt at White Plains. However, user groups such as SHARE have recently waned in their ALGOL enthusiasm and are encouraging IBM not to scrap FORTRAN because of increasing individual investments in training and programming.

The current status at IBM: considerable head scratching.

ASI STOCK UP  
ON FAITH & GEOGRAPHY

When first announced as a new entry in the computer market several months ago, Advanced Scientific Instruments in Minneapolis demonstrated the premature birth pains of saying a great deal too soon. ASI's first press release boasted a complete line of small, medium and large scale, gp scientific machines while their employees numbered a tidy 30. Disregarding this obvious paradox and the fact that drawing board specs were still pinned to the draftsman's table, brochures were distributed by ASI outlining operating characteristics, peripheral gear and design principles for all three machines.

Founders of the new firm are from General Mills

Be sure your cards and packages are signed, sealed and delivered with

**CHRISTMAS SEALS TO FIGHT TB**

ANSWER YOUR CHRISTMAS SEAL LETTER TODAY

DECEMBER

NAME \_\_\_\_\_

TITLE \_\_\_\_\_

COMPANY \_\_\_\_\_

ADDRESS \_\_\_\_\_

CITY \_\_\_\_\_

HOME ADDR

CITY \_\_\_\_\_

FOR M

PRODUCT ADV

1	2	3	4	5
10	11	12	13	14
19	20	21	22	23
20	29	30	31	32
37	38	39	40	41
46	47	48	49	50
55	56	57	58	59
64	65	66	67	68
73	74			

I  
SU

I you

NAME \_\_\_\_\_

TITLE \_\_\_\_\_

COMP \_\_\_\_\_

COMP \_\_\_\_\_

CITY \_\_\_\_\_

GM

Show

COMP \_\_\_\_\_

CITY \_\_\_\_\_

DECEMBER

NAME \_\_\_\_\_

TITLE \_\_\_\_\_

COMPANY \_\_\_\_\_

ADDRESS \_\_\_\_\_

CITY \_\_\_\_\_

HOME ADDR

CITY \_\_\_\_\_

FOR M

PRODUCT ADV

1	2	3	4	5
10	11	12	13	14
19	20	21	22	23
20	29	30	31	32
37	38	39	40	41
46	47	48	49	50
55	56	57	58	59
64	65	66	67	68
73	74			



where their plans for commercially available equipment were not encouraged, so they proceeded to wrap up their drawings, secure some capital, and start their own operation.

Despite the fact that there were no orders in the house until late last month, ASI stock climbed steadily from \$1.15 in August when 875,000 shares were issued to almost \$7.00 early in November, a probable result of the kindly feeling prevalent in the stock exchange toward new computer manufacturers from Minneapolis.

Since geographic proximity and color brochures are hardly the basic ingredients for a successful operation, the first ASI contract was obtained from NASA for the small-scale 210. Delivery of the \$130,000 computer is scheduled for April. In addition, the first prototype of the medium scale 420 is reported on the air and features a 42 bit, 8K core memory with 14 microsecond add time and 2 microsecond cycle time.

NEW GOVT. REGS  
TO BOOST EDP SALES

A sharp increase in the purchase of edp equipment by the federal government is expected as a result of recently issued instructions from the Bureau of the Budget establishing conditions for the purchase of hardware and stating that the lease method applies only when purchase or lease-with-option-to-purchase agreements have been determined as "conclusively" disadvantageous.

The purchase method is to be used by the government when "a comparative cost analysis of alternate methods indicates a cost advantage can be obtained by the purchase method in six years or less after date of delivery."

The lease-with-option-to-purchase method is indicated when "a short period of operational experience is desirable to prove the validity of a system design or where decisions which might substantially alter the system specifications are imminent."

For comparatively smaller and newer firms in the computing field, this stress on purchase should come as encouraging news providing a more immediate return on heavy initial investments.

FILCO:  
NO NEWS IS NO NEWS

Awaiting stockholder confirmation of the Ford-Philco merger, industry speculation continues on the fate of the computer division. Three leading guesses are: 1) major support will be forthcoming with development of new hardware and wider sales of the current line including the 2400; 2) consolidation of Aeronutronic and the Philco Computer division and 3) dropping the computer division entirely. At this juncture, a team of management consultants are being employed by Ford to recommend the most profitable route while Philco salesmen are encouraging potential customers with the rhetorical question, "Why buy from a weeny outfit like IBM when you can buy from the third largest company in the country?"

Soon to be announced from Philco are high speed tapes facetiously termed "super-Hypertapes," and a disc file called "super-Hyperdiscfile."

# WE REALIZE THAT THESE POSITIONS WILL BE AD- VERTISED AGAIN NEXT YEAR!!

BECAUSE MANY OF THE PEOPLE WE HIRE NOW WILL HAVE BEEN PROMOTED.

Our H800 and H400 scientific and business computer systems have been gathering users like bees to honey. To keep the supply equal to the demand, Honeywell EDP has had to grow.

Hence, one year from now you'll probably see this ad again. Where will you be then? Still looking for a way out of your present job, or growing with Honeywell EDP?

## PROGRAM SYSTEMS DIVISION

*Opportunities exist for:*

### SENIOR ANALYSTS

Responsibilities in the Language Definition and Systems Determination Group. Analysis of the COBOL specification and the development of compiling systems for implementation. A degree in mathematics or physics is desirable, with 3-5 years' experience in Automatic Programming. Specific experience in constructing Assemblers with generators and library sub-routines is desirable.

### STAFF ANALYSTS

Should have 2-4 years' experience. You will organize and direct the implementation of complex program systems such as Compilers and Assembly Routines.

### PROGRAMMERS

College degree preferred. A minimum of one year's experience is required. You will write and check out portions of Automatic Programming Systems. These and other Programmer opportunities exist in the following areas: Program Monitoring Systems; Scientific Programming; Operational Programming; Service Routines.

## MARKETING DIVISION

*Opportunities exist for:*

### INSTRUCTORS

Courses are presented at our Branch Offices and at customer locations, therefore some foreign travel is possible. Must have at least one years' experience teaching EDP Programming and Systems. Willingness to travel and relocate is essential.

### SALES REPRESENTATIVES

Qualified candidates should have at least one year's experience selling magnetic tape EDP systems. Insurance background would be useful, however this is not a requirement.

### SYSTEMS SERVICE REPRESENTATIVES

Requires prior experience in Programming and Systems Analysis work on tape computers.

*These career assignments are available throughout the United States, particularly in the New England area. Honeywell EDP offers an excellent employee benefits program, the opportunity to continue your education and periodic salary reviews. Relocation expenses will be paid. The confidential nature of all inquiries shall be completely respected.*

# Honeywell



*Electronic Data Processing*

*'An Equal Opportunity Employer'*

Send all inquiries to: JOHN O'SULLIVAN  
Employment Supervisor  
60 Walnut Street, Dept. 98  
Wellesley Hills 81, Massachusetts

## Now business machines can "talk" over telephone lines

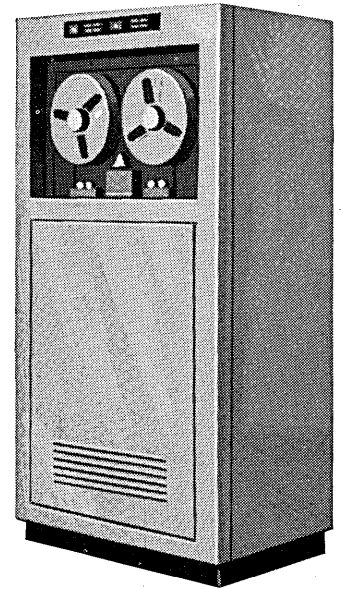
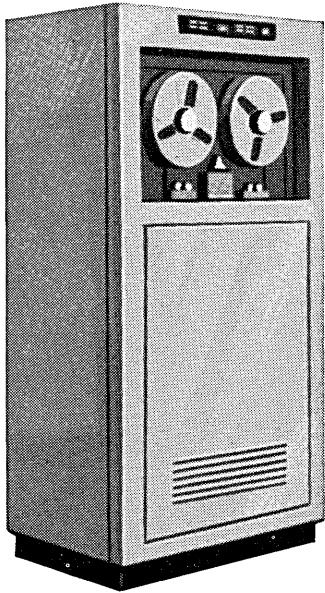

DATA-PHONE service makes it possible. It's the new Bell System development that lets you send business data over regular telephone lines, at regular telephone rates. DATA-PHONE service converts either card-punched or taped data into a special language which can be sent by telephone at speeds up to 1600 words per minute. It speeds data collections from branches, improves customer service, promotes more efficient, more profitable operations. *Like to know more?* Just call your Bell Telephone Business Office and ask for a Communications Consultant. He'll bring you complete details. No obligation, of course.

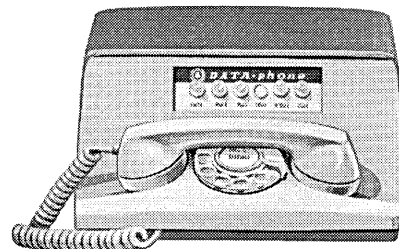

**BELL TELEPHONE SYSTEM**

PROGRAM											SAMPLE CUSTOMER ORDER RUN USING A COMBINATION OF COBOL, TABSOL, AND ALGOL																																	DATE																		
PROGRAMMER																						COMPUTER											GE 225	PAGE																												
1	2	3	4	5	6	7	8	9	10	11	12	13	14	15	16	17	18	19	20	21	22	23	24	25	26	27	28	29	30	31	32	33	34	35	36	37	38	39	40	41	42	43	44	45	46	47	48	49	50	51	52	53	54	55	56	57	58	59	60	61	62	63
SEQUENCE NUMBER																																																														
305											OPEN INPUT MASTER~SPEC, CUST~SPEC, AND PARAMETER FILE																																																			
310											READ PARA~CARD RECORD.																																																			
315											GET~SPEC. READ CUST~SPEC RECORD, AT END FILE GO TO END~R																																																			
320											READ MASTER~SPEC RECORD UNTIL ORDER~NO OF MASTER~SPE																																																			
325											ORDER~NO OF CUST~SPEC, AT END FILE GO TO END~ROUTI																																																			
330											IR = SQRT (A**2 + B**2). MOVE A1 TO A. MOVE B1 TO B.																																																			
335											K~SPEC TABLE. 3 CONDITIONS, 3 ACTIONS, 4 ROWS.																																																			
340											K EQ   IR EQ   LOT~NO EQ   DRWG~NO   HOLE~DIA   PERFORM T																																																			
345											0.0763   0.00761   "AB33"   "5007AB33"   0.77   COST~01																																																			
350											1.1127   0.3451   "CU33"   "501BCU33"   1.34   COST~07																																																			
355											2.9001   0.7942   "FE331"   "5020FE331"   1.99   COST~03																																																			
360											3.7667   0.81175   "AL331"   "5024AL331"   2.09   COST~10																																																			
365											IF K~SPEC TABLE NOT SOLVED, DISPLAY "K~SPEC N.S." CN																																																			
370											PERFORM AREA~P.																																																			
375											SPEC~CALC. AREA(J) = P~AREA																																																			
380											IF AREA(J) EQ D~AREA(L(I*3), M(Q+N, Z)) OR HOLE~WD NGR																																																			
385											PDZ = (A*B)**3 - SQRT AREA(J).																																																			
390											IF J EQ Q-1 THEN GO TO GET~SPEC																																																			
395											J = Q.																																																			
400											GO TO COST~ADJUST.																																																			

# A UNIQUE CONCEPT IN

now available in the GE 225... and future General Electric general-purpose computers.

- processes COBOL, ALGOL and TABSOL\*
- all problem statements easily read and understood
- extended usage... re-programming unnecessary
- programs produced faster... more efficiently

GECOM—the first truly GENERAL COMPILER SYSTEM—introduces a fresh, versatile approach to computer communication. Developed for the GE 225 computer, the GENERAL COMPILER makes available all of the various proved programming techniques in one consistent, compact package. No longer is it necessary to learn a dozen different programming systems to handle a full range of jobs effectively—each job is approached in exactly the same way, be it formula evaluation, a sort, or even a payroll. The language for describing any run is consistent, operating procedures and programming are standard, and documentation is readable and easily understood.

\*A General Electric Trademark

THE GENERAL COMPILER PROVIDES—

A FAMILIAR LANGUAGE STRUCTURE—Problems need not be stated in machine code. The GENERAL COMPILER processes English language statements (COBOL), Algebraic expressions (ALGOL), and Structure Tables (TABSOL). It permits you to use all or any one of the computer languages... as your needs require. Still, you have available the capability to expand, use other languages and new techniques as your needs change.

A PROVED, ACCURATE CODER—Data Description and Problem Logic may be written in one, two, or a combination of the available languages producing a machine program of efficient, effective coding. Since the machine coding is derived directly from the logic of the problem statement, it is only at the logic level that debugging may have to be done.

A STANDARDIZED, UNDERSTANDABLE DOCUMENTATION—Because GENERAL COMPILER problems are written in familiar languages, they can be easily read and under-

1 / 20 / 61  
 3 of 9  
 1 6 8 8 8 6 7 6 8 8 9 7 0 7 1 7 2 7 3 7 4 7 5 7 6 7 7 7 8 7 9 8 0

ES.  
 OUTLINE.  
 C EQUALS  
 NE.

ABLE

TYPEWRITER.

3.012E-5 THEN

Computer Department, Phoenix, Arizona CA-13 (10-60)

# GENERAL ELECTRIC'S NEW 225 GENERAL COMPILER

COBOL

TABSOL\*

ALGOL

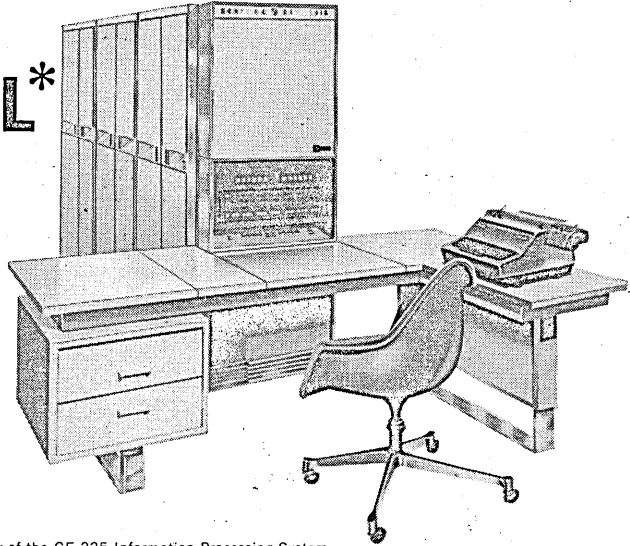

Control Console and Central Processor of the GE 225 Information Processing System

## COMPUTER COMMUNICATION

stood. In addition, problem format provides a high degree of standardization. Programs written for today's machines in GECOM format can be used for future General Electric computers—eliminating the need for re-programming.

**AN EFFICIENT, ECONOMICAL USE OF COMPUTERS**—Personnel training time and expense are sharply reduced since the novice programmer may use the familiar terminology of his profession. Manual coding is eliminated and debugging cut to a minimum. Thus, a machine program may be produced much faster and

more efficiently than by present manual methods.

**THE GENERAL COMPILER IS ANOTHER GENERAL ELECTRIC FIRST!**

For more detailed information, write today for brochure CPB-144 on the new General Electric General Compiler. Also available: brochure CPB-101 on the GE 225 Information Processing System and CPB-81 on the GE 210 Data Processing System.

Write to: General Electric Company • Computer Department • Section 60J12 • Phoenix, Arizona.

**Contact Your Nearest General Electric Computer Department District Office:** Atlanta: 270 Peachtree St. N.W., 522-1611 • Boston: 140 Federal St., HU 2-1800, Ext. 311 • Chicago: 120 S. La Salle St., 782-5061 • Cleveland: Williamson Bldg., 215 Euclid Ave., SU 1-6822 • Dallas: 3200 Maple Ave., RI 8-0589 • Denver: 201 University Blvd., DU 8-4545 • Detroit: 680 Antoinette St., TR 2-2600 • Houston: 4219 Richmond Ave., MO 7-3301 • Kansas City, Mo.: 106 W. 14th St., GR 1-2919 or GR 1-2920 • Los Angeles: 1010 S. Flower St., DU 1-3641 • Louisville: Bldg. 6, Appliance Pk., GL 4-7511 • Minneapolis: Plymouth Bldg., 6th & Hennepin, FE 2-7569 • New York: 122 E. 42nd St., PL 1-1311, Ext. 3205 • Philadelphia: 3 Penn Center Plaza, LO 8-1800 • Phoenix: Guaranty Bank Bldg., 3550 N. Central Ave., AM 4-3741-2 • Pittsburgh: 1634 Oliver Bldg., Mellon Sq., AT 1-6400, Ext. 566 • San Francisco: The Russ Bldg., 235 Montgomery St., DO 2-3740 • Schenectady: Bldg. 2, 1 River Rd., FR 4-2211, Ext. 5-4405 • Seattle: Dexter Horton Bldg., 710 Second Ave., MA 4-8300 • St. Louis: Paul Brown Bldg., 818 Olive St., GE 6-4343 • Syracuse: 1010 James St., GR 6-4411, Ext. 6141 or 6142 • Washington, D.C. Area: 7401 Wisconsin Ave., Suite 514, Bethesda, Maryland, OL 2-8100 • In Canada: Canadian General Electric Company, Ltd., Electronic Equipment and Tube Dept., 830 Lansdowne Avenue, Toronto, Ontario, Canada. **Outside U.S.A. and Canada:** Producer Goods, Export Dept., International General Electric Co. Division, 150 E. 42nd Street, New York City, New York, U.S.A.



General Electric—Pioneer in computer systems for all phases of business, industrial, scientific, engineering and financial endeavor.

*Progress Is Our Most Important Product*

**GENERAL ELECTRIC**

CIRCLE 13 ON READER CARD

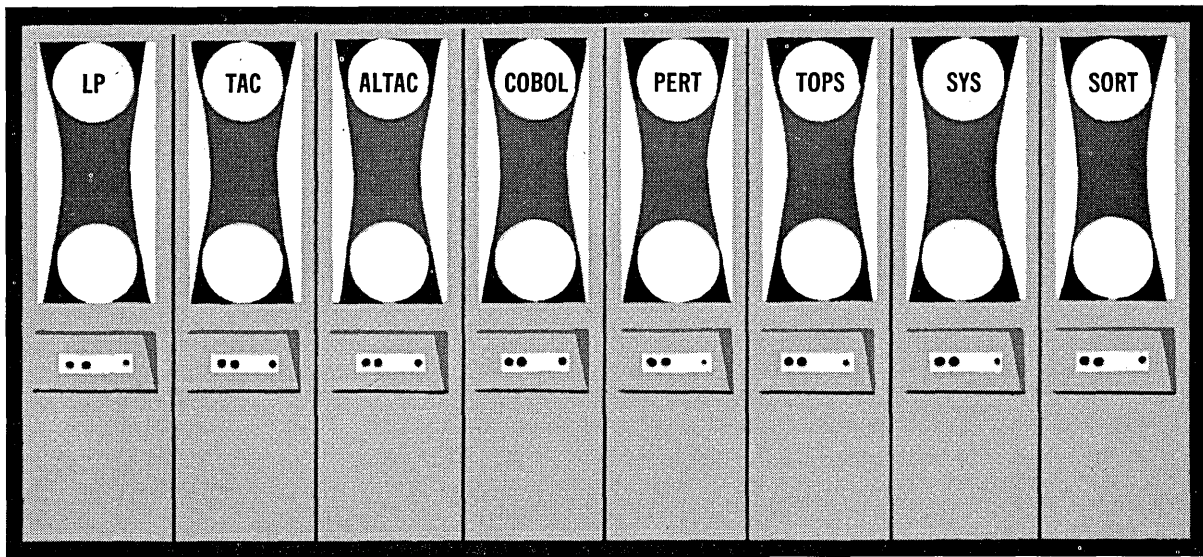

210-211-212

—2400

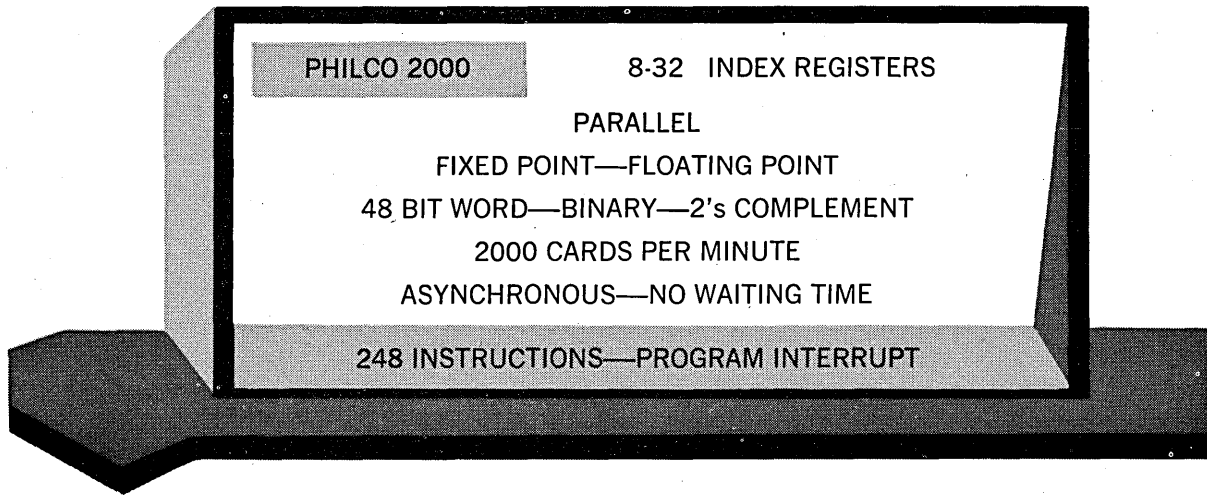

## COMPUTER PROGRAMMER OPPORTUNITIES

PHILCO is seeking genuinely creative scientists with the imagination and ability to venture well beyond the present state of the art in PROGRAMMING RESEARCH. Among the immediate, non-routine senior level assignments available are: **Linear Programming / Numerical Analysis / Operations Research / Problem Oriented Languages / Real-Time Data Handling Problems / Scientific Information Processing / Self-Monitoring Diagnostic Routines.** Positions in these vital fields offer an excellent opportunity for increased professional growth. Applied mathematicians and digital computer programmers having B.S., M.S. or Ph.D. degrees are invited to join our scientific staff. The development of such advanced programming techniques is a part of PHILCO COMPUTER DIVISION efforts to open new areas of computer applications. Stimulating opportunities also exist for Pre-Sales and Post-Sales System Analysis, Programming, Education, Technical Writing, Sales Representation and Field Engineering.

Please direct your inquiry to:  
 Mr. John Felos  
 Professional Placement Mgr.  
 Philco Computer Division  
 Willow Grove, Pennsylvania

# PHILCO



*Famous for Quality the World Over*®



CIRCLE 83 ON READER CARD

**DATAMATION**

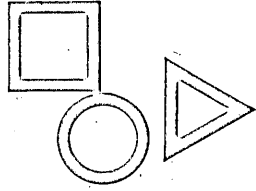

# EDITOR'S READOUT

---

## HOW TO CONSTRUCT

## AND MAINTAIN A LANGUAGE BARRIER

While the need for effective communication between computer people and their hardware has been repeatedly stressed, a basic and largely neglected prerequisite to constructive discussion is an increasing, inter-personal language barrier.

At an initial glance this subject may smack of an almost prosaic quality hardly meriting the interest of a scientifically disciplined profession. A brief exposition of the problem however, may help remove this obstruction.

First and despite a growing complex of technical problems, there is relatively minor concern for defining a massive list of undefined terms. For example, while compatibility of software has been a basic and recent goal, there is widespread misunderstanding as to precisely what is meant by "compatibility," or for that matter such fundamentals as "programming" as opposed to "coding," or "information processing" as opposed to "data processing," and how should one define "computer" as opposed to "system?" One logical conclusion which may be drawn from this muddle is that semantic engagements are sometimes preferred to a comprehensible expression of technical competency.

Secondly and because of recent explosive additions to the computing population, a sharp cleavage has arisen between venerable "pathfinders" and younger "followers." The tendency of the pathfinder to look disparagingly on the follower while the latter leans toward priestly worship of the former, diminishes effective criticism and understanding; the assumption being that what one doesn't understand must have substantial validity.

Finally, the most serious element of the problem has been the mounting number of both sincere and insincere charlatans, "fast buckers" or less congenially, "garbage mongers." Without a reasonably clear communications network, this group delights in perpetuating the language barrier. Its mouthings in the midst of a lack of standardized terminology are sometimes accepted by pathfinders as emanating from prospective members of the club and by followers, as plausible gospel.

Perhaps the most effective method for penetrating the inter-personal language barrier is an improved critical facility for recognizing its components and more specifically, how they are manifest in professional discourse. Following are a few of the elements essential to the construction and proper maintenance of a language barrier:

1. *The Mad Stillness.* As a negative reaction to a published paper or a verbal presentation, one variety of nervousness is characterized by the declaration, "What absurd stupidity! I can do it better, much better and I'm going to write something which will prove it. I'm going to make that idiot look exactly like

the fool he is. You can count on it, but right now I'm a little busy and anyway, I'll have to clear it with my boss and did you know my wife's pregnant? It'll be our fifth."

Unfortunately, muted anger is frequently viewed as implied intelligence. While there may be substance to the anger, insufficient motivation to express it publicly may be attributed more to a lack of reasonable support for the argument than to a fear of corporate reprisal. But don't discard the latter. It exists!

Nevertheless, bearers of *The Mad Stillness* contribute to the language barrier by the overt refusal to impede its construction.

2. *The Trail Blazer's Bookkeeper*. To implement the virtues of a proposal, a claim to authority by association is commonly expounded by the exclamation: "Prior to working for the Fizzle and Flop Consulting Service, I was connected with Eckert & Mauchly on the ENIAC project and before that, I corresponded intimately with Babbage."

Of course, association with the early history of computing may imply some genuine competence but the stress frequently placed on the historical aspects of one's credentials should encourage close inspection of more recent accomplishments. In this regard, it should be noted that the ranks of computing's founders have swelled substantially within the last year somewhat in proportion to the number of new firms entering the industry.

*The Trail Blazer's Bookkeeper* is a major factor in strengthening the foundations of a language barrier by attempting to reinforce a contribution with the mortar of pioneering authority.

3. *The Confirmation or Bar Mitzvah Paper*. Given the arduous chore of submitting his first paper for publication or presentation at a computer conference, the young writer generally leaps at one of two extremes. The first may be properly titled "Everything I Know About EDP" and within a tidy 1,000 words furnishes opinions on programmed teaching, numerical analysis, linear programming, asynchronous design and cryogenics.

At the introverted end of the spectrum, an intense offering is submitted on "How I Coded A Sine Routine" or "Square Roots Revisited." In this instance overly dedicated attention is provided to a contribution which may have its significance dwarfed by the limited interest of its audience.

In both cases an obvious middle ground could be found and competency demonstrated if overzealousness and timidity were better controlled. In the construction of a language barrier, the *Confirmation or Bar Mitzvah paper* provides the luke warm water necessary for mixing the mortar.

4. *The Royal Title and A Prince of an Abstract*. Occasionally, a title and abstract require a far longer period to prepare than the paper. This is excusable providing the author has not spent more time in this effort than on the research he describes. A suitable example: "How I Wrote A Compiler in Seven Short Weeks of Moonlighting" by Dr. Jack Fizzle, a former associate of Eckert & Mauchly on the ENIAC and countless other very impressive computing machines."

Dr. F.'s abstract: "The following 750-word paper not only describes precisely how I did it but also how I sold it to three computer manufacturers. Flow charts are included for illustration."

To apply the mortar in constructing a language barrier, *The Royal Title and A Prince of an Abstract* function well as handy trowels.

5. *Green Cheese On The Moon*. In October, DATAMATION encouraged its readers to critically weigh the balance between "Dreams & Dribble" (page 17). An important factor in evaluating the substance of a paper which broaches tomorrow's horizons is the implied statement: "Sure we're having problems running the payroll, but forget about that and let me tell you what it'll be like simulating the economic structure of Mars and Venus. Maybe we can give it a new name like interplaneteticsonicsing!"



At this juncture, it may be appropriate for the industry to call a moratorium on new phrases until some of the old ones are understood, accepted or properly disposed of. As an essential part of the language barrier, *Green Cheese On The Moon* is in fact, the very substance out of which solid, impenetrable brick is constructed.

6. *The Divorcee*. After departing from a previous employer, there appears to be a noteworthy tendency on the part of some ex's to disclose the frailties of their earlier relationship under the title: "What It Was Really Like Living With Nelly!" To carry the analogy further, one might question the duration of the marriage and if the circumstances surrounding the divorce proved of such a strain, why it endured as long as it did?

While Nelly stories are generally confined to the corridors of conference hotels and their veracity may not be entirely reliable, the audience is always eager to listen and tokens of compassion are liberally bestowed. Subsequently, it may be impossible to fairly evaluate the contribution of an important paper if its author represents a company previously treated to the rancor of the *Divorcee*. In fairness to the *Divorcee* however, it should be noted that normally at least a smidgen of truth can be uncovered in virtually all Nelly stories. Sometimes two smidgens.

The skill of *The Divorcee* is usually above average and given the mortar, brick and trowel, he is able to provide the labor necessary to see that the language barrier is efficiently constructed.

7. *Such Happiness*. Although the existence of sheer bliss in a computer shop is not very likely, there is a growing tendency to convey this impression in formal presentations. It is certainly understood that no one takes pleasure in detailing childhood illnesses or even the psychosomatic traumas of adulthood, however there is much to be said for occasional inclusion of a serious problem and its solution such as "How We Cut Our Downtime From 80 per cent to 79," or "Why we switched from COBOL to octal absolute!"

Once constructed, *Such Happiness* provides the glaze and garden under the wall of the language barrier which lulls the onlooker into passiveness and inaction. It is in fact, a charter member of the language barrier maintenance committee.

8. *The Product Pusher*. In the crass world where money is made by the sale of things, services and words, competition frequently encourages an entrepreneur to push his product a trifle harder than necessary. The following letter to an editor of a computing publication may serve to illustrate the point: "Dear Buddy, The boys here at Plastic Sewers, Inc., are working up a piece for your exclusive use on this terrific new vacuum tube which is smaller than a transistor. We're also submitting the article to one of the computer conferences under the title, "The First Generation Was Jake With Us." Let us know if you can use it old buddy, buddy, and by the way, the boys at the agency think a lot of your book and we're jacking up the ad schedule next year."

*The Product Pusher* stands guard against occasional intruders who seek to surmount the barrier. His function may be compared to broken glass at the top of a high wall or to the chairman of the maintenance committee.

The effectiveness of the above contributions in the construction and proper maintenance of a language barrier will vary with the abilities of audiences to recognize their glazed surfaces and to extract the real significance (if any) of a paper or presentation. This is not an easy task.

It may be implemented however, by perceptive expressions of criticism voiced publicly, privately and *consistently*. Apathy and timidity particularly from younger contributors can hardly impede further extensions of the barrier or improve individual competence and self respect. To this end, a considerable measure of backbone may be required.

BALGOL

BALGOL

BALGOL

BALGOL

BALGOL

# BALGOL AT STANFORD

**a fast compiler on a slow computer**

by BOB FOREST, Forest & Rolph,  
Consultants, Sierra Madre, Calif.

 On the console of the Burroughs 220 at the Stanford University Computation Center is a sign which reads: "The purpose of computing is insight, not numbers."

Despite this noble philosophy of Richard Hamming's, the Computation Center considers itself a problem-solving "factory," and although the goal of an efficient computing job shop is not an uncommon one, Computation Center Director George Forsythe feels that the Burroughs Algebraic Compiler (BALGOL) has allowed his center to achieve new lows in button-pushing.

Stanford's 220 has a 10K memory, five tape units, and a one-in, two-out Cardatron card-handling subsystem. The Computation Center also has a 650, which sees limited use by those familiar with its language and who want to spend the time programming it.

Pointing to the IN and OUT boxes outside the 220 room, Forsythe says, "This is our computing machine, as far as the students are concerned. That's all they need to know."

The compiling speeds of the one-pass BALGOL compiler—50 to 100 ALGOL statements per minute, which

generate an average of 500 machine-language instructions per minute—make it possible for the Center to run an average of about 120 BALGOL problems per working day, plus additional work. The top production figure for one day on BALGOL runs was 288 problems in 16 hours.

According to Forsythe, some large-scale computers—20 to 30 times as fast internally as the 220—take three times as long to compile using FORTRAN. This is partly because their FORTRAN compiler—for even the simplest programs—polishes and polishes . . . and thus requires two to three minutes for the simplest kind of problem.

FOR a computation center like Stanford's—interested in hundreds of problems a day—this is not the solution, says Forsythe. "Our goal," he adds, "is to convert every student at Stanford—get them out of the stone age and into the computing age."

The manner in which BALGOL has helped the Stanford Computation Center move towards this goal is reflected in the low "overhead"—18 seconds per problem. Of this, Forsythe points out, 11 seconds is for supervisory printout and could be eliminated.

BALGOL is described by Forsythe as something be-

tween ALGOL 58 and ALGOL 60: "It has most of the important ALGOL features and might be called ALGOL 59. Its language is rich and flexible—you are not limited in what you can say. Too, it has the capacity of easily enlarging itself—of defining new entities which are easily incorporated into the language."

Used with a "load-and-go" compiler, it features semi-automatic segmentation. This permits the main body of the program to become a master routine which controls operation sequence and the memory assignment of program segments.

Approximately 95% of the Stanford programs for the 20 are written in BALGOL, with the remainder mostly written in BLEAP, a symbolic assembly language.

Forsythe also points out that BALGOL is easy to teach. The Computation Center conducts 10-hour BALGOL programming courses which are offered in two-hour sessions over one school week. So far, about 10 such courses have been offered to some 300 students. The Computation Center also offered a special pre-school course to 50 members of the engineering faculty this fall.

BALGOL has also found its way into Math. 136, a general introduction to programming. For this course, Forsythe is using the 220 as a grading machine for problems written in BALGOL. To his program deck, the student adds a card which calls in a grader program from magnetic tape. The grader provides the data for each case in turn, to the student's program, which provides the solutions. The solutions are evaluated by the grader, which then summarizes the students' scores for all cases, and prints out comments. Students usually get two to three-hour service. "The computer is an ideal teaching machine," says Forsythe.

The grader program is based on that developed by Perlis and Van Zoeren at Carnegie Institute of Technology.

In addition to its use by students, BALGOL has played a key role in work being done by the members of the University's recently established Computer Science Division, of which Professor Forsythe is also the head.

Professor John G. Herriot of the Computer Science Division is using BALGOL in his work on the solution of boundary value problems by methods of kernel function. This involves a great deal of calculation . . . so much that Herriot considers the work impractical without computers and compilers such as BALGOL. Using the Burroughs compiler, he was able to do the analysis and programming over a period of three to four months, working on it part-time.

With the help of a graduate assistant, Herriot is also

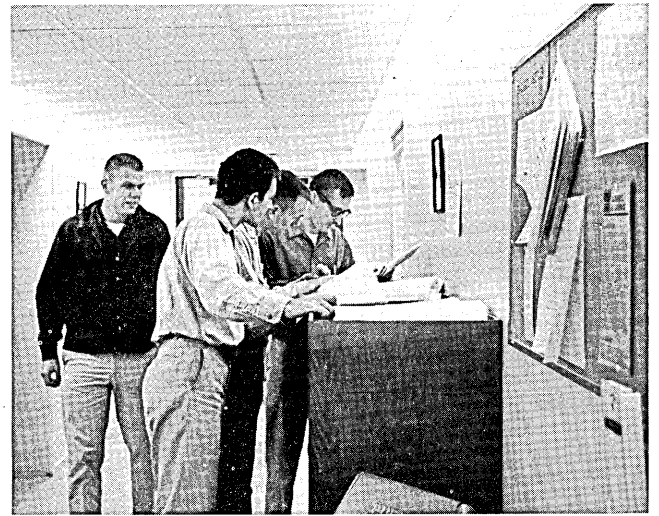

Students gather at their "computing machine" — the IN/OUT box at Stanford Computation Center. Students normally get two to three-hour service for their BALGOL problems.



Stanford Computer Science Division Director George E. Forsythe (l.), Assistant Director John G. Herriot, and programmer-analyst Jeanette Peters.

#### TEST COMPARISON\*

<u>Computer</u>	<u>Time to Compile</u>	<u>Time to Execute</u>
220 (BALGOL)	51 sec.	1100 sec.**
704 (MAD)	42 sec.	222 sec.
709 (FORTRAN)	182 sec.	94 sec.
7090 (FORTRAN)	79 sec.	29 sec.
2000 (ALTAC)	119 sec.	170 sec.

\*Program involved 61 cases of data.

\*\*220 add time is 185 microseconds.

using BALGOL in the solution of polynomial equations. They are investigating in particular, with Professor Hans Maehly, the Laguerre method of solving polynomial equations. Also, a BALGOL procedure has been written for solving differential equations by the Adams method. This incorporates an automatic change of step size and flexible output, permitting the printout of points at any desired interval.

Other work in progress includes finding particular solutions of more general partial differential equations than that of Laplace. "Here BALGOL has been especially helpful in translating equations to a program for the machine," says Herriot.

John Welsch, Alan Shaw and James Vandergraft of the Computation Center have prepared magnetic tape handling routines for use with BALGOL. These include external procedures for reading, searching and writing on mag tape, and give the programmer a much larger memory with which to work.

Welsch has completed a routine which allows a compiled program to be stored on magnetic tape for later running without recompiling. The Center has also developed an operating system which will allow programs to be compiled and run without operator intervention.

A great deal of work is also being done on matrix problems—inversion and the determining of eigenvalues for both symmetrical and non-symmetrical matrices. This work will be published in the language of ALGOL 60.

At one time, consideration was given to the possibility of a mechanical translation from BALGOL to ALGOL 60, but the translation is straight-forward enough so that this was deemed unnecessary.

The Computation Center is also active in assisting other academic departments in their use of the Burroughs 220. The Medical School's Department of Psychiatry uses the computer in connection with its study of the learning process, especially as it is affected by removal of parts of the brain. Equipment operated by monkeys controls paper tape punches, on which monkey responses are recorded. The paper tape serves as input to the 220, which maintains an updated record of all experiments on magnetic tape. Wade Cole of the Computation Center admits this is a "simple-minded" use of a computer, but says, "It's a beginning in a field which has seen very little sophisticated use of computers."



Chief of Operations Al Collins at the console of the Stanford Computation Center's Burroughs 220.

Working with Drs. J. G. Toole and J. von der Groeben of the Medical School's Department of Cardiology, Professor Forsythe has developed a program on the reduction of vector electrocardiograph data. Future medical school uses of the 220 include diagnosis, simulation, and on-line reduction of experimental data.

The Computation Center has also collaborated with the Mechanical Engineering department on the numerical solution of non-linear partial differential equations for the laminar flow of an incompressible fluid. The 220 is also performing data reduction for radio-telescope signals generated in the University's radio science laboratories.

Another data reduction task will involve the work of Alphonse Juilland of the department of Modern European Languages, in his studies of the relationships of the Romance Languages to Latin. Professor Juilland is investigating language structure from phonetic and lexicographical standpoints, and will use the computer to record and compare the basic structural units of some 500,000 words of given Romance languages.

Other uses of the 220 include a program being developed by Professor R. V. Oakford of Industrial Engineering for the optimal scheduling of high school classes, given the available classrooms, courses, sections, and the number of students. The social sciences also make frequent use of the 220 for various statistical work and data reduction.

Finally, the 220 is used on the third shift by the First National Bank of San Jose for 40 hours a week for demand deposit accounting.

According to Cole, "BALGOL has played a key role in permitting experts in various disciplines to communicate with the computer. It allows the problem sponsor to program the job himself in language with which he is familiar . . . and in the process helps remove the old communication barriers between the man with the problem and the man with the machine." Professor Forsythe adds, "BALGOL allows research to go on where it belongs."

Equally important, of course, is the high-volume efficiency it brings to the closed shop operations. "The real payoff," says Forsythe, "is the ability to compile programs rapidly and to take out the errors in the source language." This latter is accomplished by the compiler, which flags violations of the rules of the language, and lists them without interruption of the compiling process. Thus a "linguistically correct" program can usually be achieved in two or three compilations. It is also possible to detect logical and other programmer errors through the addition of temporary output statements, which are easily added or removed, since the program is normally recompiled every time it is run.

Additional monitoring facilities, dumps and traces have also been added to the compiler by Burroughs, which is bringing out a new edition this month.

For Chief of Operations Al Collins, the value of BALGOL can be directly measured in dollars. "The Burroughs Algebraic Compiler is worth \$10,000 a day," he says. The estimate is based on the fact that the 220 is in the compile mode four hours a day . . . at a compiling rate of 500 instructions a minute, this represents 120,000 commands a day.

"If only one out of five commands compiled is of value—and that's a conservative estimate—this represents 24,000 instructions, equivalent to the output of approximately 200 programmers, who represent a daily cost—including overhead—of \$10,000. Another way of looking at it is that BALGOL commands cost approximately 8¢ each, compared to \$8.00 a machine-language command."

"But no matter how you look at it," concludes Collins with a smile, "one thing is certain: a slow computer and a fast compiler have combined to make this one happy shop." ■

# MAD AT MICHIGAN

its function & features

by BRUCE W. ARDEN, BERNARD A. GALLER,  
and ROBERT M. GRAHAM, University of Michigan, Ann Arbor

The Michigan Algorithm Decoder (MAD), in operation since February, 1960, was developed for the specific purpose of training large numbers of university students and handling the large volume of university research problems. The primary motivation for writing this rapid translator may be traced directly to the special environment of a university computing center.

A large university should not operate its computing facility as a closed shop since the university's role is educational; moreover, it cannot operate in such a fashion since the users, students and staff, may number in the thousands. The computing implications of these facts are that large numbers of relative novices will have direct access to the machine. Like it or not, these users will work at the level of an algebraic source language—often making many compilations on programs which are not destined to become long-run production programs. What is required in this environment (which is not necessarily peculiar to universities) is an extremely rapid translator accepting a source language which has a minimum number of restrictions. MAD was written to fulfill these requirements. ALGOL 58 provided the basic pattern for the language and to the extent that ALGOL 58 is like ALGOL 60, MAD is an ALGOL translator. The design criteria were satisfactorily achieved although, undeniably, the permitted generality of expression reduced, in some instances, the object program efficiency as compared to that produced from restricted source languages.

MAD translators now exist on the IBM 704, 709, and 7090, and a recent compilation of 785 statements took one minute on the 7090, producing approximately 10,000 machine instructions. In another occasion, using the Bell Monitor System on the 7090, MAD compiled 84 programs in 20 minutes. (MAD is also available as part of the FORTRAN Monitor System.) The translator itself contains about 16,000 words, of which several hundred are diagnostic comments. Before we consider the reasons for the translation speed, we shall describe some of the features of the MAD language. Symbols consist of up to six alphanumeric characters, the first of which is a letter. Function names consist of a symbol and a terminating period, such as SIN., SQRT., and so on. Constants, as in FORTRAN, have such forms as 1.2E-3, .006, -1E7, etc., except that one may write the Boolean constants 1B and 0B (representing *true* and *false*, respectively), and alphabetic constants, such as \$ABC\$ or \$=\$ (up to six Hollerith characters enclosed in dollar signs). Arithmetic expressions are formed

in the usual way, using +, -, \*, /, .ABS., and .P., with the last two meaning "absolute value" and exponentiation, respectively. Also available are the relations <, ≤, =, ≠, >, and ≥, represented by .L., .LE., .E., .NE., .G., and .GE., respectively, and ^, V, ¬, ⊃, ≡, and exclusive or, represented by .AND., .OR., .NOT., .THEN., .EQV. and .EXOR., respectively. Thus, one might write the Boolean expression

X.P.3.L.Y.P.3.AND.I.NE.J.OR.X\*Y.G.1  
to represent the expression

$$X^3 < Y^3 \wedge I \neq J \vee XY > 1$$

The mode of arithmetic of each variable and function (floating point, integer, Boolean, etc.) is declared by exception. For example, in MADTRAN, the FORTRAN to MAD translator which was written in MAD, all variables were of integer mode, since Hollerith constants are also of integer mode. The statement

NORMAL MODE IS INTEGER

caused all variables to be integer, and if there had been any floating point variables, they would have been so declared. There also exist programs in which the normal mode is Boolean! Mixed expressions are allowed whenever ordinary mathematical notation would allow it.

Besides the ordinary substitution statement, which has the form

$$X = (-B + \text{SQRT.}(B*B-4.*A*C))/(2.*A)$$

there are many other statements. The most useful statements are the simple and compound conditionals and the two forms of the iteration statement. These are illustrated by the following:

(a) **The Simple Conditional**

WHENEVER I.G.J.AND.X.E.3, TRANSFER TO BETA(I)

(b) **The Compound Conditional**

WHENEVER I.G.J.AND.X.E.3

$$C(I) = B(J)$$

$$X = 2$$

TRANSFER TO BETA(I)

OR WHENEVER I.G.J.AND.X.E.2

$$C(I) = B(J) + X$$

$$X = X - 1$$

OTHERWISE

$$C(I) = B(J) - X$$
$$X = X - 1$$

END OF CONDITIONAL

(c) The Iteration Terminated by a Boolean Expression

THROUGH A, FOR I = BZERO, F.(I) - I,  
.ABS.F.(I) .L. EPSLON

This is interpreted as: Set I = BZERO, then test the Boolean expression .ABS.F.(I) .L. EPSLON. If *true*, the scope of the iteration is not executed at all. If *false*, it is executed, then I is incremented by F.(I)-I (in effect, I is replaced by F.(I) in this example) and the Boolean expression is tested again.

(d) The Range of Values Iteration

THROUGH A, FOR VALUES OF Q = 50, 25, 10, 5, 1

In this case the scope is executed for each of the listed values (which could be arbitrary expressions) in turn.

While the dimension statement in MAD causes a fixed block of storage to be set aside for each array, the number of dimensions (i.e., the number of subscripts), the range of each subscript, and the base point of the array within the block are stored as ordinary values of a vector and may all be modified or set during execution. Format information, similar in form to that used in FORTRAN, can likewise be modified or set at execution time. On the other hand, all of this information may be pre-set by a general declarative statement which can pre-set values of any array or vector. Input-output statements which make use of a symbol table and require no format information, such as

READ DATA

have recently been added to the 709/7090 version, as well as the ability to define new operations into the language.

There are also facilities for defining internal or external functions. The latter correspond to the FORTRAN *subroutine*, while the former are similar to the ALGOL *procedure*, in that they are defined within the body of the calling program and variables not listed as arguments are common to both programs. It is possible to define recursive functions, also, and still other statements provide a *push-down list* mechanism. While multiple subscripting is handled by a set of standard subroutines, the user may provide his own storage function for each array, if he chooses, by designating the name of the new function. This function, whose definition program may be written in MAD, may then allow one to store one-half of a symmetric or upper triangular array, only non-zero entries, etc.

There are many other features in MAD, such as the EQUIVALENCE, ERASABLE, and PROGRAM COMMON declarations, and so on, but let us return to the question of the reason for the speed of translation. Probably the greatest single factor in this speed is the minimization of the use of the magnetic tapes. In the 709/7090 version, programs containing under 200 statements require no tape movement other than reading the source program from the input tape and writing the translated object program onto the output tapes. (The MAD translator is itself one record on the master tape.) Longer programs require intermediate tape storage, but in a highly buffered way. Another factor is the internal structure of the translator, with a heavy dependence on just a few tables of information. Also the statement structure is such that statement types are discernable without an analytic scan. A final and, perhaps, second order reason is that the group writing the translator was small—three people. As a result the intra-group communication was good, and the program inefficiencies which are so often introduced in developing large,

group-effort programs were held to a minimum. The writing of the 704 MAD translator took 2 man-years, and the rewriting for the 709/7090 took about 3 man-months.

The use of this translator has made it possible to assign rather formidable problems to students. In a one-semester course assuming no computer experience, the following problems have been assigned (each one as the last problem in a different semester). (1) Symbolic differentiation, (2) An interpretive program for a simplified MAD-like language, (3) An assembly program for a language much like FAP for the 709/7090, (4) The complete scan and decomposition of arithmetic expressions from MAD. Usually 30-50% of the 100 or more students in the course have the program checked out by the end of the semester. The following is a portion of a solution to the analytic differentiation problem. It deals with the input expression, and might be found in any of the problems described above. It is included here to illustrate some of the symbol manipulation features of the language. Problems involving evaluation of algebraic expressions would appear much more conventional than this.

```
R FUNCTION CONST. THIS BOOLEAN
FUNCTION
R RETURNS A VALUE OF 1B (TRUE)
IF ITS ARGUMENT IS
R INCLUDED IN THE SET OF CONSTANTS
0-9,A-Z (except X)
R AND 0B (FALSE) OTHERWISE.
INTERNAL FUNCTION (Z)
BOOLEAN CONST.
ENTRY TO CONST.
SCON1 THROUGH SCON1, FOR B =
1, 1, Z.E. TAB(B) .OR. B.E. 36
WHENEVER B .L. 36
FUNCTION RETURN 1B
OTHERWISE
FUNCTION RETURN 0B
END OF CONDITIONAL
END OF FUNCTION
VECTOR VALUES TAB(1)=$0$,$1$,$2$,$3$,
$4$,$5$,$6$,$7$,$8$,$9$,
$A$,$B$,$C$,$D$,$E$,$F$,$G$,$H$,$I$,
$J$,$K$,$L$,$M$,$N$,
2 $O$,$P$,$Q$,$R$,$S$,$T$,$U$,$V$,$W$,
$Y$,$Z$,
R FUNCTION P. THIS FUNCTION ASSIGNS A
R PRECEDENCE VALUE TO THE OPERATORS.
INTERNAL FUNCTION (Z)
ENTRY TO P.
WHENEVER Z .E. $.P.$
PREC=8
OR WHENEVER Z .E. $-U$
PREC=7
OR WHENEVER Z .E. $/$ .OR. Z .E. $*$
PREC=6
OR WHENEVER Z .E. $-$ .OR. Z .E. $+$
PREC=5
OR WHENEVER Z .E. RTEND .OR. Z .E. LFTEND
PREC=4
OTHERWISE
PREC=3
END OF CONDITIONAL
FUNCTION RETURN PREC
END OF FUNCTION
```

# BASIC ALGOL

a close-up of  
some clear-cut advantages

by DANIEL D. McCracken, McCracken Assoc.,  
Ossining, N.Y.



"ALGOL will collapse of its own weight in a year or two. It's nothing but an intellectual exercise for recursive procedure theorists." So said an acquaintance a while ago, and I suspect he speaks for a great many computing people.

I think it's time somebody spoke up for the power of ALGOL in doing "ordinary" programming—the kind of

work in which recursive definition, "own" variables, and call-by-name seldom arise. The value of such "advanced" features of ALGOL should not be minimized, but neither should it be thought that until one understands these aspects thoroughly (a supposedly hopeless task), no use can be made of the language. In refutation of this position, let me list some obvious points of superiority of ALGOL over, say, FORTRAN, in doing *simple* calculations.

(FORTRAN is chosen for comparison simply because it is the most widely used scientific programming language, and thus provides a good frame of reference.)

1. Variable naming is easier: you don't have to worry about the IJKLMNOP business or the restriction to six characters.

2. Constants are simpler to write: no more recompilations because you forgot to write a floating point 2 with a decimal point.

3. Conditional expressions are much more powerful. Instead of the extremely restricted format of the FORTRAN IF statement, you can write any Boolean expression, and there are other flexibilities available if you want to use them. It takes no great effort to devise realistic examples of tests that take a half-dozen statements in FORTRAN and one in ALGOL.

4. ALGOL offers great power and flexibility in writing loops, at no great penalty in difficulty of learning. If you want to execute a loop for several values of a parameter, you can simply list them. In the form of the ALGOL "for" statement that most closely corresponds to the FORTRAN DO statement, the three parameters can be any expression, rather than "a single unsigned fixed point constant or variable." This one thing alone would take dozens of statements out of some FORTRAN programs. Another variation allows continued execution of a loop as long as a Boolean expression is still true.

5. Subscripting capabilities in ALGOL are more flexible and powerful. FORTRAN, for instance, will accept the subscript  $2 * N - 3$ , but reject  $N * 2 - 3$ . ALGOL has no such annoyances; a subscript can be any expression, and that's that. Furthermore, the lower bound of a subscript

is not restricted to the integer *one*, and array sizes can be established at execution time.

6. Compilers will be faster, I am told. The speed of the Burroughs Algebraic Compiler for the 220 and of MAD, both of which are more like ALGOL than FORTRAN, would seem to bear out the contention.

Other points could be listed, but these should demonstrate that there is a lot to be said for ALGOL besides the power of the advanced features. It may also be noted that this list contains nothing that is particularly difficult to learn. In fact, learning is easier in many particulars, because you don't have to keep track of a lot of bothersome little restrictions.

It is interesting to speculate on the origin of the myth of ALGOL's abstruseness, for which I suggest three reasons. First, the report in the ACM *Communications* of May, 1960, is excellent for its intended purpose of defining the language; but somewhat lacking when viewed as a beginner's primer. I assume I am not the only one who spent twenty minutes on the report and promptly gave up on ALGOL because I thought it would be more trouble to learn than it was worth. (I assume I am also not the only one who found that the report is not all that difficult, once I took the trouble to learn the notation.)

Second, most of the published discussion of ALGOL has centered around the advanced features, which is entirely reasonable, but misleading. It is only natural that those who are concerned with the development of advanced computer languages should spend their time on the difficult things, after noting that the "simple" advantages of the type listed above would be relatively easy to accomplish. But this sort of discussion leaves those of us on the fringes with the entirely mistaken impression that ALGOL consists only of the difficult things.

Third, the algorithms published in the *Communications* are slow going for some of us *because the problems they solve* are slow going for some of us. I for one don't know off-hand how a Riccati-Bessel function differs from a plain Bessel function; of course I'm not going to get much out of a casual reading of an algorithm to compute a Riccati-Bessel function—no matter *what* the language. Once again, this is proper, but misleading. There is not too much point in publishing algorithms to do "ordinary" things, which can obviously be done fairly easily in any language. But in the process of exhibiting how ALGOL can be used for difficult problems, some of us got the impression that that was the whole story.

In summary, it appears to me that ALGOL offers clear-cut advantages to anyone doing scientific computing, whether or not the application requires use of the more advanced features of the language. These features may very well turn out to be major advances in the computing art; in the meantime, there is no need to wait for the dust to settle before making use of the "simple" advantages.

It's time for some of us to take a fresh look. ■

Generation of appropriate command structures has long been a problem when designing a new computer, due to the manifold possible applications of any given system. The purpose of this paper is to describe an approach to the formulation of such command structures.

# MESO-PROGRAMMING

A new approach to "most" problems

by R. L. HOOPER and L. A. RAPHAEL,  
Packard Bell Computer Corp., Los Angeles

Historically speaking, computer instruction sets have been designated by engineers who are not user-oriented. Recently, special instruction sets (micro-programming, macro-programming, stored logic, etc.) have been copied into hardware from the seminal conceptions of compiler designers. However, the "final solution" to the computer language problem has not yet been realized, to our knowledge. But we feel that Meso-Programming does offer, in fact, a final solution.

The Meso-Programming approach has been used successfully in the construction of assemblers, compilers, interpreters, real time process control systems, operating systems, data processing problems, and even maintenance routines. Both ALGOL and COBOL are immediately expressible in an appropriate Meso-dialect. Some authorities feel that the Meso-Programming approach may be the "Esperanto" of the computing industry, by providing a language common to all computers.

Such a common language may be immediately generated from a suitable self-orientable P.O.L. Here it has been found that associative memory techniques such as pushdown lists and threaded list structures lend themselves to the solution of the dynamic allocation problem common to all multistage processors. A simple intuitive justification can be demonstrated by some of the more common mathematical tools found in Operations Research (hereafter referred to as O.R.), e.g., dynamic programming. Statistical investigations involving the use of the maximum likelihood function result in a reduction to an equivalent form and in an equivalent approach. This equivalence is independent of the use of either scope delimiting or polish suffix forms.

Heuristic considerations indicate that recursive types of problems (characteristic of all definable finite algorithms) can be solved by a relatively compact Meso-set. Meso-sets in general operate in a deterministic fashion on the more frequently used computer components. The Meso instruction set includes a wide range of operations, including such post hoc ones as character setting and resetting, data transfers, and multi-channel priority scheduling. Extensive bit handling is possible through the selection of a canonical Meso-set. Further, the handling of such meta-operators as may appear in linguistic strings is also facili-

tated by the choice of an appropriate Meso-set. In intra-system echelons, control can be greatly simplified over the conventional polymorphic-stored logic approach.

The field of numerical analysis has not remained untouched. Consultants from several universities have considered the applicability of Meso-Programming to some classical problems facing the computer industry. More eloquent solutions were found in the field of statistics (multiple regression analysis, probability sample design, latin squares, et al.), theorem proving in both Euclidean and non-Euclidean geometries, engineering analyses requiring the use of covariant Riemann-Christoffel curvature tensors, residue quadratures for evaluating complex integrals, and functional analysis investigations in both Banach and Hilbert Hausdorff spaces.

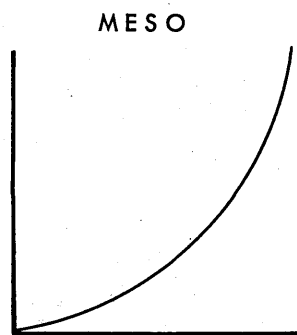

Figure 1

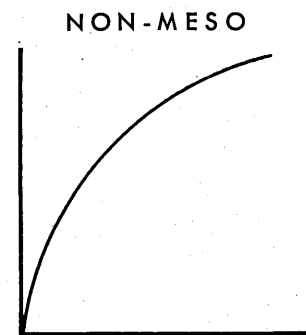

Figure 2

In summary, an analysis has shown that Meso-Programming (machine language coding) is adequate to solve most problems, where "most problems" is defined to mean any problem capable of being solved on a digital computer. ■

## REFERENCES:

1. Pelta, H. N. "Selfcipher: Programming," *Comm. Assoc. Comp. Mach.* 3, No. 6 (1960), 83.
2. Rand Corp. *Million Random Digits with 10,000 Normal Deviates*, 1955, Free Press.



# Critical path programs drawn in milliseconds!

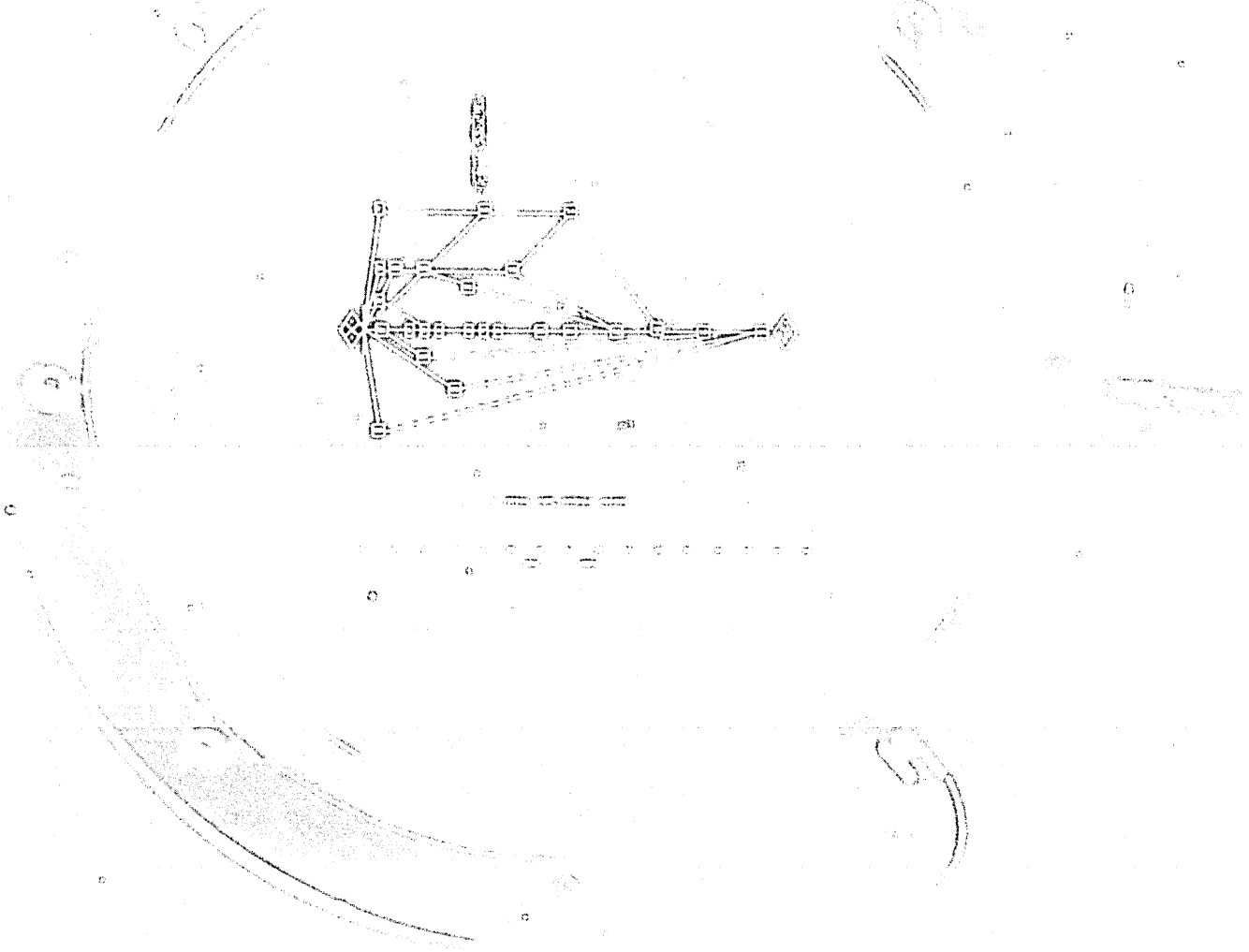

Typical critical path scheduling network on face of CHARACTRON® Shaped-Beam Tube, heart of the SC-4020.

GENERAL DYNAMICS | ELECTRONICS (  ) SAN DIEGO

CIRCLE 15 ON READER CARD

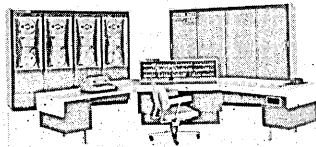

# HOW TO MAKE MONEY IN COMPUTING

## a corporate profile of Control Data

based on an interview with CDC President BILL NORRIS  
by HAROLD BERGSTEIN, Editor

What makes Control Data tick, hum, hop, run and sell computers? More important, how does this four-year-old Minneapolis firm make money at it?

Most obvious are reasons why this clearly *shouldn't* be the case: 1) with one prominent exception, no one else is making money; 2) the firm's initial cash assets consisted of slightly less than a shoe string (\$19,000 as of July, 1957); 3) its present hardware (160, 160A and 1604) offer a potential user no "breakthrough" advantages over competitive equipment, and 4) the competition has an abundance of financial support.

Less obvious and highly speculative are reasons for CDC's success:

1. an overriding necessity for producing a profit since losses remotely comparable to its competition would place CDC squarely out of business;

2. a heavy reliance on existing design (as opposed to large R&D expenditures) which reduces the price of its hardware;

3. a concentrated effort on a single segment of the market; namely, sophisticated scientific users who are sometimes able to separate the virtues of equipment from advertising claims;

4. the foresight, horse sense, or whatever the particular quality may be labelled to stride directly into the large scale market with the 1604, and

5. the ability to accomplish all of this in the beginning with a comparatively tidy handful of ex-RemRanders.

Having made a small but profitable dent in the market on the basis of what some have claimed as experience gained at the expense of another management, the obvious question asked by CDC's critics is, "What next?"

Promising and impressive for the near future are initial specifications on the giant 6600 (see DATAMATION, p. 13, May, 1961), particularly when the outcome of STRETCH and LARC installations have chased several major contenders far away from the monster marketing scene.

In addition to the 6600, CDC will probably concentrate on filling two or three gaps between the 160A and 6600. The 924 which falls mid-way between the 160A and 1604 is currently in production and has been delivered but as yet, remains unannounced. However, some speculators feel that the next CDC entry will fall between the 7090 and LARC and that the 924 will not be announced until a management decision is reached on a specific area within business edp in which to market the machine.

Unlikely are any entries below the 160A-class or a CDC "breakthrough" into the third generation. Most likely, the company will maintain an active r&d effort in thin film and tunnel diodes to obtain a capability for nanosecond hardware without physically developing such equipment until pathways into the next generation are more clearly defined.

Peripheral gear which heretofore has been purchased from suppliers, will experience a far greater home-

grown flavor in such areas as printers, tape drives and in facilities for high speed data transmission.

And for a company which began its operations by selling hardware a la carte (without software), the need for adequate support in this area has been clearly felt and within a year, the present 60-man programming effort is expected to double. FORTRAN has been CDC's mainstay designed to take advantage of the numerous problems already written in this language, and COBOL development is currently underway.

One effective key to both its sales and development

efforts is what CDC's management refers to as its "family plan." For an installation of a 1604 for example, a small team of engineers and technicians stick with a single machine until it is on the air at a customer's site. One primary result: responsibility is clearly focused.

For a closer view of Control Data's present posture and expectations, DATAMATION recently visited with the firm's president and founder, William C. Norris. To this end, the following taped interview should serve as a palatable illumination. □

Q. Mr. Norris, isn't the STRETCH-class 6600 which CDC is currently developing, an unusually large step for a comparatively small company?

A. Yes, it is rather a large step. On the other hand, compared to our size four years ago, the 1604 was a giant step, so that things are all relative in this world and I don't think the 6600 is any greater a step than the 1604 was at the time that was taken.

Q. Do you consider the 6600 larger than a STRETCH in power and size?

A. Yes. We wouldn't bring it out if it weren't larger.

Q. When will you make a formal announcement of this machine?

A. As yet the specifications have not been frozen and there are no contracts officially in the house. When we know precisely what our plans are, we'll announce it.

Q. How large a potential market do you project for a machine of this size?

A. We really don't have any good way of knowing this. We're a small company and we feel that while the market is big to us, it still may be very small to a big company. I think it's a little too early to know.

One of the big motivations in Control Data is what our people want to do and some of them at least, are very much interested in the giant class of computers. I wouldn't minimize this factor. In addition, we have sufficient faith in the growth of computing requirements to go into this market.

Q. In the medium-priced field, the 924 is presently in production and we understand there have been several installations. Will the 924 become CDC's first entry in business data processing?

A. I honestly don't know what my plans are going to be with the 924. We built this machine with the idea of looking into the business market and eventually we will go into it. However, I don't really know if this is the machine or the time. We're not trying to be coy about it. We want to make the right decision and there's a big market in this area. The 924 itself may be perfectly fine, but it's got to be related to other things that we're doing, and one of Control Data's problems is not to grow too fast.

Q. But the company certainly has experienced a phenomenal growth. What factors do you attribute to CDC's success?

A. Perhaps the most important one is planning. We spend more time on planning an undertaking than on any other single thing. Another important factor is our

conservative accounting. We have been charging off all of our research and development costs as we incur them. In addition, we depreciate our leased equipment on a four year, double declining basis. This means that along with some other conservative accounting practices we face today's problems today and we don't defer them for five or ten years.

Q. An opinion not uncommon in the industry is that there must be some unique aspect to CDC's management policies since most other computer manufacturers have experienced considerable difficulty in obtaining a profit. Is this true?

A. There isn't anything unique in Control Data. I would say that the biggest difficulty some of the companies have had is their inability to get a plan and to carry through on it in a reasonable length of time. So many companies have to bring 50 people at all levels of management into the matter of making a decision. By the time they get all these fellows either subdued, cajoled or however they do it, somebody else has done it.



Q. Earlier this year it was reported that a stipulation was signed stating that Sperry Rand would not interfere with CDC's use of alleged trade secrets in work on government contracts. Has this eliminated any further claims for financial retribution by Sperry Rand?

A. From a practical point of view, I believe it did. I don't see how you have the right to use something

- in an unrestricted manner and have somebody come along later and say you've got to pay for it.
- Q. When CDC first began to sell the 1604, hardware was being sold à la carte (without software). Recently, there has been a very definite shift in emphasis. Would you comment on this change?
- A. Emphasis on software has been necessary simply to expand our market. As time goes on we will be adding other software packages to further expand the market.
- Q. Would Control Data accept a software penalty clause in a contract for hardware delivery?
- A. I presume so although I have never been very keen on penalty clauses. On the other hand, we have had contracts with this provision. To answer the question the other way around, I couldn't basically object because the company in the first instance, wouldn't want to deliver a piece of equipment without adequate software since it's been well proven that this is the best way to get yourself a lot of dissatisfied customers.
- Q. What is your feeling about following in the footsteps of a competitor such as IBM in the development of software?
- A. It is perfectly satisfactory to us if IBM sets the standards in software development. We would just as soon have their standards as government standards, as long as there is a standard.
- Q. What future areas of growth do you foresee for Control Data?
- A. I think there's a growing market in what we call the large computer class which is the 1604 and computers above and below it in a narrow range . . . While the medium size computer field has opportunities, I believe this is the most competitive part of the market and another reason why we have left it for a little later consideration. However, we do intend to go into it on a carefully selected market by market basis.

- Some business applications are presently plagued by a great many details that one has to cover which are not present in the scientific and engineering fields. Because of this factor, progress in the banking industry and retailing field has been extremely slow and it is difficult to predict future growth. Of course, with the U. S. government behind the engineering and science in the country and the tremendous effort that has got to be made, this area is obviously going to grow.
- Q. What about process control? Control Data has its 8000 series which has received very little public attention.
- A. I think process control is going to be an exceedingly important part of our business. Again, we follow a conservative policy of being sure we have the answer before we blow the horn. There have been a large number of false steps made and I know one company who has put out equipment which just doesn't work. It's one of the major companies in the U. S. They did not follow experience that has been proven in the computer industry and as a consequence are being forced into a redesign. We are moving very slowly but surely and you *will* hear about the 8000.
- Q. What is your attitude toward price competition currently evident in process control and attributable to the fact that certain firms would like to obtain early recognition in this field?
- A. Anybody that wants to buy business can have it. This is something that Control Data won't do and any company who does it is just plain foolish.
- Q. Could this price competition be one of the reasons for Control Data's slow movement into this field; a sort of waiting period until the prices stabilize at a more realistic level?
- A. No! We quote our price which we consider reasonable and stick with it; in fact, we are offering maintenance service and other service considerations in the sale

### A CDC BOX SCORE

	July, 1957	1958	1959	1960	1961
Cash Assets	\$19,000	\$85,910	\$379,981	\$764,195	\$677,101
Total Assets	\$25,000	\$1,223,311	\$2,373,779	\$7,877,803	\$18,949,407
Net Sales	....	\$785,823	\$4,588,174	\$9,665,290	\$19,783,745
Net profit (or loss) after taxes	....	(\$192,023)	\$283,214	\$551,712	\$842,524
Total Employees	4	260	380	690	1,350
Professional Employees	3	24	100	269	561
Common Stockholders	....	690	2,510	4,579	8,180
Common Stock Low Bid	\$.33	\$.96	\$3.17	\$9.17	\$20.92
High Bid	\$1.08	\$3.33	\$11.25	\$23.17	\$44.00
Shares of Stock Outstanding (Relative to 3-for-1 split)	1,800,000 offered	1,995,000	2,354,250	2,905,569	3,360,339

July 8, 1957 - Date of incorporation

October 1, 1957 - Laboratory work began on 1604

November 25, 1957 - Ceder Engineering acquired

June 27, 1958 - First order for 1604

April 1, 1960 - Control Corp. acquired

Sept. 20, 1961 - Three-for-One stock split.

of control equipment and because of this, our prices are the highest in the process control industry.

- Q. What is your position in seeking further mergers for CDC?
- A. We will probably be interested in picking up companies who are producing peripheral gear such as printers, card readers, tape punches, etc.
- Q. May we assume that your present thinking is toward solidifying your resources for I/O equipment rather than increasing a reliance on suppliers?
- A. This is correct. However, I will add that we are very happy to rely on suppliers who are able to furnish us equipment at a reasonable price with suitable quality, but in many instances we have not been able to obtain this.
- Q. There have been very few overt statements from CDC concerning the third generation of computers. Speculation has it that you are not going to lead the field in this area but when the third generation does arrive you will see what is brought out and join the field.
- A. No, I wouldn't agree with your statement. I think there is a lot of baloney being passed out in connection with third generation computers and for that reason we don't think there's anyone right now who can pick cryogenics, tunnel diodes, thin films, or what have you.
- Q. When do you believe the third generation computer will appear?
- A. I have a feeling that we're going to slide into the third generation and someday you'll have to look back a few years to say when it was that you got there. I don't think there's going to be any dramatic overnight changes.
- Q. Are there any technological developments from your special purpose government work that have commercial possibilities?
- A. There's no direct application in a one-for-one exchange. However, the Polaris project, for example, has a very sophisticated control computer, much more sophisticated than you need in industry for most applications, but the knowledge which is gained there is certainly useful.

Q. What were the reasons for your recent three-for-one stock split?

- A. Many of the people who trade in the stock were unhappy because of the price fluctuations. They felt this came about because of the limited supply of the stock and the thought was that if the supply was increased the market would tend to stabilize. Although stockholders like a stock split, you can prove mathematically that it doesn't mean a thing.
- Q. A final question, Mr. Norris: what rank or position do you feel Control Data holds in the computing industry as far as sales volume is concerned?
- A. I'll be conservative and say sixth. ■

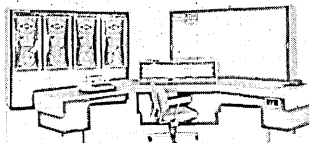

William C. Norris was elected president of Control Data on July 29, 1957. He was formerly vice president of Sperry Rand and general manager of its RemRand Univac Division. In 1946, he was appointed vice president and was one of the founders of Engineering Research Assoc. During the war years he worked for the Navy in r&d and earlier was employed by Westinghouse for seven years.

## NEXT MONTH IN DATAMATION: "OUTLOOK FOR 1962"

Unusual in virtually every respect, DATAMATION'S January issue will feature no features. Instead, the entire issue will be devoted to the theme "Outlook for 1962," and will present a series of concise commentaries from authorities in every major aspect of computing projecting the state-of-the-art (as they view it) for the coming year.

Some examples: Willis Ware on the role of AFIPS; Press Eckert on hardware; D. D. McCracken on software; Charles Phillips on the government's posture; Frank Wagner on new scientific applications; Burt Grad on business edp; Don Madden on the population problem; George Vosatka on the changing role of the consultant; Dick Clipping on standards; Dean Wanlass on the military scene; Ike Auerbach on computing abroad; Herbert Teager on computing at the university, and Fred Gruenberger on computing in secondary education.

Not to depart entirely from our current format, DATA-

MATION will also present its regular, not-so-usual departments, keying them however, toward events in the offing for '62.

## A NEW ADVISOR

DATAMATION is pleased to announce the third addition to our staff of Editorial Advisors: ROBERT L. PATRICK. Well known for his disquieting nature and impressive technical competence, Bob Patrick has been a proficient DATAMATION contributor for several years, and is presently a free lance consultant in Northridge, California.

Among his earlier activities, Patrick was employed at Convair Ft. Worth as an astrophysics engineer and programmer; at General Motors as a senior research engineer; at C-E-I-R as deputy director of computer services in Washington, and at Computer Sciences as project director for the FACT compiler. ■

# YOUR business will benefit with NCR Data Processing!

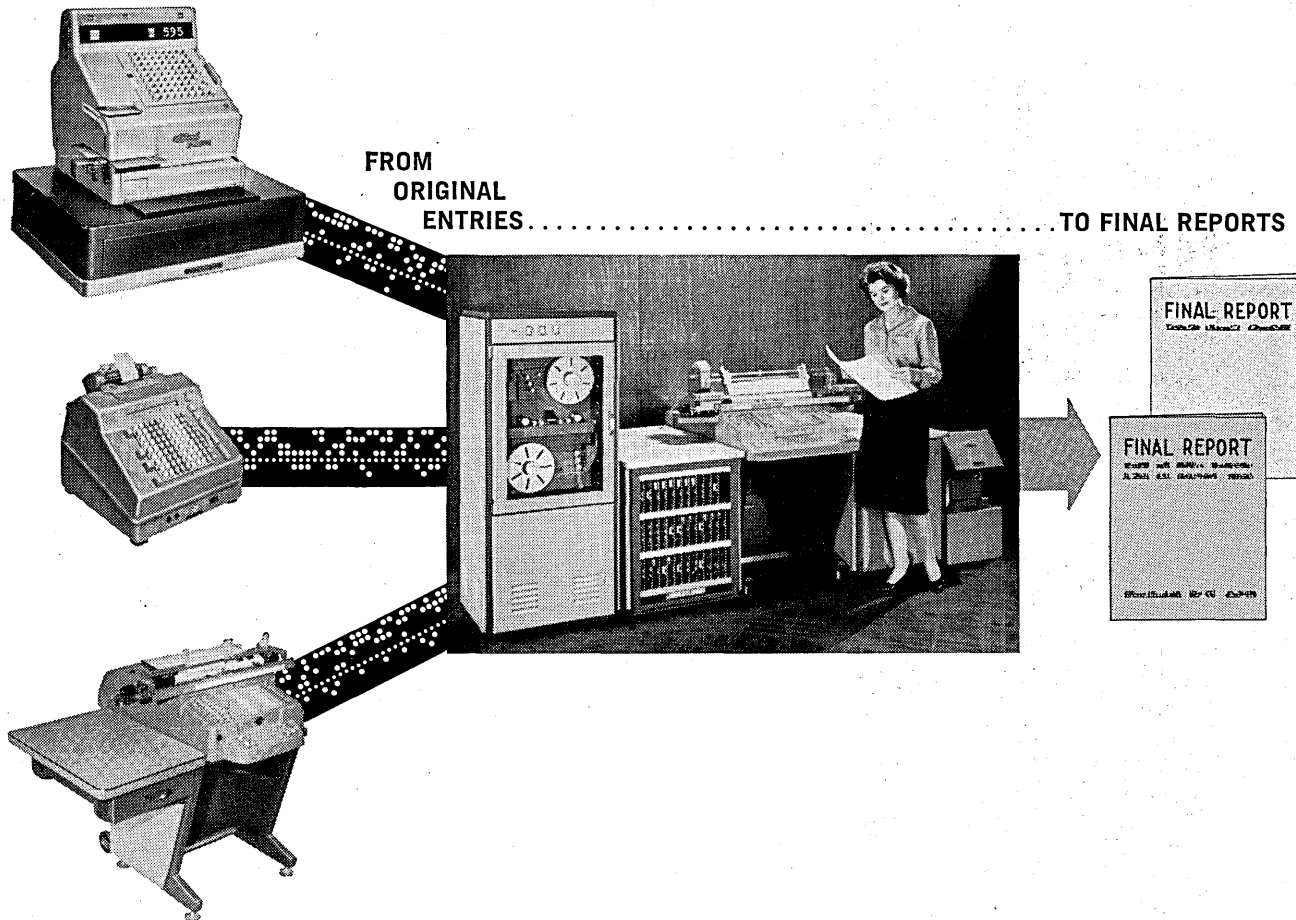

Regardless of the type or size of your business, you will benefit from the efficiencies of National Data Processing. From one or more of NCR's original entry products—accounting machines, cash registers, listing, window posting and receipting systems—you can get just the input media of your need and choice. This may be punched paper tape or punched cards.

This input media is processed quickly, accurately and economically by an NCR computer specifically designed to furnish complete record information tailored to your specific needs. NCR offers a full range of Data Processing Systems: small, medium, and large-scale computers, plus a network of processing centers.

For more complete information on

how NCR Data Processing can benefit your business, call your local National Branch Office or WRITE TO US TODAY!

**NCR** TRADEMARK—REG. U.S. PAT. OFF.  
*National*

ELECTRONIC DATA PROCESSING  
 ADDING MACHINES • CASH REGISTERS  
 ACCOUNTING MACHINES  
 NCR PAPER (NO CARBON REQUIRED)

**NCR GOES ALL THE WAY FROM ORIGINAL ENTRIES TO FINAL REPORTS.**  
 THE NATIONAL CASH REGISTER COMPANY, Dayton 9, Ohio  
 1039 OFFICES IN 121 COUNTRIES • 77 YEARS OF HELPING BUSINESS SAVE MONEY

1  
Microsecond

MEMORY\*  
MODULES!

\*STANDARDIZED

Now available from Daystrom as standard units, these 1  $\mu$ sec modularized core memories permit manufacturers of digital machines to eliminate expensive component development. The modules offer design flexibility never before available to computer engineers. Full read-write cycle time for the modules is 1  $\mu$ sec or less, and access time is typically 0.5  $\mu$ sec. The standard memory has a capacity of 1024 words, 50 bits to the word, and can be expanded in multiples of this capacity up to 4096 words and 200 bits per word. Components are stacked to give high package density. Only two different voltages...+20V and -20V... are required, and the full driving current is only 360ma. All solid-state and highly reliable, the standardized modules reflect Daystrom Military Electronics Division's extensive experience with MIL memories and circuitry such as the NORC and 465L systems. Send for technical data.



**DAYSTROM**, INCORPORATED

MILITARY ELECTRONICS DIVISION

ARCHBALD, PENNSYLVANIA • JERMYN 876-1500

# FROM CODE CARD TO PUNCH TAPE

**Systematics' converter performs a double function**

Incompatible paper tape and punched card coding systems for input/output equipment are currently posing serious problems for computer users who attempt to combine different machines into integrated systems. Although some efforts to standardize codes and improve media handling capabilities of data conversion systems have been initiated, the use of a converter is one solution frequently applied.

Systematics division of General Instrument Corp., Hawthorne Calif., has recently introduced a code card-to-tape converter, model K-177. This converter may be attached to any IBM 024 or 026 card punch and permits the unit to perform both as a keypunch and as a card-to-tape converter. The code tape punch perforates 5,6,7 or 8-channel tape of any code structure and any width from 11/16-1" at a speed of 15 cps.

The K-177 consists, essentially, of three components: a control module clamped to the left end of the IBM card-punch unit; a portable, cable-connected paper tape punch, and a removable programming plugboard which controls the output tape code configuration as well as customary card-to-tape programming functions. Using the 024 or 026

as card readers, the system accepts cards punched with non-Hollerith as well as conventional codes.

In one installation the K-177 is utilized as standard tape preparation equipment for the astro-inertial guidance system of the Skybolt GAM-87 air-launched missile, a priority defense project of Nortronics.

Since the guidance system of the missile incorporates a pre-launch computer (PLC), development and testing of the PLC requires the processing capabilities of at least four separate but related systems. These include: the pre-launch computer itself; a 7090, a 1620, and a punch-tape-operated automatic test system called the AN/GJQ-9. The K-177 converter provides machine-to-machine intercommunication between these systems and between the computers and conventional unit-record equipment.

For the PLC, the K-177 converts binary coded decimal cards produced by the 7090 to a special 8 channel tape for input to the PLC. This translation permits the PLC to accept check-out routines generated on the 7090.

For the Bendix AN/GJQ-9 test set, here, as with the PLC, the card-to-tape conversion method is followed. The translation problem with this system is even more complex, since three card columns must be sensed and converted

UNDER computers & test areas

wherever you must REACH

BENEATH  
for  
wires &  
cables

you need STRONG, RIGID

**ELAFLOR**  
FREE-ACCESS FLOORING

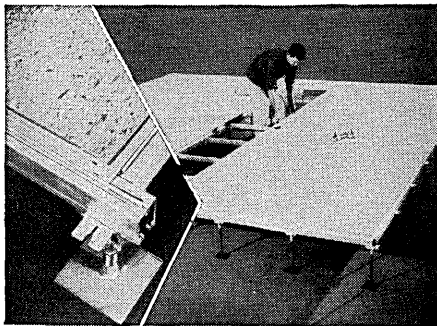

\*Pat. App. For

**LISKEY ALUMINUM, INC.**  
Friendship International Airport, Box  
506, Glen Burnie, Md.; Canadian Rep.—  
Cameron Windows (Aluminum) Ltd.,  
142 Kennedy Rd. S., Brampton, Ontario

Write for 34 page  
Construction Details Folder

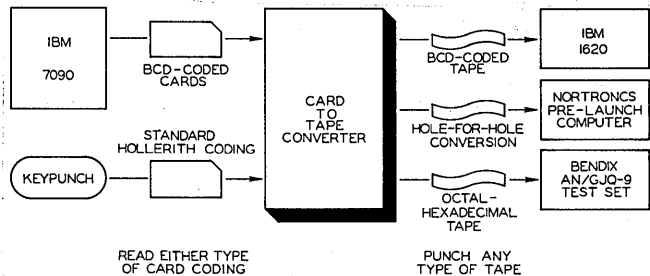
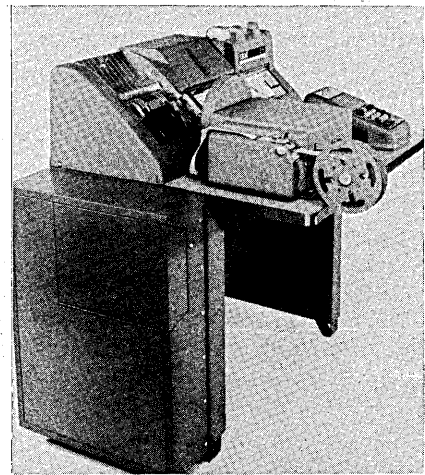

by the K-177 to produce each octal/-hexadecimal tape code. Output cards from the 7090 can also be converted to AN/GJQ-9 tape by this converter.

Finally, for the 1620, the K-177 takes cards punched in Fortran and Symbolic Programming System coding and prepares an 8-channel BCD tape.

FOR SYSTEMATICS CIRCLE 213 ON READER CARD

FOR GENERAL DYNAMICS CIRCLE 19 ON READER CARD →

**DATAMATION**



# THE COMPUTER CHOOSERS QUANDARY:

which machine and why?

reportorial relief proposed

by JOHN A. GOSDEN,  
Auerbach Corporation, Philadelphia

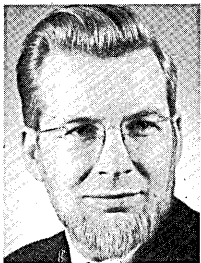

The strange paradox of a fifteen-year-old field devoted to data processing is that up to this time it has not produced a comprehensive information service about itself.

With the present proliferation of computers, a prospective user is hard pressed to remember the names of all the machines that he must survey, let alone keep up with their frequently changing specifications. Often the mark of a user in the throes of shopping is the handy score card of quick-look specifications, kept in the most accessible pocket ready for a fast draw on each computer salesman.

The prospective user becomes, for better or for worse, a computer systems analyst. Whether he appoints a committee, assigns a skilled technical team, elicits proposals, or undertakes the task himself, the final decisions will be based upon data that varies in quantity, quality and consistency, and that data is rarely oriented to the user's

viewpoint of the problem. Let's look at these problems further:

Assuming that the user has thoroughly defined his problem, though this is a difficult step, his next task is to reduce his field of analysis from the many computers with their entourage of program packages, to a group which seems most likely to solve his problem effectively.

Even when his range of interest has been narrowed to perhaps eight computers, and he begins a detailed analysis, he may then wind up with a six-foot shelf of manuals on the hardware and only a few documents on associated software.

The next obstacle is the orientation of the data that he will use in his analysis. On the one hand there is material which presents carefully selected data reflecting the emphasis thought necessary by the manufacturer's sales department. How can the bias be removed and the hidden drawbacks revealed? On the other hand, there are detailed instruction, programming and engineering manuals

in varying formats and terminologies. Somewhere in this plethora of data are the characteristics important to the user.

The quality of the data available on computer systems varies considerably, depending upon the manufacturer, the sales engineer who has prepared the specific document, and the status of the document—preliminary or final.

To add to interpretation difficulties, terminology in this field is not yet standardized. Although both national and international organizations are busily concerned with establishing definitions of terms, current technical literature contains the semantic traps of synonyms, alternative definitions, confused statements, and careless usage.

Finally, even when the computer systems analyst has reached fairly safe ground by translating the material into some common language, he faces another obstacle: the specifications of the various systems and their performance figures are quoted on entirely different bases. To obtain comparable figures, he must make complex interpretations to arrive at what might be called apples-to-apples comparison.

Having overcome these problems, the user has the additional problem of measuring each computing system against the jobs it is required to do. At this level, each analysis becomes unique; but at the earlier stages the same data is being analyzed again and again. Even when judging systems for a specific application, general measures of performance, based on actual applications, can assist users appreciably.

During the course of its work, the Auerbach Corp. has compiled reports in depth comparing various features of computer systems. As a result of recent discussions with The Bureau of National Affairs, Inc., it has been decided to prepare EDP reports of general interest and to publish them in association with BNA. Soon to be available on a subscription basis, this service will include the following:

#### **computer system reports**

Each commercially available system will be covered by a special report in standard form describing, from the user's point of view, its characteristics. These reports will be divided into the following sections:

- Data structure: showing how this computer system represents basic units of data: character, field, etc. in various locations.
- Internal storage: the size, speed, and characteristics of the working storage for the processor of the system.
- Central processor: a user-orientated specification of the capabilities of the processor, functional capabilities (operations performed), special features to improve speed and programming ease, error-control features, etc.
- Input-Output units: complete specification of the peripheral units available with the system, including basic speeds, overheads, error systems and compatibility of external storage.
- Systems configuration: a review of the minimum, typical and maximum configurations that can be reasonably utilized, and the interconnection restrictions.
- Simultaneous operations: features that permit overlapping of operations and therefore improved performance.
- Physical characteristics: a summary of the characteristics pertinent to physical installation problems.

The following sections of these reports describe for the user the program packages available with the system.

- Source languages: a description of the scope and features of the languages available for use with the system.
- Translators: an analysis of the programming pack-

ages which translate source languages to machine languages emphasizing what they do for the user, and their availability and status.

- Operating systems: the standard routines and conventions which assist in the sequencing of runs, in error detection and correction, and other operating problems.

The following sections provide performance and cost information:

- Systems performance: standard problems, developed for this service, measure the particular system performance for both data processing and scientific applications.
- Prices, purchase, and rental, for both the equipment and associated services, such as maintenance and training.

Another series of reports will cover peripheral devices independent of systems.

#### **comparison charts**

The service will include charts permitting the rapid comparison of systems which are likely to be considered at one time; for example, all medium-scale systems. The comparisons will include not only the basic specifications in standard terms but the performance measures thus giving rapid evaluation of the relative effectiveness of systems for various applications. Separate charts will be prepared to compare peripheral equipments, for instance all high-speed printers.

#### **supporting reports**

In addition to the basic data, the service will provide special reports describing selection procedures, as an aid to those users who are now selecting equipment. Also provided will be reports on the state-of-the-art and directories of manufacturers, of computing centers, and of other services.

#### **examples**

It is obviously impossible to summarize in this article an entire service which will require several thousand pages in its complete form. Two examples will illustrate the nature of the service. Exhibit I is an example of a report on a typical compiler translator for a particular machine. As a second example, consider the problem of evaluating a high-speed printer system. The key item to the user is to determine how long it will take to print a given number of records of a specified size. By analyzing the basic equipment characteristics and input-output commands of the processor, a graph can be prepared which provides the user specifically with data about print times. In the graph in Exhibit II, the user selects the format spacing involved and can directly determine the effective rate of printing.

Exhibit II also shows how supplementary facts are provided. In one case whether the printer's character set satisfies COBOL requirements, in another case the varieties of paper feed control available.

To make the reports easy to use and understand, they will all be issued in the same format. This standard format will permit a fast standardized indexing system and side-by-side comparisons. A User's Guide included with the first issue will contain not only precise definitions based on those being developed as international standards, but a commentary on the meaning of various entries and their importance to the user.

#### **EXHIBIT I — FICTITIOUS PROGRAM TRANSLATOR**

1	GENERAL	
11	Identity.....	UPEL 1961 Translator
12	Classification	
121	Source Languages:.....	UPEL 1961.
122	Originator:.....	ABC Corp.

123 Maintainer:.....ABC Corp.,  
Address.

124 Reference Document:.....No. 32-001-62.

13 Brief Description:  
The standard translator from UPEL to OPEL computer code. A straight-forward compiler with no generators or novel features. It is only available with magnetic tape systems.

14 Date First Available:.....March 1961

2 INPUT

21 Language

211 Name:.....UPEL 1961.

212 Exemptions.....none.

22 Form:.....punched card.

23 Size Limitations

231 Maximum number source statements:.....none.

232 Maximum number of data items:.....10,000 data names.

3 OUTPUT

31 Object Program

311 Language:.....OPEL relocatable computer code.

312 Form:.....Magnetic tape, or punched cards.

313 Conventions:.....Fits OPEL EXECUTIVE

32 Documentation  
Subject Provision  
Source program:.....full listing,  
Object program:.....optional separate listing,  
cross referenced.  
Storage map:.....none.  
Language errors:.....flag on SP listing.  
Program inconsistency:.....separate listing.

4 TRANSLATING METHOD

41 Combination of Tasks:.....translate,  
translate & go.

42 Special Tasks:.....fast patching, alter  
translate to check only.

43 Bulk Compiling:.....translator needs reloading.

44 Program Diagnostics:.....snapshot points inserted  
as indicated.

45 Library Entries:.....separate translate and  
insert runs.

46 Library Extracts:.....automatically called by  
name from tape.

5 TRANSLATOR PERFORMANCE

51 Object Program Space

511 Fixed Overhead:

Space:	For:	COMMENT:
400 words	EXECUTIVE	uses overlays.
200 words	FLOAT-ARITH	if used.

512 Space required for each input-output file: twice max.  
block size  
plus max.  
record size.

513 Approximate expansion of procedures:.....10 words per  
elementary  
statement.

52 Translation Time

521 Normal compiling:.....15 + .001 S mins.

522 Checking only:.....15 + .0005 S mins.

523 Unoptimized compiling:.....NA.

53 Optimizing Data:.....priority of program  
partitions.

54 Object Program Performance

Type	Speed	Space
Elementary algebra:.....	good.	avg.
Complex formulae:.....	fair.	avg.
Deep nesting:.....	avg.	avg.
Heavy branching:.....	avg.	avg.
Complex subscripts:.....	poor.	poor.
Data editing:.....	excellent.	good.
Overlapping operations:.....	good.	avg.

6 COMPUTER CONFIGURATIONS

61 Translating Computer

611 Minimum configuration.

Tape units:.....	4
HSM:.....	4000 words
Discs:.....	0
Card Reader:.....	1
Card Punch:.....	1
Line Printer:.....	1

612 Larger configuration advantages:.....none

62 Target Computer

621 Minimum configuration  
Tape units:.....3.  
HSM:.....4000 words.

622 Usable extra facilities:.....any.

7 ERRORS, CHECKS AND ACTION

71 Error

	Check or Interlock	Action
Missing entries:	only if referenced,	separate listing.
Un-sequenced entries:	yes,	internal re-order.
Duplicate names:	yes,	flag on listing.
Improper format:	yes,	flag on listing.
Incomplete entries:	yes,	flag on listing.
Duplicate descriptions:	no,	last one rules.
Overflow target computer:	no,	
Inconsistent program:	some,	separate listing.

8 ALTERNATIVE TRANSLATORS

Computer	Identity	Date
ABEL	UDEL to OPEL Translator	June 1962.

NOTE  
All special words in the report are carefully defined in the User's Guide, especially where there are alternative uses; coded entries are avoided. For example:

212 Exemptions: Facilities that are (optionally) available in other (prospective or alternative) implementations of the language but are not covered by this translator.

52 Translation time: quoted in minutes as a function of S, the number of elementary statements.

54 Object Program: relative time taken and space used compared to an average programmer using a computer oriented language. The terms used represent the following approximate ratios:

poor	.....2.0 or more,
fair	.....1.4,
average	.....1.0,
good	.....0.7,
excellent	.....0.5 or less.

EXHIBIT II. SAMPLE EXTRACTS FROM PART OF A TYPICAL REPORT ON A LINE-AT-A-TIME PRINTER

Characters Available

Numerals	0 to 9
Letters	A to Z
Other	.+/-=*,,(')
COBOL requirements	Yes, basic
FORTRAN requirements	Yes
Alternatives possible	Yes

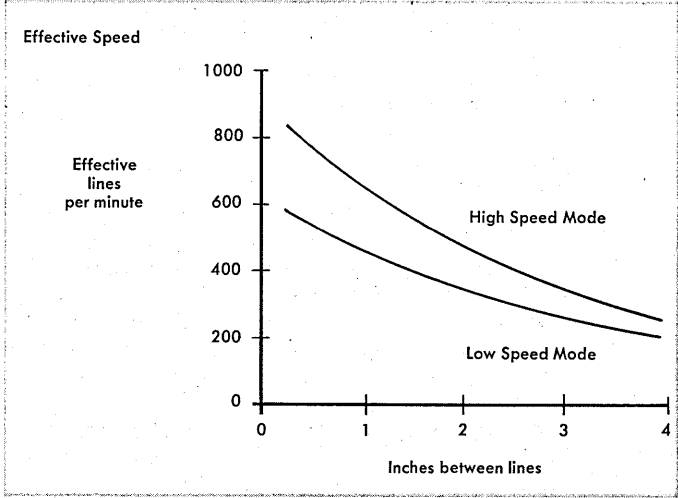

Facilities

Output load: Up to 1000 characters divided into variable length lines by Line End characters.

Stepping: Included in output operation, either 0, 1, 2, 3, 4, 5 or 6 line feeds before each line is printed.

Skipping: Included in output operation as alternative to stepping before any line; controlled by four skipstop channels on paper tape loop.

FOR AUERBACH CIRCLE 214 ON READER CARD

# THE 1206

by DAVID FROST,  
Military Applications, UNIVAC, St. Paul

 The UNIVAC 1206 Military Real-Time Computer is a large-scale, general-purpose machine for which applications are found wherever environment dictates a small physical size and resistance to shock vibration, and unusual climate conditions. It was developed from the AN/USQ-20 computer, heart of the Naval Tactical Data System (NTDS).

At present 15 1206 computers have been delivered. A typical mean-time-between failure figure of 385 hours has been achieved during more than 3000 hours of operation under actual service conditions. The 1206 is intended for applications such as missile guidance, range safety, process monitoring, and tactical control and display.

Relative to other general-purpose systems, the 1206 emphasizes large, randomly accessible internal storage and rapid communication with external devices. Its general-purpose nature, asynchronous input/output system, and program interrupt feature allow for parallel processing of both "batch" and real-time data under executive control.

Internal storage of the 1206 consists of a 32,768-word core memory. Control, Arithmetic and Input/Output sections of the computer each have access to memory; cycle time is eight microseconds. Arithmetic and logical operations are performed in the parallel binary mode; arithmetic is one's complement subtractive with a modulus ( $2^{30}-1$ ).

The computer is housed in a single cabinet 33" deep x 37" wide x 72" high. Thirteen chassis, eight of logic and five of memory, are arrayed horizontally within the cabinet.

Primary power is provided from a 60-cycle input, 400-cycle output motor-alternator which in addition to converting frequency, serves to provide necessary isolation from the main power source. Total power consumption is 2400 watts. For the average installation, forced air cooling is all that is required.

Compact peripheral equipment also available includes a magnetic tape system which uses standard  $\frac{1}{2}$ " tape, at a speed of 112- $\frac{1}{2}$ " per second with a word transfer rate of 2.25 kc. A paper tape reader and punch operate at 200 and 60 cps, respectively.

The monitoring typewriter is a unit of peripheral equipment containing the necessary control and logic circuitry to adapt a Flexowriter for use as an output printer and an input keyboard entry device.

A number of militarized peripheral devices have also been developed which send and receive data to and from the computer. These include video processors or data quantizers that convert radar video into digital form for automatic tracking, communications control

for ruggedized real-time control

equipments that perform the control and assembly interface, and manual entry devices (keysets) and a synchronizer for their sequential scanning. In addition, the paper tape, typewriter, and magnetic tape units serve as on-line and off-line input/output devices for maintenance and program recovery purposes.

Programming the 1206 is facilitated by the computer's ability to organize and handle data in either full or half words, providing for more effective storage when extremely fine accuracy is not needed; to make most arithmetic instructions serve also as decision-making instructions, and to manipulate individual bits or groups of bits easily.

The 30-bit instruction word is divided into five parts as follows:

- f 6 bits: function code
- j 3 bits: j designator
- k 3 bits: k designator
- b 3 bits: index register designator
- y 15 bits: operand

The function code (f) can take on 62 values, all of which represent different instructions (00<sub>8</sub> and 77<sub>8</sub> are not used). These instructions include those expected in any large general-purpose computer, e.g., the usual arithmetic, shift and store instructions. However, input-output instructions reflect the real-time design of this computer, and other instructions, which are not common to all large general-purpose computers, are also of special interest. "Replace" instructions allow modification of memory registers using one instruction in a way that would require three or more instructions in a traditional machine. These instructions, as well as all other arithmetic and store class instructions, can specify, as part of the function code, the option of handling individual bits or bit groups through the use of masks and logical products. In addition, a "repeat" instruction provides a method for rapid table search; this feature is especially useful in realtime situations, where rapid data handling is necessary.

Use of the j designator allows decision making to be included in the function of more than three-fourths of the instructions in the computer repertoire. The ability to make a calculation and then test the result all in one step is both convenient and time saving. The three-bit j designator can take on the following values:

- j=0: Do not skip the next instruction
- j=1: Skip the next instruction unconditionally
- j=2: Skip if Q is positive
- j=3: Skip if Q is negative
- j=4: Skip if the accumulator is zero
- j=5: Skip if the accumulator is not zero
- j=6: Skip if the accumulator is positive
- j=7: Skip if the accumulator is negative

(The Q register, together with the A register (ac-

cumulator), plays the traditional role in holding the double-length word needed in multiplication and division. It is also addressable in so many ways that it can serve as another accumulator.)

Fault conditions may arise in the execution of a divide instruction: the divisor may be zero or the quotient may exceed 30 bits (including sign). The computer never stops automatically because of a divide fault. With proper use of the *j* designator, however, a fault can be detected and a remedial subroutine (for example, re-scaling followed by another divide attempt) may be operated.

For input/output instructions the *j* designator is used to address the input/output channel specified. It borrows a bit from the *k* designator so that it can assume values large enough to specify all 14 channel numbers.

The *k* designator which is used to specify whole- or half-word operands is applicable to all 62 function codes. All eight values that can be expressed using three bits are used, providing flexibility in specifying both source and destination of half words. One source of a half word of data can be the operand of the instruction itself. This option of storing the operand as part of the instruction word is particularly advantageous for certain applications. It reduces computing time by eliminating a memory reference and preserves storage space, if 15 bits are adequate for the precision required.

The index designator can specify any one of the seven index registers for address modification. Most of the instructions of the 1206 are indexable.

Communication with the computer is carried on in a 30-bit parallel mode. The 1206 is provided with 14 input and output channels, which are divided into 12 normal and 2 special input channels. The four special input/output channels differ from normal channels only in timing and control of data transfer and are used for intercomputer transfer of data.

A system of both internal (computer controlled) and

external (external equipment controlled) interrupts allows efficient scheduling of real-time problems, because the flow of external data can actually control program flow.

For each of the 14 input/output channel pairs there are five permanently assigned locations in memory that are of significance to input/output operations:

1. **A buffer control register for input.** This register contains the current and final addresses of the area in core memory to which data is being transferred. The lower address is set initially to the first address for the transfer. As words come in, it is incremented until the current and final addresses compare and the last word has been read in.
2. **A buffer control register for output.** This register contains the current and final addresses of the area in core memory from which data is being transferred. During transfer its operation is similar to that of the input buffer control register.
3. **A program address register for internal interrupt-input.** An internal interrupt may be programmed to occur when an input transfer terminates normally because the two halves of the buffer control register have become equal. It consists of an unconditional program transfer to the program address register specified for the particular channel.
4. **A program address register for internal interrupt-output.** An internal interrupt may also be programmed upon normal termination of an output transfer.
5. **A program address register for an external interrupt.** An external interrupt occurs when a piece of external equipment sets the interrupt control line on the input channel to the computer.

An internal or external interrupt consists simply of transfer of program control to the particular register specified for the channel in operation upon receipt of a signal from the input/output section of the computer. At that point, an interrupt diagnostic subroutine will generally be programmed to analyze the situation and then return control to the main operating program.

As an aid to analysis of an external interrupt situation, peripheral equipment may place a coded word on the input data lines at the same time it sets the interrupt line. The interrupt diagnostic subroutine can thus receive detailed information as to the cause of the interruption. External interrupts generally occur as a result of a failure in data transmission or at the successful termination of some normal mode of operation.

A typical transfer, either into or out of the computer, is started by two programmed commands, one to the external equipment, the other to the computer's input/output section. The first places a signal on a control line to the peripheral control equipment along with a word on the output data lines coded to tell it exactly what is to be done. The other instruction defines the core storage buffer area in the buffer control register, and specifies if an interrupt is to occur upon completion of the transfer.

Available for 1206 users is the CS-1 compiler and utility system.

In addition to machine code language, the CS-1 compiler makes available a problem oriented language that was designed for the typical real-time problems found in military systems. A library system offers input/output and format control programs, function evaluation programs for square root, the common trigonometric, exponential, etc., functions, as well as a complete floating point package.

Although its application has been mostly to the real-time programs for which it was designed, the CS-1 compiler can be and is being used for scientific and ordinary data processing applications. ■

CIRCLE 215 ON READER CARD

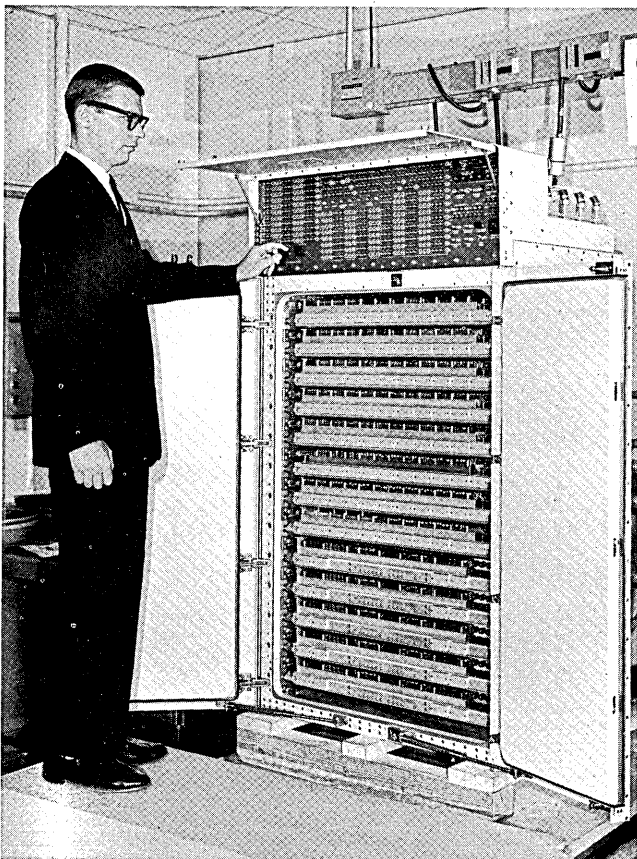

# THE THOUGHT PROCESS

by P. M. BEATTS,  
Education Planning Center, IBM, Poughkeepsie, N.Y.



In an age of nanoseconds and mach numbers, and in an industry which has gone from electro-mechanical relays to tubes, to transistors, to thin films, to cryotrons in less than fifteen years, hair-splitting is as necessary in discourse as atom-splitting in physics. As the fission process preceded fusion, so an analysis of thinking, machine-logic, etc., is a necessary prerequisite to any meeting in discourse between psychology and data-processing as well as to the merging for mutual progress of two areas of research. For they are, as we increasingly observe, inextricably related; the opposition that at times appears to exist is really either mere misunderstanding or incompatibility of language. There are two tendencies which make many of our problems more serious than necessary.

First is our natural inclination towards anthropomorphism. For example, we tend to think of a machine's "memory;" to think of queuing as if people were waiting in line; to think of programs in human terms, until we discover "memory" is an obstructive concept when buffering and priority programming are involved, that queuing theory is a mathematical probability concept, and the rapid shortening and simplification of programs comes as a result of machine-knowledge and adaptation to machine design, rather than to human logic. Instead, we need to find new approaches and new methods of solution to problems that are essentially connected with getting a machine to perform certain functions, rather than getting a machine to do what a man did, somewhat in the way the man did. As Ross Ashby pointed out, his homeostat would be a good deal more efficient if he were not trying to make it operate *and fail* in human fashion.

## a definition before simulation

Second is the opposite simplification, by which we tend to equate the often complex operations of a machine with what seems logically to be human behavior, thus "proving" that the machine "thinks".

Let us now try to throw a little light on these areas, preparatory to the joint effort to solve the basic problems of "What is human thinking? How is it mediated? What are the components involved, the procedures followed, by efficient and inefficient examples?" Then we could jointly address ourselves to the next series, namely, "How can this be taught, encouraged, or inculcated in the young in ever larger numbers?" "What artificial (i.e., computer, etc.) models, trainers, simulators can be designed to help this effort, or even make it unnecessary?" Such a program appears necessary because, in fact, the first series of problems is by no means solved.

We shall then try to draw some descriptive, but perhaps usable definitions and discriminations between various activities or behaviors of the human nervous system which could *all* be called thinking, and thus lead nowhere.

For this purpose, and in line with many valid psychological and neurological findings, we shall describe a hierarchy of behavior, and only to the top level of this hierarchy shall we give the label "THINKING." If it serves no other purpose, it will be a tool by which the various technical groups concerned can *really* agree or disagree, and even test their statements that machines do or do not, can or cannot, will or will not, "think."

The levels of activity in ascending order will be named for the purposes of this discussion as follows: 1. Attitudes; 2a. and b. Percepts and Introspections; 3a. and b. Practical Meaning and Emotional Meaning; 4. Concepts; 5. Ratiocinations; 6. Constatations. These are diagrammed on the opposite page in a schematic which is intended to show (a) the sources of the raw material of each level of con-

struct; (b) the possibility of their integration in a nervous system such as the human, having in general three "sections" — motor (nerves producing muscular activity, and the area of the head-brain controlling these nerves); sensory (nerves carrying information from the external world (touch, taste, smell, sight, hearing) and the area of the head brain controlling these nerves), and correlative (or internuncial or central) (areas of the brain concerned with relating, integrating and combining nerve impulses).

FIGURE 1.

INTEGRATIONS OF CENTRAL NERVOUS SYSTEM

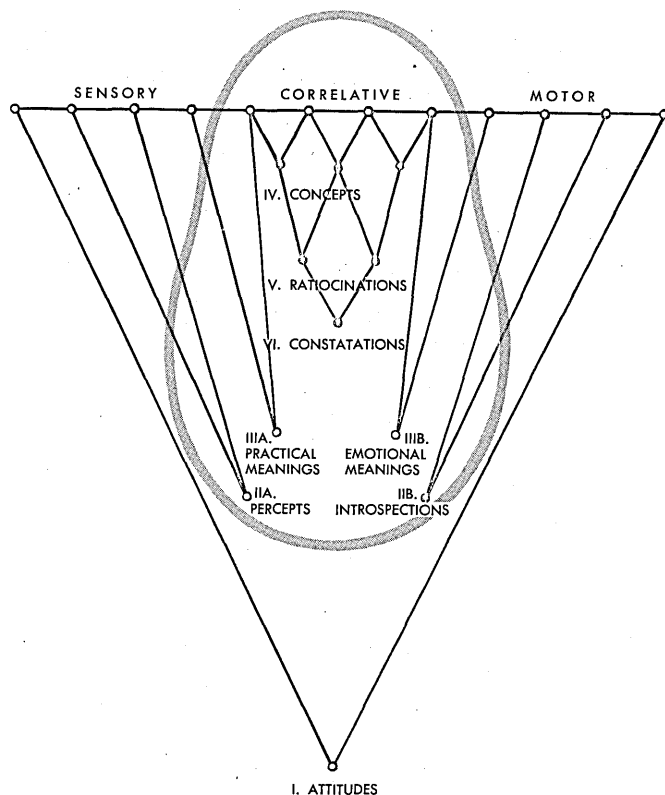

It must be stressed that the diagram does *not* include the peripheral equipment such as sensory receptors, motor effectors, or the neural activity of such nerves. In other words, the "sensory impulses" of the diagram are already converted to neural phenomena capable of registration and integration in other areas. In brief, a "sensory" or "motor" stimulus in this diagram is a neural representation of the motor nerve or sensory nerve phenomenon.

As if, in a computer, we cut away all peripheral equipment such as card readers, tapes and printers, dealing only with the pulse pattern generated, on input lines, by a punched hole or magnetic tape bit, and on output lines en route to conversion into punched holes, magnetic bits or printed characters.

The reader will note that, as we advance in this hierarchical system, two patterns are evident: a parallelism between motor and sensory constructs; and a complete independence of further external material once the concept level is reached.

Furthermore, we shall deal first, in ascending order, with items 2a, 4, 5 and 6, since these are general levels of thought-process. We shall try to point out the difference between this group and items 1, 2b, 3a and b, and the necessity for the inclusion of the second group, as we go along.

Let us give a simple example of what class of events is

intended to be described by each label in group 1.

2a. Percepts. A man sees a cow for the first time and retains in his nervous system a pattern corresponding to certain aspects or attributes of the event "cow." In many cases, even with such simple raw material, each man forms a different percept (the reasons for this will be touched upon later).

Evidently this is the result of several sensory stimuli and their integration. This, on the sensory side, is the basic behavior, and the lowest level at which central integration occurs.

4. Concepts. A word so misused by laymen that it is almost deserving of an apology here. This is the level of behavior at which for the first time the raw material is all of the second order of events. An infinite combination of individual items can be integrated to form an infinite number of concepts. These are the first level of abstraction and generalization in the hierarchy of behavior. Unfortunately, it is to the concept-forming activity of men that many people give the label "THINKING." We deny its validity on the grounds of pragmatic value. The point will become clearer below.

A single example of concept formation would be inadequate on the basis of what has already been postulated. Also there should be no need to stress the infinite variety of concepts that may be formed by individuals starting from the same centrally-registered data.

For example, what may be the raw material of concepts? Any or all of the lower levels of the hierarchy, for even an attitude, once formed, is registered centrally; so with percepts, introspections, meaning, etc. It is the centrally-registered patterns of these behaviors that form the raw material of concepts.

Above the concept level we begin to approach the classes of behavior that may rightfully claim the label THOUGHT or THINKING. Before that, however, we must deal with the second area of confusion, one which even sophisticated speakers tend to regard as thinking. There is, undoubtedly, more justification for this error than for the equating of concept-formation with thinking, especially in as "practical" a society as ours.

5. Ratiocination is the combination or integration of concepts, and is a highly intricate process, achieved as a general rule by a reasonably small percentage of the population. It consists of such activities as circuit-design, much musical composition, the writing of the more complex types of advertising matter, etc.

The distinguishing feature of the behavior is that it is logical, it proceeds generally in an orderly step-by-step fashion and it is always the reorganization, in time, space, or logical sequence, of existing concepts, objects, facts, etc. The result is frequently of great practical value, and even of a startling nature, since it may involve the juxtaposition or conjunction in a novel fashion of two or more concepts hitherto regarded as completely unrelated or even mutually incompatible. A possible example is the recent development of a land vehicle traveling slightly above ground level on a cushion of compressed air generated by the vehicle itself.

There may be those who argue, and with some justification, that this *is* thinking. Very well then, what label shall we use for the final step in the hierarchy above this level?

6. Constataion is our label for a different behavior, so rare that those who exhibit it are sought out by their fellows, whether to be mercilessly persecuted, extravagantly rewarded, or ruthlessly exploited. This is the activity of men like Einstein, Von Neumann, Newton, Lavoisier, Curie and others who had one factor in common: an intuitive and "irrational" glimpse of hitherto unimagined relationships between existing ratiocinations. Their thinking was

a central process using for its raw material existing ratiocinations, and notably in Einstein's case, requiring at the later stages the formation of new ratiocinations.

To those who believe a spacious distinction without a difference is being made on the basis of a subjective evaluation of the importance and complexity of individuals' contributions, I recommend the reading of such evidence as we have concerning these behaviors. For example, Einstein's correspondence, Fermi's description of his thought-processes, and an interesting group of questionnaires filled in by men such as Bertrand Russell and Al-

FIGURE II.—GROUP ONE

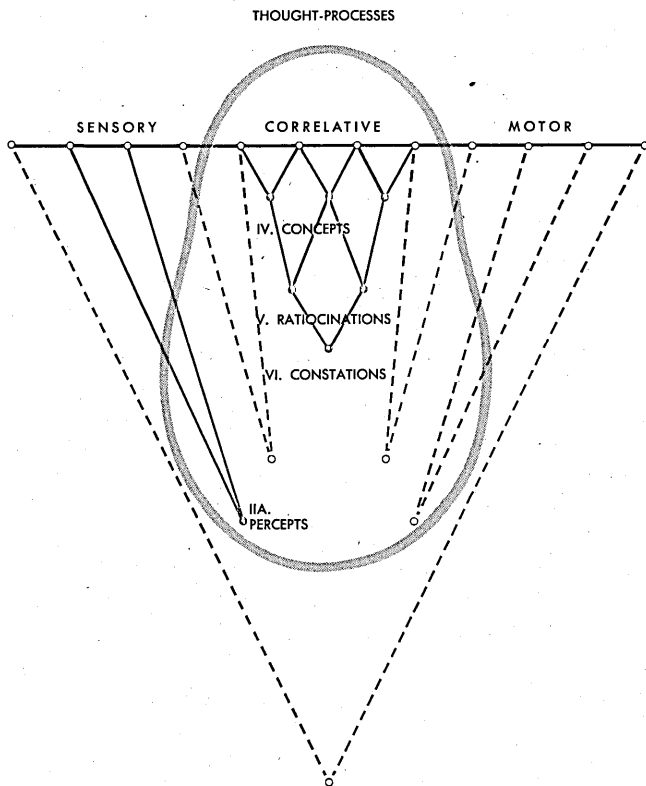
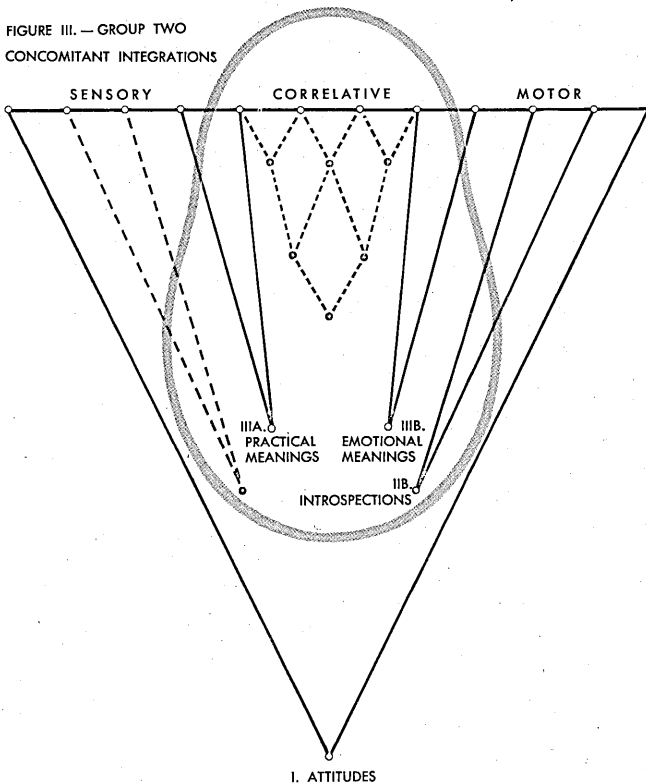

FIGURE III.—GROUP TWO  
CONCOMITANT INTEGRATIONS



dous Huxley in Hutchinson's book, *How To Think Creatively*. True, these are highly subjective reports, but at least they are the serious reflections of men who have exhibited the behavior we discuss, rather than theoretical explanations of how they *must* do it by men who have not.

Less subjectively, the distinctive characteristic of constating as opposed to ratiocinating is that the former behavior involves this intuitive grasp or "snatch at" a "new" field of relationships; and *its raw material is existing ratiocinations, not concepts*.

As an example, for the purpose of topicality and drama, let us consider the thought-process which postulated the existence of atoms having the numbers —, by Mendeleev, or the thought-process postulating the feasibility of, and predicating the power, construction, etc., of the fusion bomb as opposed to the fission bomb.

At all events, we must, I think, concede to this form of behavior a real separate existence from all others previously described. With it we reach the end of the first group in our descriptive hierarchy.

Let us now consider the second group; here we meet an apparent anomaly in the case of attitudes. Note, however, that this integration, in the diagrams, is shown to be occurring *outside* the correlative area. This is because an attitude requires no correlation activity. For example—

1. Attitudes. A man sees another man at a meeting and immediately feels an "irrational" desire or interest in talking to him, becoming acquainted with him, etc. This is a direct (whether overtly expressed or not) motor response to a sensory stimulus. Without an attitude of some kind in any life-situation the organism will not react. Hence we can call this the basic behavior.

The second integration, named introspection, is merely a replica, on the motor side, of the percept. Since its content is emotional, not rational, and involves much contribution from the sympathetic system and the basal ganglia, it cannot correctly be considered a thought-process, despite the integrative activity necessary.

Here a man feels a desire to kick his superior, but also an equal or stronger desire to retain his job. The activity by which he is aware (a) of both motor tendencies (or emotions) and (b) resolves them, is properly to be called introspection. Note again that with as simple raw material as this, each man may form a different introspection.

3a. Practical Meaning in similar fashion is not strictly a thought-process since it has strongly subjective and non-logical elements involved in the integration. For example, let us suppose that a man already having a percept of a cow, next, through a demonstration by another, through accidentally finding a calf at suck, or through his own idle experimentation, discovers the cow gives milk. His percept "cow" now carries a further value, and a value arrived at by a higher level of nervous behavior, and a value not to be lost or forgotten. The percept "cow" is now directly related to himself—has "meaning" for him. (note: whether he *is* or *is not* a milk-drinker!)

3b. Emotional Meaning is an exactly parallel behavior involving motor activity or the motor system. For example, the man's superior described above *can* become "the guy I want to kick" or "the guy I can't kick because I'd lose my job" or "the guy who prevents me from expressing myself just because he's my boss." Extravagantly psychotic meanings can be developed by those who will (yet note that equally psychotic practical meanings are not uncommon, such as "dogs bite," "women are bad drivers," "redheads have bad tempers"). Here again the raw motor response is "filtered" or "integrated" with some degree of central or internuncial response.

The reason for the inclusion in our current discussion of the four forms of behavior that are here defined as not



being thought-processes should be fairly evident from the nature of each as described above. For each contributes to, and affects all thought-processes, from the percept level upwards.

Furthermore, it can be tentatively suggested here that the concept-formation behavior of man is the level at which real error can begin, leading to poor thinking, ill-adaptive overt behavior of all kinds, as well as great inventions, brilliant thoughts, etc. For example, if a concept relative to some object or class of objects in the external world is formed without taking into consideration the attitude formed towards the same object or class of objects, the resultant overt behavior of the individual will be either "inconsistent" or non-existent. If emotional meaning is omitted, he may act *unwittingly* to his own dismay, misery or dissatisfaction, or, as is said, in an "inhuman cold-blooded fashion" (cf. the extermination of Jews in Germany, or Swift's Modest Proposal," in both of which logical conclusions the element lacking was "emotional meaning").

The above considerations lead, therefore, to the conclusion that a "correct" concept can be based only on an integration of all the lower elements in the hierarchy. Anything less must be in some area inadequate or unsatisfactory. I believe that many of the everyday disharmonies of human discourse and even human activities can be explained by the fact that the protagonists are always operating on the basis of "incomplete" or "incorrect" concepts. (Note, by this is not intended the conclusion that only one "correct" concept can be formed from one set of raw materials. Rather there can be several "complete" or "correct" ones, and also many "incomplete" or "incorrect" ones.)

We have, in summary, postulated four levels of thought-process, distinguished from each other by the levels of raw material used in their products, by their removal at each stage one step further from external reality, and by their increased generalization and abstraction. In close relationship with them, influencing their occurrence, nature, and direction we have postulated four types of integration not properly thought-processes yet behaviors of the human central nervous system mediated, with the exception of attitudes, by neural activity in the head brain.

Finally, we have suggested that the accuracy, efficiency and completeness of the three upper levels of thought-process are to a notable degree dependent upon the inclusion and correct combination of all "lower-level" activities.

Three tasks remain. First, to adduce, if there is any, what evidence we can for the correspondence between these categories of description, and the real components and behavior of the human nervous system. Second, to compare computer performance and behavior with these categories to determine whether, and to what degree, they are possible to, or performed by, computers. Third, to try to project lines of computer development which might conceivably result in machine-performance of those categories of behavior which it has been agreed, under task number two, cannot today be machine-accomplished. ■

#### BIBLIOGRAPHY:-

**Integrative Psychology**—Marston, Marston & King. Harcourt Brace & Co.

**How to Think Creatively**—Hutchinson—Abingdon-Cokesbury Press

**Neural Basis of Human Behavior**—H. S. Burr—Cross

**Speech & Brain Mechanisms**—Penfield & Smith

December 1961

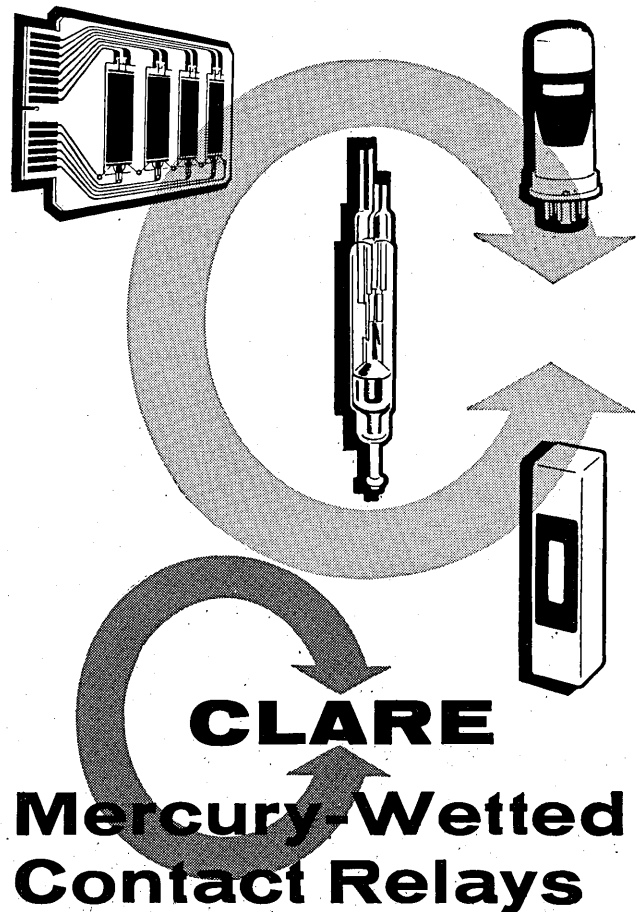

*... flexible to meet every requirement*

Clare mercury-wetted contact relays are available in printed circuit assemblies, modules, conventional plug-in relays and special assemblies. Either of two basic switch capsules...HGS for especially fast, sensitive operation or HG for higher contact loads...is provided. These relays are tested for billions of maintenance-free operations. They never get out of adjustment, never bounce or chatter.

#### The Mercury-Wetted Principle

The remarkably long life of CLARE mercury-wetted relays is the result of a design principle whereby a film of mercury on the contacts is constantly renewed, by capillary action, from a mercury pool. Switches are sealed in a glass tube in high-pressure hydrogen atmosphere.

For complete data write for Design Manual 201-A

C. P. CLARE & CO., 3101 Pratt Blvd., Chicago 45, Illinois.  
In Canada: C. P. Clare Canada Ltd.,  
840 Caledonia Road, Toronto 19, Ont.  
Cable address: CLARELAY.



**C. P. CLARE & CO.**

*Relays and Related Control Components*

CIRCLE 20 ON READER CARD

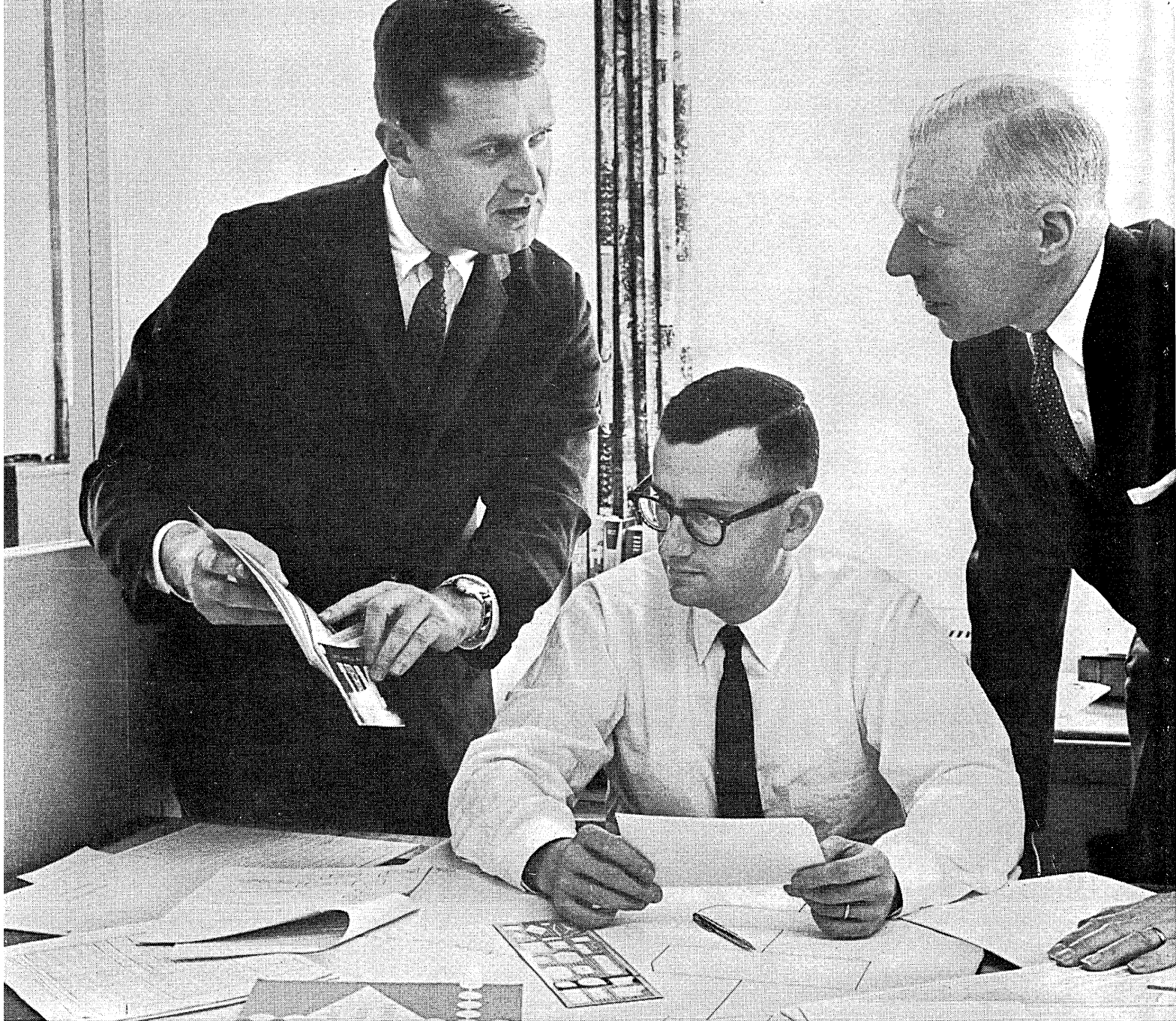

# New ideas in punched

## How your IBM supplies specialist helps you find ways to cut your punched card costs

How can a redesigned punched card improve your data processing efficiency?

Your IBM supplies specialist can tell you...and show you ways to redesign your cards to give you new data processing economies.

Your IBM supplies specialist is a man with extensive training in data processing supplies. That's why

he is uniquely qualified to help you match the punched card to the job that you want to do.

There's virtually no limit to the practical cost-saving ideas he offers you for:

**SAMPLE CARD SELECTION**—You can look over thousands of card formats, filed by industry and application. One or more of these may provide the key to the card design problem that's troubling you.

**DESIGN ASSISTANCE**—Our designers are at your service through a nationwide network of Card Design Cen-

**CUSTOMER METHODS MEN AND AN IBM SUPPLIES SPECIALIST (left) study a stock card form book and flow charts. By matching the card to the job, you get the most out of your data processing equipment.**

**THE RIGHT DESIGN.** Thousands of stock, special, and continuous card forms, books and sets are on file at IBM Card Sample Centers. One of them might solve your problem.

**NEED A SPECIAL CARD?** IBM research has developed scented-ink, water-resistant, magnetic-ink-encoded cards—and a host of others, including cards printed in full color.

**CREATIVE SKILLS AT YOUR SERVICE.** At thirteen IBM Design Centers across the country, experts create cards to meet your specific needs, and bring new efficiency to your data processing operation.



# card design

ters. These experts can help you to develop your own card ideas, to apply existing formats, or to create new, exclusive designs for solving your problems.

**EDUCATION**—Seminars at our customer education centers, informative literature and plant tours keep you up-to-date on the latest techniques in designing, using and caring for your IBM cards.

**FAST CARD DELIVERY**—Whether your order is large or small, you get fast service from nationwide manu-

facturing facilities. IBM gives you prompt service, too, on card designs and card proofs.

Your IBM supplies specialist is the man with the complete punched card story. Let him help you with solutions to your card problems.

**IBM** DATA PROCESSING

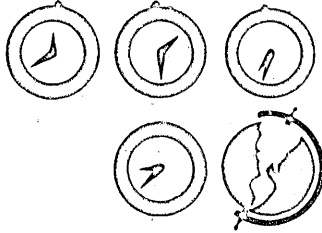

# NEWS BRIEFS

## RCA & ICT SIGN TRADE AGREEMENT

International Computers and Tabulators Limited of England (I.C.T.) has placed an initial order for the purchase of 50 RCA 301 systems, with an option for the purchase of 50 or more additional systems. Shipments will begin by mid-1962 and will be completed by 1964.

RCA has granted I. C. T. non-exclusive patent licenses for the manufacture and sale of dp equipment and has also placed at the disposal of the British company technical information relating to the manufacture of other dp equipment produced by RCA.

## 704 FLUNKS PSYCHOLOGICAL TESTS

Mental tests are being given to computers at the University of Michigan Medical Center to investigate their ability to think. John W. Gyr and Albert C. Cafagna, of the University's Mental Health Research Institute, are giving an intricate psychological test to IBM 704s in which the computers are told to solve problems in three different ways and the results thus far, according to the investigators, seem to indicate that the computer is quite vacillatory and simple-minded when it comes to solving these problems. The various ways in which the problems can be dealt with vary in the extent to which certain environ-

mental events are registered or how capable the computer is of abstract thinking.

The computer seems to seek the more simple paths until, generally by accident, it comes upon a more complex method of problem solving, Gyr stated. There is a tendency for it to vacillate around a solution and it is relatively unable to retain information.

Before selling the computer short, however, the researchers note that, "Other programs, basically more 'elegant' theoretically, tend to lead to behavior which is less vulnerable to the above shortcomings."

## NIH BUDGETS \$12,000,000 FOR MEDICAL DP CENTERS

The National Institute of Health plans to spend up to \$12,000,000 during the next six years to support five or six regional instrumentation centers containing dp equipment, according to a report prepared by Dr. Fay M. Hemphill of the Division of Research Grants, and Dr. James A. Shannon, NIH director. Five million dollars has been budgeted for the period between June 30, 1961 to June 30, 1962, according to Shannon.

Dr. Frederick J. Moore of the University of Southern California School of Medicine has predicted a rapid rise in the use of computers in the field of medical research and diagnostics. Dr. Moore was the summary speaker at an October conference sponsored

by IBM, the theme of which was the use of computers in medical and biological research. At the conference, researchers described some of the areas in which computers will be used, including the detection of hidden heart disease, various inheritable diseases and conditions, inherited traits, and characteristics, and analysis of brainwaves in the detection of mental illness.

At the recent 1961 Computer Applications Symposium in Chicago, Robert S. Ledley, president of the National Biochemical Research Foundation, Inc., stated that the entire medical diagnostic process could be converted into mathematical models to be programmed into a computer.

## SDC AWARDED \$4,530,000 FOR COMMAND, CONTROL R&D

A \$4,530,000 contract for r&d in command and control systems has been awarded to System Development Corp., by the Office of the Secretary of Defense. Under the contract, SDC will perform experimental and conceptual studies in decision and control at the highest levels of command. An IBM AN/FSQ-32V has been installed at the corporate headquarters of SDC in Santa Monica, Calif., and will be used in conjunction with the recently opened \$3,000,000 Systems Simulation Research Laboratory for this purpose.

A new Command System Department, headed by Dr. Paul D. Greenberg, has been formed to carry out the program. Approximately 125 senior scientists and technicians will staff the new department.

## PHILCO'S BARNARD TO CHAIR '62 SPRING JCC IN S.F.

The appointment of executive and committee responsibilities for the 1962 Spring Joint Computer Conference and Exhibition to be held at the Fairmont Hotel in San Francisco May 1-3 has been completed.

George A. Barnard of Philco Western Development Laboratories has been named general chairman of the Conference which is sponsored by the American Federation of Information Processing Societies (AFIPS).

Dr. Hewitt D. Crane of Stanford Research Institute is the vice-chair-

man and the secretary-treasurer is Robert A. Isaacs of Philco.

Head of the technical program is Dr. Richard I. Tanaka of Lockheed Missiles & Space Co. and Dr. Robert C. Minnick of Stanford Research Institute is vice-chairman. Associate chairmen for special sessions are John E. Sherman of Lockheed and R. J. Andrews of IBM.

Exhibits chairman is John W. Ball of Pacific Telephone Co. and R. George Glaser of McKinsey & Co. is arrangements chairman.

## INTERNATIONAL IR COMMITTEE ESTABLISHED

An interim international Research Committee for Mechanical Search was established late in October following the close of a three-day International Patent Office Workshop on Information Retrieval held at the State Department in Washington, D.C.

Function of the committee is to develop means of international co-

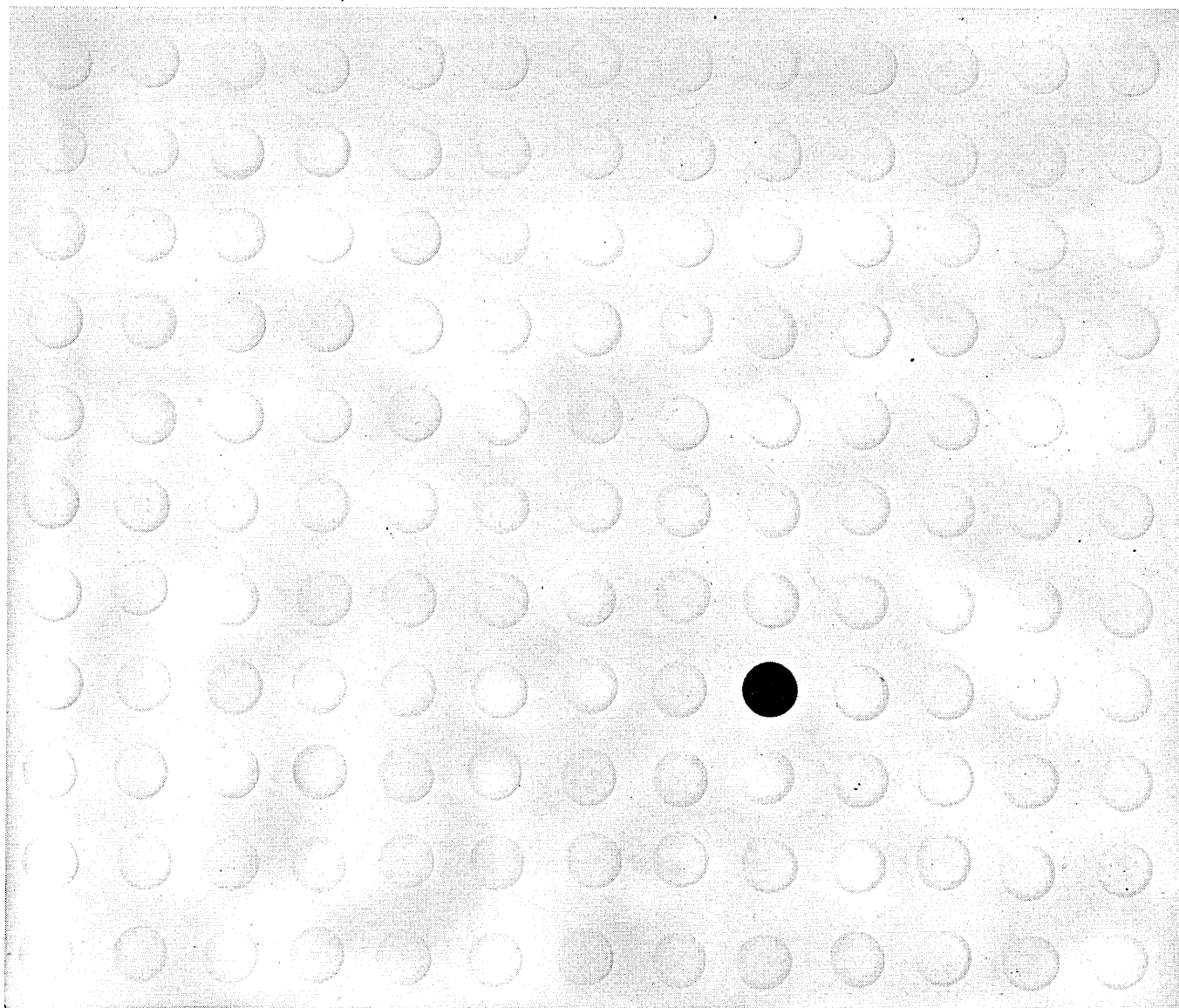

## Is your computer tape truly clean? (If so, you must be using Ampex)

Ampex is the first truly *clean* computer tape! It's produced in a controlled atmosphere, under the most rigid precautions. Every roll must pass intensive electrical and physical tests before packing.

Then, when Ampex engineers are almost sure it's perfect, they take another step to insure it's truly *clean*. They "bathe" it in a special chemical bath that removes all extraneous matter that might cause even a "temporary dropout."

But that's not all. Every inch of Ampex Computer Tape is digitally checked to make sure every reel is completely error-free before it leaves the plant. What's more, it's tested on systems compatible with those it will be used on.

Another thing about truly clean Ampex tape is that it keeps your system

cleaner, too! The exclusive Ferro-Sheen process insures a smooth, clean surface that reduces headwear and oxide build-up . . . so you have less costly downtime for cleaning! Ampex performs better and runs cleaner than any other tape!

Some people say we take excessive precautions in making sure our tapes are truly clean and error-free. But this is the kind of deliberate excess that makes products superior enough to be called Ampex, a name that's known for perfection!

To test Ampex superiority, compare our computer tape, at 556 BPI, against any other tape made. See for yourself what Ampex can do!

Incidentally, as you may have guessed, it just naturally follows that our Instrumentation Tapes are the finest available!

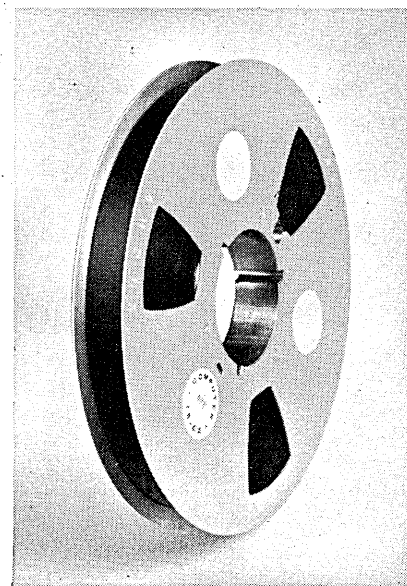

AMPEX MAGNETIC TAPE PRODUCTS

Opelika, Alabama

## News Briefs . . .

operation in solving the problems of mechanical techniques for searching patent applications. Delegates represented the U.S., Australia, Canada, Germany, Japan, Netherlands, Norway, Philippines, Sweden and United Kingdom.

### ACM STUDIES AUTOMATED COMPUTING INSTRUCTION

The Education Committee of the Washington, D. C. Chapter of ACM has established a subcommittee, to be headed by Captain Thomas A. Durek, on Automated Instruction. The subcommittee will be concerned with using automated instruction, programmed texts or teaching machines to instruct high school students in digital computer programming. Their primary purpose will be to provide ACM members with a means for learning about the new developments in teaching machines through participation in an instructional project. An automated course in computer programming for high school students in the spring will be the first activity of the subcommittee.

Captain Durek, chairman of the

subcommittee, is director of a programming section at the HQ United States Air Force Computer Center and has also taught navigation instructors at an Air Force instructor training school.

● Philip Hankins & Co., Inc., computer consultants, has been awarded a contract for writing an algebraic compiler for the H290, Honeywell's new process control computer. Special features will be incorporated in the compiler language which will be compatible with the basic FORTRAN format.

● The Bendix G-15 has been used to design lenses for the world's largest ballistic camera which is used to gather optical data on the flight of missiles and spacecraft. The camera is expected to be able to spot missiles at 1,000 miles distance within a 26 foot error range.

CIRCLE 115 ON READER CARD

● Univac III systems are scheduled for delivery to the Pacific Finance Co. in December, 1962, and to the Houston Lighting and Power Co. early in 1963.

CIRCLE 116 ON READER CARD

● Shortcutting methods for optical design calculations which increase accuracy and reduce computation times by as much as 250% have been accomplished by the use of Autonetics RECOMP II and a highly refined programming technique developed for the Pacific Optical Corporation.

CIRCLE 117 ON READER CARD

● The National Science Foundation has awarded \$400,000 to Michigan State University to be applied to the purchase of a new, general purpose computer (as yet unannounced) to replace the MISTIC which has been in use during the past four years.

● The Applied Physics Laboratory of Johns Hopkins University has awarded a \$2,000,000 contract to Thompson Ramo Wooldridge's RW Division for the design and fabrication of a high accuracy control computer system to be used with the TRANSIT satellite Navy system.

● The United Kingdom Atomic Energy Authority has become the largest user of computers in that country. The A.E.A. presently has nine digital computers, two analog

### COMMUNICATION AND DATA SYSTEMS COLLINS RADIO COMPANY

Collins Radio Company invites you to participate in the development and implementation of advanced concepts in integrating communications and data processing. The following positions are currently open with the Communication and Data Systems Division in Cedar Rapids, Iowa . . .

**COMPUTER APPLICATIONS ANALYSTS**—Graduate degree in Engineering, Physics or Mathematics and/or extensive experience in engineering, mathematical or numerical analysis.

**OPERATIONS RESEARCH ANALYSTS**—Graduate degree and/or considerable experience in the application of operations research techniques to scientific or business problems.

**SENIOR COMPUTER PROGRAMMERS**—Undergraduate degree in Engineering, Physics or Mathematics and several years' programming experience on large scale digital computers.

**COMPUTER SYSTEMS SPECIALISTS**—Undergraduate degree in Engineering, Physics or Mathematics and comprehensive experience in developing, writing, modifying and trouble-shooting sub-routines and macros, compilers, assemblers, generators and supervisory control systems.

Send your resume, explaining in detail your past experience and present position to Charles K. Titus, Manager, Scientific Analysis and Programming Department.

### COLLINS RADIO COMPANY

Cedar Rapids, Iowa  
*An equal opportunity employer.*

CIRCLE 75 ON READER CARD

## DO MORE - SAVE MORE with ALUMA-PLANK FLEXIBLE COMPUTER FLOORS

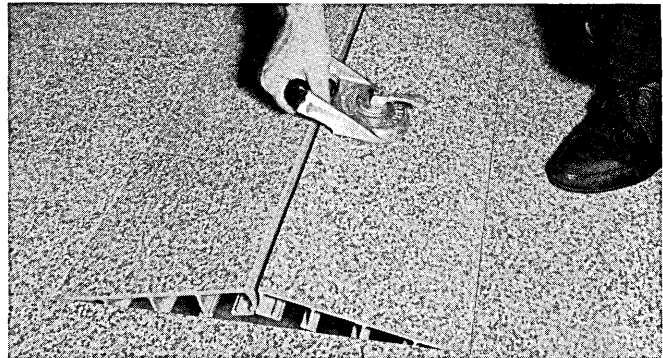

MODULAR elevated infinite access FLOORING SYSTEMS of light weight extruded aluminum offer:

- EASE OF OPERATION — Maximum under-floor accessibility; Simplified relocation.
- NO TOP CONNECTIONS — Panels are removed by suction cups, leaving floor area clear.
- AUTOMATIC RELOCATING CAM ACTION — Planks repositioned accurately for complete stability.
- SMALL MODULES — Multiples of 9" widths reduce waste and lessen area affected by relocations.



ITEECO, A Division of Idaho Maryland Industries Inc.  
12906 Saticoy, North Hollywood, California, TRIangle 7-9821

CIRCLE 23 ON READER CARD

**DATAMATION**

computers and one digital computer with analog attachments.

The computers include the Ferranti Mercury, E.M.I. Emiac II, Ferranti ATLAS, IBM 704, E.A.I. Pace, IBM 1620, English Electric DEUCE, Elliott 609, IBM 7090, and Ferranti Mk. 1.

● Net earnings for IBM for the nine months which ended Sept. 30, 1961 were \$152,887,977 as compared with the earnings for the corresponding 1960 period of \$119,088,057. The 27,533,769 shares outstanding at the end of the 1961 period sold for \$5.55 per share while the 27,453,087 shares for the 1960 period were \$4.34, adjusted for the stock split.

● Control Data Corporation has granted a graduate research fellowship to the University of Minnesota Institute of Technology. The first award of \$5,000 was given to Juri Matisoo who will pursue research in the areas of integrated circuitry, and thin film memory techniques.

● Three regional Field Support Centers have been established by

General Electric Company's Computer Department for installation, service and maintenance of all computer installations. The new centers will be located in Los Angeles, Chicago and Hartford, Conn. G. E. has also announced plans to establish a computer center at Tempo, the company's long range planning and advanced engineering organization in Santa Barbara, Calif.

CIRCLE 118 ON READER CARD

● The first edp system in South Asia, an IBM 1401, has been set in operation in India by Standard-Vacuum Oil Company and will supersede electric accounting machines in handling record keeping and statistical analyses. In the near future the company will install three additional 1401s in Cape Town, Melbourne, Australia and Sungei Gerong, Indonesia.

● An analog-to-digital converter and scanner has been purchased by the University of Texas Medical Center from Dresser Electronics' SIE Division in Houston. The equipment will be used to obtain information to be used in the analysis of heart malfunctions and disease.

CIRCLE 119 ON READER CARD

● An IBM 7080 has been installed in the Hughes Aircraft Co., Los Angeles, Calif., where, together with three 1401s, it will handle information for the company's facilities in Arizona, Idaho and Southern Calif. The 7080 will be used for management control, clerical chores, and aerospace research. It is the first 7080 installation in California.

CIRCLE 120 ON READER CARD

● Control Data Corporation has recently formed a Peripheral Equipment Division for providing a complete line of I/O equipment to be supplied with the company's digital computers.

CIRCLE 121 ON READER CARD

● The Metropolitan Computer Assoc. (MCA) serving the New York metropolitan area was founded earlier this year and has featured such speakers as J. W. Mauchly and Ascher Opler. G. T. Martin, C-E-I-R, is president of the group.

● An auto-instructional systems division for development of programs for using electronic techniques in automated teaching has been established by the Burroughs Corp. Dr. Felix F. Kopstein, an experimental psychologist, will be director of the division.

CIRCLE 122 ON READER CARD

## AN/FSQ-7

COMPUTER PROGRAMMERS AND  
ANALYSTS FOR EXPERIMENTAL  
REAL-TIME CONTROL SYSTEMS

THE  
**MITRE**  
CORPORATION

An equal opportunity employer

The MITRE Corporation is expanding its efforts on the design and development of computer programs for experimental large-scale real-time control systems:

**SATIN (AIR TRAFFIC CONTROL)**  
**MILITARY COMMAND AND CONTROL**  
AIR DEFENSE  
COMMAND POSTS  
INTELLIGENCE PROCESSING

Opportunities exist at MITRE's development facilities in Bedford, Massachusetts for both senior and junior personnel experienced in AN/FSQ-7 operational and utility programming and analysis.

Personnel with comparable experience in programming for other computing systems are also invited to apply.

WRITE IN CONFIDENCE TO: Technical Director, Systems Engineering, The MITRE Corporation, Post Office Box 208, Dept. MZ9, Bedford, Massachusetts.

CIRCLE 82 ON READER CARD

the lifeline of commerce

# COMMUNICATIONS

SYSTEMS PLANNING

Our client, a leader in the Commercial Information Processing Systems Field is seeking specialists...

- **TO PLAN** data communication networks using telegraph, voice grade or wide band data transmissions techniques to meet system requirements of response time, traffic capacity and cost.
- **TO TEST** data communications facilities to determine characteristics such as error rates, reliability, etc.
- **TO APPLY** mathematical models to the design of communications networks.
- **TO WORK** on data transmission coding techniques.

*Salaries are open to \$30,000*

If you seek analytical stimulation, creative leeway and an environment which encourages both—write for personal interview, including a complete resume of your background.

MR. DWIGHT L. GREENLAND  
*Executive Vice President*

HAMILTON WITTMAN ASSOCIATES

*Management Consultants*

551 Main St., East Orange, N.J.

*Our client is an equal opportunity employer*



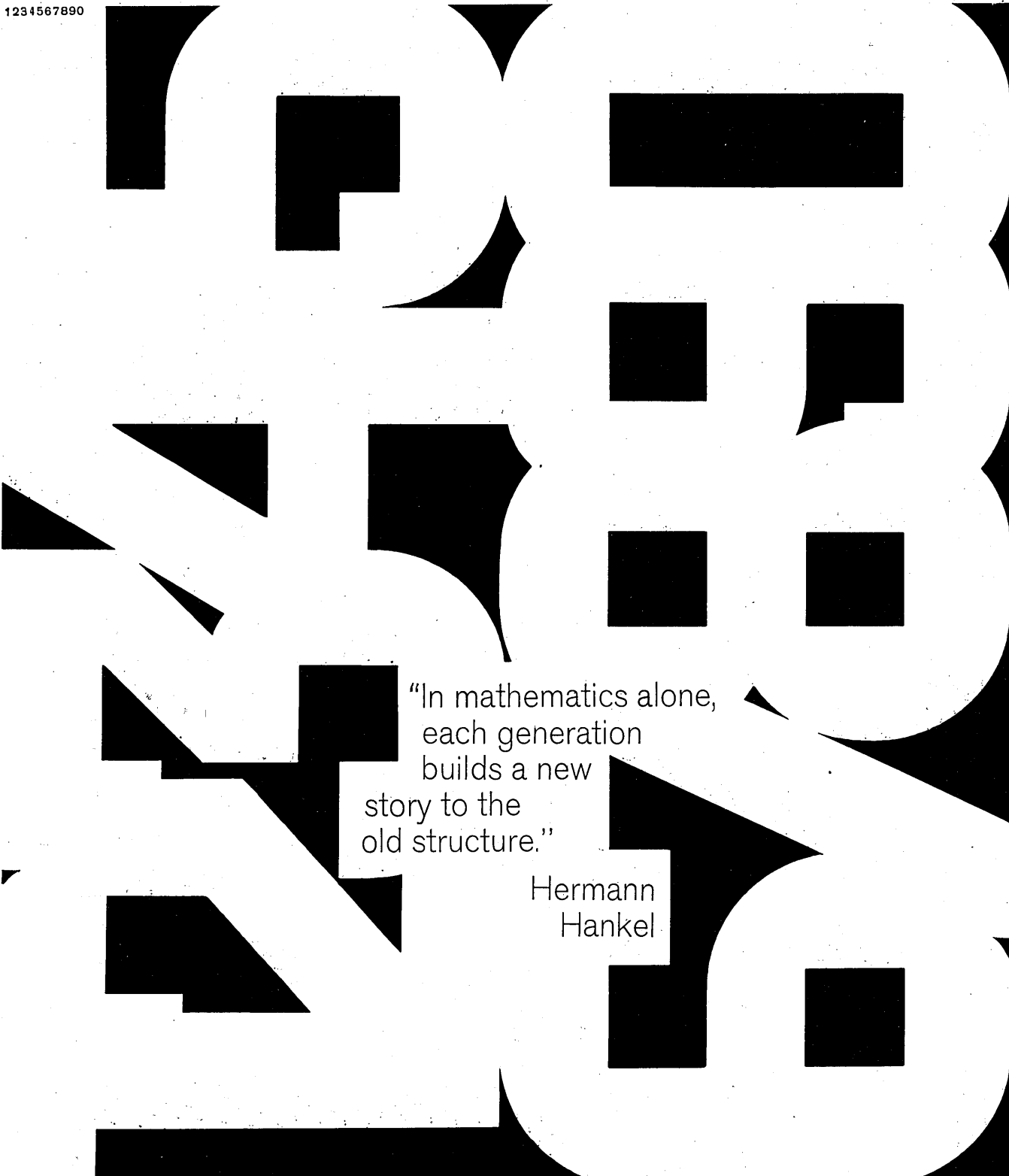

"In mathematics alone,  
each generation  
builds a new  
story to the  
old structure."

Hermann  
Hankel

IBM mathematicians and programmers are doing work today that will still have meaning years from now.

They are, for example, teaching computers to work out proofs for theorems in Euclidean geometry. They are applying new techniques to problems in symbolic logic originally outlined by Russell and Whitehead. They are crossing into frontier territory in the fields of automatic storage allocation...lexical processing...and in almost every other area of applied and applications programming.

IBM regards programming and programming research as essential to its future growth. At IBM, mathematicians and

programmers have at their disposal the machine time they need for the full development of their ideas. And they have before them unusual opportunity for professional growth and personal advancement.

If you'd like to know more about the stimulating and rewarding work at IBM, we'd like to hear from you. All applicants for employment will be considered without regard to race, creed, color or national origin. Write to:

Manager of Technical Employment  
IBM Corporation, Dept. 701 M  
590 Madison Avenue  
New York 22, N. Y.

**IBM**  
®

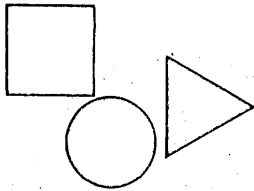

# NEW PRODUCTS

## binary to bcd converters

The design of a new direct binary to bcd converter is based on a parallel conversion without the use of traditional counting methods. The converters can be used with computers and/or angular position encoders to oper-

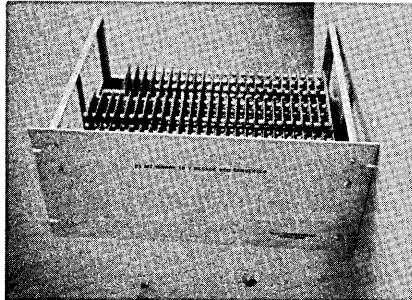

ate readout and/or other peripheral devices and are available for conversion from 7 bits to 23 bits. WANG LABORATORIES, INC., 12 Huron Dr., Natick, Mass. For information:

CIRCLE 200 ON READER CARD

## control computer

The RW 530 industrial computer, with stored logic, parallel operation, large core memory and microsecond operating speeds can communicate directly with process instruments and controls through analog and digital I/O equipment. Word length of the 530 is 18 bits, and up to 32K words can be stored in the memory which has a cycle time of six microseconds per word. THOMPSON RAMO WOOLDRIDGE INC., 8433 Fallbrook Ave., Canoga Park, Calif. For information:

CIRCLE 201 ON READER CARD

## pulse-pattern generator

The major element of the model B pulse-pattern generator is a magnetic peg board that controls 10 separate outputs, each with 64 serial bits individually selected by small, permanent, magnet plugs inserted in the peg board according to the desired pat-

tern. Each output can have up to 512 serial bits and triggering can be internal or external, with a maximum serial repetition rate of more than 250 kc. CYBETRONICS, INC., 132 Calvary St., Waltham, Mass. For information:

CIRCLE 202 ON READER CARD

## rewinding paper-tape reeler

A unidirectional paper-tape reeler with rewind, model RS-200, can supply tape at any speed up to 40 inches per second and can rewind at speeds

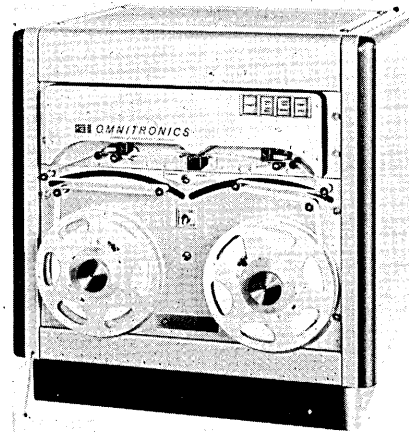

from 45-60 ips. The reeler features positive prevention of tape breakage. OMNITRONICS, INC., 511 N. Broad St. Philadelphia 23, For information:

CIRCLE 203 ON READER CARD

## systems cards

Ten MC systems cards have been added to the Welded Circuit product lines. This DC10C series is directly compatible with series DC2C, a two MC series, and DC1C, a 100 KC series. The cards offer flip flops, gates, amplifiers, input-output circuits, shift registers, etc., and are 2.75" x 5.5". Each circuit card mounts from two to four standard modules. CONTROL LOGIC, INC., 11 Mercer Rd., Natick, Mass. For information:

CIRCLE 204 ON READER CARD

## thin-film memory

A 166,000 binary digit thin-film memory, developed for use with miniaturized computers, measures only one-third cubic foot, including associated circuits. With the exception of 256 words, all others stored in the memory are available for use with an as-

**M** **Growth Potential for**  
**MATHEMATICIANS, PROGRAMMERS,**  
**ELECTRONIC ENGINEERS**  
**in Data Reduction**

Telecomputing Services, Inc., New Mexico Division, is located at Holloman Air Force Base in Southern New Mexico on the White Sands Missile Range. Working with high-speed digital computers, we perform vital functions in the reduction, analysis, and evaluation of data gathered from various instrumentation systems used on the Range in support of missile test programs. Our continuing growth is creating exciting and challenging new positions for qualified data systems engineers in the fields of missiles, satellites, and space travel. You are invited to investigate the opportunities for *your* future with Telecomputing Services, Inc.

- Pleasant Modern Facility
- Attractive Salaries
- Group Insurance
- Professional Working Atmosphere
- Relocation Pay
- Educational Reimbursement
- Profit Sharing

For Application and Further Information, write  
 Director of Technical Personnel at:

**tsi TELECOMPUTING SERVICES, INC.**  
 SUBSIDIARY OF  
 TELECOMPUTING CORPORATION  
 BOX 447-E, HOLLOMAN AIR FORCE BASE, NEW MEXICO

CIRCLE 78 ON READER CARD

# a major advance in Digital Control

## NEW LOW COST DIGINAMICS DIGITAL TRANSDUCERS

OFFERING . . .



### TRUE SYSTEM COMPATIBILITY

Each component is capable of operating individually or collectively with any digital controller or data recorder. Outputs from each component are conventional D-C level code. Optional outputs as follows: Parallel, serial (forward or backward) and sample storage.



### IMPROVED RELIABILITY

Complete value readout eliminates error often present with incremental readout. Direct digital transduction and transmission of relatively high voltage signals require fewer piece parts. Error buildup is reduced by eliminating additive conventional analog tolerances. Output signals are capable of transmission over long lines.



### COST-SAVING SIMPLIFICATION

The usual millivolt switching, operational D-C amplifiers, voltage to frequency converters, frequency counters and voltage to digital converter equipments are no longer necessary.

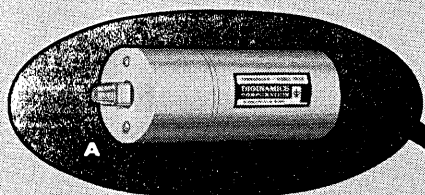

**A Pressure to Digital Transducer — Models 2012-2030**  
Vacuum, absolute, gauge and differential pressure ranges  
Complete value digital output, parallel or serial

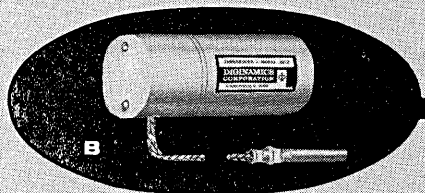

**B Temperature to Digital Transducer — Models 3012-3030**  
Direct to 200°F. Remote to 2200°F.  
Complete value digital output, parallel or serial



**C Shaft Position to Digital Transducer — Model 4012**  
Forward or Backward rotation  
Divides one revolution into 1024 parts  
Load torque less than 0.1 gram-centimeters  
Complete value digital output, parallel or serial

**D Parallel to Serial Converter (Serializer) — Model 5012**  
Convert any number of parallel bits to serial data — most significant bit first or least significant bit first  
Conversion from reflected binary to binary code if desired  
Optional sample storage, parallel or serial output



**E Sampling Multiplexer — Model 6012**  
Completely solid state  
Basic unit accepts 16 inputs  
Additional inputs may be added in multiples of 16  
Input and output levels adjustable

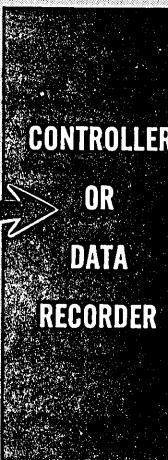
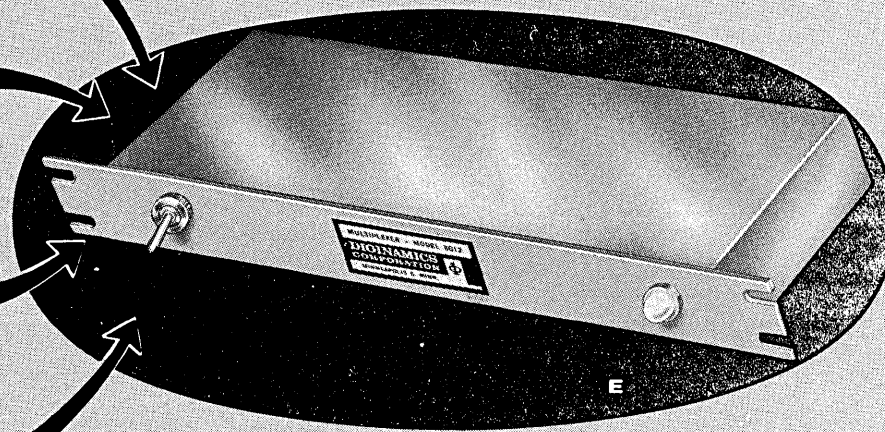

#### NOTE:

Units shown in this ad are 1/5 actual size.

Basic units operate over range —40°F to +158°F ambient.

Higher temperature ranges available.

Write today for specifications and prices.

## DIGINAMICS CORPORATION

2525 East Franklin Ave. Dept. D Minneapolis 6, Minn.



DIGITAL INSTRUMENTATION  
DIGITAL TRANSDUCERS  
DIGITAL CONTROL SYSTEMS

CIRCLE 25 ON READER CARD

## NEW PRODUCTS . . .

sociated computer on a non-destructive read-out basis.

Among the features of the memory is the ability to operate over a wide temperature range and to be subjected to shock and vibrations without damaging the stored contents. Also, switching-time can be reduced to nanoseconds. The thin-film memory is produced by mass assembly techniques and has very low power requirements. UNIVAC, MILITARY DEPT., St. Paul 16, Minn. For information:

CIRCLE 205 ON READER CARD

### 5-mc digital modules

A new series of S-PAC digital plug-in packages operate in the frequency range of dc to five megacycles and feature transistor logic. The modules have high package density and can

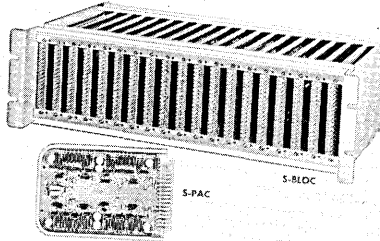

be used with high speed digital computers. Analog to digital converters, digital to analog ladder networks, flip-flops and several special circuit boards, etc., are included in the line. COMPUTER CONTROL CO., INC., 983 Concord St., Framingham, Mass. For information:

CIRCLE 206 ON READER CARD

### 60 cps tape perforator

An asynchronous 60 cps tape perforator, type 61-A, is designed as an auxiliary device for computers, data logging, machine control, automatic

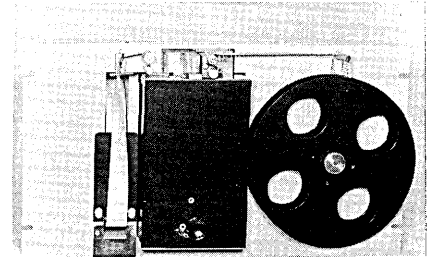

test and simulating, and other data recording systems. INFONETICS CORP., 7617 Hayvenhurst Ave., Van Nuys, Calif. For information:

CIRCLE 207 ON READER CARD

### Recomp x-y plotters

A digital high-speed plotter, the RECOMP X-Y, will accommodate any analytical or discontinuous function and present this information in graphic form. The RECOMP X-Y plots in 1/100th inch increments at speeds of 200 increments per second

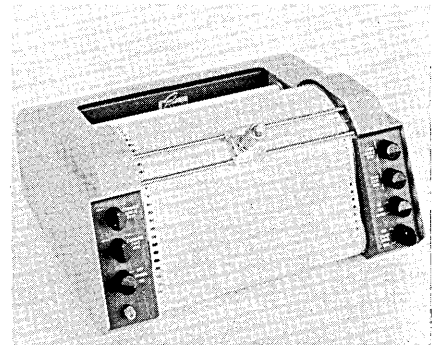

at .01-inch resolution. Eight directional movements, controlled by 10 programming commands are offered. AUTONETICS INDUSTRIAL PRODUCTS, 3400 E. 70th St., Long Beach 5, Calif. For information:

CIRCLE 208 ON READER CARD

### interstage delays & flip flops

Model M11 interstage delay module is used with the model M10 one-megacycle flip-flop module and has five inductive delay circuits which provide a filed delay of .75 microseconds for each interstage carry pulse from the M10. The flip-flop module has five identical flip-flops which will operate as a counter at rates up to

The key to successful computer application. . .

## EXPERIENCED TECHNICAL SUPPORT

### Systems Development:

real-time • commercial • scientific

### Programming:

analysis • design • integration • checkout

### Software:

compilers • generators • utility • input-output • simulation • executive systems

### Hardware:

requirements analysis • system-organization • command repertoires

### Subsystems:

engineering design • development • manufacture • installation

### Training • Feasibility Studies •

Demonstrations • Equipment-Evaluation • Diagnostics

**NATIONAL COMPUTER ANALYSTS, INC.**

Main Office: 206 Center, Princeton, New Jersey Walnut 1-9078  
N.Y. Office: 107 Mamaroneck Ave., White Plains, New York • ROckwell 1-1998  
Affiliate: Ess Gee, Inc., 15 Havens St., Elmsford, New York

Inquiries invited from qualified professionals in the use of large-scale digital computer systems. Positions available in Princeton and White Plains.

For Product Information Circle 26 on Reader Card

For Recruitment Information Circle 79 on Reader Card

two megacycles, and when used with the M11, it forms a parallel-entry adder which will complete a five-bit addition in less than four microseconds. NAVIGATION COMPUTER CORP., Valley Forge Industrial Park, Norristown, Pa. For information: CIRCLE 209 ON READER CARD

**tape preparation system**

An automatic tape preparation system converts numerical test data into punched tape. Automatic error-detection devices are featured in the solid state system which can perforate up to eight channels of tape from a keyboard which includes editing features.

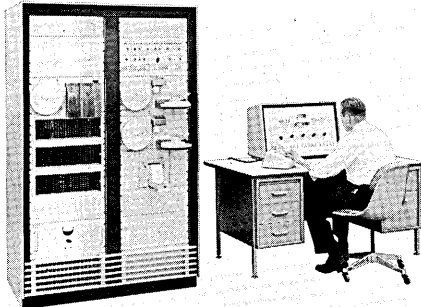

Tape is duplicated at 60 characters per second with or without verification with another tape. ASTRODATA, INC., 240 East Palais Rd., Anaheim, Calif. For information: CIRCLE 210 ON READER CARD

**tunable ferrite pot cores**

Three tunable ferrite pot cores, for use with inductors with close permeability tolerances, have high "Q" for applications up to three Mc, have good linear temperature stability and feature convenient hardware and easy vernier adjustment. The units have a minimum tuning range of 14% with a final adjustment accuracy of 0.02% FERROXCUBE CORP., Saugerties, N.Y. For information: CIRCLE 211 ON READER CARD

**symbol generator**

A symbol generator for cathode ray tube displays and two complementary units, a line generator and a format generator, are now available. The digitally driven generator has a 64 character repertoire which can be expanded to 128 characters without core storage modification. Each symbol can be made from up to 20 connected straight line segments and each segment can be independently oriented in direction and length which results in 24 display combinations. STRAND ENGINEERING CO., A DIV. OF DATRONICS ENGINEERS, INC., P. O. Box 76, Ann Arbor, Mich. For information: CIRCLE 212 ON READER CARD

memory me  
 memory memory m  
 memory memory memory m memory memo  
 memory memory memory memory memo memory mem  
 memory m memory  
 ory memory  
 emory memory  
 ory memory m  
 y memory mem  
 ory memory memo  
 mory memory memo  
 memory memory me  
 ry memory memory m  
 mory memory  
 ory memory memory memory memory  
 ry memory memory memory memory memory  
 memory memory, memory memory memory m ory  
 mory memory, memory memory memory  
 ory memoy, ory memory memory  
 emory memory mem  
 ory memory memo  
 mory memory me  
 y memory me or  
 memory mem  
 emory memor  
 memory mem  
 ory memory  
 ory memory  
 memory me  
 y memory memo  
 ory memory m  
 memory me  
 emory me

# CORE FACT

## elephants and EECO magnetic core memories never forget

EECO Magnetic Core Memories are the result of a decade of experience in data processing systems design and construction. EECO Magnetic Core Memories are built by data processing systems engineers for data processing systems engineers with greater reliability as a goal. Character capacity from 128 to 2048; 8 levels per character in all models. Random access (R), sequential access (S), and sequential interlace (SI) models. 200-kc, 5-microsecond operation. Non-destructive unload. Separate input and output registers. Power consumption a low 120 watts. Noise rejection input circuits. Time-saving, self-check features with visual indicators; automatic test of entire memory at 200-kc rate, and manual step-by-step test. 19" wide by 7" high by 18" deep. 32 pounds. All solid-state circuits on plug-in cards. Write for details.

CHARACTER CAPACITY	MEMORY MODELS		
	RANDOM ACCESS	SEQUENTIAL ACCESS	SEQUENTIAL INTERLACE
128	8-128R	8-128S	8-128SI
256	8-256R	8-256S	8-256SI
512	8-512R	8-512S	8-512SI
1024	8-1024R	8-1024S	8-1024SI
2048	8-2048R	8-2048S	8-2048SI

 **Electronic Engineering Company** of California  
 1601 East Chestnut Avenue, Santa Ana, Calif. • KImberly 7-5501, P.O. BOX 58  
 Representative in Western Europe and Israel: Electronic Engineering S. A., CP. 142 Fribourg, Switzerland  
 Digital Circuit Modules: Engineered Electronics Company, Santa Ana

CIRCLE 27 ON READER CARD

# ANELEX®



**Anelex High Speed Line Printers**  
are standard equipment in the  
data processing systems of  
almost every major computer  
manufacturer here and abroad.



Further information available upon request

**ANELEX CORPORATION**

155 Causeway Street, Boston 14, Massachusetts

CIRCLE 28 ON READER CARD

## NEW FIRMS & mergers in DP

■ An affiliation has been made between National Computer Analysts, Inc., Princeton, N. J., and Ess Gee, Inc., Elmsford, N. Y. for the purpose of improving their client services. NCA is primarily engaged in the performance of applications analysis, design and programming of digital computer systems, and Ess Gee designs, fabricates and installs digital instrumentation systems and subsystems for governmental and commercial applications.

CIRCLE 100 ON READER CARD

■ A new firm has been established in Dallas, Texas, by John K. Paden, edp consultant, to assist businesses in planning and programming edp systems. The Paden firm will also assist with existing systems in analyzing applications and programming. Services offered include cost analysis and training company employees to operate equipment.

CIRCLE 101 ON READER CARD

■ Computers For Industry, & Business, Inc. is a new consulting firm in New York City. CIB specializes in programming services for both scientific and commercial users. Principals are George J. Hsieh formerly with Union Carbide Corp., and Bernard A. Goldberg formerly of IBM.

CIRCLE 102 ON READER CARD

■ Scientific Development Corp., a new company which has entered the field of scientific educational devices, has established offices in Watertown, Mass. The company's first product is a digital computer simulator which was developed by Dr. Claude E. Shannon of M.I.T. Officers of the company are Arnold E. Amstutz, president; William H. Seaver, vice president for production; Willard W. Dickerson, treasurer; and Jack E. Stover, marketing director.

CIRCLE 103 ON READER CARD

■ A wholly-owned subsidiary has been formed in Aachen, West Germany, by Electronic Associates, Inc., to handle sales of its instrument line in that country. Included in the line is the desk-top TR-10 analog computer, plotting boards and other instruments in the analog field. It is estimated by EAI that more than \$3 million of analog equipment will be sold in Europe during 1961.

CIRCLE 104 ON READER CARD

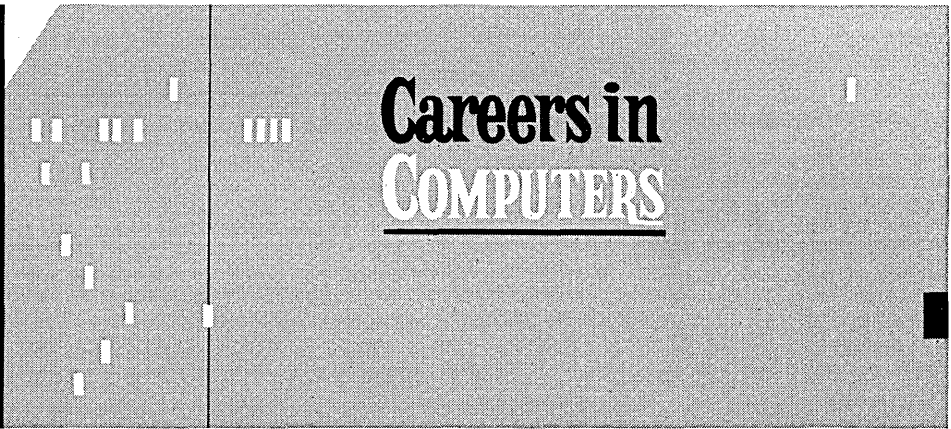
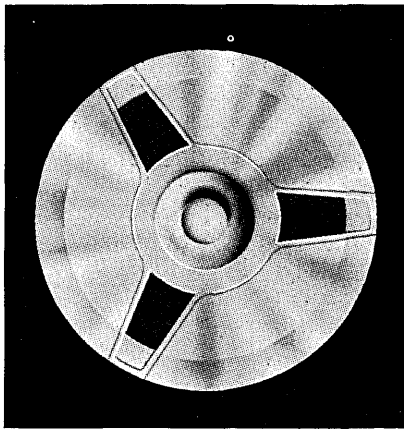

## COMMUNICATIONS ENGINEERS

Experienced in Telegraph Systems, Data Transmission, Switching Systems, Transmission Systems, Communications Planning, to work on the development of new large-scale, communications based data processing systems for unique business and industrial applications. . . . . \$17,000

## SYSTEMS PLANNERS

Experienced in machine organization and design of multi-terminal business systems with particular emphasis in communications. Will specify optimum configurations of system components to solve actual and hypothetical problems. Degrees in Electrical Engineering, Mathematics or Physics. . . . . to \$16,000

## SYSTEMS-INDUSTRY ANALYSTS

Experienced men with particular "industry" background. Ability to determine the proper data processing system for a specific industry or determine if a unique system should be designed. Should have knowledge of at least one computer manufacturer's equipment and the capabilities of such equipment. . . . . to \$15,000

## PROGRAMMERS

Experience to include programming on large scale equipment with programs and applications of a Business, Scientific, or Engineering nature. 7090 experience preferred. . . . . to \$13,000

*Our client, a leader in the data processing field, is presently expanding a major division (East Coast location). Professionals whose interests and qualifications are in the above areas, please submit complete resume with salary requirements to:*

**DATAMAN\***  
ASSOCIATES  
PERSONNEL CONSULTANTS

6 Beacon St., Boston, Mass. - Richmond 2-1932

*\*DATA MANAGEMENT... Recruiting Specialists for Data Processing and Computer Personnel Exclusively.*

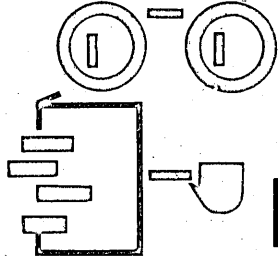

# NEW LITERATURE

**AUTOMATION & INTELLIGENCE:** This pamphlet discusses the intelligence cycle and automation, method lag, technique acceleration, technique bias and compatibility. **PLANNING RESEARCH CORP.**, 1333 Westwood Blvd., Los Angeles 24, Calif. For copy:

CIRCLE 130 ON READER CARD

**COMPUTER RESEARCH:** Research reports on such topics as learning machines, reading and teaching machines, speech analysis and synthesis are given in this bibliography. Translations of foreign technical literature on computer research in medicine and human engineering are also included. For copy of this report send 10¢ to **OTS, BUSINESS & DEFENSE SERVICES ADMINISTRATION**, U. S. DEPT. OF COMMERCE, Washington 25, D. C.

**ANALOG-TO-PULSE DURATION SYSTEM:** A folder describes a new 10-channel analog-to-pulse duration system for direct digital conversion of analog input from d.c. sensing devices. Operation and capabilities of the system are given as well as a block diagram of typical temperature monitoring application and performance specifications. **GENISCO, INC.**, 2233

CIRCLE 131 ON READER CARD

**MATERIALS INFORMATION PROCESSING CAPABILITY:** This report gives detailed information on a proposal to establish a "materials information processing capability." The proposed super-library would make a wide variety of scientific and technical information in libraries and information centers scattered around the country readily available to researchers. Computers would be used to sift descriptive in-

formation and empirical data to provide information for the particular problem in question. For a copy of this report send 50¢ to **OTS, U. S. DEPT. OF COMMERCE**, Washington 25, D. C.

**OPTICAL SCANNERS:** This brochure gives information on what the optical scanner reads, what it reads from, how it reads, source devices, additional functions of the reader, input system elements, and applications. **FARRINGTON ELECTRONICS INC.**, 7019 Edsall Road, Alexandria, Va. For copy:

CIRCLE 132 ON READER CARD

**SELECTION GUIDE:** The guide is available for the selection of solid state power supplies and transducer control modules for telemetry, data process-

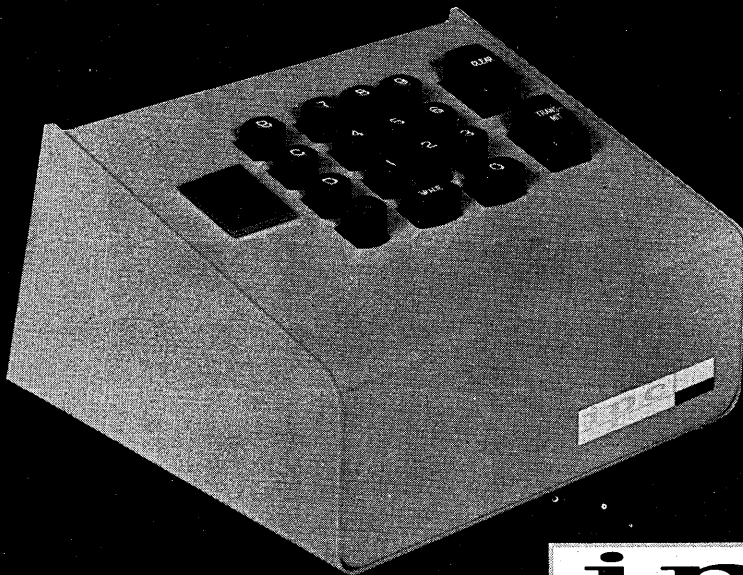

## MAGNETO-MECHANICAL KEYBOARD

The new IPC Model EK-176 Coding Keyboard is a magnetically-actuated mechanical-matrix device that guarantees the longest life, highest reliability and lowest cost available anywhere today . . . Just compare these features —

- 25,000 hours of trouble-free operation
- Under \$75.00 per unit in quantity
- Available from stock
- Less than 5 microseconds contact bounce
- Custom output coding — at no extra cost
- 100% dependability — at any operating speed

Other features of the all-new Model EK-176 include — individual hermetically-sealed, magnetically-actuated contacts . . . and fail-proof mechanical interlocks.



If you use keyboards, investigate this one. Write or call IPC today for complete specifications and ordering data.

**INFORMATION PRODUCTS CORPORATION**  
156 Sixth Street, Cambridge, Massachusetts  
Area Code 617 • Telephone ELiot 4-1206



ing and laboratory testing applications. A variety of isolated power supplies are also covered. VIDEO INSTRUMENTS CO., INC., 3002 Pennsylvania Ave., Santa Monica, Calif. For copy:

CIRCLE 133 ON READER CARD

**COMPUTER BIBLIOGRAPHY:** This bibliography lists translations of foreign technical literature and government-owned patents available for license on computers. Research reports of various government agencies are given and topics covering solid-state computers, high speed computer systems, modular transistorized circuits, etc., are included. For a copy of this report send 10¢ to OTS, BUSINESS & DEFENSE SERVICES ADMINISTRATION, U. S. DEPT. OF COMMERCE, Washington 25, D. C.

**AUTOMATIC CHARACTER RECOGNITION:** A 168-page state-of-the-art report on character recognition reviews some recent developments in dp techniques and covers both optical readers now in actual field use for applications which involve limited character vocabularies or specialized fonts, and operational prototypes of mechanisms

which are able to read printed or typed pages.

The purpose of the report is to contribute to the improvement of cooperation in the fields of information retrieval research, information selection systems, and mechanized translation. OTS, BUSINESS & DEFENSE SERVICES ADMINISTRATION, U. S. DEPT. OF COMMERCE, Washington 25, D. C. For copy:

CIRCLE 134 ON READER CARD

**DIGITAL CIRCUIT MODULES:** An eight-page brochure describes two megacycle miniature welded digital circuit modules and card mounted modules from basic circuits to accessories. CONTROL LOGIC INC., 11 Mercer Rd., Natick, Mass. For copy:

CIRCLE 135 ON READER CARD

**DATA-LOGGER BULLETIN:** This bulletin discusses functions, data collection and presentation, applications, cost, design, options and maintenance of data loggers. Log sheets, punched cards and punched tapes are also discussed and illustrated. THE BRISTOL CO., Waterbury 20, Conn. For copy:

CIRCLE 136 ON READER CARD

**DATA PROCESSING APPLICATIONS:**

The sixth edition of "IDP Products in Action" presents 32 pages of systems applications involving the company's paper tape-operated business machines. Illustrations and explanations of the systems are included. PROMOTION PLANNING DEPT., FRIDEN, INC., 97 Humboldt St., Rochester 2, N. Y. For copy:

CIRCLE 137 ON READER CARD

**PORTABLE DATA GATHERING:** A four-page brochure describes the model S-3100 portable data gathering system. Weighing less than 130 pounds, the S-3100 can record up to 100 analog voltage inputs on tape in suitable format for direct entry to a digital computer. EPSCO INC., SYSTEMS DIV., 275 Massachusetts Ave., Cambridge 39, Mass. For copy:

CIRCLE 138 ON READER CARD

**G-20 SYSTEM:** An illustrated 19-page booklet describes information flow, accessories, programming and specifications of the G-20 system. BENDIX COMPUTER DIV., 5630 Arbor Vitae St., Los Angeles 45, Calif. For copy:

CIRCLE 139 ON READER CARD

**RANDOM ACCESS FILE INTERROGATOR**

Here is the only practical data-entry-and-display device available today — for those applications where high-speed man-machine communications is a must . . . With the IPC Numeric Interrogator an IR Specialist or data handling clerk can: (1) receive in seconds up-to-the-minute visual data from a remote central file . . . (2) add new information to the file . . . (3) up-date,

modify, delete stored data . . . (4) add new information to a received message and then re-transmit the entire new communication. And note these important user features:

- Up to 20 Interrogators can share the same communications link — each on a private line basis
- The CRT display will accommodate up to 200 alphanumeric characters
- Can be used with any existing random access file computer
- Remote linkage via direct wire or ordinary telephone line
- Variable character transmission rates up to 100 KC
- Less than \$100 per month per Interrogator — Custom coding at no extra cost
- Available through direct purchase or convenient lease plans

Write or call IPC today for a copy of Interrogators and Interrogator Systems.

INFORMATION PRODUCTS CORPORATION  
156 Sixth Street, Cambridge, Massachusetts  
Area Code 617 • Telephone ELiot 4-1206

CIRCLE 31 ON READER CARD



← CIRCLE 30 ON READER CARD

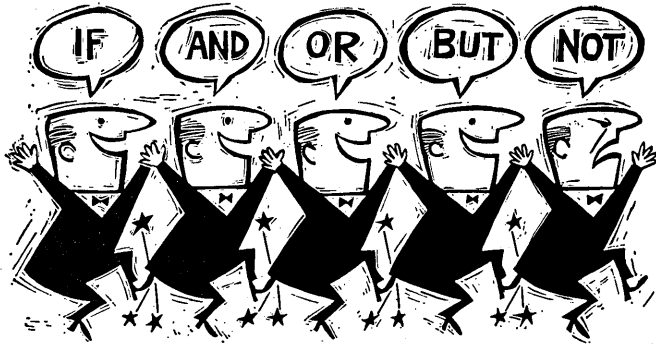

### LOGIC

Disciples of George Boole and John Venn: We have basic design positions in system organization and logic for large-scale, real-time, airborne computers. Experienced logic designers and theoretical mathematicians are invited to write to Mr. Harry Laur.

An equal opportunity employer



LITTON SYSTEMS, INC. Data Systems Division  
Canoga Park, California

■ Erwin Tomash, v.p. and manager of the Computer Products Division of Ampex, has announced his resignation as of Dec. 31st. Tomash will be retained by Ampex on a consulting basis to his successor, Edward R. Gamson, who was formerly manager of the Components Division of Ampex.

■ Advanced Scientific Instruments, Minneapolis, has established a programming department and has appointed Ernest E. Haight, manager of programming development; Irving B. Elliott, senior systems analyst; and Charles F. Blumke, programmer.

■ Four new program analysts including J. L. Patterson, Ronald Hope, Joseph LaHood, and Monroe Novell have been named to the staff of Computer Concepts, Inc., Washington, D. C.

■ Charles L. Cave has been appointed director of systems engineering for Machine Translation, Inc. Cave was previously a staff systems engineer for IBM, where he was engaged in the analysis and design of various military dp systems.

## UNIQUE CAREER OPPORTUNITY FOR PROGRAMMER ANALYSTS

National management consulting firm (ACME member) is expanding its computer applications services into programming. Assignments will include a wide variety of client business applications in distribution, banking and manufacturing on all types of digital systems. Key positions are now available in several locations across the country. This is a new and unique opportunity for professional growth and advancement offered to career programmer-analysts.

- **SENIOR PROGRAMMER-ANALYSTS**—College degree with graduate degree desirable. Minimum five years experience, including some supervisory experience, with more than one machine and language. Strong interest and knowledge in at least one specialized area of programming. Exposure to pre-programming analytical work.
- **JUNIOR PROGRAMMER-ANALYSTS** — College degree desirable. Minimum of two years experience in at least one machine and language.

Interested applicants should submit their qualifications in writing to

Box 311, Datamation Magazine,  
141 East 44th St., New York 17, N. Y.

All inquiries will be handled in complete confidence.

## You Get Things Done Better By Seeing What's Happening

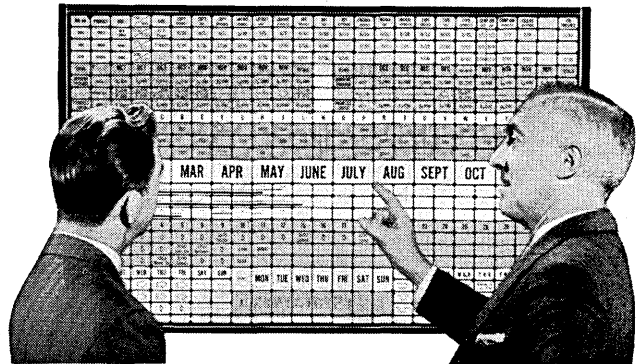

### BOARDMASTER VISUAL CONTROL

- ★ Gives Graphic Picture of Your Operations in Color.
- ★ Facts at a Glance — Saves Time and Prevents Errors.
- ★ A Simple, Flexible Tool — Easily Adapted to Your Needs.
- ★ Easy to Use. Type or Write on Cards, Snap on Board.
- ★ Ideal for Production, Scheduling, Sales, Inventory, Etc.
- ★ Compact, Attractive. Made of Metal. 500,000 in Use.

Complete Price **\$4950** Including Cards

**FREE**

24-Page ILLUSTRATED BOOKLET CG-20

Without Obligation

GRAPHIC SYSTEMS, Yanceyville, North Carolina

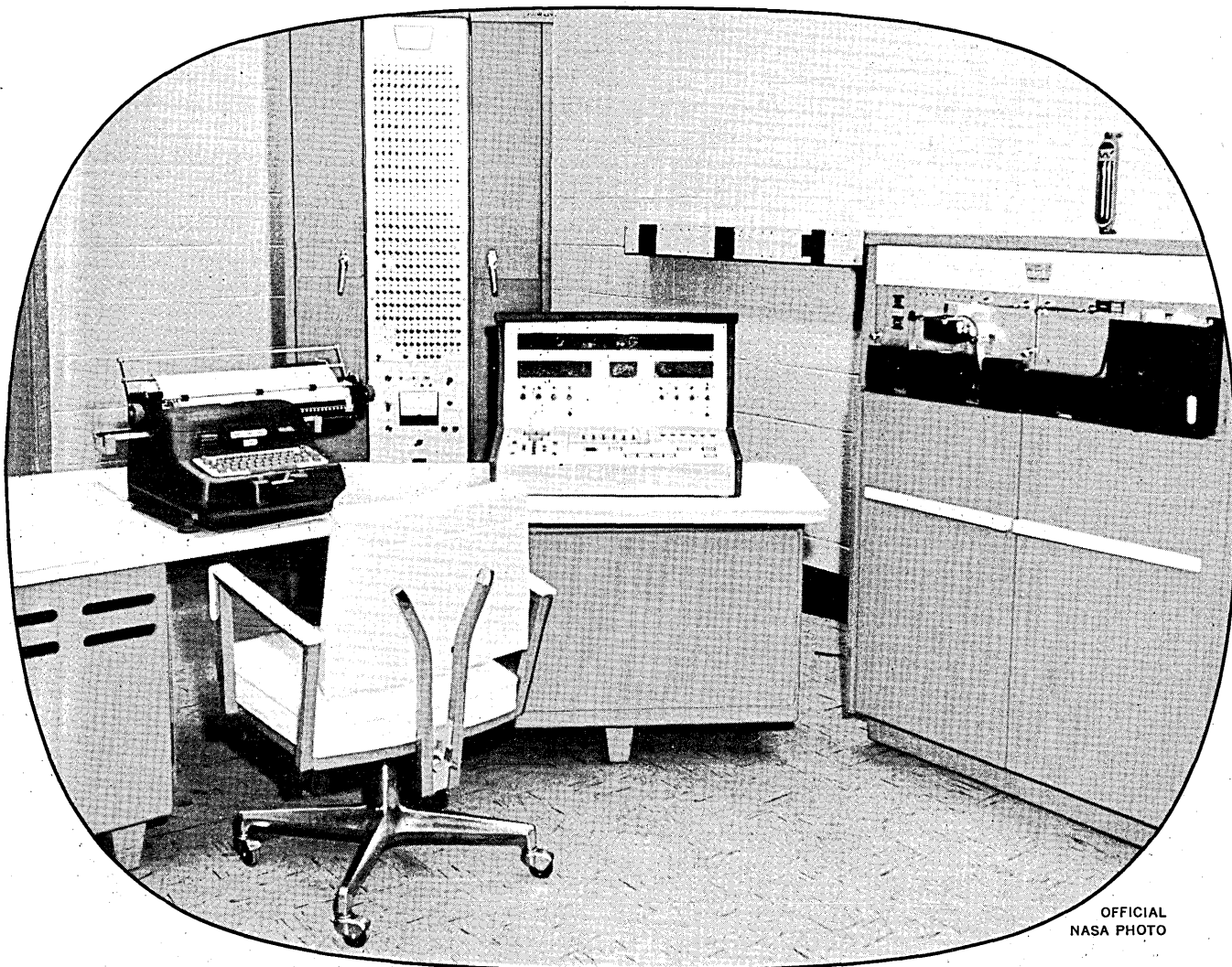

OFFICIAL  
NASA PHOTO

## General Mills Computers to Process Data from NASA's Orbiting Astronomical Observatory

When the National Aeronautics and Space Administration launches its first OAO satellite late in 1963, General Mills AD/ECS-37 computers will perform data reduction and processing of information telemetered from the satellite. The first such computer, produced by the General Mills Electronics Group, has been delivered to the Goddard Space Flight Center at Greenbelt, Md. Identical computers, now being constructed, will be installed at ground stations in NASA's minitrack network.

The AD/ECS-37 is a solid state, parallel, gen-

eral purpose digital computer system. It can be adapted readily to fit specific applications. Low cost "customization" has been made possible by the use of plug-in, printed circuit instruction cards. It has a 36-bit (plus sign) word length and utilizes a 4,096 word random access magnetic core memory (expandable to 8,192 words). The computing system has a simultaneous input-output-compute capability and can be used for scientific and engineering calculations, process control, or direct data handling and processing. External air conditioning is not required.



**ELECTRONICS GROUP**  
1620 Central Avenue, Minneapolis 13, Minnesota

## DERIVING MAJORITY LOGIC NETWORKS

FUND THM:  $f(X,Y,Z) \equiv (X \# Y \# f_{xy}) \# (\bar{X} \# \bar{Y} \# f_{\bar{x}\bar{y}}) \# f_{xy}$

DEFINITIONS:  $X \# Y \# Z \equiv \text{Maj}(X,Y,Z)$ ;  $f_{xy} \equiv f(X,X,Z)$ ;  $f_{\bar{x}\bar{y}} \equiv f(X,\bar{X},Z)$

DERIVATION: Let  $f(X,Y,Z)$  be even-parity function  $P$ .  
Then  $f_{xy} \equiv \bar{Z}$  and  $f_{\bar{x}\bar{y}} \equiv Z$  so

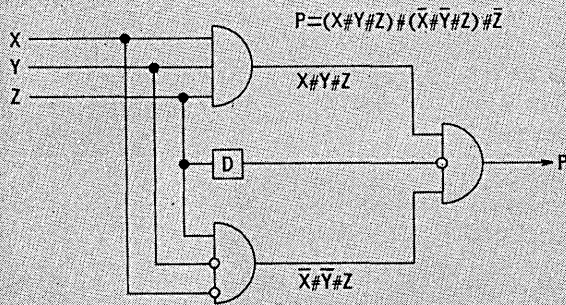

The fundamental theorem of majority-decision logic, a typical product of Univac's Mathematics and Logic Research Department, has practical as well as theoretical interest. The even-parity checker derived above from the fundamental theorem can be used to determine the parity of  $3^n$  bits in  $n$  logic levels using only  $\sum_{i=0}^{n-1} 3^i$  three-input majority gates.

Qualified applicants will find at Remington Rand Univac a scientific climate tuned to the intellectual curiosity of the professional man. The opportunity and the incentive for advancement are waiting for you in highly significant positions at Univac. You are invited to investigate them immediately.

### ST. PAUL, MINN.

LOGICAL SYSTEMS ANALYSTS • COMPUTER PROGRAMMERS  
COMPUTER APPLICATION ANALYSTS • COMPUTER LOGICAL  
DESIGNERS • MILITARY SYSTEMS ANALYSTS • ENGINEER WRITERS

For the above positions in our St. Paul, Minnesota, laboratories, send resume of experience and education to:

**R. K. PATTERSON**

Remington Rand Univac • Univac Park • St. Paul 16, Minnesota

### SAN DIEGO, CALIF.

COMPUTER PROGRAMMERS • MILITARY SYSTEMS ANALYSTS  
• SYSTEMS TEST AND EVALUATION ENGINEERS for  
data extraction and reduction, debugging  
of equipment and systems integration.

The above positions are now available at Univac in San Diego.  
Send resume of experience and education to:

**WILLIAM LOWE**

Remington Rand Univac • P. O. Box 6068 • San Diego 6, Calif.

### COCOA BEACH, FLORIDA

A new data processing center is being established in the Cocoa Beach, Florida, area to service the Atlantic Missile Range. Qualified applicants interested in a Florida location can be offered very challenging work on essential range problems. Openings include the following:

- PROGRAMMERS • SYSTEMS ANALYSTS for correlation of radar tracking data and programming techniques for data handling and data reduction.

Send resume of experience and education to:

**R. K. PATTERSON**

Remington Rand Univac • Univac Park • St. Paul 16, Minnesota

**Remington Rand Univac**

DIVISION OF SPERRY RAND CORPORATION

There are also immediate openings in all areas of digital computer development at our other laboratories. Inquiries should be addressed to:

**F. E. NAGLE**  
Rem. Rand Univac  
P.O. Box 500  
Blue Bell, Pa.

**J. R. STAHL**  
Rem. Rand Univac  
315 Fourth Avenue  
New York 10, N. Y.

All qualified applicants considered regardless of race, creed, color or national origin.

# ADVERTISERS' INDEX

American Telephone & Telegraph Co. ....	17
Ampex Computer Products Company .....	Cover 2
Ampex Magnetic Tape Products .....	54
Anelex Corporation .....	65
Burroughs Corporation .....	1
C. P. Clare & Co. ....	50
Collins Radio Company .....	55
Control Data Corp. ....	2, 3
Dataman Associates .....	66
Daystrom Incorporated, Military Electronics Division .....	37
Diginamics Corporation .....	62
E. I. Du Pont de Nemours & Co., Inc. ....	11
Electric Boat, A Division of General Dynamics .....	9
Electronic Engineering Company of California .....	64
General Dynamics/Astronautics .....	39, 40, 41
General Dynamics/Electronics .....	31
General Electric Computer Department .....	18, 19
General Mills, Inc. ....	70
Graphic Systems .....	69
Hamilton Wittman Associates .....	57
Honeywell Electronic Data Processing .....	16
IBM Data Processing .....	51, 52, 60
Information Products Corporation .....	67, 68
Itecco, A Division of Idaho Maryland Industries, Inc. ....	55
Liskey Aluminum, Inc. ....	38
Litton Systems, Inc. ....	4
Litton Systems, Inc. Data Systems Division .....	69
Mac Panel Company .....	6
The Mitre Corporation .....	56
The National Cash Register Company .....	36
National Computer Analysts, Inc. ....	63
Packard Bell Computer Corporation .....	Cover 3
Philco Computer Division .....	20
Philco Government & Industrial Group .....	Cover 4
Photocircuits Corporation, Tape Reader Division .....	7
Potter Instrument Co., Inc. ....	8
Ramo-Wooldridge, A Division of Thompson Ramo Wooldridge Inc. ....	12
Remington Rand Univac .....	71
Telecomputing Services, Inc. ....	61

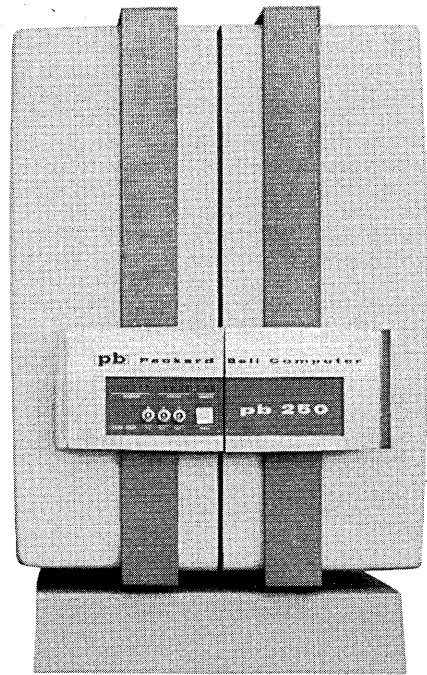
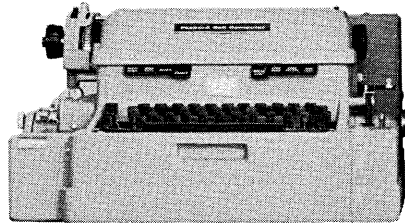

## FULL SCALE PERFORMANCE

### WITH OPERATING EASE

Wide range flexibility...microsecond speed...solid state reliability...full line of software and peripheral equipment—the pb250 offers all the performance you want for all problem-solving applications. At the lowest price in the industry—\$40,000. Send for bulletin SP 100A.

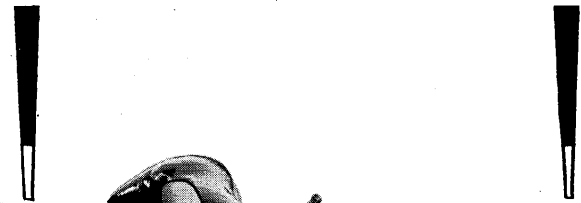
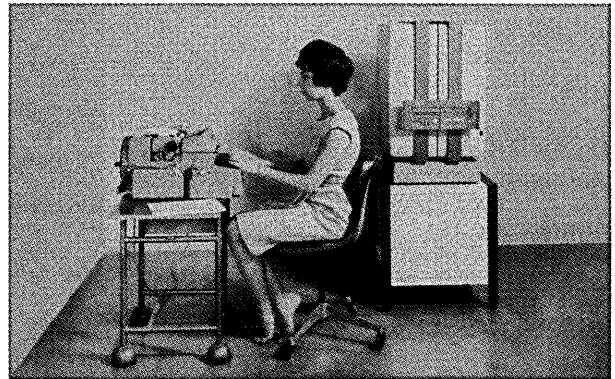

**pb Packard Bell Computer**

A SUBSIDIARY OF PACKARD BELL ELECTRONICS  
1905 ARMACOST AVENUE • LOS ANGELES 25 CALIFORNIA

CIRCLE 2 ON READER CARD

# Your Computer is Wasting Time and Money!

[unless it's asynchronous]

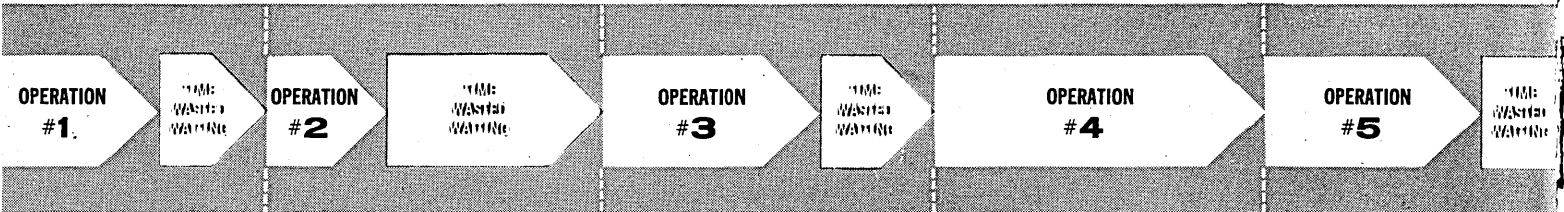

## SYNCHRONOUS

Synchronous computers waste time waiting!

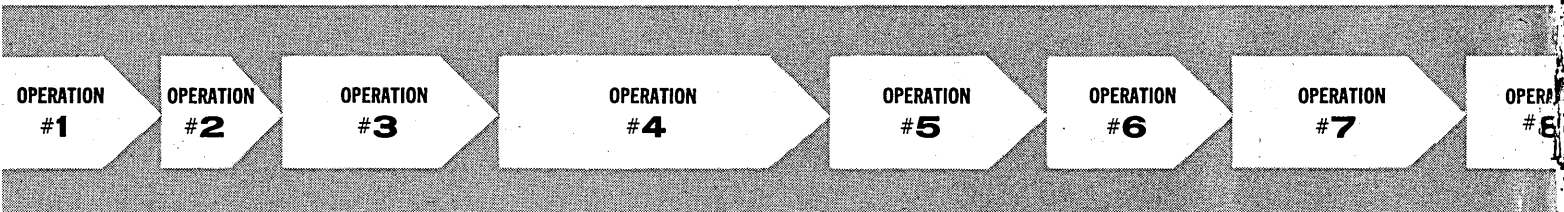

## ASYNCHRONOUS

The Philco 2000 Series, the only asynchronous computers, work full time!

## Save money with the Philco 2000 Series

In other computers the master clock breaks time into cycles tailored to the longest operation. Shorter operations are also completed within these same time limits. Time is wasted . . . *waiting*.

In the asynchronous Philco 2000 Series, there are no clocks. Each operation triggers the next. Time is spent *working* . . . not waiting. More operations accomplished in the same time.

Let us tell you more about asynchronous operation and the Philco 2000 Series, the only asynchronous computers. Write today.

### HOW MUCH TIME DO THE PHILCO 2000 SERIES COMPUTERS SAVE? COMPARE:

Typical processing rate: 639,000 additions per second, including access time.

Access time: 0.5 microsecond.

Multiple processing capability: up to seven instructions simultaneously through four-way processing. Multiplies time saving by four.

Typical problem: Invert a 100 x 100 matrix.

Computation load: 1 million multiplications and 1 million additions.

Time: only 50 seconds!

CIRCLE 3 ON READER CARD

Please see our Employment Opportunities Advertisement on Page 20.

# PHILCO®

 Famous for Quality the World Over

PHILCO CORPORATION • GOVERNMENT & INDUSTRIAL GROUP  
COMPUTER DIVISION, 3900 WELSH ROAD, WILLOW GROVE, PA.

