

COMPUTER DESIGN

THE DESIGN AND APPLICATION OF DIGITAL CIRCUITS, EQUIPMENT & SYSTEMS

DECEMBER 1965

Product Reference File:

MANUAL INPUT DEVICES

EDL 2 M B/C 15

~~_____~~ 22275
~~_____~~ 460650
~~_____~~ 0502
SEATTLE WASH 98107 H23851

24-30

Pr WI

Fr WI

Fr WI

WS

WS

WS

NEW



INTEGRATED CIRCUIT 1 μ SEC CORE MEMORY

New ICM-40 microcircuit, coincident current, random access core memories feature full cycle operation in 1 μ SEC (less than 500 nsec access time). ICM-40s feature price, size and reliability advantages of integrated circuit μ -PAC[™] logic.* Word capacities to 16,384 in a 5 $\frac{1}{4}$ " high unit for mounting in a standard relay rack. Design permits pull out front of rack access. Operating temperatures from 0°C to +50°C, with broad margins. Clear/Write, Read/Restore and Read/Modify/Write are standard modes of operation. ICM-40 interfaces comfortably with both discrete component and integrated circuit systems. Low power dissipation.

*More than 20 months of in-house funded research went into development of the standard μ -PAC line of 5 mc silicon monolithic integrated circuit modules.

3C SALES OFFICES: NEEDHAM, MASS.; FOREST HILLS, N.Y.;
LEVITTOWN, PA.; SYRACUSE, N.Y.; SILVER SPRING, MD.; HOUSTON,
TEXAS; HUNTSVILLE, ALA.; ORLANDO, FLA.; DES PLAINES, ILL.;
DETROIT, MICH.; CENTERVILLE, OHIO; LOS ANGELES, CALIF.;
PALO ALTO, CALIF.; KENT, WASH.; ALBUQUERQUE, N.M.



COMPUTER CONTROL COMPANY, INC.
OLD CONNECTICUT PATH, FRAMINGHAM, MASSACHUSETTS 01702

CIRCLE NO. 1 ON INQUIRY CARD

You can buy the whole megabit nanosecond shebang. Or just the bits and pieces.

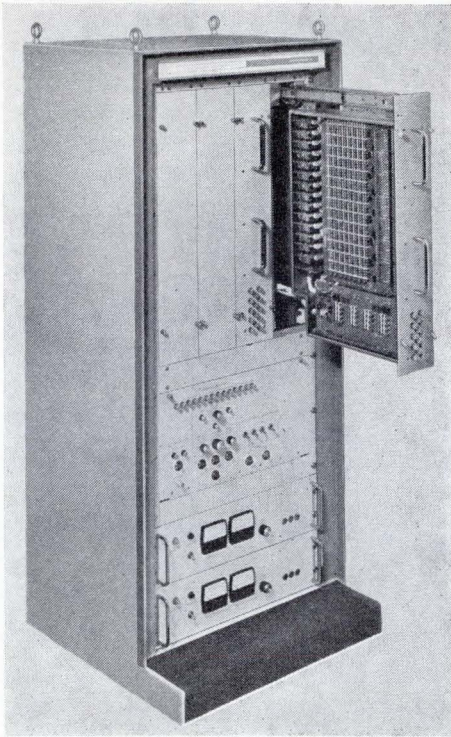

If you don't want to buy the fastest megabit memory system complete, we suggest that you build it yourself. Because of the unique modular construction of Nanomemory you can buy the complete memory system, the digitized stack only, or just the core stack assembly. In each case you get nanosecond cycle times, 2½ D organization, and highly competitive prices.

The whole shebang:
Everything included from power supply to interface circuitry. Self-contained. Just plug into mainframe, peripheral system, or what-have-you.

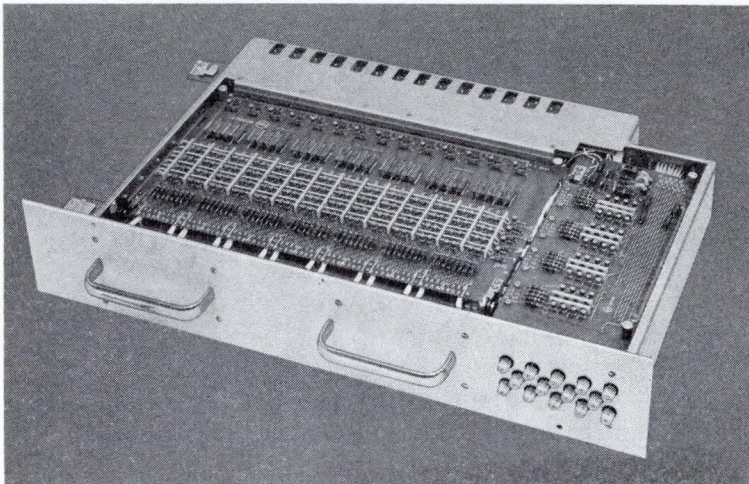

If you'd rather build:
Buy the digitized stack only. This includes low level decode, sense amplifiers and drivers. But you have to add your own interface, timing, control, power supply and box.

Stack only:
If you really want to build from the ground up, buy just the Nanostak (magnetics plus decode diodes). You still get nanosecond cycles, and the benefit of our design and memory construction experience. But you build drivers, decoders, sense amplifiers, control, interface, etc. to suit your own system.

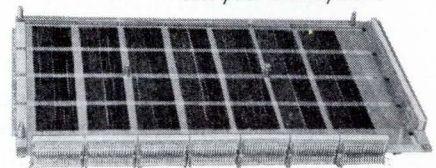

Nanomemory Specifications:

Speed: 900 nsec. cycle (30 mil cores) 350 nsec. access.
650 nsec. cycle (20 mil cores) 300 nsec. access.

Capacity: 4, 8, or 16K 8 to 84 bits per word.

Temperature: +10°C to +40°C operating ambient.

Power requirements: 115 VAC ±10%, 60 cycle,
1600W (16K words of 70 bits)

Size: 19" RETMA rack-mounted (8-70 bit word length)

24" RETMA rack-mounted (8-84 bit word length)

16" rack depth 38" rack height (excluding power supply)

For full details write to: Dean Knutson
electronic memories inc.

Memory Cores, Stacks and Systems for Industry and Aerospace, 12621 Chadron Ave., Hawthorne, Calif.

CIRCLE NO. 2 ON INQUIRY CARD

How do you like your Roytron™ paper tape punches,

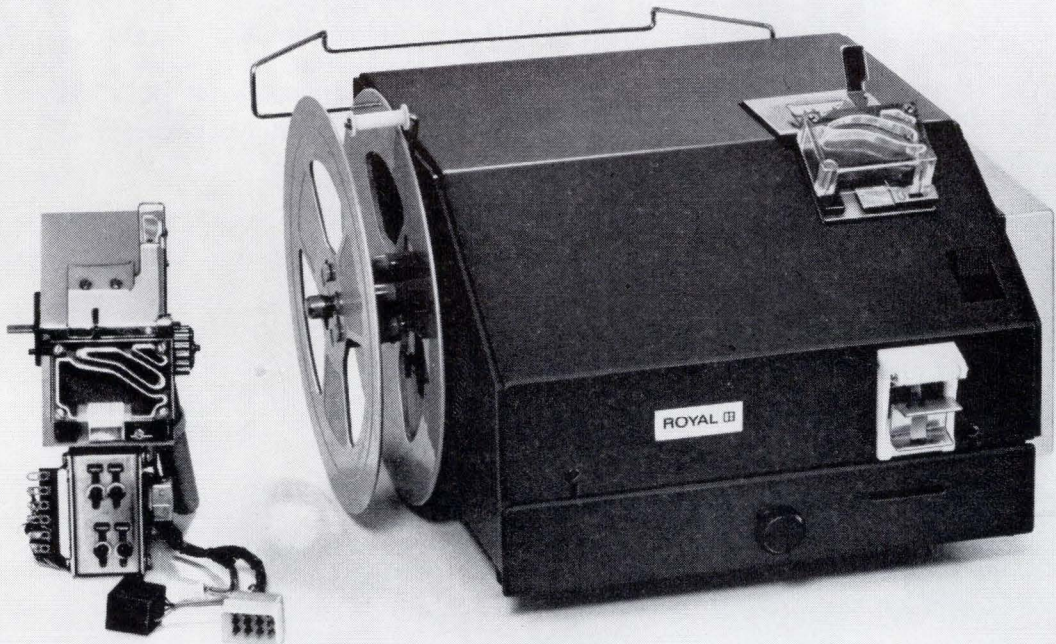

plain or fancy?

Desk or rack mounted? With or without electronic logic and circuitry? Reader incorporated? In any of 24 models? 20, 50 or 75 CPS? Roytron gives you the kind of punch you need because it customizes for every conceivable OEM requirement.

Roytron also gives you something extra in operating features. Like efficient electromagnets and off-center springs for smooth, trouble-free punching. And Roytron tape punches operate on unusually low power (24 volts, 75 ma).

Now the Roytron™ line of tape punching equipment is even more flexible. The new, low cost Series 200 punch is ideal where an asynchronous speed of 20 CPS is

best-suited for the job. For other applications, the Series 500 (50 CPS) and Series 700 (75 CPS) are available.

Roytron punched tape equipment comes with a meaningful warranty backed up by a nationwide system of service centers.

Consider the Roytron™ paper tape punch and other Roytron paper tape equipment before you go a step further on any punched tape system. For detailed specifications on the Roytron tape punch that fits your exact requirements, write:

Roytron, Royal Typewriter Company, Inc., Dept. 35LV, 150 New Park Avenue, Hartford, Connecticut.

A DIVISION OF LITTON INDUSTRIES

ROYTRON

CIRCLE NO. 3 ON INQUIRY CARD

COMPUTER DESIGN

FOR ENGINEERING PERSONNEL RESPONSIBLE FOR THE DESIGN & APPLICATION OF DIGITAL CIRCUITS, EQUIPMENT, AND SYSTEMS IN COMPUTING, DATA PROCESSING, CONTROL AND COMMUNICATIONS.

ROBERT BROTHERSTON, Publisher
S. HENRY SACKS, Editor

Editorial Advisory Board

HAROLD H. SEWARD
JOSEPH D. SABO
EDWARD M. COPPS, JR.
DANIEL J. LICKLY

Contributing Editors

RICHARD AHRONS
DAN M. BOWERS
A. S. BUCHMAN
W. A. GANNON
WALTER A. LEVY
H. S. MILLER
RICHARD PETTERSEN

Washington Editor

HAROLD V. SEMLING, JR.

JAMES FLORA Art Director
THERESA SACKS Production Manager
BERNARD GREENSIDE Tech. Illus.
JERILYN DEE Editorial Ass't.
SANDRA M. MARTIN Adv. Prod.

LINDSAY H. CALDWELL
Vice Pres.-Sales

Editorial & Executive Offices
Professional Bldg.

Baker Ave. • W. Concord, Mass.
Tel. 369-6660

Computer Design is published monthly. Copyright 1965 by Computer Design Publishing Corporation. Accepted as controlled circulation publication at Post Office at Boston, Massachusetts. No material may be reprinted without permission. Postmaster: CHANGE OF ADDRESS — FORM 3579 to be sent to Computer Design, Circulation Dept., P. O. Box B, Arlington, Mass. 02174. Subscription rate to non-qualified subscribers is \$15.00 per year; \$1.50 per issue. Subscription rate to all foreign subscribers is \$25.00 per year; \$2.50 per copy.



Circulation
over 24,000

FEATURES

18 OPTICAL CHARACTER RECOGNITION BASED ON PEEPHOLE TEMPLATE MATCHING

This article explains a character recognition concept in which each character field is divided into $N \times M$ areas and one character can be distinguished from all the others by examining only 1 or 2% of these areas.

24 DEVELOPMENT OF AN AIR MOVER TO IMPROVE COMPUTER PERFORMANCE

As described in this article, a proper cooling system can be a significant factor in improving life and reliability.

CD PRODUCT REFERENCE FILE

28 MANUAL INPUT DEVICES

This survey article covers input typewriters, input keyboards, and thumb-wheel switches. Summaries of the performance characteristics of manufacturers' units are included.

42 COMPUTER SPECIFICATION GUIDELINE

Computer purchasing can often become as great a problem as the one the computer is supposed to solve. Primarily directed to the use of computers for engineering and scientific applications, this specification aid is based on the author's several years of experience both in writing computer specs and responding to them.

DEPARTMENTS

10 READERS' FORUM

12 INDUSTRY NEWS

16 DC OUTPUT

49 NEW BOOKS

50 NEW PRODUCTS

- Circuit Components • Circuit Packaging • Input-Output Equipment
- Console Equipment • Power Supplies • Memories • Test Equipment
- Systems • Circuit Modules

62 LITERATURE

64 ADVERTISERS' INDEX

Reader subscription cards opposite page 16

Reader inquiry cards opposite page 48

There's nothing soft about our hardware programs. (That, we can promise you.)

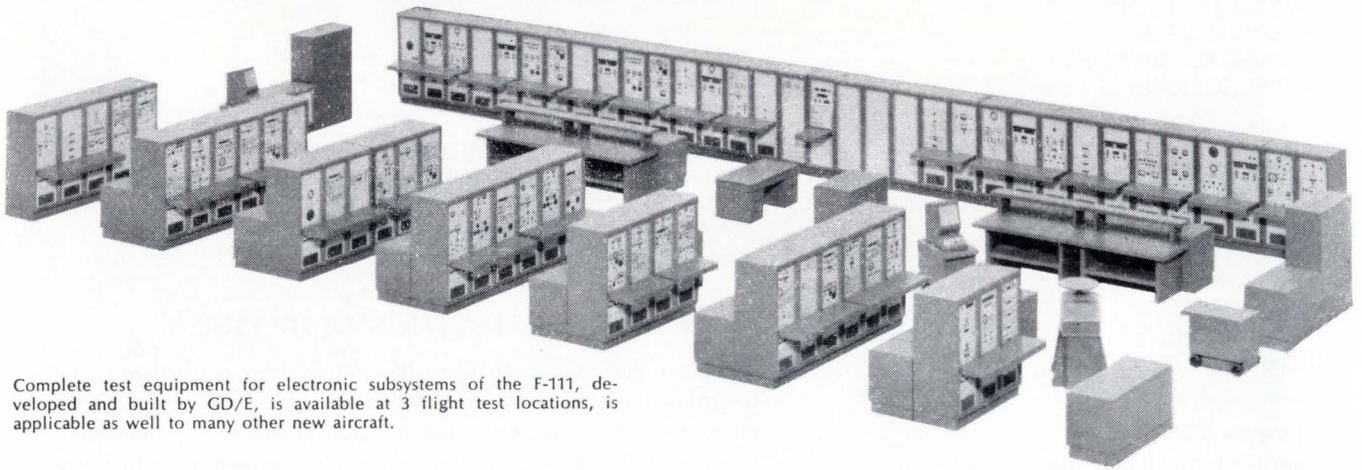

Complete test equipment for electronic subsystems of the F-111, developed and built by GD/E, is available at 3 flight test locations, is applicable as well to many other new aircraft.

In a world where all too often promises made with the best intentions cannot be kept, more and more career-oriented engineers are filtering out the glow of unsubstantiated anticipation, and fixating on the successful track record of an organization they may be interested in joining.

Fine with us.

We're fast becoming known as one of the few places in the country that persists in *keeping* promises we never made.

AUTODIN is a good example.

Wouldn't we have enjoyed dangling the prospect of working on a program as huge and complex as AUTODIN before the eyes of the experienced systems and circuit design engineers who were considering us as recently as a year ago? All we could promise was a chance to become part of a lean, hard-hitting, aggressive and competitive professional team with a pretty respectable batting average. Yet they came on board and helped us win

AUTODIN. And a remotely tuned, automatically controlled HF communications receiving set for the Navy's most far-reaching project, Southern Cross; advanced communications countermeasures equipment for the intelligence community; an advanced acoustic marker/launcher system for undersea warfare; an improved Diversity Autotrack Receiver for satellite antenna positioning used on the TOS (Tiros Operational Satellite) program... and a variety of other contracts. All within a 12-month period.

Can we make you a richer promise? It's up to you.

Tell us which of these areas seem to match your interests: Radio Communications ● Data Communications ● Antisubmarine Warfare ● Reconnaissance/Countermeasures ● Radio Frequency Interference ● Space Tracking ● Navigation Aids ● Signal Processing ● Hydroacoustics ● Reliability & Maintainability ● Total Systems or Subsystems.

Write to John F. Miller, Dept. 319.

GENERAL DYNAMICS

Electronics Division

1400 N. GOODMAN ST., ROCHESTER, NEW YORK 14601

An Equal Opportunity Employer

CIRCLE NO. 900 ON INQUIRY CARD

Now Litton's Size 11 Neo-Magnetic Encoders Pack Size 18 Capacity into 1/6 the space with 1/4 the weight!



Litton's new size 11 shaft-to-digital non-contact encoders offer a significant size reduction over standard size 18 magnetic units of the same capacity. They're 84% smaller and 75% lighter.

The reductions were possible through a new proprietary technique that eliminates the conventional "magnetic spot" approach in which ferrite discs are permanently magnetized to create code-symbolizing flux patterns. Litton's patented neo-magnetic technique offers complete immunity from external conditions capable of degrading accuracy by altering magnetic patterns or nullifying operations through demagnetization.

Outputs of the new size 11 encoders are 7-19 bits natural binary, either decoded or undecoded for time-shared V-scan decoding logic. Resolution is 8 bits per turn. Operating speed ranges from 0-1500 rpm with slew rate to 4000 rpm maximum. Electronics MTBF is

conservatively rated at 30,000 hours. Mechanical life exceeds 200,000,000 revolutions. The electronics, available in discrete or microelectric form, and integrally or separately packaged, can be configured to multiplex a number of encoders.

Litton's neo-magnetic, non-contact technique also permits other code patterns to be packaged into cases substantially smaller than previously possible. Please call us direct with your specific requirements or contact your nearest Litton regional engineering office. Encoder Division, 7942 Woodley Ave., Van Nuys, Calif. (213) 781-2111. New York: (212) 524-4727. Chicago: (312) 775-6697. Washington: (202) 462-8833.

ENCODER DIVISION
LITTON INDUSTRIES
OPTICAL · MAGNETIC · CONTACT ENCODERS

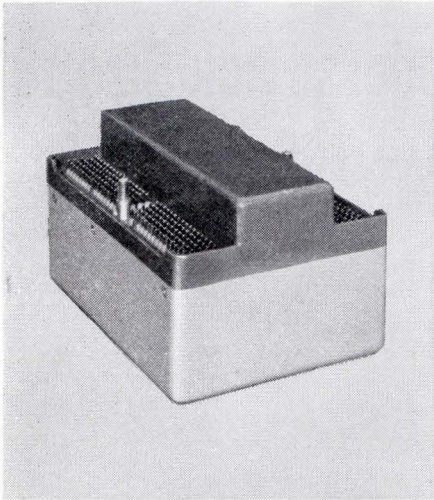

Customer: Control Data Corporation
128 x 64 x 12 capacity, temperature controlled stack for Polaris program

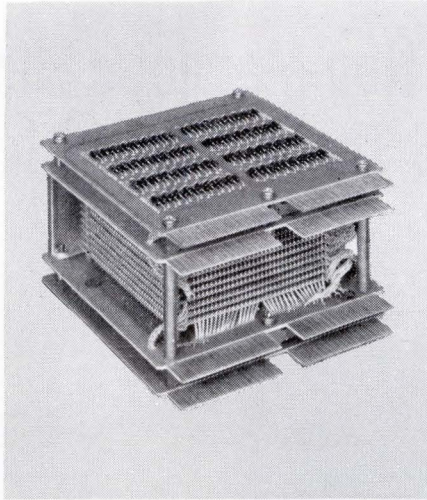

Customer: Honeywell
64 x 64 x 9 stack for H-200 computer

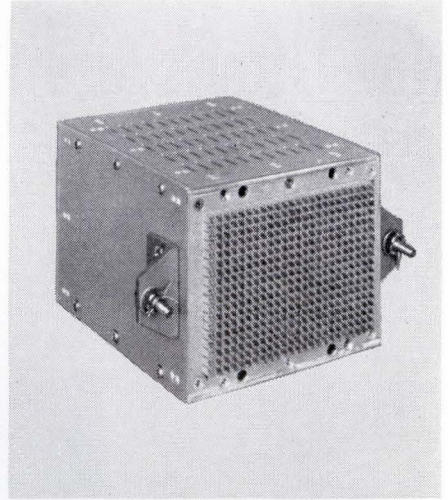

Customer: General Electric Company
2048 x 74 stack for 635 computer

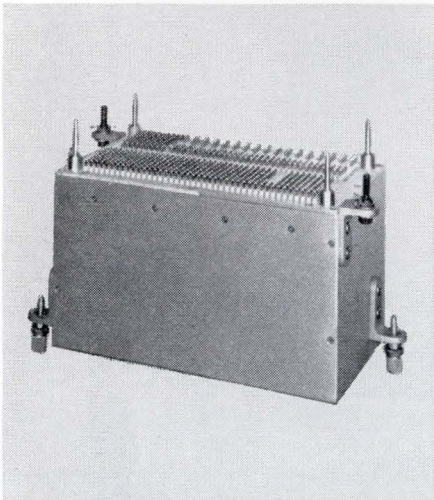

Customer: Bunker-Ramo Corporation
16,384 x 16 stack for BR 133 computer

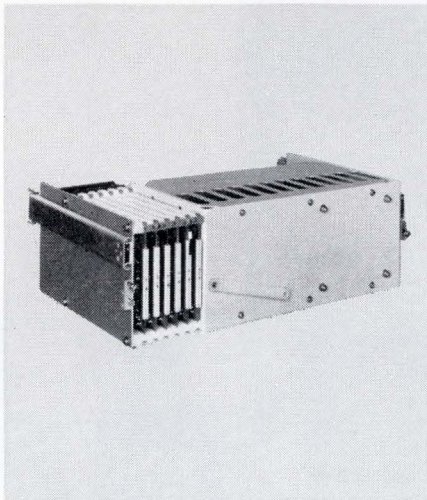

Customer: Dynatronics
2048 x 19 stack for simulator system

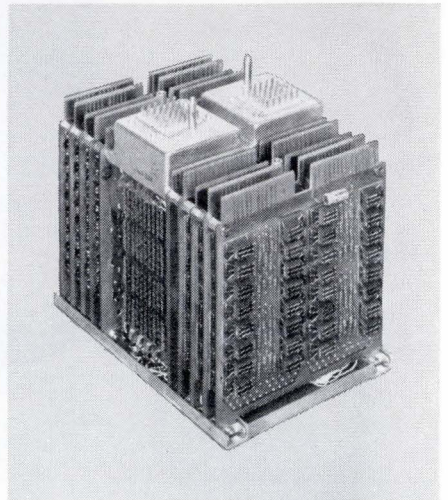

Customer: Honeywell
128 x 128 x 9 stack for H-2200 computer

Whatever you need in a core memory stack... FABRI-TEK can build it!

These stacks are typical of the diverse requirements our customers ask us to meet. Their problems range from speed to packaging, from temperature to size.

The solution to a stack problem can take many forms. We work with all core sizes and types to suit your system needs. We'll give you any word selection scheme, any type termination, any capacity. Packaging can include heaters, ground planes, rug-

gedized circuitry or your own hardware, if you desire.

Your stack design may not look like any of these, but it's a good bet we've built its cousin.

Put Fabri-Tek memory technology to work on your stack problems. Write Fabri-Tek Incorporated, Amery, Wisconsin.

Phone: 715-268-7155. TWX: 510-376-1710.

FABRI-TEK LEADS IN MEMORY TECHNOLOGY

Check with Fabri-Tek for rewarding engineering opportunities!



CIRCLE NO. 5 ON INQUIRY CARD

DATA COMMUNICATIONS

equipment for on-line,
real-time processing

there's more than that to a page printer!

Is most of your data coded in numbers? Need a page printer that will print in 2-colors? Neither is difficult in data communications, because Teletype page printers offer a wide variety of print-out capabilities.

The Teletype numeric keyboard has keys similar to an office adding machine to provide fast, efficient collection, integration, and transmission of numerically coded data. It can be used by branches to record and transmit numeric data to processing or distribution centers to simplify ordering and inventory control, as well as speed shipping. Though this Teletype set transmits numeric data only, it will receive and print-out all alphanumeric characters.

TWO-COLOR PRINTING

There are many applications of 2-color printing, including tie-ins with business machines. Accounting and statistical departments can use Teletype machines to transmit data in 2-colors to the home office or a centralized data processing center. For instance, the red can be used to indicate

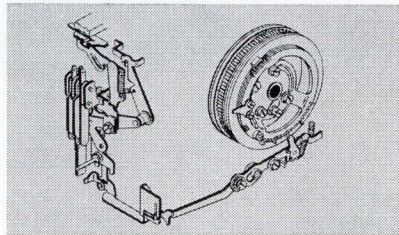

HORIZONTAL TABULATOR

"loss" figures and the black to indicate "profit" figures. Page printers can also be used to report plant operations, using black for normal conditions and red for abnormal conditions.

AIDS TO DATA COMMUNICATIONS

There are many additional Teletype page printer features that further improve your data communications capabilities. These include: vertical and horizontal tabulators; a variety of type styles and sizes; and sprocket feed platens that enable you to type on multicopy business forms.

There are also a variety of platen widths to accommodate most standard size forms. Another important feature is the automatic forms feed-out. With one key stroke, you can advance a business form, bringing the next one to the starting position automatically.

KEEPS MANAGEMENT UP-TO-DATE

The capabilities of Teletype page printers have found wide application in both business and industry. For

example, a large aircraft plant uses nearly 50 Teletype Model 35 page printers throughout the plant to report production information to two real-time computers. In this way, management is provided with instant information on the status of plant operations. This system has helped management to tighten control over in-plant functions, shorten production time, and reduce overall manufacturing costs.

And there's more to Teletype equipment than just page printing—such as automatic and keyboard send-receive sets, and a variety of paper tape punches and readers to name only a

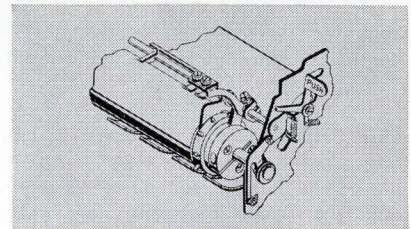

SPROCKET FEED PLATEN

few. That's why these Teletype machines are made for the Bell System and others who need dependable communications at the lowest possible cost. A brochure on the applications of Teletype equipment is available by writing: Teletype Corporation, Dept. 71M, 5555 Touhy Avenue, Skokie, Illinois 60078.

machines that make data move

SPECIFYING MODULES?

5 points to check
— and 3 questions for your supplier

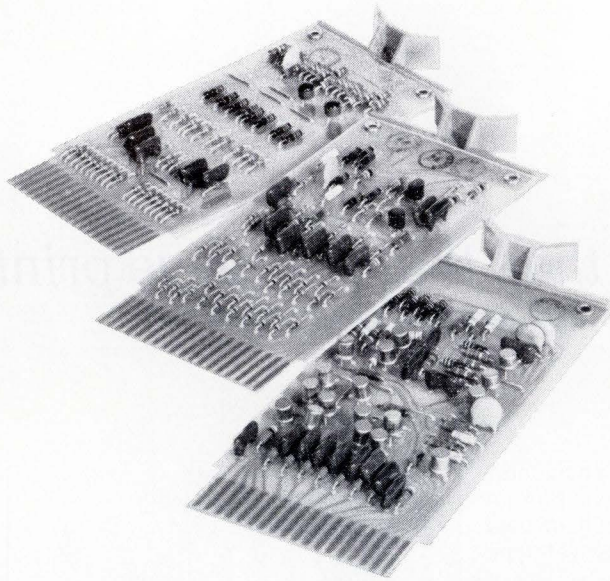

1. NOISE IMMUNITY

FLIP CHIP Modules use DTL clamped logic, provide a threshold value of 1.2-1.5 volts of noise immunity.

2. DRIVING CAPABILITY (Fan Out)

Based on 1 ma = 1 unit load, FLIP CHIP gates have a typical fan out of 18 unit loads; flip-flops have a typical fan out of 15 unit loads.

3. COST

FLIP CHIP gates cost out at about \$4.00 per gate — mounted, tested, and ready to go. A built in design feature permits additional diode inputs to be added at an average cost of 60¢ each.

FLIP CHIP flip-flops run about \$11.00 each and provide multiple functions (JK, RS, T, and RST). Since the same flip-flop can be used in a variety of applications — counters, shift registers, jam transfer buffers, BCD counters — inventory can be held to a minimum, reducing costly spares.

4. SPEED

Two frequency ranges are offered in our standard FLIP CHIP line:

- R Series — up to 2 mc
- B Series — up to 10 mc

Both series are fully compatible with our earlier line of System Modules.

5. RELIABILITY

FLIP CHIP Modules are rigidly tested and warranted for 10 years. Printed specifications are included with each module.

What is the breadth of my suppliers' line?

You need only one supplier when you select Digital. FLIP CHIPS take you from input to output. Logic level converters standardize incoming and outgoing signals. Digital has a complete line of: interface modules — including relay drivers, lamp drivers, bus drivers, Schmitt triggers, A-D and D-A modules, and mounting hardware and power supplies. All the equipment necessary to build a complete system.

What kind of delivery can I expect?

You get off-the-shelf delivery on all standard items. If it's any easier, order through the latest Allied Electronics catalog.

Can I get systems design help?

Digital applications engineers, located in major cities throughout the United States and in Canada, Europe, and Australia, are experienced professionals who can understand your problem and recommend the equipment to solve it.

Our 202 page FLIP CHIP Module Catalog has been called the standard reference work on digital logic for the industry. It's a valuable manual on logic circuit design and yours for the asking. For your free copy, just call any Digital Equipment office: DIGITAL EQUIPMENT CORPORATION, Maynard, Massachusetts 01754. Telephone: (617) 897-8821.

DIGITAL

MODULES • COMPUTERS

DATA COMMUNICATIONS

equipment for on-line,
real-time processing

rock 'em! sock 'em! yea testing!

Reliability is a very important feature of Teletype equipment because it must stand up under all kinds of conditions. That's why laboratory testing equipment is used to make sure Teletype machines will operate in steamy jungles, 20 miles in space, in deep mines, and on warships, as well as in the modern office.

RELIABILITY THROUGH DEVELOPMENTAL TESTING

The extensive testing in the development of Teletype sets includes a vibration test and a humidity test. An electronic vibrator shakes the machine to simulate conditions on a jet plane or at a command post in combat. Teletype equipment is also placed into a humid, 130-degree tropic test room to check moisture absorption

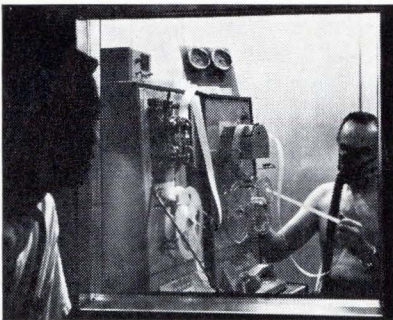

HUMIDITY TEST CHAMBER

rate. This insures that the equipment will operate under the most strenuous physical conditions.

And, still there is more. For instance, the test lab uses a stroboscopic light to "stop" the motion of the paper tape punch mechanism to permit full inspection of the action of rapidly moving parts.

"THE QUICK BROWN FOX . . ."

Testing during production is also an important part of the Teletype quality control program. For example, each page printer must produce perfect copy during an exacting typing exercise. If a single mistake occurs, the offending unit is rejected and reprocessed.

Apparatus assembled as sets must undergo a rigid final system test before they are packaged for shipment. Everything possible is done to assure the reliability of every Teletype machine.

BUT THE BIGGEST TEST IS BY YOU

The reliability of Teletype equipment gets its biggest test in numerous ap-

plications throughout business, government, and industry. Teletype sets are used to keep the ground control center at Cape Kennedy in touch with orbiting space capsules. They transmit weather forecasts and observations. Hotel and airline reservations are made and confirmed by Teletype sets. Railroads use Teletype equipment to maintain optimum freight car inventory; insurance companies for

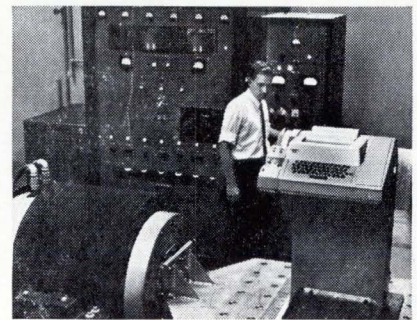

VIBRATION TEST RACK

real-time processing of policy payments and claims; and both large and small companies to speed sales orders to production, shipping, and billing departments.

This kind of reliability is why Teletype equipment is made for the Bell System and others who demand reliable communications at the lowest possible cost. Information on the many applications of Teletype equipment can be obtained by writing: Teletype Corporation, Dept. 71M, 5555 Touhy Avenue, Skokie, Illinois 60078.

BREAKTHRU!

in blower design
and performance



ROTRON
centrimaxTM

- Delivers more air with more efficiency than conventional squirrel cage blowers.
- Package size substantially smaller than assembled centrifugal blowers (measures only 10³/₄" x 12¹/₂" x 7¹/₄" deep—weight 14 lbs.)
- Motor completely integrated with impeller.
- Ultimate in reliability—no centrifugal starting switches or relays (cause of 90% of all single phase motor failures).
- Oversized, double-shielded, precision ball-bearings—lubricated for life.
- Fully equipped with inlet/outlet arrangements for standard round ducting.
- Can be mounted in any attitude and from any of 3 mounting surfaces.
- Adjustable blast direction—impeller housing adjustable 360°.
- Fabricated from flame retardant polyester resin—can't rust, won't bend.
- Thermal safety cutout feature available as optional accessory.
- Delivers 550 CFM at free delivery—200 CFM at 3¹/₄" w.g.
- Available in 115 VAC, 60 CPS, single phase; 230 VAC, 60 CPS, single phase.
- Operating temperature from -20°C to +85°C.
- Years ahead in styling and design—costs less to buy—costs less to install—costs less to operate.

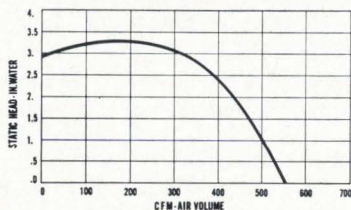

Get all the technical details on this amazing new blower, write today to:



ROTRON MANUFACTURING
COMPANY, INC.
WOODSTOCK, NEW YORK

West Coast: ROTRON PACIFIC, Glendale, California
Canada: THE HOOVER CO., LTD., Hamilton, Ontario
Rotron-Vacric Europa (N.V.) Breda, The Netherlands
Export Sales: AURIEMA INTERNATIONAL GROUP

CIRCLE NO. 8 ON INQUIRY CARD

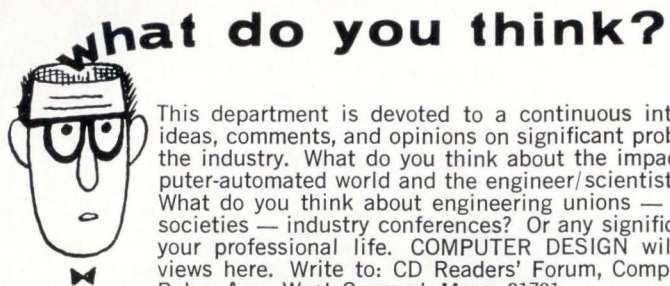

What do you think?

This department is devoted to a continuous interchange of ideas, comments, and opinions on significant problems facing the industry. What do you think about the impact of a computer-automated world and the engineer/scientist's role in it? What do you think about engineering unions — professional societies — industry conferences? Or any significant facet of your professional life. COMPUTER DESIGN will print your views here. Write to: CD Readers' Forum, Computer Design, Baker Ave., West Concord, Mass. 01781.

CD READERS' FORUM

LOGIC SYMBOLS STANDARD

EDITOR'S NOTE: Continuing the discussion on the possibilities of achieving industry-wide acceptance of one standard for logic symbols, this month's Forum reflects one group favoring MIL-STD-806B while another favors abandoning the detailed logic diagram altogether.

TO CD READERS' FORUM:

We have studied logic symbols and decided that MIL-STD-806B is the easiest to understand.

We vote for 806B!

James Crawford, E.E.
U.S. Naval Ordnance Test Station
China Lake, Cal.

TO CD READERS' FORUM:

The comments to date on the use of a standard logic symbology seem to have glossed over some of the problems involved. There are two reasons why MIL-STD-806B is extremely difficult to apply.

1. It does not adequately treat the NAND/NOR cases. Admittedly symbols are available — but when trying to apply them to involved logic control circuits the ambiguities involved in assigning symbols are

outrageous. In desperation the logic design assigns the symbols arbitrarily — and this brings us to the second point.

2. As the symbol assignment becomes more arbitrary, its correlation with the physical hardware becomes less and less. For example — the use of a small "or" symbol to designate a "collector or" connection. This is a serious problem, for if the logic diagram does not clearly reflect the physical hardware, it has lost one of the main reasons for its existence.

There are also good reasons for abandoning the detailed logic diagram. There is neither time nor space to present a detailed, rational argument in this letter so I'll present a heuristic argument.

For other than the simplest systems, the use of detailed logic diagrams is a horse and buggy approach to the problems of equipment design and maintenance. More stringent requirements on the designer and the maintenance man dictate fresh approaches to the design and maintenance problems. The tools and the techniques are at hand in the form of computers and computer-oriented documents to solve these problems. At Philco WDL we have devised such a system. We would encourage others to do the same.

Arnold E. Larson, Project Engr.
Philco WDL, Palo Alto, Cal.

DATA COMMUNICATIONS

equipment for on-line,
real-time processing

picking paper tape punches and readers

The integration of paper tape punches and readers within data processing systems has been widespread. Paper tape has become an important communications link, and

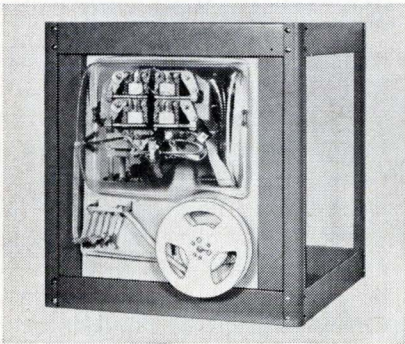

DRPE PAPER TAPE PUNCH

is still the most inexpensive and reliable continuous recording medium available.

OFFERS FLEXIBILITY IN COMMUNICATIONS

Teletype paper tape punches offer a variety of data communications uses. They can be used on the receiving end of high-speed tape-to-tape systems. They can combine data from various sources on one master tape. Some units include a printing mechanism for simultaneous punch and print information.

There are punches available to operate at 6 to 240 characters per second (60 to 2,400 words per minute), and for punching fully perforated or chadless tape.

Most Teletype paper tape units are available in 5, 6, 7, or 8-level, and either as self-contained units or as components in other Teletype equipment, such as automatic send-receive sets.

Teletype LARP Tape Punch—A multi-magnet punch designed to serve as a "slave" unit for a variety of data

processing systems. Operates on a parallel-wire basis at 20 cps (200 wpm) or less.

Teletype LPR Tape Punches—Actuated by incoming serial line signals, these self-contained units operate at 10 cps (100 wpm). They also have a printing mechanism to print out information that is simultaneously punched in the tape.

Teletype BRPE Tape Punch—This high-speed parallel-wire punch operates at 105 cps (1,050 wpm). It can record output of computers and other business machines, as well as produce master tapes by combining information from various sources.

Teletype DRPE Tape Punch—In this unit, instead of a motor, an electro-mechanical punch supplies the energy to perforate data into paper tape. Operates at speeds up to 200 cps (2,000 wpm). The unit is asynchronous and needs no adjustments or modifications when changing speeds.

FAST, ACCURATE DATA TRANSMISSION

Teletype tape readers are available to operate at speeds of 6 to 240 cps (60 to 2,400 wpm). They are designed for fast, accurate, and dependable data transmission, whether your needs involve simple station-to-station relay or the more complex transmission requirements of data processing. Most Teletype tape readers will handle fully perforated or chadless tape.

Teletype LX Tape Readers—These units convert data from punched paper tape into parallel-wire impulses. Speed may be varied from 6 to 20 cps (60 to 200 wpm) by substituting different drive gears.

Teletype LXD Tape Readers—Transmit a serial signal at 10 cps (100 wpm). Provide dependable, economical transmission of messages and data.

Teletype CX Tape Reader—Data collected from slower machines can be transmitted over this unit at 105 cps (1,050 wpm). It transmits parallel-wire signals, and can be used as an input device for computer and business machines, feeding synchronized data instantly into these systems.

Teletype DX Tape Reader—Transmits parallel-wire binary signals at speeds up to 240 cps (2,400 wpm). The DX is equipped with step-by-step feeding that enables it to start and stop on a single discrete character with no coasting.

The variety and reliability of Teletype paper tape punches and readers is another reason why they're made for the Bell System and others who require dependable communications at the lowest possible cost. For further information write to: Teletype Corporation, Dept. 71M, 5555 Touhy Avenue, Skokie, Illinois 60078.

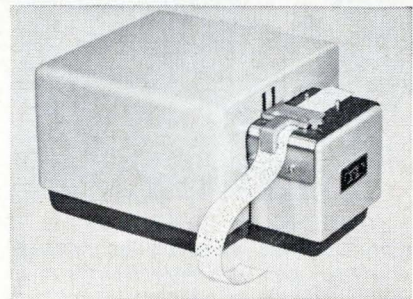

DX PAPER TAPE READER

machines that make data move



CIRCLE NO. 9 ON INQUIRY CARD

who has the answer to EDP economy?

EDP systems designers, builders and users who are fighting the traditionally high cost of computing. That's who. They specify system components that do the job **better** for **less money**. For example, they specify computer magnetic tape units from Datamec. Either the **D 2020** or the **D 3030**. Both are well-known for setting new industry standards in greater all-around economy: lower initial cost, reduced maintenance expense, greater up-time, higher performance reliability.

The **D 2020** is an attractively-priced unit for computer and off-line applications where moderate speed performance is highly practical (data transfer rates up to 36,000 characters per second).

The **D 3030** offers the same unprecedented **economy** and **reliability** for heavy duty, on-line use with digital computers and other digital EDP systems requiring higher data transfer rates (up to 60,000 characters per second).



Some 80 leading manufacturers already specify Datamec computer magnetic tape units in their data systems. Like to read over the list of people who have the answer to EDP economy? Write Tom Tracy at Datamec, 345 Middlefield Road, Mountain View, California.

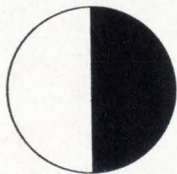

DATAMEC
A DIVISION OF HEWLETT-PACKARD
leadership in low-cost/high-reliability
digital magnetic tape handling
CIRCLE NO. 13 ON INQUIRY CARD

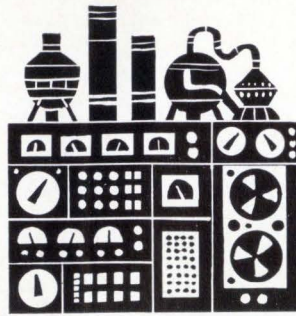

INDUSTRY NEWS

ACCESS, A DATA-PROCESSING SYSTEM RECENTLY DEVELOPED BY THE NATIONAL BUREAU OF STANDARDS' INSTITUTE FOR APPLIED TECHNOLOGY, represents an advance in communication between man and computers. This system will receive and process data from local and remote sources and can present its output in a form immediately intelligible to the human operator. Access (so-called for Automatic Computer Controlled Electronic Scanning System) was developed for use by the Office of Emergency Planning to help provide rapid access to digital and pictorial data. The ready availability of these data will aid the OEP in evaluating situations during a national emergency. Access accepts input information directly from microfilm records of hand-marked documents and digital information either from other machines or directly from its keyboard. It has been used in experimental work at the Bureau to accept such graphical material as specially prepared maps and charts. Access scans marked documents by means of an advanced version of Fosdic which is a "Film Optical Sensing Device for Input to Computers." Fosdic was initially developed jointly by NBS and the Bureau of the Census for machine reading of census documents.

CONTRACT TO DEVELOP A HIGH-SPEED TELEPRINTER SYSTEM, 10 TO 20 TIMES FASTER THAN CURRENT TELETYPEWRITER EQUIPMENT, YET COMPACT AND LIGHT ENOUGH FOR FIELD USE, has been awarded to Anelex Corp., of Boston, Mass. The contract was granted by the Army Electronics Command, Ft. Monmouth, N.J. The new 80-column teleprinter will operate at 150 to 300 characters per second, but will weigh less than 65 pounds. The accompanying control sub-set will weigh less than 35 pounds. The printer's light weight and rugged design will make it possible, Anelex engineers said, to pack it into remote locations for use on the company level as a receive station. Power consumption of the teleprinter will be only about 15 watts.

THE FOXBORO COMPANY HAS SOLD ITS FIRST DIGITAL COMPUTER SYSTEM IN EUROPE. Contracts totaling well over \$500,000 for two large systems have been awarded to Foxboro by Chemische Werke Huels, Marl, West Germany. Another large system has been sold in Great Britain. The systems purchased by CWH will be installed in a large chemical processing complex near Duesseldorf, West Germany. One system will control a continuous process; the second, batch processing.

Now you can have the fastest, most flexible logic modules ever made.

(But you'll have to pay less for them.)

Who knows more about monolithic integrated circuitry than SDS?

Nobody. We were the first to announce an integrated-circuit computer, and we're still the only manufacturer making deliveries.

Everything we've learned about the state of the art in integrated circuitry has gone into our new line of logic modules.

To tease you a little: SDS modules have unique monolithic flip flops with true trailing-edge triggering. They have both inverting and non-inverting logic at the same price. They have fully buffered AND/OR gates, alone or in conjunction with NAND/NOR gates. A variety of gating structures, and 52-pin connectors, give such flexibility that you'll need far fewer cards for each function. Delay times as short as 18 nanoseconds per stage.

Cost? For quality and performance, the lowest in the industry.

We'll be glad to give you the rest of the details the moment you show some interest. Just write or call.

Scientific Data Systems

1649 Seventeenth Street, Santa Monica, California
U. S. sales offices in New York, Boston, Washington, Philadelphia, Pittsburgh, Huntsville, Orlando, Chicago, Houston, Dallas, Albuquerque, Denver, Seattle, San Francisco, St. Louis, Detroit.



CIRCLE NO. 14 ON INQUIRY CARD

*Absolutely
Reliable*

**DUE TO
PLANETGEAR®
PRINCIPLE!**

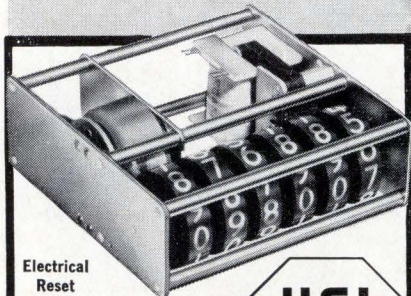

Electrical
Reset



**Digital
CLOCKS and
COUNTERS**

*Never Slip, Skip or
Miss a Count!*

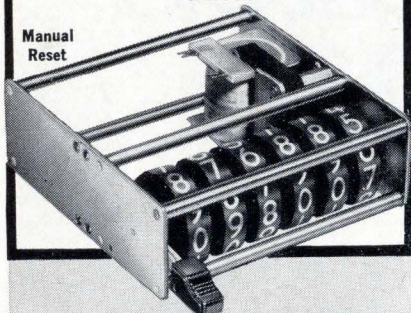

Manual
Reset

This amazing feat is accomplished because with HSI PLANETGEAR the gears are always in mesh... even while resetting!

You need these trustworthy components if you have applications where there are demands for digital devices which:

- ... offer maximum rapid drum transfer.
- ... give high speed counting (over 2000 RPM).
- ... give infallible accuracy.
- ... long life at high speeds.

HSI has prepared a *gold mine* of scientific and technical data on its PLANETGEAR Pulse Counters and on the revolutionary Digital Stop Clocks and Time Totalizers. Without the slightest obligation write Haydon Switch & Instrument, Inc., 1500 Meriden Road, Waterbury, Conn. 06720 for Bulletins No. 44-1R (Counters) and No. 42-2R (Clocks).



**HAYDON SWITCH &
INSTRUMENT, INC.**

1500 MERIDEN ROAD
WATERBURY, CONN. 06720

CIRCLE NO. 15 ON INQUIRY CARD

INDUSTRY NEWS

THE FIRST PROJECT IN THE COUNTRY INCORPORATING AUTOMATIC COMPUTERIZED EXPRESSWAYS TRAFFIC CONTROLS was put into operation recently on a four mile section of the Eisenhower Expressway in Chicago. One of the significant features of the Chicago system is that it is the first working system to combine computer-operated traffic control signals with automatic surveillance. Instead of visual surveillance, the system makes use of ultrasonic detectors to monitor the traffic flow on the expressway. When these detectors indicate impending congestion, a computer initiates metering. At this point a human operator must activate the ramp-metering equipment. Once started, however, it operates automatically. At the on-ramp, a pair of detectors buried in the pavement record the passage of every incoming vehicle and computer-operated signals then feed the vehicles into the expressway at intervals determined by traffic conditions on the freeway.

DEFENSE ELECTRONICS, INC. OF ROCKVILLE, MD. HAS BEEN AWARDED A CONTRACT IN EXCESS OF \$400,000 from the NASA Marshall Space Flight Center, for a computer-controlled telemetry ground station. For the first time, according to reports, all telemetry parameters will be selected and controlled by a general-purpose digital computer. A group of six subsystems will be designed

and developed by DEI to receive and demodulate all types of Saturn telemetry data. One of the unique features of the system is a VHF/UHF receiver subsystem, consisting of eight DEI Model CR-101 computer-controlled receivers. The computer can turn the equipment on or off and select any of 16 pre-determined crystal-controlled carriers in the VHF or UHF telemetry spectrum, any of 4 IF amplifier bandwidths, and any of 3 video output characteristics, for each receiver in the subsystem. Predetection record and play back capability is also provided under computer control.

PLANS TO INSTALL A \$6-MILLION IBM SYSTEM/360 TIME-SHARING COMPUTER COMPLEX at the M. I. T. Computation Center to serve M. I. T. and 51 other cooperating colleges and universities in New England were announced recently by Dr. J. A. Stratton, president of Massachusetts Institute of Technology and A. L. Williams, president of IBM. The new computer, designed specifically for time-sharing, will be capable of serving simultaneously more than 200 people working with different programs from remotely located terminals. The new System/360 computer complex is expected to be approximately 15 times more powerful than the IBM 7094 system now installed at the Center. In making the announcement, Dr. Stratton said: "few foresaw a decade ago how quickly and extensively computers would take a position of overriding importance in M. I. T.'s many programs of education and research. We are now at the stage where the need for computation has penetrated to almost every department and affects nearly every research and teaching activity."

RECEIPT OF A \$3.3 MILLION AIR FORCE CONTRACT FOR ADVANCED AIRBORNE DATA PROCESSING EQUIPMENT COMPONENTS and spare parts was announced by General Telephone & Electronics Corp. The award was made to Sylvania Electric Products Inc., a GT&E subsidiary, by the Aeronautical Systems Division of the Air Force Systems Command. Work was completed earlier this year on the equipment. The new contract brings total funding to Sylvania on the project to \$10 million. Work on the new project will be performed at Sylvania's manufacturing plants in Santa Cruz, Cal., and Needham, Mass.

LEEDS & NORTHRUP HAS RECEIVED AN ORDER EXCEEDING \$1,250,000 to supply two digital computer systems and automatic boiler control equipment for a generating station near Michigan City, Indiana. Described by George E. Beggs, Jr., L&N's President, as the "largest individual order received by the company during peacetime", the contract calls for Leeds & Northrup to supply two LN4000 digital computer systems, boiler control using the Direct-Energy Balance (D-E-B) concept, and associated instrumentation and panels. The computer systems will be used for alarm scanning, data logging, performance calculations, start-up sequence monitoring, and guidance instructions including appropriate instructions to the operator. The Direct-Energy-Balance control will automatically regulate the combustion and feedwater supply to the boiler and coordinate them with the regulation of the turbine governor to provide the desired electrical output.

RELIABILITY, RELIABILITY, RELIABILITY

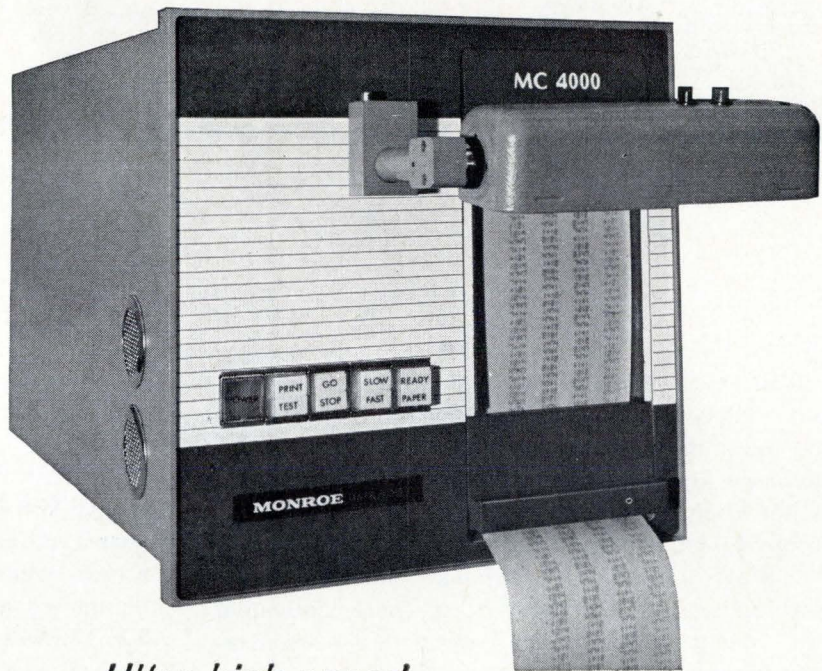

Ultra high speed
Monroe DATALOG®
MC 4000 Printer delivers
6000 lines per minute!

That's 100 lines per second, synchronous or any speed less than 100 lines per second that your application might require. The MC 4000 is truly synchronous or asynchronous.

A non-impact printer. Completely silent. Absolute reliability. It's available in a numeric model (15 characters in each column) or in an alphanumeric model (43 to 64 characters in each column). Both models are 32 columns wide and have the same 6000 lines per minute printing speed.

Look at these MC 4000 features: Character serial input, bit parallel. Data transfer time of 50 microseconds (no buffers required). Only two moving parts—the paper feed stepping motor and the fan. Compact: 10½" high, 10¼" wide. Rack mount available. All solid state with cathode ray tube through fiber optics.

Any 4 line code for the numeric model; any 6 line code for the alphanumeric model. Any logic level.

Price, just \$5650 for the numeric, \$5850 for the alphanumeric model.

Reliable. Silent. Ultra high speed. Synchronous or asynchronous.

And, like all Monroe DATALOG printers, the MC 4000 is covered by a full year's warranty with on site maintenance.

For additional information, specification sheets or a demonstration, write or call Monroe DATALOG Division of Litton Industries, 343 Sansome, San Francisco. (415) 397-2813.

MONROE DATALOG 

A DIVISION OF LITTON INDUSTRIES

CIRCLE NO. 16 ON INQUIRY CARD



One of the unresolved questions raised by legislation presently before Congress to revise our copyright laws concerns the use of "copyrighted works" in computers. "Copyrighted works" under the proposed legislation could include not only copyrighted works as we customarily know them but also computer programs.

It has been questioned if the right "to reproduce the copyrighted work" includes reproduction of data in a storage unit of an information storage and retrieval system or the right "to prepare derivative works" means work fed into a computer — the fixation of magnetic impulses in a storage unit — as constituting a derivative work.

With respect to another section of the proposed revision of the copyright law, computer programs might fit within the definition of "literary works." The performing right of a computer program would thus be limited to a "public" performance right. It is asked whether a performance of a copyright program in a public showroom constitutes a public performance, and whether this is a performance right that is intended to be granted to computer programs.

The Copyright Office calls these difficult and important problems. However, Abraham L. Kaminstein, Register of Copyrights, states that any specific reference to "computers" or "information storage and retrieval units" was deliberately avoided in the clause on "copyrighted works." As a reason, Kaminstein says ". . . there are many developments that are going to come in the immediate future, and we think it is safer to draft general language which can be interpreted by the courts to apply to particular usages."

.....

Congress has been asked by Treasury Secretary Fowler for the power to require taxpayers to mail returns directly to the handful of data processing centers instead of their local district office. He claims the computer centers will offer sizeable savings in time and money. It seems likely Congress will act on Fowler's request in 1966. IRS plans to ask taxpayers in the five Middle Atlantic States voluntarily to send their returns to its Philadelphia computer center and will again suggest to those in the seven Southeastern States

that they send their returns to the Atlanta computer center.

.....

An almost 100 percent re-utilization of Government-owned EDP equipment screened for re-use during fiscal year 1965 has been achieved during the first year of a new Department of Defense program. Value of this equipment at the time of its original acquisition was \$26,143,592. There was also a 10 percent re-utilization of excess rented EDP equipment in which the government has an equity, according to the fiscal year report. This accounted for an additional \$6 million, raising the total sum to \$32 million. Equipment on lease by one government agency, in such cases, may be purchased by another agency to take advantage of reduced prices resulting from accrued purchase options and lease credits. The total number of computers in government is expected to grow to a projected 2,451 by the end of this fiscal year.

.....

Increases in the shipment by manufacturers of electronic computing and associated equipment from 1963 to 1964 have been reported by the Census Bureau. Shipments were valued at \$987,179,000 FOB plant in 1964 — a \$15,223,000 increase over 1963. Census found increases in digital equipment including that used for general purposes. Values for shipments of analog equipment in 1964, with 6 firms reporting to Census, decreased from \$39,731,000 in 1963 to \$35,589,000 (FOB plant).

.....

The U. S. Navy has accepted delivery of the first 13 Polaris Target Card Computer Systems (PTCCS) produced by Control Data Corp. under a \$5.3 million contract as part of the U. S. Navy Polaris Program. PTCCS systems are being installed to work with the MK80 Fire Control System used on the earlier Polaris Submarines. They will improve the fire control capabilities of these submarines.

A computer program for political reapportionments of state legislatures and congressional districts has been developed by C-E-I-R. The major advantage of the program is its ability to produce patterns which accurately reflect whatever judgments are "fed" into the computer and at the same time meet court imposed criteria of "one man, one vote" and compact, contiguous districts. Besides its political application it can be modified for use in related fields such as school redistricting and territorial assignments for salesmen.

Recent Defense Department Contracts

IBM CORP., Washington, D. C., is being awarded a \$1,303,180 fixed-price contract for EDP equipment. Work will be done in Poughkeepsie, New York. The 2750th Air Base Wing Headquarters (Air Force Logistics Command), Wright-Patterson AFB, Dayton, Ohio is issuing the contract.

WESTERN ELECTRIC CO., New York, N. Y., has been awarded a \$221,216,696 modification to an existing contract for R&D on the NIKE X missile defense system. The NIKE X Project Office, Redstone, Ala., is issuing the contract modification.

ITT CORP., Paramus, N. J., was awarded a \$1,007,201 contract for computer services and programming for the Strategic Air Command control system. Work will be done in Omaha, Neb. The Electronic Systems Division (Air Force Systems Command), L. G. Hanscom Field, Bedford, Mass., is the contracting agency.

GENERAL DYNAMICS CORP., San Diego, Cal., is receiving a \$1,221,400 contract for continuation of research in ocean data processing. Work will be done at San Diego and Point Mugu, Cal., south of Puerto Rico, and off the Straits of Florida. Office of Naval research is the contracting agency.

GOVERNMENT REPORTS ★ ★

ERROR IN DIGITAL DATA ON TELEPHONE NETWORKS

Air Force-sponsored researches say that present telephone circuits have good error rates, and retransmission blocks in error do not seriously affect the throughput of data. When retransmission is not practical, forward error correcting devices are available which can reduce the bit error rate by two orders of magnitude. The study as a whole was made to satisfy a need for a simplified explanation of error control techniques, and a need to know how the technology performs against real error distributions.

Order from Clearinghouse, U.S. Dept. of Commerce, Springfield, Va. 22151. Order No: AD 616 678N. Price: \$3.00.

Here's the new
Integrated Circuit
VersaSTORE
CORE MEMORY

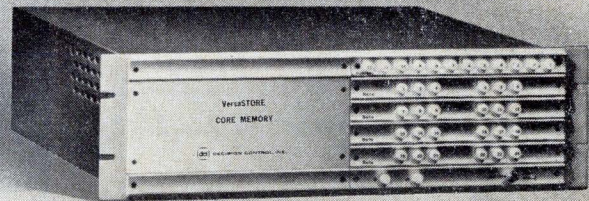

*Packed with features
that won't stop!*

... Like its flexible interface, either PNP or NPN interface Buffered input 3V. to 24V. and output from 1V. to 12V. Only power required $\pm 12V. \pm 5\%$ 2usec. cycle time 1/2 cycle operation Random access Sequential and sequential interlace address options Plenty of output drive for system requirements Integrated circuits for maximum reliability Outputs can be grounded without damage Continuous lamp display of all the registers Servoed current drive for good operating margins at temperature Exclusive "Dataguard" that protects the memory during system checkout Compact, flexible packaging that allows you to select memories from 256 to 4096 words of 24 bits or less, in only 5 1/4" of standard rack space.

No other memory has *all* of these features. Compare. Think about it. Then call us at 714-646-9371, or write for our new VersaSTORE brochure.

See VersaSTORE in Booth 526, F.J.C.C.



DECISION CONTROL, INC.

1590 Monrovia Avenue, Newport Beach, Calif.
Tel. (714) 646-9371 • TWX (714) 642-1364

This article explains a character recognition concept that is quite remarkable. Each character field is divided into $N \times M$ areas and one character can be distinguished from all the others by examining only 1 or 2% of these areas. Further, a digital computer program exists for automatically generating the recognition criteria.

OPTICAL CHARACTER RECOGNITION

The inability of today's high-speed computers to accept inputs directly in the form of typed or printed documents is a serious handicap. Many man-hours are expended in converting typed or printed information to a machine acceptable code. To remedy this situation, industry has responded with a concentrated effort to develop suitable optical character recognition (OCR) machines. These character recognition machines possess the ability to recognize printed and typewritten information and to convert this information reliably into a digital code at high speed.

A peephole template matching technique developed by General Precision's Link Group employs a mask or template in which only a relatively small number of selected sub-areas of the image field are used as apertures for matching. This method permits the use of only certain elemental areas contained inside the boundaries of each character for identification of each specific character out of a group of characters. Each character is described by a matrix consisting of N columns and M rows; $N \times M$ elemental areas make up each character. The number of these elemental areas which are selected to discriminate each character from the total group should be kept to a minimum so as to achieve low equipment cost.

To be exact, each character will be divided into $N \times M$ areas each containing an experimentally-derived percent blackness. One character will be distinguished from another by examining a minimum of 1%-2% of $N \times M$ areas. Many areas are common to a number of characters in a group such as the upper case alphabet for example, so that examination of 7%-8% of $N \times M$ areas will suffice to identify the unknown character from all others. There exists an automatic means by which the $N \times M$ areas of each character and their percent blackness are generated, and also a

program that will depict 1%-2% of the $N \times M$ areas between two characters in order to generate the areas (7%-8% of the total area) that identify that character from all others in that group. The total selected areas per character make up the mask of that character. All masks in a group make up the master vocabulary.

Recognition can be accomplished by a process in which the character is, as seen by the electro-optical pick-up, examined through every mask in the master vocabulary, registering the number of area mismatches, i.e., where the mask differs from the optical pick-up (the mask may look for white and the pick-up senses black) and selecting the character whose mask comparison resulted in the least number of mismatches. The total number of these mismatches must be smaller than a preselected threshold, or the output of the recognition logic will signify a "reject" indicating that the character just sensed by the sensors was not a character contained in the master vocabulary, or the character had deteriorated excessively.

The initial task is to determine the percent occurrence of black in each of the $N \times M$ elemental areas of each character in a selected group.

The reliability of black or white in a particular area of a character can be determined by scanning actual typed or printed samples, for example, 100 characters of the same identity, and counting the number of times each elemental area is detected as black or white. A threshold input to the recognition system is assumed in which only two possibilities, "black" or "white" is permitted. Ideally, when scanning 100 "4's" of the same type font, the area $N_A M_B$, for example, (Fig. 1) should have a consistent occurrence of zero blacks. In most existing OCR systems, the scanning resolution varies from 100 to 500 elemental areas, so the area $N_A M_B$ should be consistently white in the character

Klaus K. Maass is presently an Associate Engineer at the System Development Laboratory at IBM Corp., Poughkeepsie, N. Y. Previously, he was employed as a Senior Engineer at the Link Division of General Precision, Inc. This article is based on work associated with Link's optical scanning system programs. Mr. Maass holds one patent and is co-holder of 3 pending patents on character recognition systems and sub-systems.

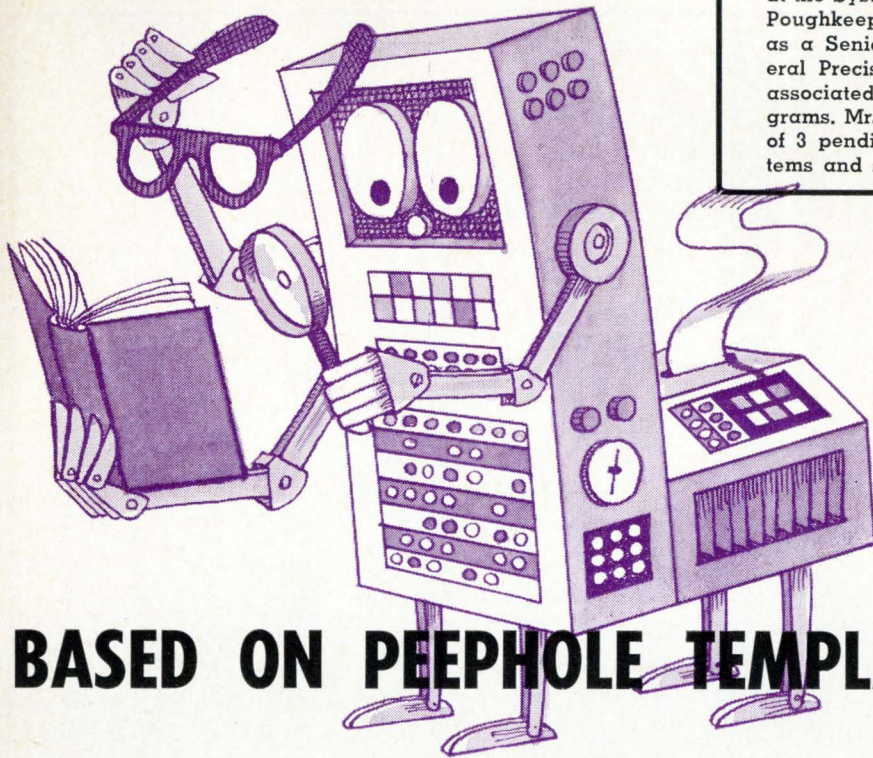

BASED ON PEEPHOLE TEMPLATE MATCHING

"A" in all cases.

It is unfortunate, however, that characters do not appear in the form where all elemental areas are consistently either black or white. This would greatly simplify the selection and storage of the most useful areas for an automatic recognition process. In reality, when sampling character impressions having the same identity, the elemental areas (bits) within each impression are not all consistently black or white, due to different impression settings on the typewriter when producing the character, dirt, variations in angular orientation, ribbon flaws, etc. In this discussion, the approach is to distinguish three categories of black consistency, three categories of white consistency, and a marginal category which does not appear in the final encoder version of any given character. The three categories of black or white are designated as excellent, good, and fair.

An excellent black or white bit is one which has been found to be repeatedly (on at least 95 per cent of all samples tested) black or white, respectively, on at least 100 successive character impressions. In addition, a form of bit weighting is included by requiring neighboring bit positions to be classified as having equal reliability minimums.

A good black or white bit is defined as one that meets the qualifications of an excellent bit, with the exception that one or both adjacent bits are less than 95 per cent reliable.

A fair black or white bit is one that is reliable at least 90 per cent of the time but less than 95.

Bits that fall outside of these regions are classified as marginally black or white. With these definitions of bit weighting, each character can be described by a data matrix of an area $M \times N$ using one of seven designations to categorize each bit.

	Decimal		Decimal
Excellent Black	(7)	Excellent White	(0)
Good Black	(6)	Good White	(1)
Fair Black	(5)	Fair White	(2)
Marginal	(4)	Marginal	(3)

The general form of a data matrix is:

$$X = \begin{matrix} X_{11}X_{12} \dots\dots\dots X_{1N} \\ X_{21}X_{22} \dots\dots\dots X_{2N} \\ \cdot \\ X_{M1}X_{M2} \dots\dots\dots X_{MN} \end{matrix}$$

The character 4 in the Prestige Pica font is shown in data matrix form in Fig. 2 and is used to illustrate the rules employed to establish a data matrix.

After all characters have been described in matrix form, the optimum bit locations for memory storage can then be determined, using a digital computer facility. This is accomplished by first establishing a difference matrix for each character versus every other character in the group ($N-1$ difference matrices per character where N is the total number of characters). The difference matrices provide the source of significant bits for the final encoding of each character.

The general form of a difference matrix is:

$$X-Y = \begin{matrix} X_{11}-Y_{11} \dots\dots\dots X_{1N}-Y_{1N} \\ X_{21}-Y_{M1} \dots\dots\dots X_{2N}-Y_{2N} \\ \cdot \\ X_{M1}-Y_{M1} \dots\dots\dots X_{MN}-Y_{MN} \end{matrix}$$

		N															
		A	B	C	D	E	F	G	H	I	J	K	L	M	N	O	P
M	1	0	0	0	0	0	0	0	2	28	7	0	0	0	0	0	0
	2	0	0	0	0	0	0	43	96	97	55	3	0	0	0	0	0
	3	0	0	0	0	0	6	84	100	100	78	16	0	0	0	0	0
	4	0	0	0	0	0	42	100	100	98	53	11	0	0	0	0	0
	5	0	0	0	0	0	83	100	100	84	32	1	0	0	0	0	0
	6	0	0	0	0	7	99	100	100	61	18	0	0	0	0	0	0
	7	0	0	0	1	34	100	100	86	38	3	0	0	0	0	0	0
	8	0	0	0	9	97	100	100	70	22	0	0	0	0	0	0	0
	9	0	0	0	63	100	100	88	38	10	0	0	0	0	0	0	0
	10	0	0	3	95	100	100	72	24	1	0	0	7	3	1	0	0
	11	0	0	37	100	100	84	43	12	0	2	54	73	29	1	0	0
	12	0	1	82	100	100	70	28	2	1	44	100	100	79	3	0	0
	13	0	21	100	100	83	35	18	0	2	70	100	100	74	15	0	0
	14	1	81	100	99	58	21	3	1	2	77	100	100	70	8	0	0
	15	29	99	100	82	32	11	0	0	3	86	100	100	67	8	0	0
	16	88	100	97	54	16	1	0	0	5	87	100	100	62	6	0	0
	17	99	100	74	26	8	0	0	0	2	86	100	100	59	2	0	0
	18	99	99	62	22	5	4	2	2	9	88	100	100	60	6	3	0
	19	99	97	78	64	59	52	56	51	57	95	100	100	83	62	61	36
	20	91	99	99	99	100	97	100	100	100	100	100	100	100	99	98	84
	21	88	98	99	99	98	95	95	95	95	100	98	100	91	94	94	71
	22	62	66	66	63	67	56	51	49	52	99	100	100	65	52	56	28
	23	23	25	26	25	23	20	17	15	14	94	100	100	46	20	19	13
	24	0	1	1	0	1	0	0	0	7	95	100	99	48	1	0	0
	25	0	0	0	0	0	0	0	0	6	99	100	100	47	4	0	0
	26	0	0	0	0	0	0	0	0	14	97	100	96	49	1	0	0
	27	0	0	0	0	0	0	0	0	9	62	91	71	26	5	0	0
	28	0	0	0	0	0	0	0	0	0	27	54	34	13	1	0	0
	29	0	0	0	0	0	0	0	0	0	1	9	5	1	0	0	0
	30	0	0	0	0	0	0	0	0	0	0	0	0	0	0	0	0

CHARACTER: 4

TYPE STYLES: PRESTIGE PICA

Fig. 1 Typical percentage occurrences of black when scanning a large number of "4's".

Only the difference matrix locations that contain positive or negative numbers 5, 6, or 7 are considered for final character encoding.

These are the key locations which make it possible to differentiate between characters. Best recognition reliability will be achieved, if the final mask is made up of locations that correspond to difference matrix locations containing a positive or negative number 7.

Positions having numbers in the difference matrix less than 5, 6, or 7, negative or positive, are discarded for assembly of the final mask of a character. What the smaller numbers actually convey is that the area under consideration in the difference matrix is equally black or white, more so the smaller the number. A zero, for example, would indicate that the two characters under consideration are equally black or white. A location containing a negative sign implies that the character to be encoded is white in that location, while the character it was compared against is black in the same location.

The process of formulating a master vocabulary continues by establishing the criteria that for each character to be encoded, at least Z differences should be selected for each and every other character in the group. A reject threshold is set at $Z-1$. This allows deterioration of the character up to and including $Z-2$ errors in the difference accumulation circuitry for the correct character. At that point correct recognition still occurs provided every combination of characters had Z or more differences. If the character deteriorates further, say, $Z-1$ errors are accumulated, a reject and a correct recognition would have equal probabilities of occurring. Finally, an accumulation of Z or more errors in all character channels would result in rejects only.

Typical values for Z as used in a laboratory reading machine varied from 5-7 depending on the desired relationship between reject and substitution rates. In a vocabulary of 36 characters for example, Z was equal to 5. This resulted into an encoded form of every

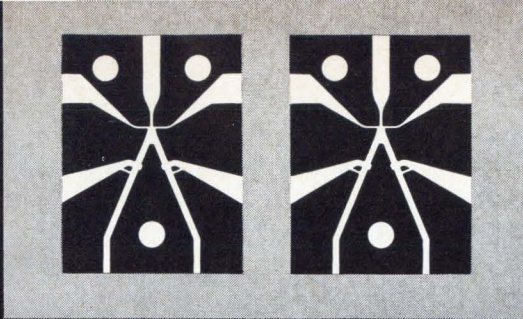

Fluid computer elements

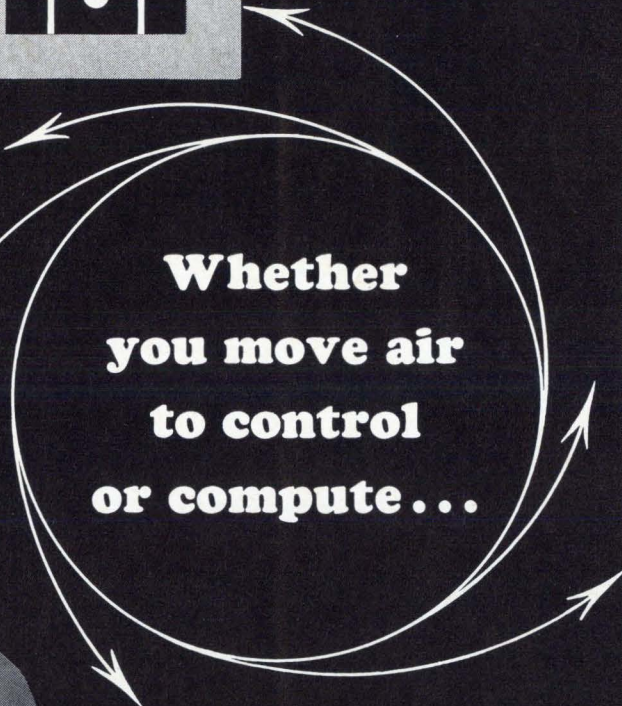

**Whether
you move air
to control
or compute...**

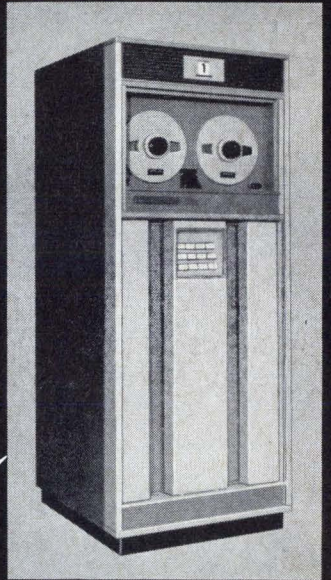

Vacuum tape loop control

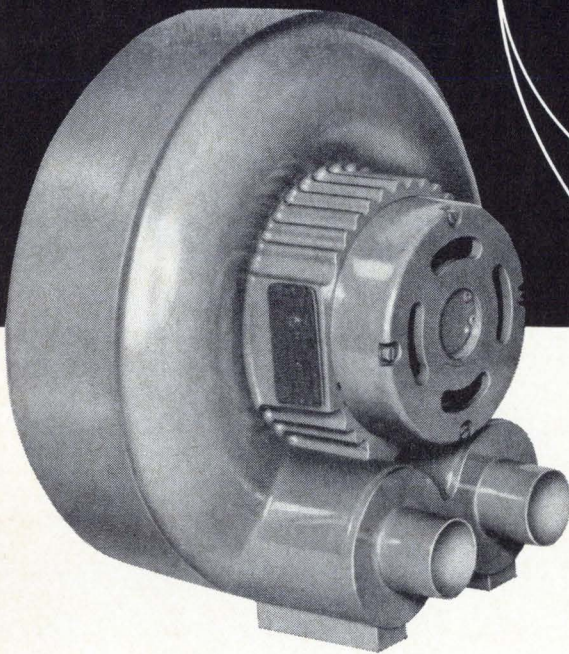

Diehl's new Series 915[†] vortex-type single stage blower offers these 8 advantages never before available in 1 unit

Now one blower—the new Diehl series 915—can do all these things for you: (1) generate high air pressures or vacuums (2) with longest possible life (3) with utmost simplicity and minimum of moving parts (4) for minimum maintenance (5) at lightest weight (6) with low rotational speeds (7) at low noise levels (8) at the lowest possible price!

New Series 915 vortex-type single-

stage blowers provide 60 cfm free air delivery, a static head of 24 inches of water at 20 cfm (.872 psig) (3400 rpm), with LOW NOISE—in the under-60 db range at most frequencies.

A unique design achieves this excellent noise suppression without the usual sacrifice in performance. Inlet and outlet are directly from the multi-blade impeller—no right angle turns to lower efficiency. Instead, resonant

sound absorbers—perforated tubes wrapped with polyurethane foam surrounded by a cavity and carefully tuned to the exact frequencies generated by the impeller blades—are located at both inlet and outlet.

Optional feature: a control which permits adjustment of pressure or suction at any flow rate.

Send the coupon today for a four-page bulletin on the 915 blower.

[†] Patent applied for

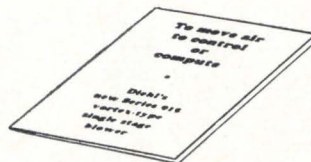

THE SINGER COMPANY

DIEHL DIVISION

Finderne Plant, Somerville, N. J., Tel. Randolph 5-2200
Greenville Service Office, 207 Eisenhower Drive, Greenville, S. C., Tel. 803-235-0382

*A Trademark of The Singer Company

CIRCLE NO. 18 ON INQUIRY CARD

Yes, I'd like to see a bulletin on the high performing but quiet new Diehl Series 915 vortex-type blower.

NAME _____
TITLE _____
COMPANY _____
ADDRESS _____
CITY _____ STATE _____ ZIP _____
DEPT. CD _____

		N															
		A	B	C	D	E	F	G	H	I	J	K	L	M	N	O	P
1	0	0	0	0	0	0	0	1	1	4	2	0	0	0	0	0	0
2	0	0	0	0	0	0	1	4	6	6	4	1	0	0	0	0	0
3	0	0	0	0	0	0	2	4	7	7	4	4	0	0	0	0	0
4	0	0	0	0	0	0	4	6	7	6	4	4	0	0	0	0	0
5	0	0	0	0	1	4	7	7	4	4	1	0	0	0	0	0	0
6	0	0	0	0	2	6	7	6	4	4	0	0	0	0	0	0	0
7	0	0	0	1	4	7	7	4	4	1	0	0	0	0	0	0	0
8	0	0	0	2	6	7	6	4	4	0	0	0	0	0	0	0	0
9	0	0	0	4	7	7	4	4	2	0	0	1	0	0	0	0	0
10	0	0	1	6	7	6	4	4	1	0	1	2	1	0	0	0	0
11	0	0	4	7	7	4	4	4	0	1	4	4	4	0	0	0	0
12	0	1	4	7	6	4	4	1	0	4	6	6	4	1	0	0	0
13	0	4	6	7	4	4	4	0	0	4	7	7	4	4	0	0	0
14	1	4	7	6	4	4	1	0	0	4	7	7	4	2	0	0	0
15	4	6	7	4	4	4	0	0	0	4	7	7	4	2	0	0	0
16	4	7	6	4	4	1	0	0	0	4	7	7	4	2	0	0	0
17	6	7	4	4	2	0	0	0	1	4	7	7	4	1	0	0	0
18	7	7	4	4	2	1	1	1	2	4	7	7	4	2	1	1	1
19	6	7	4	4	4	4	4	4	4	6	7	7	4	4	4	4	4
20	5	7	6	6	6	6	6	6	6	7	7	7	6	6	6	6	4
21	4	6	6	6	6	6	6	6	6	7	7	7	5	5	5	5	4
22	4	4	4	4	4	4	4	4	4	6	7	7	4	4	4	4	4
23	4	4	4	4	4	4	4	4	4	5	7	7	4	4	4	4	4
24	1	1	1	1	1	1	1	1	2	6	7	7	4	1	1	1	1
25	0	0	0	0	0	0	0	0	2	7	7	7	4	0	0	0	0
26	0	0	0	0	0	0	0	0	4	6	6	6	4	0	0	0	0
27	0	0	0	0	0	0	0	0	2	4	5	4	4	0	0	0	0
28	0	0	0	0	0	0	0	0	1	4	4	4	4	0	0	0	0
29	0	0	0	0	0	0	0	0	0	1	2	1	1	0	0	0	0
30	0	0	0	0	0	0	0	0	0	0	1	0	0	0	0	0	0

M

Fig. 2 Typical data matrix.

CHARACTER: 4
TYPE STYLES: PRESTIGE PICA

character with a total number of areas in each of about 35 (black or white) out of a possible total of 480. The 35 selected areas contained at least 5 differences between the encoded character and all other characters in that group.

The criteria used for the selection of *Z* locations of excellent, good, or fair quality of either black or white depends on their availability in the respective difference matrix. Preferred locations, of course, are those having the largest difference values in the greatest number of difference matrices. Selection of locations common to many characters permits minimizing recognition instrumentation complexity.

Before the selection of *Z* differences from each of the *N-1* difference matrices can start, all difference matrices are arranged in a descending order of total number of differences.

The difference matrices with the following characteristics are considered first to furnish location and color (black or white) for the final encoded form of the character:

1) Difference matrices that contain a total equal or less than *Z* differences.

2) Difference matrices that contain equal or less than *Z* excellent differences.

3) Difference matrices that contain equal or less than *Z* excellent and good differences.

4) Difference matrices that contain equal or less than *Z* good differences, in the absence of excellent differences.

Locations selected observing these rules are termed essential bits.

Before any further selection of difference bits takes place, three frequency matrices are constructed. If a certain location in a difference matrix contains a difference bit of excellent reliability, the procedure is to locate, count, and label all other matrices containing a difference bit of equal reliability in the same location. If a particular location in a difference matrix contains a difference bit of good reliability, it is necessary to find the number of other difference matrices that have good or excellent reliability differences in the same location.

Last, if a specific location in a difference matrix contains a difference bit of fair reliability, the total

number of differences (excellent, good, and fair) in the same location of all other difference matrices is established.

At this point in the process, the final encoded matrix of the character under consideration will contain many essential locations. For those characters for which the Z criteria is not yet satisfied, the selection of additional locations for the final encoding starts with the difference matrix containing the lowest number of specified locations. Each highest quality difference is checked to determine if its location is already contained in the final matrix. If it is, it counts toward meeting the Z criteria. If none of the differences under consideration are contained in the final matrix, the correct frequency matrices are consulted. The highest quality differences having the highest frequency of occurrence will then be selected. The possibility exists, however, that the highest frequency of occurrence occurs more than once in the particular frequency matrix. Assuming one additional difference is needed to satisfy the Z criteria, and more than one excellent quality difference has the same high frequency of occurrence in the corresponding frequency matrix, the frequency matrix containing the occurrence of excellent and good quality differences must be searched. If the two differences under consideration have identical frequencies of occurrence, the total frequency of occurrence matrix is searched. If the frequencies are equally high in all three matrices, the first encountered excellent quality difference is selected.

In the event that a decision must be made between two good quality differences and frequencies are equally high in the corresponding frequency matrix (excellent and good), the frequency matrix of excellent quality difference is examined to determine which of the two locations under consideration has the higher frequency before searching the total frequency matrix. The first encountered good quality difference is used in the event that all three frequency matrices contain equally high frequencies of occurrence.

Before considering the next difference matrix, the frequency matrices are updated. Each location in the respective frequency matrix corresponding to the location and quality of the differences in the difference matrix just considered is reduced by one count. The investigation is then continued until all difference matrices have contributed the required Z differences. The result of the process described is the final encoded version of a character consisting of black and white bit locations. A typical selection of locations is shown as shaded locations in Fig. 2 for the stored version of the "4" in a reading machine vocabulary, including upper and lower case alphas, numerals, and punctuation.

The significance of the data resulting from the process described is that a convolution of any encoded character with the total form of any other character in the same vocabulary group will result in a minimum of Z color differences at the coded locations.

Other vocabularies consisting of multi-font upper and lower case alphas and numerals have been encoded and memories have been designed by Link Group of General Precision, Inc. A laboratory page reader having a vocabulary of four type fonts has been successfully demonstrated.

END



INTEGRATED CIRCUITS: DESIGN PRINCIPLES AND FABRICATION

This book covers both the theoretical and the practical considerations of all aspects of integrated circuit fabrication and their influence on circuit and system design. The material reflects the accumulated experience of hundreds of engineers, scientists, technicians, and other technical people. The most recent and significant advances in the field are covered in detail. Topics include junction theory and properties, impurity diffusion, field-effect devices for integrated circuits, and integrated circuit packaging. Of particular importance to system designers, Part 2 takes up the design principles of monolithic and hybrid integrated circuits with special emphasis on comparisons between various approaches, limitations on their capabilities, and design freedoms and limitations presented by the basic technology. Price: \$12.50. Order from:

Motorola Semiconductor Products Div., Technical Information Center, 5005 East McDowell Rd., Phoenix, Ariz.

Performance Proves:

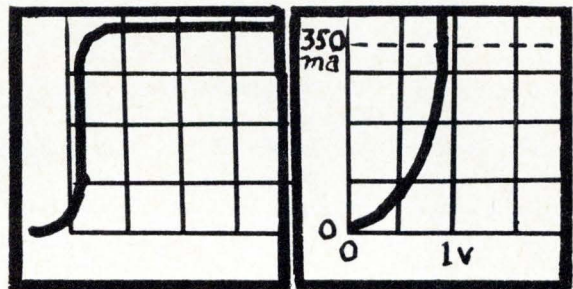

Fastest Switching Diode With High Forward Current

Test waveforms show that International Diode Corp.'s ID3-050T alloy junction diode has a reverse recovery time (left) in the picosecond range, with a 200-to-400 milliamperere forward conductance (right). IDC can provide more than 100 types to solve your design problems, including Q6-100, Q5-100, ID3-050, 1N3146. Price as low as 45 cents in quantities; delivery mostly from stock. Write or phone for details.

INTERNATIONAL DIODE CORP.

90 Forrest Street, Jersey City, N. J. 07304

201 - 432-7151

CIRCLE NO. 19 ON INQUIRY CARD

DEVELOPMENT of AN AIRMOVER TO IMPROVE COMPUTER PERFORMANCE

ARTHUR MANKIN, Airmover Engineer,
IMC Magnetics Corp., Westbury, L.I., N.Y.

One area of computer design that is often neglected the cooling system. As described here, it can be a significant factor in improving life and reliability.

Like most computer designers, Control Data Corp's engineers constantly seek ways to improve their computers, and they recently achieved this in a sometimes neglected portion of the machine — the cooling system. Although the existing cooling system was in most ways satisfactory, the designers of the 3000 Series felt that component life, and therefore system performance and life, could be improved by developing a new cooling system.

After the circuit designers have derated components and lowered quiescent current levels, there still remained some heat to be dissipated. And depending on the package configuration and component packing density within the package, heat dissipates unevenly. Or it collects, causing thermal gradients and sometimes local hot spots within the enclosure. This of course means that within the same enclosure some components may be working under a considerably more difficult environment than others. And this, in turn, can cause local variations in performance and life.

Unfortunately, it is exceedingly difficult to predict with exactness just how heat and airflow will behave within a given machine. Removing a few cards can create a hole through which most of the airstream flows, depriving non-adjacent components of the cooling air. Conversely, plugging in a few cards can add just enough airstream impedance that the flow is significantly diminished. And even where the card count has been stabilized, changes in operating and ambient conditions affect the need for cooling.

At CDC, the engineering staff

determined that a more even flow of air at a higher velocity would prevent future heat-caused component problems in the machine. The following airmover was specified very exactly, in black-box fashion.

Package: to be physically interchangeable with the old assembly. Physical size, mounting locations, and electrical inputs to be unchanged. The reasons are apparent when one considers the needs of field service and of manufacturing.

Output: package to supply more air against back pressures and more even distribution of the air. Air delivery and noise level requirements are shown in Fig. 1.

Input: 115 volts, to operate at both 50 and 60 cps, so as to accommodate the increasing foreign markets.

Equipment Protection: Should the customer's ambient air temperature rise too high, an alarm must be signalled to the machine's protective logic. Also, if the airstream ceases for any reason (for example, if a sheet of paper were to lift from the floor and jam into the air inlet), an alarm must be signalled to the logic.

Customer Considerations: Appearance to be compatible with a machine costing several thousands of dollars. Noise from the airmover not to exceed certain defined levels. Reliability and long life required in the airmover. Cost to be compatible with commercial equipment.

IMC Magnetics Corp., a manufacturer of air moving devices found that the package size and

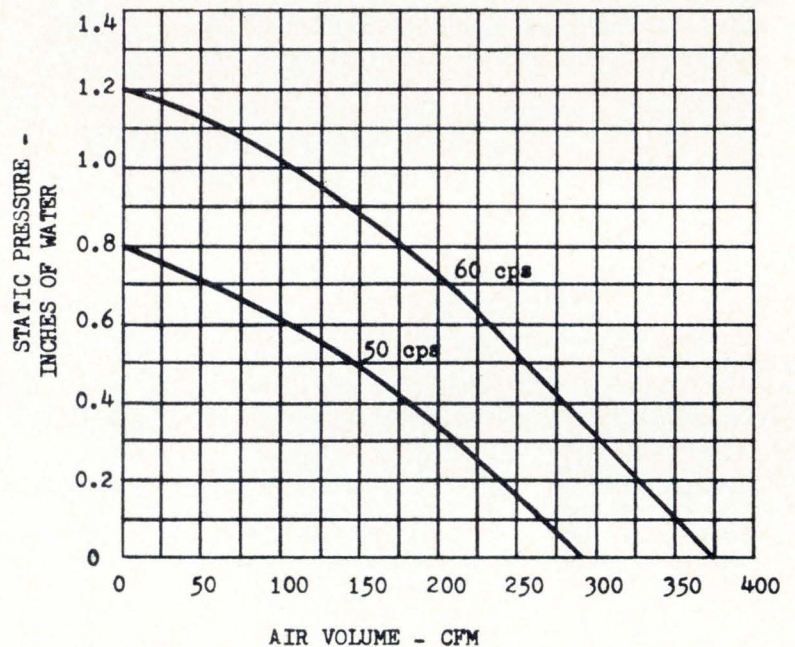

Fig. 1 Air delivery specified for the new airmover in the 3000 Series.

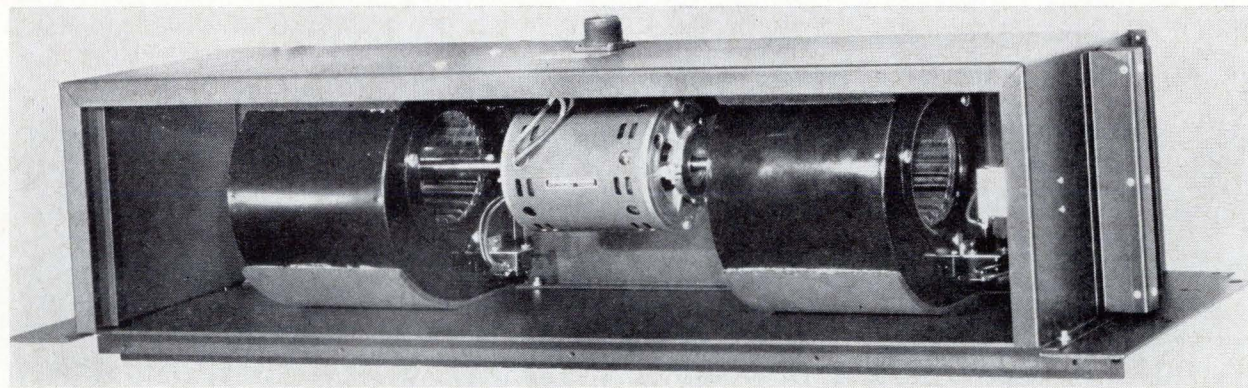
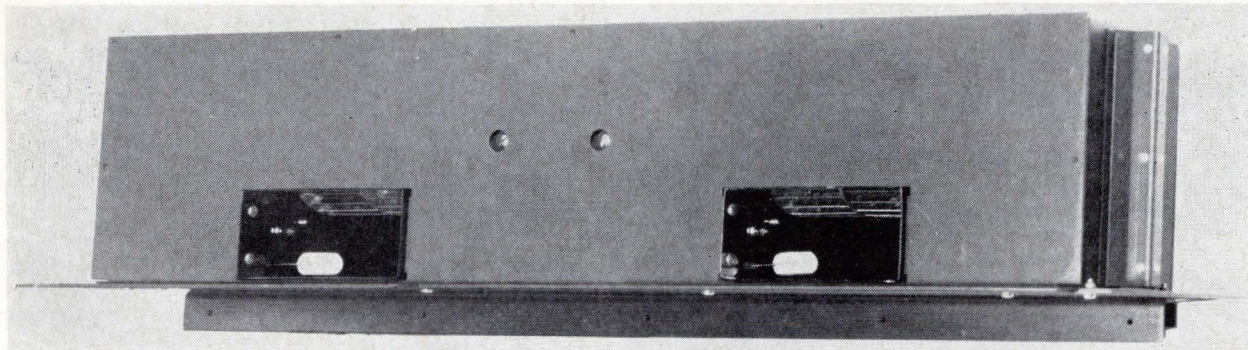

Fig. 2 (above) Front view of the airmover; (below) back view showing double-ended blower. Each wheel end section contains two blower wheels. Pads (between blower housing and package wall) were used to damp out low frequency noise.

configuration posed no unusual problems. However, obtaining the required output from the box while still meeting the other specifications was more involved. In addition to the air delivery specifications depicted in Fig. 1, the shape of the outlet air could be defined as a ribbon approximately 30 inches long by 1 inch wide at the outlet. Pressure and flow to be relatively even across the outlet.

Immediately then, the initial problem was to select the proper type of impeller. Propeller fans were quickly eliminated because of the high pressure required; vaneaxial fans because of the cost limitation. The choice seemed to be clearly a centrifugal blower. But it is mechanically difficult to obtain the long extended ribbon of air from a centrifugal blower. Typically, the centrifugal blower wheel's aspect ratio (length/diameter) ranges from about 1:1 to 1:4. What was needed was an aspect ratio of around 4:1.

Because of this fact, early design consideration was given to a cross flow blower where the air enters at one point on the wheel and exits at

another point on the wheel, so that the length of the wheel can be very large compared to its radius. Usually, the overall noise level as measured on a sound meter is approximately the same for a centrifugal blower as for a cross flow blower. However, the cross flow blower's noise level tends to be concentrated in the higher frequencies. Since the higher frequencies are more audible to the human ear, the CDC specification particularly limited the permissible amount of high frequency noise.

Thus, to meet the output requirements within the noise limitations, the decision was made to build and test a "double-double" centrifugal blower — a single motor with a double shaft extension, each shaft extension carrying a double wheel. The final design is shown in Fig. 2.

The initial tests with this system indicated that air delivery was both sufficient and even enough across the outlet to meet the requirements. But the noise level was high. Fortunately, it was high at the low frequency end where it is possible to reduce it effectively. First, isolating

the motor mounting from the frame and particularly from the blower housing reduced the noise level approximately 4 db. Another 4-db reduction was obtained by isolating the blower housing from the system enclosure with a sponge rubber sheet. Together, these measures brought the design well within specs.

Noise, output, and package requirements were thereby met. Equipment protection was provided by three separate devices. Thermal protection for the motor will stop the motor if it should overheat for any reason. Thermal sensors detect the temperature of incoming air and are set to trigger an alarm signal should heat rise beyond specified limits. In parallel, a pair of spring-loaded air vane switches signal abnormality in air flow.

After the initial design concept had been found workable in the laboratory, further effort in both design and manufacturing permitted IMC to meet cost and appearance requirements without sacrificing any of the performance initially achieved.

Hybrid Computer Technique

Yields Random Signal Probability Distributions

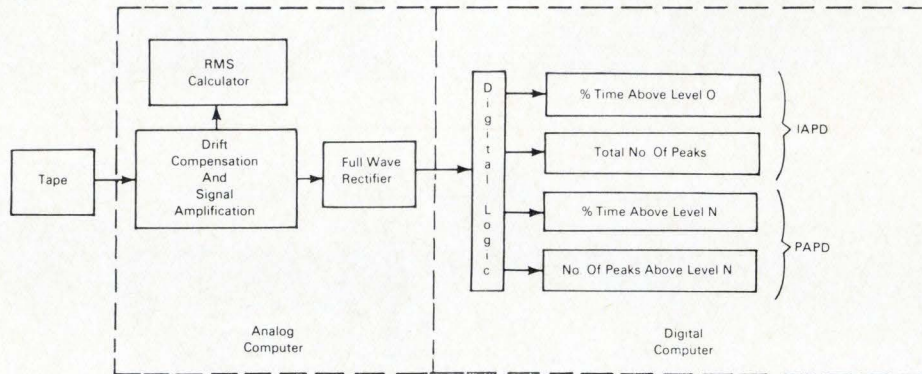

THE PROBLEM

A complete space vehicle responds, during launch, to a variety of loadings, the study of which requires the outputs of many sensors. Analyzing these data graphically by hand introduces delays and human error factors. A rapid, accurate determination of probability distributions from the sensor outputs is needed.

THE SOLUTION

A special digital logic computer is combined with a standard analog computer to determine the probability distributions of both the instantaneous and peak amplitudes of a random signal recorded on magnetic tape.

HOW IT'S DONE

The instantaneous amplitude probability distribution (IAPD) of a random signal is the percentage of time the signal is above some arbitrary value, where there are n arbitrary values to provide the distribution comparison. The peak amplitude probability distribution (PAPD) of a random signal is the percentage of the total number of peaks that are above some arbitrary value among n arbitrary values.

The recorded signal from the tape is amplified and fed to a low pass filter, whose output is inverted and subtracted from the input signal to remove the low frequency components identified with drift in the sensing and recording devices. The RMS calculator continuously generates the root-mean-square of this information signal. The RMS signal is rectified and routed to the digital logic where the two components (IAPD and PAPD) are determined and fed to the readout. To measure the percentage of time the signal is above some arbitrary value (IAPD), it is assumed that the signal exceeded that level 100% of the time, and the amount of time the signal was below that level is subtracted. This is accomplished by

dividing the logic time base into 10,000 equal increments and subtracting one digit for each time increment the signal is below that level. When the time base counter reaches 0000, it produces a carry-out that stops the computer and feeds the answer to the readout.

To measure the percentage of the total number of peaks that are above some arbitrary value (PAPD), comparator outputs drive one-way digital differentiators. A one-way differentiator produces a blip one clock pulse wide when the input goes from the low level to the high level (goes from 0 to 1). The differentiator output drives a binary upcounter. When the input to the counter is high, it will count up one bit at each clock pulse. Since the differentiator is high for only one clock pulse, the counter will add one bit each time the increasing signal crosses the set level. The signal, rather than the absolute value, drives the counter in level 0. This assures that the signal will pass through zero. The counter in level 0 counts only half the total peaks as negative portion of the signal has no effect on the comparator.

NOTES

1. Data that requires five to seven man-days to reduce by hand can be reduced in 30 seconds by this method.
2. This method of analysis should have application in such non-stationary random processes.
3. Inquiries concerning this invention may be directed to: Technology Utilization Officer, Ames Research Center, Moffett Field, California, 94035, Reference: B65-10208.

PATENT STATUS

NASA encourages the immediate commercial use of this invention. Inquiries about obtaining rights for its commercial use may be made to NASA, Code AGP, Washington, D.C., 20546. **END**

RICHARD PETERSEN,
Contributing Editor

MANUAL INPUT DEVICES

Manual input to a computer or other data processing system is usually indirect, simply because the human and the machine operate at vastly different rates. Where large quantities of data are involved, it is more efficient and economical for the operator to translate the input information, off-line, onto punch cards, paper tape, or magnetic tape, which the system can then absorb at its own rate.

However, some means of direct manual input is still a necessity in most applications. It may take the dynamic form of real-time query or entry of transient information, or a more static form of setting up constants and operational parameters. The dynamic form of input is generally via a keyboard unit such as a typewriter, which may or may not also produce hard copy for operator use. (Another approach to dynamic input-output, the light-pen/CRT technique, is presently in the development stages. For a description of one technique, see the article on the Rand Tablet in the April 1965 issue of *COMPUTER DESIGN*.) Static input is more often generated by means of manually-preset thumbwheel switches.

This Product Reference File article surveys currently-available keyboards and thumbwheel switches and outlines the different operating approaches taken by the manufacturers.

Input Typewriters

An input typewriter is a keyboard unit which produces hard copy in ordinary typewriter fashion and at the same time generates electrical output signals that can be fed directly into an EDP system. Some form of buffering is usually required because of timing and noise problems. Any input typewriter is essentially a *typewriter*, with all the high current drain and gross electromechanical movements required to print out copy character-by-character. The coded electrical outputs are something of an afterthought and tend to be contaminated with signal noise. It's a trade-off situation — if the user must have page copy, he must accept the problems.

Individual manufacturers occasionally adapt existing typewriters as input units for a special application. Such adaptation usually takes the form of accepting the signals generated by the typewriter as a by-product of its own operation (e.g., the 7-bit code from IBM solenoids), and re-coding these signals into the required pattern at the required levels.

Manufacturers' input typewriters described below involve internal modifications to the typewriter itself, resulting in a product-line device. One company, Friden, Inc., mentioned below, does not really

PRODUCT REFERENCE FILE

Background concepts, selection criteria, and application information on a class of products used by digital design engineers.

have an input typewriter, but their Flexowriter finds widespread use as one. A summary of the major characteristics of manufacturers' models appears in Table 1.

Manufacturers' Units

Connecticut Technical Corp., Hartford, Conn. — This company's input-output typewriter, shown in Fig. 1, was described in the December 1963 issue of **COMPUTER DESIGN**. Originally designed for use with military Fieldata computers, this unit offers either coded or uncoded output signals. Each typewriter key operates a bifurcated precious metal switch for direct output. For coded outputs, the switch signals are applied to an internal diode matrix. Maximum input rate is 9.3 cps.

Connecticut Technical has also developed a special input typewriter for graphic arts applications. This unit has 19 extra function switches, wired in, in addition to extras on the keyboard. This particular machine is a transmit uncoded partial receive unit and contains at least two unusual functions in addition to the normal standards, namely (1) the operation of the carriage return key furnishes electrical output resulting in the emptying of the computer buffer store into a punched tape with the computer in turn operating the carriage return mech-

TABLE 1 • Input Typewriters

Mfgr.	Model	Chassis	Technique	Code	Rate
Connecticut Technical Corp.	----	Underwood	Electromech.	Direct	9.3 cps
Invac Corp.	TTR 100	RemRand	Photoelectric	8 bits	10 cps
	TTR 200	Selectric	Photoelectric	8 bits	15.5 cps
Soroban Engineering	Computer-iter	IBM	Electromech.	8 bits	10 cps

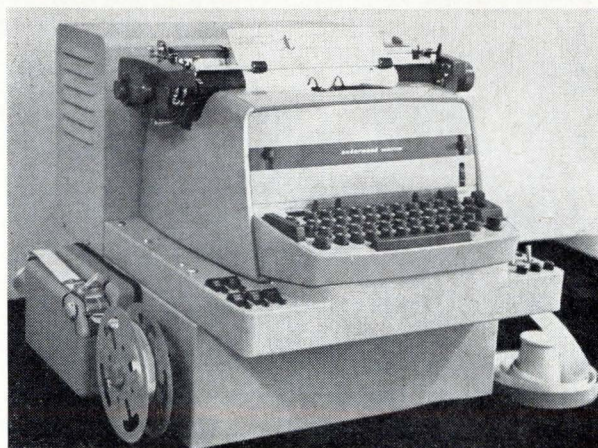

Fig. 1 Connecticut Technical Corp.'s input typewriter incorporates a paper tape punch and reader and input-output communications interface. The keyboard is shiftless except for certain "Fieldata" codes.

anism, and (2) a back space character strike-out system, wherein operation of the back space results in an electrical signal clearing the last character from memory while the

typewriter action, controlled from the computer, back spaces one space and automatically strikes a square around the deleted character from a non-escaping key.

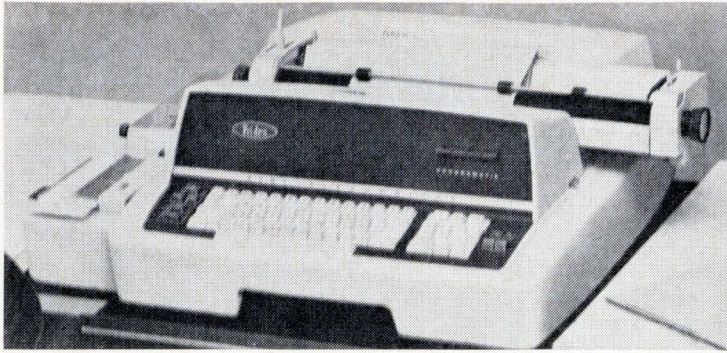

Fig. 2 Friden's new Model 2201 Flexowriter.

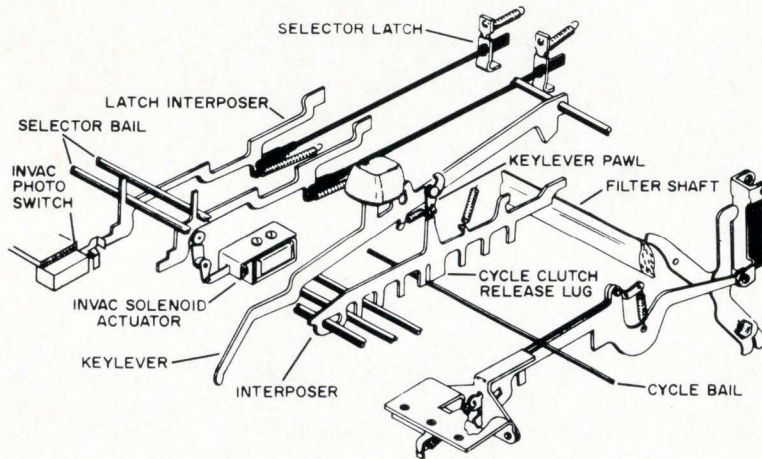

Fig. 3 Invac Corp's Series 200 input typewriter, which uses an IBM Selectric chassis, combines mechanical and photo-electric techniques. Pressing a data key actuates a selector interposer, which engages the selector bails that operate the latch interposers. A bank of six photoswitches senses the movement of the latch interposers to generate electrical signals, which are amplified to produce the output code. Rotation of the print cycle shaft in the unit generates the strobe signal after the photoswitch data has become available.

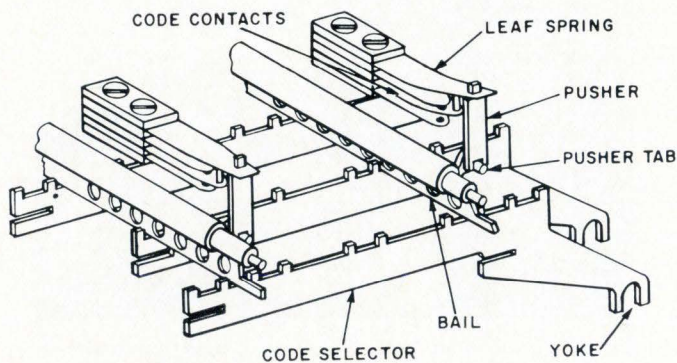

Fig. 4 Soroban Engineering's Computeriter uses a mechanical encoder. The yoke of the code selector fits over a pin projecting from the side of its associated typewriter cam on the keyboard. Pressing the key pulls the code selector, whose notched teeth engage to edges of selected bails, to cause a rocking motion in those bails. A tab projecting from the bail drives a contact pusher to generate one bit of the parallel output code. When the cam releases, springs return the bails and code selectors to normal position.

Friden, Inc., San Leandro, Cal. — Still going strong as a workhorse input unit, even though it does not provide direct input, Friden's Flexowriter is essentially a heavy-duty electric typewriter which has been successfully adapted for operation as a remote-controlled (e.g., computer output) device, a paper tape punch control, a card punch control, and an automatic typewriter capable of combining tape and card data with data entered manually by the operator. It is this flexibility which accounts for the continued popularity of the Flexowriter, despite certain manifest disadvantages as a manual input device, and increasing competition. When used as an input device, the Flexowriter simply produces a perforated tape, which must then be read into the system by a separate reader. The new Model 2201 Flexowriter (Fig. 2) is a re-styled, somewhat faster and quieter machine.

Invac Corp., Waltham, Mass. — By adding mechanical encoders and photoelectric switches, Invac has adapted both IBM Selectric and Remington Rand Model 300 electric typewriters as input devices. Operation of both types of units can be illustrated by Invac's Series 200 Typewriter Transmitter/Receiver, which uses the Selectric "golf-ball" chassis. The Selectric has a spherical, character-embossed print head which moves along the printing line and is rotated in two planes to select the character to be printed. In the IBM unit, the seven solenoids (six control, one check) which drive the print head are brought out as signals. In the Invac Series 200, a bank of six photocells (see Fig. 3) sense the mechanical position of the keyboard interposers to produce output signals. Function codes are derived by encoding outputs in a diode matrix.

Soroban Engineering, Inc., Melbourne, Fla. — This company's "Computeriter" is an IBM electric typewriter chassis with a mechanical encoder (see Fig. 4). Each data key generates an output code of up to eight bits from leaf-spring contacts, and a common contact is available for use as a strobe. Machine function outputs are provided by relay contact closures. Maximum operating rate is 10 cps.

Input Keyboards

Recent years have seen an increasing number of keyboard-only units for applications which do not require printed copy along with the input signals. These units, freed of the necessity of driving relatively massive mechanical printing elements, are simpler, smaller, and generate less electrical noise than input typewriters.

Many manufacturers of pushbutton switches occasionally build up such switches into special-purpose keyboard control panels. However, this article treats only complete keyboard units designed for rapid manual data input operation in the manner of a typewriter.

Most manufacturers of input keyboards have taken some pains to provide a key touch comparable to that of units with which the operator is already familiar (the IBM electric typewriter is commonly chosen as a model). Table 2 lists the major characteristics of manufacturers' models. Such units, described below, range from almost purely mechanical to almost purely electronic devices.

Manufacturers' Units

Burroughs Corp., Pasadena, Cal. — Burroughs uses a small decimal keyboard, the Model 410, with its 205 computing system, and now offers it as a separate item with either 13 or 16 keys. Each key operates a single-pole double-throw switch whose closures are brought out directly.

Connecticut Technical Corp., Hartford, Conn. — The high-speed alphanumeric keyboard being produced by Connecticut Technical has been available in service test quantities for six months. Two versions have been initially produced to satisfy the requirements of the graphic arts industry. Each is capable of being furnished with up to 70 keys. A small standard 44-46 key alphanumeric unit is manufactured by the shortening of the transverse members. One version, shown in Fig. 5, furnishes electrical output for a justifying computer, the other is used in the preparation of tape for justifying computers. The keyboard is a motor-driven mechanical device with switch closure output. Present units

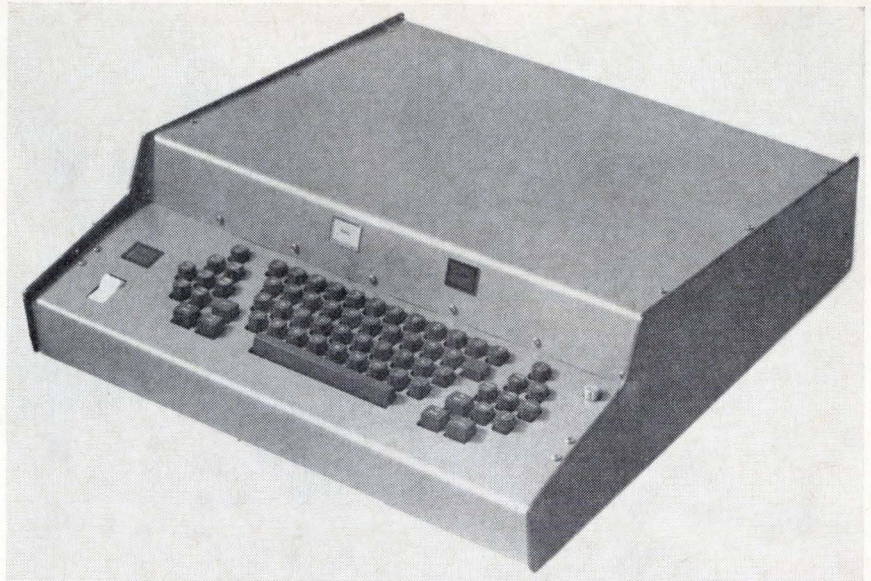

Fig. 5 Connecticut Technical Corp.'s Model KB-100 alphanumeric keyboard.

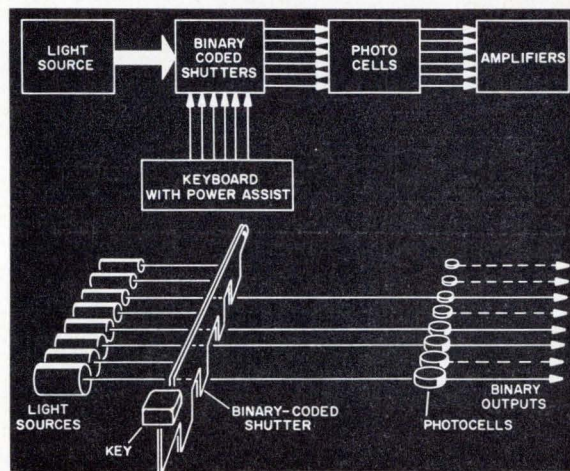

Fig. 6 In the Invac PK-144 and PK-164 keyboards, pressing a key lowers a coded shutter between a bank of light sources and associated photocells, causing a resistive change in the selected photocells. Amplifiers convert the photocell signals into the output code. Operation of the coded shutter also energizes two solenoids which operate a common bail to lock the key lever and shutter while a strobe signal is generated.



Fig. 7 Navigation Computer Corp.'s Series 1050 keyboards are available in both numeric and alphanumeric versions. Operation is almost entirely electronic.

can provide eight channel code plus strobe while simultaneously furnishing two form A non-coded closures to identify the key depressed. The

keyboard without the punch has an average rate capability in excess of 20 characters per second. Its instantaneous two character rate capability

FA



Take boards, wire, solder, diodes, transistors, capacitors and resistors. Put them together with cordwooding, twisted-pair wiring and a pile of connectors. What have you got? A low speed, high cost, alternative to Micrologic* integrated circuitry.

*Fairchild's Trademark for Integrated Circuits

FAIRCHILD

is 50 character per second. When integrated with a 20 character per second punch, the input rate is timed to 19 char./sec. average to preclude the need for electronic feed back interlocking. The touch is adjustable at the keyboard from 2½ to 6 oz. It is fully interlocked mechanically and has a single character storage capability. The code output switches are gated by a bounce free strobe, and can transfer 48 volts at 1 amp resistive. The data pulse is factory adjustable up to 25 ms. The strobe is adjustable up to 20 ms and is positionable with respect to data pulse. The keyboard's mechanical interlock can be "locked up" remotely by solenoid actuation. Power switches and lights and "state" indicator lights for upper and lower case, etc., are available.

Invac Corp., Waltham, Mass. — Invac's PK-144 and PK-164 keyboards combine photoelectric encoding with solenoids for power assist and strobing purposes. As illustrated in Fig. 6, each key drops a coded shutter between a bank of light sources and a facing bank of photocells to produce the code. The shutter is locked in place until after the strobe signal. The Model PK-144 has 45 alphanumeric keys; the Model PK-164 has 63 alphanumeric keys. Both include a space bar, and the PK-144 can be fitted with additional function keys.

Navigation Computer Corp., Norristown, Pa. — Navcor's 1050 Series keyboards (Fig. 7) are completely modular units which can provide a variety of code and control outputs, according to the requirements of the user. Each key incorporates a magnetically-actuated sealed switch which is available with either direct contact closure or pulse output. The keys are mounted directly on an etched-circuit base panel beneath the keyboard panel. An optional diode matrix board plugs in beneath the base panel to produce coded outputs of up to 15 bits for each key. Still another etched-circuit board can be plugged in (forming a third layer to the sandwich) to provide timing, blanking, electronic interlock, and similar functions. Flip-flop buffer storage is still another option. A further option provides

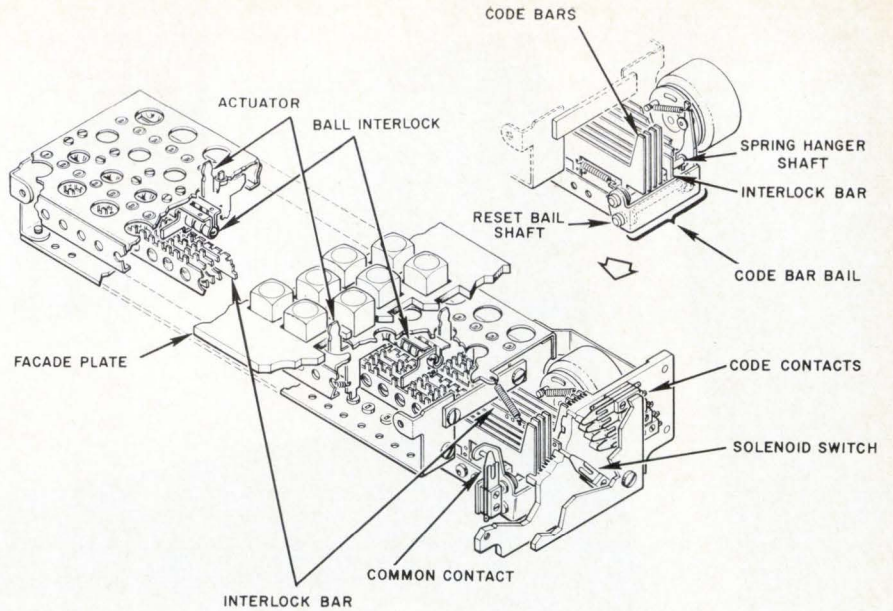

Fig. 8 In the Soroban Series FK keyboards, pressing a key locks all code bars except those directly involved in producing the desired output code, and also actuates a solenoid, which works through a bail to allow the selected code bars to close the code contacts. After the code contacts close, a common strobe contact is operated. A caged row of ball bearings prevents simultaneous operation of more than one key.

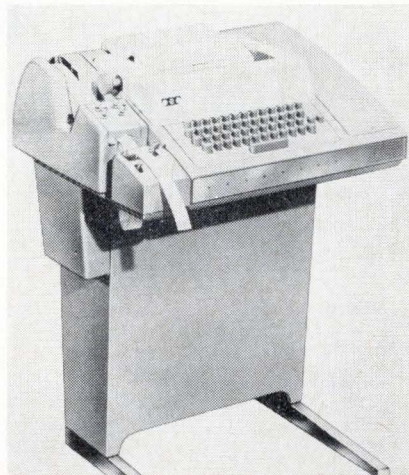

Fig. 9 Teletype Corp.'s Model 33 Numeric Keyboard Automatic Send-Receive Set is one of their many data communication units that can be used for machine input.

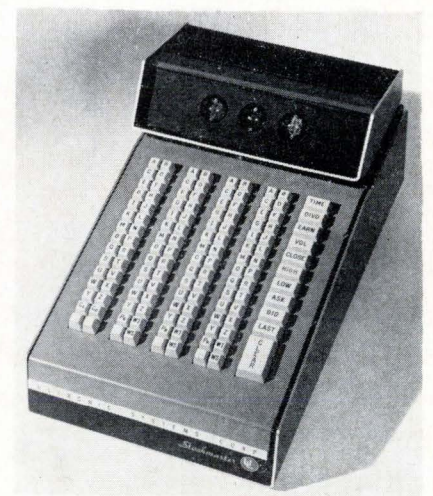

Fig. 10 Ultrasonic Systems Corp.'s encoding keyboard with visual display.

automatic protection against both double strike and slur errors.

Soroban Engineering, Inc., Melbourne, Fla. — Soroban's Series FK keyboards (Fig. 8) are essentially mechanical devices using

spring-loaded code bars. Pressing a key triggers a solenoid which operates a bail to allow selected code bars to close contacts. Mechanical double-strike protection is included. Keyboards are available with up to 64 keys, including space.

TABLE 2 • Input Keyboards

Mfgr.	Model	Technique	Keys	Code	Comments
Burroughs Corp.	410	Electromech.	13, 16	Direct	—
Conn. Tech. Corp.	KB-100	Electromech.	70	8 bits	High-Speed unit
Invac Corp.	PK-144	Photoelectric	46	8 bits	Other codes Available
	PK-164	Photoelectric	64	8 bits	
Navcor	1050	Electronic	50	8 bits	Pulse, buffered, timing outputs
	1050N	Electronic	16	8 bits	
Soroban Engineering	FK	Electromech.	up to 64	8 bits	Up to 16 bits available on order
Teletype Corp.	—	Electromech.	52	Direct	Special purpose keys
Ultronic Systems Corp.	500	Electromech.	Unlimited	5 bits	Visual display
	600	Electromech.	Unlimited	Unlimited	Visual display

Teletype Corp., Skokie, Ill. — Standard teletypewriter models by Teletype Corp. are often used for machine input although they are primarily data communication sets. However, Teletype also offers self-contained 4-row alphanumeric keyboards that provide direct parallel-

wire entry of variable data into computers.

The standard Teletype sets are available with 3-row keyboards, 4-row keyboards, and numeric keyboards. Their Model 32 line contains 3-row keyboards that operate on 5-level Baudot code. Model 33

sets contain the 4-row keyboards that operate on standard ASCII code. All units are available with many different special purpose keys. Teletype's Model 35 sets are for heavy traffic loads. Model 33 Numeric Keyboard Automatic Send-Receive Set is shown in Fig. 9.

Ultronic Systems Corp., Pennsauken, N.J. — This company's encoding keyboards (see Fig. 10) will allow the input of combinations of any code through the use of either mechanical coding bars operating a miniature switch or a diode encoding matrix driven from reed switches actuated by permanent magnets. Ease of operation, rugged construction, high reliability, and flexibility of design are said to be the major features of these units. The keyboards are made with some visual indication of input format. It is accomplished by either the key remaining in its depressed position until cleared or by means of visual display. Prices average \$4 to \$8 per key, depending on coding requirements, visual display, keyboard layout, etc.

IS YOUR SYSTEM SPECIAL?

If so, use an input device designed to mate with it.

The typewriters furnish hard copy from a fully interlocked keyboard. You can have coded or uncoded input, together with 20 or more extra function keys and make selection from up to 50 special options that our customers use to reduce the cost of system electronics.

The keyboards have single character memory • switch closure output with adjustable timing • easily changed mechanical coding • power assist • light touch • AND 20 character per second non-ambiguous data rate.

Write for information on input-output typewriters • data loggers • keyboards • keyboard perforators, and low cost tape printers.

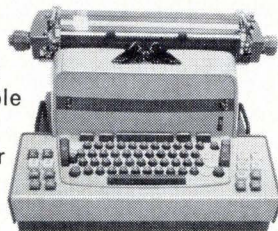

Model KB-100
Input-output computer typewriter
(Graphic Arts Computer Special)



Model KBP-100
Keyboard perforator

CONNECTICUT TECHNICAL corporation



3000 MAIN STREET

HARTFORD, CONNECTICUT 06120

CIRCLE NO. 21 ON INQUIRY CARD

THUMBWHEEL SWITCHES

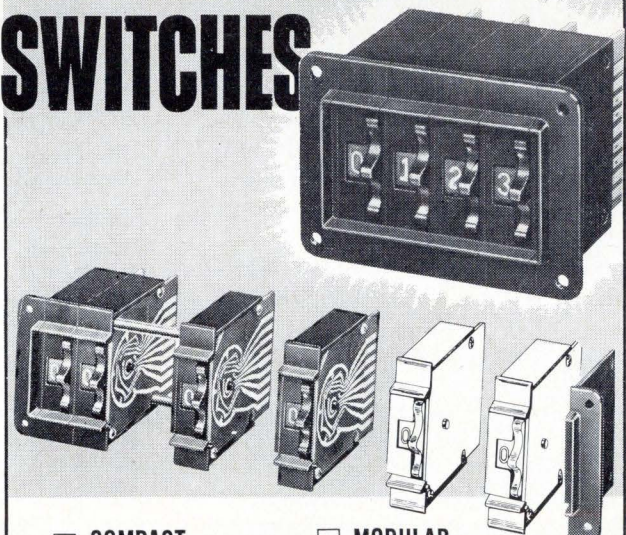

- COMPACT
- POSITIVE OPERATION
- SIMPLE, CLEAN INSTALLATION
- ECONOMICAL
- MODULAR
- WIDE RANGE OUTPUT
- EDGE LIGHTING AVAILABLE

Send for further information

TECH LABORATORIES, INC.

Palisades Park, New Jersey
Phone: 201 — 944-2221 • TWX: 201 — 947-4730

CIRCLE NO. 22 ON INQUIRY CARD

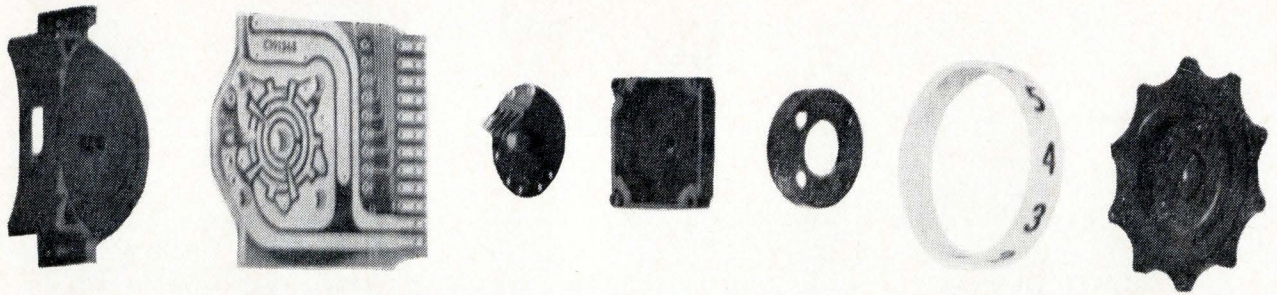

Fig. 11 Engineered Electronic Corp's Series 300 unit illustrates the major parts of typical thumbwheel switches.

Thumbwheel Switches

Thumbwheel switches can be categorized between rapid-fire keyboards and step-by-step pushbuttons, as far as versatility is concerned. They cannot be operated very rapidly, but each is capable of producing a variety of signals, and a full bank of these switches can represent virtually any condition required by the system. They are typically used in setting up data which must remain available to the system, but which must be changed by the operator from time to time — for example, constants for a computation or control process. A glossary of thumbwheel switch terms is given in Table 3.

A typical thumbwheel switch (Fig. 11) includes a rotor which is manually turned to a desired index position, and a detent mechanism which locks in the rotor and prevents hang-up between positions. Each index position is visually displayed on the front of the rotor (typically as a number), and also makes contact with brushes on the body of the switch. The brushes



Fig. 12 Open type construction is used in Chicago Dynamic Industries' line of thumbwheel switches. This type of construction allows the user to choose from a wide variety of options — multiple decks, double-width wheels, and extended boards for component mounting.

are usually soldered to conductors on an etched-circuit card and so brought out to the output cable or connector. Stops are used to skip unused portions on the rotor. Spacers are used both to fill out a bank of switches to a desired length

and to divide, functionally, separate groups of switches (integrals vs. fractions, or days vs. months).

The etched-circuit card which provides the outputs may or may not include encoding capabilities. That is, it may indicate the position

TABLE 3 • Glossary of Thumbwheel Switch Terms

SWITCH COMMON: The input connection and wiring that remains active in all switching positions.

BRUSHES: Electrical conductors that transfer the current from the stator to the output lines.

STATOR: Conducting surfaces of the switch. Similar to the commutator in electrical rotating mechanisms.

SHORTING SWITCH: A switch type where contact is made for a new position before breaking contact with the previous position. Classified as "make before break" switch.

NON-SHORTING SWITCH: A switch type where contact is broken from one position before contact is made with the next. Classified as a "break before make" switch.

DETENT: Component that holds the switch at exact indexing positions; prevents hang-up between positions.

INDEXING or SWITCHING POSITIONS: Defines the available output lines of a switch; for instance, an 8-, 10-, or 12-position switch. Various switch positions are usually referenced numerically or alphabetically.

STATIONS: Defines locations and quantities of switches and spacers in an assembly; for instance, five 8-position switches and one spacer make up a six station assembly.

STOPS: Hardware for mechanically limiting the number of active positions in a switch; for instance, limiting a 10-position switch to five active outputs.

SPACERS: Component used when it is desirable to physically separate one or more switches without leaving an open space in the assembly. May replace any compatible switch module.

ESCUTCHEON PLATE or BEZEL: A part designed to cover all but the essential portions of the switch faces.

MOUNTING HARDWARE: Parts used to mount plates, panels, modules, etc., to the assembly proper.

PIN NUMBERS: Numbers used to identify the relationship between the switching positions and the termination points of a circuit card.

Courtesy of Engineered Electronics Co.

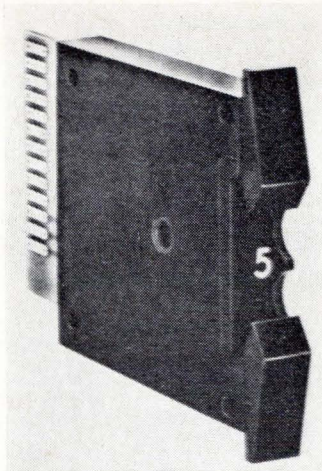

Fig. 13 Digitrans' Series 500 switch has a 16-position setting wheel and up to 8-level coded outputs.

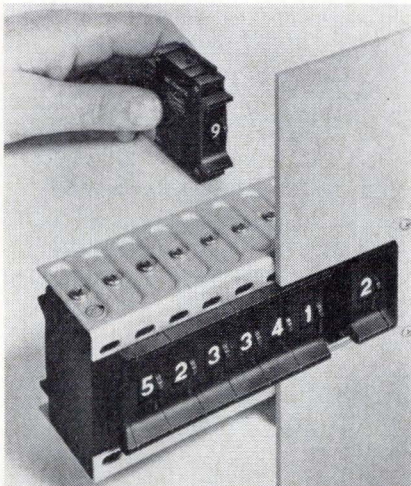

Fig. 14 Engineered Electronics' Series 200 thumbwheel switches feature removable single switches.

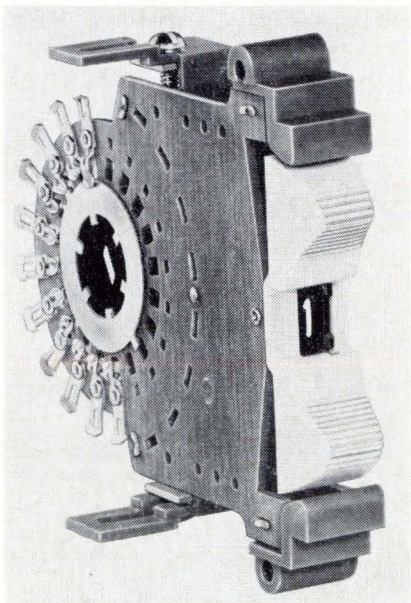

Fig. 16 Oak Manufacturing Co. uses a push-type rocker instead of the conventional tabs projecting from the rotor.

**ELIMINATES
THE
MIDDLEMAN!**

AN INCREMENTAL RECORDER
FOR ONLY

\$3750⁰⁰

COMPLETE, READY TO OPERATE
Build it in (Rack Mount)
or carry it (Portable)

**DIGI-
DATA'S**

DIGITAL STEPPING RECORDER

STORE DATA AT ANY RATE — 0 TO 400
CHARACTERS PER SECOND

READ ON ANY IBM COMPATIBLE TRANSPORT

GENERATES FULLY COMPATIBLE IBM TAPE AUTOMATICALLY!

- Choice of 200 or optional 556 bits per inch
- Standard IBM type 10½" reels, ½" tape
- 7 track standard spacing
- ¾" inter record gap with longitudinal check character
- Lateral parity selectable—odd or even
- For additional information, phone or write

DDC DIGITAL STEPPING RECORDERS
DIGITAL DATA HANDLING EQUIPMENT

DIGI-DATA CORPORATION

Main Office: 4315 Baltimore Ave. • Bladensburg, Md. 20710 • (301) 277-9378
Western Regional Office: 4341 W. Commonwealth Ave. • Fullerton, Cal. 92633 • (213) 941-3182

CIRCLE NO. 23 ON INQUIRY CARD

of the rotor by activating a single line associated with that position, or it may contain a matrix which produces an equivalent digital code as an output. Coded switches thus offer an additional capability in that they can be used as code converters. A switch with 10 positions, which generates a 4-bit binary code, is automatically a decimal-to-BCD converter. The possibilities inher-

ent in this sort of application become obvious when one considers that thumbwheel switches are available with 40 or more index positions, and with outputs ranging up to nearly 100 code configurations.

Table 4 summarizes the major characteristics of commercially-available thumbwheel switches. Brief descriptions of each manufacturer's product line are given below.



Fig. 15 North Atlantic Industries' Series SM-412 switches are built into complete assemblies to customer specs.

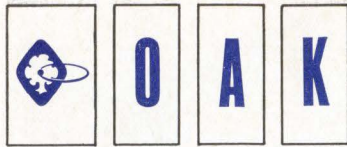

...35 YEARS LEADERSHIP
IN ROTARY SWITCHES

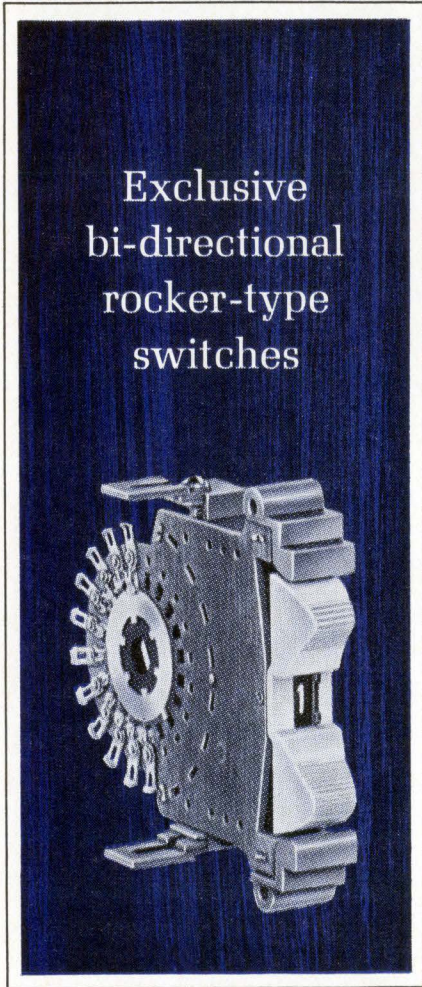

Exclusive
bi-directional
rocker-type
switches

New Oak® Rocker Switches are ideally designed for panel mounting. Module principle permits mounting a single switch, or horizontal or vertical module arrangements of as many switches as desired. All have sturdy mounting frames. Fingers never touch readout characters—Oak's exclusive recessed numerals assure continued legibility. You get bi-directional, multi-position operation, choice of alpha or numeric readout. Can be read from right or left. Can be operated with gloves on for military use. Made with Oak-pioneered double-wiping action contacts.

For full details, write for Bulletin SP-202.

OAK MANUFACTURING CO.

A DIVISION OF OAK ELECTRO/NETICS CORP.
CRYSTAL LAKE, ILLINOIS 60014 • Telephone: 815-459-5000
TWX: 815-459-5628 • Cable Address OAKMANCO
CIRCLE NO. 24 ON INQUIRY CARD

TABLE 4 • Thumbwheel Switches

Mfgr.	Model	Approx. Size*			Positions	Codes	Comments
		H	W	L			
Chicago Dynamic	TTD	2.1	0.6	2.3	8,10,12,16	Direct	Lighted
	TTB	2.1	0.6	2.3	8,10,12,16	4 bits	Lighted
	MTTD	1.7	0.3	1.4	8,10,12	Direct	
	MTTB	1.7	0.3	1.4	10	4 bits	
	TD	2.1	0.6	2.2	10	Direct	Lighted
	TB	2.1	0.6	2.2	8,10,12,16	4 bits	Lighted
Digitran Co.	200	1.1	0.5	1.2	10	4 bits	Sealed
	300	2.3	0.5	1.6	8,10,12	4 bits,	
	400	1.9	0.6	2.5	8,10	4 bits,	Sealed
	500	3.2	0.5	2.8	16	8 bits,	
	600				40	6 bits	
	700	1.1	0.5	1.2	10	4 bits	
Engineered Electronics Co.	100	2.0	0.5	1.6	8,10,12	4, 5 bits,	
	200	2.0	0.5	1.6	10	4, 5 bits,	Lighted, sealed
	300	2.2	0.5	2.0	8,10,12	4, 5 bits,	Lighted sealed
	400	2.2	0.5	2.0	8,10,12	4, 5 bits,	Lighted
	700	0.9	0.4	1.3	10	4 bits	Lighted, sealed
	800	0.9	0.4	1.3	10	4 bits	Lighted
North Atlantic	SM412	1.8	0.6	2.3	6,10,12	4 bits,	Single Switch
	SM413	2.7	—	2.3	6,10,12	4 bits,	Assembly
	SM414	2.7	—	2.3	6,10,12	4 bits,	Sealed
Oak Manu- facturing	—	2.6	1.4	3.1	10,16,20	4 bits	Rocker- actuated
Tech Labo- ratories	B-6500	1.9	0.5	1.6	2-10	4 bits,	

*Nominal, excluding pigtails, extended cards, and mounting tabs.

Manufacturers' Units

Chicago Dynamic Industries, Chicago, Ill. — CDI's switches feature open type construction (see Fig. 12) in which the switch mechanism is not enclosed in a box. Advantages of this approach include easy adaptation to multiple-deck or extra-width construction (up to

10 decks driven by one rotor, or sufficient space on the rotor for words as well as numbers). The manufacturer also finds this construction helps avoid trapping moisture and contaminants in the circuit area. Switches are available with 8, 10, 12, or 16 positions, direct or binary coded outputs. Certain switch types plug into connectors for quick replacement.

The Digitran Co., Pasadena, Cal.—“Digiswitch,” used by some engineers as a generic term for all thumbwheel switches, is actually a proprietary trade-name of The Digitran Co. Most Digiswitches are available with direct outputs, resistance decades, or digital codes ranging from binary and BCD to Berkeley and others. The Series 300 is most commonly used in industrial applications; the sealed Series 400 for severe environmental conditions. The Series 500 (see Fig. 13) provides special output codes (including greater than, less than, equal to). The Series 600 offers up to 40 index positions. A smaller size series, called “Miniswitch,” is available either as the standard Series 700 or the sealed Series 200. Digiswitches are readily ganged into banks without special hardware.

Engineered Electronics Co., Santa Ana, Cal. — This company’s EECo-Switch Dept. offers internally-lighted switches in addition to the more conventional types, and special mounting hardware. The Series 100 is a militarized switch with 8, 10, or 12 positions, direct or coded outputs. The Series 300 and 400 feature internal lighting, and are sealed and unsealed, respectively. The Series 700 is a miniaturized, lighted, and sealed unit with 10 positions and limited coding, but with provision for diodes. The Series 800 is the Series 700, unsealed. A recently announced Series 200 (Fig. 14) features removable individual switch modules.

North Atlantic Industries, Inc., Plainview, N.Y. — This company offers one basic switch series in three forms. The SM-412 series (Fig. 15) consists of single switch units with 6, 10, or 12 positions and either direct or coded outputs. Codes include 1248 and 1224, with or without complements. An advertised feature of the switch is its coin-silver contacts.

When individual SM-412 switches are assembled into complete banks to customer specifications and with mounting hardware, they become the SM-413 series. Sealed, for military or adverse industrial applications, they are termed the SM-414 series.

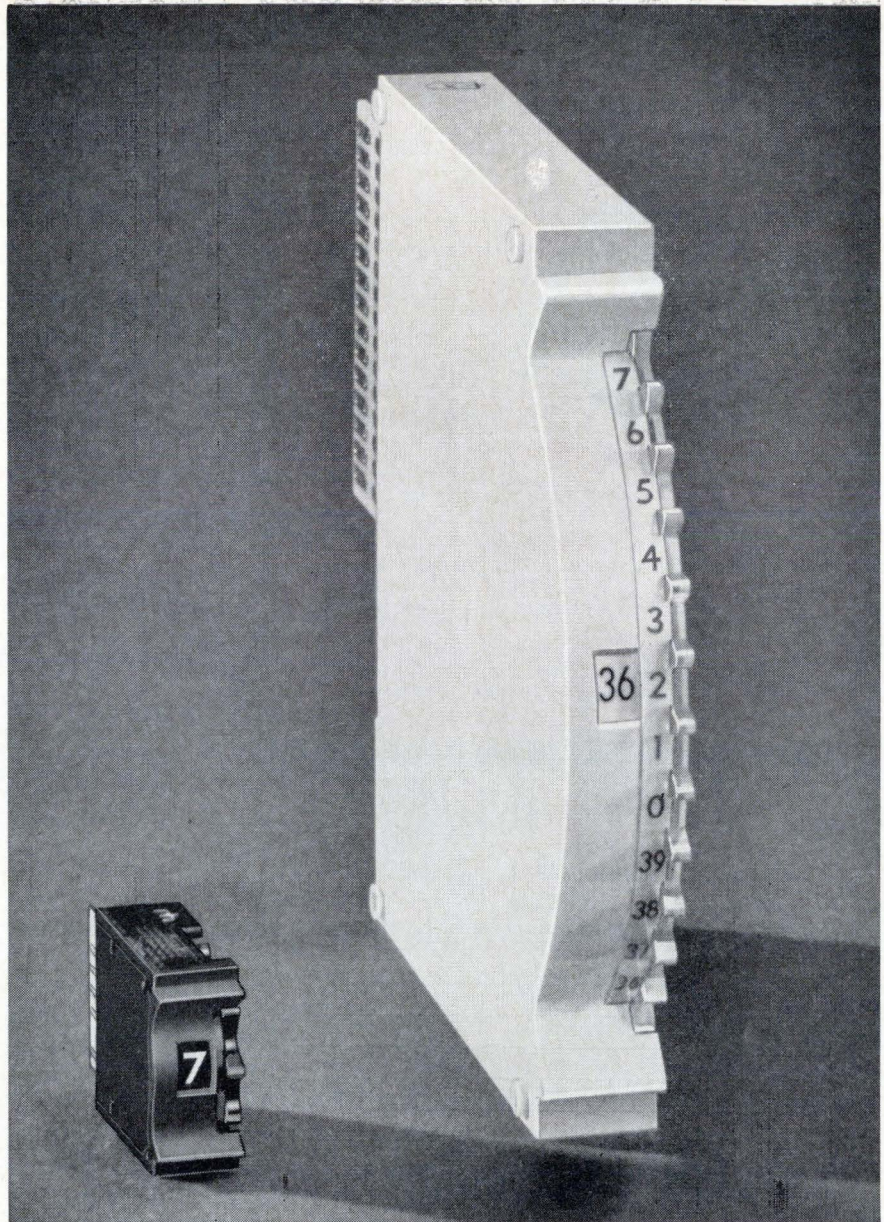

DIGISWITCH® THUMBWHEEL SWITCHES VARY IN SIZE BUT NEVER IN QUALITY

High standards of quality in the materials, construction and design of DIGISWITCH promote reliable, trouble-free performance, long life and excellent appearance.

DIGISWITCH Thumbwheel Switches are available in six (6) different series offering the engineer maximum **design flexibility**. All are panel space savers — modular constructed for simple, inexpensive mounting—human engi-

neered to increase operator efficiency —and offer extensive coded electrical output capabilities.

Shown above (actual size), are MINISWITCH*— the smallest thumbwheel switch on the market, and the unique rapid-setting 40-position Series 600 DIGISWITCH.

For a catalog on our complete line of DIGISWITCH and MINISWITCH Series, write to:

*Trademark

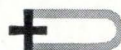

THE DIGITRAN COMPANY

A Division of Endevco Corporation

855 South Arroyo Parkway, Pasadena, California

Phone: 213/449-3110

MANUFACTURED UNDER PATENTS 3,089,923 AND D188,724. OTHER PATENTS PENDING.

CIRCLE NO. 25 ON INQUIRY CARD

NOW! NAVCOR 1050 CUSTOMIZED KEYBOARDS



Tired of searching for the right keyboard to fit your requirements? 1050 Keyboards solve that problem with unsurpassed flexibility.

Need numeric or alphanumeric layout, special key arrangements, rack mounting or table top housing? They're all available in the 1050 Series, along with a choice of switch closure or pulse outputs, diode matrix plug-ins that provide any coded output up to 15 bits, and a variety of special output options.

So stop searching! Send the coupon—we'll tell you all about the 1050 Series and KM Keys.

NAVCOR®

Valley Forge Industrial Park
Norristown, Pennsylvania



I'M INTERESTED! Please send me technical data and prices on your 1050 Keyboards and KM Keys.

Name _____
Title _____
Company _____
Address _____
City _____
State _____ Zip _____

Dept. CD-012

NEW! magnetic keys for your keyboard

Reader Service #11

PAT. PEND.



Here's the key that outdates ordinary switches. Magnetically actuated, with minimum bounce, these switches are sealed in glass for environmental immunity. Life expectancy? Up to 100 million operations. And the magnetic hysteresis band prevents make/break microphonics.

They're available with switch closure or pulse outputs, standard or special letters, numerals and symbols, and require no special installation tools. You'll save time, cost and headaches with KM Keys. Send coupon for details.

NAVIGATION COMPUTER CORPORATION

Valley Forge Industrial Park • Norristown, Pennsylvania
Dept. CD-012 • TWX 215-666-0729 • Phone 215-666-6531

TABLE 5 • MANUFACTURERS' LITERATURE

For your product reference file, a complete set of manufacturers' literature can be obtained by circling the reader inquiry numbers listed below.

INQUIRY CARD NO.

INPUT TYPEWRITERS

CONNECTICUT TECHNICAL CORP., Hartford, Conn.	70
FRIDEN, INC., San Leandro, Cal.	71
INVAC CORP., Waltham, Mass.	72
SOROBAN ENGINEERING, INC., Melbourne, Fla.	73

INPUT KEYBOARDS

BURROUGHS CORP., Pasadena, Cal.	74
CONNECTICUT TECHNICAL CORP., Hartford, Conn.	75
INVAC CORP., Waltham, Mass.	76
NAVIGATION COMPUTER CORP., Norristown, Pa.	77
SOROBAN ENGINEERING, INC., Melbourne, Fla.	78
TELETYPE CORP., Skokie, Ill.	79
ULTRONIC SYSTEMS CORP., Pennsauken, N.J.	80

THUMBWHEEL SWITCHES

CHICAGO DYNAMIC INDUSTRIES, INC., Chicago, Ill.	81
DIGITRAN CO., Pasadena, Cal.	82
ENGINEERED ELECTRONICS CO., Santa Ana, Cal.	83
NORTH ATLANTIC INDUSTRIES, INC., Plainview, N.Y.	84
OAK MANUFACTURING CO., Crystal Lake, Ill.	85
TECH LABORATORIES, INC., Palisades Park, N.J.	86

Oak Manufacturing Co., Crystal Lake, Ill. — Oak, producers of pushbutton and rotary switches, uses a novel technique in the design of their thumbwheel switches. Instead of direct thumb-turning of the rotor by means of its projecting tabs, the Oak switch has a rocker (Fig. 16) which is pressed up or down to move the rotor one position either way — an advantage when the operator is wearing bulky gloves. Each switch position has a firm and positive mechanical-index feeling. Available in either 10 or 20 position types, the switches offer direct or coded outputs. Codes include 1248-excess 3 and biquinary.

Tech Laboratories, Inc., Palisades Park, N. J. — This company's B-6500 miniature thumbwheel switch is made to mount either in front or behind the panel. Various combinations of BCD outputs are available with or without complements. Decimal and binary outputs with either 1 or 2 poles are also offered. The company also makes a larger model, the B-5575, which handles more current and is rugged enough for operation in steel mills and similar production applications.

Summary

We conclude this survey with a brief reminder that the manufacturers' units mentioned were just examples of each company's capabilities. For a complete reference file, we recommend that the reader supplement this survey with a set of company brochures and technical data sheets. The list of manufacturers in Table 5 is keyed with reader inquiry card numbers for your convenience in requesting this material. **END**

This is the Bryant PhD-170 drum. It carries on four communications at the same time. That's 4-channel simultaneity and it's something new—not just for a Bryant system, but for any peripheral random storage equipment. Simultaneous random read-write access is the way we describe it. Any channel has access to 21 million bytes stored on its 2,752 tracks. These exclusive features allow you to increase your up-time and lower your costs. The PhD-170 is already finding applications in banking, brokerage, reservation handling and actuarial circles, to mention just a few. For more information write for brochure #BCPB 109-5-65. Deliveries of the PhD-170 begin first quarter, 1966.

BRYANT

COMPUTER PRODUCTS

A Division of EX-CELL-O Corporation

850 Ladd Road • Walled Lake, Michigan 48088

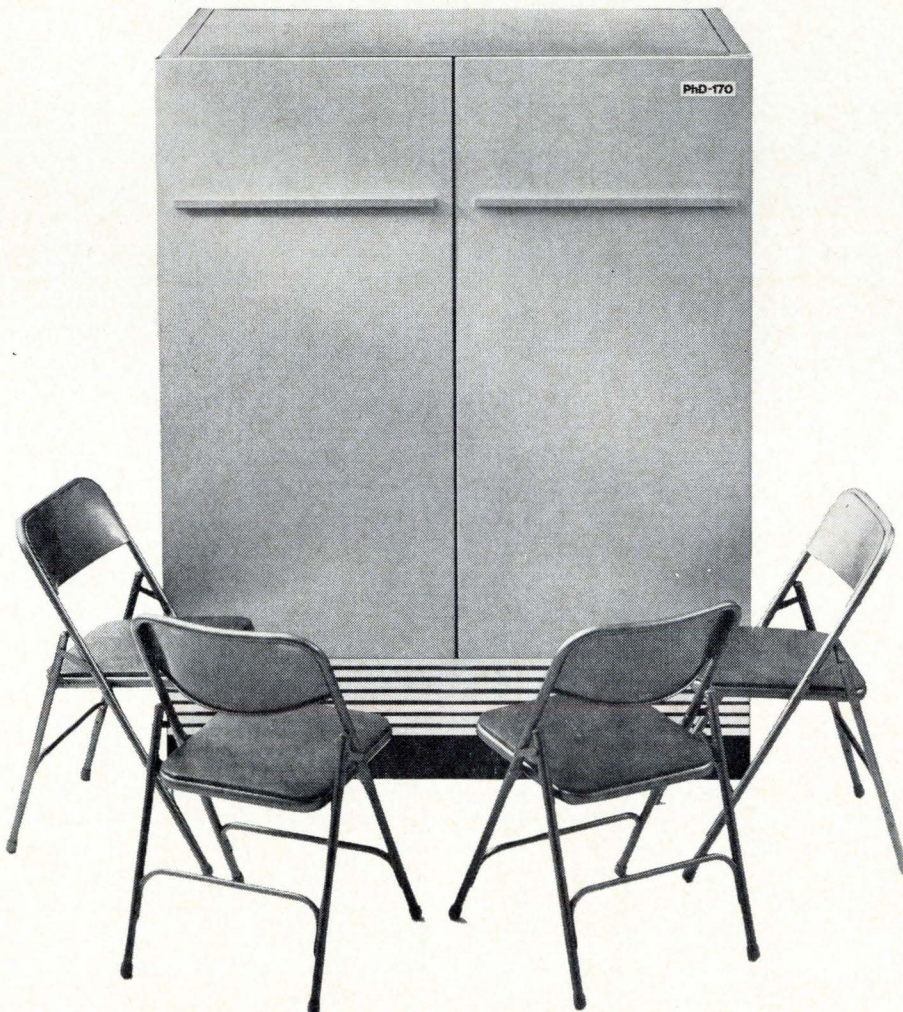

CIRCLE NO. 26 ON INQUIRY CARD

JOSEPH POPOLO

Mgr., Computer Products
Computer Control Co.,
Framingham, Mass.

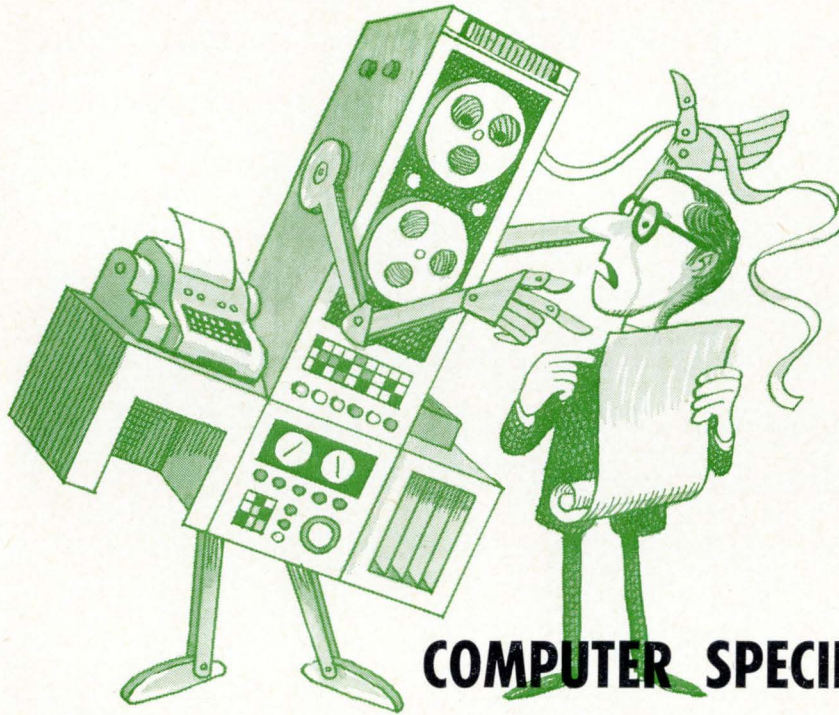

COMPUTER SPECIFICATION GUIDELINE

Computer purchasing can often become as great a problem as the one the computer is supposed to solve. Directed primarily to users of computers for engineering and scientific applications, this specification aid is based on the author's several years of experience both in writing computer specs and responding to them.

An enthusiastic program for obtaining a new computer often turns into a nightmare when the details of writing a procurement specification become a reality. It certainly needn't be a drudgery. In fact, it is the most important and critical aspect in the lifetime of living with a computer. Like the architect, a mistake at this point can lead, literally, to a monument of a monster computer system. Quite often, the user personnel provides too little or inaccurate information to their Purchasing or Procurement Department with the result that a lower cost but, unfortunately, an inadequate computer was the result after the bidding was over. Only a little care need be exercised, with adherence to a few basic rules, in order to write a good comprehensive specification.

Generally, the user hopes prospective bidders will demonstrate in detail the capabilities of their equipment. On the surface, this appears to be of prime importance, and manufacturers don't have to be prodded to do this. However, the most important part of the specification is to determine which computers will provide the necessary capability to handle the desired application. In practically all cases, the user will enter the actual procurement cycle with one or possibly two

favorite computers over all of those offered to him. The specification and its response should do two things. First, it should provide an opportunity for the manufacturer to respond in writing with the actual performance characteristics of the proposed computer and demonstrate those specific features which the bidder feels will do the job adequately. Secondly, it should uncover features the customer may be paying for which either are inadequate or unusable for the desired system.

Loose or Tight Specs

The case for a loose or tight specification has long been argued. It usually evolves from the stringency of the policies of the Procuring Department or Agency. Depending on the rules laid down by Purchasing, the user must be able to assure himself he will make the decision from the facts presented in the proposal from the manufacturers. In some companies, the tail wags the dog and the user is stuck with a computer selected by people interested only in best price. Quite often, a low bidder, although not necessarily with the most desirable machine, will be forced upon the user by the

Purchasing Department merely on the basis that the proposal takes few or no exceptions to the specifications. Laboratories and computer facilities today are loaded with this kind of equipment because of this hard and fast rule. To prevent this, the specification should define all the major features desired. Even though every bidder must take some exceptions, this permits the user to decide on the basis of the arguments presented which features he can justify waiving. On his judgment alone can these deviations be evaluated.

The guideline for writing such a specification in Table 1 has been put together based on several years' experience both in writing specifications and responding to them. Hopefully, it will provide the reader with a start for writing a clean, comprehensive, and informative specification. Specifications with nebulous phrases or sentences leave tortuous doubt in the minds of the bidders, and attempts to satisfy intended meaning leads only to confusion and inadequate responses. Areas where hard fast rules should be applied and other areas where judgment of manufacturer is requested are pointed out. In the latter case, it should be fairly obvious to a bidder by a direct statement to that effect.

The sample used typifies such a specification. It describes a medium size general-purpose scientific computer. More often than not, it is only a portion, but a significant part of a much larger system.

Statement of Application

A statement should be initially made regarding the intended use of the computer. This will alert the bidder to describe those options and features which are pertinent to the particular application throughout the remaining specification. This statement need not be more than one or two sentences. This will also be an aid in eliminating descriptive features which would only increase the verbiage and not add to the responsiveness of the proposal. As shown in Table 1, this might be considered the introduction.

Data Organization

Practically all computers procured in these small and medium size scientific ranges today are parallel machines, but as a holdover from the past, a specification may still include a statement on parallel transfers. Next, a statement regarding the desired word length and the type of internal binary representation which will be most desirable is required. In most cases, the word length is specified within certain limits which will provide the user with the computational accuracy he desires. If the user feels that double word operation with words of a shorter length will be adequate, he should indicate this, and not leave it to the judgment of the bidder. Otherwise, machines with a shorter word length will not be bid. If the bidder has a preference in regard to internal representation of data, such as sign magnitude or one or two's complement, he should so state.

Memory

In the area of memory specifications, there are four considerations. In addition to the memory size and speed, the maximum addressable memory and the maximum memory expansion possible should be determined. The listing in Table 1 indicates a typical specification which requests this information.

Processor Features

The processor including the arithmetic unit should be described so that the manipulation and addressability of registers are evident. Also found in this section are indexing requirements, instruction capabilities, and other processor features.

It is necessary for the user to know what additional time will be required for each instruction when it is indexed. In machines that use memory locations as pseudo index registers, an additional memory cycle time is required to index any instruction. However, computers with separate flip-flop hardware index registers are designed to permit indexing without any increase in execution time of an instruction. This is important since any speed advantage of one machine over another may be lost if indexing is to be employed extensively. A minimum instruction repertoire should be requested.

The number of levels of indirect addressing are also important from a programming consideration. The user should request from the manufacturer the number of levels of indirect addressing that are possible, and whether indexing is possible with each step.

A certain number of minimum processor features are usually required. This should be so stated and defined. Four specs — shift operations, memory incrementing, floating point operations, and binary-to-BCD conversion — in Table 1 were taken from a typical specification and are defined as explicit user requirements.

Input/Output

There is a variety of input/output channels that are provided by the manufacturers. The user should state his needs using the following guidelines: the number of separate channels required, the number of bits to be transferred either in a buffered or unbuffered condition, the rate, the expansion of channels possible, and the device interface characteristic. The latter is important if the equipment is customer furnished and non-standard to the manufacturer. For peripheral devices such as card or paper tape equipment, let the manufacturer recommend the type of channel required. In most cases, his standard software will be written for

Accuracy control, usually in the form of parity checking, is a feature whose value is often debated. If the user wishes to specify its use, the type of statement in 2.4.2 of Table 1 is helpful.

In computer applications other than the free standing data processing scientific use, discrete input lines and discrete output lines are employed. The user

TABLE 1 — SPECIFICATION GUIDELINE

1. Introduction — This specification covers the requirements of the general purpose computer. The computer will be the heart of the system. It will be used in an on-line, real-time application as well as for part-time, open-shop computation.

2. Computer Requirements

2.1 General Description

2.1.1 Parallel Logic — The digital computer shall be a parallel machine, i.e., all bits for data words shall be transferred within the computer in parallel.

2.1.2 Word Length — A computer shall have a word length of () bits. Internal numeric representation shall be stated in the proposal. Preference shall be given to the computer with the simplest scheme from the user viewpoint.

2.2 Memory

2.2.1 Memory Type — The computer memory shall be designed with magnetic cores as a basic storage element. All bits of each word must be injected, stored and extracted in parallel.

2.2.2 Memory Speed — Memory shall have a cycle time no more than () microseconds.

2.2.3 Memory Size — The memory provided with a computer shall provide storage for () words. The size of memory modules available shall be stated.

2.2.4 Memory Addressability — The maximum number of words directly addressable by one instruction shall also be stated.

2.2.5 Memory Expansion — It shall be possible to expand memory in increments of () modules to a maximum of () words, of which () words must be directly addressable.

2.3 Arithmetic Unit — The computer shall have a minimum of two registers (exclusive of any index registers) which can be manipulated under program control. Both registers shall be addressable. Preference will be given to the computer which provides the most flexible control.

2.3.1 Index Registers — The computer shall be provided with at least one index register with the capability of adding a minimum of two or more such index registers. Effective address formation of indexed instructions which increase the execution time of that instruction shall be stated.

2.3.2 Instruction Repertoire — The basic instruction repertoire of the computer shall include a minimum of 50-60 commands. These commands shall include but not be limited to the following: Loading of registers, storing of registers, arithmetic operations (all arithmetic op-codes should be delineated), logical operations, shift operations, jump operations, index register operations, input/output operations and other miscellaneous codes such as loading and storing of input/output channels, status and control operations.

2.3.3 Instruction Execution Times — The instruction execution times of the following instructions, considered to be indicative of the general speed characteristics of the computer, shall not be in excess of the times so indicated.

INSTRUCTION	MAXIMUM EXECUTION TIME IN MICROSECONDS
ADD	()
MULTIPLY	()
DIVIDE	()
LOAD ACCUMULATOR	()
LOAD INDEX REGISTER	()

2.3.4 Indirect Addressing — Successive (multi-level) indirect addressing with indexing at each step shall be provided with the basic computer. A minimum of two levels is required.

2.3.5 Shift Operations — It shall be possible to shift by means of a single instruction; one of the two arithmetic units by itself, or two, both of the arithmetic registers together. Shifting shall be possible both to the left and to the right. Shift instruction must be able to shift up to two full word lengths. Preference will be given to the computer with the most flexible shift instructions.

2.3.6 Memory Incrementing — It shall be possible to increment the contents of a memory location by single instruction. The time required for this instruction shall be stated.

2.3.7 Floating Point Operations — Floating point hardware which permits the loading and storing, addition, subtraction, multiplication and division, each accomplished by single instructions shall be provided as an option. Floating point numbers shall be expressed with a minimum of 24 bits including sign with a mantissa and 9 bits for the characteristics. If this feature is not available as hardware, software to be provided shall be described in detail, including execution time.

2.3.8 Binary to BCD Conversion — Hardware to perform a BCD to Binary and Binary to BCD conversion each with a single instruction shall be provided as an option. If it's not available in processor hardware, software to be provided shall be described in detail.

2.4 Input/Output

2.4.1 Basic input/output channels — The basic computer shall be provided with the capability of transferring data through a () bit parallel word channel. The maximum number of input/output channels shall be so stated. The devices shall have a minimum data rate of () words (characters) per sec. The attached diagram indicates the voltage and timing characteristics of the interface device(s). The time required to set up and execute an I/O operation both for one word or block data shall be stated.

2.4.2 Parity — Parity checking shall be provided on all input channels. Parity generation shall be provided on all output channels.

2.4.3 Single Word Transfer — It shall be possible to transfer single words directly to and from memory by means of a single instruction. The time required for each operation shall not exceed () microseconds.

2.4.4 Single Word Transfer to and from the Arithmetic Unit — It shall be possible to transfer words directly to or from one or more of the registers in the arithmetic unit. The time required for each operation shall not exceed () microseconds.

2.4.5 Output Control Lines — The computer shall be provided with a minimum of () output control lines. These lines shall be capable of being activated by a single command instruction within () microseconds. Lines may be either the pulse or dc level, in which case the signal characteristics of the level shall be provided. The maximum possible expansion of these lines shall also be stated.

2.4.6 Single Line Input — The computer shall be provided with a minimum of () discrete sense lines to enable detection of conditions external to the computer. The maximum possible expansion of these lines in the computer shall be stated.

2.4.7 Interrupt System — The basic computer shall be provided with interrupt lines. The following features shall be provided.

2.4.7.1 A Stacking-Priority system — shall be provided. When the computer interrupts, it shall be automatically possible for the program to jump to a unique memory location or locations from which the user subroutine can be implemented to service the interrupt. The means for returning to the main program shall be stated. The computer shall supply an acknowledge line for each interrupt in order to notify the external device that the interrupt is being serviced. The characteristics of the interrupt and the acknowledge lines shall be specified. When several interrupts occur, a pre-assigned priority shall service the highest priority first and then the next lower priority, etc. The maximum number of lines possible shall be stated.

TABLE 1 — Specification Guideline (cont'd.)

2.4.7.2 Interrupt of Interrupt Priority — A priority interrupt system shall be provided. With this option, the computer shall be automatically interrupted and the program transferred to a unique memory location or locations from which a user subroutine can be implemented to service the interrupt. The means should be provided for a simple return to the main program at the completion of the subroutine. Acknowledge line should be provided for each interrupt in order to notify the external device that the interrupt is being serviced. If a higher priority interrupt occurs while a lower priority interrupt routine is in process, then the lower priority interrupt shall be interrupted and the next higher priority serviced. The maximum number of lines for possible expansion shall be stated.

2.4.7.3 Single Instruction Interrupt — A priority interrupt system shall be provided. When the computer is interrupted, the program automatically shall execute a unique instruction to associate with that particular line. An acknowledge line shall be provided for each interrupt in order to notify the external device that the interrupt has been serviced. If two more interrupts occur simultaneously, the one with the higher priority assigned to it shall be serviced first and the next lower priority, etc. Characteristics of the interrupt line, the signal for the interrupt and acknowledge lines shall be so stated. The maximum number of lines for possible expansion shall be stated.

2.5 Peripheral Equipment — The following equipment shall be provided with the basic computer:

The manufacturer and model number of each unit supplied shall be stated in the proposal.

2.5.1 Paper Tape Reader shall read a minimum of () characters per second.

2.5.2 Paper Tape Punch shall punch paper tape at a minimum rate of () characters per second. (The code used through both the reader and punch shall be stated.)

2.5.3 Typewriter (teletype) which operates at a rate of () characters per second shall be provided.

2.5.4 Line Printer — A line printer of () columns and () lines-per-minute shall be provided.

2.5.5 Magnetic Tape Units — () magnetic tape units, and IBM compatible tape controller shall be provided. The speed of () inches-per-second with densities of () and () bpi shall be provided.

2.5.6 Card Reader — A () card-per-minute reader shall be provided and it shall read both binary and Hollerith cards.

2.5.7 Card Punch — A () card-per-minute card punch shall be provided. It shall punch both binary and Hollerith cards.

3. Operational Aids

3.1 Control Panel — a control panel and/or console shall be provided for manual operations of the computer. The control features shall include, but shall not be limited to the following:

1. A display for each of the following:
 - a. The contents of () of the registers in the arithmetic unit;
 - b. The contents of index registers provided with the computer;
 - c. The contents of the program counter (register which indicates the current instruction being executed).
 (The contents of the above mentioned registers must be alterable from the panel via illuminated push-button switches.)

(The contents of the above mentioned registers must be alterable from the panel via illuminated push-button switches.)

2. At least () sense switches, which may be tested under program control.

3. Switches to control the paper tape reader, paper tape punch, and typewriter. By means of these switches it shall be possible to set individually the above mentioned equipment into either an on-line or off-line mode of operation.

4. Switches to permit the program to run to a given location and halt.
5. Overflow indicators for fixed and/or floating point operations.

3.2 Maintenance Panel — A maintenance panel to assist maintenance personnel in trouble-shooting the computer shall be provided. Features of the panel shall include but shall not be limited to the following:

1. An indication of the connection status of each of the input and output channels.
2. The means to turn off the computer clock.
3. The means to step through operations internal to the computer one clock pulse at a time, as well as, one instruction at a time.

4. Software — A comprehensive, well documented software package which is currently operational and can be used with the proposed computer system shall be demonstrated as a condition for acceptable delivery of the computer system. The minimum requirements of this package are outlined below.

4.1 Symbolic Assembly Program — The symbolic assembly program, with optional fixed or relocatable binary output, shall accept programs using mnemonic operation codes, macro-instructions, and assembly control commands and shall produce a program in machine language. A sample of macro-instruction usage is desired.

4.2 Fortran II Compiler — A Fortran II compiler which produces a relocatable binary object program compatible with the real-time operation of the computer shall be provided. Features of the compiler shall be (1) magnetic tape statements, (2) complete formatting capability, (3) source language error detection, and (4) Boolean algebra capability. Other capabilities which are standard should be stated.

4.3 Mathematical Subroutines — A complete set of mathematical subroutines including floating point subroutines, double precision subroutines, a square root subroutine, and trigonometric, logarithm, and exponential subroutines shall be provided.

4.4 Utility Routines — These routines, provided with the computer, shall be a complete set of utility routines to facilitate loading, dumping memory, listing, editing, duplicating, and converting between various input media.

4.5 Diagnostic Routines — These routines, supplied with the computer, shall be a set of diagnostic routines to check the computer memory, all internal instructions, the input/output channels, and the interrupt system. The routines shall be used as an aid to tracing failures and defective elements in the computer. The level of diagnostic capability shall be stated.

5. Support Services

5.1 Training — The duration and content of separate programming and maintenance courses, if available, should be described. The date, number of attendees, and location of this training shall be indicated.

5.2 Programming — The programming analysis which shall be provided as a result of this contract should be indicated.

5.3 Documentation — The quantity and title of all manuals, drawings, and associated documents to be supplied as a result of this contract shall be stated.

5.4 Free Computer Time — The number of hours of free computer time and the nearest available computer site shall be stated.

5.5 Maintenance — The manufacturer should describe the maintenance plan offered with the system, covering rates and response time.

should request detailed description of how these lines operate. Signals as levels or pulses may be available. The type of signal and how a control line is used under program control should be stated.

Also in the input/output area, the scientific user requires, in most cases, an interrupt system. Manufacturers today offer a variety of interrupts (some manufacturers offer three different types in which two may be mixed as a standard feature). If it is clear in the mind of the user which type is best for his application, he should state it. Otherwise, request those available, the capabilities of each, and how they may be applied to the user's particular problem in the system. Three typical interrupt systems are described in Table 1.

High Rate Channels

If particular devices or peripheral units are expected to operate on a time-shared or simultaneous basis with the computer, the specification should request a detailed description on the operating characteristics of the channel or channels available. Specifications should also request the transfer rates possible in each of the options and the conditions under which the maximum transfer rates can be obtained. Because of these limitations, manufacturers will attempt to respond to the spec only by stating operations up to the maximum rate, and will not indicate that certain operating conditions of the processor are required to obtain this maximum rate. A statement such as "pure simultaneous input/output and processor computations are necessary" should be included if it is desired. Otherwise, limited and less attractive features may be suggested for the purposes of a lower bid cost, while not adequately performing the function. An example should be requested for the coding necessary to set up the channel and operate it. Explicit times for each instruction should be indicated.

Peripheral Equipment

The customer should state the exact number of peripheral devices and general operating characteristics of peripheral equipment. Small and medium size manufacturers do not build all of their own peripheral equipment, but rather offer a variety of devices from other manufacturers. The decision of the manufacturer to accept one line printer, for example, over another has been based on his verification of device capability and the ease of interfacing with their equipment. If at all possible, the suggested peripheral equipment provided should satisfy the main requirement of data rate. Another consideration is the ability of the manufacturer to provide back up in the area of maintenance service.

As an example, the peripheral devices listed in Table 1 should only be specified as to operating performance. However, the manufacturer and model number of each unit should be requested, but not specified.

Since tape units are character devices, several manufacturers offer a word or character forming device which permits tape operations to be handled on ordinary parallel word channels rather than character channels. Likewise, the number of characters per word

and the ability to change the packing of characters per word may also be desirable, and should be so stated.

The ability to operate certain of these devices both on and off line may be desirable. It should be stated which devices can operate in this mode.

For other special equipment such as X-Y plotters, oscilloscopes, disc or drums, etc., it should be remembered that these units may not be standard and are included as specially-priced units, only to be responsive. This means the company may not have the software to operate with this unit, or the price to develop it may be hidden in this special price.

Operating Controls

Ease of operation is an important consideration, and the aids for maintenance and trouble shooting should be noted. The sections in Table 1 under Operational Aids depict some of the more desirable features.

Software

The minimum requirements for software usually consist of a symbolic assembly program, a compiler, and a well-rounded library of sub-routines. In the early computer era, many computers were delivered without the accompanying software. This situation still occurs today and to guard against it, the user may find it necessary to require demonstration of all proposed software as a condition for delivery acceptance.

Some manufacturers will advertise most elaborate software packages but the minimum configuration for running it (e.g., magnetic tape, card reader, etc.) may not be the configuration to be purchased. Therefore, the software descriptions in the proposal should state if it will run on the proposed system.

Utility and debug routines vary in capability and should be explained in detail. Execution times for one or two typical math routines may be requested. Their relative efficiency can be compared if the routines' accuracies are specified.

The submission of benchmark problems is a growing trend. Most always in FORTRAN, a few errors will disclose the diagnostic capability of the particular version. The compilation efficiency can also be examined.

The software specification in Table 1 is typical of a broad software requirement.

Support Services

Manufacturers vary greatly in the depth and extent of back up support for customers although they all claim the best. These usually cover training (both programming and maintenance), programming analysis, documentation, and free computer time. The latter is imperative if the system is expected to operate as soon as possible after the hardware delivery. This specification should request the magnitude of the services provided.

Miscellaneous Specs

As a miscellaneous category which wraps up the computer specification, one can lump anything into it from power consumption to reliability statistics. Require-

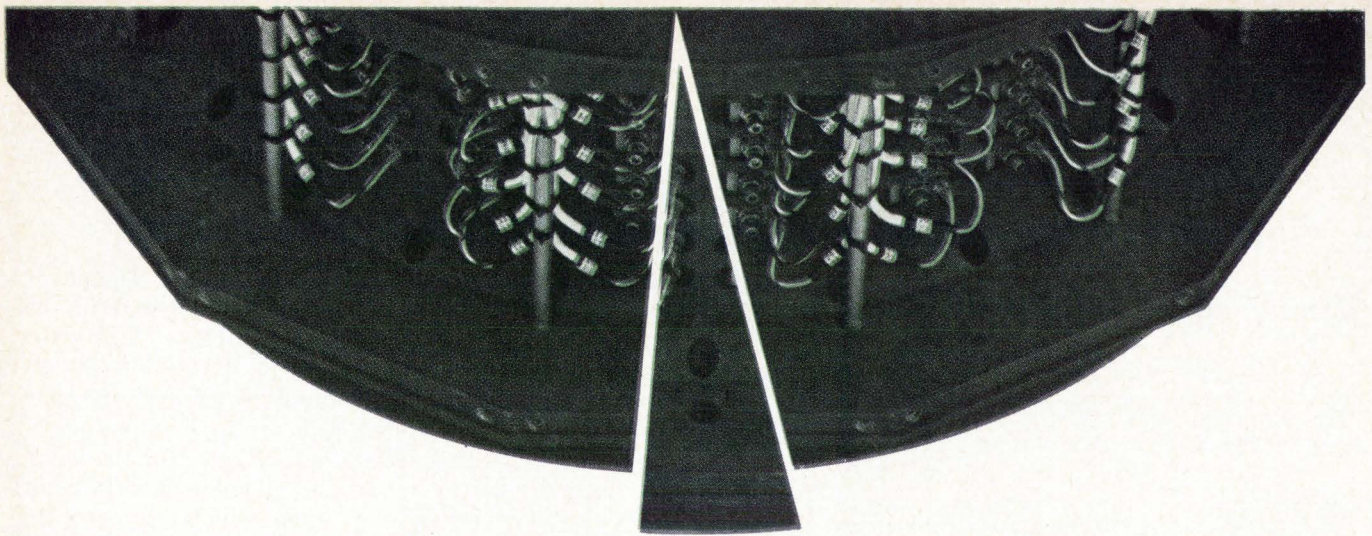

“< 1 BIT IN 10¹²?”

Where else can you find this remarkably low transient error rate, Single Bit Alteration Phase Modulation Recording, and Less than 3 Microseconds Write-to-Read Recovery time – all at one megacycle data rate? At Magne-Head, these are standard features—not extra-cost “options.” Comparison is the key to your best buy. For Magnetic Drum Memory Systems—designed...engineered ...and manufactured to your exact requirements, contact Magne-Head today.



MAGNE-HEAD *a division of General Instrument Corp.*

13040 South Cerise Avenue • Hawthorne, California 90250
213 679-3377 / 772-2351 • TWX 910-325-6203
CIRCLE NO. 27 ON INQUIRY CARD

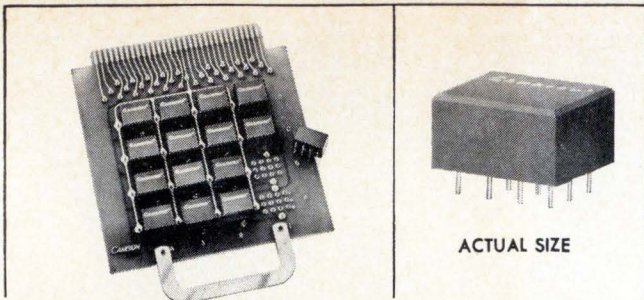

Block out your logic problems

Use CAMBION® Digital Logic Modules. They are available complete with mounting hardware in three new lines: 10 MC and 100 KC germanium plus 2 MC silicon. Featuring standard 12 pin grid configurations and produced with standard pin connections on logic and power points, these building block digital logic modules provide total intercompatibility for simple and mixed logic circuits.

With CAMBION Cambi-Cards, you have the most versatile mounting hardware for any logic circuit. Logic types of all three CAMBION Digital Module lines can be intermixed on each Cambi-Card. To guarantee insertion of proper card into chassis, each card can be key-coded by slotting a specific finger of the connector contact area.

Get valuable assistance in logic circuits from CAMBION. Our application engineers want to help you design CAMBION Digital Modules into efficient, low cost systems for a variety of modern digital logic applications.

FREE! CAMBION Catalog 80 contains circuit diagrams and operating characteristics on 19 CAMBION Module families. Write for your copy today. Cambridge Thermionic Corporation, 413 Concord Avenue, Cambridge, Mass. 02138. (617) 876-2800.

CAMBION®

"DIAL-A-PART" SERVICE

Standardize on CAMBION...The Guaranteed Electronic Components

CIRCLE NO. 28 ON INQUIRY CARD

evenwolt™

complete voltage
reference units

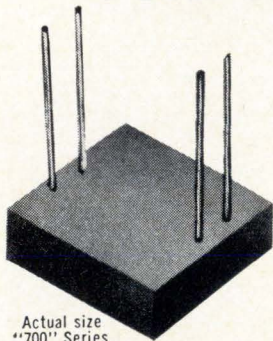

Actual size
"700" Series

in modular component size

small ■ printed circuit or chassis mounting ■ simplifies circuit design ■ no temperature compensation needed ■ low price—unlimited variations of voltages, current, temperature coefficient, regulation, output impedance, case and mounting.

(NOW!)

Line operated references
with 0.0001% regulation.
Write for spec. 200-15

For information—write, wire or phone

INSTRULAB, INC.

1205 LAMAR STREET
DAYTON, OHIO 45404

CIRCLE NO. 29 ON INQUIRY CARD

ments for heat, power, spare parts complement or special test equipment can be noted. If they may present unique problems as to how the system is to be used, or the environmental conditions under which it may operate, they definitely should be included.

Acceptance Tests

This is the most troublesome feature in any request for proposal. An ill-defined statement on the part of the user may leave the way open for trouble during the course of the procurement and run up unforeseen costs on the part of the manufacturer when delivery time rolls around. A statement such as "a mutually agreeable acceptance test" leaves the way open for the buyer to demand what he wants during test demonstrations. The manufacturer is more than willing to agree to any acceptance test if he knows what the labor and expense will be to provide a satisfactory demonstration ahead of time. And the proposal request is the place for it. If no special test is required, the manufacturer will probably run the acceptance test demonstration with his software, or usual diagnostic routines, to verify the system's operational status.

Summary

Obviously, the clearer the original specification the less reason for the manufacturer to deviate from the intended meaning. And the manufacturer prefers it that way since it will lead to the most realistic demonstration of how his equipment meets your requirements. **END**

GOVERNMENT REPORTS ★ ★

A 200-SECOND DIGITAL MAGNETIC CORE TIMER

A prototype model of a 200-second selectable digital magnetic core timer has been developed at Picatinny Arsenal. The timer, which is an efficient binary storage system, consists of a temperature-stabilized 1000-cycle L-C oscillator accurate to 0.1 percent, a magnetic-core counter in double line shift register mode, and a remote selection unit. Time delays from 1 to 200 seconds can be obtained with a setting resolution to 0.1 second. Maximum error is 0.1 percent of the time selected over an operating temperature range from -65 to 165F. Size of the timer package is projected to be less than 10 cubic inches while power consumption is less than 40 milliwatts with a power source of 5.6 volts plus or minus 10 percent. The count state of the system is defined by the direction of remanent magnetism in the magnetic cores and therefore is not altered by the loss or absence of power-supply voltage. Sufficient energy remains in the capacitors to complete any data transfer underway at the time of failure. The remote selection system eliminates the need for circuit power while the time delay is being selected. The time delay selected can be stored without standby power for an indefinite length of time because of magnetic storage.

Order from Clearinghouse, U. S. Dept. of Commerce, Springfield, Va. 22151. Order No. AD614564N. Price: \$2.00.



NEW BOOKS

DATA SMOOTHING AND PREDICTIONS

R. B. Blackman

This book presents a treatment in depth of the theoretical and practical aspects of finite-memory polynomial filters and predictions. The subject is approached from the transmission viewpoint which is familiar to most communications-oriented engineers. The text is of broad interest to engineers working in such fields as automatic control, missile guidance, and radar tracking.

The discussion begins with background material on linear invariant analog transmission networks, proceeds with development of optimum smoothing for polynomial predictions, discusses extensively the realization of practical digital equivalents to analog filters, and concludes with chapters on variable analog and discrete smoothing schemes and the measurement of power spectra.

The author of this book has had over twenty years experience with the problems about which he writes. The book was based on notes for a series of lectures which he delivered at the White Sands Proving Ground. Price: \$11.75. Order from:

Addison-Wesley Publishing Co., Reading, Mass.

INTRODUCTION TO NUMERICAL ANALYSIS

Carl-Erik Froberg

This book is intended to serve as a text for introductory courses in numerical analysis. It is additionally intended as a reference for people working on numerical problems. It stresses modern topics, particularly emphasizing subjects that have become important with the advent of electronic computers. Older techniques have been generally excluded. Matrix theory is included along with a detailed exposition of the application of matrix methods. Topics covered include "Interpolation", "Numerical Differentiation and Quadrature", "Difference, Ordinary, and Partial Differential Equations", "Approximations", "Monte Carlo Methods", and "Linear Programming" along with basic chapters on Numerical Computations, Equations, and Matrix Theory. Exercises are provided in each chapter along with a complete set of answers. Price: \$8.95. Order from:

Addison-Wesley Publishing Co., Reading, Mass.

Let's Talk....

BLUE CHIP

In a non-defense industry, The Foxboro Company, a firm that does things well, is expanding again in our conservative New England way (facilities and global activity). As a recognized leader in control systems and instruments for the chemical, petroleum, pulp and paper, power, pipeline, food and other process industries, the DIGITAL SYSTEMS DIVISION of The Foxboro Company now offers excellent career opportunities with rapid advancement in the fast-growing commercial technology of COMPUTER CONTROLLED PROCESSING. The demands of the future, and our means of preparing for them, are unmistakably clear. We are blue chip and proud of it. Consider your future carefully. We do. The areas listed below represent only a few of the many career openings available.

DIGITAL COMPUTER DESIGN ENGINEER

Minimum of 5 years' experience in design and development of digital computers, emphasizing real-time and I/O features. Computer design experience should be as a project leader with responsibility for decisions involving computer main frame logic design and machine organization, analysis and implementation of I/O data and control channels, and analysis and organization of computer instruction repertoire. Computer experience should be involved in high-speed memory systems (2 microseconds or better) and integrated circuit technology. Will be responsible for contributing to advance system design in digital computers as applied to industrial process control.

DIGITAL COMPUTER LOGICAL DESIGNER

Minimum of 5 years' experience in analysis and implementation of digital computer logic design. Should have acted as Senior Logical Designer on several computers involved in real-time and on-line computer applications. Should have had responsibility in definition and logical structure of instruction complement and information transfer. Will be responsible for contributing to advance system design in digital computers as applied to industrial process control.

SENIOR DEVELOPMENT ENGINEER DIGITAL CIRCUIT DESIGN

BSEE with 4-6 years' experience in circuit design of high-speed digital circuitry above 2 megacycles. Emphasis on integrated circuit design application. Should have background in noise, signal propagation and all logical element design problems. Proven ability to handle project efforts in circuit engineering. Contributes to system logic organization for analyzing optimum logic and circuit configurations.

SENIOR SYSTEMS ANALYST

Computer process control. Advanced ME or CE degree preferred. Must have 5-10 years' experience in chemical, refinery or power plant computer automation. Simulation and process modeling experience desirable.

SERVICE ENGINEER

Minimum 2 years' technical schooling in electronics and general purpose digital computer maintenance training. Experience in solid state computer systems — check-out, installation and on-site maintenance. Ability to troubleshoot digital portion of systems main frame as well as peripheral equipment. Minimum 3 months' training at our facility prior to field assignment.

Let's Talk. If you think you would like to grow with us, please forward your resume in confidence to:

J. G. Willett

Central Recruiting Office

THE FOXBORO COMPANY DIGITAL SYSTEMS DIVISION

12C Neponset Avenue
Foxboro, Massachusetts

FOXBORO
REGISTERED TRADEMARK

"Specialists in Process and Energy Control"

An Equal Opportunity Employer

CIRCLE NO. 902 ON INQUIRY CARD



NEW PRODUCTS

DRUM MEMORY SYSTEM

Adaptable to any computer with direct memory access, a new drum system stores up to 524,000 18-bit words. The system costs less than 10¢ per word, complete, in large capacity size. It is word addressable with 8.5msec average access time, and sequential words are available at a 17usec rate. Additional system features include phase modulation recording with internal parity generation and checking; high reliability silicon circuitry; and error rates proven less than 1 in 10^{11} . The entire system is contained in a 19" rack. Vermont Research Corp., North Springfield, Vt.

Circle No. 174 on Inquiry Card

INTEGRATED CIRCUIT TESTER

A highly flexible, high-speed instrument for fully automatic testing of integrated circuits and similar multiterminal devices has been put on the market. A number of programs, each containing all the tests required to check out the device under test, are stored in the disc memory of the tester, and allow go/no-go testing to be performed at a rate of 180 tests per second. The tester is said to be ideally suited for diverse applications such as production testing, final testing, receiving inspection, engineering evaluation, etc. Aircraft Armaments, Inc., Northridge, Cal.

Circle No. 183 on Inquiry Card

LINE PRINTERS

New line printers are available in speeds up to 40,000 characters per minute or 300 lines per minute. An 80 column unit can be obtained for mounting in a 19" rack. Two standard desk-top models accommodate up to 80 columns and 132 columns respectively. The mechanical section is said to be the smallest available in the field today. The electronic section uses a microelectronic circuit memory. The Series 300 printers include the same features used on the company's larger printers; such as a full set of hammers and two sets of tractors for paper stepping. The upper and lower tractors are driven together and are provided with a phasing control to adjust for proper paper tensioning. The printer uses a free flight hammer system to obtain clear printing with multiple forms without requiring critical adjustments. The printers use vertical ribbons of full paper width to provide long ribbon life. Datamark, Inc., Westbury, N. Y.

Circle No. 185 on Inquiry Card

DIRECT DIGITAL CONTROL

A direct digital controller system provides up to 99 loops of direct digital indicating control, computer capability for data formatting and logging, alarming, and convenient manual operation of all controls, readouts and adjustments. It was developed to meet the need for accurate and reliable process control using modern digital techniques with computer capability. The system provides convenience and efficiency of operation, accepts standard analog transmitter signals and supplies standard analog output signals for control of process. Also included are digital readout, selectable alarm limit and digital set points, which may be switched from a remote location. The controller system can include a stored program computer with the flexibility and rugged construction needed for industrial control work. 3M Co., Instru. Dept., Camarillo, Cal.

Circle No. 172 on Inquiry Card

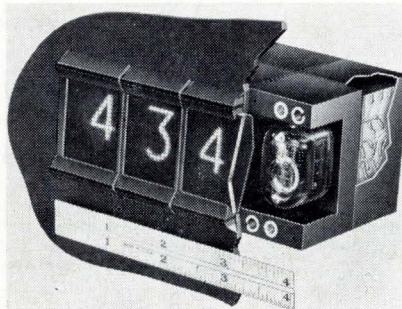

IC READOUT

New transistor-controlled readout operates directly from the output signal levels of many integrated circuit packages. Input impedances of the readouts are specified to allow calculation of fan-out and fan-in according to the integrated circuit manufacturer's specs. Available in three series, these readouts handle 8-wire or 4-wire BCD input. Ele-

ments of the rectangular neon readout tube are controlled by internal all-transistor decoder-driven circuitry that is said to eliminate diode decoders and reduce the number of semiconductor components by 60%. Because all readouts have self-contained transistorized drivers operating from low level signals — as low as 2 volts typically present in solid-state systems — the expense of relays or external drivers is said to be avoided. High voltage of 180 VDC required to fire the tube's numerals, is confined to the display panel eliminating the problems created when high voltage is carried into sensitive logic systems. Transistor Electronics Corp., Minneapolis, Minn.

Circle No. 196 on Inquiry Card

For more Data per Dollar use the **UNICOM**[®] Data Communications System by **INVAC**

If you have branch offices it will prove profitable for you to investigate the Unicom Data Communications System by Invac.

The Unicom System matches your present data load requirement to the capacity of both the Unicom and "Data-Phone" equipment for a completely compatible system with or without a central computer. When you consider the combined cost of original equipment and the monthly "Data-Phone" and "on-line" charges, you will discover that you can transmit and receive more data per dollar with Unicom by Invac than any other system on the market today! Another important consideration . . . you buy only what you need now . . . the system can be expanded

later as your needs demand.

Unicom is a fully integrated system with unsurpassed reliability. All control electronics and power supplies are included . . . just plug into any 60 cps 110 volt outlet. Tape Punches are guaranteed for 100,000,000 operations or six months without error or failure. Tape Readers can read any 5 to 8 hole tape at rates from 0 to 150 characters per second. Invac Transmitter/Receivers (8½" and 13" writing lines) can be operated by anyone who can use a typewriter. Unicom modules are designed for both serial and parallel simplex, half-duplex and full-duplex communications networks. Nationwide Service provided.

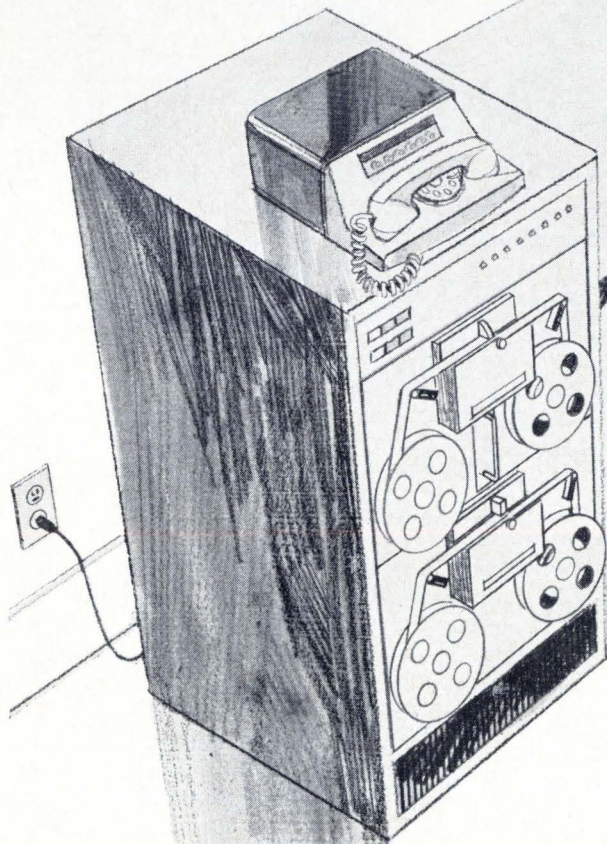
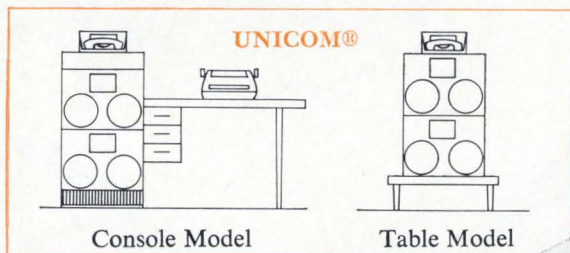

Write for the
Invac Unicom Brochure.

IT'S INVAC FOR ADVANCED PERIPHERAL EQUIPMENT



26 Fox Road, Waltham, Mass. 02154 Tel. (617) 899-2380

CIRCLE NO. 30 ON INQUIRY CARD

NEW PRODUCTS

FAST RISE TIME RESISTORS

Low inductance and low capacitance are two of the important features of a new series of precision wirewound resistors. The "RT" resistors can be supplied with rise times as low as 20 nanoseconds (from 10% to 90% of peak pulse amplitude with a 100 kc pulse input) and as low as 400 nanoseconds (0% to 100% peak pulse amplitude), depending on resistance values and physical configurations. In general, faster rise times can be obtained in the resistance range of 5k to 500k and in the smaller diameter configurations. Low inductance is created by a special winding technique while specially designed bobbins contribute to the lower capacitance. Standard axial lead types offer wattages ranging from 0.15 to 2.00 w in sizes from 1.87 diameter x 3.75 long to 0.500 diameter x 2.00 long. Radial lug types offer a wattage range from 0.50 to 2.50 in sizes from 0.500 diameter x 0.500 long to 1.00 diameter x 2.125 long. These resistors can be designed to fit most requirements in computing, data processing, process control and related systems. Kelvin, Van Nuys, Cal.

Circle No. 155 on Inquiry Card

HIGH DENSITY MAG TAPE

New heavy-duty computer tape is compatible with new IBM 2400 Series magnetic tape units which record and read data at 1600 bits per inch. It is also compatible with present half-inch tape drives. Development of a new testing technique was a primary requirement for this tape since the phase encoding method of recording at 3200 flux changes per inch calls for a more critical test covering the complete surface of the tape. Mac Panel Co., High Point, N.C.

Circle No. 133 on Inquiry Card

PORTABLE ANALOG COMPUTER

New solid state analog computer is said to add a new dimension to portable analog computation. Features include a unique removable problem board, $\pm 0.01\%$ component accuracy, complete short circuit protection, and full iterative flexibility. Designed for expansion to 20 amplifiers, the design permits full trade-in to a larger computer series for expansion to 84 amplifiers. Unit also

has built in digital logic, electronic mode control, trunk lines, and slaving capability for possible hybrid operations. The removable problem board has visual computer circuits that enable new operators or students to learn analog computer programming directly from textbook diagrams. A twelve amplifier computer starts as low as \$7,300. Computer Div., Systron-Donner Corp. Concord, Cal.

Circle No. 159 on Inquiry Card

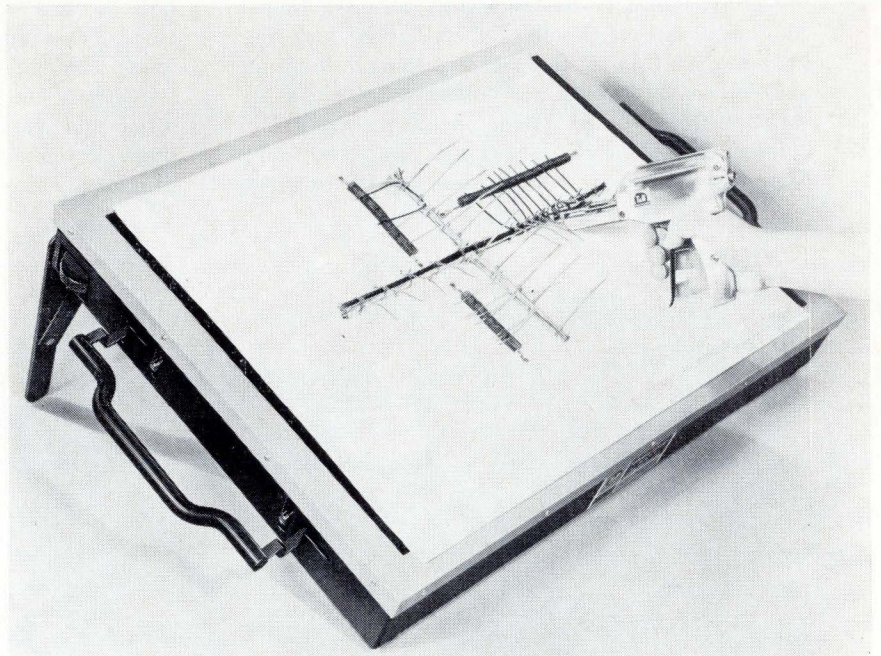

HARNESS FABRICATION BOARD

Completely replacing conventional harness boards and their methods an entirely new harness fabrication technique, is based on a new "pop-up" harness board, a result of almost 8 years of study of the harnessing operation. The new board has been designed to improve the costs and methods of harness tying and to overcome the difficulties arising from "what do you do with the board once the harness has been made." The board is a device consisting of a perforated aluminum work surface below which is located a movable panel to which the pins are fastened. In the "up" position, the pins are elevated sufficiently to contain all wires as they are routed. When it is time to tie the harness, the pins can be lowered to a

preset height so that they do not interfere with the tying operation. When the harness has been completely tied, the retracted position of the pins facilitates removal of the harness. Moving the pins again to the "up" position readies the board for fabrication of the next harness. When fabrication of one particular harness design has been completed, the pins may be removed and reinserted to accommodate a new harness design. All that has to be stored is the engineering print of the harness layout drawing. The lower movable pin board is 1/2-inch knot-free plywood. Should replacement of this board be necessary, it is easily removed by loosening four screws, rotating the retaining plate, and replacing the board. Thomas & Betts Co., Elizabeth, N. J.

Circle No. 156 on Inquiry Card

NEW COMPUTER TAPE

According to a report from the developers of a new computer tape, the same scientists who developed high resolution ferro magnetic oxide for computer tapes have now introduced a superior binder system which will eliminate most of present-day magnetic recording errors. According to the report, the ferro magnetic oxide particles in almost all computer tapes now on the market are bonded together by a thermoplastic system which expands when heated, permitting particles to drop out or to become rearranged. The new thermosetting binder system has optimum flexibility yet does not stretch or soften with heat thus holding the magnetic particles firmly in place despite changes in temperature or extended use. Superiority of the new tape, called Micronetic 404 could introduce new guarantees to the computer tape field with the possibility of certifying tapes to be completely free of errors for a period of ten years or more of continuous use. The half-inch wide computer tapes have a recording capacity of 800 bits per inch stored on 7 separate tracks. The Micronetic Corp., Alexandria, Va.

Circle No. 122 on Inquiry Card

INSTRUMENT POWER UNIT

A new solid-state 14-pound power unit was designed to combine with other instrument sub-assemblies to form completely self-contained pulse driver units. Negative or positive current or voltage pulse generator plug-in units, combined with the power unit, form pulse drivers that feature high power, variable rise time, fall time, and output amplitude control. Operating from positive or negative input gating signals with pulse repetition rates up to 10 megacycles, the power unit, with a suitable plug-in unit, provides variable parameter pulses for a wide variety of investigation and test applications. Computer Control Co., Framingham, Mass.

Circle No. 180 on Inquiry Card

SWITCH AND PROGRAM / **fast simple**

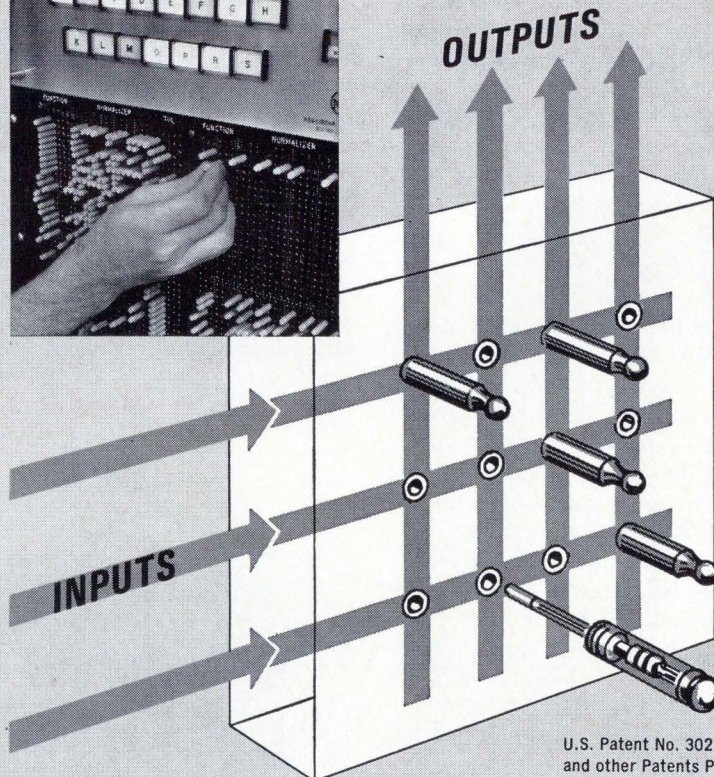
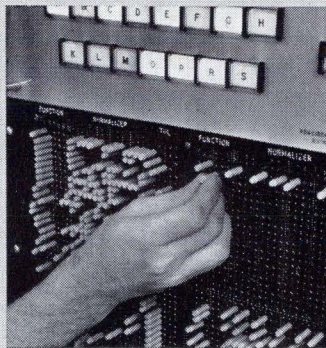

U.S. Patent No. 3027534
and other Patents Pending.

SEAELECTOBOARD®

End patch-board clutter and confusion . . . "Sealectoboard" programming and switching provides complete ease and simplicity of operation with drastic reductions in hardware and space. Complete programming or multi-switching operations are provided in a mechanically simple, ruggedly constructed "Sealectoboard." A single pin completes switching or component insertion in a circuit . . . move the pin to a new location and you have a new program function. Sealectoboards are made in 2, 3, and 4 deck versions. Modular or custom designs available for any application. Patented* component holders for interpositioning diodes or other components, skip pins and shorting pins are available in colors for color coding. Send for your free copy of our latest catalog of engineering information and application data . . .

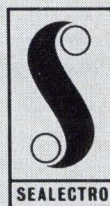

PROGRAMMING DEVICES DIVISION

SEAELECTRO CORPORATION

HOYT STREET • MAMARONECK • NEW YORK
PHONE: 914 698-5600 TWX: 914-3180

Sealectro Ltd., Walton-on-Thames, Surrey, England

* Sealectoplug U.S. Patent No. 3145329

CIRCLE NO. 31 ON INQUIRY CARD

NEW PRODUCTS

MAG TAPE TRANSPORT

Originally designed for digital geophysical field recording, a new transport system can be used in any application where adverse environmental conditions exist, such as aircraft recorders, mobile equipment, and shipboard applications. Identified as the FT-150 "Field-Tape" transport, the unit is lightweight yet ruggedly constructed to operate on low power from 12 vdc. Outstanding features are high-speed operation, modular construction, front access to all components for ease of maintenance, and minimum depth behind the front panel for mounting in confined areas. The complete system includes transport, data electronics, read/write head, full width dc erase head, EOT/BOT photo-reflective sensors, IBM-type reels and hubs, IBM-compatible write lockout switch, and precision tape cleaner. Three selectable tape speeds are accurately controlled by a single capstan dc servo system with any combination of tape speeds available from 15 to 150 ips. The system writes and/or reads digital data in IBM-compatible 7-channel and 9-channel (IBM 360 or ASCII-compatible) formats. With packing densities up to 800 bpi, data transfer up to 120 kc is readily available. Potter Instrument Co., Inc., Plainview, L.I., N.Y.

Circle No. 132 on Inquiry Card

LOW-OPACITY TAPE READER

A photoelectric punch tape reader is capable of reading low-opacity tapes. Designated the PTR-66, it is bidirectional, controlled by a front panel switch, and can read tapes with up to 40% transmissivity at speeds up to 150 cps asynchronously. In single quantity, price is \$585. Omni-Data, Div. of Borg-Warner Corp., Phila., Pa.

Circle No. 149 on Inquiry Card

PEDESTAL-GATED FLIP-FLOPS

New flip-flop module is one of a complete new line of 1-megacycle system logic functions, available in both germanium and silicon versions. The Model 03 Pedestal-Gated Flip-Flop module contains four flip-flops which are especially useful for control functions. These flip-flops, which can be used either individually or together, are altered by a zero level at one input and triggered by a positive-going transition at another input. Since the triggering transition is typically the trailing edge of a pulse all required conditions can be set up without encountering race condition or critical timing problems, greatly simplifying logic design of a system. The module includes its own clamp supply to minimize noise problems, and neon indicators on the module display the state of each flip-flop. Price: \$92.50.

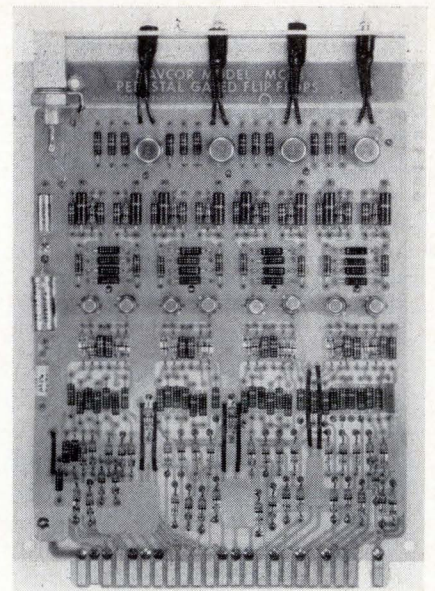

Navigation Computer Corp., Norristown, Pa.

Circle No. 126 on Inquiry Card

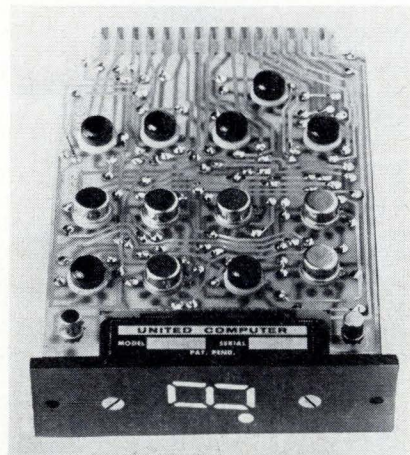

INTEGRATED LOGIC DECADE

An improved logic module complete with in-plane display can be used as a decade counter, shift register, or BCD-to-decimal display. It contains 13 integrated circuits and 7 silicon controlled rectifiers. Display is $\frac{3}{4}$ " high, uses 100,000 hour lamps, and is readable to over 25'. Counting speed is in excess of 3 million counts per second. Cost is \$89.00 each. United Computer Co., Phoenix, Ariz.

Circle No. 189 on Inquiry Card

MICROCIRCUIT VOLTAGE COMPARATOR

A dual differential voltage comparator in the form of a Planar epitaxial microcircuit is intended primarily for core memory sense amplifier applications. It can also be used as a window discriminator in pulse height detectors and as a double-ended limit detector for automatic go/no-go test equipment. It offers a resolution of 2 millivolts and a response time of 40 nanoseconds. It has an input voltage range of 5 volts, and a power consumption of 130 milliwatts. The device is compatible with practically all integrated logic forms with an output voltage of 3.2 volts and -0.5 volts. It has independent strobes on each channel which are compatible with all logic forms. The strobe release time is 12 nanoseconds. When the circuit is used as a sense amplifier, the threshold voltage can be adjusted over a wide range, almost independent of the integrated circuit characteristics. Fairchild Semiconductor, Mt. View, Cal.

Circle No. 129 on Inquiry Card

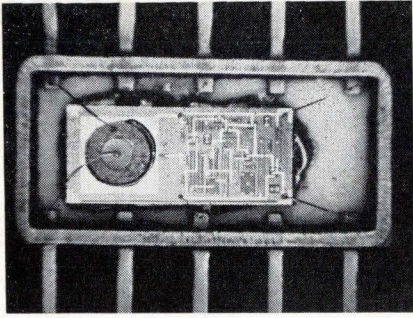

OPTICAL DIGITAL IC

A new semiconductor technology utilizing optical coupling to obtain complete electrical isolation within a standard integrated-circuit package has led to the development of an "optoelectronic pulse amplifier." Designated SNX1304, the experimental device offered for engineering evaluation consists of an integrated-circuit feedback amplifier with input from a light-sensitive

diode in the silicon bar. Affixed to the surface of the bar is a gallium-arsenide PN junction light emitter. Applications include transmission of ac or dc signals across computer-subsystem interfaces where circulating currents prevent interconnection of subsystem grounds, and where rejection of common-mode noise at the end of a long data-transmission line is required. The high input-to-output isolation (± 100 v) of the optical coupling allows the device to function as a broad-band pulse transformer with response extending from 100 kc to dc. The unit is compatible with company's standard digital integrated circuits. The package is a standard 10-lead TO-89 flat pack, $\frac{1}{4}$ " by $\frac{1}{8}$ ". Texas Instruments, Dallas, Texas.

Circle No. 146 on Inquiry Card

DISPLAY DEVICES

A new family of display devices includes three models of display stations with cathode ray tubes and numeric, numeric/block-alpha, or alphanumeric keyboards operating into universal control units. The control units may interface into a communications network, a central processor, or a combination of both. Display message lengths range from 32 to 786 characters, and the character library includes full alphanumeric, plus data and special function symbols; both input and response messages may be optionally edited, corrected, changed, or deleted. Used as primary terminal devices, the displays can either replace or supplement other types of input/output terminal equipment such as page printers and paper tape devices. The display system is designed to operate with any general purpose data processor and practically any number of stations may be used to form an integrated processing/communications network. Bunker-Ramo Corporation, Canoga Park, Cal.

Circle No. 123 on Inquiry Card

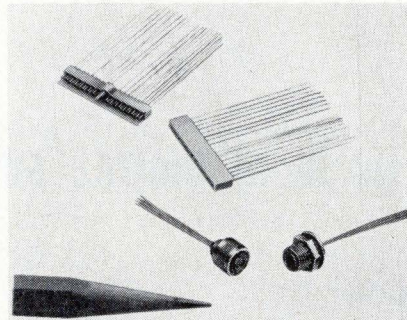

MICROMINIATURE CONNECTOR

New microminiature connectors with contacts paced on 0.025" centers include both strip and circular configurations. One seven contact circular connector with screw type engagement suitable for panel mounting and a 28 contact strip are available. The insulators of both the circular and strip connectors are made of glass-filled nylon. The contacts are twisted miniature cables with five outer strands wound around one core wire thereby assuring electric continuity when mated with tubular sockets. ITT Cannon Electric, Los Angeles, Cal.

Circle No. 120 on Inquiry Card

CODE GENERATOR

New integrated-circuit time code generator simultaneously generates any five precision BCD day-of-year and time-of-day codes from a selection of 5 IRIG, 3 NASA, and 3 Δ MR formats. Featuring integrated-circuit and all-silicon transistors, the unit requires only 5- $\frac{1}{4}$ inches of rack space, while providing frequency stability to 5×10^{-9} . Another feature is provision for 12-volt battery back-up in case of power failure. A single auxiliary battery will operate all circuits except the front-panel Nixie tube display. Electronic Engineering Co., Santa Ana, Cal.

Circle No. 154 on Inquiry Card

SMALL REED RELAYS

Two new reed relays are said to be the smallest ever produced. Both relays feature "flat-pak" design for high density component and card packaging, and have been designed to exceed all MIL R5757, Series 12, specifications. Contacts of the $\frac{1}{4}$ size and the $\frac{1}{8}$ size are sealed in glass. The header has glass-to-metal terminal seals and is soldered to the case. Terminal spacing of both relays is in multiples of 0.100 inches to comply with standard printed circuit board layout. Grigsby-Barton, Incorporated, Arlington Heights, Ill.

Circle No. 124 on Inquiry Card

THUMBWHEEL SWITCH

A 16-position thumbwheel switch provides letter, decimal or coded electrical output. For example, a standard 0-15 dial converts directly to binary-coded-Hexidecimal output, plus complement with two commons. Provisions have been made for mounting diodes in the output terminals. The new switch module is $\frac{1}{2}$ " wide. Individual switch modules may be ganged into a single unitized assembly to insure simplicity of mounting. Digitran Company, Pasadena, Cal.

Circle No. 171 on Inquiry Card

NEW PRODUCTS

DC POWER MODULE

New dc power module line provides 1-200 volts at 25.0 to 1.35 amps with input of 105-125v, 50-400cps at 5.0 amps. Regulation is 5 to 20mv max. (line and load); ripple is 1mv rms max. at 100v and below and 2mv rms max. above 100v; output impedance is less than 1 ohm at 500kc; and transient recovery time is less than 100 usec. Remote sensing, remote fuse, remote voltage adjust, automatic current limiting, overload protection, and overvoltage protection are standard. Net weight is 27 lbs; dimensions are 8 $\frac{5}{8}$ x 6 $\frac{1}{8}$ x 8-3/16. Dressen Barnes Electronics Corporation, Pasadena, Cal.

Circle No. 131 on Inquiry Card

MICROMINIATURE RESISTORS

High stability resistors which approach the ultimate in miniaturization of discrete components were designed for use in hybrid and "cordwood" circuits. Type RKL 2 are 0.12" long and 0.035" diameter and are rated at 30 mw. Supplied in tolerances of $\pm 20\%$ or $\pm 10\%$, resistors have several new design features. The carbon deposit, applied by pyrolysis to the ceramic substrate, is extended to cover cavities at the ends of the rod. The leads are soldered to nickel plating overlaying the carbon in these cavities. This assures stable electrical contact, a strong mechanical bond, and provides the longest possible resistance path. Risk of heat damage during soldering has been greatly reduced by use of Cu-Ni leads which combine high strength with low thermal conductivity. Quantity prices are as low as 18 cents each. British Radio Electronics Ltd., Washington, D.C.

Circle No. 138 on Inquiry Card

PROCESS CONTROL COMPUTER

A new high-speed, low-cost computer for both process control and scientific applications in the small computer market has been developed by General Electric. Suitable for rack mounting in an upright cabinet, or in a small desk, the GE/PAC 4020 has a selling price below \$50,000. With its comprehensive and coordinated peripheral and process communication equipment GE/PAC 4020 offers users convenient development into a plant management system. The computer can be used initially for data accumulation on a single-process unit, then expanded to full process control and later coupled with remote scanners or another process unit control computer to form the total plant management system. Production control, process control, optimization, yield accounting and other functions desired on an over-all plant basis are then possible. General Electric, Phoenix, Ariz.

Circle No. 182 on Inquiry Card

A DESIGN REFERENCE GUIDE

"CAUSES AND CURES OF NOISE IN DIGITAL SYSTEMS"

By J. Paul Jones, Jr.

A 56-PAGE POCKET-SIZE HANDBOOK

Excellent design tips and basic guideline rules for eliminating or minimizing noise in digital systems are given. Here is just a partial listing of topics:

- Electrostatic Interference in Backplane Wiring
- Worst-Case Cabling of Wires
- Inductive Noise in Systems Backplanes
- Routing of Circuit Grounds
- Use of Output Clamps • Output Filters
- RFI-Proofing • AC Power Line Noise
- Driving Diode Matrices • Power Supplies
- for Very High Noise Locations • Test Points

PRICE: \$1.75 per copy

Bulk quantity prices available on request.

To order your copy, simply fill out coupon below, enclose check or money order, for \$1.75 per copy, payable to Computer Design Publishing Corp. Shipment will be made immediately upon receipt of order.

COMPUTER DESIGN PUBLISHING CORP.
BAKER AVE., W. CONCORD, MASS. 01781

GENTLEMEN:

Enclosed is \$..... for copy(ies) of 56-page Handbook — "CAUSES AND CURES OF NOISE IN DIGITAL SYSTEMS".

SHIP HANDBOOK(S) TO:

NAME

COMPANY

ADDRESS

CITY STATE



RANDOM NUMBER GENERATOR

Unlike presently used subroutines, which generate pseudo-random numbers by using a mathematical approach, a new random number generator electronically generates true random numbers. Therefore, the errors introduced by pseudo-random numbers are avoided and a saving in memory space results by the elimination of the sub-routine. Designated the ERAC 7000, it is capable of generating random numbers in digital form up to 100 kc. It can be triggered externally or by internal clock. Trag Automatic Systems, Detroit, Mich.

Circle No. 147 on Inquiry Card

A-D CONVERTER/SERVO

A new analog-to-digital converter and closed loop position servo incorporates company's recently-developed proprietary components including a digital servo controller, a digital servo driven potentiometer, and digital servo comparator. Closure of a position feedback loop around the digital servo motor and controller accomplishes both A-D conversion and shaft position control. The digital servo comparator and digital servo-driven potentiometer provide the necessary comparison, amplification, and position feedback. Typical applications in industrial process controls and aerospace data and control functions include conversion of analog sensing instrument output to digital form and converting critical analog information to digital form (un-weighted binary) for high accuracy transmission by telemetry. Automation Development Co., Div. of Barton Instrument Corp., Monterey Park, Cal.

Circle No. 136 on Inquiry Card

CHALCO

photo-electric tape reader

\$400⁰⁰*

- 500 characters/second
- 3½" high
- One week delivery

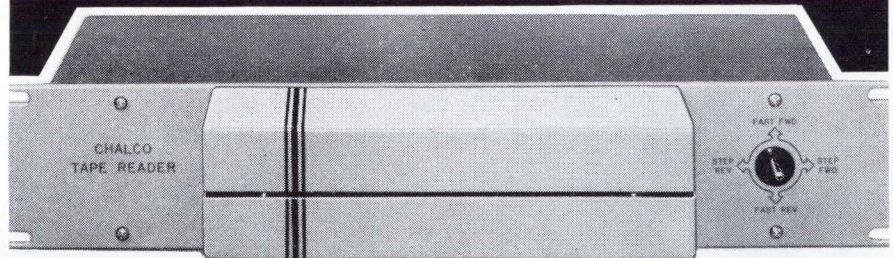

*Basic unidirectional module. Amplifiers and other options available at extra cost.

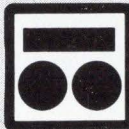

Send for literature

CHALCO ENGINEERING CORP.

Mfrs. of tape readers and D.C. power supplies

15126 S. BROADWAY, GARDENA, CALIFORNIA • FA 1-0121 (213)

CIRCLE NO. 32 ON INQUIRY CARD

REMEMBER **RESE**
FOR **MAGNETIC CORE MEMORIES**

OR CALL

**/215/
GL5/
9000**

RESE ENGINEERING INC.

A and Courtland Streets, Philadelphia, Pa. 19120 (215) GL5-9000

CIRCLE NO. 33 ON INQUIRY CARD

NEW PRODUCTS

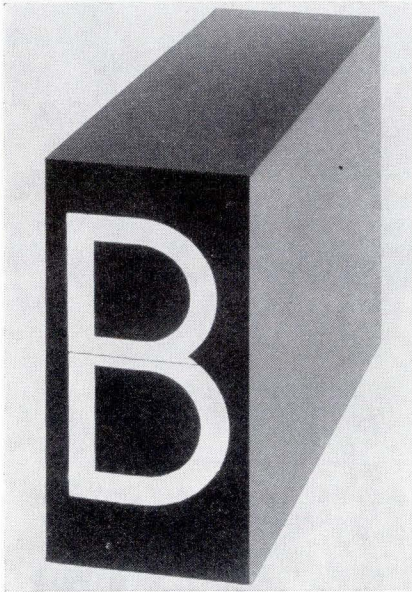

ALPHANUMERIC READOUT

A 40-position alphanumeric readout unit was designed for maximum malfunction-free continuous display. Optimum readability under varying light conditions and from acute viewing angles is said to have been achieved. Eliminated, according to the company, are many problems commonly associated with rear projection or illuminated displays such as varying contrast, bulb burnout, poor readability, and excessive service. Selected position is reached directly without reset through an 8-channel contact code. Readouts are not subject to readout errors due to loss of pulses commonly associated with readouts requiring reset prior to each signal pulse and set pulse count. The new readout does not depend on pulse count to reach correct readout position. Control of all 40 readout positions is accomplished through selection control code by closing 4 out of 8 input code contacts. When activated, unit will seek, through a decoder contact code inside the readout, the position that corresponds to the control contact code. Visiontron Corporation, N. Y., N. Y.

Circle No. 160 on Inquiry Card

MOS INTEGRATED CIRCUITS

Standard line of MOS devices now includes shift registers, binary counters (flip-flops), gates, MOS transistors, and MOSFETS (field effect transistors). It is believed to be the broadest line of standard MOS microcircuits available commercially, and the first such family of basic MOS units that permits construction of a complete computer or data processing system using only standard MOS microcircuits. The new MOS devices are designed basically for medium-speed systems operated at frequencies up to 1 megacycle. The expanded line now includes four different types of MOS shift registers for both industrial-commercial and military systems, operating from dc to 500 kc or 1 mc. Each type is really three shift registers in a single microcircuit, all sharing common supply voltages. The three can be used independently in parallel (to provide 16, 4, and 1 bit delays) or connected in series to give a total of 21 bits of delay to an arbitrary data stream. A new monolithic MOS R-S-T binary counter, or flip-flop, operating at frequencies from dc to 500 kc is priced at \$10 per unit in 100-999 quantities, and \$15 in 1-49 quantities. Company also offers an MOS "custom line" of monolithic integrated circuits. Custom packages available on 8- to 10-week delivery schedules include such devices as two 21-bit shift registers in a single package and packaged combinations of gates, binaries, and shift registers. General Instrument Corp., Hicksville, L. I., N. Y.

Circle No. 139 on Inquiry Card

DIGITAL DISPLAY

Two new digital display subsystems consist of a five-digit model and a six-digit model. Both subsystems include floating decimal points. The displays employ a stroboscopic technique to project multi-character presentations with a steady, bright illumination. Units feature an integral motor and a rotating drum which are used in conjunction with a single high-speed strobe tube, and optical projection system, and all-solid-state logic with self-synchro-

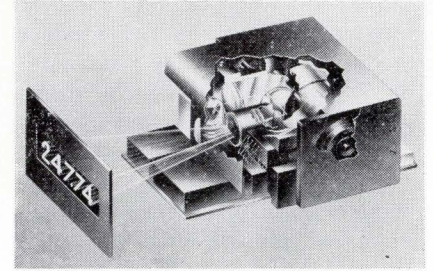

nizing circuitry. Time sharing of the strobe light and a single decoder-comparator circuit for six character columns and floating decimal point significantly reduces the number of components. As a result, the units are said to be highly reliable, fail-safe displays, with no erroneous information readout. Both models are self-contained and connect directly to 4-bit BCD input of 2 volts and 1 milliampere per bit, thus eliminating the need for drivers or buffers. A complete six-character number takes 22 milliseconds to form. This display speed, however, does not limit the ability of the electronics to accept inputs at megacycle switching rates. Raytheon Co., Components Div., Lexington, Mass.

Circle No. 121 on Inquiry Card

DISC MEMORIES

New disc memory system affords a bit-packing density of 3,125 bpi, stores up to six million bits of digital data in a compact 50-pound unit, and provides data storage at a cost less than one-tenth of a cent per bit. The system, called the F-6, is available with or without electronics, which includes read/write amplifiers, a head-switching matrix, encoding and decoding, and clocking. The standard F-6 unit operates

at 1800 rpm so that the average random access time to any of the six million bits is 16.7 milliseconds. The entire file can be unloaded in under three seconds at a data transfer rate of 2.8 million bits per second. The standard memory has an in-contact head on each of 64 tracks and is designed to provide up to 90 tracks of storage capacity, if required. Data Disc, Inc., Palo Alto, Cal.

Circle No. 165 on Inquiry Card

MILITARY COMPUTER

New general-purpose computer is said to be the smallest and lightest computer to offer militarized real time data processing with multiple program and multiple computer capability. The first of the company's L-300 series computers, it weighs only 34 pounds, including the power supply, and is contained in a rugged case measuring 0.3 cubic ft. Designated the L-304, it contains 4096 thirty-two-bit words of memory and is expandable to 32,000 32-bit words. With addition of memory extension logic, it can be increased to 131,072 32-bit words. Computational capability also is expandable through a multiple computer configuration. Each computer can communicate with up to 16 memory modules at 8192 words each, and each module can communicate with up to four computers. Read-write cycle time is 1.6 microseconds for a memory composed of 4096-word modules or 1.8 microseconds for a memory composed of 8192-word modules. The computer's compactness is made possible by maximum use of monolithic silicon integrated and hybrid circuits interconnected by unique multilayer boards, and by use of a series of miniaturized power supplies. While organized as a general purpose computer, the L-304 includes special features that make it effective in real time command and control and intelligence data processing. Litton Industries, Data Systems Div., Beverly Hills, Cal.

Circle No. 128 on Inquiry Card

PULSE TRANSFORMERS

Miniature encapsulated pulse transformers designed to plug into standard sockets may be used for isolation, coupling, or blocking oscillator circuits. The windings may be connected in various ways for impedance matching. The transformers are embedded in epoxy, with aluminum outer shells. They are resistant to humidity, shock and vibration, and other environmental conditions. They are priced at \$9.10 each. Berkshire Laboratories, Princeton, N. J.

Circle No. 153 on Inquiry Card

CHALPAK POWER SUPPLIES

*fill special
needs at
standard
prices*

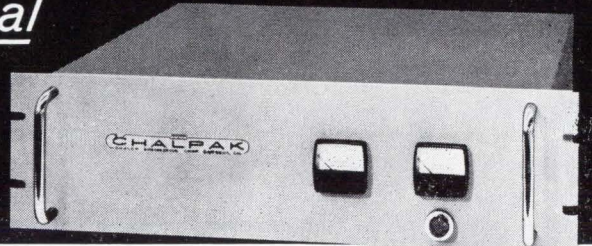

Whatever you require can be delivered in a standard Chalpak. Any voltage to 500v. Any current to 100 amps. Regulation: 1%, .1%, or .01%.

Multiple form factors give you wide latitude: 1/6 rack, 1/4, 1/3, 1/2, and full rack. Overload protection is standard. So are silicon transistors, and remote sensing/programming. Options include over and/or under voltage protection. *Low cost... low maintenance.*

Send for Chalpak catalog.

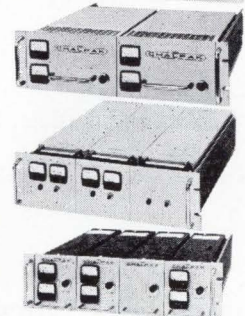

CHALCO ENGINEERING CORP.

Mfrs. of tape readers and D.C. power supplies

15126 S. BROADWAY, GARDENA, CALIFORNIA • FA 1-0121 (213)

CIRCLE NO. 34 ON INQUIRY CARD

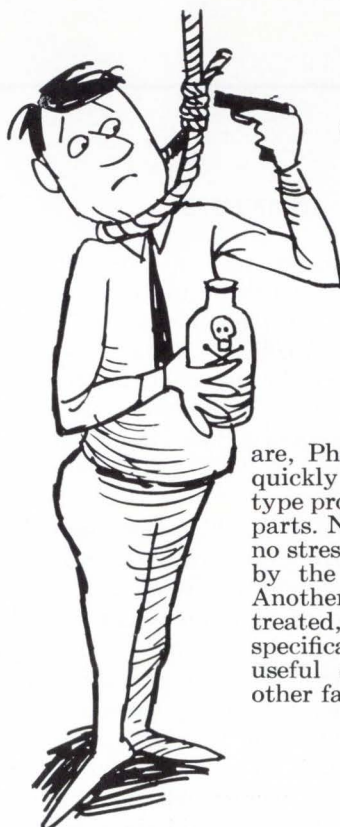

*Ready to end it all
over delays in
prototype production?*

use the

*theory of
probability
to solve your problems*

This is where experience counts! Chances are, Photoforming by Hamilton will get you quickly from the drawing board stage to prototype production of thin, flat, odd-shaped precision parts. No dies . . . no burrs . . . no bent edges . . . no stresses . . . no delays when parts are produced by the Hamilton process called Photoforming. Another plus, Photoformed parts can be heat-treated, plated, or formed according to your specifications. Write for the facts—you'll get useful data on Hamilton's Photoforming and other facilities.

INDUSTRIAL PRODUCTS DIVISION

 **HAMILTON**

WATCH COMPANY
LANCASTER, PA.

CIRCLE NO. 35 ON INQUIRY CARD

NEW PRODUCTS

DIGITAL PLOTTER

A truly digital plotter features absolute position sensing by means of photoelectric readers scanning 19 track linear precision engraved binary coded scales on each axis. System is said to eliminate sources of error common to incremental plotters. It accepts manual, tape, and card inputs. Life time accuracy within 0.002 inches and repeatability within 0.001 inches. Discon Corp., Fort Lauderdale, Fla.

Circle No. 175 on Inquiry Card

MILITARY DATA PROCESSOR

A general-purpose digital data processor, the DPS-2402, has been developed by the Surface Division of the Westinghouse Defense and Space Center. The unit was specifically designed to meet military requirements using specifications MIL-E-16400 and MIL-E-4158 as guides. The new system has a response time of two microseconds. It uses 24-bit words and a stored program. It is capable of withstanding unusual shock, vibration, temperature extremes, salt spray, and humidity. The first DPS-2402 data processor will be installed aboard the Royal Canadian Navy's new high-speed antisubmarine hydrofoil, the FHE-400. Molecular electronic circuits are used in the new data processor to achieve high speed, high reliability, low power consumption, and small size. The unit is a parallel, 24-bit-per-word, binary, single-address, stored program machine capable of retaining from 4000 to 32,000 words of memory. The DPS-2402 is designed for real-time applications such as tactical control, communications switching, weapon control and guidance, navigation and air traffic control, and display. Westinghouse Electric Corp., Pittsburgh, Pa.

Circle No. 142 on Inquiry Card

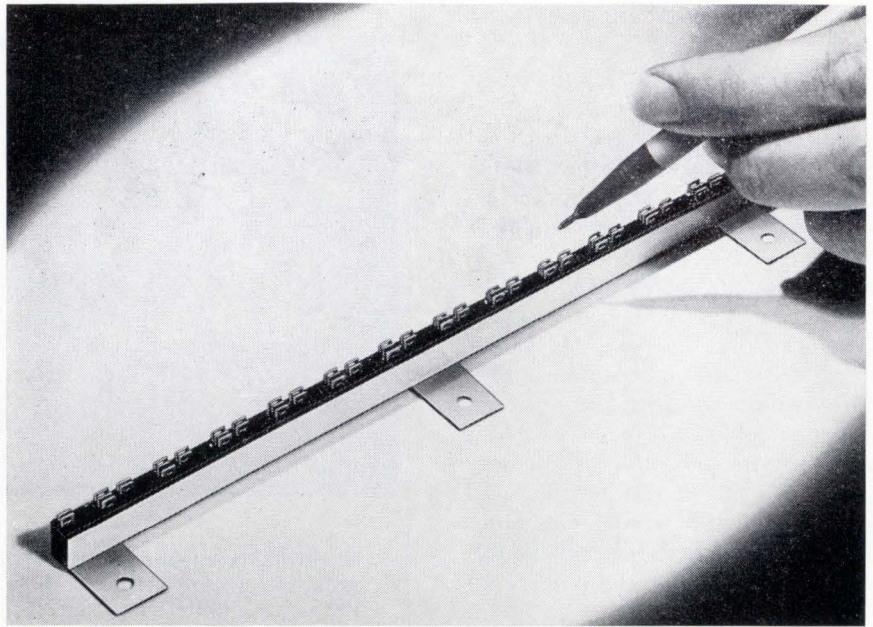

LAMINAR BUS BAR

For use in computers, communications equipment, and other high-speed switching applications, a new miniature high-reliability laminar bus bar consists of five conductor layers of 0.016" copper or brass, insulated with polyester film between each layer. The three signal-carrying layers are interleaved with grounding conductor layers to provide high capacitance and low noise. The entire bus bar assembly is en-

capsulated to withstand a wide range of ambient environmental conditions as well as being vibration and shock resistant. This laminar bus bar has tap-offs on 0.200" centers, designed to feed two signals and ground into each printed circuit board connector in a rack-mounted arrangement. The tap-offs are of the solder hole type and are tinned for easy soldering. Methode Mfg. Corp., Rolling Meadows, Ill.

Circle No. 186 on Inquiry Card

NEW COMPUTERS

Making its entry into the computer field, a series of medium capacity, general-purpose computers priced from \$23,000 to \$35,000 was announced by Scientific Control Systems, Inc. The company is conducting pre-procurement demonstrations of the SCS 670-2; a \$35,000 system with four times the speed of comparable competitive computers, it is claimed. The computer has a 4-microsecond add time, a 12 microsecond multiply time, and the price includes hardware, input-output channels, a direct register control console, and index register. Other computers in the new series are: the SCS 660-5, a \$23,000 system with a 5 microsecond memory cycle, 10 microsecond add time, and 155

microsecond multiply time; SCS 660-2 priced at \$28,000 with a 2 microsecond memory cycle; and SCS 670-5 costing \$29,000 with a 5 microsecond memory cycle, 10 microsecond add time, and 30 microsecond multiply time. The entire series of SCS computers is binary, single address with indexing, indirect addressing, and a complete instruction repertoire. The computers have core memories with 4,096-word capacity, expandable to 32,000 words of 24 bits. Software includes a symbolic assembler, utility and mathematic routines, a Fortran compiler, diagnostic routines, and other software from a library of programs. Scientific Control Systems, Incorporated, Dallas, Texas.

Circle No. 141 on Inquiry Card

CODE CONVERTER

New code converter was developed to serve as an on-line interface between conventional start-stop and synchronous telegraph systems. In addition, it enables utilization of the converter with single channel start-stop telegraph circuits permitting actual transmission of information by synchronous signals. The advantages of synchronous operation (lower error rates, reduced idle channel hits, stable system clock, etc.) can provide a substantial increase in system performance. The basic design of the Model 690A code converter includes built-in loop power supply, internal crystal-controlled timing, regeneration of input signals, bit synchronism of the synchronous circuits, automatic or manual synchronous framing, and solid-state input and output relays. Frederick Electr. Corp., Frederick, Md.

Circle No. 157 on Inquiry Card

STATIC CARD READER

New card reader provides for simple multi-connection programming of repetitive system or equipment functions such as batching, mixing, heat treating, etc., along with quick changeover to a new pattern as required. The card reader consists of two opposing arrays of contacts — male and female — hinged into a compact locking frame. In simplest terms, circuits across matching contact pairs are made or interrupted according to a pattern punched into an interleaving plastic card. Standard card readers have 336-point arrays, but up to 2000-point units are available. The standard model measures 9" x 4-13/16" x 2-15/16" deep. To facilitate generating the program cards, a simple, low-cost punching device is available. It consists of a matrix frame and an easy-to-operate manual hole punch. Tenor Co., Butler, Wis.

Circle No. 148 on Inquiry Card

RFI-SHIELDED INDICATORS

To eliminate radio frequency interference "leaks" that can introduce false information in computers and hamper operation of other equipment, a company has designed a metal mesh shield inside the plastic lens of its indicator lights. To solve the RFI problem for pushbutton switches, the company also developed a special U-shaped spring "wiper" around the inner metal button of the switch, designed to maintain continuous contact with the case throughout switch travel. Shielded indicator lights are available in the standard size with replaceable incandescent or neon lamps or a permanently-sealed 50,000 hour subminiature indicator. Shielded pushbutton switches can be furnished in two-circuit and four-circuit momentary contact designs, and in a push-push double pole double throw model. Controls Co. of America, Folcroft, Pa.

Circle No. 125 on Inquiry Card

Test & Measuring Equipment
Data Recorders
Data Processing Equipment
Power Supplies
Communications Systems



The Boxer® Fan fights failures by keeping components cool in these and many other systems and electronic enclosures.

Standard size rugged metal housing resists breakage to assure system reliability.

Long life. Air bearing model endures 20 to 30 years; sleeve bearing model some 5 years; stainless steel ball bearing model has life in between. Commercial and mil spec types available. Accepts many inputs, dc to 400 cps, 28 to 230V models. Range of outputs. From 70 to 195 cfm; flip fan to reverse airflow direction. Accessories. Screen and filter available in standard and slim-line

(1/8 inch) types; also finger guards and cord sets. Available. Six widely used models are distributor stocked for immediate delivery. Sales reps throughout the US and in Canada.

IMC Magnetics Corp., only producer of the high-reliability fan used in the MINUTEMAN'S guidance computer, is the single-source specialist for airmovers.

EAST
Baltimore, Md.: D & H Distributing Co., Inc., (301) 539-6525
Binghamton, N.Y.: Stack Industrial Electronics, (607) RA 3-6326
Boston, Mass.: De Mambro Radio Supply Co., (617) AL 4-9000
Cambridge, Mass.: Electrical Supply Corp., (617) UN 4-6300
Clifton, N.J.: Eastern Radio Corp., (201) 471-6600
Farmingdale, L. I., N.Y.: Arrow Electronics, Inc., (212) JA 6-0300 (516) MY 4-6800
New Haven, Conn.: Connector Corp. of America, (203) SP 7-2513
Philadelphia, Penn.: Simco Electronics, Inc., (215) 229-1880, (609) 964-8400
Pittsburgh, Penn.: Cameradio Company Industrial Electronics, (412) 391-4000

SOUTH
Atlanta, Ga.: Ack Radio Supply Co., (404) 375-5246
Birmingham, Ala.: Ack Radio Supply Co., (205) FA 2-0588
Greenville, S. C.: Carolina Radio Supply Co., Inc., (803) 239-5125

Greensboro, N. C.: Carolina Radio Supply Co., Inc., (919) 273-8669
Huntsville, Ala.: Ack Radio Supply Co., (205) 825-2341

MIDWEST
Cincinnati, Ohio: Newark Herrlinger Electronics Corp., (513) GA 1-5282
Chicago, Ill.: Newark Electronics Corp., (312) ST 2-2944
Dayton, Ohio: ESCO, Inc., (513) 298-0191
Detroit, Mich.: Newark Ferguson Electronics Corp., (313) JO 4-5490
Minneapolis, Minn.: D. A. Schultz Co., (612) FE 9-7701
Milwaukee, Wis.: Electronic Expeditors, (414) 871-3000
St. Louis, Mo.: Target Sales Corp., (314) JA 1-3800

WEST
Austin, Tex.: 4-M Co., (512) ALpine 5-3131
Dallas, Tex.: All State Electronics, Inc., (214) RI 1-3281

Denver, Colo.: Newark-Denver Electronic Supply Corp., (303) SK 7-3351
Houston, Tex.: Busacker Electronics & Equipment Company, Inc., (713) JA 6-4661
Gardena, Calif.: Bell Electronic Corp., (213) FA 1-5802
Inglewood, Calif.: Newark Electronics Corp., (313) OR 8-0441
Los Angeles, Calif.: Kieruff Electronics, (213) OV 5-5511
Menlo Park, Calif.: Bell Electronic Corp., (415) DA 3-9431
Palo Alto, Calif.: Pencil Electronic Corp., (415) DA 6-3366
San Diego, Calif.: Bell Electronic Corp., (714) BR 8-4350, Kieruff Electronics, (714) 278-2112
Salt Lake City, Utah: Newark-Denver Electronic Supply Company, (801) EM 3-6107
San Antonio, Tex.: Busacker Electronics & Equipment Company, Inc., (512) CA 3-5517
Seattle, Wash.: Seattle Radio Supply, Inc., (206) MA 4-2341
Tempe, Ariz.: JMC Magnetics Corp., Arizona Division, (602) 967-7851

CANADA
Ottawa, Ont.: M. J. Howard Co., Ltd., PA 8-2991

imc Magnetics Corp., Marketing Division: 570 Main Street, Westbury, New York 11591. Telephone: (516) 334-7070. TWX (516) 333-3319.

CIRCLE NO. 36 ON INQUIRY CARD



Information Handling

Ground data handling systems are featured in a 34-page booklet. Sections treat analog acquisition systems, PCM acquisition systems, digital data processing systems, data display systems, digital command systems, airborne telemetry systems, and antenna systems. Radiation Inc., Melbourne, Fla.

Circle No. 201 on Inquiry Card

Tape Reader Module

Modular photocell tape reader is described in a new spec sheet. The modules are available in 7, 8, and 9-cell configurations of cadmium selenide cells. Their simple design is said to end the problem of assembling tape reader heads one cell at a time. The cells are potted in compact modules slightly over an inch long and less than 1/2-inch in height. In addition to the spec sheet, a 16-page photocell designers' handbook is available. Clairex Corp., New York, N. Y.

Circle No. 220 on Inquiry Card

Oscilloscope Cameras

A 12-page booklet describes standard camera systems and also contains detailed specifications on available components and accessories which can be used to simplify custom-designing a camera to meet individual specific requirements. In addition, the booklet features a series of waveform photographs illustrating many typical applications with various lens/object-to-image ratio combinations. Tektronix, Inc., Beaverton, Ore.

Circle No. 223 on Inquiry Card

Silicone Encapsulants

Selection guide to RTV encapsulants gives comparative physical, chemical, and electrical properties of six room-temperature-vulcanizing silicone rubber encapsulants designed for electronic packaging. Also covered in the brochure are how-to-use suggestions for the six materials, including data on pot life with different catalyst concentrations, and information on how viscosity can be adjusted to suit particular processing requirements. Dow Corning Corporation, Midland, Mich.

Circle No. 236 on Inquiry Card

Random Access Memory

Brochure describes a dual-cartridge random access memory system called the RAM. The system utilizes a unique drive system which permits the use of high-density magnetic tape loops as the storage medium. The dual-cartridge provides important operational flexibility. Partial or entire data content may be copied from one cartridge to the other, eliminating the necessity for two machines where the on-line capacity of one is adequate. The memory provides 50.2 million bits of on-line capacity equally divided between the two cartridges. Information is recorded serially at an information density of 1,000 bits/inch, and any information may be written or read at random by transmitting address information to the unit with an appropriate command signal. Reliability is said to be better than one bit in 10^9 transient error rate. Average access time is less than 90 milliseconds, including both head positioning and average latency time. Potter Instrument Co., Inc., Plainview, N. Y.

Circle No. 226 on Inquiry Card

Connector Catalog

A new 68-page catalog covers a wide variety of tube sockets, plugs, and connectors for commercial and industrial use. The section on tube sockets features a discussion on advantages and disadvantages of various contact and dielectric materials along with a table of dielectric mechanical and electrical characteristics. Connectors featured in the catalog include rack and panel units, printed circuit connectors, miniature power connectors, and hermetic seal units. Amphenol Corp., Chicago, Ill.

Circle No. 214 on Inquiry Card

Circuit Components

New 28-page catalog covers "Monobloc" ceramic capacitors, tubular and discs, transcaps, button mica capacitors, feed thru and stand offs, trimmers, film capacitors, and bypass capacitor systems for transmitting tubes. It also covers broad band RFI filters, bushing and eyelet filters, multisection filters, silicon diffused rectifiers, diodes, and integrated networks. Erie Technological Products, Erie, Pa.

Circle No. 224 on Inquiry Card

Numerical Display

Fold-out selection chart outlines in detail the specifications and functional characteristics of company's continuous and latching numerical displays. One of the series of displays incorporates a special feature of latching storage, making it possible to sample at any desired time the information being presented to the display, and to indicate and hold this sampled data for convenient visual observation. The latch command pulse automatically clears, decodes, and writes the information presented at the input terminals. No additional control signals are required to erase the previous display. Transatron Electronic Corp., Wakefield, Mass.

Circle No. 235 on Inquiry Card

Solenoid Driver Protection

A two-page bulletin, eighth in company's "Magnetic Testing Note" series, examines the situation in which long cables connecting a driver module with relay or solenoid can increase the inductive kickback enough to destroy the driving transistor in the module. This problem occurs in testing systems using certain core handling equipment. The solution described in the bulletin is to connect a Zener diode between the collector of the output transistor and ground. The normal operation of the circuit is not affected by this addition, but during abnormal transients at the output terminal, the Zener breakdown of the diode is exceeded, and the inductive kickback is shunted to ground. A diagram indicates where the diode would be connected to protect a solenoid drive circuit. Digital Equipment Corp., Maynard, Mass.

Circle No. 209 on Inquiry Card

Automated Communications Set

How a new automated communications set simplifies the preparation of business forms is described in an 8-page brochure. The Model 35 ACS, which extends capabilities of the company's Model 35 automatic send-receive set, eliminates time-consuming repetitive manual typing, form positioning, and programming by the operator. The brochure covers how this is accomplished through the application of two paper tape readers. One reader senses and interprets a tape containing information normally repeated on each form. The second reader accepts a program and format tape. Inter-operating at programmed intervals, the readers automatically control most of the form preparation but permit the manual entry of variable data by the machine's operator. The brochure describes how the unit is used for the transmission of business form and other data "on-line" or directly into a computer or associated business machines for processing. Teletype Corp., Skokie, Ill.

Circle No. 215 on Inquiry Card

Core Memory System

New memory system with one microsecond speed and large memory capacity is described in a bulletin. The Series MFA1, with 400-nanosecond access time, is available in word capacities up to 32,000, in a bit length. Construction is all-silicon semiconductor printed circuit modules. The brochure includes information for specifying any of four cycle operations, six access modes, and nine combinations of address and data registers, power supply, and self-test circuitry. These variations, together with eight optional accessories, give the user more than 1700 possible configurations from which to select. Fabri-Tek Inc., Amery, Wis.

Circle No. 225 on Inquiry Card

Stored Program Simulator

Data sheet gives full description and specification information on a stored program simulator that is capable of simulating any known format, regardless of complexity. It is designed to evaluate, checkout, and calibrate PCM, PAM, and PDM decommutation systems, digital or video tape systems, digital and analog computers, quick-lock devices, XY plotters, and telemetry data processing routines. It consists of a 20x256 core memory, an 8-bit address register, a 20-bit input/output register, and various generating circuits. Word and frame length is limited only by the ultimate capacity of the memory, and multiple formats may be stored simultaneously. Telemetrics, Inc., Santa Ana, Cal.

Circle No. 207 on Inquiry Card

Core Stacks/Arrays

Individual product sheets describing magnetic core memory components, a specifications sheet on memory arrays and stacks, and a reference index are contained in a new product folder. Ampex Corp., Redwood City, Cal.

Circle No. 218 on Inquiry Card

DC Power Supplies

A 2-page catalog describes a recently-expanded line of extra-high current silicon modular dc supplies. These supplies have current ratings of 40, 25, and 15 amps in voltage ratings from 1 through 31 vdc and are packaged so as to provide minimum size and weight characteristics. Catalog provides technical data, physical and electrical specs, model listings, and pricing data. Electronic Research Associates, Inc., Cedar Grove, N. J.

Circle No. 232 on Inquiry Card

Desk-Top Computer

New 8-page brochure describes the capabilities and operation of a low-cost desk-top computational center. It offers such features as six 24-digit registers — three arithmetic and three storage — with complete freedom of transfer, automatic square root, and 8-inch "TV" tube display of all operations. A programmed automatic card input system is said to provide for unlimited externally-stored programs. Any scientific problem which can be programmed as a power series expansion or summation of series can be performed automatically. Wyle Laboratories, Inglewood, Cal.

Circle No. 200 on Inquiry Card

Coaxial Connectors

Complete line of connectors and adapters for use with shielded and coaxial cable is described in a 12-page brochure. A step-by-step installation guide of a new "Shield-Kon" system for terminating and grounding the braid on multiple shielded or overall shielded cables is featured. New tool for extracting leads and for compressing the connectors is illustrated. Information for selecting the proper connectors and adapters, as well as hand or power tools with the proper dies, is included. The Thomas & Betts Co., Elizabeth, N. J.

Circle No. 212 on Inquiry Card



SALES OFFICES

BOSTON

Lindsay H. Caldwell
Professional Bldg.
Baker Ave.
W. Concord, Mass.
phone: (617) 369-6660

NEW YORK

Robert J. Bandini
663 Fifth Ave.
New York 20, N. Y.
phone: (212) 421-4840

CHICAGO

Phil Holmes
410 N. Michigan Avenue
Chicago 11, Illinois
phone: (312) 467-6240

DETROIT

Robert T. Barrett
424 Lafayette Building
Detroit 26, Michigan
phone: (313) WO 1-0278

LOS ANGELES

David Barton
672 So. Lafayette Park Pl.
Los Angeles 57, California
phone: (213) 382-1121

LONG ISLAND — SO. CONN.

C. Lynn Coy
Robert C. Woodies
155 E. 50th St.
N.Y., N.Y. 10022
phone: (212) 751-2960

SAN FRANCISCO

David Barton
672 So. Lafayette Park Pl.
Los Angeles 57, California
phone: (213) 382-1121

ADVERTISERS' INDEX

BRYANT COMPUTER PRODUCTS	41
CAMBRIDGE THERMIONIC CORP.	48
CHALCO ENGINEERING CORP.	57, 59
COMPUTER CONTROL CO., INC.	Cover 2
CONNECTICUT TECHNICAL CORP.	35
CONTEMPORARY ELECTRONICS	Cover 3
DATAMEC CORP.	12
DECISION CONTROL INC.	17
DIGI-DATA CORP.	37
DIGITAL EQUIPMENT CORP.	8
DIGITRAN CO.	39
ELECTRONIC MEMORIES, INC.	1
FABRI-TEK, INC.	6
FAIRCHILD SEMICONDUCTOR	32, 33
THE FOXBORO CO.	49
GENERAL DYNAMICS/ELECTRONICS	4
HAMILTON WATCH CO.	59
HAYDON SWITCH & INSTRUMENT, INC.	14
IMC MAGNETICS CORP.	61
INSTRULAB, INC.	48
INTERNATIONAL DIODE CORP.	23
INVAC CORP.	51
LITTON INDUSTRIES	
Encoder Div.	5
Monroe Datalog Div.	15
MAGNE-HEAD	
Div. of General Instruments	47
NATIONAL CASH REGISTER	27
NAVIGATION COMPUTER CORP.	40
OAK MANUFACTURING CO.	38
RESE ENGINEERING CORP.	57
ROTRON MANUFACTURING CO., INC.	10
ROYAL TYPEWRITER CO.	2
SCIENTIFIC DATA SYSTEMS	13
SEAELECTRO CORP.	53
SINGER CO.	
Diehl Div.	21
TALLY CORP.	Cover 4
TECH LABORATORIES, INC.	35
TELETYPE CORP.	7, 9, 11

Contemporary Electronics is one of the largest producers of computer pulse transformers in the U.S.

SO?

So, maybe you're missing a bet if you haven't checked Contemporary Electronics for *quality, service* and *price*.

Contemporary Electronics *specializes* in pulse transformers. It's not a sideline, but a principal part of our business. Well over 100,000 pulse transformers are produced each month in 75 different designs.

Advantages? Here are some.

Technical Capability. Contemporary Electronics engineering staff knows computers and can design any special product for any application.

High Quality. Most transformers have special high quality design features. All pulse transformers are 100% inspected as many as three times before shipment. QC system meets MIL-Q-9858, and has been approved for use on the Apollo program.

Fast Sample Service. Samples, small production lots and specials are normally shipped 24 to 72 hours after receipt of request.

Interested in what can be done in terms of performance, size, delivery, or MIL-specs? Get to us—we've got lots more to tell.

WRITE, OR CALL COLLECT AND WE'LL HAVE THE FULL STORY TO YOU WITHIN 48 HOURS

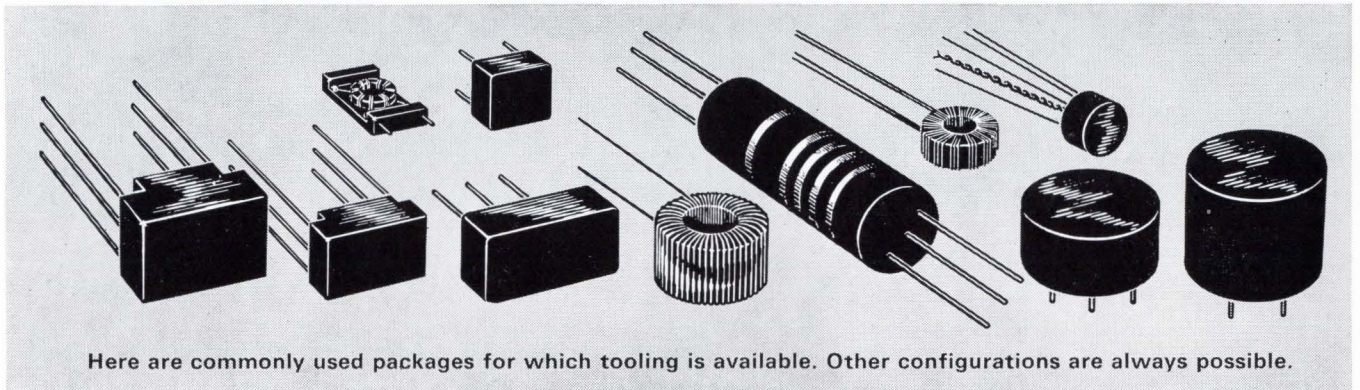

Here are commonly used packages for which tooling is available. Other configurations are always possible.

 **CONTEMPORARY
ELECTRONICS**

128 North Jackson, Hopkins, Minn. 55343 Telephone 935-8481—Area Code 612
EXTRA SERVICE TO THE DATA PROCESSING INDUSTRY

CIRCLE NO. 37 ON INQUIRY CARD



Tally perforators make more chad per dollar, save it for New Year's Eve!

Whether you welcome an astronaut, celebrate New Year's or just plain punch tape day-in-day-out, your Tally perforator will supply you with perfect chad—and more of it. (Our chad drops from perfectly round holes in perfectly spaced tape.)

Take the minor mountain of chad we generated here. This is the first part of the life test on our new P-120 Perforator. 600 million perfect holes or 120 million characters were made to prove reliability. This is no one-time deal either. Every new Tally product gets the same going over when it's new and periodically as long as we offer it for sale.

Recently, our engineers have given us a good number of new products including perforators, readers, data communications equipment, and logic systems. Let us send you the details. Address Mr. Ken Crawford, Tally Corporation, 1310 Mercer Street, Seattle, Washington 98109, Phone: (206) MA 4-0760. TWX: (910) 444-2039. In the U. K. and Europe, address our man in London, H. Ulljohn, Tally Europe Ltd., Radnor House, 1272 London Road, London, S.W. 16, England, Phone: POLlards 9199.

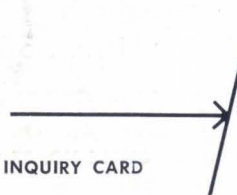
 **TALLY®**

CIRCLE NO. 38 ON INQUIRY CARD