

Z8000 CPU Technical Manual

Zilog
Zilog
Zilog
Zilog
Zilog

Table of Contents

1.1	Introduction	1-1	Z8000 Processor Overview
1.2	General Organization	1-1	
1.3	Architectural Features	1-1	
	General-Purpose Register File	1-2	
	Instruction Set	1-2	
	Data Types	1-2	
	Addressing Modes	1-2	
	Multiple Memory Address Spaces	1-3	
	System/Normal Mode of Operation	1-3	
	Separate I/O Address Spaces	1-3	
	Interrupt Structure	1-3	
	Multi-Processing	1-4	
	Large Address Space of the Z8001	1-4	
	Segmented Addressing of the Z8001	1-4	
	Memory Management	1-4	
1.4	Benefits of the Architecture	1-5	
	Code Density	1-5	
	Compiler Efficiency	1-5	
	Operating System Support	1-5	
	Support for Many Types of Data Structures	1-6	
	Two CPU Versions: Z8001 and Z8002	1-6	
1.5	Extended Instruction Facility	1-6	
1.6	Summary	1-6	
<hr/>			
2.1	Introduction	2-1	Architecture
2.2	General Organization	2-1	
2.3	Hardware Interface	2-3	
	Address/Data Lines	2-3	
	Segment Number (Z8001 only)	2-3	
	Bus Timing	2-3	
	Status	2-3	
	CPU Control	2-4	
	Bus Control	2-4	
	Interrupts	2-4	
	Segment Trap Request (Z8001 only)	2-4	
	Multi-Micro Control	2-4	
	System Inputs	2-4	
2.4	Timing	2-4	
2.5	Address Spaces	2-4	
	Memory Address Space	2-4	
	I/O Address Space	2-5	
2.6	General-Purpose Registers	2-5	
2.7	Special-Purpose Registers	2-7	
	Program Status Registers	2-7	
	Program Status Area Pointer	2-7	
	Refresh Counter	2-7	
2.8	Instruction Execution	2-7	
2.9	Instructions	2-7	
	Instruction Formats	2-8	
2.10	Data Types	2-8	
	11 Addressing Modes	2-8	
2.12	Extended Processing Architecture	2-8	

Table of Contents (Continued)

2.13 Exceptions	2-9	Architecture (Continued)	2		
Reset	2-9				
Traps	2-9				
Interrupts	2-9				
Trap and Interrupt Service Procedures	2-9				
<hr/>					
3.1 Introduction	3-1	Address Spaces	3		
3.2 Types of Address Spaces	3-1				
3.3 I/O Address Space	3-1				
3.4 Memory Address Spaces	3-2				
Addressable Data Elements	3-2				
Segmented and Nonsegmented Addresses	3-2				
Segmentation and Memory Management	3-3				
<hr/>					
4.1 Introduction	4-1	CPU Operation	4		
4.2 Operating States	4-1				
Running State	4-1				
Stop/Refresh State	4-1				
Bus-Disconnect State	4-1				
Effect of Reset	4-1				
4.3 Instruction Execution	4-2				
Running-State Modes	4-2				
Segmented and Nonsegmented Modes	4-2				
Normal and System Modes	4-3				
4.4 Extended Instructions	4-4				
<hr/>					
5.1 Introduction	5-1			Addressing Modes	5
5.2 Use of CPU Registers	5-2				
5.3 Addressing Mode Descriptions	5-2				
5.4 Descriptions and Examples (Z8002 and Z8001 Nonsegmented Mode)	5-3				
Register (R)	5-3				
Immediate (IM)	5-3				
Indirect Register (IR)	5-3				
Direct Address (DA)	5-4				
Index (X)	5-4				
Relative Address (RA)	5-4				
Base Address (BA)	5-5				
Base Index (BX)	5-6				
5.5 Descriptions and Examples (Segmented Z8001)	5-6				
Register (R)	5-6				
Immediate (IM)	5-6				
Indirect Register (IR)	5-7				
Direct Address (DA)	5-7				
Index (X)	5-8				
Relative Address (RA)	5-8				
Base Address (BA)	5-9				
Base Index (BX)	5-10				

6.1	Introduction	6-1	Instruction Set	6
6.2	Functional Summary	6-1		
	Load and Exchange Instructions	6-2		
	Arithmetic Instructions	6-2		
	Logical Instructions	6-3		
	Program Control Instructions	6-3		
	Bit Manipulation Instructions	6-4		
	Rotate and Shift Instructions	6-4		
	Block Transfer and String Manipulation Instructions	6-5		
	Input/Output Instructions	6-6		
	CPU Control Instructions	6-6		
	Extended Instructions	6-7		
6.3	Processor Traps	6-7		
6.4	Condition Codes	6-8		
6.5	Instruction Interrupts and Traps	6-8		
6.6	Notation and Binary Encoding	6-9		
6.7	Z8000 Instruction Descriptions and Formats	6-11		
6.8	EPA Instruction Templates	6-167		

7.1	Introduction	7-1	Exceptions	7
7.2	Interrupts	7-1		
	Non-Maskable Interrupt (NMI)	7-1		
	Vectored Interrupt (VI)	7-1		
	Nonvectored Interrupt (NVI)	7-1		
7.3	Traps	7-1		
	Extended Instruction Trap	7-1		
	Privileged Instruction Trap	7-1		
	System Call Trap	7-1		
	Segment Trap	7-1		
7.4	Reset	7-2		
7.5	Interrupt Disabling	7-2		
7.6	Interrupt and Trap Handling	7-2		
	Acknowledge Cycle	7-2		
	Status Saving	7-2		
	Loading New Program Status	7-3		
	Executing the Service Routine	7-4		
	Returning from an Interrupt or Trap	7-4		
7.7	Priority	7-4		

8.1	Introduction	8-1	Refresh	8
8.2	Refresh Cycles	8-1		
8.3	Periodic Refresh	8-1		
8.4	Stop-State Refresh	8-1		

Table of Contents (Continued)

External Interface

9

9.1	Introduction	9-1
9.2	Bus Operations	9-1
9.3	CPU Pins	9-2
	Transaction Pins	9-2
	Bus Control Pins	9-2
	Interrupt/Trap Pins	9-2
	Multi-Micro Pins	9-3
	CPU Control	9-3
9.4	Transactions	9-3
	WAIT	9-4
	Memory Transactions	9-4
	I/O Transactions	9-6
	EPU Transfer Transactions	9-7
	Interrupt/Trap Acknowledge Transactions	9-8
	Internal Operations and Refresh Transactions	9-8
9.5	CPU and Extended Processing Unit Interaction	9-10
9.6	Requests	9-10
	Interrupt/Trap Request	9-11
	Bus Request	9-11
	Resource Request	9-12
	Stop Request	9-12
9.7	Reset	9-13

Hardware Information	A-1
----------------------------	-----

Appendix

A

Z8000 Family Specifications	B-1
-----------------------------------	-----

Appendix

B

Programmers Quick Reference	C-1
-----------------------------------	-----

Appendix

C

Glossary of Terms	D-1
-------------------------	-----

Appendix

D



Zilog
Zilog
Zilog
Zilog
Zilog

Chapter 1

Z8000 Processor Overview

1.1 Introduction

This chapter provides a summary description of the advanced architecture of the Z8000 Microprocessor, with special attention given to those architectural features that set the Z8000 CPU apart from its predecessors. A complete

overview of the architecture is provided in Chapter 2, with detailed descriptions of the various aspects of the processor provided in succeeding chapters.

1.2 General Organization

Zilog's Z8000 microprocessor has been designed to accommodate a wide range of applications, from the relatively simple to the large and complex. The Z8000 CPU is offered in two versions: the Z8001 and the Z8002. Each CPU comes with an entire family of support components: a memory management unit, a DMA controller, serial and parallel I/O controllers, and extended processing units—all compatible with Zilog's Z-Bus. Together with other Z8000 Family components, the advanced CPU architecture provides in an LSI microprocessor design the flexibility and sophisticated features usually associated with mini- or mainframe computers.

The major architectural features of the Z8000 CPU that enhance throughput and processing power are a general purpose register file, system and normal modes of operation, multiple addressing spaces, a powerful instruction set, numerous addressing modes, multiple stacks, sophisticated interrupt structure, a rich set of data types, separate I/O address spaces and, for the Z8001, a large address space and segmented memory addressing. Each of these features is treated in detail in the next section.

These architectural features combine to produce a powerful, versatile microprocessor. The

benefits that result from these features are code density, compiler efficiency, support for typical operating system operations, and complex data structures. These topics are treated in Section 1.3.

The CPU has been designed so that a powerful memory management system can be used to improve the utilization of the main memory and provide protection capabilities for the system. This is discussed in Section 1.3.12. Although memory management is an optional capability—the Z8000 CPU is an extremely sophisticated processor without memory management—the CPU has explicit features to facilitate integrating an external memory management device into a Z8000 system configuration.

Finally, care has been taken to provide a very general mechanism for extending the basic instruction set through the use of external devices (called Extended Processing Units—EPUs). In general, an EPU is dedicated to performing complex and time-consuming tasks so as to unburden the CPU. Typical tasks for specialized EPUs include floating-point arithmetic, data base search and maintenance operations, network interfaces, and many others. This topic is treated in Section 1.5.

1.3 Architectural Features

The architectural resources of the Z8000 CPU include sixteen 16-bit general-purpose registers, seven data types ranging from bits to 32-bit long words and byte strings, eight user-selectable addressing modes, and an instruction set more powerful than that of most mini-computers. The 110 distinct instruction types combine with the various data types and addressing modes to form a rich set of 414 instructions. Moreover, the set exhibits a high degree of regularity: more than 90% of the instructions can use any of five main addressing modes, with 8-bit byte, 16-bit word, and 32-bit long-word data types.

The CPU generates status signals indicating the nature of the bus transaction that is being attempted; these can be used to implement sophisticated systems with multiple address spaces—memory areas dedicated to specific

uses. The CPU also has two operating modes, system and normal, which can be used to separate operating system functions from normal applications processes. I/O operations have been separated from memory accesses, further enhancing the capability and integrity of Z8000-based systems, and a sophisticated interrupt structure facilitates the efficient operation of peripheral I/O devices. Moreover, the Extended Processing Unit (EPU) capability of the Z8000 allows the CPU to unload many time-consuming tasks onto external devices.

Special features of the Z8000 have been introduced to facilitate the implementation of multiple processor systems. In addition, the Z8001 CPU has a large, segmented addressing capability that greatly extends the applicability of microprocessors to large system applications.

1.3.1 General-Purpose Register File. The heart of the Z8000 CPU architecture is a file of sixteen 16-bit general-purpose registers. These general-purpose registers give the Z8000 its power and flexibility and add to its regular instruction structure.

General-purpose registers can be used as accumulators, memory pointers or index registers. Their major advantage is that the particular use to which they are put can vary during the course of a program as the needs of the program change. Thus, the general-purpose register file avoids the critical bottlenecks of an implied or dedicated register architecture, which must save and restore the contents of dedicated registers when more registers of a particular type are needed than are supplied by the processor.

The Z8000 CPU register file can be addressed in several ways: as 16 byte registers (occupying ~~the upper~~^{ONE} half of the file) or as 16 word registers or, by using the register pairing mechanism, as eight long-word (32-bit) registers or as four quadruple-word (64-bit) registers. Because of this register flexibility, it is not necessary (for example) for a Z8000 user to dedicate a 32-bit register to hold a byte of data. Registers can be used efficiently in the Z8000.

1.3.2 Instruction Set. A powerful instruction set is one of the distinguishing characteristics of the Z8000. The instruction set is one measure of the flexibility and versatility of a computer. Having a given operation implemented in hardware saves memory and improves speed. In addition, completeness of the operations available on a particular data type is frequently more important than additional, esoteric instructions, which are unlikely to affect performance significantly. The Z8000 CPU provides a full complement of arithmetic, logical, branch, I/O, shift, rotate, and string instructions. In addition, special instructions have been included to facilitate multiprocessing, multiple processor configurations, and typical high level language and operating system functions. The general philosophy of the instruction set is two-operand register-memory operations, which include as a special subset register-register operations. However, to improve code density, a few memory-memory operations are used for string manipulation. The two-address format reflects the most frequently occurring operations (such as $A \leftarrow A + B$). Also, having one of the operands in a rapidly accessible general-purpose register facilitates the use of intermediate results generated during a calculation.

The majority of operations deal with byte, word, or long-word operands, thereby providing a high degree of regularity. Also included in the instruction set are compact, one-word instructions for the most frequently used operations, such as branching short distances in a program.

The instruction set contains some notable additions to the standard repertoire of earlier microprocessors. The Load and Exchange group of instructions has been expanded to support operating system functions and conversion of existing microprocessor programs. The usual arithmetic instructions can now deal with higher-precision operands, while hardware multiply and divide instructions have also been added. The Bit Manipulation instructions can use calculated values to specify the bit position within a byte or word as well as to specify the position statically in the instruction. The Rotate and Shift instructions are considerably more flexible than those in previous microprocessors. The String instructions are useful in translating between different character codes. Multiple-processor configurations are supported by special instructions.

1.3.3 Data Types. Many data types are supported by the Z8000 architecture. A data type is supported when it has a hardware representation and instructions which directly apply to it. New data types can always be simulated in terms of basic data types, but hardware support provides faster and more convenient operations. The basic data type is the byte, which is also the basic addressable element. The architecture also supports the following data types: words (16 bits), long words (32 bits), byte strings, and word strings. In addition, bits are fully supported and addressed by number within a byte or word. BCD digits are supported and represented as two 4-bit digits in a byte. Arrays are supported by the Indexed addressing mode (see 1.3.4 and Chapter 5). Stacks are supported by the instruction set and by an external device (the Memory Management Unit, MMU) available with the Z8001.

1.3.4 Addressing Modes. The addressing mode, which is the way an operand is specified in an instruction, determines how an address is generated. The Z8000 CPU offers eight addressing modes. Together with the large number of instructions and data types, they improve the processing power of the CPU. The addressing modes are Register, Immediate, Indirect Register, Direct Address, Index, Relative Address, Base Address, and Base Index. Several other addressing modes are implied by specific instructions, including autoincrement. The first five modes listed

above are basic addressing modes that are used most frequently and apply to most instructions having more than one addressing mode. (In the Z8002, Base Address and Index modes are identical, and in the Z8001, Base Addressing capabilities are made available to all instructions, using the Memory Management Unit AND THE DIRECT OR INDEXED ADDRESSING MODE.)

1.3.5 Multiple Memory Address Spaces. The Z8000 CPU facilitates the use of multiple address spaces. When the Z8000 CPU generates an address, it also outputs signals indicating the particular internal activity which led to the memory request: instruction fetch, operand reference, or stack reference. This information can be used in two ways: to increase the memory space available to the processor (for example, by putting programs in one space and data in another); or to protect portions of the memory and allow only certain types of accesses (for example, by allowing only instruction fetches from an area designated to contain proprietary software). The Memory Management Unit (MMU) has been designed to provide precisely these kinds of protection features by using the CPU-generated status information.

1.3.6 System/Normal Mode of Operation. The Z8000 CPU can run in either system mode or normal mode. In system mode, all of the instructions can be executed and all of the CPU registers can be accessed. This mode is intended for use by programs performing operating system functions. In normal mode, some instructions may not be executed (e.g., I/O operations), and the control registers of the CPU are inaccessible. In general, this mode of operation is intended for use by application programs. This separation of CPU resources promotes the integrity of the system, since programs operating in normal mode cannot access those aspects of the CPU which deal with time dependent or system-interface events.

Programs executing in normal mode which have errors can always reproduce those errors for debugging purposes simply by re-executing the program with its original data. Programs using facilities available only in system mode may have errors due to timing considerations (e.g. based upon the frequency of disk requests and disk arm-position) that are harder to debug because these errors are not easily reproduced. Thus, the preferred method of program development is to partition the task into a portion which can be performed without those resources accessible only in system mode (which will usually be the bulk of the task) and a portion requiring system mode resources. The classic example of this partitioning comes from current minicomputer and mainframe systems: the operating system runs in system

mode and the individual users write their programs to run in normal mode.

To further support the system/normal mode dichotomy, there are two copies of the stack pointer—one for a system mode stack and another for a normal mode stack. These two stacks facilitate the task switching involved when interrupts or traps occur. To insure that the normal stack is free of system information, the information saved on the occurrence of interrupts or traps is always pushed on the system stack before the new program status is loaded.

1.3.7 Separate I/O Address Spaces. The Z8000 Architecture distinguishes between memory and I/O spaces and thus requires specific I/O instructions. This architectural separation allows better protection and has more potential for extension. The use of separate I/O spaces also conserves the limited Z8002 data memory space. There are in fact two separate I/O address spaces: standard I/O and special I/O. The main advantage of these two spaces is to provide for two types of peripheral support chips—standard I/O peripherals and special I/O peripherals—devices such as the Z8010 Memory Management Unit that do not respond to standard I/O commands, but do respond to special I/O commands. A second advantage of these two spaces is that they allow 8-bit peripherals to attach to the low-order eight bits (standard I/O) or to the high-order eight bits (special I/O) of the processor Address/Data bus.

The increased speed requirements of future microprocessors are likely to be achieved by tailoring memory and I/O references to their respective, characteristic reference patterns and by using simultaneous I/O and memory referencing. These future possibilities require an architectural separation today. Memory-mapped I/O is still possible, but loss of protection and lack of expandability are severe problems.

1.3.8 Interrupt Structure. The sophisticated interrupt structure of the Z8000 allows the processor to continue performing useful work while waiting for peripheral events to occur. The elimination of periodic polling and idling loops (typically used to determine when a device is ready to transmit data) increases the throughput of the system. The CPU supports three types of interrupts. A non-maskable interrupt represents a catastrophic event which requires immediate handling to preserve system integrity. In addition, there are two types of maskable interrupts: non-vectorized interrupts and vectored interrupts. The latter provides an automatic call to interrupt processing routines ^{SEPARATE} depending on the vector presented by the peripheral to the Z8000. _{FOR EACH FOR EACH PERIPHERAL}

The Z8000 has implemented a priority system for handling interrupts. Vectored interrupts have higher priority than non-vectored interrupts. This priority scheme allows the efficient control of many peripheral devices in a Z8000 system.

An interrupt causes information relating to the currently executing program (program status) to be saved on a special system stack with a code describing the reason for the switch. This allows recursive task switches to occur while leaving the normal stack undisturbed by system information. The state program to handle the interrupt (new program status) is loaded from a special area in memory, the program status area, designated by a pointer resident in the CPU.

The use of the stack and of a pointer to the program status area is a specific choice made to allow architectural compatibility if new interrupts or traps are added to the architecture.

1.3.9 Multi-Processing. The increase in microprocessor computing power that the Z8000 represents makes simple the design of distributed processing systems having many low-cost microprocessors running dedicated processes.

The Z8000 provides some basic mechanisms that allow the sharing of address spaces among different microprocessors. Large segmented address spaces and the support for external memory management make this possible. Also, a resource request bus is provided which, in conjunction with software, provides the exclusive use of shared critical resources. These mechanisms, and new peripherals such as the Z-FIO, have been designed to allow easy asynchronous communication between different CPUs.

1.3.10 Large Address Space for the Z8001.

For many applications, a basic address space of 64K bytes is insufficient. A large address space increases the range of applications of a system by permitting large, complex programs and data sets to reside in memory rather than be partitioned and swapped into a small memory as needed. A large address space greatly simplifies program and data management. In addition, large address spaces and memories reduce the need for minimizing program size and permit the use of higher level languages. The segmented version of the Z8000 generates 23-bit addresses, for a basic address space of 8 megabytes (8M or 8,388, 608 bytes).

1.3.11 Segmented Addressing of the Z8001.

The segmented version of the Z8000 CPU divides its 23-bit addresses into a 7-bit segment number and a 16-bit segment offset. The segment number serves as a logical name of a segment; it is not altered by the effective

address calculation (by indexing, for example). This corresponds to the way memory is typically used by a program—one portion of the memory is set aside to hold instructions, another for data. In a segmented address space, the instructions could reside in one segment (or several different modules in different segments), and each data set could reside in a separate segment. One advantage of segmentation is that it speeds up address calculation and relocation. Thus, segmentation allows the use of slower memories than linear addressing schemes allow. In addition, segments provide a convenient way of partitioning memory so that each partition is given particular access attributes (for example, read-only). The Z8000 approach to segmentation (simultaneous access to a large number of segments) is necessary if all the advantages of segmentation are to be realized. A system capable of directly accessing only, say, four segments would lack the needed flexibility and would be constrained by address space limitations.

1.3.12 Memory Management. Memory management consists primarily of dynamic relocation, protection, and sharing of memory. It offers the following advantages: providing a logical structure to the memory space that is independent of the actual physical location of data, protecting the user from inadvertent mistakes such as attempting to execute data, preventing unauthorized access to memory resources or data, and protecting the operation system from disruption by the users.

The address manipulated by the programmer, used by instructions, and output by the segmented Z8000 CPU are called logical addresses. The external memory management system takes the logical addresses and transforms them into physical addresses required for accessing the memory. This address transformation process is called relocation, which makes user software independent of the physical memory. Thus, the user is freed from specifying where information is actually located in the physical memory.

The segmented Z8000 CPU supports memory management both with segmented addressing and with program-status information. A segmented addressing space allows individual segments to be treated differently.

Program status information generated by the CPU permits an external memory management device to monitor the intended use of each memory access. Thus, illegal types of access can be suppressed and memory segments protected from unintended or unwanted modes of use. For example, system tables could be protected from direct user access. This added protection capability becomes more important as microprocessors are applied to large, complex tasks.

1.4 Benefits of the Architecture

The features of the Z8000 Architecture combine to provide several significant benefits: improvements in code density, compiler efficiency, operating system support, and support for high level data structures.

1.4.1 Code Density. Code density affects both processor speed and memory utilization. Code compaction saves memory space—an especially important factor in smaller systems—and improves processor speed by reducing the number of instruction words that must be fetched and decoded. The Z8000 offers several advantages with respect to code density. The most frequently used instructions are encoded in single-word formats. Fewer instructions are needed to accomplish a given task and a consistent and regular architecture further reduces the number of instructions required.

Code density is achieved in part by the use of special "short" formats for certain instructions which are shown by statistical analysis to be most frequently used by assemblers. A "short offset" mechanism has also been provided to allow a 2-word segmented address to be reduced to a single word; this format may be used by assemblers and compilers.

The largest reduction in program size and increase in speed results from the consistent and regular structure of the architecture and from the more powerful instruction set—factors that substantially reduce the number of instructions required for a task. The architecture is more regular relative to preceding microprocessors because its registers, address modes, and data types can be used in a more orderly fashion. Any general-purpose register can be specified as an accumulator, index register, or base register. With a few exceptions, all basic addressing modes can be used with all instructions, as can the various data types.

General-purpose registers do not have to be changed as often as registers dedicated to a specific purpose. This reduces program size, since frequent load and store operations are not required.

1.4.2 Compiler Efficiency. For microprocessor users, the transition from assembly language to high-level languages allows greater freedom from architectural dependency and improves ease of programming. However, rather than adapt the architecture to a particular high-level language, the Z8000 was designed as a general-purpose microprocessor. (Tailoring a processor for efficiency in one language often leads to inefficiency in unrelated languages.) For the Z8000, language support has been provided through the inclusion of features designed to minimize typical compilation and code-generation problems. Among these features is the regularity of the Z8000 address-

ing modes and data types. Access to parameters and local variables on the procedure stack is supported by the "Index With Short Offset" addressing mode, as well as the Base Address and Base Index addressing modes. In addition, address arithmetic is aided by the Increment and Decrement instructions.

Testing of data, logical evaluation, initialization, and comparison of data are made possible by the instructions Test, Test Condition Codes, Load Immediate Into Memory, and Compare Immediate With Memory. Since compilers and assemblers frequently manipulate character strings, the instructions Translate, Translate And Test, Block Compare, and Compare String all result in dramatic speed improvements over software simulations of these important tasks. In addition, any register except zero can be used as a stack pointer by the Push and Pop instructions.

1.4.3 Operating System Support. Interrupt and task-switching features are included to improve operating system implementations. The memory-management and compiler-support features are also quite important.

The interrupt structure has three levels: non-maskable, non-vectored, and vectored. When an interrupt occurs, the program status is saved on the stack with an indication of the reason for this state-switching before a new program status is loaded from a special area of memory. The program status consists of the flag register, the control bits, and the program counter. The reason for the occurrence is encoded in a vector that is read from the system bus and saved on the stack. In the case of a vectored interrupt, the vector also determines a jump table address that points to the interrupt processing routine.

The inclusion of system and normal modes improves operating system organization. In the system mode, all operations are allowed; in the normal mode, certain system instructions are prohibited. The System Call instruction allows a controlled switch of mode, and the implementation of traps enforces these restrictions.

Traps result in the same type of program status-saving as interrupts: in both cases, the information saved is pushed on to a system stack that keeps the normal stack undisturbed. The Load Multiple instruction allows the contents of registers to be saved efficiently in memory or on the stack. Running programs can cause program status changes under direct software control with the Load Program Status instruction.

Finally, exclusion and serialization can be achieved with the "atomic" Test And Set instruction that synchronizes asynchronous cooperating processes.

EXCEPT R0 →

1.4.4 Support for Many Types of Data Structures. A data structure is a logical organization of primitive elements (byte, word, etc.) whose format and access conventions are well-defined. Common data structures include arrays, lists, stacks, and strings. Since data structures are high-level constructs frequently used in programming, processor performance is significantly enhanced if the CPU provides mechanisms for efficiently manipulating them. The Z8000 offers such mechanisms.

In many applications, one of the most frequently encountered data structures is the array. Arrays are supported in the Z8000 by the Base Index addressing mode and by segmented addressing. The Base Index addressing mode allows the use of pointers into an array (i.e., offsets from the array's starting address). Segmented addressing allows an array to be assigned to one segment, which can be referenced simply by segment number.

Lists occur more frequently than arrays in business applications and in general data processing. Lists are supported by Indirect Register and Base Address addressing modes. The Base Index addressing mode is also useful for more complex lists.

Stacks are used in all applications for nesting of routines, block structured languages, and interrupt handling. Stacks are supported by the Push and Pop instructions, and multiple stacks may be implemented based on the general-purpose registers of the Z8000. In

addition, two hardware stack pointers are used to assign separate stacks to system and normal operating modes, thereby further supporting the separation of system and normal operating environments discussed earlier.

Byte and word strings are supported by the Translate and Translate And Test instructions. Decimal strings use the Decimal Adjust instruction to do decimal arithmetic on strings of BCD data, packed two characters per byte. The Rotate Digit instructions also manipulate 4-bit data.

1.4.5 Two CPU Versions: Z8001 and Z8002.

The Z8000 CPU is offered in two versions: the Z8001 48-pin segmented CPU and the Z8002 40-pin nonsegmented CPU. The main difference between the two is addressing range. The Z8001 can directly address 8M bytes of memory; the Z8002 directly addresses 64K bytes. The Z8001 has a non-segmented mode of operation which permits it to execute programs written for the Z8002.

Not all applications require the large address space of the Z8001; for these applications the Z8002 is recommended. Moreover, many multiple-processor systems can be implemented with one Z8001 and several Z8002s, instead of exclusively using Z8001s. Since the same assembler generates code for both CPUs, users can buy only the power they require without having to worry about software incompatibility between processors.

1.5 Extended Instruction Facility

The Z8000 architecture has a mechanism for extending the basic instruction set through the use of external devices. Special opcodes have been set aside to implement this feature. When the CPU encounters an instruction with these opcodes in its instruction stream, it will perform any indicated address calculation and data transfer; otherwise, it will treat the "extended instruction" as being executed by the external device. Fields have been set aside in these extended instructions which can be interpreted by external devices (Extended Pro-

cessing Units—EPU(s) as opcodes. Thus, by using appropriate EPU(s), the instruction set of the Z8000 can be extended to include specialized instructions.

In general, an EPU is dedicated to performing complex and time-consuming tasks in order to unburden the CPU. Typical tasks suitable for specialized EPU(s) include floating-point arithmetic, data base search and maintenance operations, network interfaces, graphics support operations—a complete list would include most areas of computing.

1.6 Summary

The architectural sophistication of the Z8000 microprocessor is on a level comparable with that of the minicomputer. Features such as large address spaces, multiple memory spaces, segmented addresses, and support for multiple processors are beyond the capabilities of the traditional minicomputer. The benefits of this

MICROPROCESSOR

architecture—code density, compiler support, and operating system support—greatly enhance the power and versatility of the CPU. The CPU features that support an external memory management system also enhance the CPU's applicability to large system environments.

Zilog
Zilog
Zilog
Zilog
Zilog

Chapter 2 Architecture

2.1 Introduction

This chapter provides an overview of the Z8000 CPU architecture. The basic hardware, operating modes and instruction set are all described. Differences between the two versions of the Z8000 (the nonsegmented Z8002

and the segmented Z8001) are noted where appropriate. Most of the subjects covered here are also treated with greater detail in later chapters of the manual.

2.2 General Organization

Figure 2.1 contains a block diagram that shows the major elements of the Z8000 CPU, namely:

- A 16-bit internal data bus, which is used to move address and data within the CPU.
- A Z-Bus interface, which controls the interaction of the CPU with the outside world.
- A set of 16 general-purpose registers, which is used to contain addresses and data.
- Four special-purpose registers, which control the CPU operation.
- An Arithmetic and Logic Unit, which is used for manipulating data and generating addresses.
- An instruction execution control, which fetches and executes Z8000 instructions.

- An exception-handling control, which processes interrupts and traps.
- A refresh control, which generates memory refresh cycles.

Each of these elements is explained in the following sections. All of the elements are common to both the Z8001 CPU and the Z8002 CPU. The differences between the two versions of the Z8000 are derived from the number of bits in the addresses they generate. The Z8002 always generates a 16-bit linear address, while the Z8001 always generates a 23-bit segmented address (that is, an address composed of a 7-bit segment number and a 16-bit offset).

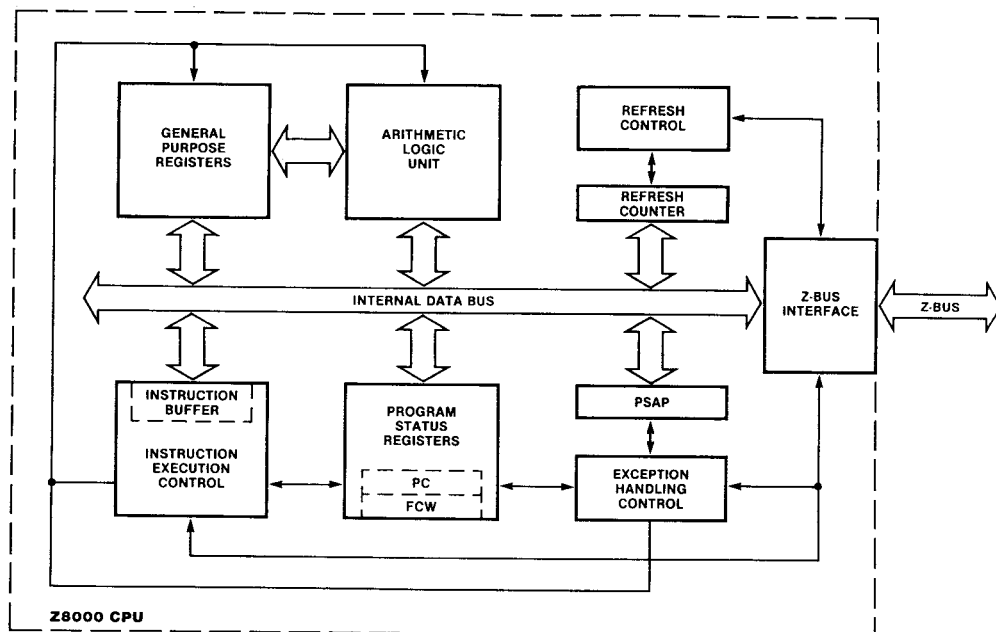

Figure 2-1. Z8000 CPU Functional Block Diagram

2.2 General Organization
(Continued)

Figure 2.2 gives a system-level view of the Z8000. It is important to realize that the Z8000 CPU comes with a whole family of support components. The Z8000 Family has been designed to allow the easy implementation of powerful systems. The major elements of such a system might include:

- The Z-Bus, a multiplexed address/data shared bus that links the components of the system.
- A Z8001 or Z8002 CPU.
- One or more Extended Processing Units (EPUs), which are dedicated to performing specialized, time-consuming tasks.
- A memory sub-system, which in Z8001 systems can include one or more Memory

Management Units (MMUs) that offer sophisticated memory allocation and protection features.

- One or more Direct Memory Access (DMA) controllers for high-speed data transfers.
- A large number of possible peripheral devices interfaced to the Z-Bus through Universal Peripheral Controllers (UPCs), Serial Communication Controllers (SCCs), Counter-Timer and Parallel I/O Controllers (CIOs) or other Z-Bus peripheral controllers.
- One or more FIFO I/O Interface Units (FIOs) for elastic buffering between the CPU and another device, such as another CPU in a distributed processing system.

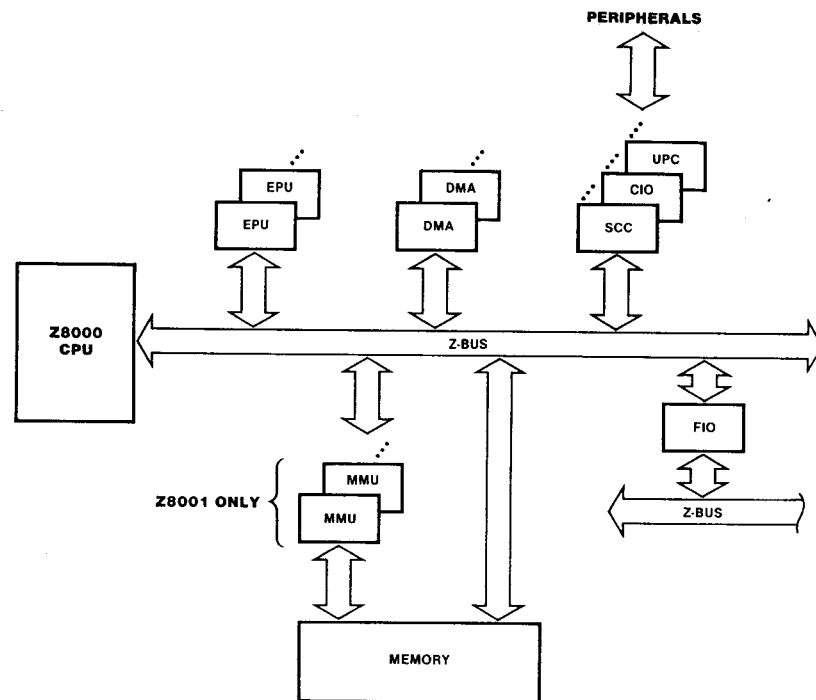

Figure 2-2. Z8000 System Configuration

2.3 Hardware Interface

Figure 2.3 shows the Z8000 pins grouped according to function. The Z8001 is packaged in a 48-pin DIP and the Z8002 is packaged in a 40-pin DIP. The eight additional pins on the Z8001 are the seven segment-number lines and the segment trap. Except for those eight, all pins on the two CPU versions are identical.

The Z8000 is a Z-Bus CPU; thus, activity on the pins is governed by the Z-Bus protocols (see *The Z-Bus Summary*). These protocols specify two types of activities: *transactions*, which cover all data movement (such as memory references or I/O operations), and *requests*, which cover interrupts and requests for bus or resource control. The following is a brief overview of the Z8000 pin functions; complete descriptions are found in Chapter 9.

2.3.1 Address/Data Lines. These 16 lines alternately carry addresses and data. The addresses may be those of memory locations or I/O ports. The bus timing signal lines described below indicate what kind of information the Address/Data lines are carrying.

2.3.2 Segment Number (Z8001 only). These seven lines encode the address of up to 128 relocatable memory segments. The segment signals become valid before the address offset signals, thus supporting address relocation by the memory management system.

2.3.3 Bus Timing. These three lines include Address Strobe (AS), Data Strobe (DS) and Memory Request (MREQ). They are used to signal the beginning of a bus transaction and

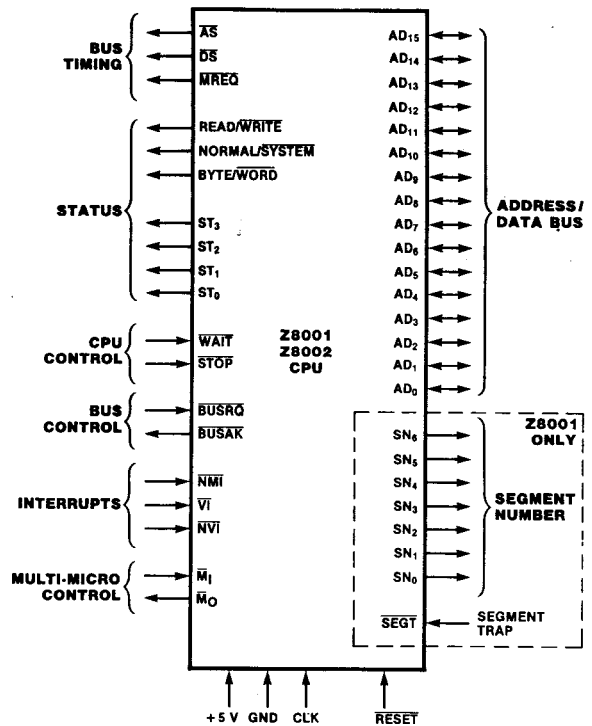

Figure 2-3. Z8000 Pin Functions

to determine when the multiplexed Address/Data Bus holds addresses or data. The Memory Request signal can be used to time control signals to a memory system.

ST ₃ -ST ₀	Definition
0 0 0 0	Internal operation
0 0 0 1	Memory refresh
0 0 1 0	I/O reference
0 0 1 1	Special I/O reference
0 1 0 0	Segment trap acknowledge
0 1 0 1	Non-maskable interrupt acknowledge
0 1 1 0	Non-vectored interrupt acknowledge
0 1 1 1	Vectored interrupt acknowledge
1 0 0 0	Data memory request
1 0 0 1	Stack memory request
1 0 1 0	Data memory request (EPU)
1 0 1 1	Stack memory request (EPU)
1 1 0 0	Instruction space access
1 1 0 1	Instruction fetch, first word
1 1 1 0	EPA Transfer
1 1 1 1	Reserved

Table 2.1 Status Line Codes

2.3.4 Status. These lines function to indicate the kind of transaction on the bus (ST₀-ST₃), whether it is a read or write (R/ \bar{W} , where High is Read and Low is Write), whether it is on byte or word data (B/ \bar{W} , High = byte, Low = word), and whether the CPU is operating in normal mode or system mode (N/ \bar{S} , High = normal, Low = system). The ST₀-ST₃ lines also encode additional characteristics of the bus transactions, as Table 2.1 shows. The availability of status information defining the type of bus transaction in advance of data transmission allows bidirectional drivers and other external hardware elements to be enabled before data is transferred.

2.3 Hardware Interface

(Continued)

(OR THE SECOND WORD OF AN EPA INSTRUCTION)

2.3.5 CPU Control. These inputs allow external devices to delay the operation of the CPU. The $\overline{\text{WAIT}}$ line, when active (Low), causes the CPU to idle in the middle of a bus transaction, taking extra clock cycles until the $\overline{\text{WAIT}}$ line goes inactive; it is typically input by memory or I/O peripherals which operate more slowly than the CPU. The Stop ($\overline{\text{STOP}}$) line halts internal CPU operation when the first word of an instruction has been fetched. This signal is useful for single-step instruction execution during debugging operations and for enabling Extended Processing Units to halt the CPU temporarily.

2.3.6 Bus Control. These lines provide the means for other devices, such as direct memory access (DMA) controllers, to gain exclusive use of the system bus, i.e., the signal lines that are common to several devices in a system. The external device requesting control of the bus inputs a bus request ($\overline{\text{BUSREQ}}$); the CPU responds with a bus acknowledge ($\overline{\text{BUSACK}}$) after three-starting, or electrically neutralizing, the Address/Data Bus, Bus Timing lines, Status lines, and Control lines. The Z-Bus allows a daisy chain to be used to

enforce a priority among several external devices.

2.3.7 Interrupts. Three interrupt inputs are provided: non-maskable interrupts ($\overline{\text{NMI}}$), vectored interrupts ($\overline{\text{VI}}$) and non-vectored interrupts ($\overline{\text{NVI}}$). These permit external devices to suspend the CPU's execution of its current program and begin executing an interrupt service routine.

2.3.8 Segment Trap Request (Z8001 only).

This input to the CPU is used by an external memory-management system to indicate that an illegal memory access has been attempted.

2.3.9 Multi-Micro Control. The Multi-Micro In ($\overline{\text{MI}}$) and Multi-Micro Out ($\overline{\text{MO}}$) lines are used in conjunction with instructions such as MSET and MREQ to coordinate multiple-CPU systems. They allow exclusive use by one CPU of a shared resource in a multiple-CPU system.

2.3.10 System Inputs. The four inputs shown at the bottom of Figure 3 include +5 V power, ground, a single-phase clock signal and a CPU reset. The reset function is described in Chapter 7.

2.4 Timing

Figure 2.4 shows the three basic timing periods of the Z8000: a clock cycle, a bus transaction, and a machine cycle. A *clock cycle* (sometimes called a T-state) is one cycle of the CPU clock, starting with a rising edge. A *bus transaction* covers a single data movement on the CPU bus and will last for three or more clock cycles, starting with a falling edge

of $\overline{\text{AS}}$ and ending with a rising edge of $\overline{\text{DS}}$. A *machine cycle* covers one basic CPU operation and always starts with a bus transaction. A machine cycle can extend beyond the end of a transaction by an unlimited number of clock cycles. Appendix A contains a complete description of Z8000 timing.

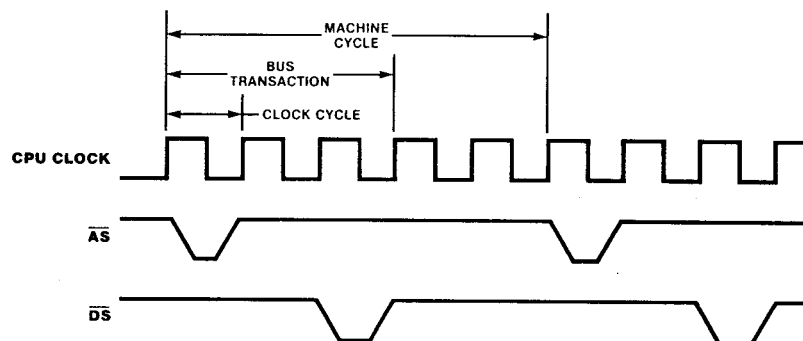

Figure 2-4. Basic Timing Periods

2.5 Address Spaces

The Z8000 supports two main address spaces corresponding to the two different kinds of locations that can be addressed:

- **Memory Address Space.** This consists of the addresses of all locations in the main memory of the computer system.
- **I/O Address Space.** This consists of the addresses of all I/O ports through which peripheral devices are accessed.

For more information on address spaces, consult Chapter 3.

2.5.1 Memory Address Space. Memory address space can be further subdivided into Program Memory address space, Data Memory address space, and Stack Memory address space, each for both normal and system modes.

The particular space addressed is determined by the external circuitry from the code appearing at the CPU's output status pins (ST_0 – ST_3) and the state of the Normal/System signal ($\overline{\text{N/S}}$ pin). Data memory reference, stack memory reference, and program memory

2.5 Address Spaces (Continued)

reference each correspond to a different status code at the ST₀-ST₃ outputs, allowing three address spaces to be distinguished for each of two operating modes, giving six address spaces in all. Each of the six address spaces has a range as great as the addressing ability of the processor. For the nonsegmented Z8002, each address space can have up to 64K bytes, giving a potential total system capacity of 384K bytes of directly addressable memory. The segmented Z8001, on the other hand, provides up to 48M bytes of directly addressable memory due to the 23-bit segmented addresses.

Segmentation is a means of partitioning memory into variable-size segments so that a variety of useful functions may be permitted, including:

- Protection mechanisms that prevent a user from referencing data belonging to others, attempting to modify read-only data or overflowing a stack.
- Virtual memory, which permits a user to write functioning programs under the assumption that the system contains more memory than is actually available.
- Dynamic ^{RELOCATING,} relocation which allows the placement blocks of data in physical memory

independently of user addresses, allowing better management of the memory resources and sharing of data and programs.

The signals provided on the segmented Z8001 CPU assist in implementing these features, although additional software and external circuitry (such as the Z8010 MMU) is generally required to take full advantage of them. Chapter 3 contains an extensive discussion of segmentation and the Z8001.

2.5.2 I/O Address Space. I/O addresses are represented as 16-bit words for both the Z8001 and Z8002.

There are two I/O address spaces, Standard I/O and Special I/O, which are both separate from the memory address space. Each I/O space is accessed through a separate set of I/O instructions, which can be executed only when the CPU is operating in system mode.

Standard I/O instructions transfer data between the CPU and peripherals and Special I/O instructions transfer data to or from external CPU support circuits such as the Z8010 MMU. Access to Standard or Special I/O space is distinguished by the status lines (ST₀-ST₃).

2.6 General-Purpose Registers

The Z8000 CPU contains 16 general-purpose registers, each 16 bits wide. Any general-purpose register can be used for any instruction operand (except for minor exceptions described at the beginning of Chapter 5).

Figure 2.5 shows these general-purpose registers. They allow data formats ranging from bytes to quadruple words. The word registers are specified in assembly-language statements as R0 through R15. Sixteen byte registers, RH0-RL7, which may be used as accumulators, overlap the first eight word registers. Register grouping for larger operands include eight double-word (32-bit) registers, RR0-RR14, AND ^{FOUR QUAD} word registers: ^{WORD REGISTER:} RQ0-RQ12, which are used by a few instructions such as Multiply, Divide, and Extend Sign.

As Figure 2.5 illustrates, the CPU has two hardware stack pointers, one dedicated to each of the two basic operating modes, system and

As Figure 2.5 illustrates, the CPU has two hardware stack pointers, one dedicated to each of the two basic operating modes, system and

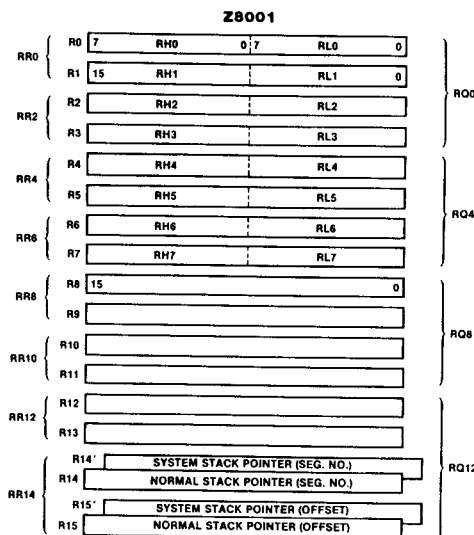

Figure 2-5a. Z8001 General-Purpose Registers
(Register Address Space)

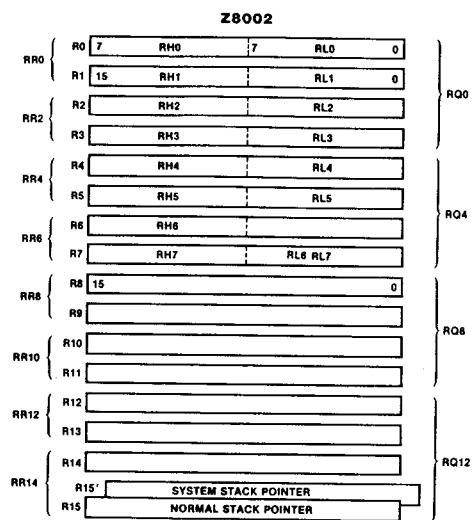

Figure 2-5b. Z8002 General-Purpose Registers
(Registers Address Space)

2.6 General-Purpose Registers
(Continued)

normal. The segmented Z8001 uses a two-word stack pointer for each mode (R14'/R15' or R14/R15), whereas the nonsegmented Z8002 uses only one word for each mode (R15' or R15).

The system stack pointer is used for saving status information when an interrupt or trap occurs and for supporting calls in system

IN SYSTEM MODE, THE NORMAL

mode. The normal stack pointer is used for subroutine calls in user programs. In normal-mode operation only the normal stack pointer is accessible. In system-mode operation, the system stack pointer is directly accessible as one of the general-purpose registers. The user stack pointer can be accessed as a special control register.

2.7 Special-Purpose Registers

In addition to the general-purpose registers, there are special-purpose registers. These include the Program Status registers, the Program Status Area Pointer, and the Refresh Counter; they are illustrated for both CPU versions in Figure 2.6. Each register can be manipulated in software executing in system mode, and some are modified automatically by certain operations.

2.7.1 Program Status Registers. These registers include the Flag and Control Word (FCW) and the Program Counter (PC). They are used to keep track of the state of an executing program.

In the nonsegmented Z8002, the Program Status registers consist of two words: one each for the FCW and the PC. In the segmented Z8001, there are four words: one reserved word, one word for the FCW and two words for the segmented PC.

The low-order byte of the Flag and Control Word (FCW) contains the six status flags, from which the condition codes used for control of program looping and branching are derived. The six flags are:

Carry (C), which generally indicates a carry out of the high-order bit position of a register being used as an accumulator.

Zero (Z), which is generally used to indicate that the result of an operation is zero.

Sign (S), which is generally used to indicate that the result of an operation is a negative number.

Parity/Overflow (P/V), which is generally used to indicate either parity (after logical operations on byte operands) or overflow (after arithmetic operation).

Decimal-Adjust (D), which is used in BCD arithmetic to indicate the type of instruction that was executed (addition or subtraction).

Half Carry (H), which is used to convert the binary result of a previous decimal addition or subtraction into the correct decimal (BCD) result.

Section 6.3 provides more detail on these flags.

The control bits, which occupy the high-order byte of the FCW, are used to enable various interrupts or to control CPU operating modes. The control bits are:

Non-Vectored Interrupt Enable (NVIE), Vectored Interrupt Enable (VIE). These bits determine whether or not the CPU will accept non-vector or vectored interrupts (see Section 2.13).

System/Normal Mode (S/N). When this bit is set to one, the CPU is operating in system mode; when cleared to zero, the CPU is in normal mode (see Section 2.8). The CPU output status line (N/S pin) is the complement of this bit.

Extended Processor Architecture (EPA) Mode. When this bit is set to one, it indicates that the system contains Extended Processing Units, and hence extended instructions

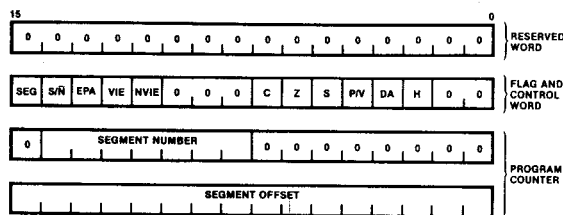

Z8001 Program Status Registers

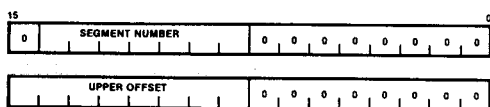

Z8001 Program Status Area Pointer

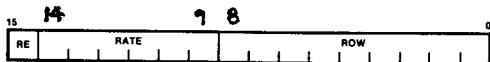

Z8001 Refresh Counter

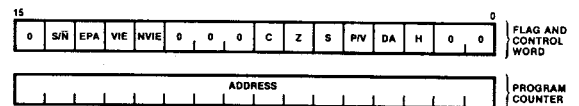

Z8002 Program Status Registers

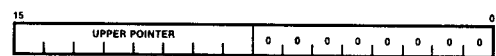

Z8002 Program Status Area Pointer

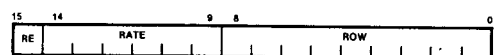

Z8002 Refresh Counter

Figure 2-6. CPU Special Registers

2.7 Special Purpose Registers (Continued)

encountered in the CPU instruction stream are executed (see Section 2.12). When this bit is cleared to zero, extended instructions are trapped for software emulation.

Segmentation Mode (SEG). This bit is implemented only in the Z8001; it is always cleared in the nonsegmented Z8002. When set to one, the CPU is operating in segmented mode, and when cleared to zero, the CPU is operating in nonsegmented mode (see Section 2.8).

2.7.2 Program Status Area Pointer (PSAP). The Program Status Area Pointer points to an array of program status values (FCW and PC) in main memory called the Program Status Area. ~~✗~~ New Program Status reg-

ister values^{ARE} fetched from this area when an interrupt or trap occurs. As shown in Figure 2.6, the PSAP comprises either one word (nonsegmented Z8002) or two words (segmented Z8001); for either configuration, the lower byte of the pointer must be zero. Refer to Chapter 7 for more details about the Program Status Area and its layout.

2.7.3 Refresh Counter. The CPU contains a programmable counter that can be used to refresh dynamic memory automatically. The refresh counter register consists of a 9-bit row counter, a 6-bit rate counter and an enable bit (Figure 2.6). Refer to Chapter 8 for details of the refresh mechanism.

2.8 Instruction Execution

In the normal course of events, the Z8000 CPU will spend most of its time fetching instructions from memory and executing them. This process is called the *running state* of the CPU. The CPU also has two other states that it occasionally enters.

Stop/Refresh State. This is really one state, although it may be entered in two different ways: either automatically for a periodic memory refresh; or when the $\overline{\text{STOP}}$ line is activated. In this state, program execution is temporarily suspended and the CPU makes use of the Refresh Counter to generate refreshes. For more information, consult Chapter 8.

Bus-Disconnect State. This is the state the CPU enters when the DMA, or some other bus requester, takes over the bus. Program execution is suspended and the CPU disconnects itself from the bus. See Chapter 7 for more information.

While the CPU is in the running state, it can either be handling interrupts or executing

instructions. If it is executing instructions, the Z8000 can be in the system or normal execution mode. In system mode, privileged instructions (such as those which perform I/O) can be executed; in normal mode they cannot. This dichotomy allows the creation of operating system software, which controls CPU resources and is protected from application program action.

In addition, the CPU will be in either segmented or nonsegmented mode. In segmented mode, which is available only on the Z8001, the program uses 23-bit segmented addresses for memory accesses; in nonsegmented mode, which is available on both CPUs, the program uses 16-bit nonsegmented addresses for memory accesses.

While executing instructions, the mode of the CPU is controlled by bits in the FCW (Section 2.8). While handling interrupts, the CPU is always in system mode and, for the Z8001, in segmented mode.

2.9 Instructions The Z8000 instruction set contains over 400 different instructions which are formed by combining the 110 distinct instruction types (opcodes) with the various data types and addressing modes. The complete set is divided into the following groups:

Load and Exchange for register-to-register and register-to-memory operations, including stack management.

Arithmetic for arithmetic operations, including multiply and divide, on data in either registers or memory. Compare, increment, and decrement functions are included.

Logical for Boolean operations on data in registers or memory.

Program Control for program branching (conditional or unconditional), calls, and returns.

Bit Manipulation for setting, resetting and testing individual bits of bytes or words in registers or memory.

Rotate and Shift for bytes, words, or for shifts only, long words, within registers.

Block Transfer and String Manipulation for automatic memory-to-memory transfers of data blocks or strings, including compare and translate functions.

Input/Output for transfers of data between I/O ports and memory or registers.

Extended for operations involving Extended Processing Units.

CPU Control for accessing special registers, controlling the CPU operating state, synchronizing multiple-processor operation, enabling/disabling interrupts, mode selection, and memory refresh.

Chapter 6 contains details on the full instruction set.

2.9 Instructions (Continued)

2.9.1 Instruction Formats. Formats of the instructions are shown in Figure 2.7. The two most significant bits in the instruction word determine whether the compact instruction format (A) or the general instruction format (B) is used. Compact formats encode the four most frequently used instructions into single words, thereby saving on instruction-memory usage and increasing execution speed. As long as the two most significant bits are not logic ones, the general format applies. In the general format, the two most significant bits in conjunction with the source-register field are sufficient for specifying any of the five main addressing modes. Source and destination fields are four bits wide for addressing the 16 general-purpose registers.

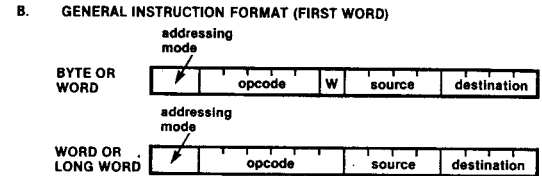
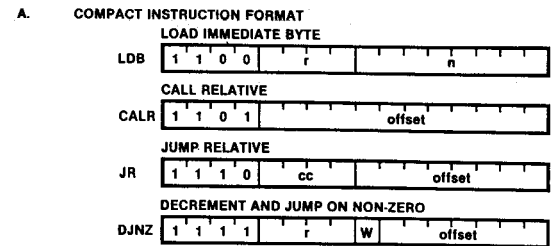

Note: W indicates Word (1) or Byte (0)

Figure 2-7. Instruction Formats

2.10 Data Types

The Z8000 supports manipulation of eight data types. Five of these have fixed lengths; the other three have lengths that can vary dynamically. Each data type is supported by a number of instructions which operate upon it directly. These data types are:

- Bit
- Signed and unsigned byte, word, long word, or quadruple word binary integer
- Byte- or word-length logical value
- Word (nonsegmented) or long word (segmented) address

- Unsigned byte decimal integer
- Dynamic-length string of byte data
- Dynamic-length string of word data
- Dynamic-length stack of word data

Bits can be manipulated in registers or memory. Binary and decimal integers and logical values can be manipulated in registers only, although operands can be fetched directly from memory. Addresses are manipulated and used only in registers, and strings and stacks ~~ARE~~ manipulated only in memory.

2.11 Addressing Modes

The information included in Z8000 instructions consists of the function to be performed, the type and size of data elements to be manipulated; and the location of the data elements. Locations are designated using one of the following eight addressing modes:

Register Mode. The data element is located in one of the 16 general-purpose registers.

Immediate Mode. The data element is located in the instruction.

Indirect Register Mode. The data element can be found in the location whose address is in a register.

Direct Address Mode. The data element can be found in the location whose address is in the instruction.

Index Mode. The data element can be found

in the location whose address is the sum of the contents of an index value in a register and an address in the instruction.

Relative Address Mode. The data element can be found in the location whose address is the sum of the contents of the program counter and a displacement in the instruction.

Base Address Mode. The data element can be found in the location whose address is the sum of a base address in a register and a displacement in the instruction.

Base Index Mode. The data element can be found in the location whose address is the sum of a base address in one register and an index value in another register.

Chapter 5 defines and illustrates the eight addressing modes.

2.12 Extended Processing Architecture

An important feature of the Z8000 CPU architecture is the Extended Processing Architecture (EPA) facility. This facility provides a mechanism by which the basic instruction set of the CPU can be extended via external devices, called Extended Processing Units (EPUs). A special set of instructions, called extended instructions, is used to control this feature. When the CPU encounters one of

these extended instructions in its instruction stream, it will either trap to a software trap handler to process the instruction or it will perform the data transfer portion of the instruction (leaving the data manipulation part of the instruction to the EPU). Whether the CPU traps or transfers data depends on the setting of the EPA bit in the FCW.

2.12 Extended Processing Architecture
(Continued)

The underlying philosophy behind the EPA feature is a view of the CPU as an instruction processor—the CPU fetches instructions, fetches data associated with the instruction, performs the operations and stores the result. Extending the number of operations performed does not affect the instruction fetch and address calculation portion of the CPU activity. The extended instructions exploit this

feature—the CPU fetches the instruction and performs any address calculation that may be needed. It also generates the timing signals for the memory access if data must be transferred between memory and the ~~extension~~ ^{EXTENDED} processor. But the actual data manipulation is handled by the EPU. The Extended Processing Architecture is explained more fully in Chapter 4.

2.13 Exceptions

Three events can alter the normal execution of a Z8000 program: hardware interrupts that occur when a peripheral device needs service, synchronous software traps that occur when an error condition arises, and system reset. Chapter 7 contains a detailed description of exceptions and how they are handled.

2.13.1 Reset. a system reset overrides all other operating conditions. It puts the CPU in a known state and then causes a new program status to be fetched from a reserved area of memory to reinitialize the Flag and Control Word (FCW) and the Program Counter (PC).

2.13.2 Traps. Traps are synchronous events that are usually triggered by specific instructions and recur each time the instruction is executed with the same set of data and the same process or state. The four kinds of traps are:

Extended instruction attempted in non-EPA mode. The current instruction is an EPU instruction, but the system is not in EPA mode. This trap allows system software to either simulate instruction or abort the program.

Privileged instruction attempted in normal mode. The current instruction is privileged (I/O for example), but the CPU is in normal mode.

System Call (SC) instruction. This instruction provides a controlled access from normal-mode to system-mode operation.

Segmentation violation (supplied by external circuit). A segmentation violation, such as using an offset larger than the defined length of the segment, can be made to cause an external memory management system to signal a segmentation trap. This can occur only with the segmented Z8001.

2.13.3 Interrupts. Interrupts are asynchronous events typically triggered by peripheral devices needing attention. The three kinds of interrupts associated with the three interrupt lines of the CPU are:

Non-maskable interrupts (\overline{NMI}). These interrupts cannot be disabled and are usually reserved for critical external events that require immediate attention.

Vectored interrupts (\overline{VI}). These interrupts cause eight bits of the vector output by the interrupting device to be used to select a particular interrupt service procedure to which the program automatically branches.

Non-vectored interrupts (\overline{NVI}). These interrupts are maskable interrupts which are all handled by the same interrupt procedure.

2.13.4 Trap and Interrupt Service Procedures. Interrupts and traps are handled similarly by the Z8000 CPU. The Z8000 CPU automatically acknowledges interrupt and processes traps in system mode. In the case of the segmented Z8001, the CPU uses the segmented mode regardless of its mode at the time of interrupt or trap. The program status information in effect just prior to the interrupt or trap is pushed onto the system stack. An additional word, which serves as an identifier for the interrupt or trap, also is pushed onto the system stack, where it can be accessed by the interrupt or trap handler. The Program Status registers are loaded with new status information obtained from the Program Status Area of memory. Then control is transferred to the service procedure, whose address is now located in the Program Counter. For details of interrupt and trap handling, refer to Chapter 7.

INTERRUPT REQUESTS AND SEGMENTATION TRAP REQUESTS ARE ACCEPTED AFTER THE COMPLETION OF THE INSTRUCTION EXECUTION DURING WHICH THEY WERE MADE. AT THE END OF THE INSTRUCTION EXECUTION, A SPURIOUS INSTRUCTION FETCH TRANSACTION IS USUALLY PERFORMED BEFORE THE INTERRUPT OR ACKNOWLEDGE SEQUENCE BEGINS, BUT THE PROGRAM COUNTER IS NOT AFFECTED BY THE SPURIOUS FETCH.



Zillog
Zillog
Zillog
Zillog
Zillog

Chapter 3 Address Spaces

3.1 Introduction

Programs and data may be located in the main memory of the computer system or in peripheral devices. In either case, the location of the information must be specified by an *address* of some sort before that information can be accessed. A set of these addresses is called an *address space*.

The Z8000 supports two different types of addresses and thus two categories of address spaces:

- *Memory addresses*, which specify locations in main memory.
- *I/O addresses*, which specify the ports through which peripheral devices are accessed.

3.2 Types of Address Spaces

Within the two general types of address spaces (memory and I/O), it is possible to distinguish several subcategories. Figure 3.1 shows the address spaces that are available on both the Z8001 and the Z8002.

The difference between the Z8001 and the Z8002 lies not in the number and type of address spaces, but rather in the organization and maximum size of each space. For the Z8001, each of the six memory address spaces contains 8M byte addresses grouped into 128 segments, for a total memory addressing capability of 48M bytes. For the Z8002, each memory space is a homogeneous collection of 64K byte addresses. In both the Z8001 and the Z8002, the I/O address spaces contain 64K port addresses. When an address is used to access data, the address spaces may be distinguished by the state of the status lines (ST₀-ST₃) (which is determined by the way the address was generated) and by the value of the Normal/System line (N/\bar{S}) (which is determined by the state of the S/\bar{N} bit in the FCW).

- *Instruction Space* (*status* = 1100 or 1101), *normal mode* ($N/\bar{S} = 1$) or *system mode* ($N/\bar{S} = 0$). These spaces typically address memory that contains user programs (normal), or system programs (system).

The CPU generates addresses during four types of operations:

- *Instruction fetches*, described in Chapter 4.
- *Operand fetches and stores*, described in Chapter 5.
- *Exception processing*, described in Chapter 7.
- *Refreshes*, described in Chapter 8.

Timing information concerning addresses is described in Chapter 9.

- *Data Spaces* (*status* = 1000 or 1010), *normal mode* ($N/\bar{S} = 1$) or *system mode* ($N/\bar{S} = 0$). These spaces may be used to address the data that user or system programs operate on.
- *Stack Spaces* (*status* = 1001 or 1011), *normal mode* ($N/\bar{S} = 1$) or *system mode* ($N/\bar{S} = 0$). These spaces can be used to address the system and normal program stacks.
- *Standard I/O Space* (*status* = 0010). This space addresses all the I/O ports that are used for Z8000 peripherals.
- *Special I/O Space* (*status* = 0011). This space addresses ports in CPU support chips (such as the Z8010 Memory Management Unit).

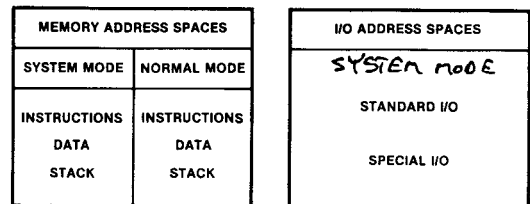

Figure 3-1. Address Spaces on the Z8001 and Z8002

3.3 I/O Address Spaces

All I/O addresses are represented by 16-bit words. Each of the ports addressed is either eight or 16 bits wide. Transfer to or from 16-bit ports always involves word data and, for 8-bit ports, byte data.

The address of a 16-bit port may be even or odd for both address spaces. In standard I/O space, byte ports must have an odd address; in special I/O space, byte ports must have an even address.

3.4 Memory Address Spaces

Each memory address space in the Z8002, or each segment in each memory address space on the Z8001, can be viewed as addressing a string of 64K bytes numbered consecutively in ascending order. The 8-bit byte is the basic addressable element in Z8000 memory address spaces. However, there are three other addressable data elements:

- *Bits*, in either bytes or words.
- *16-bit words*.
- *32-bit long words*.

3.4.1 Addressable Data Elements. The nature of the data element being addressed depends on the instruction being executed. As Chapter 6 explains in detail, different assembler mnemonics are used for addressing bytes, words, and long words. Moreover, only certain instructions can address bits.

A bit can be addressed by specifying a byte or word address and the number of the bit within the byte (0-7) or word (0-15). Bits are numbered right-to-left, from the least to the

most significant. This is consistent with the convention that bit n corresponds to position 2^n in the conventional representation of positive binary numbers (see Figure 3.2).

The address of a data type longer than one byte (word or long word) is the same as the address of the byte with the lowest memory address within the word or long word (Figure 7.2). This is the leftmost, highest-order, or most significant byte of the word or long word.

Word or long word addresses are always even-numbered. Low bytes of words are stored at odd-numbered memory locations and high bytes at even-numbered locations. Byte addresses can be either even- or odd-numbered.

Certain memory locations are reserved for system-reset handling. These are described fully in Chapter 7. Except for these reserved locations, there are no memory addresses specifically designated for a particular purpose.

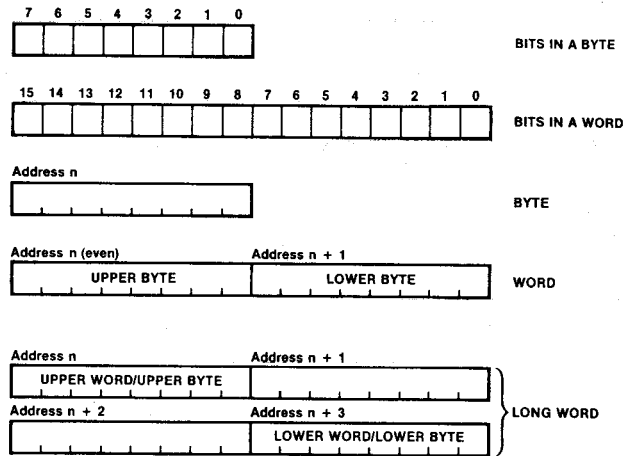

Figure 3-2. Addressable Data Elements

3.4.2 Segmented and Non-Segmented Addresses. The two versions of the Z8000 CPU generate two kinds of addresses with different lengths. The Z8002 generates a 16-bit address specifying one of 64K bytes. The Z8001 generates a 23-bit *segmented* address. A segmented address consists of a 7-bit *segment number*, which specifies one of 128 segments, and a 16-bit *offset*, which specifies one of up to 64K bytes in the segment. Each segment is an independent collection of bytes; thus, instructions and multiple byte data elements cannot cross segment boundaries. Some of the advantages of address segmentation are outlined in Section 3.4.3.

Figure 3.3 shows the format of segmented and nonsegmented addresses. Nonsegmented addresses are 16 bits long and thus can be stored in word registers (R_n) or in memory as

word-length addressable elements. The 23-bit segmented addresses are embedded in a 32-bit long word and thus can be stored in a long word register (RR_n) or a long word memory element.

It is important to realize that even though the Z8001 can operate in nonsegmented mode (Chapter 4), it always generates segmented addresses. ~~THE SEGMENT NUMBER IS SUPPLIED BY THE PROGRAM COUNTER NUMBER.~~ **BEING SUPPLIED BY THE PROGRAM COUNTER NUMBER.**

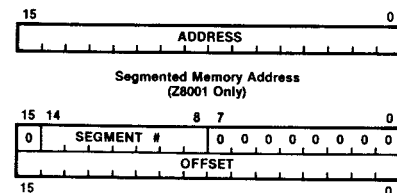

Figure 3-3. Segmented and Non-Segmented Address Formats

THERE IS A SHORT ENCODING OF SEGMENTED ADDRESS THAT APPEARS IN INSTRUCTIONS AND REQUIRES ONLY 16 BITS.

3.4 Memory Address Spaces
(Continued)

3.4.3 Segmentation and Memory Management. Addresses manipulated by the programmer, used by instructions, and output by the Z8001 are called "logical addresses." An external memory-management circuit can translate logical addresses into physical (actual) memory addresses and perform certain checks to insure data and programs are properly accessed.

The Z8010 Memory Management Unit (MMU) performs this function for the segmented addresses produced by the Z8001 CPU. A single MMU keeps a descriptor for each of 64 segments. This descriptor tells where in physical memory the segment lies, how long the segment is, and what kind of accesses can be made to the segment. The MMU uses these descriptors to translate logical segment numbers and offsets into 24-bit physical addresses (as shown in Figure 3.4). At the same time, the MMU checks for such errors as writing into a read-only segment or a system segment being accessed by a nonsystem program. MMUs are designed to be combined so that more than 64 segments can be supported at once.

Some of the benefits of the memory management features provided by the MMU are:

- Provision for flexible and efficient allocation of physical memory resources during the execution of programs.

- Support for multiple, independently executing programs that can share access to common code and data.
- Protection from unauthorized or unintentional access to data or programs.
- Detection of obviously incorrect use of memory by an executing program.
- Separation of users from system functions.

Segmentation in the Z8001 helps support memory management in two ways:

- By allowing part of an address (the segment number) to be output by the CPU early in a memory cycle. This keeps access to the segment descriptor in the MMU from adding to the basic access time of the memory.
- By providing a standard, variable-sized unit of memory for the protection, sharing, and movement of data.

In addition, segmentation is the natural model for the support of modular programs and data in a multi-programming environment. It efficiently supports re-entrant programs by providing data relocation for different tasks using common code.

More information about the MMU and memory management can be found in *An Introduction to the Z8010 MMU Memory Management Unit* and in the *Z8010 MMU Technical Manual*.

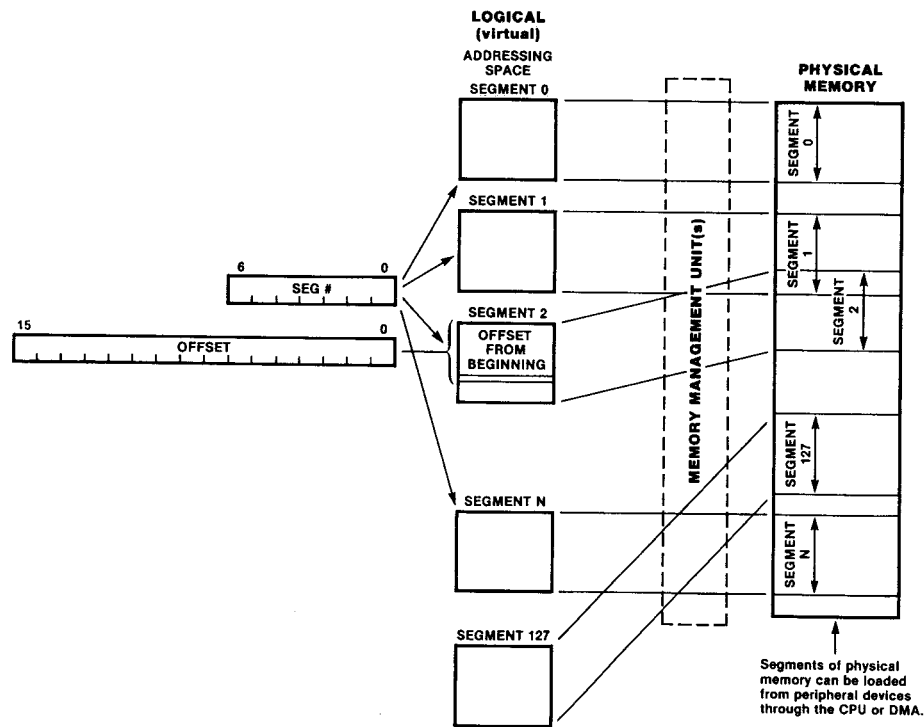

Figure 3-4. Segmented Address Translation



Zilog
Zilog
Zilog
Zilog
Zilog

Chapter 4 CPU Operation

4.1 Introduction

This chapter gives a fundamental description of the operating states of the Z8000 CPU and the process of instruction execution. The details of instruction execution are described in Chapters 5 and 6. Other detailed aspects of

Z8000 operation are given in Chapter 7 (Exceptions) and Chapter 8 (Refresh). Chapter 9 describes CPU operations as they are manifested on the external pins of the CPU.

4.2 Operating States

The Z8000 CPU has three operating states: Running state, Stop/Refresh state, and Bus-Disconnect state. Running state is the usual state of the processor: the CPU is executing instructions or handling exceptions. Stop/Refresh state is entered when the \overline{STOP} line is asserted or the refresh counter indicates that a periodic refresh should be done. In this state, memory refresh transactions are generated continually (see Chapter 8). Bus-Disconnect state is entered when the CPU acknowledges a bus request and gives up control of the system bus. Figure 4.1 shows the three states and the conditions that cause state transitions.

4.2.1 Running State. While the CPU is in Running state, it is either executing instructions (as described in Section 4.3) or handling exceptions (as described in Chapter 7). The CPU is normally in Running state, but will leave this state in response to one of three conditions:

- The refresh mechanism indicates that a periodic refresh needs to be done, in which case the CPU temporarily enters Stop/Refresh state.

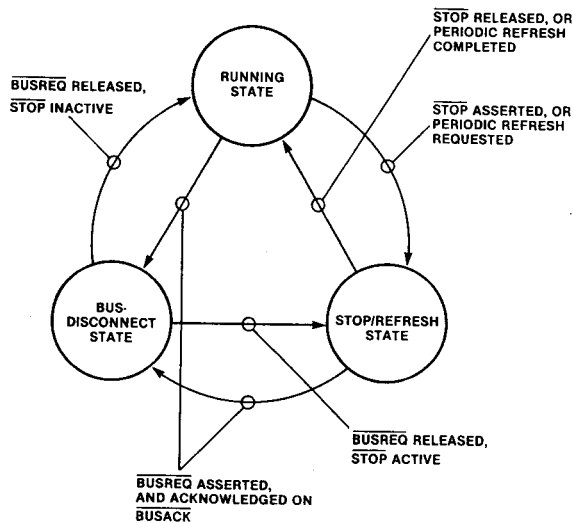

Figure 4-1. Operating States and Transitions

- An external stop request pushes the CPU into Stopped state.
- An external bus request pushes the CPU into Bus-Disconnect state.

4.2.2 Stop/Refresh State. While the CPU is in Stop/Refresh state, it generates a continuous stream of refresh cycles (as discussed in Chapter 8) and does not perform any other functions. This state provides for the generation of memory refreshes by the CPU and allows external devices to suspend CPU operation. This feature can be used to force single-step operation of the processor or to synchronize the CPU with an Extended Processing Unit (as described in Section 4.4).

The CPU enters Stop/Refresh state when the refresh mechanism needs to do a refresh or when the stop line is activated. It leaves Stop/Refresh state when neither of these conditions hold or when a bus request causes the CPU to enter Bus-Disconnect state.

4.2.3 Bus-Disconnect State. While the CPU is in Bus-Disconnect state, it does nothing. It enters Bus-Disconnect state from either Running state or Stop/Refresh state when a bus request has been received on \overline{BUSREQ} and acknowledged on \overline{BUSACK} as (described in Chapter 9). While in this state, it disconnects itself from the bus by 3-stating its output. It will leave Bus-Disconnect state when the external bus request has been received. Note that Bus-Disconnect state is highest in priority in that the presence of a bus request will force the CPU into this state, regardless of any conditions indicating that a different state should be entered.

4.2.4 Effect of Reset. Activation of the CPU's \overline{RESET} line puts the CPU in a nonoperational state within five clock cycles, regardless of its previous state or the states of its other inputs. The CPU will remain in this state until \overline{RESET} is deactivated. When this occurs, the processor enters one of the three operating states described above, depending on the state of \overline{BUSREQ} and \overline{STOP} inputs. Reset is more fully described in Chapters 7 and 9.

4.3 Instruction Execution

While the CPU is in Running state and executing instructions, it is controlled by the Program Status registers (Figure 4.2). The Program Counter gives the address from which instructions are fetched, the flags control branching (as described in Chapter 6), and the control bits determine the mode in which the CPU updates (see Section 4.3) and the interrupts that are masked (see Chapter 7).

Instruction execution consists of the repeated application of two steps:

- Fetch one or more words comprising a single instruction from the program memory address space at the address specified by the Program Counter (PC).
- Perform the operation specified by the instruction and update the Program Counter and flags in the Program Status registers.

The operation performed by an instruction and the way the flags are updated depends on the particular instruction being executed and is described in Chapter 6. For most instructions, the PC value is updated to point to the word immediately following the last word of the instruction. The effect of this is that instructions are fetched sequentially from memory. Exceptions to this are Branch, Call, and Return instructions, which cause the PC to be set to a value generated by the instruction. This causes a transfer of control with execution continuing at the new address in PC. The exact operation of these instructions is described in Chapter 6.

The Z8000 CPU is able to overlap the fetching of one instruction with the operation of the previous instruction. This facility, called Instruction Look-Ahead, is illustrated in Figure 4.3. This shows the execution of a series of

memory-to-register instructions, such as a value in memory being added to the value in a general-purpose register. Part of each instruction is fetched while the previous instruction execution is being completed. This mechanism provides faster execution speed than the typical alternative of fetching each instruction only after the prior instruction has completed execution.

After executing an instruction and in some cases (explained in Chapters 6 and 7) during an instruction's execution, the CPU checks to see if there are any traps or interrupts pending and not masked. If so, it temporarily suspends instruction execution and begins a standard exception-handling sequence. This sequence, which is described fully in Chapter 7, causes the value of the Program Status registers to be saved and a new value loaded. Instruction execution then continues with a new PC value and Flag and Control Word value. The effect is to switch the execution of the CPU from one program to another.

4.3.1 Running-State Modes. While the CPU is executing instructions, its mode will be controlled by two control bits in the FCW: the system/normal mode bit (S/N) and the segmentation mode bit (SEG).

4.3.2 Segmented and Nonsegmented Modes. The segmentation mode of the CPU (segmented or nonsegmented) determines the size and format of addresses that are directly manipulated by programs. In segmented mode (SEG = 1), programs manipulate 23-bit segmented addresses; in nonsegmented mode (SEG = 0), programs generate 16-bit nonsegmented addresses. There are also the following differences in the address portion of instructions, which are executed due to the difference in address size:

- Indirect and Base Registers are 32-bit registers in segmented mode and 16-bit registers in nonsegmented mode.
- Address-embedded instructions are always 16-bits in nonsegmented mode. They consist of a 7-bit segment number and either an 8-bit or 16-bit offset in segmented mode.

Segmented mode is available only on the Z8001 CPU; on the Z8002, the segment bit is always forced to zero, indicating nonsegmented mode. Because the Z8001 supports segmented and nonsegmented modes, it is possible to run programs written for the Z8002 on the Z8001 without alteration. The reverse is not possible. The Z8001 CPU always generates segmented addresses, even when operating in nonsegmented mode. When a memory access

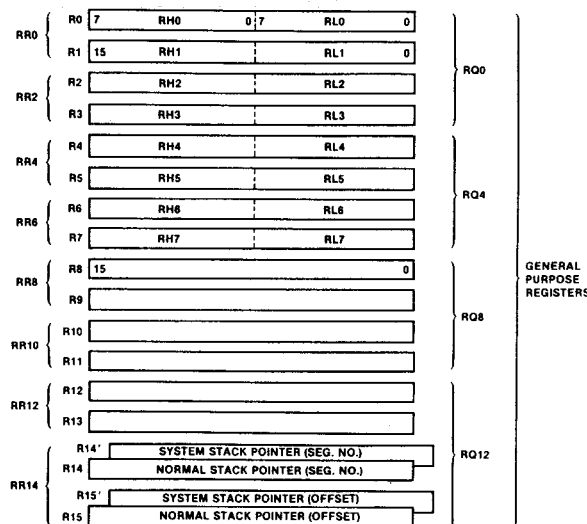

Figure 4-2. General-Purpose Registers

4.3 Instruction Execution

(Continued)

is made in nonsegmented mode, the offset of the segmented address is the 16-bit address generated by the program, and the segment number is the value of the segment number field of the Program Counter.

4.3.3 Normal and System Modes. The operation mode of the CPU (system mode or normal mode) determines which instructions can be executed and which Stack Pointer register is used.

In system mode ($S/\bar{N} = 1$), all instructions can be executed. While in normal mode, certain privileged instructions that alter sensitive parts of the machine state (such as I/O operations or changes to control registers) cannot be executed.

The second distinction between system and normal mode is access to the system or normal Stack Pointer. As shown in Figure 4.2, there are two copies of the Stack Pointer registers (Register 15 in the Z8002 and Registers 14 and 15 in the Z8001): one for normal mode and one for system mode. When in normal mode, a reference to the Stack Pointer register by an instruction will access the normal Stack Pointer. When in system mode, an access to the Stack Pointer register will reference the

system Stack Pointer, unless the Z8001 is running in nonsegmented system mode, in which case a reference to R14 will access the normal mode R14. This is summarized in Table 4.1.

In normal mode, the system Stack Pointer is not accessible; in system mode the normal Stack Pointer is accessed by using a special Load Control instruction (described in Chapter 6).

The CPU switches modes whenever the Program Status Control bits change. This can happen when a privileged load control instruction is executed or when an exception (interrupt, trap, or reset) occurs. There is a special instruction (system call) whose sole purpose is to generate a trap and thus provide a controlled transition for normal to system mode.

The distinction between normal/system mode allows the construction of a protected operating system. This is a program that runs in system mode and controls the system's resources, managing the execution of one or more application programs which run in normal mode. Normal and system modes, along with Memory Protection, provide the basis for protecting the operating system from malfunctions of application programs.

Register Referenced by Instruction	System Mode		Normal Mode	
	Segmented	Nonsegmented	Segmented	Nonsegmented
R14	System R14	Normal R14	Normal R14	Normal R14
R15	System R15	System R15	Normal R15	Normal R15
RR14	System R14	Normal R14	Normal R14	Normal R14
	System R15	System R15	Normal R15	Normal R15

Note: Z8002 always runs in nonsegmented mode.

Table 4.1 Registers Accessed by References to R14 and R15.

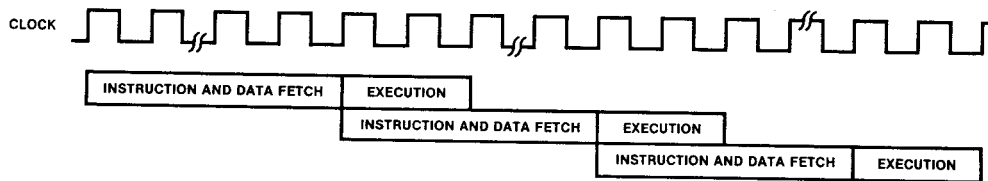

Figure 4-3. Instruction Look Ahead

4.4 Extended Instructions

The Z8000 CPU supports six extended instructions, which can be executed cooperatively by the CPU and an external Extended Processing Unit. The execution of these instructions is controlled by the EPA control bit in the FCW.

When the EPA bit is zero, it indicates that there is no Extended Processing Unit connected to the CPU and causes the CPU to trap (as explained in Chapter 7) when it encounters an extended instruction. This allows the operation of the extended instruction to be simulated by software running on the CPU.

If the EPA bit is set, it indicates that an Extended Processing Unit is connected to the CPU in order to process the operation encoded in the extended instruction. The CPU will fetch the extended instruction and perform any address calculation required by that instruc-

tion. If the instruction specifies the transfer of data, the CPU will generate the timing signals for this transfer. The CPU will fetch and begin executing the next instruction in its instruction stream. The Extended Processing Unit is expected to monitor the CPU's activity, participate in extended instruction data transfers initiated by the CPU, and execute the extended instruction. While the Extended Processing Unit is executing the instruction, the CPU can be fetching and executing further instructions. If the CPU fetches another extended instruction before the Extended Processing Unit is finished executing a previous instruction, the $\overline{\text{STOP}}$ line may be used to delay the CPU until the previous instruction is complete. This process is described more fully in Chapters 6 and 9.

Zillog
Zillog
Zillog
Zillog
Zillog

Chapter 5 Addressing Modes

5.1 Introduction

This chapter describes the eight addressing modes used by instructions to access data in memory or CPU registers. Separate sets of examples for the nonsegmented and segmented modes of operation are given at the end of the chapter.

An instruction is a consecutive list of one or more words aligned at even-numbered byte addresses in memory. Most instructions have operands in addition to an operation code

(opcode). These operands may reside in CPU registers or memory locations. The modes by which references are made to operands are called "addressing modes." Figure 5.1 illustrates these modes. Not all instructions can use all addressing modes; some instructions can use only a few, and some instructions use none at all. In Figure 5.1, the term "operand" refers to the data to be operated upon.

Addressing Mode	Operand Addressing		Operand Value
	In the Instruction	In a Register	
R			
Register	REGISTER ADDRESS	OPERAND	The content of the register
IM			
Immediate	OPERAND		In the instruction
*IR			
Indirect Register	REGISTER ADDRESS	ADDRESS → OPERAND	The content of the location whose address is in the register
DA			
Direct Address	ADDRESS	OPERAND	The content of the location whose address is in the instruction
*X			
Index	REGISTER ADDRESS BASE ADDRESS	INDEX → (+) → OPERAND	The content of the location whose address is the address in the instruction plus the content of the working register.
RA			
Relative Address	DISPLACEMENT	PC VALUE → (+) → OPERAND	The content of the location whose address is the content of the program counter, offset by the displacement in the instruction
*BA			
Base Address	REGISTER ADDRESS DISPLACEMENT	BASE ADDRESS → (+) → OPERAND	The content of the location whose address is the address in the register, offset by the displacement in the instruction
*BX			
Base Index	REGISTER ADDRESS REGISTER ADDRESS	BASE ADDRESS INDEX → (+) → OPERAND	The content of the location whose address is the address in a register plus the index value in another register.

*Do not use R0 or RR0 for these operands.

Figure 5-1. Addressing Modes

5.2 Use of CPU Registers

The 16 general-purpose CPU registers can, with the exceptions noted below, be used in any of the following ways:

- As accumulators, where the data to be manipulated resides within the register.
- As pointers, where the value in the register is the memory address of the operand, rather than the operand itself. In string and stack instructions, the pointers may be automatically stepped either forward or backward through memory locations.
- As index or base registers, where the contents of the register and the word(s) following the instruction are combined to produce the address of the operand. This allows efficient access to a variety of data structures.

There are two exceptions to the above uses of general-purpose registers:

- Register R0 (or the double register RR0 in segmented mode) cannot be used as an indirect register, base register, index register, or software stack pointer.
- Register R15' (or the double register RR14' in the Z8001) is used in acknowledging interrupts and therefore can never be used as an accumulator in system-mode operation. The system-mode registers, R14' and R15', are automatically accessed when R14, R15, or RR14 are referenced by instructions executed in system mode.

In addition to the general-purpose use of Z8000 registers, the following registers are used for special purposes:

- Register R15 (or the double register RR14 in the Z8001) is used as a stack pointer for subroutine calls and returns.
- The byte register RH1 is used in the translate instructions (TRDB, TRDRB, TRIB, TRIRB) and the translate and test instructions (TRTDB, TRTDRB, TRTIB, TRTIRB).
- Register R0 is used in extended instructions.

In Relative Address (RA) mode, the Program Counter (PC) is used instead of a general-purpose CPU register to supply the base address for an effective address calculation.

The Program Counter normally is used only to keep track of the next instruction to be executed; whenever an instruction is fetched from memory, the PC is incremented to point to the next instruction. For addressing purposes, however, the updated PC serves as a base for referencing an operand relative to the location of an instruction. Operands specified by relative addressing reside in the program address space if the memory system distinguishes between program and data or stack address spaces.

Two of the addressing modes, Direct Address and Index, involve an I/O or memory address as part of the instruction. I/O addresses are always 16 bits long, as are non-segmented memory addresses (Z8002), so these addresses occupy one word in the instruction. Segmented addresses generated by the Z8001 are 23 bits long. Within an instruction, a segmented address may occupy either two words (16-bit long offset) or one word (8-bit short offset).

As Figure 5.2 illustrates, bit 7 of the segment number byte distinguishes the two formats. When this bit is set, the long-offset representation is implied. When the bit is cleared, the short-offset address representation is implied. For a short-offset address, the 23-bit segmented address is reduced to 16 bits by omitting the eight most significant bits of the offset, which are assumed to be zero.

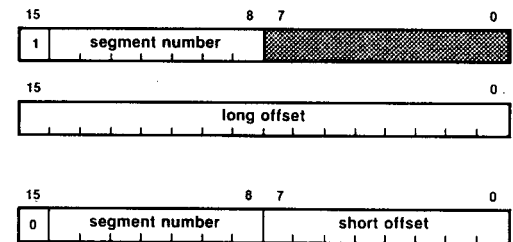

NOTE: Shaded area is reserved.

Figure 5-2. Segmented Memory Address Within Instruction.

5.3 Addressing Mode Descriptions

The following pages contain descriptions of the addressing modes of the Z8000. Each description:

- Explains how the operand address is calculated,
- Indicates which address space (Register, I/O, Special I/O, Data Memory, Stack Memory, or Program Memory) the operand is located in,
- Shows the assembly language format used to specify the addressing mode, and

- Works through an example.

The descriptions are grouped into two sections—one for nonsegmented CPUs, the other for segmented CPUs. Users of the Z8002 need refer to the first section only; users of the Z8001 in nonsegmented mode should also refer to the first section, while users of Z8001 in segmented mode should refer to the second section.

5.4 Descriptions and Examples (Z8002 and Z8001 Nonsegmented Mode)

In this section, the addressing modes of both the Z8002 and the nonsegmented mode Z8001 are described.

5.4.1 Register (R). In the Register addressing mode the instruction processes data taken from a specified general-purpose register. Storing data in a register allows shorter instructions and faster execution than occurs with instructions that access memory.



The operand is always in the register address space. The register length (byte, word, register pair, or register quadruple) is specified by the instruction opcode.

Assembler language format:

- RHn, RLn Byte register
- Rn Word register
- RRn Double-word register
- RQn Quadruple-word register

Example of R mode:

```
LD R2, R3           !load the contents of
                    !R3 into R2!
```

Before Execution

R2	A6B8
R3	9A20

After Execution

R2	9A20
R3	9A20

5.4.2 Immediate (IM). The Immediate addressing mode is the only mode that does not indicate a register or memory address as the source operand. The data processed by the instruction is in the instruction.

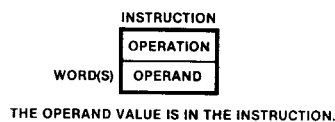

Because an immediate operand is part of the instruction, it is always located in the program memory address space. Immediate mode is often used to initialize registers. The Z8000 is optimized for this function, providing several short immediate instructions to reduce the length of programs.

Assembler language format (see also Chapter 6):

#data

Example of IM mode:

```
LDB RH2 #%55       !load hex 55 into RH2!
```

Before Execution

R2	6789
----	------

After Execution

R2	5589
----	------

5.4.3 Indirect Register (IR). In the Indirect Register addressing mode, the data processed is not the value in the specified register. Instead, the register holds the address of the data.

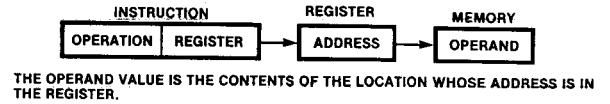

A single word register is used to hold the address. Any general-purpose word register can be used except R0.

Depending on the instruction, the operand specified by IR mode will be located in either I/O address space (I/O instructions), Special I/O address space (Special I/O instructions), or data or stack memory address spaces. For non-I/O references, the operand will be in stack memory space if the stack pointer (R15) is used as the indirect register; otherwise, the operand will be in data memory space.

The Indirect Register mode may save space and reduce execution time when consecutive locations are referenced. This mode can also be used to simulate more complex addressing modes, since addresses can be computed before the data is accessed.

Assembler language format (see also Chapter 6):

@Rn

Example of IR mode:

```
LD R2,@R5          !load R2 with the!
                    !data addressed by the!
                    !contents of R5!
```

Before Execution

R2	030F
R3	0005
R4	2000
R5	170C

Memory

	⋮
170A	A023
170C	0B0E
170E	10D0
	⋮

After Execution

R2	0B0E
R3	0005
R4	2000
R5	170C

5.4 Descriptions and Examples (Z8002 and Z8001 Nonsegmented Mode)
(Continued)

5.4.4 Direct Address (DA). In the Direct Addressing mode, the data processed is found at the address specified in the instruction.

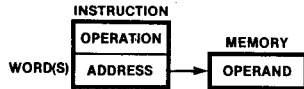

THE OPERAND VALUE IS THE CONTENTS OF THE LOCATION WHOSE ADDRESS IS IN THE INSTRUCTION.

Depending upon the instruction, the operand specified by DA mode will be either in I/O space (I/O instructions), in Special I/O space (Special I/O instructions), or in data memory space.

This mode is also used by Jump and Call instructions to specify the address of the next instruction to be executed. (Actually, the address serves as an immediate value that is loaded into the Program Counter.)

Assembler language format (see also Chapter 6):

address either memory, I/O, or Special I/O

Example of DA mode:

LDB RH2,%5E23 !load RH2 with the!
 !data in address!
 !5E23!

<p><i>Before Execution</i></p> <p>R2 6789</p>	<p><i>Memory</i></p> <table border="1" style="border-collapse: collapse; text-align: center;"> <tr><td style="padding: 2px;">⋮</td></tr> <tr><td style="padding: 2px;">5E22 0106</td></tr> <tr><td style="padding: 2px;">5E24 0304</td></tr> <tr><td style="padding: 2px;">⋮</td></tr> </table>	⋮	5E22 0106	5E24 0304	⋮
⋮					
5E22 0106					
5E24 0304					
⋮					

After Execution

R2 0689

5.4.5 Index (X). In the Index Addressing mode, the instruction processes data located at an indexed address in memory. The indexed address is computed by adding the address specified in the instruction to an "index" contained in a word register, also specified by the instruction. Indexed addressing allows random access to tables or other complex data structures where the address of the base of the table is known, but the particular element index must be computed by the program.



THE OPERAND VALUE IS THE CONTENTS OF THE LOCATION WHOSE ADDRESS IS THE ADDRESS IN THE INSTRUCTION, OFFSET BY THE CONTENTS OF THE REGISTER.

Any word register can be used as the index register except R0.

Operands specified by X mode are always in the data memory address space, except when Index Addressing is used with the Jump and Call instructions. In these cases, the destination, computed by adding the index

register contents to the base address, is in program memory space.

Assembler language format (see also Chapter 6):

address (Rn)

Example of X mode:

LD R4,%231A(R3) !load into R4 the con-!
 !tents of the memory!
 !location whose!
 !address is 231A +!
 !the value in R3!

<p><i>Before Execution</i></p> <p>R3 01FE</p> <p>R4 203A</p>	<p><i>Memory</i></p> <table border="1" style="border-collapse: collapse; text-align: center;"> <tr><td style="padding: 2px;">⋮</td></tr> <tr><td style="padding: 2px;">2516 F3C2</td></tr> <tr><td style="padding: 2px;">2518 3D0E</td></tr> <tr><td style="padding: 2px;">251A 7ADA</td></tr> <tr><td style="padding: 2px;">⋮</td></tr> </table>	⋮	2516 F3C2	2518 3D0E	251A 7ADA	⋮
⋮						
2516 F3C2						
2518 3D0E						
251A 7ADA						
⋮						

Address Calculation

231A
+ 01FE

2518

After Execution

R3 01FE

R4 3D0E

5.4.6 Relative Address (RA). In the Relative Addressing mode, the data processed is found at an address relative to the current instruction. The instruction specifies a two's complement displacement which is added to the Program Counter to form the target address. The Program Counter setting used is the address of the first instruction *following* the currently executing instruction. (The assembler will take this into account in calculating the constant that is assembled into the instruction.)

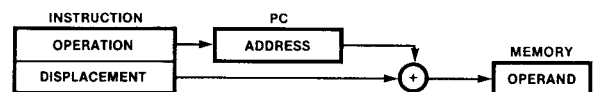

THE OPERAND VALUE IS THE CONTENTS OF THE LOCATION WHOSE ADDRESS IS THE CONTENTS OF PC OFFSET BY THE DISPLACEMENT IN THE INSTRUCTION.

An operand specified by RA mode is always in the program memory address space.

As with the Direct Addressing mode, the Relative Addressing mode is used by certain program control instructions to specify the address of the next instruction to be executed (specifically, the result of the addition of the Program Counter value and the displacement is loaded into the Program Counter). Relative addressing allows short references forward or backward from the current Program Counter value and is used only for such instructions as Jumps or Calls and special loads (LDR) that can cross the normally strict boundary between program and data memory.

5.4 Descriptions and Examples (Z8002 and Z8001 Nonsegmented Mode)
(Continued)

Assembler language format (see also Chapter 6):

address

Example of RA mode: (Note that the symbol "\$" is used for the value of the current program counter.)

```
LDR R2,$+%6      !load into R2 the contents of the memory!
                  !location whose address is the current!
                  !program counter!
                  !+ hex 6!
```

Because the program counter will be advanced to point to the next instruction when the address calculation is performed, the constant that occurs in the instruction will actually be +2.

Before Execution

R2	A0F0
PC	0202

Memory

	⋮
0202	3102
0204	0002
0206	E801
0208	FFFE
	⋮

} Instruction

Address Calculation

$$\begin{array}{r} 0206 \\ + \quad 2 \\ \hline 0208 \end{array}$$

After Execution

R2	FFFE
PC	0206

5.4.7 Base Address (BA). The Base Addressing mode is similar to Index mode in that a base and offset are combined to produce the effective address. In Base Addressing, however, a register contains the base address, and the displacement is expressed as a 16-bit value in the instruction. The two are added and the resulting address points to the data to be processed. This addressing mode may be used only with the Load instructions. Base Addressing mode, as a complement to Index

mode, allows random access to tables or other data structures where the displacement of an element within the structure is known, but the base of the particular structure must be computed by the program.

Any word register can be used for the base address *except R0*.

An operand specified by BA mode will be in stack memory space if the base register is the stack pointer (R15) and in data memory space otherwise.



THE OPERAND VALUE IS THE CONTENTS OF THE LOCATION WHOSE ADDRESS IS THE ADDRESS IN THE INSTRUCTION, OFFSET BY THE CONTENTS OF THE REGISTER.

Assembler language format (see also Chapter 6):

Rn (#disp)

Example of BA mode:

```
LDL R5(##18),RR2 !load the long word!
                  !in RR2 into the!
                  !memory location!
                  !whose address is the!
                  !value in R5 + hex!
                  !18!
```

Before Execution

RR2	R2	0A00
	R3	1500
	R4	3100
	R5	20AA

Memory

	⋮
20C0	0ABE
20C2	F50D
20C4	BADE
20C6	B0D1
	⋮

Address Calculation

$$\begin{array}{r} 20AA \\ + \quad 18 \\ \hline 20C2 \end{array}$$

After Execution

RR2	R2	0A00
	R3	1500
	R4	3100
	R5	20AA

Memory

	⋮
20C0	0ABE
20C2	0A00
20C4	1500
20C6	B0D1
	⋮

5.4 Descriptions and Examples (Z8002 and Z8001 Nonsegmented Mode)
(Continued)

5.4.8 Base Index (BX). The Base Index addressing mode is an extension of the Base Addressing mode and may be used only with the Load instructions. In this case, both the base address and index (displacement) are held in registers. This mode allows access to memory locations whose physical addresses are computed at runtime and are not fully known at assembly time.

Any word register can be used for either the base address or the index *except* R0. An operand specified by BX mode will be in stack memory space if the base register is the stack pointer (R15) and in data memory otherwise.

Assembler language format (see also Chapter 6):

Rn (Rm)

Example of BX mode:

```
LD R2,R5(R3)      !load into R2 the
                  !value whose address!
                  !is the value in!
                  !R5 + the value in R3!
```

Before Execution

R2	1F3A
R3	FFFE
R4	0300
R5	1502

Memory

14FE	0101
1500	BODE
1502	F732

Address Calculation

$$\begin{array}{r} 1502 \\ + \text{FFFE} \\ \hline 1500 \end{array}$$

After Execution

R2	BODE
R3	FFFE
R4	0300
R5	1502

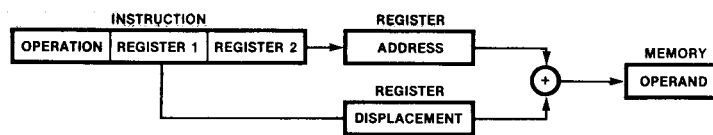

THE OPERAND VALUE IS THE CONTENTS OF THE LOCATION WHOSE ADDRESS IS THE CONTENTS OF THE ONE REGISTER OFFSET BY THE DISPLACEMENT IN THE SECOND REGISTER.

5.5 Descriptions and Examples (Segmented Z8001)

In this section, <<nn>> will often be used to refer to segment number nn.

5.5.1 Register (R). In the Register addressing mode, the instruction processes data taken from a specified general-purpose register. Storing data in a register allows shorter instructions and faster execution than occurs with instructions that access memory.

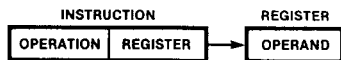

THE OPERAND VALUE IS THE CONTENTS OF THE REGISTER.

The operand is always in the register address space. The register length (byte, word, register pair, or register quadruple) is specified by the instruction opcode.

Assembler language formats (see also Chapter 6):

RHn, RLn	Byte register
Rn	Word register
RRn	Double-word register
RQn	Quadruple-word register

Example of R mode:

```
LDL RR2,RR4      !load the contents!
                  !of RR4 into RR2!
```

Before Execution

RR2	R2	A6B8
	R3	9A20
RR4	R4	38A6
	R5	745E

After Execution

RR2	R2	38A6
	R3	745E
RR4	R4	38A6
	R5	745E

5.5.2 Immediate (IM): The Immediate addressing mode is the only mode that does not indicate a register or memory address as the location of the source operand. The data processed by the instruction is in the instruction.

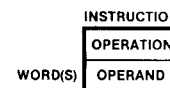

THE OPERAND VALUE IS IN THE INSTRUCTION.

5.5 Descriptions and Examples (Segmented Z8001)

(Continued)

Because an immediate operand is part of the instruction, it is always located in the program memory address space. Immediate mode is often used to initialize registers. The Z8000 is optimized for this function, providing several short immediate instructions to reduce the length of programs.

Assembler language format (see also Chapter 6):

#data

Example of IM mode:

LDB RH2, #55 !load hex 55 into RH2!

Before Execution

R2 6789

After Execution

R2 5589

5.5.3 Indirect Register (IR). In the Indirect Register addressing mode, the data processed is not the value in the specified register. Instead, the register holds the address of the data.

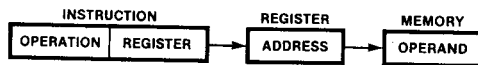

THE OPERAND VALUE IS THE CONTENTS OF THE LOCATION WHOSE ADDRESS IS IN THE REGISTER.

Depending upon the instruction, the operand specified by IR mode will be located in either I/O address space (I/O instructions), Special I/O address space (Special I/O instructions), or data or stack memory address spaces. For non-I/O references, the operand will be in stack memory space if the stack pointer (RR14) is used as the indirect register, otherwise the operand will be in data memory space.

A 16-bit register is used to hold an I/O or Special I/O address; a register pair is used to hold a memory address. Any general-purpose register or register pair may be used except R0 or RR0.

The Indirect Register mode may save space and reduce execution time when consecutive locations are referenced. This mode can also be used to simulate more complex addressing modes, since addresses can be computed before the data is accessed.

Assembler language formats (see also Chapter 6):

@Rn Contains I/O or
 Special I/O address.
@RRn Contains memory
 address.

Example of memory access using IR mode:

LD R2, @RR4

!load into R2 the!
!value in the memory!
!location addressed!
!by the contents of!
!RR4!

Before Execution

RR2	R2	030F
	R3	0005
RR4	R4	2000
	R5	170C

Memory

	⋮
170A*	A023
170C	0B0E
170E	10D3
	⋮

After Execution

RR2	R2	0B0E
	R3	0005
RR4	R4	2000
	R5	170C

* Segment Number 20

Example of I/O using IR mode:

OUTB RLO, @R1

Before Execution

R0	0A23
R0	0011

Execution sends the
data "23" to the I/O
device addressed by
"0011."

5.5.4 Direct Address (DA). In the Direct Addressing mode, the data processed is found at the address specified as an operand in the instruction.

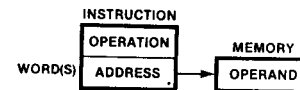

THE OPERAND VALUE IS THE CONTENTS OF THE LOCATION WHOSE ADDRESS IS IN THE INSTRUCTION.

Depending upon the instruction, the operand specified by DA mode will be either in I/O space (I/O instructions), Special I/O space (Special I/O instructions), or data memory space. I/O and Special I/O addresses are one word long; memory addresses can be either one or two words long, depending on whether the long or short format is used.

This mode is also used by Jump and Call instructions to specify the address of the next instruction to be executed. (Actually, the address serves as an immediate value that is loaded into the Program Counter.)

5.5 Descriptions and Examples (Segmented Z8001)
(Continued)

Assembler language format (see also Chapter 6):

address either memory, I/O, or Special I/O where double angle brackets "<<" and ">>" enclose the segment number, and vertical lines "|" and "|" enclose short-form memory addresses.

Example of DA mode:

```
LDB RH2, <<15>> %23 !load RH2 with the!
                              !value in memory!
                              !segment 15, dis-!
                              !placement 23 (hex)!
```

Before Execution

R2 6789

Memory

<<15>>	0022	⋮
	0024	0206
		0304
		⋮

After Execution

R2 0689

5.5.5 Index (X). In the Index addressing mode, the instruction process data is located at an indexed address in memory. The indexed address is computed by adding the address specified in the instruction to an "index" contained in a word register, also specified by the instruction.

The *offset* of the operand address is computed by adding the 16-bit index value to the 8 or 16-bit offset portion of the address in the instruction. The segment *number* of the oper-

and address comes directly from the instruction. (Any overflow is ignored—it neither sets the Overflow flag nor increments the segment number. The segment number of the operand address comes directly from the instruction.) Indexed addressing allows random access to table or other complex data structures where the address of the base of the table is known, but the particular element index must be computed by the program.

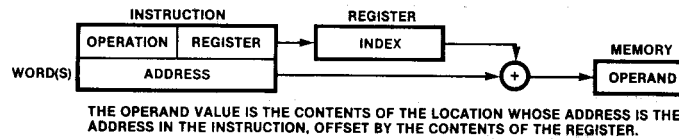

Any word register can be used as the index register *except* R0. The address in the instruction can be one or two words, depending on whether a long or short offset is used in the address.

Operands specified by X mode are always in the data memory address space.

Assembler language format:

address (Rn)

Example of X mode:

```
LD R4, <<5>> %231A(R3) !load into R4 the!
                              !contents of the!
                              !memory location!
                              !whose address is!
                              !segment 5,!
                              !displacement!
                              !231A + the!
                              !value in R3!
```

Before Execution

R3 01FE
R4 203A

Memory

<<5>>	2516	⋮
	2518	F3C2
	251A	7ADA
		⋮

Address Calculation

<<5>>	%231A
+	01FE
<<5>>	%2518

After Execution

R3 01FE
R4 3D0E

5.5.6 Relative Address (RA). In the Relative Addressing mode, the data processed is found at an address relative to the current instruction. The instruction specifies a two's complement displacement which is added to the offset of the Program Counter to form the target address. The Program Counter setting used is the address of the instruction *following* the currently executing instruction. (The assembler will take this into account in calculating the constant that is assembled into the instruction.)

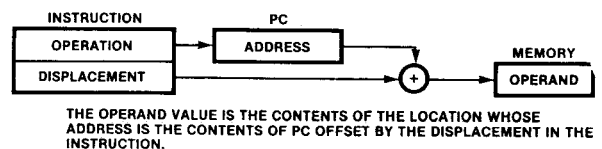

5.5 Descriptions and Examples (Segmented Z8001)
(Continued)

An operand specified by RA mode is always in the program memory address space. Either long or short format addresses may be used. As with the Direct Addressing mode, the Relative Addressing mode is also used by certain program control instructions to specify the address of the next instruction to be executed (specifically, the result of the addition of the Program Counter value and the displacement is loaded into the Program Counter). Relative addressing allows short references forward or backward from the current Program Counter value and is used only for such instructions as Jumps and Calls and special loads (LDR). Note that because the segment number is unchanged relative addresses are located in the same segment as the instruction.

Assembler language format (see also Chapter 6):

address

Example of RA mode:

```
LDR R2,$ + 6      !load into R2 the con-
                  !tents of the memory!
                  !location whose!
                  !address is the!
                  !current program!
                  !counter + 6!
```

Because the program counter will be advanced to point to the next instruction when the address calculation is performed, the constant that occurs in the instruction will actually be +2.

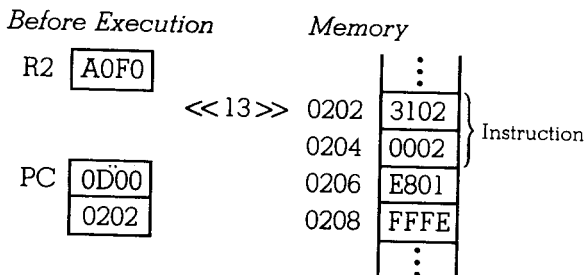

Address Calculation

$$\begin{array}{r} \ll 13 \gg 0206 \\ + \quad \quad 2 \\ \hline \ll 13 \gg 0208 \end{array}$$

After Execution

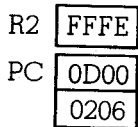

5.5.7 Base Address (BA). The Base Addressing mode is similar to Index mode in that a base and displacement are combined to produce the effective address. In Base Addressing, a register pair contains the 23-bit segmented base address and the displacement is expressed as a 16-bit value in the instruction. The displacement is added to the offset of the base address, and the resulting address points to the data to be processed. (The segment number is not changed.) This addressing mode may be used only with the Load instructions. Base Addressing mode, as a complement to Index mode, allows random access to records or other data structures where the displacement of an element within the structure is known, but the base of the particular structure must be computed by the program.

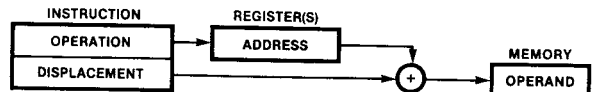

THE OPERAND VALUE IS THE CONTENTS OF THE LOCATION WHOSE ADDRESS IS THE ADDRESS IN THE REGISTER, OFFSET BY THE DISPLACEMENT IN THE INSTRUCTION.

Any double-word register can be used for the base address *except RR0*. The Base Address mode allows access to locations whose segment numbers are not known at assembly time.

An operand specified by BA mode will be in stack memory space if the base register is the stack pointer (RR14) and in data memory space otherwise.

If the segment number is known when the program is assembled (or loaded, for example, if the loader can resolve symbolic segment numbers), the Indexed addressing mode may be used to simulate the based addressing mode. For example, if R2 is known to hold segment number 18, then the operand specified using the based address RR2 (#93) can also be referenced by the indexed address << 18 >> 93 (R3). The advantage of this simulation is that indexing mode is supported for most operations, whereas based is restricted to LOAD and LOAD Address. Thus, using Indexed addressing is faster and leads to compact code.

Assembler language format (see also Chapter 6):

RRn(#disp) Add the immediate value to the contents of RRn; the result is the address of the operand.

5.5 Descriptions and Examples (Segmented Z8001)
(Continued)

Example of BA mode:

LDL RR4(##18),RR2 !load the long word!
!in RR2 into the!
!memory location!
!whose address is!
!the value of RR4!
!+ hex 18!

Before Execution

RR2	R2	0A00
	R3	1500
RR4	R4	2500
	R5	20AA

Memory

<< 31 >>	20C0	0ABE
	20C2	F50D
	20C4	BADE
	20C6	B0D1

Address Calculation

$$\begin{array}{r} \ll 31 \gg 20AA \\ + \quad 18 \\ \hline \ll 31 \gg 20C2 \end{array}$$

After Execution

RR2	R2	0A00
	R3	1500
RR4	R4	2500
	R5	20AA

Memory

<< 31 >>	20C0	0ABE
	20C2	0A00
	20C4	1500
	20C6	B0D1

5.5.8 Base Index (BX). The Base Index addressing mode is an extension of the Base Addressing mode and may be used only with the Load instructions. In this case, both the base address and index are held in registers. The index value is added to the offset of the base address to produce the offset of the

operand address. The segment number of the operand address is the same as the base address. This mode allows access to memory locations whose physical addresses are computed at runtime and are not fully known at assembly time.

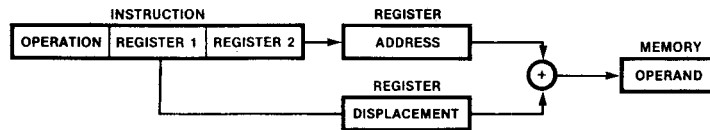

THE OPERAND VALUE IS THE CONTENTS OF THE LOCATION WHOSE ADDRESS IS THE CONTENTS OF THE ONE REGISTER OFFSET BY THE DISPLACEMENT IN THE SECOND REGISTER.

Any register pair can be used for the base address except RR0. Any word register except R0 can be used for the index. Note that the Short Offset format for base addresses is illegal in registers.

An operand specified by BX mode will be in stack memory space if the base register is the stack pointer (RR14) and in data memory otherwise.

Assembler language format (see also Chapter 6):

RRn (Rn)

Example of BX mode:

LD R2,RR4 (R3) !load into R2 the value!
!whose address is the!
!contents of RR4 +!
!the contents of R3!

Before Execution

RR2	R2	3535
	R3	FFFE
RR4	R4	0D00
	R5	1502

Memory

<< 13 >>	14FE	0101
	1500	B0DE
	1502	F732

Address Calculation

$$\begin{array}{r} \ll 13 \gg 1502 \\ + \quad FFEF \\ \hline \ll 13 \gg 1500 \end{array}$$

After Execution

RR2	R2	B0DE
	R3	FFFE
RR4	R4	0D00
	R5	1502

Memory

<< 13 >>	14FE	0101
	1500	B0DE
	1502	F732



Zilog
Zilog
Zilog
Zilog
Zilog

Chapter 6 Instruction Set

6.1 Introduction

This chapter describes the instruction set of the Z8000. An overview of the instruction set is presented first, in which the instructions are divided into ten functional groups. The instructions in each group are listed, followed by a summary description of the instructions. Significant characteristics shared by the instructions in the group, such as the available addressing modes, flags affected, or interruptibility, are described. Unusual instructions or features that are not typical of predecessor microprocessors are pointed out.

Following the functional summary of the instruction set, flags and condition codes are

discussed in relation to the instruction set. This is followed by a section discussing interruptibility of instructions and a description of traps. The last part of this chapter consists of a detailed description of each Z8000 instruction, listed in alphabetical order. This section is intended to be used as a reference by Z8000 programmers. The entry for each instruction includes a description of the instruction, addressing modes, assembly language mnemonics, instruction formats, execution times and simple examples illustrating the use of the instruction.

6.2 Functional Summary

This section presents an overview of the Z8000 instructions. For this purpose, the instructions may be divided into ten functional groups:

- Load and Exchange
- Arithmetic
- Logical
- Program Control
- Bit Manipulation
- Rotate and Shift
- Block Transfer and String Manipulation
- Input/Output
- CPU Control
- Extended Instructions

6.2.1 Load and Exchange Instructions.

Instruction	Operand(s)	Name of Instruction
CLR CLRB	dst	Clear
EX EXB	dst, src	Exchange
LD LDB LDL	dst, src	Load
LDA	dst, src	Load Address
LDAR	dst, src	Load Address Relative
LDK	dst, src	Load Constant
LDM	dst, src, num	Load Multiple
LDR LDRB LDRL	dst, src	Load Relative
POP POPL	dst, src	Pop
PUSH PUSHL	dst, src	Push

The Load and Exchange group includes a variety of instructions that provide for movement of data between registers, memory, and the program itself (i.e., immediate data). These instructions are supported with the widest range of addressing modes, including the Base (BA) and the Base Index (BX) mode which are available here only. None of these instructions affect any of the CPU flags.

The Load and Load Relative instructions transfer a byte, word, or long word of data from the source operand to the destination operand. A special one-word instruction, LDK, is also included to handle the frequent requirement for loading a small constant (0 to 15) into a register.

These instructions basically provide one of the following three functions:

- Load a register with data from a register or a memory location.
- Load a memory location with data from a register.
- Load a register or a memory location with immediate data.

The memory location is specified using any of the addressing modes (IR, DA, X, BA, BX, RA).

The Clear and Clear Byte instructions can be used to clear a register or memory location to zero. While this is functionally equivalent to a Load Immediate where the immediate data is zero, this operation occurs frequently enough to justify a special instruction that is more compact and faster.

6.2 Functional Summary
(Continued)

The Exchange instructions swap the contents of the source and destination operands.

The Load Multiple instruction provides for efficient saving and restoring of registers. This can significantly lower the overhead of procedure calls and context switches such as those that occur at interrupts. The instruction allows any contiguous group of 1 to 16 registers to be transferred to or from a memory area, which can be designated using the DA, IR or X addressing modes. (R0 is considered to follow R15, e.g., one may save R9-R15 and R0-R3 with a single instruction.)

Stack operations are supported by the PUSH, PUSHL, POP, and POPL instructions. Any general-purpose register (or register pair in segmented mode) may be used as the stack pointer (except R0 and RR0). The source operand for the Push instructions and the destination operand for the Pop instructions may be a register or a memory location, specified by the DA, IR, or X addressing modes. Immediate data can also be pushed onto a stack one word at a time. Note that byte operations are not supported, and the stack pointer register must contain an even value when a stack instruction is executed. This is consistent with the general restriction of using even addresses for word and long word accesses.

The Load Address and Load Address Relative instructions compute the effective address for the DA, X, BA, BX and RA modes and return the value in a register. They are useful for management of complex data structures.

6.2.2 Arithmetic Instructions

Instruction	Operand(s)	Name of Instruction
ADC	dst, src	Add with Carry
ADCB		
ADD	dst, src	Add
ADDB		
ADDL		
CP	dst, src	Compare
CPB		
CPL		
DAB	dst	Decimal Adjust
DEC	dst, src	Decrement
DECB		
DIV	dst, src	Divide
DIVL		
EXTS	dst	Extend Sign
EXTSB		
EXTSL		
INC	dst, src	Increment
INCB		
MULT	dst, src	Multiply
MULTL		
NEG	dst	Negate
NEGB		
SBC	dst, src	Subtract with Carry
SBCB		
SUB	dst, src	Subtract
SUBB		
SUBL		

The Arithmetic group consists of instructions for performing integer arithmetic. The basic instructions use standard two's complement binary format and operations. Support is also provided for implementation of BCD arithmetic.

Most of the instructions in this group perform an operation between a register operand and a second operand designated by any of the five basic addressing modes, and load the result into the register.

The arithmetic instructions in general alter the C, Z, S and P/V flags, which can then be tested by subsequent conditional jump instructions. The P/V flag is used to indicate arithmetic overflow for these instructions and it is referred to as the V (overflow) flag. The byte version of these instructions generally alters the D and H flags as well.

The basic integer (binary) operations are performed on byte, word or long word operands, although not all operand sizes are supported by all instructions. Multiple precision operations can be implemented in software using the Add with Carry, (ADDC, ADDCB), Subtract with Carry (SBC, SBCB) and Extend Sign (EXTS, EXTSB, EXTSL) instructions.

BCD operations are not provided directly, but can be implemented using a binary addition (ADDB, ADCB) or subtraction (SUBB, SBCB) followed by a decimal adjust instruction (DAB).

The Multiply and Divide instructions perform signed two's complement arithmetic on word or long word operands. The Multiply instruction (MULT) multiplies two 16-bit operands and produces a 32-bit result, which is loaded into the destination register pair. Similarly, Multiply Long (MULTL) multiplies two 32-bit operands and produces a 64-bit result, which is loaded into the destination register quadruple. An overflow condition is never generated by a multiply, nor can a true carry be generated. The carry flag is used instead to indicate where the product has too many significant bits to be contained entirely in the low-order half of the destination.

The Divide instruction (DIV) divides a 32-bit number in the destination register pair by a 16-bit source operand and loads a 16-bit quotient into the low-order half of the destination register. A 16-bit remainder is loaded into the high-order half. Divide Long (DIVL) operates similarly with a 64-bit destination register quadruple and a 32-bit source. The overflow flag is set if the quotient is bigger than the low-order half of the destination, or if the source is zero.

6.2 Functional 6.2.3 Logical Instructions.

Instruction	Operand(s)	Name of Instruction
AND ANDB	dst, src	And
COM COMB	dst	Complement
OR ORB	dst, src	Or
TEST TESTB TESTL	dst	Test
XOR XORB	dst, src	Exclusive Or

The instructions in this group perform logical operations on each of the bits of the operands. The operands may be bytes or words; logical operations on long word are not supported (except for TESTL) but are easily implemented with pairs of instructions.

The two-operand instructions, And (AND, ANDB), Or (OR, ORB) and Exclusive-Or (XOR, XORB) perform the appropriate logical operations on corresponding bits of the destination register and the source operand, which can be designated by any of the five basic addressing modes (R, IR, DA, IM, X). The result is loaded into the destination register.

Complement (COM, COMB) complements the bits of the destination operand. Finally, Test (TEST, TESTB, TESTL) performs the OR operation between the destination operand and zero and sets the flags accordingly. The Complement and Test instructions can use the five basic addressing modes to specify the destination.

The Logical instructions set the Z and S flags based on the result of the operation. The byte variants of these instructions also set the Parity Flag (P/V) if the parity of the result is even, while the word instructions leave this flag unchanged. The H and D flags are not affected by these instructions.

6.2.4 Program Control Instructions.

Instruction	Operand(s)	Name of Instruction
CALL	dst	Call Procedure
CALR	dst	Call Procedure Relative
DJNZ DBJNZ	r, dst	Decrement and Jump if Not Zero
IRET		Interrupt Return
JP	cc, dst	Jump
JR	cc, dst	Jump Relative
RET	cc	Return from Procedure
SC	src	System Call

This group consists of the instructions that affect the Program Counter (PC) and thereby control program flow. General-purpose

registers and memory are not altered except for the processor stack pointer and the processor stack, which play a significant role in procedures and interrupts. (An exception is Decrement and Jump if Not Zero (DJNZ), which uses a register as a loop counter.) The flags are also preserved except for IRET which reloads the program status, including the flags, from the processor stack.

The Jump (JP) and Jump Relative (JR) instructions provide a conditional transfer of control to a new location if the processor flags satisfy the condition specified in the condition code field of the instruction. (See Section 6.4 for a description of condition codes.) Jump Relative is a one-word instruction that will jump to any instruction within the range -254 to +256 bytes from the current location. Most conditional jumps in programs are made to locations only a few bytes away; the Jump Relative instruction exploits this fact to improve code compactness and efficiency.

Call and Call Relative are used for calling procedures; the current contents of the PC are pushed onto the processor stack, and the effective address indicated by the instruction is loaded into the PC. The use of a procedure address stack in this manner allows straightforward implementation of nested and recursive procedures. Like Jump Relative, Call Relative provides a one-word instruction for calling nearby subroutines. However, a much larger range, -4092 to +4098 bytes for CALR instruction, is provided since subroutine calls exhibit less locality than normal control transfers.

Both Jump and Call instructions are available with the indirect register, indexed and relative address modes in addition to the direct address mode. These can be useful for implementing complex control structures such as dispatch tables.

The Conditional Return instruction is a companion to the Call instruction; if the condition specified in the instruction is satisfied, it loads the PC from the stack and pops the stack.

A special instruction, Decrement and Jump if Not Zero (DJNZ, DBJNZ), implements the control part of the basic FOR loop in a one-word instruction.

System Call (SC) is used for controlled access to facilities provided by the operating system. It is implemented identically to a trap or interrupt: the current program status is pushed onto the system processor stack followed by the instruction itself, and a new program status is loaded from a dedicated part of

6.2 Functional Summary (Continued) the Program Status Area. An 8-bit immediate source field in the instruction is ignored by the CPU hardware. It can be retrieved from the stack by the software which handles system calls and interpreted as desired, for example as an index into a dispatch table to implement a call to one of the services provided by the operating system.

Interrupt Return (IRET) is used for returning from interrupts and traps, including system calls, to the interrupted routines. This is a privileged instruction.

6.2.5 Bit Manipulation Instructions

Instruction	Operand(s)	Name of Instruction
BIT BITB	dst, src	Bit Test
RES RESB	dst, src	Reset Bit
SET SETB	dst, src	Set Bit
TSET TSETB	dst	Test and Set
TCC TCCB	cc, dst	Test condition code

The instructions in this group are useful for manipulating individual bits in registers or memory. In most computers, this has to be done using the logical instructions with suitable masks, which is neither natural nor efficient.

The Bit Set (SET, SETB) and Bit Reset (RES, RESB) instructions set or clear a single bit in the destination byte or word, which can be in a register or in a memory location specified by any of the five basic addressing modes. The particular bit to be manipulated may be specified statically by a value (0 to 7 for byte, 0 to 15 for word) in the instruction itself or it may be specified dynamically by the contents of a register, which could have been computed by previous instructions. In the latter case, the destination is restricted to a register. These instructions leave the flags unaffected. The companion Bit Test instruction (BIT, BITB) similarly tests a specified bit and sets the Z flag according to the state of the bit.

The Test and Set instruction (TSET, TSETB) is useful in multiprogramming and multiprocessing environments. It can be used for implementing synchronization mechanisms between processes on the same or different CPUs.

Another instruction in this group, Test Condition Code (TCC, TCCB) sets a bit in the destination register based on the state of the flags as specified by the condition code in the

instruction. (See Section 5.6.1 for a list of condition codes.) This may be used to control subsequent operation of the program after the flags have been changed by intervening instructions. It may also be used by language compilers for generating boolean values.

6.2.6 Rotate and Shift Instructions.

Instruction	Operand(s)	Name of Instruction
RL RLB	dst, src	Rotate Left
RLC RLCB	dst, src	Rotate Left through Carry
RLDB	dst, src	Rotate Left Digit
RR RRB	dst, src	Rotate Right
RRC RRCB	dst, src	Rotate Right through Carry
RRDB	dst, src	Rotate Right Digit
SDA SDAB SDAL	dst, src	Shift Dynamic Arithmetic
SDL SDLB SDLL	dst, src	Shift Dynamic Logical
SLA SLAB SLAL	dst, src	Shift Left Arithmetic
SLL SLLB SLLL	dst, src	Shift Left Logical
SRA SRAB SRAL	dst, src	Shift Right Arithmetic
SRL SRLB SRLL	dst, src	Shift Right Logical

This group contains a rich repertoire of instructions for shifting and rotating data registers.

Instructions for shifting arithmetically or logically in either direction are available. Three operand lengths are supported: 8, 16 and 32 bits. The amount of the shift, which may be any value up to the operand length, can be specified statically by a field in the instruction or dynamically by the contents of a register. The ability to determine the shift amount dynamically is a useful feature, which is not available in most minicomputers.

The rotate instructions will rotate the contents of a byte or word register in either direction by one or two bits; the carry bit can be included in the rotation. A pair of digit rotation instructions (RLDB, RRDB) are especially useful in manipulating BCD data.

6.2 Functional Summary (Continued) 6.2.7 Block Transfer And String Manipulation Instructions.

Instruction	Operand(s)	Name of Instruction
CPD CPDB	dst, src, r, cc	Compare and Decrement
CPDR CPDRB	dst, src, r, cc	Compare, Decrement and Repeat
CPI CPIB	dst, src, r, cc	Compare and Increment
CPIR CPIRB	dst, src, r, cc	Compare, Increment and Repeat
CPSD CPSDB	dst, src, r, cc	Compare String and Decrement
CPSDR CPSDRB	dst, src, r, cc	Compare String, Decrement and Repeat
CPSI CPSIB	dst, src, r, cc	Compare String and Increment
CPSIR CPSIRB	dst, src, r, cc	Compare String, Increment and Repeat
LDD Lddb	dst, src, r	Load and Decrement
LDDR LDRB	dst, src, r	Load, Decrement and Repeat
LDI LDIB	dst, src, r	Load and Increment
LDIR LDIRB	dst, src, r	Load, Increment and Repeat
TRDB	dst, src, r	Translate and Decrement
TRDRB	dst, src, r	Translate, Decrement and Repeat
TRIB	dst, src, r	Translate and Increment
TRIRB	dst, src, r	Translate, Increment and Repeat
TRTDB	src1, src2, r	Translate, Test and Decrement
TRTDRB	src1, src2, r	Translate, Test, Decrement and Repeat
TRTIB	src1, src2, r	Translate, Test and Increment
TRTIRB	src1, src2, r	Translate, Test, Increment and Repeat

This is an exceptionally powerful group of instructions that provides a full complement of string comparison, string translation and block transfer functions. Using these instructions, a byte or word block of any length up to 64K bytes can be moved in memory; a byte or word string can be searched until a given value is found; two byte or word strings can be compared; and a byte string can be translated by

using the value of each byte as the address of its own replacement in a translation table. The more complex Translate and Test instructions skip over a class of bytes specified by a translation table, detecting bytes with values of special interest.

All the operations can proceed through the data in either direction. Furthermore, the operations may be repeated automatically while decrementing a length counter until it is zero, or they may operate on one storage unit per execution with the length counter decremented by one and the source and destination pointer registers properly adjusted. The latter form is useful for implementing more complex operations in software by adding other instructions within a loop containing the block instructions.

Any word register can be used as a length counter in most cases. If the execution of the instruction causes this register to be decremented to zero, the P/V flag is set. The auto-repeat forms of these instructions always leave this flag set.

The D and H flags are not affected by any of these instructions. The C and S flags are preserved by all but the compare instructions.

These instructions use the Indirect Register (IR) addressing mode: the source and destination operands are addressed by the contents of general-purpose registers (word registers in nonsegmented mode and register pairs in segmented mode). Note that in the segmented mode, only the low-order half of the register pair gets incremented or decremented as with all address arithmetic in the Z8000.

The repetitive forms of these instructions are interruptible. This is essential since the repetition count can be as high as 65,536 and the instructions can take 9 to 14 cycles for each iteration after the first one. The instruction can be interrupted after any iteration. The address of the instruction itself, rather than the next one, is saved on the stack, and the contents of the operand pointer registers, as well as the repetition counter, are such that the instruction can simply be reissued after returning from the interrupt without any visible difference in its effect.

6.2 Functional 6.2.8 Input/Output Instructions.

Summary (Continued)	Instruction	Operand(s)	Name of Instruction
	IN INB	dst, src	Input
	IND INDB	dst, src, r	Input and Decrement
	INDR INDRB	dst, src, r	Input, Decrement and Repeat
	INI INIB	dst, src, r	Input and Increment
	INIR INIRB	dst, src, r	Input, Increment and Repeat
	OTDR OTDRB	dst, src, r	Output, Decrement and Repeat
	OTIR OTIRB	dst, src, r	Output, Increment and Repeat
	OUT OUTB	dst, src	Output
	OUTD OUTDB	dst, src, r	Output and Decrement
	OUTI OUTIB	dst, src, r	Output and Increment
	SIN SINB	dst, src	Special Input
	SIND SINDB	dst, src, r	Special Input and Decrement
	SINDR SINDRB	dst, src, r	Special Input, Decrement and Repeat
	SINI SINIB	dst, src, r	Special Input and Increment
	SINIR SINIRB	dst, src, r	Special Input, Increment and Repeat
	SOTDR SOTDRB	dst, src, r	Special Output, Decrement and Repeat
	SOTIR SOTIRB	dst, src, r	Special Output, Increment and Repeat
	SOUT SOUTB	dst, src	Special Output
	SOUTD SOUTDB	dst, src, r	Special Output and Decrement
	SOUTI SOUTIB	dst, src, r	Special Output and Increment

This group consists of instructions for transferring a byte, word or block of data between peripheral devices and the CPU registers or memory. Two separate I/O address spaces with 16-bit addresses are recognized, a Standard I/O address space and a Special I/O address space. The latter is intended for use with special Z8000 Family devices, typically the Z-MMU. Instructions that operate on the Special I/O address space are prefixed with the word "special." Standard I/O and Special I/O instructions generate different codes on the CPU status lines. Normal 8-bit peripherals are connected to bus lines AD₀-AD₇. Standard I/O byte instructions use odd addresses only. Special 8-bit peripherals such as the MMU, which are used with special I/O instructions,

are connected to bus lines AD₈-AD₁₅. Special I/O byte instructions use even addresses only.

The instructions for transferring a single byte or word (IN, INB, OUT, OUTB, SIN, SINB, SOUT, SOUTB) can transfer data between any general-purpose register and any port in either address space. For the Standard I/O instructions, the port number may be specified statically in the instruction or dynamically by the contents of the CPU register. For the Special I/O instructions the port number is specified statically.

The remaining instructions in this group form a powerful and complete complement of instructions for transferring blocks of data between I/O ports and memory. The operation of these instructions is very similar to that of the block move instructions described earlier, with the exception that one operand is always an I/O port which remains unchanged as the address of the other operand (a memory location) is incremented or decremented. These instructions are also interruptible.

All I/O instructions are privileged, i.e. they can only be executed in system mode. The single byte/word I/O instructions don't alter any flags. The block I/O instructions, including the single iteration variants, alter the Z and P/V flags. The latter is set when the repetition counter is decremented to zero.

6.2.9 CPU Control Instructions.

Instruction	Operand(s)	Name of Instruction
COMFLG	flag	Complement Flag
DI	int	Disable Interrupt
EI	int	Enable Interrupt
HALT		Halt
LDCTL LDCTLB	dst, src	Load Control Register
LDPS	src	Load Program Status
MBIT		Multi-Micro Bit Test
MREQ	dst	Multi-Micro Request
MRES		Multi-Micro Reset
MSET		Multi-Micro Set
NOP		No Operation
RESFLG	flag	Reset Flag
SETFLG	flag	Set Flag

The instructions in this group relate to the CPU control and status registers (FCW, PSAP, REFRESH, etc.), or perform other unusual functions that do not fit into any of the other groups, such as instructions that support multi-microprocessor operation. Most of these instructions are privileged, with the exception of NOP and the instructions operating on the flags (SETFLG, RESFLG, COMFLG, LDCTLB).

6.2 Functional 6.2.10 Extended Instructions. The Z8000

Summary (Continued)

architecture includes a powerful mechanism for extending the basic instruction set through the use of external devices known as Extended Processing Units (EPUs). (See Section 2.12 for a more comprehensive presentation of the Extended Processor Architecture.) A group of six opcodes, 0E, 0F, 4E, 4F, 8E and 8F (in hexadecimal), is dedicated for the implementation of extended instructions using this facility. The five basic addressing modes (R, IR, DA, IM and X) can be used by extended instructions for accessing data for the EPUs.

There are four types of extended instructions in the Z8000 CPU instruction repertoire: EPU internal operations; data transfers between

memory and EPU; data transfers between EPU and CPU; and data transfers between EPU flag registers and CPU flag and control word. The last type is useful when the program must branch based on conditions determined by the EPU. The action taken by the CPU upon encountering extended instructions is dependent upon the EPA control bit in the CPU's FCW. When this bit is set, it indicates that the system configuration includes EPUs; therefore, the instruction is executed. If this bit is clear, the CPU traps (extended instruction trap) so that a trap handler in software can emulate the desired operation.

6.3 Processor Traps

The processor flags are a part of the program status (Section 2.7.1). They provide a link between sequentially executed instructions in the sense that the result of executing one instruction may alter the flags, and the resulting value of the flags may be used to determine the operation of a subsequent instruction, typically a conditional jump instruction. An example is a Test followed by a Conditional Jump:

```
TEST R1          !sets Z FLAG if R1 = 0!
JR Z, DONE      !go to done if Z flag is set!
```

DONE:

The program branches to DONE if the TEST sets the Z flag, i.e., if R1 contains zero.

The program status has six flags for the use of the programmer and the Z8000 processor:

- Carry (C)
- Zero (Z)
- Sign (S)
- Parity/Overflow (P/V)
- Decimal Adjust (D)
- Half Carry (H)

The flags are modified by many instructions, including the arithmetic and logical instructions.

Appendix C lists the instructions and the flags they affect. In addition, there are Z8000 CPU control instructions which allow the programmer to set, reset (clear), or complement any or all of the first four flags. The Half-Carry and Decimal-Adjust flags are used by the Z8000 processor for BCD arithmetic corrections. They are not used explicitly by the programmer.

The FLAGS register can be separately loaded by the Load Control Register (LDCTLB) instruction without disturbing the control bits in the other byte of the FCW. The contents of the flag register may also be saved in a register or memory.

The Carry (C) flag, when set, generally indicates a carry out of or a borrow into the high-order bit position of a register being used as an accumulator. For example, adding the 8-bit numbers 225 and 64 causes a carry out of bit 7 and sets the Carry flag:

	7	6	5	4	3	2	1	0
225	1	1	1	0	0	0	0	1
+ 64	0	1	0	0	0	0	0	0
289	0	0	1	0	0	0	0	1

↳ 1 = Carry flag

The Carry flag plays an important role in the implementation of multiple-precision arithmetic (see the ADC, SBC instructions). It is also involved in the Rotate Left Through Carry (RLC) and Rotate Right Through Carry (RRC) instructions. One of these instructions is used to implement rotation or shifting of long strings of bits.

The Zero (Z) flag is set when the result register's contents are zero following certain operations. This is often useful for determining when a counter reaches zero. In addition, the block compare instructions use the Z flag to indicate when the specified comparison condition is satisfied.

The Sign (S) flag is set to one when the most significant bit of a result register contains a one (a negative number in two's complement notation) following certain operations.

6.3 Processor Traps (Continued)

The Overflow (V) flag, when set, indicates that a two's complement number in a result register has exceeded the largest number or is less than the smallest number that can be represented in a two's complement notation. This flag is set as the result of an arithmetic operation. Consider the following example:

	7	6	5	4	3	2	1	0
120	0	1	1	0	1	0	0	1
+ 105	0	1	1	0	1	0	0	1
225	1	1	1	0	0	0	0	1
	1	1	1	0	0	0	0	1

↙
↘ = Overflow flag

The result in this case (-95 in two's complement notation) is incorrect, thus the overflow flag would be set.

The same bit acts as a Parity (P) flag following logical instructions on byte operands. The number of one bits in the register is counted and the flag is set if the total is even (that is, P = 1). If the total is odd (P = 0), the flag is reset. This flag is often referred to as the P/V flag.

6.4 Condition Codes

The first four flags, C, Z, S, and P/V, are used to control the operation of certain "conditional" instructions such as the Conditional Jump. The operation of these instructions is a function of whether a specified boolean condition on the four flags is satisfied or not. It would take 16 bits to specify any of the 65,536 (2¹⁶) boolean functions of the four flags. Since only a very small fraction of these are generally of interest, this procedure would be very wasteful. Sixteen functions of the flag settings found to be frequently useful are encoded in a 4-bit field called the condition code, which

The Block Move and String instructions and the Block I/O instructions use the P/V flag to indicate the repetition counter has decremented to 0.

The Decimal-Adjust (D) flag is used for BCD arithmetic. Since the algorithm for correcting BCD operations is different for addition and subtraction, this flag is used to record whether an add or subtract instruction was executed so that the subsequent Decimal Adjust (DAB) instruction can perform its function correctly (See the DAB instruction for further discussion on the use of this flag).

The Half-Carry (H) flag indicates a carry out of bit 3 or a borrow into bit 3 as the result of adding or subtracting bytes containing two BCD digits each. This flag is used by the DAB instruction to convert the binary result of a previous decimal addition or subtraction into the correct decimal (BCD) result.

Neither the Decimal-Adjust nor the Half-Carry flag is normally accessed by the programmer. The specific operations affecting the flags are detailed in Section 5.6.

forms a part of all conditional instructions.

The condition codes and the flag settings they represent are listed in Section 6.6.

Although there are sixteen unique condition codes, the assembler recognizes more than sixteen mnemonics for the conditional codes. Some of the flag settings have more than one meaning for the programmer, depending on the context (PE & OV, Z & EQ, C & ULT, etc.). Program clarity is enhanced by having separate mnemonics for the same binary value of the condition codes in these cases.

6.5 Instruction Interrupts and Traps

Interrupts are discussed in detail in Section 7. This section looks at the relationship between instructions and interrupts.

When the CPU receives an interrupt request, and it is enabled for interrupts of that class, the interrupt is normally processed at the end of the current instruction. However, certain instructions which might take a long time to complete are designed to be interruptible so as to minimize the length of time it takes the CPU to respond to an interrupt. These are the iterative versions of the String and Block instructions and the Block I/O instruction. If an interrupt request is received during one of these interruptible instructions, the instruction is suspended after the current iteration. The address of the instruction itself, rather than the address of the following instruction, is saved on the stack, so that the same instruction is executed again when the interrupt handler executes an IRET. The con-

tents of the repetition counter and the registers which index into the block operands are such that after each iteration when the instruction is reissued upon returning from an interrupt, the effect is the same as if the instruction were not interrupted. This assumes, of course, the interrupt handler preserved the registers, which is a general requirement on interrupt handlers.

The longest noninterruptible instruction that can be used in normal mode is Divide Long (728 cycles in the worst case). Multi-Micro-Request, a privileged instruction, can take longer depending on the contents of the destination register.

Traps are synchronous events that result from the execution of an instruction. The action of the CPU in response to a trap condition is similar to the case of an interrupt (see Section 7). Traps are non-maskable.

6.5 Instruction Interrupts and Traps (Continued)

The Z8000 CPUs implement four kinds of traps:

- Extended Instruction
- Privileged Instruction in normal mode
- segmentation violation
- System Call

The Extended Instruction trap occurs when an Extended Instruction is encountered, but the Extended Processor Architecture Facility is disabled, i.e., the EPA bit in the FCW is a zero. This allows the same software to be run on Z8000 system configurations with or without EPU's. On systems without EPU's, the desired extended instructions can be emulated by software which is invoked by the Extended Instruction trap.

6.6 Notation and Binary Encoding

The rest of this chapter consists of detailed descriptions of each instruction, listed in alphabetical order. This section describes the notational conventions used in the instruction descriptions and the binary encoding for some of the common instruction fields (e.g., register designation fields).

The description of an instruction begins with the instruction mnemonic and instruction name in the top part of the page. Privileged instructions are also identified at the top.

The assembler language syntax is then given in a single generic form that covers all the variants of the instruction, along with a list of applicable addressing modes.

Example:

```
AND dst, src    dst: R
ANDB           src: R, IM, IR, DA, X
```

The operation of the instruction is presented next, followed by a detailed discussion of the instruction.

The next part specifies the effect of the instruction on the processor flags. This is followed by a table that presents all the variants of the instruction for each applicable addressing mode and operand size. For each of these variants, the following information is provided:

A. Assembler Language Syntax. The syntax is shown for each applicable operand width (byte, word or long). The invariant part of the syntax is given in UPPER CASE and must appear as shown. Lower case characters represent the variable part of the syntax, for which suitable values are to be substituted. The syntax shown is for the most basic form of the

The privileged instruction trap serves to protect the integrity of a system from erroneous or unauthorized actions of arbitrary processes. Certain instructions, called privileged instructions, can only be executed in system mode. An attempt to execute one of these instructions in normal mode causes a privileged instruction trap. All the I/O instructions and most of the instructions that operate on the FCW are privileged, as are instructions like HALT and IRET.

The System Call instruction always causes a trap. It is used to transfer control to system mode software in a controlled way, typically to request supervisor services.

instruction recognized by the assembler. For example,

```
AND Rd,#data
```

represents a statement of the form ADD R3,#35. The assembler will also accept variations like ADD TOTAL, #NEW-DELTA where TOTAL, NEW and DELTA have been suitably defined.

The following notation is used for register operands:

Rd, Rs, etc.:	a word register in the range R0-R15
Rbd Rbs:	a byte register RHn or RLn where n = 0 - 7
RRd RR:	a register pair RR0, RR2, ... RR14
RQd:	a register quadruple RR0, RR4, RR8 or RR12

The "s" or "d" represents a source or destination operand. Address registers used in Indirect, Base and Base Index addressing modes represent word registers in nonsegmented mode and register pairs in segmented mode. A one-word register used in segmented mode is flagged and a footnote explains the situation.

B. Instruction Format. The binary encoding of the instruction is given in each case for both the nonsegmented and segmented modes. Where applicable, both the short and long forms of the segmented version are given (SS and SL).

The instruction formats for byte and word versions of an instruction are usually combined. A single bit, labeled "w," distinguishes

6.6 Notation and Binary Encoding
(Continued)

them: a one indicates a word instruction, while a zero indicates a byte instruction.

Fields specifying register operands are identified with the same symbols (Rs, RRd, etc.) as in Assembler Language Syntax. In some cases, only nonzero values are permitted for certain registers, such as index registers. This is indicated by a notation of the form "RS ≠ 0."

The binary encoding for register fields is as follows:

	Register		Binary	
RQ0	RR0	R0	RH0	0000
		R1	RH1	0001
	RR2	R2	RH2	0010
RQ4	RR4	R3	RH3	0011
		R4	RH4	0100
	RR6	R5	RH5	0101
		R6	RH6	0110
RQ8	RR8	R7	RH7	0111
		R8	RLO	1000
	RR10	R9	RL1	1001
		R10	RL2	1010

Register		Binary		
RQ12	RR12	R11	RL3	1011
		R12	RL4	1100
RR14		R13	RL5	1101
		R14	RL6	1110
		R15	RL7	1111

For easy cross-references, the same symbols are used in the Assembler Language Syntax and the instruction format. In the case of addresses, the instruction format in segmented mode uses "segment" and "offset" to correspond to "address," while the instruction format contains "displacement," indicating that the assembler has computed the displacement and inserted it as indicated.

A condition code is indicated by "cc" in both the Assembler Language Syntax and the instruction formats. The condition codes, the flag settings they represent, and the binary encoding in the instruction are as follows:

Code	Meaning	Flag Setting	Binary
F	Always false	-	0000
	Always true	-	1000
Z	Zero	Z = 1	0110
NZ	Not zero	Z = 0	1110
C	Carry	C = 1	0111
NC	No carry	C = 0	1111
PL	Plus	S = 0	1101
MI	Minus	S = 1	0101
NE	Not equal	Z = 0	1110
EQ	Equal	Z = 1	0110
OV	Overflow	V = 1	0100
NOV	No overflow	V = 0	1100
PE	Parity even	P = 1	0100
PO	Parity odd	P = 0	1100
GE	Greater than or equal	(S XOR V) = 0	1001
LT	Less than	(S XOR V) = 1	0001
GT	Greater than	(Z OR (S XOR V)) = 0	1010
LE	Less than or equal	(Z OR (S XOR V)) = 1	0010
UGE	Unsigned greater than or equal	C = 0	1111
ULT	Unsigned less than	C = 1	0111
UGT	Unsigned greater than	((C = 0) AND (Z = 0)) = 1	1011
ULE	Unsigned less than or equal	(C OR Z) = 1	0011

Note that some of the condition codes correspond to identical flag settings: i.e., Z-EQ, NZ-NE, NC-UGE, PE-OV, PO-NOV.

C. Cycles. This line gives the execution time of the instructions in CPU cycles.

D. Example. A short assembly language example is given showing the use of the instruction.

ADC dst, src dst: R
ADCB src: R

Operation: dst ← dst + src + c

The source operand, along with the setting of the carry flag, is added to the destination operand and the sum is stored in the destination. The contents of the source are not affected. Two's complement addition is performed. In multiple precision arithmetic, this instruction permits the carry from the addition of low-order operands to be carried into the addition of high-order operands.

- Flags:**
- C:** Set if there is a carry from the most significant bit of the result; cleared otherwise
 - Z:** Set if the result is zero; cleared otherwise
 - S:** Set if the result is negative; cleared otherwise
 - V:** Set if arithmetic overflow occurs, that is, if both operands were of the same sign and the result is of the opposite sign; cleared otherwise
 - D:** ADC—unaffected; ADCB—cleared
 - H:** ADC—unaffected; ADCB—set if there is a carry from the most significant bit of the low-order four bits of the result; cleared otherwise

Addressing Mode	Assembler Language Syntax	Nonsegmented Mode		Segmented Mode											
		Instruction Format	Cycles	Instruction Format	Cycles										
R:	ADC Rd, Rs ADCB Rbd, Rbs	<table border="1" style="display: inline-table;"> <tr> <td>10</td><td>11010</td><td>W</td><td>Rs</td><td>Rd</td> </tr> </table>	10	11010	W	Rs	Rd	5	<table border="1" style="display: inline-table;"> <tr> <td>10</td><td>11010</td><td>W</td><td>Rs</td><td>Rd</td> </tr> </table>	10	11010	W	Rs	Rd	5
10	11010	W	Rs	Rd											
10	11010	W	Rs	Rd											

Example: Long addition can be done with the following instruction sequence, assuming R0, R1 contain one operand and R2, R3 contain the other operand:

```

ADD  R1,R3           !add low-order words!
ADC  R0,R2           !add carry and high-order words!

```

If R0 contains %0000, R1 contains %FFFF, R2 contains %4320 and R3 contains %0001, then the above two instructions leave the value %4321 in R0 and %0000 in R1.

ADD

Add

ADD dst, src dst: R
ADDB src: R, IM, IR, DA, X
ADDL

Operation: dst ← dst + src

The source operand is added to the destination operand and the sum is stored in the destination. The contents of the source are not affected. Two's complement addition is performed.

Flags: **C:** Set if there is a carry from the most significant bit of the result; cleared otherwise
Z: Set if the result is zero; cleared otherwise
S: Set if the result is negative; cleared otherwise
V: Set if arithmetic overflow occurs, that is, if both operands were of the same sign and the result is of the opposite sign; cleared otherwise
D: ADD, ADDL—unaffected; ADDB—cleared
H: ADD, ADDL—unaffected; ADDB—set if there is a carry from the most significant bit of the low-order four bits of the result; cleared otherwise

Source Addressing Mode	Assembler Language Syntax	Nonsegmented Mode		Segmented Mode																									
		Instruction Format	Cycles	Instruction Format	Cycles																								
R:	ADD Rd, Rs	<table border="1"><tr><td>10</td><td>00000</td><td>W</td><td>Rs</td><td>Rd</td></tr></table>	10	00000	W	Rs	Rd	4	<table border="1"><tr><td>10</td><td>00000</td><td>W</td><td>Rs</td><td>Rd</td></tr></table>	10	00000	W	Rs	Rd	4														
	10	00000	W	Rs	Rd																								
10	00000	W	Rs	Rd																									
ADDB Rbd, Rbs																													
ADDL RRd, RRs		<table border="1"><tr><td>10</td><td>010110</td><td>RRs</td><td>RRd</td></tr></table>	10	010110	RRs	RRd	8	<table border="1"><tr><td>10</td><td>010110</td><td>RRs</td><td>RRd</td></tr></table>	10	010110	RRs	RRd	8																
	10	010110	RRs	RRd																									
10	010110	RRs	RRd																										
IM:	ADD Rd, #data	<table border="1"><tr><td>00</td><td>000001</td><td>0000</td><td>Rd</td></tr><tr><td colspan="4">data</td></tr></table>	00	000001	0000	Rd	data				7	<table border="1"><tr><td>00</td><td>000001</td><td>0000</td><td>Rd</td></tr><tr><td colspan="4">data</td></tr></table>	00	000001	0000	Rd	data				7								
	00	000001	0000	Rd																									
	data																												
00	000001	0000	Rd																										
data																													
ADDB Rbd, #data		<table border="1"><tr><td>00</td><td>000000</td><td>0000</td><td>Rd</td></tr><tr><td colspan="2">data</td><td colspan="2">data</td></tr></table>	00	000000	0000	Rd	data		data		7	<table border="1"><tr><td>00</td><td>000000</td><td>0000</td><td>Rd</td></tr><tr><td colspan="2">data</td><td colspan="2">data</td></tr></table>	00	000000	0000	Rd	data		data		7								
	00	000000	0000	Rd																									
	data		data																										
00	000000	0000	Rd																										
data		data																											
ADDL RRd, #data		<table border="1"><tr><td>00</td><td>010110</td><td>0000</td><td>RRd</td></tr><tr><td colspan="2">31 data (high) 16</td><td colspan="2"></td></tr><tr><td colspan="2">15 data (low) 0</td><td colspan="2"></td></tr></table>	00	010110	0000	RRd	31 data (high) 16				15 data (low) 0				14	<table border="1"><tr><td>00</td><td>010110</td><td>0000</td><td>RRd</td></tr><tr><td colspan="2">31 data (high) 16</td><td colspan="2"></td></tr><tr><td colspan="2">15 data (low) 0</td><td colspan="2"></td></tr></table>	00	010110	0000	RRd	31 data (high) 16				15 data (low) 0				14
	00	010110	0000	RRd																									
	31 data (high) 16																												
15 data (low) 0																													
00	010110	0000	RRd																										
31 data (high) 16																													
15 data (low) 0																													
IR:	ADD Rd, @Rs1	<table border="1"><tr><td>00</td><td>00000</td><td>W</td><td>Rs ≠ 0</td><td>Rd</td></tr></table>	00	00000	W	Rs ≠ 0	Rd	7	<table border="1"><tr><td>00</td><td>00000</td><td>W</td><td>Rs ≠ 0</td><td>Rd</td></tr></table>	00	00000	W	Rs ≠ 0	Rd	7														
	00	00000	W	Rs ≠ 0	Rd																								
	00	00000	W	Rs ≠ 0	Rd																								
ADDB Rbd, @Rs1																													
ADDL RRd, @Rs1		<table border="1"><tr><td>00</td><td>010110</td><td>Rs ≠ 0</td><td>RRd</td></tr></table>	00	010110	Rs ≠ 0	RRd	14	<table border="1"><tr><td>00</td><td>010110</td><td>Rs ≠ 0</td><td>RRd</td></tr></table>	00	010110	Rs ≠ 0	RRd	14																
	00	010110	Rs ≠ 0	RRd																									
00	010110	Rs ≠ 0	RRd																										

Source Addressing Mode	Assembler Language Syntax	Nonsegmented Mode		Segmented Mode																					
		Instruction Format	Cycles	Instruction Format	Cycles																				
DA:	ADD Rd, address ADDB Rbd, address	<table border="1"><tr><td>01</td><td>00000</td><td>W</td><td>0000</td><td>Rd</td></tr><tr><td colspan="5">address</td></tr></table>	01	00000	W	0000	Rd	address					9	SS <table border="1"><tr><td>01</td><td>00000</td><td>W</td><td>0000</td><td>Rd</td></tr><tr><td>0</td><td>segment</td><td colspan="3">offset</td></tr></table>	01	00000	W	0000	Rd	0	segment	offset			10
		01	00000	W	0000	Rd																			
	address																								
	01	00000	W	0000	Rd																				
0	segment	offset																							
SL <table border="1"><tr><td>01</td><td>00000</td><td>W</td><td>0000</td><td>Rd</td></tr><tr><td>1</td><td>segment</td><td colspan="3">00000000</td></tr><tr><td colspan="5">offset</td></tr></table>	01	00000	W	0000	Rd	1	segment	00000000			offset					12									
01	00000	W	0000	Rd																					
1	segment	00000000																							
offset																									
ADDL RRd, address	<table border="1"><tr><td>01</td><td>010110</td><td>0000</td><td>RRd</td></tr><tr><td colspan="5">address</td></tr></table>	01	010110	0000	RRd	address					15	SS <table border="1"><tr><td>01</td><td>010110</td><td>0000</td><td>RRd</td></tr><tr><td>0</td><td>segment</td><td colspan="3">offset</td></tr></table>	01	010110	0000	RRd	0	segment	offset			16			
	01	010110	0000	RRd																					
address																									
01	010110	0000	RRd																						
0	segment	offset																							
SL <table border="1"><tr><td>01</td><td>010110</td><td>0000</td><td>RRd</td></tr><tr><td>1</td><td>segment</td><td colspan="3">00000000</td></tr><tr><td colspan="5">offset</td></tr></table>	01	010110	0000	RRd	1	segment	00000000			offset					18										
01	010110	0000	RRd																						
1	segment	00000000																							
offset																									
X:	ADD Rd, addr(Rs) ADDB Rbd, addr(Rs)	<table border="1"><tr><td>01</td><td>00000</td><td>W</td><td>Rs≠0</td><td>Rd</td></tr><tr><td colspan="5">address</td></tr></table>	01	00000	W	Rs≠0	Rd	address					10	SS <table border="1"><tr><td>01</td><td>00000</td><td>W</td><td>Rs≠0</td><td>Rd</td></tr><tr><td>0</td><td>segment</td><td colspan="3">offset</td></tr></table>	01	00000	W	Rs≠0	Rd	0	segment	offset			10
		01	00000	W	Rs≠0	Rd																			
	address																								
	01	00000	W	Rs≠0	Rd																				
0	segment	offset																							
SL <table border="1"><tr><td>01</td><td>00000</td><td>W</td><td>Rs≠0</td><td>Rd</td></tr><tr><td>1</td><td>segment</td><td colspan="3">00000000</td></tr><tr><td colspan="5">offset</td></tr></table>	01	00000	W	Rs≠0	Rd	1	segment	00000000			offset					13									
01	00000	W	Rs≠0	Rd																					
1	segment	00000000																							
offset																									
ADDL RRd, addr(Rs)	<table border="1"><tr><td>01</td><td>010110</td><td>Rs≠0</td><td>RRd</td></tr><tr><td colspan="5">address</td></tr></table>	01	010110	Rs≠0	RRd	address					16	SS <table border="1"><tr><td>01</td><td>010110</td><td>Rs≠0</td><td>RRd</td></tr><tr><td>0</td><td>segment</td><td colspan="3">offset</td></tr></table>	01	010110	Rs≠0	RRd	0	segment	offset			16			
	01	010110	Rs≠0	RRd																					
address																									
01	010110	Rs≠0	RRd																						
0	segment	offset																							
SL <table border="1"><tr><td>01</td><td>010110</td><td>Rs≠0</td><td>RRd</td></tr><tr><td>1</td><td>segment</td><td colspan="3">00000000</td></tr><tr><td colspan="5">offset</td></tr></table>	01	010110	Rs≠0	RRd	1	segment	00000000			offset					19										
01	010110	Rs≠0	RRd																						
1	segment	00000000																							
offset																									

Example: ADD R2, AUGEND !augend A located at %1254!
Before instruction execution:

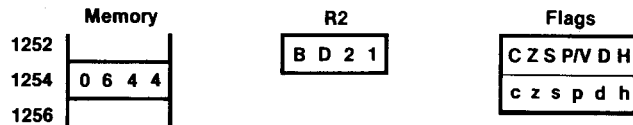

After instruction execution:

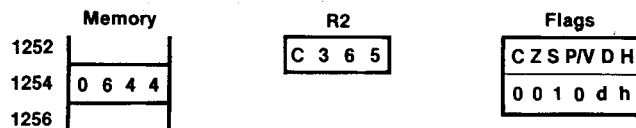

Note 1: Word register in nonsegmented mode, register pair in segmented mode.

AND

And

AND dst, src
ANDB

dst: R
 src: R, IM, IR, DA, X

Operation: dst ← dst AND src

A logical AND operation is performed between the corresponding bits of the source and destination operands, and the result is stored in the destination. A one bit is stored wherever the corresponding bits in the two operands are both ones; otherwise a zero bit is stored. The source contents are not affected.

Flags:
C: Unaffected
Z: Set if the result is zero; cleared otherwise
S: Set if the most significant bit of the result is set; cleared otherwise
P: AND — unaffected; ANDB — set if parity of the result is even; cleared otherwise
D: Unaffected
H: Unaffected

Source Addressing Mode	Assembler Language Syntax	Nonsegmented Mode		Segmented Mode																			
		Instruction Format	Cycles	Instruction Format	Cycles																		
R:	AND Rd, Rs ANDB Rbd, Rs	<table border="1"><tr><td>10</td><td>00011</td><td>W</td><td>Rs</td><td>Rd</td></tr></table>	10	00011	W	Rs	Rd	4	<table border="1"><tr><td>10</td><td>00011</td><td>W</td><td>Rs</td><td>Rd</td></tr></table>	10	00011	W	Rs	Rd	4								
10	00011	W	Rs	Rd																			
10	00011	W	Rs	Rd																			
IM:	AND Rd, #data	<table border="1"><tr><td>00</td><td>000111</td><td>0000</td><td>Rd</td></tr><tr><td colspan="4">data</td></tr></table>	00	000111	0000	Rd	data				7	<table border="1"><tr><td>00</td><td>000111</td><td>0000</td><td>Rd</td></tr><tr><td colspan="4">data</td></tr></table>	00	000111	0000	Rd	data				7		
	00	000111	0000	Rd																			
data																							
00	000111	0000	Rd																				
data																							
	ANDB Rbd, #data	<table border="1"><tr><td>00</td><td>000110</td><td>0000</td><td>Rd</td></tr><tr><td>data</td><td>data</td><td colspan="2"></td></tr></table>	00	000110	0000	Rd	data	data			7	<table border="1"><tr><td>00</td><td>000110</td><td>0000</td><td>Rd</td></tr><tr><td>data</td><td>data</td><td colspan="2"></td></tr></table>	00	000110	0000	Rd	data	data					
00	000110	0000	Rd																				
data	data																						
00	000110	0000	Rd																				
data	data																						
IR:	AND Rd, @Rs! ANDB Rbd, @Rs!	<table border="1"><tr><td>00</td><td>00011</td><td>W</td><td>Rs≠0</td><td>Rd</td></tr></table>	00	00011	W	Rs≠0	Rd	7	<table border="1"><tr><td>00</td><td>00011</td><td>W</td><td>Rs≠0</td><td>Rd</td></tr></table>	00	00011	W	Rs≠0	Rd	7								
00	00011	W	Rs≠0	Rd																			
00	00011	W	Rs≠0	Rd																			
DA:	AND Rd, address ANDB Rbd, address	<table border="1"><tr><td>01</td><td>00011</td><td>W</td><td>0000</td><td>Rd</td></tr><tr><td colspan="4">address</td></tr></table>	01	00011	W	0000	Rd	address				9	SS <table border="1"><tr><td>01</td><td>00011</td><td>W</td><td>0000</td><td>Rd</td></tr><tr><td>0</td><td>segment</td><td colspan="2">offset</td></tr></table>	01	00011	W	0000	Rd	0	segment	offset		10
		01	00011	W	0000	Rd																	
		address																					
01	00011	W	0000	Rd																			
0	segment	offset																					
<table border="1"><tr><td>01</td><td>00011</td><td>W</td><td>0000</td><td>Rd</td></tr><tr><td colspan="4">offset</td></tr></table>	01	00011	W	0000	Rd	offset					SL <table border="1"><tr><td>1</td><td>segment</td><td>0000</td><td>0000</td></tr><tr><td colspan="4">offset</td></tr></table>	1	segment	0000	0000	offset				12			
01	00011	W	0000	Rd																			
offset																							
1	segment	0000	0000																				
offset																							
				SS <table border="1"><tr><td>01</td><td>00011</td><td>W</td><td>Rs≠0</td><td>Rd</td></tr><tr><td>0</td><td>segment</td><td colspan="2">offset</td></tr></table>	01	00011	W	Rs≠0	Rd	0	segment	offset		10									
01	00011	W	Rs≠0	Rd																			
0	segment	offset																					
X:	AND Rd, addr(Rs) ANDB Rbd, addr(Rs)	<table border="1"><tr><td>01</td><td>00011</td><td>W</td><td>Rs≠0</td><td>Rd</td></tr><tr><td colspan="4">address</td></tr></table>	01	00011	W	Rs≠0	Rd	address				10	SS <table border="1"><tr><td>01</td><td>00011</td><td>W</td><td>Rs≠0</td><td>Rd</td></tr><tr><td>0</td><td>segment</td><td colspan="2">offset</td></tr></table>	01	00011	W	Rs≠0	Rd	0	segment	offset		10
01	00011	W	Rs≠0	Rd																			
address																							
01	00011	W	Rs≠0	Rd																			
0	segment	offset																					
				SL <table border="1"><tr><td>01</td><td>00011</td><td>W</td><td>Rs≠0</td><td>Rd</td></tr><tr><td>1</td><td>segment</td><td>0000</td><td>0000</td></tr><tr><td colspan="4">offset</td></tr></table>	01	00011	W	Rs≠0	Rd	1	segment	0000	0000	offset				13					
01	00011	W	Rs≠0	Rd																			
1	segment	0000	0000																				
offset																							

Example: ANDB RL3, # %CE

Before instruction execution:

RL3	Flags
1 1 1 0 0 1 1 1	C Z S P/V D H
	c z s p d h

After instruction execution:

RL3	Flags
1 1 0 0 0 1 1 0	C Z S P/V D H
	c 0 1 1 d h

Note 1: Word register in nonsegmented mode, register pair in segmented mode.

BIT

Bit Test

BIT dst, src dst: R, IR, DA, X
BITB src: IM
 or
 dst: R
 src: R

Operation: $Z \leftarrow \text{NOT } \text{dst}(\text{src})$

The specified bit within the destination operand is tested, and the Z flag is set to one if the specified bit is zero; otherwise the Z flag is cleared to zero. The contents of the destination are not affected. The bit number (the source) can be specified statically as an immediate value, or dynamically as a word register whose contents are the bit number. In the dynamic case, the destination operand must be a register, and the source operand must be R0 through R7 for BITB, or R0 through R15 for BIT. The bit number is a value from 0 to 7 for BITB, or 0 to 15 for BIT, with 0 indicating the least significant bit. Note that only the lower four bits of the source operand are used to specify the bit number for BIT, while only the lower three bits of the source operand are used for BITB.

Flags: **C:** Unaffected
 Z: Set if specified bit is zero; cleared otherwise
 S: Unaffected
 V: Unaffected
 D: Unaffected
 H: Unaffected

Destination Addressing Mode	Assembler Language Syntax	Nonsegmented Mode		Segmented Mode	
		Instruction Format	Cycles	Instruction Format	Cycles
R:	BIT Rd, b BITB Rbd, b	<div style="border: 1px solid black; padding: 2px; display: inline-block;"> 10 10011 W Rd b </div>	4	<div style="border: 1px solid black; padding: 2px; display: inline-block;"> 10 10011 W Rd b </div>	4
IR:	BIT @Rd ¹ , b BITB @Rd ¹ , b	<div style="border: 1px solid black; padding: 2px; display: inline-block;"> 00 10011 W Rd≠0 b </div>	8	<div style="border: 1px solid black; padding: 2px; display: inline-block;"> 00 10011 W Rd≠0 b </div>	8
DA:	BIT address, b BITB address, b	<div style="border: 1px solid black; padding: 2px; display: inline-block;"> 01 10011 W 0000 b address </div>	10	SS <div style="border: 1px solid black; padding: 2px; display: inline-block;"> 01 10011 W 0000 b 0 segment offset </div>	11
				SL <div style="border: 1px solid black; padding: 2px; display: inline-block;"> 01 10011 W 0000 b 1 segment 0000 0000 offset </div>	13
X:	BIT addr(Rd), b BITB addr(Rd), b	<div style="border: 1px solid black; padding: 2px; display: inline-block;"> 01 10011 W Rd≠0 b address </div>	11	SS <div style="border: 1px solid black; padding: 2px; display: inline-block;"> 01 10011 W Rd≠0 b 0 segment offset </div>	11
				SL <div style="border: 1px solid black; padding: 2px; display: inline-block;"> 01 10011 W Rd≠0 b 1 segment 0000 0000 offset </div>	14

Addressing Mode	Assembler Language Syntax	Nonsegmented Mode		Segmented Mode																					
		Instruction Format	Cycles	Instruction Format	Cycles																				
R:	BIT Rd, Rs BITB Rbd, Rs	<table border="1"> <tr> <td>00</td> <td>10011</td> <td>W</td> <td>0000</td> <td>Rs</td> </tr> <tr> <td>0000</td> <td>Rd</td> <td>0000</td> <td>0000</td> <td></td> </tr> </table>	00	10011	W	0000	Rs	0000	Rd	0000	0000		10	<table border="1"> <tr> <td>00</td> <td>10011</td> <td>W</td> <td>0000</td> <td>Rs</td> </tr> <tr> <td>0000</td> <td>Rd</td> <td>0000</td> <td>0000</td> <td></td> </tr> </table>	00	10011	W	0000	Rs	0000	Rd	0000	0000		10
00	10011	W	0000	Rs																					
0000	Rd	0000	0000																						
00	10011	W	0000	Rs																					
0000	Rd	0000	0000																						

Example: If register RH2 contains %B2 (10110010), the instruction
 BITB RH2, #0
 will leave the Z flag set to 1.

Note 1: Word register in nonsegmented mode, register pair in segmented mode.

CALL

Call

CALL dst

dst: IR, DA, X

Operation:

Nonsegmented
 SP ← SP - 2
 @SP ← PC
 PC ← dst

Segmented
 SP ← SP - 4
 @SP ← PC
 PC ← dst

The current contents of the program counter (PC) are pushed onto the top of the processor stack. The stack pointer used is R15 in nonsegmented mode, or RR14 in segmented mode. (The program counter value used is the address of the first instruction byte following the CALL instruction.) The specified destination address is then loaded into the PC and points to the first instruction of the called procedure. At the end of the procedure a RET instruction can be used to return to original program. RET pops the top of the processor stack back into the PC.

Flags: No flags affected

Destination Addressing Mode	Assembler Language Syntax	Nonsegmented Mode		Segmented Mode																	
		Instruction Format	Cycles	Instruction Format	Cycles																
IR:	CALL @Rd!	<table border="1"><tr><td>00</td><td>011111</td><td>Rd</td><td>0000</td></tr></table>	00	011111	Rd	0000	10	<table border="1"><tr><td>00</td><td>011111</td><td>Rd</td><td>0000</td></tr></table>	00	011111	Rd	0000	15								
00	011111	Rd	0000																		
00	011111	Rd	0000																		
DA:	CALL address	<table border="1"><tr><td>01</td><td>011111</td><td>0000</td><td>0000</td></tr><tr><td colspan="4">address</td></tr></table>	01	011111	0000	0000	address				12	SS <table border="1"><tr><td>01</td><td>011111</td><td>0000</td><td>0000</td></tr><tr><td>0</td><td>segment</td><td colspan="2">offset</td></tr></table>	01	011111	0000	0000	0	segment	offset		18
01	011111	0000	0000																		
address																					
01	011111	0000	0000																		
0	segment	offset																			
				SL <table border="1"><tr><td>01</td><td>011111</td><td>0000</td><td>0000</td></tr><tr><td>1</td><td>segment</td><td>0000</td><td>0000</td></tr><tr><td colspan="4">offset</td></tr></table>	01	011111	0000	0000	1	segment	0000	0000	offset				20				
01	011111	0000	0000																		
1	segment	0000	0000																		
offset																					
X:	CALL addr(Rd)	<table border="1"><tr><td>01</td><td>011111</td><td>Rd≠0</td><td>0000</td></tr><tr><td colspan="4">address</td></tr></table>	01	011111	Rd≠0	0000	address				13	SS <table border="1"><tr><td>01</td><td>011111</td><td>Rs≠0</td><td>0000</td></tr><tr><td>0</td><td>segment</td><td colspan="2">offset</td></tr></table>	01	011111	Rs≠0	0000	0	segment	offset		18
01	011111	Rd≠0	0000																		
address																					
01	011111	Rs≠0	0000																		
0	segment	offset																			
				SL <table border="1"><tr><td>01</td><td>011111</td><td>Rs≠0</td><td>0000</td></tr><tr><td>1</td><td>segment</td><td>0000</td><td>0000</td></tr><tr><td colspan="4">offset</td></tr></table>	01	011111	Rs≠0	0000	1	segment	0000	0000	offset				21				
01	011111	Rs≠0	0000																		
1	segment	0000	0000																		
offset																					

Example:

In nonsegmented mode, if the contents of the program counter are %1000 and the contents of the stack pointer (R15) are %3002, the instruction

CALL %2520

causes the stack pointer to be decremented to %3000, the value %1004 (the address following the CALL instruction with direct address mode specified) to be loaded into the word at location %3000, and the program counter to be loaded with the value %2520. The program counter now points to the address of the first instruction in the procedure to be executed.

Note 1: Word register in nonsegmented mode, register pair in segmented mode.

CALR

Call Relative

CALR dst

dst: RA

Operation:

Nonsegmented

SP ← SP - 2

@SP ← PC

PC ← PC - (2 × displacement)

Segmented

SP ← SP - 4

@SP ← PC

PC ← PC - (2 × displacement)

The current contents of the program counter (PC) are pushed onto the top of the processor stack. The stack pointer used is R15 if nonsegmented, or RR14 if segmented. (The program counter value used is the address of the first instruction byte following the CALR instruction.) The destination address is calculated and then loaded into the PC and points to the first instruction of a procedure.

At the end of the procedure a RET instruction can be used to return to the original program flow. RET pops the top of the processor stack back into the PC.

The destination address is calculated by doubling the displacement in the instruction, then subtracting this value from the current value of the PC to derive the destination address. The displacement is a 12-bit signed value in the range -2048 to +2047. Thus, the destination address must be in the range -4092 to +4098 bytes from the start of the CALR instruction. In segmented mode, the PC segment number is not affected. The assembler automatically calculates the displacement by subtracting the PC value of the following instruction from the address given by the programmer.

Flags:

No flags affected

Destination Addressing Mode	Assembler Language Syntax	Nonsegmented Mode		Segmented Mode					
		Instruction Format	Cycles	Instruction Format	Cycles				
RA:	CALR address	<table border="1" style="display: inline-table; vertical-align: middle;"><tr><td style="padding: 2px;">1101</td><td style="padding: 2px;">displacement</td></tr></table>	1101	displacement	10	<table border="1" style="display: inline-table; vertical-align: middle;"><tr><td style="padding: 2px;">1101</td><td style="padding: 2px;">displacement</td></tr></table>	1101	displacement	15
1101	displacement								
1101	displacement								

Example:

In nonsegmented mode, if the contents of the program counter are %1000 and the contents of the stack pointer (R15) are %3002, the instruction

CALR PROC

causes the stack pointer to be decremented to %3000, the value %1004 (the address following the CALR instruction) to be loaded into the word location %3000, and the program counter to be loaded with the address of the first instruction in procedure PROC.

CLR

Clear

CLR dst
CLRB

dst: R, IR, DA, X

Operation: dst ← 0

The destination is cleared to zero.

Flags: No flags affected.

Destination Addressing Mode	Assembler Language Syntax	Nonsegmented Mode		Segmented Mode																										
		Instruction Format	Cycles	Instruction Format	Cycles																									
R:	CLR Rd CLRB Rbd	<table border="1"><tr><td>10</td><td>00110</td><td>W</td><td>Rd</td><td>1000</td></tr></table>	10	00110	W	Rd	1000	7	<table border="1"><tr><td>10</td><td>00110</td><td>W</td><td>Rd</td><td>1000</td></tr></table>	10	00110	W	Rd	1000	7															
10	00110	W	Rd	1000																										
10	00110	W	Rd	1000																										
IR:	CLR @Rd! CLRB @Rd!	<table border="1"><tr><td>00</td><td>00110</td><td>W</td><td>Rd</td><td>1000</td></tr></table>	00	00110	W	Rd	1000	8	<table border="1"><tr><td>00</td><td>00110</td><td>W</td><td>Rd</td><td>1000</td></tr></table>	00	00110	W	Rd	1000	8															
00	00110	W	Rd	1000																										
00	00110	W	Rd	1000																										
DA:	CLR address CLRB address	<table border="1"><tr><td>01</td><td>00110</td><td>W</td><td>0000</td><td>1000</td></tr><tr><td colspan="5">address</td></tr></table>	01	00110	W	0000	1000	address					11	SS <table border="1"><tr><td>01</td><td>00110</td><td>W</td><td>0000</td><td>1000</td></tr><tr><td>0</td><td>segment</td><td colspan="3">offset</td></tr></table>	01	00110	W	0000	1000	0	segment	offset			12					
		01	00110	W	0000	1000																								
address																														
01	00110	W	0000	1000																										
0	segment	offset																												
X:	CLR addr(Rd) CLRB addr(Rd)	<table border="1"><tr><td>01</td><td>00110</td><td>W</td><td>Rd≠0</td><td>1000</td></tr><tr><td colspan="5">address</td></tr></table>	01	00110	W	Rd≠0	1000	address					12	SL <table border="1"><tr><td>01</td><td>00110</td><td>W</td><td>0000</td><td>1000</td></tr><tr><td>1</td><td>segment</td><td>0000</td><td>0000</td><td></td></tr><tr><td colspan="5">offset</td></tr></table>	01	00110	W	0000	1000	1	segment	0000	0000		offset					14
			01	00110	W	Rd≠0	1000																							
			address																											
01	00110	W	0000	1000																										
1	segment	0000	0000																											
offset																														
SS <table border="1"><tr><td>01</td><td>00110</td><td>W</td><td>Rd≠0</td><td>1000</td></tr><tr><td>0</td><td>segment</td><td colspan="3">offset</td></tr></table>	01	00110	W	Rd≠0	1000	0	segment	offset			12																			
01	00110	W	Rd≠0	1000																										
0	segment	offset																												
				SL <table border="1"><tr><td>01</td><td>00110</td><td>W</td><td>Rd≠0</td><td>1000</td></tr><tr><td>1</td><td>segment</td><td>0000</td><td>0000</td><td></td></tr><tr><td colspan="5">offset</td></tr></table>	01	00110	W	Rd≠0	1000	1	segment	0000	0000		offset					15										
01	00110	W	Rd≠0	1000																										
1	segment	0000	0000																											
offset																														

Example: If the word at location %ABBA contains 13, the statement
CLR %ABBA
will leave the value 0 in the word at location %ABBA.

Note 1: Word register in nonsegmented mode, register pair in segmented mode.

COM Complement

COM dst
COMB

dst: R, IR, DA, X

Operation: (dst ← NOT dst)

The contents of the destination are complemented (one's complement); all one bits are changed to zero, and vice-versa.

Flags:
C: Unaffected
Z: Set if the result is zero; cleared otherwise
S: Set if the most significant bit of the result is set; cleared otherwise
P: COM—unaffected; COMB—set if parity of the result is even; cleared otherwise
D: Unaffected
H: Unaffected

Destination Addressing Mode	Assembler Language Syntax	Nonsegmented Mode		Segmented Mode																					
		Instruction Format	Cycles	Instruction Format	Cycles																				
R:	COM Rd COMB Rbd	<table border="1"><tr><td>10</td><td>00110</td><td>W</td><td>Rd</td><td>0000</td></tr></table>	10	00110	W	Rd	0000	7	<table border="1"><tr><td>10</td><td>00110</td><td>W</td><td>Rd</td><td>0000</td></tr></table>	10	00110	W	Rd	0000	7										
10	00110	W	Rd	0000																					
10	00110	W	Rd	0000																					
IR:	COM @Rd! COMB @Rd!	<table border="1"><tr><td>00</td><td>00110</td><td>W</td><td>Rd</td><td>0000</td></tr></table>	00	00110	W	Rd	0000	12	<table border="1"><tr><td>00</td><td>00110</td><td>W</td><td>Rd</td><td>0000</td></tr></table>	00	00110	W	Rd	0000	12										
00	00110	W	Rd	0000																					
00	00110	W	Rd	0000																					
DA:	COM address COMB address	<table border="1"><tr><td>01</td><td>00110</td><td>W</td><td>0000</td><td>0000</td></tr><tr><td colspan="5">address</td></tr></table>	01	00110	W	0000	0000	address					15	<table border="1"><tr><td>01</td><td>00110</td><td>W</td><td>0000</td><td>0000</td></tr><tr><td>0</td><td>segment</td><td colspan="3">offset</td></tr></table>	01	00110	W	0000	0000	0	segment	offset			16
01	00110	W	0000	0000																					
address																									
01	00110	W	0000	0000																					
0	segment	offset																							
				<table border="1"><tr><td>01</td><td>00110</td><td>W</td><td>0000</td><td>0000</td></tr><tr><td>1</td><td>segment</td><td colspan="3">offset</td></tr></table>	01	00110	W	0000	0000	1	segment	offset			18										
01	00110	W	0000	0000																					
1	segment	offset																							
X:	COM addr(Rd) COMB addr(Rd)	<table border="1"><tr><td>01</td><td>00110</td><td>W</td><td>Rd≠0</td><td>0000</td></tr><tr><td colspan="5">address</td></tr></table>	01	00110	W	Rd≠0	0000	address					16	<table border="1"><tr><td>01</td><td>00110</td><td>W</td><td>Rd≠0</td><td>0000</td></tr><tr><td>0</td><td>segment</td><td colspan="3">offset</td></tr></table>	01	00110	W	Rd≠0	0000	0	segment	offset			16
01	00110	W	Rd≠0	0000																					
address																									
01	00110	W	Rd≠0	0000																					
0	segment	offset																							
				<table border="1"><tr><td>01</td><td>00110</td><td>W</td><td>Rd≠0</td><td>0000</td></tr><tr><td>1</td><td>segment</td><td colspan="3">offset</td></tr></table>	01	00110	W	Rd≠0	0000	1	segment	offset			19										
01	00110	W	Rd≠0	0000																					
1	segment	offset																							

Example: If register R1 contains %2552 (0010010101010010), the statement
 COM R1
 will leave the value %DAAD (1101101010101101) in R1.

Note 1: Word register in nonsegmented mode, register pair in segmented mode.

COMFLG

Complement Flag

COMFLG flag Flag: C, Z, S, P, V
 FLAGS (4:7) ← FLAGS (4:7) XOR instruction (4:7)

Operation: Any combination of the C, Z, S, P or V flags is complemented (each one bit is changed to zero, and vice-versa). The flags to be complemented are encoded in a field in the instruction. If the bit in the field is one, the corresponding flag is complemented; if the bit is zero, the flag is left unchanged. Note that the P and V flags are represented by the same bit. There may be one, two, three or four operands in the assembly language statement, in any order.

Flags:
C: Complementated if specified; unaffected otherwise
Z: Complementated if specified; unaffected otherwise
S: Complementated if specified; unaffected otherwise
P/V: Complementated if specified; unaffected otherwise
D: Unaffected
H: Undefined

Assembler Language Syntax	Nonsegmented Mode		Segmented Mode	
	Instruction Format	Cycles	Instruction Format	Cycles
COMFLG flags	10001101 CZSP/V 0101	7	10001101 CZSP/V 0101	7

Example: If the C, Z, and S flags are all clear (=0), and the P flag is set (=1), the statement
 COMFLG P, S, Z, C
 will leave the C, Z, and S flags set (=1), and the P flag cleared (=0).

CP Compare Register

CP dst, src dst: R
CPB src: R, IM, IR, DA, X
CPL or
 dst: IR, DA, X
 src: IM

Operation: dst - src

The source operand is compared to (subtracted from) the destination operand, and the appropriate flags set accordingly, which may then be used for arithmetic and logical conditional jumps. Both operands are unaffected, with the only action being the setting of the flags. Subtraction is performed by adding the two's complement of the source operand to the destination operand. There are two variants of this instruction: Compare Register compares the contents of a register against an operand specified by any of the five basic addressing modes; Compare Immediate performs a comparison between an operand in memory and an immediate value.

Flags:
C: Cleared if there is a carry from the most significant bit of the result; set otherwise, indicating a "borrow"
Z: Set if the result is zero; cleared otherwise
S: Set if the result is negative; cleared otherwise
V: Set if arithmetic overflow occurs, that is, if both operands were of opposite signs and the sign of the result is the same as the sign of the source; cleared otherwise
D: Unaffected
H: Unaffected

Compare Register

Source Addressing Mode	Assembler Language Syntax	Nonsegmented Mode		Segmented Mode	
		Instruction Format	Cycles	Instruction Format	Cycles
R:	CP Rd, Rs	10 00101 W Rs Rd	4	10 00101 W Rs Rd	4
	CPB Rbd, Rbs	10 010000 Rs Rd		10 010000 Rs Rd	
IM:	CPL RRd, RRs	10 010000 Rs Rd	7	10 010000 Rs Rd	8
	CP Rd, #data	00 001011 0000 Rd data		00 001011 0000 Rd data	
	CPB Rbd, #data	00 001010 0000 Rd data data		00 001010 0000 Rd data data	
IR:	CPL RRd, #data	00 010000 0000 Rd 31 data (high) 16 15 data (low) 0	14	00 010000 0000 Rd 31 data (high) 16 15 data (low) 0	14
	CP Rd, @Rs ¹	00 00101 W Rs≠0 Rd		00 00101 W Rs≠0 Rd	
	CPB Rbd, @Rs ¹	00 010000 Rs≠0 Rd		00 010000 Rs≠0 Rd	
	CPL RRd, @Rs ¹	00 010000 Rs≠0 Rd	14	00 010000 Rs≠0 Rd	14

Source Addressing Mode	Assembler Language Syntax	Nonsegmented Mode		Segmented Mode																						
		Instruction Format	Cycles	Instruction Format	Cycles																					
DA:	CP Rd, address CPB Rbd, address	<table border="1"> <tr> <td>01</td> <td>00101</td> <td>W</td> <td>0000</td> <td>Rd</td> </tr> <tr> <td colspan="5">address</td> </tr> </table>	01	00101	W	0000	Rd	address					9	<table border="1"> <tr> <td>SS</td> <td>01</td> <td>00101</td> <td>W</td> <td>0000</td> <td>Rd</td> </tr> <tr> <td>0</td> <td colspan="2">segment</td> <td colspan="2">offset</td> </tr> </table>	SS	01	00101	W	0000	Rd	0	segment		offset		10
	01	00101	W	0000	Rd																					
	address																									
	SS	01	00101	W	0000	Rd																				
0	segment		offset																							
		<table border="1"> <tr> <td>SL</td> <td>01</td> <td>00101</td> <td>W</td> <td>0000</td> <td>Rd</td> </tr> <tr> <td>1</td> <td colspan="2">segment</td> <td colspan="2">0000 0000</td> </tr> <tr> <td colspan="6">offset</td> </tr> </table>	SL	01	00101	W	0000	Rd	1	segment		0000 0000		offset						12						
SL	01	00101	W	0000	Rd																					
1	segment		0000 0000																							
offset																										
	CPL RRd, address	<table border="1"> <tr> <td>01</td> <td>010000</td> <td>0000</td> <td>Rd</td> </tr> <tr> <td colspan="4">address</td> </tr> </table>	01	010000	0000	Rd	address				15	<table border="1"> <tr> <td>SS</td> <td>01</td> <td>010000</td> <td>0000</td> <td>Rd</td> </tr> <tr> <td>0</td> <td colspan="2">segment</td> <td colspan="2">offset</td> </tr> </table>	SS	01	010000	0000	Rd	0	segment		offset		16			
01	010000	0000	Rd																							
address																										
SS	01	010000	0000	Rd																						
0	segment		offset																							
			<table border="1"> <tr> <td>SL</td> <td>01</td> <td>010000</td> <td>0000</td> <td>Rd</td> </tr> <tr> <td>1</td> <td colspan="2">segment</td> <td colspan="2">0000 0000</td> </tr> <tr> <td colspan="6">offset</td> </tr> </table>	SL	01	010000	0000	Rd	1	segment		0000 0000		offset						18						
SL	01	010000	0000	Rd																						
1	segment		0000 0000																							
offset																										
X:	CP Rd, addr(Rs) CPB Rbd, addr(Rbs)	<table border="1"> <tr> <td>01</td> <td>00101</td> <td>W</td> <td>Rs ≠ 0</td> <td>Rd</td> </tr> <tr> <td colspan="5">address</td> </tr> </table>	01	00101	W	Rs ≠ 0	Rd	address					10	<table border="1"> <tr> <td>SS</td> <td>01</td> <td>00101</td> <td>W</td> <td>Rs ≠ 0</td> <td>Rd</td> </tr> <tr> <td>0</td> <td colspan="2">segment</td> <td colspan="2">offset</td> </tr> </table>	SS	01	00101	W	Rs ≠ 0	Rd	0	segment		offset		10
	01	00101	W	Rs ≠ 0	Rd																					
	address																									
	SS	01	00101	W	Rs ≠ 0	Rd																				
0	segment		offset																							
			<table border="1"> <tr> <td>SL</td> <td>01</td> <td>00101</td> <td>W</td> <td>Rs ≠ 0</td> <td>Rd</td> </tr> <tr> <td>1</td> <td colspan="2">segment</td> <td colspan="2">0000 0000</td> </tr> <tr> <td colspan="6">offset</td> </tr> </table>	SL	01	00101	W	Rs ≠ 0	Rd	1	segment		0000 0000		offset						13					
SL	01	00101	W	Rs ≠ 0	Rd																					
1	segment		0000 0000																							
offset																										
	CPL RRd, addr(Rs)	<table border="1"> <tr> <td>01</td> <td>010000</td> <td>Rs ≠ 0</td> <td>Rd</td> </tr> <tr> <td colspan="4">address</td> </tr> </table>	01	010000	Rs ≠ 0	Rd	address				16	<table border="1"> <tr> <td>SS</td> <td>01</td> <td>010000</td> <td>Rs ≠ 0</td> <td>Rd</td> </tr> <tr> <td>0</td> <td colspan="2">segment</td> <td colspan="2">offset</td> </tr> </table>	SS	01	010000	Rs ≠ 0	Rd	0	segment		offset		16			
01	010000	Rs ≠ 0	Rd																							
address																										
SS	01	010000	Rs ≠ 0	Rd																						
0	segment		offset																							
			<table border="1"> <tr> <td>SL</td> <td>01</td> <td>010000</td> <td>Rs ≠ 0</td> <td>Rd</td> </tr> <tr> <td>1</td> <td colspan="2">segment</td> <td colspan="2">0000 0000</td> </tr> <tr> <td colspan="6">offset</td> </tr> </table>	SL	01	010000	Rs ≠ 0	Rd	1	segment		0000 0000		offset						19						
SL	01	010000	Rs ≠ 0	Rd																						
1	segment		0000 0000																							
offset																										

Compare Immediate

Destination Addressing Mode	Assembler Language Syntax	Nonsegmented Mode		Segmented Mode																					
		Instruction Format	Cycles	Instruction Format	Cycles																				
IR:	CP @Rd1, #data	<table border="1"> <tr> <td>00</td> <td>00110</td> <td>W</td> <td>Rd</td> <td>0001</td> </tr> <tr> <td colspan="5">data</td> </tr> </table>	00	00110	W	Rd	0001	data					11	<table border="1"> <tr> <td>00</td> <td>00110</td> <td>W</td> <td>Rd</td> <td>0001</td> </tr> <tr> <td colspan="5">data</td> </tr> </table>	00	00110	W	Rd	0001	data					11
	00	00110	W	Rd	0001																				
data																									
00	00110	W	Rd	0001																					
data																									
	CPB @Rd1, #data	<table border="1"> <tr> <td>00</td> <td>00110</td> <td>W</td> <td>Rd</td> <td>0001</td> </tr> <tr> <td colspan="2">data</td> <td colspan="3">data</td> </tr> </table>	00	00110	W	Rd	0001	data		data				<table border="1"> <tr> <td>00</td> <td>00110</td> <td>W</td> <td>Rd</td> <td>0001</td> </tr> <tr> <td colspan="2">data</td> <td colspan="3">data</td> </tr> </table>	00	00110	W	Rd	0001	data		data			11
00	00110	W	Rd	0001																					
data		data																							
00	00110	W	Rd	0001																					
data		data																							

Destination Addressing Mode	Assembler Language Syntax	Nonsegmented Mode		Segmented Mode																															
		Instruction Format	Cycles	Instruction Format	Cycles																														
DA:	CP address, #data	<table border="1"> <tr><td>01</td><td>00110</td><td>W</td><td>0000</td><td>0001</td></tr> <tr><td colspan="5">address</td></tr> <tr><td colspan="5">data</td></tr> </table>	01	00110	W	0000	0001	address					data					14	<table border="1"> <tr><td>01</td><td>00110</td><td>W</td><td>0000</td><td>0001</td></tr> <tr><td>0</td><td>segment</td><td colspan="3">offset</td></tr> <tr><td colspan="5">data</td></tr> </table>	01	00110	W	0000	0001	0	segment	offset			data					15
		01	00110	W	0000	0001																													
	address																																		
	data																																		
01	00110	W	0000	0001																															
0	segment	offset																																	
data																																			
<table border="1"> <tr><td>01</td><td>00110</td><td>W</td><td>0000</td><td>0001</td></tr> <tr><td>1</td><td>segment</td><td colspan="3">0000 0000</td></tr> <tr><td colspan="5">offset</td></tr> <tr><td colspan="5">data</td></tr> </table>	01	00110	W	0000	0001	1	segment	0000 0000			offset					data					17														
01	00110	W	0000	0001																															
1	segment	0000 0000																																	
offset																																			
data																																			
CPB address, #data	<table border="1"> <tr><td>01</td><td>00110</td><td>W</td><td>0000</td><td>0001</td></tr> <tr><td colspan="5">address</td></tr> <tr><td colspan="2">data</td><td colspan="3">data</td></tr> </table>	01	00110	W	0000	0001	address					data		data			14	<table border="1"> <tr><td>01</td><td>00110</td><td>W</td><td>0000</td><td>0001</td></tr> <tr><td>0</td><td>segment</td><td colspan="3">offset</td></tr> <tr><td colspan="2">data</td><td colspan="3">data</td></tr> </table>	01	00110	W	0000	0001	0	segment	offset			data		data			15	
	01	00110	W	0000	0001																														
address																																			
data		data																																	
01	00110	W	0000	0001																															
0	segment	offset																																	
data		data																																	
<table border="1"> <tr><td>01</td><td>00110</td><td>W</td><td>0000</td><td>0001</td></tr> <tr><td>1</td><td>segment</td><td colspan="3">0000 0000</td></tr> <tr><td colspan="5">offset</td></tr> <tr><td colspan="2">data</td><td colspan="3">data</td></tr> </table>	01	00110	W	0000	0001	1	segment	0000 0000			offset					data		data			17														
01	00110	W	0000	0001																															
1	segment	0000 0000																																	
offset																																			
data		data																																	
X:	CP addr(Rd), #data	<table border="1"> <tr><td>01</td><td>00110</td><td>W</td><td>Rd ≠ 0</td><td>0001</td></tr> <tr><td colspan="5">address</td></tr> <tr><td colspan="5">data</td></tr> </table>	01	00110	W	Rd ≠ 0	0001	address					data					15	<table border="1"> <tr><td>01</td><td>00110</td><td>W</td><td>Rd ≠ 0</td><td>0001</td></tr> <tr><td>0</td><td>segment</td><td colspan="3">offset</td></tr> <tr><td colspan="5">data</td></tr> </table>	01	00110	W	Rd ≠ 0	0001	0	segment	offset			data					15
		01	00110	W	Rd ≠ 0	0001																													
	address																																		
	data																																		
01	00110	W	Rd ≠ 0	0001																															
0	segment	offset																																	
data																																			
<table border="1"> <tr><td>01</td><td>00110</td><td>W</td><td>Rd ≠ 0</td><td>0001</td></tr> <tr><td>1</td><td>segment</td><td colspan="3">0000 0000</td></tr> <tr><td colspan="5">offset</td></tr> <tr><td colspan="5">data</td></tr> </table>	01	00110	W	Rd ≠ 0	0001	1	segment	0000 0000			offset					data					18														
01	00110	W	Rd ≠ 0	0001																															
1	segment	0000 0000																																	
offset																																			
data																																			
CPB addr(Rd), #data	<table border="1"> <tr><td>01</td><td>00110</td><td>W</td><td>Rd ≠ 0</td><td>0001</td></tr> <tr><td colspan="5">address</td></tr> <tr><td colspan="2">data</td><td colspan="3">data</td></tr> </table>	01	00110	W	Rd ≠ 0	0001	address					data		data			15	<table border="1"> <tr><td>01</td><td>00110</td><td>W</td><td>Rd ≠ 0</td><td>0001</td></tr> <tr><td>0</td><td>segment</td><td colspan="3">offset</td></tr> <tr><td colspan="2">data</td><td colspan="3">data</td></tr> </table>	01	00110	W	Rd ≠ 0	0001	0	segment	offset			data		data			15	
	01	00110	W	Rd ≠ 0	0001																														
address																																			
data		data																																	
01	00110	W	Rd ≠ 0	0001																															
0	segment	offset																																	
data		data																																	
<table border="1"> <tr><td>01</td><td>00110</td><td>W</td><td>Rd ≠ 0</td><td>0001</td></tr> <tr><td>1</td><td>segment</td><td colspan="3">0000 0000</td></tr> <tr><td colspan="5">offset</td></tr> <tr><td colspan="5">data</td></tr> </table>	01	00110	W	Rd ≠ 0	0001	1	segment	0000 0000			offset					data					18														
01	00110	W	Rd ≠ 0	0001																															
1	segment	0000 0000																																	
offset																																			
data																																			

Example:

If register R5 contains %0400, the byte at location %0400 contains 2, and the source operand is the immediate value 3, the statement

CPB @R5,#3

will leave the C flag set, indicating a borrow, the S flag set, and the Z and V flags cleared.

Note 1: Word register in nonsegmented mode, register pair in segmented mode.

CPD

Compare and Decrement

CPD dst, src, r, cc
CPDB

dst: R
src: IR

Operation:

dst - src
AUTODECREMENT src (by 1 if byte, by 2 if word)
 $R \leftarrow R - 1$

This instruction is used to search a string of data for an element meeting the specified condition. The contents of the location addressed by the source register are compared to (subtracted from) the destination operand, and the Z flag is set if the condition code specified by "cc" would be set by the comparison; otherwise the Z flag is cleared. See section 6.6.1 for a list of condition codes. Both operands are unaffected.

The source register is then decremented by one if CPDB, or by two if CPD, thus moving the pointer to the previous element in the string. The word register specified by "r" (used as a counter) is then decremented by one.

Flags:

C: Undefined
Z: Set if the condition code generated by the comparison matches cc; cleared otherwise
S: Undefined
V: Set if the result of decrementing r is zero; cleared otherwise
D: Unaffected
H: Unaffected

Source Addressing Mode	Assembler Language Syntax	Nonsegmented Mode		Segmented Mode																	
		Instruction Format	Cycles	Instruction Format	Cycles																
IR:	CPD Rd, @Rsl, r, cc CPDB Rbd, @Rsl, r, cc	<table border="1"> <tr> <td>1011101</td> <td>W</td> <td>Rs</td> <td>1000</td> </tr> <tr> <td>0000</td> <td>r</td> <td>Rd</td> <td>cc</td> </tr> </table>	1011101	W	Rs	1000	0000	r	Rd	cc	20	<table border="1"> <tr> <td>1011101</td> <td>W</td> <td>Rs</td> <td>1000</td> </tr> <tr> <td>0000</td> <td>r</td> <td>Rd</td> <td>cc</td> </tr> </table>	1011101	W	Rs	1000	0000	r	Rd	cc	20
1011101	W	Rs	1000																		
0000	r	Rd	cc																		
1011101	W	Rs	1000																		
0000	r	Rd	cc																		

Example:

If register RH0 contains %FF, register R1 contains %4001, the byte at location %4001 contains %00, and register R3 contains 5, the instruction

CPDB RH0, @R1, R3, EQ

will leave the Z flag cleared since the condition code would not have been "equal." Register R1 will contain the value %4000 and R3 will contain 4. For segmented mode, R1 must be replaced by a register pair.

Note 1: Word register in nonsegmented mode, register pair in segmented mode.

CPDR

Compare Decrement and Repeat

CPDR *dst, src, r, cc*
CPDRB

dst: R
src: IR

Operation: *dst* - *src*
 AUTODECREMENT *src* (by 1 if byte; by 2 if word)
 $R \leftarrow R - 1$
 repeat until *cc* is true or $R = 0$

This instruction is used to search a string of data for an element meeting the specified condition. The contents of the location addressed by the source register are compared to (subtracted from) the destination operand, and the Z flag is set if the condition code specified by "cc" would be set by the comparison; otherwise the Z flag is cleared. See section 6.6.1 for a list of condition codes. Both operands are unaffected.

The source register is then decremented by one if CPDRB, or by two if CPDR, thus moving the pointer to the previous element in the string. The word register specified "r" (used as a counter) is decremented by one. The entire operation is repeated until either the condition is met or the result of decrementing r is zero. This instruction can search a string from 1 to 65536 bytes or 32768 words long (the value of r must not be greater than 32768 for CPDR).

This instruction can be interrupted after each execution of the basic operation. The program counter value of the start of this instruction is saved before the interrupt request is accepted, so that the instruction can be properly resumed. Seven more cycles should be added to this instruction's execution time for each interrupt request that is accepted.

Flags: **C:** Undefined
Z: Set if the condition code generated by the comparison matches *cc*; cleared otherwise
S: Undefined
V: Set if the result of decrementing *r* is zero; cleared otherwise
D: Unaffected
H: Unaffected

Source Addressing Mode	Assembler Language Syntax	Nonsegmented Mode		Segmented Mode																	
		Instruction Format	Cycles ²	Instruction Format	Cycles ²																
IR:	CPDR <i>Rd, @Rs1, r, cc</i> CPDRB <i>Rbd, @Rs1, r, cc</i>	<table border="1" style="border-collapse: collapse; text-align: left;"> <tr> <td style="padding: 2px;">1011101</td> <td style="padding: 2px;">W</td> <td style="padding: 2px;">Rs</td> <td style="padding: 2px;">1100</td> </tr> <tr> <td style="padding: 2px;">0000</td> <td style="padding: 2px;">r</td> <td style="padding: 2px;">Rd</td> <td style="padding: 2px;">cc</td> </tr> </table>	1011101	W	Rs	1100	0000	r	Rd	cc	11 + 9n	<table border="1" style="border-collapse: collapse; text-align: left;"> <tr> <td style="padding: 2px;">1011101</td> <td style="padding: 2px;">W</td> <td style="padding: 2px;">Rs</td> <td style="padding: 2px;">1100</td> </tr> <tr> <td style="padding: 2px;">0000</td> <td style="padding: 2px;">r</td> <td style="padding: 2px;">Rd</td> <td style="padding: 2px;">cc</td> </tr> </table>	1011101	W	Rs	1100	0000	r	Rd	cc	11 + 9n
1011101	W	Rs	1100																		
0000	r	Rd	cc																		
1011101	W	Rs	1100																		
0000	r	Rd	cc																		

Example: If the string of words starting at location %2000 contains the values 0, 2, 4, 6 and 8, register R2 contains %2008, R3 contains 3, and R8 contains 8, the instruction
 CPDR R3, @R2, R8, GT
 will leave the Z flag set indicating the condition was met. Register R2 will contain the value %2002, R3 will still contain 3, and R8 will contain 5. For segmented mode, a register pair would be used instead of R2.

Note 1: Word register in nonsegmented mode, register pair in segmented mode.

Note 2: n = number of data elements compared.

CPI

Compare and Increment

CPI dst, src, r, cc
CPIB

dst: R
 src: IR

Operation:

dst ← src
 AUTOINCREMENT src (by 1 if byte; by 2 if word)
 r ← r - 1

This instruction is used to search a string of data for an element meeting the specified condition. The contents of the location addressed by the source register are compared to (subtracted from) the destination operand and the Z flag is set if the condition code is specified by "cc" would be set by the comparison; otherwise the Z flag is cleared. See section 6.6.1 for a list of condition codes. Both operands are unaffected.

The source register is then incremented by one if CPIB, or by two if CPI, thus moving the pointer to the next element in the string. The word register specified by "r" (used as a counter) is then decremented by one.

Flags:

C: Undefined
Z: Set if the condition code generated by the comparison matches cc; cleared otherwise
S: Undefined
V: Set if the result of decrementing r is zero; cleared otherwise
D: Unaffected
H: Unaffected

Source Addressing Mode	Assembler Language Syntax	Nonsegmented Mode		Segmented Mode																	
		Instruction Format	Cycles	Instruction Format	Cycles																
IR:	CPI Rd, @Rs!, r, cc CPIB Rbd, @Rs!, r, cc	<table border="1"> <tr> <td>1011101</td> <td>W</td> <td>Rs</td> <td>0000</td> </tr> <tr> <td>0000</td> <td>r</td> <td>Rd</td> <td>cc</td> </tr> </table>	1011101	W	Rs	0000	0000	r	Rd	cc	20	<table border="1"> <tr> <td>1011101</td> <td>W</td> <td>Rs</td> <td>0000</td> </tr> <tr> <td>0000</td> <td>r</td> <td>Rd</td> <td>cc</td> </tr> </table>	1011101	W	Rs	0000	0000	r	Rd	cc	20
1011101	W	Rs	0000																		
0000	r	Rd	cc																		
1011101	W	Rs	0000																		
0000	r	Rd	cc																		

Example:

This instruction can be used in a "loop" of instruction that searches a string of data for an element meeting the specified condition, but an intermediate operation on each data element is required. The following sequence of instructions (to be executed in non-segmented mode) "scans while numeric," that is, a string is searched until either an ASCII character not in the range "0" to "9" (see Appendix C) is found, or the end of the string is reached. This involves a range check on each character (byte) in the string. For segmented mode, R1 must be changed to a register pair.

```
LD          R3, #STRLEN          !initialize counter!
LDA        R1, STRSTART         !load start address!
LD         RLO, #'9'            !largest numeric char!
LOOP:
CPB        @R1, #'0'            !test char < '0'!
JR         ULT, NONNUMERIC
CPIB      RLO, @R1, R3, ULT     !test char > '0'!
JR         Z, NONNUMERIC
JR         NOV, LOOP           !repeat until counter = 0!
DONE:
.
.
NONNUMERIC:                          !handle non-numeric char!
```

Note 1: Word register in nonsegmented mode, register pair in segmented mode.

CPIR

Compare, Increment and Repeat

CPIR dst, src, r, cc dst: R
CPIRB src: IR

Operation: dst ← src
 AUTOINCREMENT src (by 1 if byte; by 2 if word)
 R ← R - 1
 repeat until cc is true or R = 0

This instruction is used to search a string of data for an element meeting the specified condition. The contents of the location addresses by the source register are compared to (subtracted from) the destination operand, and the Z flag is set if the condition code specified by "cc" would be set by the comparison; otherwise the Z flag is cleared. See Section 6.6.1 for a list of condition codes. Both operands are unaffected.

The source register is then incremented by one if CPIRB, or by two if CPIR, thus moving the pointer to the next element in the string. The word register specified by "r" (used as a counter) is then decremented by one. The entire operation is repeated until either the condition is met or the result of decrementing r is zero. This instruction can search a string from 1 to 65536 bytes or 32768 words long (the value of r must not be greater than 32768 for CPIR).

This instruction can be interrupted after each execution of the basic operation. The program counter value of the start of this instruction is saved before the interrupt request is accepted, so that the instruction can be properly resumed. Seven more cycles should be added to this instruction's execution time for each interrupt request that is accepted.

Flags: **C:** Undefined
 Z: Set if the condition code generated by the comparison matches cc; cleared otherwise
 S: Undefined
 V: Set if the result of decrementing r is zero; cleared otherwise
 D: Unaffected
 H: Unaffected

Source Addressing Mode	Assembler Language Syntax	Nonsegmented Mode		Segmented Mode																	
		Instruction Format	Cycles ²	Instruction Format	Cycles ²																
IR:	CPIR Rd, @Rs1, r, cc CPIRB Rbd, @Rs1, r, cc	<table border="1"> <tr> <td>1011101</td> <td>W</td> <td>Rs</td> <td>0100</td> </tr> <tr> <td>0000</td> <td>r</td> <td>Rd</td> <td>cc</td> </tr> </table>	1011101	W	Rs	0100	0000	r	Rd	cc	11 + 9n	<table border="1"> <tr> <td>1011101</td> <td>W</td> <td>Rs</td> <td>0100</td> </tr> <tr> <td>0000</td> <td>r</td> <td>Rd</td> <td>cc</td> </tr> </table>	1011101	W	Rs	0100	0000	r	Rd	cc	11 + 9n
		1011101	W	Rs	0100																
0000	r	Rd	cc																		
1011101	W	Rs	0100																		
0000	r	Rd	cc																		

Example:

The following sequence of instructions (to be executed in nonsegmented mode) can be used to search a string for an ASCII return character. The pointer to the start of the string is set, the string length is set, the character (byte) to be searched for is set, and then the search is accomplished. Testing the Z flag determines whether the character was found. For segmented mode, R1 must be changed to a register pair.

```
LDA      R1, STRSTART
LD       R3, #STRLEN
LDB      RLO, #% D           !hex code for return is D!
CPIRB    RLO, @R1, R3, EQ
JR       Z, FOUND
```

Note 1: Word register in nonsegmented mode, register pair in segmented mode.

Note 2: n = number of data elements compared.

CPSD

Compare String and Decrement

CPSD dst, src, r, cc
CPSDB

dst: IR
 src: IR

Operation:

dst - src
 AUTODECREMENT dst and src (by 1 if byte; by 2 if word)
 r ← r - 1

This instruction can be used to compare two strings of data until the specified condition is true. The contents of the location addressed by the source register are compared to (subtracted from) the contents of the location addressed by the destination register. The Z flag is set if the condition code specified by "cc" would be set by the comparison; otherwise the Z flag is cleared. See section 6.6.1 for a list of condition codes. Both operands are unaffected.

The source and destination registers are then decremented by one if CPSDB, or by two if CPSD, thus moving the pointers to the previous elements in the strings. The word register specified by "r" (used as a counter) is then decremented by one.

Flags:

- C:** Undefined
- Z:** Set if the condition code generated by the comparison matches cc; cleared otherwise
- S:** Undefined
- V:** Set if the result of decrementing r is zero; cleared otherwise
- D:** Unaffected
- H:** Unaffected

Addressing Mode	Assembler Language Syntax	Nonsegmented Mode		Segmented Mode																	
		Instruction Format	Cycles	Instruction Format	Cycles																
IR:	CPSD @Rd!, @Rs!, r, cc CPSDB @Rd!, @Rs!, r, cc	<table border="1"> <tr> <td>1011101</td> <td>W</td> <td>Rs</td> <td>1010</td> </tr> <tr> <td>0000</td> <td>r</td> <td>Rd</td> <td>cc</td> </tr> </table>	1011101	W	Rs	1010	0000	r	Rd	cc	25	<table border="1"> <tr> <td>1011101</td> <td>W</td> <td>Rs</td> <td>1010</td> </tr> <tr> <td>0000</td> <td>r</td> <td>Rd</td> <td>cc</td> </tr> </table>	1011101	W	Rs	1010	0000	r	Rd	cc	25
1011101	W	Rs	1010																		
0000	r	Rd	cc																		
1011101	W	Rs	1010																		
0000	r	Rd	cc																		

Example:

If register R2 contains %2000, the byte at location %2000 contains %FF, register R3 contains %3000, the byte at location %3000 contains %00, and register R4 contains 1, the instruction (executed in nonsegmented mode)

CPSDB @R2, @R3, R4, UGE

will leave the Z flag set to 1 since the condition code would have been "unsigned greater than or equal", and the V flag will be set to 1 to indicate that the counter R4 now contains 0. R2 will contain %1FFF, and R3 will contain %2FFF. For segmented mode, R3 must be changed to a register pair.

Note 1: Word register in nonsegmented mode, register pair in segmented mode.

Compare String, Decrement and Repeat

CPSDR dst, src, r, cc dst: IR
CPSDRB src: IR

Operation:

dst ← src
 AUTODECREMENT dst and src (by 1 if byte; by 2 if word)
 r ← r - 1
 repeat until cc is true or r = 0

This instruction is used to compare two strings of data until the specified condition is true. The contents of the location addressed by the source register are compared to (subtracted from) the contents of the location addressed by the destination register. The Z flag is set if the condition code specified by "cc" would be set by the comparison; otherwise the Z flag is cleared. See section 6.6.1 for a list of condition codes. Both operands are unaffected.

The source and destination registers are then decremented by one if CPSDRB, or by two if CPSDR, thus moving the pointers to the previous elements in the strings. The word register specified by "r" (used as a counter) is then decremented by one. The entire operation is repeated until either the condition is met or the result of decrementing r is zero. This instruction can compare strings from 1 to 65536 bytes or from 1 to 32768 words long (the value of r must not be greater than 32768 for CPSDR).

This instruction can be interrupted after each execution of the basic operation. The program counter of the start of this instruction is saved before the interrupt request is accepted, so that the instruction can be properly resumed. Seven more cycles should be added to this instruction's execution time for each interrupt request that is accepted.

Flags:

- C:** Undefined
- Z:** Set if the condition code generated by the comparison matches cc; cleared otherwise
- S:** Undefined
- V:** Set if the result of decrementing r is zero; cleared otherwise
- D:** Unaffected
- H:** Unaffected

Addressing Mode	Assembler Language Syntax	Nonsegmented Mode		Segmented Mode																	
		Instruction Format	Cycles	Instruction Format	Cycles																
IR:	CPSDR@Rd ¹ ,@Rs ¹ ,r,cc CPSDRB@Rd ¹ ,@Rs ¹ ,r,cc	<table border="1"> <tr> <td>1011101</td> <td>W</td> <td>Rs</td> <td>1110</td> </tr> <tr> <td>0000</td> <td>r</td> <td>Rd</td> <td>cc</td> </tr> </table>	1011101	W	Rs	1110	0000	r	Rd	cc	11 + 14n	<table border="1"> <tr> <td>1011101</td> <td>W</td> <td>Rs</td> <td>1110</td> </tr> <tr> <td>0000</td> <td>r</td> <td>Rd</td> <td>cc</td> </tr> </table>	1011101	W	Rs	1110	0000	r	Rd	cc	11 + 14n
1011101	W	Rs	1110																		
0000	r	Rd	cc																		
1011101	W	Rs	1110																		
0000	r	Rd	cc																		

Example:

If the words from location %1000 to %1006 contain the values 0, 2, 4, and 6, the words from location %2000 to %2006 contain the values 0, 1, 1, 0, register R13 contains %1006, register R14 contains %2006, and register R0 contains 4, the instruction (executed in nonsegmented mode)

CPSDR @R13, @R14, R0, EQ

leaves the Z flag set to 1 since the condition code would have been "equal" (locations %1000 and %2000 both contain the value 0). The V flag will be set to 1 indicating r was decremented to 0. R13 will contain %OFFE, R14 will contain %1FFE, and R0 will contain 0. For segmented mode, R13 and R14 must be changed to register pairs.

Note 1: Word register in nonsegmented mode, register pair in segmented mode.

Note 2: n = number of data elements compared.

Compare String and Increment

CPSI dst, src, r, cc
CPSIB

dst: IR
 src: IR

Operation:

dst - src
 AUTOINCREMENT dst and src (by 1 if byte, by 2 if word)
 r ← r - 1

This instruction can be used to compare two strings of data until the specified condition is true. The contents of the location addressed by the source register are compared to (subtracted from) the contents of the location addressed by the destination register. The Z flag is set if the condition code specified by "cc" would be set by the comparison; otherwise the Z flag is cleared. See Section 6.6.1 for a list of condition codes. Both operands are unaffected.

The source and destination registers are then incremented by one if CPSIB, or by two if CPSI, thus moving the pointers to the next elements in the strings. The word register specified by "r" (used as a counter) is then decremented by one.

Flags:

C: Undefined
Z: Set if the condition code generated by the comparison matches cc; cleared otherwise
S: Undefined
V: Set if the result of decrementing r is zero; cleared otherwise
D: Unaffected
H: Unaffected

Addressing Mode	Assembler Language Syntax	Nonsegmented Mode		Segmented Mode																	
		Instruction Format	Cycles	Instruction Format	Cycles																
IR:	CPSI @Rd1,@Rs1,r,cc CPSIB @Rd1,@Rs1,r,cc	<table border="1"> <tr> <td>1011101</td> <td>W</td> <td>Rs</td> <td>0010</td> </tr> <tr> <td>0000</td> <td>r</td> <td>Rd</td> <td>cc</td> </tr> </table>	1011101	W	Rs	0010	0000	r	Rd	cc	25	<table border="1"> <tr> <td>1011101</td> <td>W</td> <td>Rs</td> <td>0010</td> </tr> <tr> <td>0000</td> <td>r</td> <td>Rd</td> <td>cc</td> </tr> </table>	1011101	W	Rs	0010	0000	r	Rd	cc	25
1011101	W	Rs	0010																		
0000	r	Rd	cc																		
1011101	W	Rs	0010																		
0000	r	Rd	cc																		

Example:

This instruction can be used in a "loop" of instructions which compares two strings until the specified condition is true, but where an intermediate operation on each data element is required. The following sequence of instructions, to be executed in nonsegmented mode, attempts to match a given source string to the destination string which is known to contain all upper-case characters. The match should succeed even if the source string contains some lower-case characters. This involves a forced conversion of the source string to upper-case (only ASCII alphabetic letters are assumed, see Appendix C) by resetting bit 5 of each character (byte) to 0 before comparison.

```
          LDA      R1, SRCSTART      !load start addresses!
          LDA      R2, DSTSTART
          LD       R3, #STRLEN        !initialize counter!
LOOP:
          RESB     @R1, #5            !force upper-case!
          CPSIB    @R1, @R2, R3, NE   !compare until not equal!
          JR       Z, NOTEQUAL        !exit loop if match fails!
          JR       NOV, LOOP          !repeat until counter = 0!
DONE:
          .
          .
          .
NOTEQUAL:
          .                          !match fails!
```

For segmented mode, R1 must be changed to register pair.

Note 1: Word register in nonsegmented mode, register pair in segmented mode.

CPSIR

Compare String, Increment and Repeat

CPSIR dst,src,r,cc dst: IR
CPSIRB src: IR

Operation:

dst ← src
 AUTOINCREMENT dst and src (by 1 if byte, by 2 if word)
 r ← r - 1
 repeat until cc is true or r = 0

This instruction is used to compare two strings of data until the specified condition is true. The contents of the location addressed by the source register are compared to (subtracted from) the contents of the location addressed by the destination register. The Z flag is set if the condition code specified by "cc" would be set by the comparison; otherwise the Z flag is cleared. See section 6.6.1 for a list of condition codes. Both operands are unaffected. The source and destination registers are then incremented by one if CPSIRB, or by two if CPSIR, thus moving the pointers to the next elements in the strings. The word register specified by "r" (used as a counter) is then decremented by one. The entire operation is repeated until either the condition is met or the result of decrementing r is zero. This instruction can compare strings from 1 to 65536 bytes or from 1 to 32768 words long (the value of r must not be greater than 32768 for CPSIR).

This instruction can be interrupted after each execution of the basic operation. The program counter value of the start of this instruction is saved before the interrupt request is accepted, so that the instruction can be properly resumed. Seven cycles should be added to this instruction's execution time for each interrupt request that is accepted.

Flags:

- C:** Undefined
- Z:** Set if the condition code generated by the comparison matches cc; cleared otherwise
- S:** Undefined
- V:** Set if the result of decrementing r is zero; cleared otherwise
- D:** Unaffected
- H:** Unaffected

Addressing Mode	Assembler Language Syntax	Nonsegmented Mode		Segmented Mode																	
		Instruction Format	Cycles ²	Instruction Format	Cycles ²																
IR:	CPSIR @Rd ¹ ,@Rs ¹ ,r,cc CPSIRB @Rd ¹ ,@Rs ¹ ,r,cc	<table border="1" style="border-collapse: collapse; width: 100%;"> <tr> <td style="padding: 2px;">1011101</td> <td style="padding: 2px;">W</td> <td style="padding: 2px;">Rs</td> <td style="padding: 2px;">0110</td> </tr> <tr> <td style="padding: 2px;">0000</td> <td style="padding: 2px;">r</td> <td style="padding: 2px;">Rd</td> <td style="padding: 2px;">cc</td> </tr> </table>	1011101	W	Rs	0110	0000	r	Rd	cc	11 + 14n	<table border="1" style="border-collapse: collapse; width: 100%;"> <tr> <td style="padding: 2px;">1011101</td> <td style="padding: 2px;">W</td> <td style="padding: 2px;">Rs</td> <td style="padding: 2px;">0110</td> </tr> <tr> <td style="padding: 2px;">0000</td> <td style="padding: 2px;">r</td> <td style="padding: 2px;">Rd</td> <td style="padding: 2px;">cc</td> </tr> </table>	1011101	W	Rs	0110	0000	r	Rd	cc	11 + 14n
1011101	W	Rs	0110																		
0000	r	Rd	cc																		
1011101	W	Rs	0110																		
0000	r	Rd	cc																		

Example:

The following sequence of instructions can be used in nonsegmented mode to compare two strings of possibly different lengths, but at least one character (byte) long. It determines if the destination string is lexicographically greater than or equal to the source string as determined by the ordering of the ASCII character set (see Appendix). Notice that the string "ABC" is greater than "AB", and "AC" is greater than "ABC". The destination string is initially pointed to by R1, with its length in

bytes in R3. The source string is initially pointed to by R2, with its length in bytes in R4. To execute in segmented mode, R1 and R2 must be changed to register pairs.

CP	R3, R4	!find shortest length!
JR	ULE, COMPARE	
LD	R3, R4	!if source is shorter,!
EX	R1, R2	!then swap pointers!
COMPARE:		
CPSIRB	@R1, @R2, R3, ULT	!compare while > =!
JR	Z, FAIL	
SUCCEED:	.	!destination > = source!
	.	
	.	
FAIL:		!destination < source!

Note 1: Word register in nonsegmented mode, register pair in segmented mode.

Note 2: n = number of data elements transferred.

DAB

Decimal Adjust

DAB dst dst: R

Operation: dst ← DA dst

The destination byte is adjusted to form two 4-bit BCD digits following an addition or subtraction operation. For addition (ADDB, ADCB) or subtraction (SUBB, SBCB), the following table indicates the operation performed:

Instruction	Carry Before DAB	Bits 4-7 Value (Hex)	H Flag Before DAB	Bits 0-3 Value (Hex)	Number Added To Byte	Carry After DAB
	0	0-9	0	0-9	00	0
	0	0-8	0	A-F	06	0
ADDB	0	0-9	1	0-3	06	0
ADCB	0	A-F	0	0-9	60	1
	0	9-F	0	A-F	66	1
	0	A-F	1	0-3	66	1
	1	0-2	0	0-9	60	1
	1	0-2	0	A-F	66	1
SUBB	0	0-9	0	0-9	00	0
SBCB	0	0-8	1	6-F	FA	0
	1	7-F	0	0-9	A0	1
	1	6-F	1	6-F	9A	1

The operation is undefined if the destination byte was not the result of a valid addition or subtraction of BCD digits.

Flags: **C:** Set or cleared according to the table above
Z: Set if the result is zero; cleared otherwise
S: Set if the most significant bit of the result is set; cleared otherwise
V: Unaffected
D: Unaffected
H: Unaffected

Addressing Mode	Assembler Language Syntax	Nonsegmented Mode		Segmented Mode	
		Instruction Format	Cycles	Instruction Format	Cycles
R:	DAB Rbd	10 110000 Rd 0000	5	10 110000 Rd 0000	5

Example:

If addition is performed using the BCD values 15 and 27, the result should be 42. The sum is incorrect, however, when the binary representations are added in the destination location using standard binary arithmetic.

$$\begin{array}{r} 0001\ 0101 \\ + 0010\ 0111 \\ \hline 0011\ 1100 = \%3C \end{array}$$

The DAB instruction adjusts this result so that the correct BCD representation is obtained.

$$\begin{array}{r} 0011\ 1100 \\ + 0000\ 0110 \\ \hline 0100\ 0010 = 42 \end{array}$$

DEC Decrement

DEC dst, src dst: R, IR, DA, X
DECB src: IM

Operation: dst ← dst – src (where src = 1 to 16)

The source operand (a value from 1 to 16) is subtracted from the destination operand and the result is stored in the destination. Subtraction is performed by adding the two's complement of the source operand to the destination operand. The source operand may be omitted from the assembly language statement and defaults to the value 1.

The source field in this instruction format contains the source operand n. The coding for n ranges from 0 to 15, which corresponds to the source values 1 to 16.

Flags:

- C:** Unaffected
- Z:** Set if the result is zero; cleared otherwise
- S:** Set if the result is negative; cleared otherwise
- V:** Set if arithmetic overflow occurs, that is, if the operands were of opposite signs, and the sign of the result is the same as the sign of the source; cleared otherwise.
- D:** Unaffected
- H:** Unaffected

Destination Addressing Mode	Assembler Language Syntax	Nonsegmented Mode		Segmented Mode																					
		Instruction Format	Cycles	Instruction Format	Cycles																				
R:	DEC Rd, #n DECB Rbd, #n	<table border="1" style="margin: auto;"> <tr> <td style="padding: 2px;">10</td> <td style="padding: 2px;">10101</td> <td style="padding: 2px;">W</td> <td style="padding: 2px;">Rd</td> <td style="padding: 2px;">n</td> </tr> </table>	10	10101	W	Rd	n	4	<table border="1" style="margin: auto;"> <tr> <td style="padding: 2px;">10</td> <td style="padding: 2px;">10101</td> <td style="padding: 2px;">W</td> <td style="padding: 2px;">Rd</td> <td style="padding: 2px;">n</td> </tr> </table>	10	10101	W	Rd	n	4										
		10	10101	W	Rd	n																			
10	10101	W	Rd	n																					
IR:	DEC @Rd!, #n DECB @Rd!, #n	<table border="1" style="margin: auto;"> <tr> <td style="padding: 2px;">00</td> <td style="padding: 2px;">10101</td> <td style="padding: 2px;">W</td> <td style="padding: 2px;">Rd≠0</td> <td style="padding: 2px;">n</td> </tr> </table>	00	10101	W	Rd≠0	n	11	<table border="1" style="margin: auto;"> <tr> <td style="padding: 2px;">00</td> <td style="padding: 2px;">10101</td> <td style="padding: 2px;">W</td> <td style="padding: 2px;">Rd≠0</td> <td style="padding: 2px;">n</td> </tr> </table>	00	10101	W	Rd≠0	n	11										
		00	10101	W	Rd≠0	n																			
00	10101	W	Rd≠0	n																					
DA:	DEC address, #n DECB address, #n	<table border="1" style="margin: auto;"> <tr> <td style="padding: 2px;">01</td> <td style="padding: 2px;">10101</td> <td style="padding: 2px;">W</td> <td style="padding: 2px;">0000</td> <td style="padding: 2px;">n</td> </tr> <tr> <td colspan="5" style="text-align: center; padding: 2px;">address</td> </tr> </table>	01	10101	W	0000	n	address					13	<table border="1" style="margin: auto;"> <tr> <td style="padding: 2px;">01</td> <td style="padding: 2px;">10101</td> <td style="padding: 2px;">W</td> <td style="padding: 2px;">0000</td> <td style="padding: 2px;">n</td> </tr> <tr> <td style="padding: 2px;">0</td> <td style="padding: 2px;">segment</td> <td colspan="3" style="padding: 2px;">offset</td> </tr> </table>	01	10101	W	0000	n	0	segment	offset			14
		01	10101	W	0000	n																			
address																									
01	10101	W	0000	n																					
0	segment	offset																							
X:	DEC addr(Rd), #n DECB addr(Rd), #n	<table border="1" style="margin: auto;"> <tr> <td style="padding: 2px;">01</td> <td style="padding: 2px;">10101</td> <td style="padding: 2px;">W</td> <td style="padding: 2px;">Rd≠0</td> <td style="padding: 2px;">n</td> </tr> <tr> <td colspan="5" style="text-align: center; padding: 2px;">address</td> </tr> </table>	01	10101	W	Rd≠0	n	address					14	<table border="1" style="margin: auto;"> <tr> <td style="padding: 2px;">01</td> <td style="padding: 2px;">10101</td> <td style="padding: 2px;">W</td> <td style="padding: 2px;">Rd≠0</td> <td style="padding: 2px;">n</td> </tr> <tr> <td style="padding: 2px;">0</td> <td style="padding: 2px;">segment</td> <td colspan="3" style="padding: 2px;">offset</td> </tr> </table>	01	10101	W	Rd≠0	n	0	segment	offset			14
		01	10101	W	Rd≠0	n																			
address																									
01	10101	W	Rd≠0	n																					
0	segment	offset																							
				<table border="1" style="margin: auto;"> <tr> <td style="padding: 2px;">01</td> <td style="padding: 2px;">10101</td> <td style="padding: 2px;">W</td> <td style="padding: 2px;">Rd≠0</td> <td style="padding: 2px;">n</td> </tr> <tr> <td style="padding: 2px;">1</td> <td style="padding: 2px;">segment</td> <td colspan="3" style="padding: 2px;">0000 0000</td> </tr> <tr> <td colspan="5" style="text-align: center; padding: 2px;">offset</td> </tr> </table>	01	10101	W	Rd≠0	n	1	segment	0000 0000			offset					16					
01	10101	W	Rd≠0	n																					
1	segment	0000 0000																							
offset																									
				<table border="1" style="margin: auto;"> <tr> <td style="padding: 2px;">01</td> <td style="padding: 2px;">10101</td> <td style="padding: 2px;">W</td> <td style="padding: 2px;">Rd≠0</td> <td style="padding: 2px;">n</td> </tr> <tr> <td style="padding: 2px;">0</td> <td style="padding: 2px;">segment</td> <td colspan="3" style="padding: 2px;">offset</td> </tr> </table>	01	10101	W	Rd≠0	n	0	segment	offset			14										
01	10101	W	Rd≠0	n																					
0	segment	offset																							
				<table border="1" style="margin: auto;"> <tr> <td style="padding: 2px;">01</td> <td style="padding: 2px;">10101</td> <td style="padding: 2px;">W</td> <td style="padding: 2px;">Rd≠0</td> <td style="padding: 2px;">n</td> </tr> <tr> <td style="padding: 2px;">1</td> <td style="padding: 2px;">segment</td> <td colspan="3" style="padding: 2px;">0000 0000</td> </tr> <tr> <td colspan="5" style="text-align: center; padding: 2px;">offset</td> </tr> </table>	01	10101	W	Rd≠0	n	1	segment	0000 0000			offset					17					
01	10101	W	Rd≠0	n																					
1	segment	0000 0000																							
offset																									

Example: If register R10 contains %002A, the statement
 DEC R10
 will leave the value %0029 in R10.

Note 1: Word register in nonsegmented mode, register pair in segmented mode.

DI

Disable Interrupt

Privileged Instruction

DI Int

Int: VI, NVI

Operation: If instruction (0) = 0 then NVI ← 0
 If instruction (1) = 0 then VI ← 0

Any combination of the Vectored Interrupt (VI) or Non-Vectored Interrupt (NVI) control bits in the Flags and Control Word (FCW) are cleared to zero if the corresponding bit in the instruction is zero, thus disabling the appropriate type of interrupt. If the corresponding bit in the instruction is one, the control bit will not be affected. All other bits in the FCW are not affected. There may be one or two operands in the assembly language statement, in either order.

Flags: No flags affected.

Assembler Language Syntax	Nonsegmented Mode		Segmented Mode	
	Instruction Format	Cycles	Instruction Format	Cycles
DI int	01111100 000000 Y N	7	01111100 000000 Y N	7

Example: If the NVI and VI control bits are set (1) in the FCW, the instruction:
 DI VI
 will leave the NVI control bit in the FCW set (1) and will leave the VI control bit in the FCW cleared (0).

DIV Divide

DIV dst, src dst: R
DIVL src: R, IM, IR, DA, X

Operation:

Word: (dst is register pair, src is word register):
dst (0:31) is divided by src (0:15)
(dst (0:31) = quotient × src (0:15) + remainder)
dst (16:31) ← quotient
dst (0:15) ← remainder

Long: (dst register quadruple, sr is register pair):
dst (0:63) is divided by src (0:31)
(dst (0:63) = quotient × src (0:31) + remainder)
dst (32:63) ← quotient
dst (0:31) ← remainder

The destination operand (dividend) is divided by the source operand (divisor), the quotient is stored in the low-order half of the destination and the remainder is stored in the high-order half of the destination. The contents of the source are not affected. Both operands are treated as signed, two's complement integers and division is performed so that the remainder is of the same sign as the dividend. For DIV, the destination is a register pair and the source is a word value; for DIVL, the destination is a register quadruple and the source is a long word value.

There are four possible outcomes of the Divide instruction, depending on the division, and the resulting quotient:

CASE 1. If the quotient is within the range -2^{15} to $2^{15} - 1$ inclusive for DIV or -2^{31} to $2^{31} - 1$ inclusive for DIVL, then the quotient and remainder are left in the destination register as defined above, the overflow and carry flags are cleared to zero, and the sign and zero flags are set according to the value of the quotient.

CASE 2. If the divisor is zero, the destination register remains unchanged, the overflow and zero flags are set to one and the carry and sign flags are cleared to zero.

CASE 3. If the quotient is outside the range -2^{16} to $2^{16} - 1$ inclusive for DIV or -2^{32} to $2^{32} - 1$ inclusive for DIVL, the destination register contains an undefined value, the overflow flag is set to one, the carry and zero flags are cleared to zero, and the sign flag is undefined.

CASE 4. If the quotient is inside the range of case 3 but outside the range of case 1, then all but the sign bit of the quotient and all of the remainder are left in the destination register, the overflow and carry flags are set to one, and the sign and zero flags are set according to the value of the quotient. In this case, the sign flag can be replicated by subsequent instruction into the high-order half of the destination to produce the two's complement representation of the quotient in the same precision as the original dividend.

Source Addressing Mode	Assembler Language Syntax	Nonsegmented Mode		Segmented Mode																								
		Instruction Format	Cycles ²	Instruction Format	Cycles ²																							
R:	DIV RRd, Rs	<table border="1"><tr><td>10</td><td>011011</td><td>Rs</td><td>Rd</td></tr></table>	10	011011	Rs	Rd		<table border="1"><tr><td>10</td><td>011011</td><td>Rs</td><td>Rd</td></tr></table>	10	011011	Rs	Rd																
	10	011011	Rs	Rd																								
10	011011	Rs	Rd																									
DIVL RQd, RRs	<table border="1"><tr><td>10</td><td>011010</td><td>Rs</td><td>Rd</td></tr></table>	10	011010	Rs	Rd	<table border="1"><tr><td>10</td><td>011010</td><td>Rs</td><td>Rd</td></tr></table>		10	011010	Rs	Rd																	
10	011010	Rs	Rd																									
10	011010	Rs	Rd																									
IM:	DIV RRd, #data	<table border="1"><tr><td>00</td><td>011011</td><td>0000</td><td>Rd</td></tr><tr><td colspan="4">data</td></tr></table>	00	011011	0000	Rd		data				<table border="1"><tr><td>00</td><td>011011</td><td>0000</td><td>Rd</td></tr><tr><td colspan="4">data</td></tr></table>		00	011011	0000	Rd	data										
	00	011011	0000	Rd																								
	data																											
00	011011	0000	Rd																									
data																												
DIVL RQd, #data	<table border="1"><tr><td>00</td><td>011010</td><td>0000</td><td>Rd</td></tr><tr><td>31</td><td colspan="2">data (high)</td><td>16</td></tr><tr><td>15</td><td colspan="2">data (low)</td><td>0</td></tr></table>	00	011010	0000	Rd	31		data (high)		16	15	data (low)		0	<table border="1"><tr><td>00</td><td>011010</td><td>0000</td><td>Rd</td></tr><tr><td>31</td><td colspan="2">data (high)</td><td>16</td></tr><tr><td>15</td><td colspan="2">data (low)</td><td>0</td></tr></table>	00	011010	0000	Rd	31	data (high)		16	15	data (low)		0	
00	011010	0000	Rd																									
31	data (high)		16																									
15	data (low)		0																									
00	011010	0000	Rd																									
31	data (high)		16																									
15	data (low)		0																									
IR:	DIV RRd, @Rs ¹	<table border="1"><tr><td>00</td><td>011011</td><td>Rs≠0</td><td>Rd</td></tr></table>	00	011011	Rs≠0	Rd	<table border="1"><tr><td>00</td><td>011011</td><td>Rs≠0</td><td>Rd</td></tr></table>	00	011011	Rs≠0	Rd																	
	00	011011	Rs≠0	Rd																								
00	011011	Rs≠0	Rd																									
DIVL RQd, @Rs ¹	<table border="1"><tr><td>00</td><td>011010</td><td>Rs≠0</td><td>Rd</td></tr></table>	00	011010	Rs≠0	Rd	<table border="1"><tr><td>00</td><td>011010</td><td>Rs≠0</td><td>Rd</td></tr></table>	00	011010	Rs≠0	Rd																		
00	011010	Rs≠0	Rd																									
00	011010	Rs≠0	Rd																									
DA:	DIV RRd, address	<table border="1"><tr><td>01</td><td>011011</td><td>0000</td><td>Rd</td></tr><tr><td colspan="4">address</td></tr></table>	01	011011	0000	Rd	address				SS <table border="1"><tr><td>01</td><td>011011</td><td>0000</td><td>Rd</td></tr><tr><td>0</td><td>segment</td><td colspan="2">offset</td></tr></table>	01	011011	0000	Rd	0	segment	offset										
	01	011011	0000	Rd																								
	address																											
01	011011	0000	Rd																									
0	segment	offset																										
DIVL RQd, address	<table border="1"><tr><td>01</td><td>011010</td><td>0000</td><td>Rd</td></tr><tr><td colspan="4">address</td></tr></table>	01	011010	0000	Rd	address				SL <table border="1"><tr><td>01</td><td>011011</td><td>0000</td><td>Rd</td></tr><tr><td>1</td><td>segment</td><td>0000</td><td>0000</td></tr><tr><td colspan="4">offset</td></tr></table>	01	011011	0000	Rd	1	segment	0000	0000	offset									
01	011010	0000	Rd																									
address																												
01	011011	0000	Rd																									
1	segment	0000	0000																									
offset																												
X:	DIV RRd, addr(Rs)	<table border="1"><tr><td>01</td><td>011011</td><td>Rs≠0</td><td>Rd</td></tr><tr><td colspan="4">address</td></tr></table>	01	011011	Rs≠0	Rd	address				SS <table border="1"><tr><td>01</td><td>011011</td><td>Rs≠0</td><td>Rd</td></tr><tr><td>0</td><td>segment</td><td colspan="2">offset</td></tr></table>	01	011011	Rs≠0	Rd	0	segment	offset										
	01	011011	Rs≠0	Rd																								
	address																											
	01	011011	Rs≠0	Rd																								
	0	segment	offset																									
	DIVL RQd, addr(Rs)	<table border="1"><tr><td>01</td><td>011010</td><td>Rs≠0</td><td>Rd</td></tr><tr><td colspan="4">address</td></tr></table>	01	011010	Rs≠0	Rd	address				SL <table border="1"><tr><td>01</td><td>011011</td><td>Rs≠0</td><td>Rd</td></tr><tr><td>1</td><td>segment</td><td>0000</td><td>0000</td></tr><tr><td colspan="4">offset</td></tr></table>	01	011011	Rs≠0	Rd	1	segment	0000	0000	offset								
01	011010	Rs≠0	Rd																									
address																												
01	011011	Rs≠0	Rd																									
1	segment	0000	0000																									
offset																												
			SS <table border="1"><tr><td>01</td><td>011010</td><td>0000</td><td>Rd</td></tr><tr><td>0</td><td>segment</td><td colspan="2">offset</td></tr></table>	01	011010	0000	Rd	0	segment	offset																		
01	011010	0000	Rd																									
0	segment	offset																										
			SL <table border="1"><tr><td>01</td><td>011010</td><td>0000</td><td>Rd</td></tr><tr><td>1</td><td>segment</td><td>0000</td><td>0000</td></tr><tr><td colspan="4">offset</td></tr></table>	01	011010	0000	Rd	1	segment	0000	0000	offset																
01	011010	0000	Rd																									
1	segment	0000	0000																									
offset																												
			SS <table border="1"><tr><td>01</td><td>011010</td><td>Rs≠0</td><td>Rd</td></tr><tr><td>0</td><td>segment</td><td colspan="2">offset</td></tr></table>	01	011010	Rs≠0	Rd	0	segment	offset																		
01	011010	Rs≠0	Rd																									
0	segment	offset																										
			SL <table border="1"><tr><td>01</td><td>011010</td><td>Rs≠0</td><td>Rd</td></tr><tr><td>1</td><td>segment</td><td>0000</td><td>0000</td></tr><tr><td colspan="4">offset</td></tr></table>	01	011010	Rs≠0	Rd	1	segment	0000	0000	offset																
01	011010	Rs≠0	Rd																									
1	segment	0000	0000																									
offset																												

Note 1: Word register in nonsegmented mode, register pair in segmented mode.

Note 2: Execution times for each instruction are given in the table under Example.

Flags:

- C:** Set if V is set and the quotient lies in the range from -2^{16} to $2^{16} - 1$ inclusive for DIV or in the range from -2^{32} to $2^{32} - 1$ inclusive for DIVL; cleared otherwise
- Z:** Set if the quotient or divisor is zero; cleared otherwise
- S:** Undefined if V is set and C is clear (overflow); otherwise set if the quotient is negative, cleared if the quotient is non-negative.
- V:** Set if the divisor is zero or if the computed quotient lies outside the range from -2^{15} to $2^{15} - 1$ inclusive for DIV or outside range from -2^{31} to $2^{31} - 1$ inclusive for DIVL; cleared otherwise
- D:** Unaffected
- H:** Unaffected

Example:

The following table gives the DIV instruction execution times for word and long word operands in all possible addressing modes.

src	Word			Long Word		
	NS	SS	SL	NS	SS	SL
R	107			744		
IM	107			744		
IR	107	107	107	744	744	744
DA	108	109	111	745	746	748
X	109	109	112	746	746	749
(Divisor is zero)						
R	13	13	13	30	30	30
IM	13	13	13	30	30	30
IR	13	13	13	30	30	30
DA	14	15	17	31	32	34
X	15	15	18	32	32	35
(Absolute value of the high-order half of the dividend is larger than the absolute value of the divisor)						
R	25	25	25	51	51	51
IM	25	25	25	51	51	51
IR	25	25	25	51	51	51
DA	26	27	29	52	53	55
X	27	27	30	53	53	56

Note that for proper execution, the "dst field" in the instruction format encoding must be even for DIV, and must be a multiple of 4 (0, 4, 8, 12) for DIVL. If the source operand in DIVL is a register, the "src field" must be even.

If register RR0 (composed of word register R0 and R1) contains %00000022 and register R3 contains 6, the statement

```
DIV RR0,R3
```

will leave the value %00040005 in RR0 (R1 contains the quotient 5 and R0 contains the remainder 4).

DJNZ

Decrement and Jump if Not Zero

DJNZ R, dst
DBJNZ

dst: RA

Operation:

$R \leftarrow R - 1$

If $R \neq 0$ then $PC \leftarrow PC - (2 \times \text{displacement})$

The register being used as a counter is decremented. If the contents of the register are not zero after decrementing, the destination address is calculated and then loaded into the program counter (PC). Control will then pass to the instruction whose address is pointed to by the PC. When the register counter reaches zero, control falls through to the instruction following DJNZ or DBJNZ. This instruction provides a simple method of loop control.

The relative addressing mode is calculated by doubling the displacement in the instruction, then subtracting this value from the updated value of the PC to derive the destination address. The updated PC value is taken to be the address of the instruction byte following the DJNZ or DBJNZ instruction, while the displacement is a 7-bit positive value in the range 0 to 127. Thus, the destination address must be in the range -252 to 2 bytes from the start of the DJNZ or DBJNZ instruction. In the segmented mode, the PC segment number is not affected. The assembler automatically calculates the displacement by subtracting the PC value of the following instruction from the address given by the programmer. Note that DJNZ or DBJNZ cannot be used to transfer control in the forward direction, nor to another segment in segmented mode operation.

Flags: No flags affected

Destination Addressing Mode	Assembler Language Syntax	Nonsegmented Mode		Segmented Mode	
		Instruction Format	Cycles	Instruction Format	Cycles
RA:	DJNZ R, displacement DBJNZ Rb, displacement		11		11

Example:

DJNZ and DBJNZ are typically used to control a "loop" of instructions. In this example for nonsegmented mode, 100 bytes are moved from one buffer area to another, and the sign bit of each byte is cleared to zero. Register RH0 is used as the counter.

```

LDB      RH0,#100          !initialize counter!
LDA      R1, SRCBUF       !load start address!
LDA      R2, DSTBUF

LOOP:
LDB      RL0,@R1          !load source byte!
RESB    RL0,#7           !mask off sign bit!
LDB      @R2, RL0        !store into destination!
INC      R1               !advance pointers!
INC      R2
DBJNZ   RH0, LOOP        !repeat until counter = 0!

NEXT:

```

For segmented mode, R1 and R2 must be changed for register pairs.

Privileged Instruction

EI Enable Interrupts

EI int

Int: VI, NVI

Operation:

If instruction (0) = 0 then NVI ← 1
 If instruction (1) = 0 then VI ← 1

Any combination of the Vectored Interrupt (VI) or Non-Vetored Interrupt (NVI) control bits in the Flags and Control Word (FCW) are set to one if the corresponding bit in the instruction is zero, thus enabling the appropriate type of interrupt. If the corresponding bit in the instruction is one, the control bit will not be affected. All other bits in the FCW are not affected. There may be one or two operands in the assembly language statement, in either order.

Flags:

No flags affected

Assembler Language Syntax	Nonsegmented Mode		Segmented Mode	
	Instruction Format	Cycles	Instruction Format	Cycles
EI int	<div style="border: 1px solid black; padding: 2px; display: inline-block;"> 01111100 000001 $\begin{matrix} V \\ N \end{matrix}$ </div>	7	<div style="border: 1px solid black; padding: 2px; display: inline-block;"> 01111100 000001 $\begin{matrix} V \\ N \end{matrix}$ </div>	7

Example:

If the NVI control bit is set (1) in the FCW, and the VI control bit is clear (0), the instruction

EI VI

will leave both the NVI and VI control bits in the FCW set (1)

EX Exchange

EX dst, src
EXB

dst: R
src: R, IR, DA, X

Operation: tmp ← src (tmp is a temporary internal register)
src ← dst
dst ← tmp

The contents of the source operand are exchanged with the contents of the destination operand.

Flags: No flags affected

Source Addressing Mode	Assembler Language Syntax	Nonsegmented Mode		Segmented Mode																				
		Instruction Format	Cycles	Instruction Format	Cycles																			
R:	EX Rd, Rs EXB Rbd, Rbs	<table border="1"><tr><td>10</td><td>10110</td><td>W</td><td>Rs</td><td>Rd</td></tr></table>	10	10110	W	Rs	Rd	6	<table border="1"><tr><td>10</td><td>10110</td><td>W</td><td>Rs</td><td>Rd</td></tr></table>	10	10110	W	Rs	Rd	6									
10	10110	W	Rs	Rd																				
10	10110	W	Rs	Rd																				
IR:	EX Rd, @Rs! EXB Rbd, @Rs!	<table border="1"><tr><td>00</td><td>10110</td><td>W</td><td>Rs≠0</td><td>Rd</td></tr></table>	00	10110	W	Rs≠0	Rd	12	<table border="1"><tr><td>00</td><td>10110</td><td>W</td><td>Rs≠0</td><td>Rd</td></tr></table>	00	10110	W	Rs≠0	Rd	12									
00	10110	W	Rs≠0	Rd																				
00	10110	W	Rs≠0	Rd																				
DA:	EX Rd, address EXB Rbd, address	<table border="1"><tr><td>01</td><td>10110</td><td>W</td><td>0000</td><td>Rd</td></tr><tr><td colspan="4">address</td></tr></table>	01	10110	W	0000	Rd	address				15	SS <table border="1"><tr><td>01</td><td>10110</td><td>W</td><td>0000</td><td>Rd</td></tr><tr><td>0</td><td>segment</td><td colspan="2">offset</td></tr></table>	01	10110	W	0000	Rd	0	segment	offset		16	
			01	10110	W	0000	Rd																	
address																								
01	10110	W	0000	Rd																				
0	segment	offset																						
X:	EX Rd, addr(Rs) EXB Rbd, addr(Rs)	<table border="1"><tr><td>01</td><td>10110</td><td>W</td><td>Rs≠0</td><td>Rd</td></tr><tr><td colspan="4">address</td></tr></table>	01	10110	W	Rs≠0	Rd	address				16	SL <table border="1"><tr><td>01</td><td>10110</td><td>W</td><td>0000</td><td>Rd</td></tr><tr><td>1</td><td>segment</td><td>0000</td><td>0000</td><td>offset</td></tr></table>	01	10110	W	0000	Rd	1	segment	0000	0000	offset	18
			01	10110	W	Rs≠0	Rd																	
address																								
01	10110	W	0000	Rd																				
1	segment	0000	0000	offset																				
				SS <table border="1"><tr><td>01</td><td>10110</td><td>W</td><td>Rs≠0</td><td>Rd</td></tr><tr><td>0</td><td>segment</td><td colspan="2">offset</td></tr></table>	01	10110	W	Rs≠0	Rd	0	segment	offset		16										
01	10110	W	Rs≠0	Rd																				
0	segment	offset																						
				SL <table border="1"><tr><td>01</td><td>10110</td><td>W</td><td>Rs≠0</td><td>Rd</td></tr><tr><td>1</td><td>segment</td><td>0000</td><td>0000</td><td>offset</td></tr></table>	01	10110	W	Rs≠0	Rd	1	segment	0000	0000	offset	19									
01	10110	W	Rs≠0	Rd																				
1	segment	0000	0000	offset																				

Example: If register R0 contains 8 and register R5 contains 9, the statement
EX R0,R5
will leave the values 9 in R0, and 8 in R5. The flags will be left unchanged.

Note 1: Word register in nonsegmented mode, register pair in segmented mode.

HALT

Privileged Instruction

Halt

Operation: The CPU operation is suspended until an interrupt or reset request is received. This instruction is used to synchronize the Z8000 with external events, preserving its state until an interrupt or reset request is honored. After an interrupt is serviced, the instruction following HALT is executed. While halted, memory refresh cycles will still occur, and BUSREQ will be honored.

Flags: No flags affected

	Assembler Language Syntax	Nonsegmented Mode		Segmented Mode					
		Instruction Format	Cycles ¹	Instruction Format	Cycles ¹				
	HALT	<table border="1"><tr><td>01111010</td><td>00000000</td></tr></table>	01111010	00000000	8 + 3n	<table border="1"><tr><td>01111010</td><td>00000000</td></tr></table>	01111010	00000000	8 + 3n
01111010	00000000								
01111010	00000000								

Note 1: Interrupts are recognized at the end of each 3-cycle period; thus n = number of periods without interruption.

Privileged Instruction

IN (SIN)

(Special) Input

IN dst, src	dst: R
INB	src: IR, DA
SIN dst, src	dst: R
SINB	src: DA

Operation dst ← src

The contents of the source operand, an Input or Special Input port, are loaded into the destination register. IN and INB are used for normal I/O operation; SIN and SINB are used for Special I/O operation.

Flags: No flags affected

Source Addressing Mode	Assembler Language Syntax	Nonsegmented Mode		Segmented Mode																					
		Instruction Format	Cycles	Instruction Format	Cycles																				
IR:	IN Rd1, @Rs	<table border="1"><tr><td>00</td><td>11110</td><td>W</td><td>Rs</td><td>Rd</td></tr></table>	00	11110	W	Rs	Rd	10	<table border="1"><tr><td>00</td><td>11110</td><td>W</td><td>Rs</td><td>Rd</td></tr></table>	00	11110	W	Rs	Rd	10										
	00	11110	W	Rs	Rd																				
00	11110	W	Rs	Rd																					
INB Rbd1, @Rs																									
DA:	IN Rd, port	<table border="1"><tr><td>00</td><td>11101</td><td>W</td><td>Rd</td><td>010S</td></tr><tr><td colspan="5">port</td></tr></table>	00	11101	W	Rd	010S	port					12	<table border="1"><tr><td>00</td><td>11101</td><td>W</td><td>Rd</td><td>010S</td></tr><tr><td colspan="5">port</td></tr></table>	00	11101	W	Rd	010S	port					12
	00	11101	W	Rd	010S																				
port																									
00	11101	W	Rd	010S																					
port																									
INB Rbd, port																									
	SIN Rd, port																								
	SINB Rbd, port																								

Example: If register R6 contains the I/O port address %0123 and the port %0123 contains %FF, the statement

INB RH2, @R6

will leave the value %FF in register RH2.

Note 1. Word register in nonsegmented mode; register pair in segmented mode.

INC

Increment

INC dst, src
INCB

dst: R, IR, DA, X
 src: IM

Operation: dst ← dst + src (src = 1 to 16)

The source operand (a value from 1 to 16) is added to the destination operand and the sum is stored in the destination. Two's complement addition is performed. The source operand may be omitted from the assembly language statement and defaults to the value 1.

The source field in the instruction format contains the source operand n. The coding for n ranges from 0 to 15, which corresponds to the source values 1 to 16.

Flags:

- C:** Unaffected
- Z:** Set if the result is zero; cleared otherwise
- S:** Set if the result is negative; cleared otherwise
- V:** Set if arithmetic overflow occurs, that is, if both operands were of the same sign, and the result is the opposite sign; cleared otherwise
- D:** Unaffected
- H:** Unaffected

Addressing Mode	Assembler Language Syntax	Nonsegmented Mode		Segmented Mode																												
		Instruction Format	Cycles	Instruction Format	Cycles																											
R:	INC Rd, #n INCB Rbd, #n	<table border="1"><tr><td>10</td><td>10100</td><td>W</td><td>Rd</td><td>n</td></tr></table>	10	10100	W	Rd	n	4	<table border="1"><tr><td>10</td><td>10100</td><td>W</td><td>Rd</td><td>n</td></tr></table>	10	10100	W	Rd	n	4																	
		10	10100	W	Rd	n																										
10	10100	W	Rd	n																												
<table border="1"><tr><td>00</td><td>10100</td><td>W</td><td>Rd≠0</td><td>n</td></tr></table>	00	10100	W	Rd≠0	n	<table border="1"><tr><td>00</td><td>10100</td><td>W</td><td>Rd≠0</td><td>n</td></tr></table>	00	10100	W	Rd≠0	n																					
00	10100	W	Rd≠0	n																												
00	10100	W	Rd≠0	n																												
IR:	INC @Rd ¹ , #n INCB @Rd ¹ , #n	<table border="1"><tr><td>01</td><td>10100</td><td>W</td><td>0000</td><td>n</td></tr><tr><td colspan="5">address</td></tr></table>	01	10100	W	0000	n	address					11	<table border="1"><tr><td>01</td><td>10100</td><td>W</td><td>0000</td><td>n</td></tr><tr><td>0</td><td>segment</td><td colspan="3">offset</td></tr></table>	01	10100	W	0000	n	0	segment	offset			14							
		01	10100	W	0000	n																										
address																																
01	10100	W	0000	n																												
0	segment	offset																														
<table border="1"><tr><td>01</td><td>10100</td><td>W</td><td>0000</td><td>n</td></tr><tr><td>1</td><td>segment</td><td>0000</td><td>0000</td><td>offset</td></tr></table>	01	10100	W	0000	n	1	segment	0000	0000	offset	<table border="1"><tr><td>01</td><td>10100</td><td>W</td><td>0000</td><td>n</td></tr><tr><td>1</td><td>segment</td><td>0000</td><td>0000</td><td>offset</td></tr></table>	01	10100	W	0000	n	1	segment	0000	0000	offset											
01	10100	W	0000	n																												
1	segment	0000	0000	offset																												
01	10100	W	0000	n																												
1	segment	0000	0000	offset																												
DA:	INC address, #n INCB address, #n	<table border="1"><tr><td>01</td><td>10100</td><td>W</td><td>Rd≠0</td><td>n</td></tr><tr><td colspan="5">address</td></tr></table>	01	10100	W	Rd≠0	n	address					13	<table border="1"><tr><td>01</td><td>10100</td><td>W</td><td>0000</td><td>n</td></tr><tr><td>0</td><td>segment</td><td colspan="3">offset</td></tr></table>	01	10100	W	0000	n	0	segment	offset			16							
		01	10100	W	Rd≠0	n																										
address																																
01	10100	W	0000	n																												
0	segment	offset																														
<table border="1"><tr><td>01</td><td>10100</td><td>W</td><td>Rd≠0</td><td>n</td></tr><tr><td colspan="5">address</td></tr></table>	01	10100	W	Rd≠0	n	address					<table border="1"><tr><td>01</td><td>10100</td><td>W</td><td>Rd≠0</td><td>n</td></tr><tr><td>0</td><td>segment</td><td colspan="3">offset</td></tr></table>	01	10100	W	Rd≠0	n	0	segment	offset			<table border="1"><tr><td>01</td><td>10100</td><td>W</td><td>Rd≠0</td><td>n</td></tr><tr><td>1</td><td>segment</td><td>0000</td><td>0000</td><td>offset</td></tr></table>	01	10100	W	Rd≠0	n	1	segment	0000	0000	offset
01	10100	W	Rd≠0	n																												
address																																
01	10100	W	Rd≠0	n																												
0	segment	offset																														
01	10100	W	Rd≠0	n																												
1	segment	0000	0000	offset																												
X:	INC addr(Rd), #n INCB addr(Rd), #n	<table border="1"><tr><td>01</td><td>10100</td><td>W</td><td>Rd≠0</td><td>n</td></tr><tr><td colspan="5">address</td></tr></table>	01	10100	W	Rd≠0	n	address					14	<table border="1"><tr><td>01</td><td>10100</td><td>W</td><td>Rd≠0</td><td>n</td></tr><tr><td>0</td><td>segment</td><td colspan="3">offset</td></tr></table>	01	10100	W	Rd≠0	n	0	segment	offset			14							
		01	10100	W	Rd≠0	n																										
address																																
01	10100	W	Rd≠0	n																												
0	segment	offset																														
<table border="1"><tr><td>01</td><td>10100</td><td>W</td><td>Rd≠0</td><td>n</td></tr><tr><td colspan="5">address</td></tr></table>	01	10100	W	Rd≠0	n	address					<table border="1"><tr><td>01</td><td>10100</td><td>W</td><td>Rd≠0</td><td>n</td></tr><tr><td>1</td><td>segment</td><td>0000</td><td>0000</td><td>offset</td></tr></table>	01	10100	W	Rd≠0	n	1	segment	0000	0000	offset	<table border="1"><tr><td>01</td><td>10100</td><td>W</td><td>Rd≠0</td><td>n</td></tr><tr><td>1</td><td>segment</td><td>0000</td><td>0000</td><td>offset</td></tr></table>	01	10100	W	Rd≠0	n	1	segment	0000	0000	offset
01	10100	W	Rd≠0	n																												
address																																
01	10100	W	Rd≠0	n																												
1	segment	0000	0000	offset																												
01	10100	W	Rd≠0	n																												
1	segment	0000	0000	offset																												

Example: If register RH2 contains %21, the statement
 INCB RH2,#6
 will leave the value %27 in RH2.

Note 1: Word register in nonsegmented mode, register pair in segmented mode.

Privileged Instruction

IND (SIND)

(Special) Input and Decrement

IND dst, src, r dst: IR
INDB src: IR
SIND
SINDB

Operation: dst ← src
 AUTODECREMENT dst (by 1 byte, by 2 if word)
 r ← r - 1

This instruction is used for block input of strings of data. IND and INDB are used for normal I/O operation; SIND and SINDB are used for special I/O operation. The contents of the I/O port addressed by the source word register are loaded into the memory location addressed by the destination register. I/O port addresses are 16 bits. The destination register is then decremented by one if a byte instruction or by two if a word instruction, thus moving the pointer to the previous element of the string in memory. The word register specified by "r" (used as a counter) is then decremented by one. The address of the I/O port in the source register is unchanged.

Flags: **C:** Unaffected
 Z: Unaffected
 S: Unaffected
 V: Set if the result of decrementing r is zero; cleared otherwise
 D: Unaffected
 H: Unaffected

Addressing Mode	Assembler Language Syntax	Nonsegmented Mode		Segmented Mode																	
		Instruction Format	Cycles	Instruction Format	Cycles																
IR:	IND @Rd1, @Rs, r INDB @Rd1, @Rs, r SIND @Rd1, @Rs, r SINDB @Rd1, @Rs, r	<table border="1"> <tr> <td>0011101</td> <td>W</td> <td>Rs</td> <td>100S</td> </tr> <tr> <td>0000</td> <td>r</td> <td>Rd</td> <td>1000</td> </tr> </table>	0011101	W	Rs	100S	0000	r	Rd	1000	21	<table border="1"> <tr> <td>0011101</td> <td>W</td> <td>Rs</td> <td>100S</td> </tr> <tr> <td>0000</td> <td>r</td> <td>Rd</td> <td>1000</td> </tr> </table>	0011101	W	Rs	100S	0000	r	Rd	1000	21
		0011101	W	Rs	100S																
0000	r	Rd	1000																		
0011101	W	Rs	100S																		
0000	r	Rd	1000																		

Example: In segmented mode, if register RR4 contains %02004000 (segment 2, offset %4000), register R6 contains the I/O port address %0228, the port %0228 contains %05B9, and register R0 contains %0016, the instruction

IND @RR4, @R6, R0

will leave the value %05B9 in location %02004000, the value %02003FFE in RR4, and the value %0015 in R0. The V flag will be cleared. Register R6 still contains the value %0228. In nonsegmented mode, a word register would be used instead of RR4.

Note 1: Word register in nonsegmented mode, register pair in segmented mode.

INDR (SINDR)

Privileged Instruction

(Special) Input, Decrement and Repeat

INDR dst, src, r	dst: IR
INDRB	src: IR
SINDR	
SINDRB	

Operation:

dst ← src
 AUTODECREMENT dst (by 1 if byte, by 2 if word)
 r ← r - 1
 repeat until r = 0

This instruction is used for block input of strings of data. INDR and INDRB are used for normal I/O operation; SINDR and SINDRB are used for special I/O operation. The contents of the I/O port addressed by the source word register are loaded into the memory location addressed by the destination register. I/O port addresses are 16 bits. The destination register is then decremented by one if a byte instruction, or by two if a word instruction, thus moving the pointer to the previous element of the string in memory. The word register specified by "r" (used as a counter) is then decremented by one. The address of the I/O port in the source register is unchanged. The entire operation is repeated until the result of decrementing r is zero. This instruction can input from 1 to 65536 bytes or 32768 words (the value for r must not be greater than 32768 for INDR or SINDR).

This instruction can be interrupted after each execution of the basic operation. The program counter value of the start of this instruction is saved before the interrupt request is accepted, so that the instruction can be properly resumed. Seven more cycles should be added to this instruction's execution time for each interrupt request that is accepted.

Flags:

C: Unaffected
Z: Undefined
S: Unaffected
V: Set
D: Unaffected
H: Unaffected

Addressing Mode	Assembler Language Syntax	Nonsegmented Mode		Segmented Mode																	
		Instruction Format	Cycles	Instruction Format	Cycles																
IR:	INDR @Rd!, @Rs, r INDRB @Rd!, @Rs, r SINDR @Rd!, @Rs, r SINDRB @Rd!, @Rs, r	<table border="1"> <tr> <td>0011101</td> <td>W</td> <td>Rs</td> <td>100S</td> </tr> <tr> <td>0000</td> <td>r</td> <td>Rd</td> <td>0000</td> </tr> </table>	0011101	W	Rs	100S	0000	r	Rd	0000	11 + 10n	<table border="1"> <tr> <td>0011101</td> <td>W</td> <td>Rs</td> <td>100S</td> </tr> <tr> <td>0000</td> <td>r</td> <td>Rd</td> <td>0000</td> </tr> </table>	0011101	W	Rs	100S	0000	r	Rd	0000	11 + 10n
		0011101	W	Rs	100S																
0000	r	Rd	0000																		
0011101	W	Rs	100S																		
0000	r	Rd	0000																		

Example:

If register R1 contains %202A, register R2 contains the Special I/O address %0AFC, and register R3 contains 8, the instruction

SINDRB @R1, @R2, R3

will input 8 bytes from the special I/O port 0AFC and leave them in descending order from %202A to %2023. Register R1 will contain %2022, and R3 will contain 0. R2 will not be affected. The V flag will be set. This example assumes nonsegmented mode; in segmented mode, R1 would be replaced by a register pair.

Note 1: Word register in nonsegmented mode, register pair in segmented mode.

Note 2: n = number of data elements transferred.

INI (SINI)

Privileged Instruction

(Special) Input and Increment

INI dst, src, r dst: IR
 INIB src: IR
 SINI
 SINIB

Operation: dst ← src
 AUTOINCREMENT dst (by 1 if byte, by 2 if word)
 r ← r - 1

This instruction is used for block input of strings of data. INI, INIB are used for normal I/O operation; SINI, SINIB are used for special I/O operation. The contents of the I/O port addressed by the source word register are loaded into the memory location addressed by the destination register. I/O port addresses are 16 bits. The destination register is then incremented by one if a byte instruction, or by two if a word instruction, thus moving the pointer to the next element of the string in memory. The word register specified by "r" (used as a counter) is then decremented by one. The address of the I/O port in the source register is unchanged.

Flags: **C:** Unaffected
 Z: Undefined
 S: Unaffected
 V: Set if the result of decrementing r is zero; cleared otherwise
 D: Unaffected
 H: Unaffected

Addressing Mode	Assembler Language Syntax	Nonsegmented Mode		Segmented Mode																	
		Instruction Format	Cycles	Instruction Format	Cycles																
IR:	INI @Rd!, @Rs, r INIB @Rd!, @Rs, r SINI @Rd!, @Rs, r SINIB @Rd!, @Rs, r	<table border="1"> <tr> <td>0011101</td> <td>W</td> <td>Rs</td> <td>000S</td> </tr> <tr> <td>0000</td> <td>r</td> <td>Rd</td> <td>1000</td> </tr> </table>	0011101	W	Rs	000S	0000	r	Rd	1000	21	<table border="1"> <tr> <td>0011101</td> <td>W</td> <td>Rs</td> <td>000S</td> </tr> <tr> <td>0000</td> <td>r</td> <td>Rd</td> <td>1000</td> </tr> </table>	0011101	W	Rs	000S	0000	r	Rd	1000	21
0011101	W	Rs	000S																		
0000	r	Rd	1000																		
0011101	W	Rs	000S																		
0000	r	Rd	1000																		

Example: In nonsegmented mode, if register R4 contains %4000, register R6 contains the I/O port address %0229, the port %0228 contains %B9, and register R0 contains %0016, the instruction

INIB @R4, @R6, R0

will leave the value %B9 in location %4000, the value %4001 in R4, and the value %0015 in R0. Register R6 still contains the value %0229. The V flag is cleared. In segmented mode, R4 would be replaced by a register pair.

Note 1: Word register in nonsegmented mode, register pair in segmented mode.

Privileged Instruction

INIR (SINIR)

(Special) Input, Increment and Repeat

INIR dst, src, r dst: IR
 INIRB src: IR
 SINIR
 SINIRB

Operation: dst ← src
 AUTOINCREMENT dst (by 1 if byte, by 2 if word)
 r ← r - 1
 repeat until r = 0

This instruction is used for block input of strings of data. INIR and INIRB are used for normal I/O operation; SINIR and SINIRB are used for special I/O operation. The contents of the I/O port addressed by the source word register are loaded into the memory location addressed by the destination register. I/O port addresses are 16 bits. The destination register is then incremented by one if a byte instruction, or by two if a word instruction, thus moving the pointer to the next element in the string. The word register specified by "r" (used as a counter) is then decremented by one. The address of the I/O port in the source register is unchanged. The entire operation is repeated until the result of decrementing r is zero. This instruction can input from 1 to 65536 bytes or 32768 words (the value for r must not be greater than 32768 for INIR or SINIR).

This instruction can be interrupted after each execution of the basic operation. The program counter value of the start of this instruction is saved before the interrupt request is accepted, so that the instruction can be properly resumed. Seven more cycles should be added to this instruction's execution time for each interrupt request that is accepted.

Flags: **C:** Unaffected
 Z: Unaffected
 S: Unaffected
 V: Set
 D: Unaffected
 H: Unaffected

Addressing Mode	Assembler Language Syntax	Nonsegmented Mode		Segmented Mode																	
		Instruction Format	Cycles	Instruction Format	Cycles																
IR:	INIR @Rd ¹ , @Rs, r INIRB @Rd ¹ , @Rs, r SINIR @Rd ¹ , @Rs, r SINIRB @Rd ¹ , @Rs, r	<table border="1" style="border-collapse: collapse; text-align: center;"> <tr> <td style="padding: 2px;">0011101</td> <td style="padding: 2px;">W</td> <td style="padding: 2px;">Rs</td> <td style="padding: 2px;">000S</td> </tr> <tr> <td style="padding: 2px;">0000</td> <td style="padding: 2px;">r</td> <td style="padding: 2px;">Rd</td> <td style="padding: 2px;">0000</td> </tr> </table>	0011101	W	Rs	000S	0000	r	Rd	0000	11 + 10n	<table border="1" style="border-collapse: collapse; text-align: center;"> <tr> <td style="padding: 2px;">0011101</td> <td style="padding: 2px;">W</td> <td style="padding: 2px;">Rs</td> <td style="padding: 2px;">000S</td> </tr> <tr> <td style="padding: 2px;">0000</td> <td style="padding: 2px;">r</td> <td style="padding: 2px;">Rd</td> <td style="padding: 2px;">0000</td> </tr> </table>	0011101	W	Rs	000S	0000	r	Rd	0000	11 + 10n
0011101	W	Rs	000S																		
0000	r	Rd	0000																		
0011101	W	Rs	000S																		
0000	r	Rd	0000																		

Example:

In nonsegmented mode, if register R1 contains %2023, register R2 contains the I/O port address %0551, and register R3 contains 8, the statement

```
INIRB @R1, @R2, R3
```

will input 8 bytes from port %0051 and leave them in ascending order from %2023 to %202A. Register R1 will contain %202B, and R3 will contain 0. R2 will not be affected. The V flag will be set. In segmented mode, a register pair must be used instead of R1.

Note 1: Word register in nonsegmented mode, register pair in segmented mode.

Note 2: n = number of data elements transferred.

Privileged Instruction

IRET

Interrupt Return

IRET

Operation:

Nonsegmented

SP ← SP + 2 (Pop "identifier")

PS ← @SP

SP ← SP + 4

Segmented

SP ← SP + 2 (Pop "identifier")

PS ← @SP

SP ← SP + 6

This instruction is used to return to a previously executed procedure at the end of a procedure entered by an interrupt or trap (including a System Call instruction). First, the "identifier" word associated with the interrupt or trap is popped from the system processor stack and discarded. Then contents of the location addressed by the system processor stack pointer are popped into the program status (PS), loading the Flags and Control Word (FCW) and the program counter (PC). The new value of the FCW is not effective until the next instruction, so that the status pins will not be affected by the new control bits until after the IRET instruction execution is completed. The next instruction executed is that addressed by the new contents of the PC. The system stack pointer (R15 if nonsegmented, or RR14 if segmented) is used to access memory.

Flags:

C: Loaded from processor stack

Z: Loaded from processor stack

S: Loaded from processor stack

P/V: Loaded from processor stack

D: Loaded from processor stack

H: Loaded from processor stack

Addressing Mode	Assembler Language Syntax	Nonsegmented Mode		Segmented Mode	
		Instruction Format	Cycles	Instruction Format	Cycles
	IRET	01111011 00000000	13	01111011 00000000	16

Example:

In the nonsegmented Z8002 version, if the program counter contains %2550, the system stack pointer (R15) contains %3000, and locations %3000, %3002 and %3004 contain %7F03, a saved FCW value, and %1004, respectively, the instruction

IRET

will leave the value %3006 in the system stack pointer and the program counter will contain %1004, the address of the next instruction to be executed. The program status will be determined by the saved FCW value.

JP Jump

JP cc, dst

dst: IR, DA, X

Operation: If cc is satisfied, then PC ← dst

A conditional jump transfers program control to the destination address if the condition specified by "cc" is satisfied by the flags in the FCW. See section 6.6.1 for a list of condition codes. If the condition is satisfied, the program counter (PC) is loaded with the designated address; otherwise, the instruction following the JP instruction is executed.

Flags: No flags affected

Destination Addressing Mode	Assembler Language Syntax	Nonsegmented Mode		Segmented Mode																					
		Instruction Format	Cycles ²	Instruction Format	Cycles ²																				
IR:	JP cc, @Rd ¹	<table border="1"><tr><td>00</td><td>011110</td><td>Rd≠0</td><td>cc</td></tr></table>	00	011110	Rd≠0	cc	10/7	<table border="1"><tr><td>00</td><td>011110</td><td>Rd≠0</td><td>cc</td></tr></table>	00	011110	Rd≠0	cc	15/7												
00	011110	Rd≠0	cc																						
00	011110	Rd≠0	cc																						
DA:	JP cc, address	<table border="1"><tr><td>01</td><td>011110</td><td>0000</td><td>cc</td></tr><tr><td colspan="4">address</td></tr></table>	01	011110	0000	cc	address				7/7	SS <table border="1"><tr><td>01</td><td>011110</td><td>0000</td><td>cc</td></tr><tr><td>0</td><td>segment</td><td colspan="2">offset</td></tr></table>	01	011110	0000	cc	0	segment	offset		8/8				
01	011110	0000	cc																						
address																									
01	011110	0000	cc																						
0	segment	offset																							
X:	JP cc, addr(Rd)	<table border="1"><tr><td>01</td><td>011110</td><td>Rd≠0</td><td>cc</td></tr><tr><td colspan="4">address</td></tr></table>	01	011110	Rd≠0	cc	address				8/8	SL <table border="1"><tr><td>01</td><td>011110</td><td>0000</td><td>cc</td></tr><tr><td>1</td><td>segment</td><td>0000</td><td>0000</td></tr><tr><td colspan="4">offset</td></tr></table>	01	011110	0000	cc	1	segment	0000	0000	offset				10/10
01	011110	Rd≠0	cc																						
address																									
01	011110	0000	cc																						
1	segment	0000	0000																						
offset																									
				SS <table border="1"><tr><td>01</td><td>011110</td><td>Rd≠0</td><td>cc</td></tr><tr><td>0</td><td>segment</td><td colspan="2">offset</td></tr></table>	01	011110	Rd≠0	cc	0	segment	offset		11/11												
01	011110	Rd≠0	cc																						
0	segment	offset																							
				SL <table border="1"><tr><td>01</td><td>011110</td><td>Rd≠0</td><td>cc</td></tr><tr><td>1</td><td>segment</td><td>0000</td><td>0000</td></tr><tr><td colspan="4">offset</td></tr></table>	01	011110	Rd≠0	cc	1	segment	0000	0000	offset				11/11								
01	011110	Rd≠0	cc																						
1	segment	0000	0000																						
offset																									

Example: If the carry flag is set, the statement
 JP C, %1520
 replaces the contents of the program counter with %1520, thus transferring control to that location.

Note 1: Word register in nonsegmented mode, register pair in segmented mode.

Note 2: The two values correspond to jump taken and jump not taken.

JR cc, dst

dst: RA

Operation: if cc is satisfied then $PC \leftarrow PC + (2 \times \text{displacement})$

A conditional jump transfers program control to the destination address if the condition specified by "cc" is satisfied by the flags in the FCW. See section 6.6.1 for a list of condition codes. If the condition is satisfied, the program counter (PC) is loaded with the designated address; otherwise, the instruction following the JR instruction is executed. The destination address is calculated by doubling the displacement in the instruction, then adding this value to the updated value of the PC to derive the destination address. The updated PC value is taken to be the address of the instruction byte following the JR instruction, while the displacement is a 8-bit signed value in the range -128 to +127. Thus, the destination address must be in the range -254 to +256 bytes from the start of the JR instruction. In the segmented mode, the PC segment number is not affected.

The assembler automatically calculates the displacement by subtracting the PC value of the following instruction from the address given by the programmer.

Flags: No flags affected

Destination Addressing Mode	Assembler Language Syntax	Nonsegmented Mode		Segmented Mode							
		Instruction Format	Cycles	Instruction Format	Cycles						
RA:	JR cc, address	<table border="1" style="display: inline-table;"> <tr> <td style="padding: 2px;">1 1 1 0</td> <td style="padding: 2px;">cc</td> <td style="padding: 2px;">displacement</td> </tr> </table>	1 1 1 0	cc	displacement	6	<table border="1" style="display: inline-table;"> <tr> <td style="padding: 2px;">1 1 1 0</td> <td style="padding: 2px;">cc</td> <td style="padding: 2px;">displacement</td> </tr> </table>	1 1 1 0	cc	displacement	6
1 1 1 0	cc	displacement									
1 1 1 0	cc	displacement									

Example: If the result of the last arithmetic operation executed is negative, the following four instructions (which occupy a total of twelve bytes) are to be skipped. This can be accomplished with the instruction

```
JR MI, $ +14
```

If the S flag is not set, execution continues with the instruction following the JR.

A byte-saving form of a jump to the label LAB is

```
JR LAB
```

where LAB must be within the allowed range. The condition code is "blank" in this case, and indicates that the jump is always taken.

LD Load

LD dst, src
LDB
LDL

dst: R
src: R, IR, DA, X, BA, BX

or
dst: IR, DA, X, BA, BX
src: R
or
dst: R, IR, DA, X
src: IM

Operation: dst ← src

The contents of the source are loaded into the destination. The contents of the source are not affected.

There are three versions of the Load instruction: Load into a register, load into memory and load an immediate value.

Flags: No flags affected

Load Register

Source Addressing Mode	Assembler Language Syntax	Nonsegmented Mode		Segmented Mode																				
		Instruction Format	Cycles	Instruction Format	Cycles																			
R:	LD Rd, Rs	<table border="1"><tr><td>10</td><td>10000</td><td>W</td><td>Rs</td><td>Rd</td></tr></table>	10	10000	W	Rs	Rd	3	<table border="1"><tr><td>10</td><td>10000</td><td>W</td><td>Rs</td><td>Rd</td></tr></table>	10	10000	W	Rs	Rd	3									
	10	10000	W	Rs	Rd																			
	10	10000	W	Rs	Rd																			
LDB Rbd, Rbs																								
LDL RRd, RRs	<table border="1"><tr><td>10</td><td>010100</td><td></td><td>RRs</td><td>RRd</td></tr></table>	10	010100		RRs	RRd	5	<table border="1"><tr><td>10</td><td>010100</td><td></td><td>RRs</td><td>RRd</td></tr></table>	10	010100		RRs	RRd	5										
10	010100		RRs	RRd																				
10	010100		RRs	RRd																				
IR:	LD Rd, @Rs ¹	<table border="1"><tr><td>00</td><td>10000</td><td>W</td><td>Rs≠0</td><td>Rd</td></tr></table>	00	10000	W	Rs≠0	Rd	7	<table border="1"><tr><td>00</td><td>10000</td><td>W</td><td>Rs≠0</td><td>Rd</td></tr></table>	00	10000	W	Rs≠0	Rd	7									
	00	10000	W	Rs≠0	Rd																			
	00	10000	W	Rs≠0	Rd																			
LDB Rbd, @Rs ¹																								
LDL RRd, @Rs ¹	<table border="1"><tr><td>00</td><td>010100</td><td></td><td>Rs≠0</td><td>RRd</td></tr></table>	00	010100		Rs≠0	RRd	11	<table border="1"><tr><td>00</td><td>010100</td><td></td><td>Rs≠0</td><td>RRd</td></tr></table>	00	010100		Rs≠0	RRd	11										
00	010100		Rs≠0	RRd																				
00	010100		Rs≠0	RRd																				
DA:	LD Rd, address	<table border="1"><tr><td>01</td><td>10000</td><td>W</td><td>0000</td><td>Rd</td></tr><tr><td colspan="5">address</td></tr></table>	01	10000	W	0000	Rd	address					9	SS <table border="1"><tr><td>01</td><td>10000</td><td>W</td><td>0000</td><td>Rd</td></tr><tr><td>0</td><td>segment</td><td></td><td>offset</td></tr></table>	01	10000	W	0000	Rd	0	segment		offset	10
	01	10000	W	0000	Rd																			
	address																							
	01	10000	W	0000	Rd																			
	0	segment		offset																				
	LDB Rbd, address		SL <table border="1"><tr><td>01</td><td>10000</td><td>W</td><td>0000</td><td>Rd</td></tr><tr><td>1</td><td>segment</td><td></td><td>0000 0000</td></tr><tr><td colspan="5">offset</td></tr></table>	01	10000	W	0000	Rd	1	segment		0000 0000	offset					12						
01	10000	W	0000	Rd																				
1	segment		0000 0000																					
offset																								
LDL RRd, address	<table border="1"><tr><td>01</td><td>010100</td><td></td><td>0000</td><td>RRd</td></tr><tr><td colspan="5">address</td></tr></table>	01	010100		0000	RRd	address					12	SS <table border="1"><tr><td>01</td><td>010100</td><td></td><td>0000</td><td>RRd</td></tr><tr><td>0</td><td>segment</td><td></td><td>offset</td></tr></table>	01	010100		0000	RRd	0	segment		offset	13	
01	010100		0000	RRd																				
address																								
01	010100		0000	RRd																				
0	segment		offset																					
		SL <table border="1"><tr><td>01</td><td>010100</td><td></td><td>0000</td><td>RRd</td></tr><tr><td>1</td><td>segment</td><td></td><td>0000 0000</td></tr><tr><td colspan="5">offset</td></tr></table>	01	010100		0000	RRd	1	segment		0000 0000	offset					15							
01	010100		0000	RRd																				
1	segment		0000 0000																					
offset																								

Note 1: Word register in nonsegmented mode, register pair in segmented mode.

Load Register (Continued)

Source Addressing Mode	Assembler Language Syntax	Nonsegmented Mode		Segmented Mode																												
		Instruction Format	Cycles	Instruction Format	Cycles																											
X:	LD Rd, addr(Rs) LDB Rbd, addr(Rs)	<table border="1"> <tr> <td>01</td> <td>10000</td> <td>W</td> <td>Rs≠0</td> <td>Rd</td> </tr> <tr> <td colspan="5">address</td> </tr> </table>	01	10000	W	Rs≠0	Rd	address					10	<table border="1"> <tr> <td rowspan="2">SS</td> <td>01</td> <td>10000</td> <td>W</td> <td>Rs≠0</td> <td>Rd</td> </tr> <tr> <td>0</td> <td colspan="2">segment</td> <td colspan="2">offset</td> </tr> </table>	SS	01	10000	W	Rs≠0	Rd	0	segment		offset		10						
	01	10000	W	Rs≠0	Rd																											
address																																
SS	01	10000	W	Rs≠0	Rd																											
	0	segment		offset																												
	LDL RRd, addr(Rs)	<table border="1"> <tr> <td>01</td> <td>010100</td> <td>Rs≠0</td> <td>RRd</td> <td></td> </tr> <tr> <td colspan="5">address</td> </tr> </table>	01	010100	Rs≠0	RRd		address					13	<table border="1"> <tr> <td rowspan="2">SL</td> <td>01</td> <td>10000</td> <td>W</td> <td>Rs≠0</td> <td>Rd</td> </tr> <tr> <td>1</td> <td colspan="2">segment</td> <td colspan="2">0000 0000</td> </tr> <tr> <td colspan="6">offset</td> </tr> </table>	SL	01	10000	W	Rs≠0	Rd	1	segment		0000 0000		offset						13
01	010100	Rs≠0	RRd																													
address																																
SL	01	10000	W	Rs≠0	Rd																											
	1	segment		0000 0000																												
offset																																
BA:	LD Rd, Rs!(#disp) LDB Rbd, Rs!(#disp)	<table border="1"> <tr> <td>00</td> <td>11000</td> <td>W</td> <td>Rs≠0</td> <td>Rd</td> </tr> <tr> <td colspan="5">displacement</td> </tr> </table>	00	11000	W	Rs≠0	Rd	displacement					14	<table border="1"> <tr> <td rowspan="2">SS</td> <td>01</td> <td>010100</td> <td>Rs≠0</td> <td>RRd</td> <td></td> </tr> <tr> <td>0</td> <td colspan="2">segment</td> <td colspan="2">offset</td> </tr> </table>	SS	01	010100	Rs≠0	RRd		0	segment		offset		13						
	00	11000	W	Rs≠0	Rd																											
displacement																																
SS	01	010100	Rs≠0	RRd																												
	0	segment		offset																												
	LDL RRd, Rs!(#disp)	<table border="1"> <tr> <td>00</td> <td>110101</td> <td>Rs≠0</td> <td>Rd</td> <td></td> </tr> <tr> <td colspan="5">displacement</td> </tr> </table>	00	110101	Rs≠0	Rd		displacement					17	<table border="1"> <tr> <td rowspan="2">SL</td> <td>01</td> <td>010100</td> <td>Rs≠0</td> <td>RRd</td> <td></td> </tr> <tr> <td>1</td> <td colspan="2">segment</td> <td colspan="2">0000 0000</td> </tr> <tr> <td colspan="6">offset</td> </tr> </table>	SL	01	010100	Rs≠0	RRd		1	segment		0000 0000		offset						16
00	110101	Rs≠0	Rd																													
displacement																																
SL	01	010100	Rs≠0	RRd																												
	1	segment		0000 0000																												
offset																																
BX:	LD Rd, Rs!(Rx) LDB Rd, Rs!(Rx)	<table border="1"> <tr> <td>00</td> <td>11000</td> <td>W</td> <td>Rs≠0</td> <td>Rd</td> </tr> <tr> <td colspan="5">displacement</td> </tr> </table>	00	11000	W	Rs≠0	Rd	displacement					14	<table border="1"> <tr> <td rowspan="2">SS</td> <td>00</td> <td>11000</td> <td>W</td> <td>Rs≠0</td> <td>Rd</td> </tr> <tr> <td colspan="5">displacement</td> </tr> </table>	SS	00	11000	W	Rs≠0	Rd	displacement					14						
	00	11000	W	Rs≠0	Rd																											
displacement																																
SS	00	11000	W	Rs≠0	Rd																											
	displacement																															
	LDL RRd, Rs!(Rx)	<table border="1"> <tr> <td>00</td> <td>110101</td> <td>Rs≠0</td> <td>Rd</td> <td></td> </tr> <tr> <td colspan="5">displacement</td> </tr> </table>	00	110101	Rs≠0	Rd		displacement					17	<table border="1"> <tr> <td rowspan="2">SL</td> <td>00</td> <td>110101</td> <td>Rs≠0</td> <td>Rd</td> <td></td> </tr> <tr> <td colspan="5">displacement</td> </tr> </table>	SL	00	110101	Rs≠0	Rd		displacement					17						
00	110101	Rs≠0	Rd																													
displacement																																
SL	00	110101	Rs≠0	Rd																												
	displacement																															
	LD Rd, Rs!(Rx) LDB Rd, Rs!(Rx)	<table border="1"> <tr> <td>01</td> <td>11000</td> <td>W</td> <td>Rs≠0</td> <td>Rd</td> </tr> <tr> <td>0000</td> <td>Rx</td> <td colspan="3">0000 0000</td> </tr> </table>	01	11000	W	Rs≠0	Rd	0000	Rx	0000 0000			14	<table border="1"> <tr> <td rowspan="2">SS</td> <td>01</td> <td>11000</td> <td>W</td> <td>Rs≠0</td> <td>Rd</td> </tr> <tr> <td>0000</td> <td>Rx</td> <td colspan="3">0000 0000</td> </tr> </table>	SS	01	11000	W	Rs≠0	Rd	0000	Rx	0000 0000			14						
01	11000	W	Rs≠0	Rd																												
0000	Rx	0000 0000																														
SS	01	11000	W	Rs≠0	Rd																											
	0000	Rx	0000 0000																													
	LDL RRd, Rs!(Rx)	<table border="1"> <tr> <td>01</td> <td>11010</td> <td>1</td> <td>Rs≠0</td> <td>Rd</td> </tr> <tr> <td>0000</td> <td>Rx</td> <td colspan="3">0000 0000</td> </tr> </table>	01	11010	1	Rs≠0	Rd	0000	Rx	0000 0000			17	<table border="1"> <tr> <td rowspan="2">SL</td> <td>01</td> <td>11010</td> <td>1</td> <td>Rs≠0</td> <td>Rd</td> </tr> <tr> <td>0000</td> <td>Rx</td> <td colspan="3">0000 0000</td> </tr> </table>	SL	01	11010	1	Rs≠0	Rd	0000	Rx	0000 0000			17						
01	11010	1	Rs≠0	Rd																												
0000	Rx	0000 0000																														
SL	01	11010	1	Rs≠0	Rd																											
	0000	Rx	0000 0000																													

Load Memory

Destination Addressing Mode	Assembler Language Syntax	Nonsegmented Mode		Segmented Mode																						
		Instruction Format	Cycles	Instruction Format	Cycles																					
IR:	LD @Rd ¹ , Rs LDB @Rd ¹ , Rbs	<table border="1"> <tr> <td>00</td> <td>10111</td> <td>W</td> <td>Rd</td> <td>Rs</td> </tr> </table>	00	10111	W	Rd	Rs	8	<table border="1"> <tr> <td>00</td> <td>10111</td> <td>W</td> <td>Rd</td> <td>Rs</td> </tr> </table>	00	10111	W	Rd	Rs	8											
	00	10111	W	Rd	Rs																					
00	10111	W	Rd	Rs																						
	LDL @Rd ¹ , RRs	<table border="1"> <tr> <td>00</td> <td>011101</td> <td>Rd</td> <td>RRs</td> <td></td> </tr> </table>	00	011101	Rd	RRs		11	<table border="1"> <tr> <td>00</td> <td>011101</td> <td>Rd</td> <td>RRs</td> <td></td> </tr> </table>	00	011101	Rd	RRs		11											
00	011101	Rd	RRs																							
00	011101	Rd	RRs																							
DA:	LD address, Rs LDB address, Rbs	<table border="1"> <tr> <td>01</td> <td>10111</td> <td>W</td> <td>0000</td> <td>Rs</td> </tr> <tr> <td colspan="5">address</td> </tr> </table>	01	10111	W	0000	Rs	address					11	<table border="1"> <tr> <td rowspan="2">SS</td> <td>01</td> <td>10111</td> <td>W</td> <td>0000</td> <td>Rs</td> </tr> <tr> <td>0</td> <td colspan="2">segment</td> <td colspan="2">offset</td> </tr> </table>	SS	01	10111	W	0000	Rs	0	segment		offset		12
	01	10111	W	0000	Rs																					
address																										
SS	01	10111	W	0000	Rs																					
	0	segment		offset																						
						<table border="1"> <tr> <td rowspan="2">SL</td> <td>01</td> <td>10111</td> <td>W</td> <td>0000</td> <td>Rs</td> </tr> <tr> <td>1</td> <td colspan="2">segment</td> <td colspan="2">0000 0000</td> </tr> <tr> <td colspan="6">offset</td> </tr> </table>	SL	01	10111	W	0000	Rs	1	segment		0000 0000		offset						14		
SL	01	10111	W	0000	Rs																					
	1	segment		0000 0000																						
offset																										

Note 1: Word register in nonsegmented mode, register pair in segmented mode.

Load Memory (Continued)

Destination Addressing Mode	Assembler Language Syntax	Nonsegmented Mode		Segmented Mode																						
		Instruction Format	Cycles	Instruction Format	Cycles																					
DA:	LDL address, RRs	<table border="1"> <tr> <td>01</td> <td>011101</td> <td>0000</td> <td>RRs</td> </tr> <tr> <td colspan="4">address</td> </tr> </table>	01	011101	0000	RRs	address				14	<table border="1"> <tr> <td rowspan="2">SS</td> <td>01</td> <td>011101</td> <td>0000</td> <td>RRs</td> </tr> <tr> <td>0</td> <td>segment</td> <td colspan="2">offset</td> </tr> </table>	SS	01	011101	0000	RRs	0	segment	offset		15				
		01	011101	0000	RRs																					
address																										
SS	01	011101	0000	RRs																						
	0	segment	offset																							
				<table border="1"> <tr> <td rowspan="2">SL</td> <td>01</td> <td>011101</td> <td>0000</td> <td>RRs</td> </tr> <tr> <td>1</td> <td>segment</td> <td colspan="2">0000 0000</td> </tr> <tr> <td colspan="5">offset</td> </tr> </table>	SL	01	011101	0000	RRs	1	segment	0000 0000		offset					17							
SL	01	011101	0000	RRs																						
	1	segment	0000 0000																							
offset																										
X:	LD addr(Rd), Rs LDB addr(Rd), Rbs	<table border="1"> <tr> <td>01</td> <td>10111</td> <td>W</td> <td>Rd≠0</td> <td>Rs</td> </tr> <tr> <td colspan="5">address</td> </tr> </table>	01	10111	W	Rd≠0	Rs	address					12	<table border="1"> <tr> <td rowspan="2">SS</td> <td>01</td> <td>10111</td> <td>W</td> <td>Rd≠0</td> <td>Rs</td> </tr> <tr> <td>0</td> <td>segment</td> <td colspan="3">offset</td> </tr> </table>	SS	01	10111	W	Rd≠0	Rs	0	segment	offset			12
		01	10111	W	Rd≠0	Rs																				
		address																								
		SS	01	10111	W	Rd≠0	Rs																			
0	segment		offset																							
				<table border="1"> <tr> <td rowspan="2">SL</td> <td>01</td> <td>10111</td> <td>W</td> <td>Rd≠0</td> <td>Rs</td> </tr> <tr> <td>1</td> <td>segment</td> <td colspan="3">0000 0000</td> </tr> <tr> <td colspan="6">offset</td> </tr> </table>	SL	01	10111	W	Rd≠0	Rs	1	segment	0000 0000			offset						15				
SL	01	10111	W	Rd≠0		Rs																				
	1	segment	0000 0000																							
offset																										
		<table border="1"> <tr> <td>01</td> <td>011101</td> <td>Rd≠0</td> <td>RRs</td> </tr> <tr> <td colspan="4">address</td> </tr> </table>	01	011101	Rd≠0	RRs	address				15	<table border="1"> <tr> <td rowspan="2">SS</td> <td>01</td> <td>011101</td> <td>Rd≠0</td> <td>RRs</td> </tr> <tr> <td>0</td> <td>segment</td> <td colspan="2">offset</td> </tr> </table>	SS	01	011101	Rd≠0	RRs	0	segment	offset		15				
01	011101	Rd≠0	RRs																							
address																										
SS	01	011101	Rd≠0	RRs																						
	0	segment	offset																							
				<table border="1"> <tr> <td rowspan="2">SL</td> <td>01</td> <td>011101</td> <td>Rd≠0</td> <td>RRs</td> </tr> <tr> <td>1</td> <td>segment</td> <td colspan="2">0000 0000</td> </tr> <tr> <td colspan="5">offset</td> </tr> </table>	SL	01	011101	Rd≠0	RRs	1	segment	0000 0000		offset					18							
SL	01	011101	Rd≠0	RRs																						
	1	segment	0000 0000																							
offset																										
BA:	LD Rd ¹ (#disp), Rs LDB Rd ¹ (#disp), Rbs	<table border="1"> <tr> <td>00</td> <td>11001</td> <td>W</td> <td>Rd≠0</td> <td>Rs</td> </tr> <tr> <td colspan="5">displacement</td> </tr> </table>	00	11001	W	Rd≠0	Rs	displacement					14	<table border="1"> <tr> <td>00</td> <td>11001</td> <td>W</td> <td>Rd≠0</td> <td>Rs</td> </tr> <tr> <td colspan="5">displacement</td> </tr> </table>	00	11001	W	Rd≠0	Rs	displacement					14	
		00	11001	W	Rd≠0	Rs																				
displacement																										
00	11001	W	Rd≠0	Rs																						
displacement																										
		<table border="1"> <tr> <td>00</td> <td>110111</td> <td>Rd≠0</td> <td>RRs</td> </tr> <tr> <td colspan="4">displacement</td> </tr> </table>	00	110111	Rd≠0	RRs	displacement				17	<table border="1"> <tr> <td>00</td> <td>110111</td> <td>Rd≠0</td> <td>RRs</td> </tr> <tr> <td colspan="4">displacement</td> </tr> </table>	00	110111	Rd≠0	RRs	displacement				17					
00	110111	Rd≠0	RRs																							
displacement																										
00	110111	Rd≠0	RRs																							
displacement																										
BX:	LD Rd ¹ (Rx), Rs LDB Rd ¹ (Rx), Rbs	<table border="1"> <tr> <td>01</td> <td>11001</td> <td>W</td> <td>Rd≠0</td> <td>Rs</td> </tr> <tr> <td>0000</td> <td>Rx</td> <td colspan="3">0000 0000</td> </tr> </table>	01	11001	W	Rd≠0	Rs	0000	Rx	0000 0000			14	<table border="1"> <tr> <td>01</td> <td>11001</td> <td>W</td> <td>Rd≠0</td> <td>Rs</td> </tr> <tr> <td>0000</td> <td>Rx</td> <td colspan="3">0000 0000</td> </tr> </table>	01	11001	W	Rd≠0	Rs	0000	Rx	0000 0000			14	
		01	11001	W	Rd≠0	Rs																				
0000	Rx	0000 0000																								
01	11001	W	Rd≠0	Rs																						
0000	Rx	0000 0000																								
		<table border="1"> <tr> <td>01</td> <td>110111</td> <td>Rd≠0</td> <td>RRs</td> </tr> <tr> <td>0000</td> <td>Rx</td> <td colspan="2">0000 0000</td> </tr> </table>	01	110111	Rd≠0	RRs	0000	Rx	0000 0000		17	<table border="1"> <tr> <td>01</td> <td>110111</td> <td>Rd≠0</td> <td>RRs</td> </tr> <tr> <td>0000</td> <td>Rx</td> <td colspan="2">0000 0000</td> </tr> </table>	01	110111	Rd≠0	RRs	0000	Rx	0000 0000		17					
01	110111	Rd≠0	RRs																							
0000	Rx	0000 0000																								
01	110111	Rd≠0	RRs																							
0000	Rx	0000 0000																								

Note 1: Word register in nonsegmented mode, register pair in segmented mode.

Load Immediate Value

Destination Addressing Mode	Assembler Language Syntax	Nonsegmented Mode		Segmented Mode																									
		Instruction Format	Cycles	Instruction Format	Cycles																								
R:	LD Rd, #data	<table border="1"> <tr> <td>00</td> <td>100001</td> <td>0000</td> <td>Rd</td> </tr> <tr> <td colspan="4">data</td> </tr> </table>	00	100001	0000	Rd	data				7	<table border="1"> <tr> <td>00</td> <td>100001</td> <td>0000</td> <td>Rd</td> </tr> <tr> <td colspan="4">data</td> </tr> </table>	00	100001	0000	Rd	data				7								
	00	100001	0000	Rd																									
	data																												
00	100001	0000	Rd																										
data																													
LDB Rbd, #data ²	<table border="1"> <tr> <td>00</td> <td>100000</td> <td>0000</td> <td>Rd</td> </tr> <tr> <td colspan="2">data</td> <td colspan="2">data</td> </tr> </table>	00	100000	0000	Rd	data		data		7	<table border="1"> <tr> <td>00</td> <td>100000</td> <td>0000</td> <td>Rd</td> </tr> <tr> <td colspan="2">data</td> <td colspan="2">data</td> </tr> </table>	00	100000	0000	Rd	data		data		7									
00	100000	0000	Rd																										
data		data																											
00	100000	0000	Rd																										
data		data																											
LDL RRd, #data	<table border="1"> <tr> <td>1100</td> <td>Rd</td> <td colspan="2">data</td> </tr> </table>	1100	Rd	data		5	<table border="1"> <tr> <td>1100</td> <td>Rd</td> <td colspan="2">data</td> </tr> </table>	1100	Rd	data		5																	
1100	Rd	data																											
1100	Rd	data																											
IR:	LD @Rd, #data	<table border="1"> <tr> <td>00</td> <td>001101</td> <td>Rd</td> <td>0101</td> </tr> <tr> <td colspan="4">data</td> </tr> </table>	00	001101	Rd	0101	data				11	<table border="1"> <tr> <td>00</td> <td>001101</td> <td>Rd</td> <td>0101</td> </tr> <tr> <td colspan="4">data</td> </tr> </table>	00	001101	Rd	0101	data				11								
	00	001101	Rd	0101																									
	data																												
00	001101	Rd	0101																										
data																													
LD @Rbd, #data	<table border="1"> <tr> <td>00</td> <td>001100</td> <td>Rd</td> <td>0101</td> </tr> <tr> <td colspan="2">data</td> <td colspan="2">data</td> </tr> </table>	00	001100	Rd	0101	data		data		11	<table border="1"> <tr> <td>00</td> <td>001100</td> <td>Rd</td> <td>0101</td> </tr> <tr> <td colspan="2">data</td> <td colspan="2">data</td> </tr> </table>	00	001100	Rd	0101	data		data		11									
00	001100	Rd	0101																										
data		data																											
00	001100	Rd	0101																										
data		data																											
DA:	LD address, #data	<table border="1"> <tr> <td>01</td> <td>001101</td> <td>0000</td> <td>0101</td> </tr> <tr> <td colspan="4">address</td> </tr> <tr> <td colspan="4">data</td> </tr> </table>	01	001101	0000	0101	address				data				14	<table border="1"> <tr> <td>01</td> <td>001101</td> <td>0000</td> <td>0101</td> </tr> <tr> <td>SS</td> <td>0</td> <td>segment</td> <td>offset</td> </tr> <tr> <td colspan="4">data</td> </tr> </table>	01	001101	0000	0101	SS	0	segment	offset	data				15
		01	001101	0000	0101																								
	address																												
	data																												
01	001101	0000	0101																										
SS	0	segment	offset																										
data																													
<table border="1"> <tr> <td>01</td> <td>001101</td> <td>0000</td> <td>0101</td> </tr> <tr> <td>SL</td> <td>1</td> <td>segment</td> <td>0000 0000</td> </tr> <tr> <td colspan="4">offset</td> </tr> <tr> <td colspan="4">data</td> </tr> </table>	01	001101	0000	0101	SL	1	segment	0000 0000	offset				data				17												
01	001101	0000	0101																										
SL	1	segment	0000 0000																										
offset																													
data																													
LDB address, #data	<table border="1"> <tr> <td>01</td> <td>001100</td> <td>0000</td> <td>0101</td> </tr> <tr> <td colspan="4">address</td> </tr> <tr> <td colspan="2">data</td> <td colspan="2">data</td> </tr> </table>	01	001100	0000	0101	address				data		data		14	<table border="1"> <tr> <td>01</td> <td>001100</td> <td>0000</td> <td>0101</td> </tr> <tr> <td>SS</td> <td>0</td> <td>segment</td> <td>offset</td> </tr> <tr> <td colspan="2">data</td> <td colspan="2">data</td> </tr> </table>	01	001100	0000	0101	SS	0	segment	offset	data		data		15	
	01	001100	0000	0101																									
address																													
data		data																											
01	001100	0000	0101																										
SS	0	segment	offset																										
data		data																											
<table border="1"> <tr> <td>01</td> <td>001100</td> <td>0000</td> <td>0101</td> </tr> <tr> <td>SL</td> <td>1</td> <td>segment</td> <td>0000 0000</td> </tr> <tr> <td colspan="4">offset</td> </tr> <tr> <td colspan="2">data</td> <td colspan="2">data</td> </tr> </table>	01	001100	0000	0101	SL	1	segment	0000 0000	offset				data		data		17												
01	001100	0000	0101																										
SL	1	segment	0000 0000																										
offset																													
data		data																											

Note 2: Although two formats exist for "LDB R, IM", the assembler always uses the short format. In this case, the "src field" in the instruction format encoding contains the source operand.

Load Immediate Value (Continued)

Destination Addressing Mode	Assembler Language Syntax	Nonsegmented Mode		Segmented Mode																									
		Instruction Format	Cycles	Instruction Format	Cycles																								
X:	LD addr(Rd), #data	<table border="1"> <tr> <td>01</td> <td>001101</td> <td>Rd≠0</td> <td>0101</td> </tr> <tr> <td colspan="4">address</td> </tr> <tr> <td colspan="4">data</td> </tr> </table>	01	001101	Rd≠0	0101	address				data				15	<table border="1"> <tr> <td>01</td> <td>001101</td> <td>Rd≠0</td> <td>0101</td> </tr> <tr> <td>SS</td> <td>0</td> <td>segment</td> <td>offset</td> </tr> <tr> <td colspan="4">data</td> </tr> </table>	01	001101	Rd≠0	0101	SS	0	segment	offset	data				15
		01	001101	Rd≠0	0101																								
	address																												
	data																												
01	001101	Rd≠0	0101																										
SS	0	segment	offset																										
data																													
<table border="1"> <tr> <td>01</td> <td>001101</td> <td>Rd≠0</td> <td>0101</td> </tr> <tr> <td>SL</td> <td>1</td> <td>segment</td> <td>0000 0000</td> </tr> <tr> <td colspan="4">offset</td> </tr> <tr> <td colspan="4">data</td> </tr> </table>	01	001101	Rd≠0	0101	SL	1	segment	0000 0000	offset				data				18												
01	001101	Rd≠0	0101																										
SL	1	segment	0000 0000																										
offset																													
data																													
LDB addr(Rd), #data	<table border="1"> <tr> <td>01</td> <td>001100</td> <td>Rd≠0</td> <td>0101</td> </tr> <tr> <td colspan="4">address</td> </tr> <tr> <td colspan="2">data</td> <td colspan="2">data</td> </tr> </table>	01	001100	Rd≠0	0101	address				data		data		15	<table border="1"> <tr> <td>01</td> <td>001100</td> <td>Rd≠0</td> <td>0101</td> </tr> <tr> <td>SS</td> <td>0</td> <td>segment</td> <td>offset</td> </tr> <tr> <td colspan="2">data</td> <td colspan="2">data</td> </tr> </table>	01	001100	Rd≠0	0101	SS	0	segment	offset	data		data		15	
		01	001100	Rd≠0	0101																								
address																													
data		data																											
01	001100	Rd≠0	0101																										
SS	0	segment	offset																										
data		data																											
<table border="1"> <tr> <td>01</td> <td>001100</td> <td>Rd≠0</td> <td>0101</td> </tr> <tr> <td>SL</td> <td>1</td> <td>segment</td> <td>0000 0000</td> </tr> <tr> <td colspan="4">offset</td> </tr> <tr> <td colspan="2">data</td> <td colspan="2">data</td> </tr> </table>	01	001100	Rd≠0	0101	SL	1	segment	0000 0000	offset				data		data		18												
01	001100	Rd≠0	0101																										
SL	1	segment	0000 0000																										
offset																													
data		data																											

Example: Several examples of the use of the Load instruction are treated in detail in Chapter 4 under addressing modes.

Examples:

LDA R4,STRUCT

!in nonsegmented mode, register R4 is loaded!
!with the nonsegmented address of the location!
!named STRUCT!

LDA RR2, <<3>> 8(R4)

!in segmented mode, if index register R4!
!contains %20, then register RR2 is loaded!
!with the segmented address (<<3>>, offset %28)!

LDA RR2,RR4(#8)

!in segmented mode, if base register RR4!
!contains %01000020, then register RR2 is loaded!
!with the segment address << 1 >> %28!
!(segment 1, offset %28)!

Note 1: Word register in nonsegmented mode, register pair in segmented mode.

LDCTL

Load Control

Privileged Instruction

LDCTL dst, src

dst: CTLR
 src: R
 or
 dst: R
 src: CTLR

Operation: dst ← src

This instruction loads the contents of a general purpose register into a control register, or loads the contents of a control register into a general-purpose register. The control register may be one of the following CPU registers:

FCW	Flag and Control Word
REFRESH	Refresh Control
PSAPSEG	Program Status Area Pointer - segment number
PSAPOFF	Program Status Area Pointer - offset
NSPSEG	Normal Stack Pointer - segment number
NSPOFF	Normal Stack Pointer - offset

The operation of each of the variants of the instruction is detailed below. The ones which load data into a control register are described first, followed by the variants which load data from a control register into a general purpose register.

Load Into Control Register

LDCTL FCW, Rs

Operation: FCW (2:7) ← Rs (2:7)
 FCW (11:15) ← Rs (11:15)

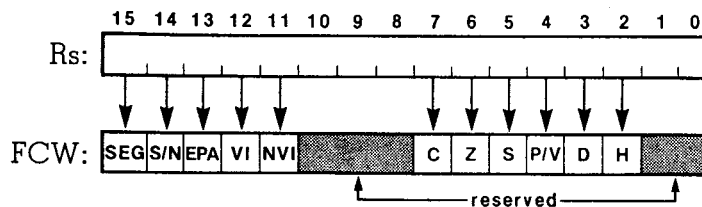

LDCTL REFRESH, Rs

Operation: REFRESH (1:15) ← Rs (1:15)

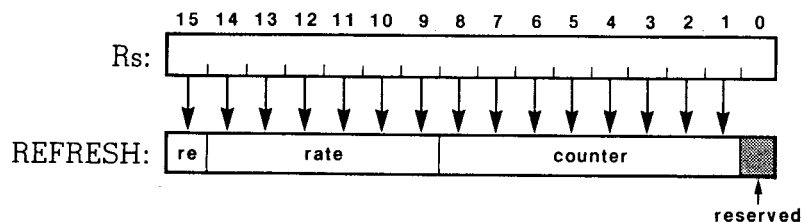

LDCTL NSPSEG, Rs

Operation: NSPSEG (0:15) ← Rs (0:15)

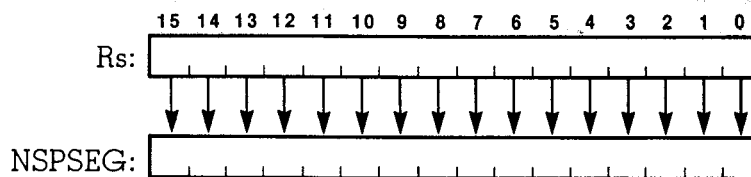

In segmented mode, the NSPSEG register is R14 and contains the segment number of the normal mode processor stack pointer which is otherwise inaccessible for system mode.

In nonsegmented mode, R14 is not used as part of the normal processor stack pointer. This instruction may not be used in nonsegmented mode.

LDCTL NSPOFF, Rs
NSP, Rs

Operation: NSPOFF (0:15) ← Rs (0:15)

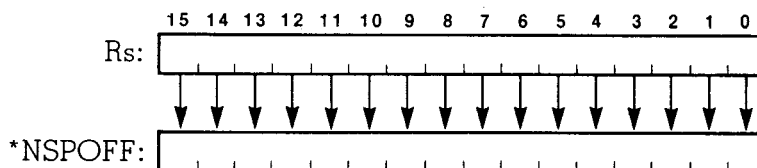

***NSP in nonsegmented mode**

In segmented mode, the NSPOFF register is R15 in normal mode and contains the offset part of the normal processor stack pointer. In nonsegmented mode, R15 is the entire normal processor stack pointer.

In nonsegmented Z8002, the mnemonic "NSP" should be used in the assembly language statement, and indicates the same control register as the mnemonic "NSPOFF".

LDCTL PSAPSEG, Rs

Operation: PSAPSEG (8:14) ← Rs (8:14)

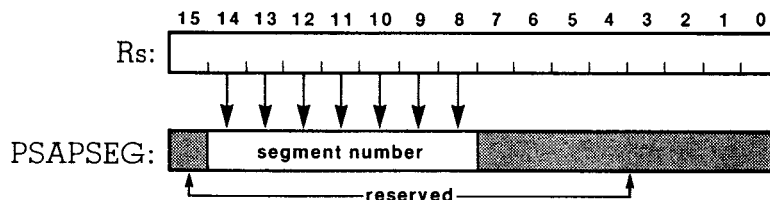

The PSAPSEG register may not be used in the nonsegmented Z8002. In the segmented Z8001, care must be exercised when changing the two PSAP register values so that an interrupt occurring between the changing of PSAPSEG and PSAPOFF is handled correctly. This is typically accomplished by first disabling interrupts before changing PSAPSEG and PSAPOFF.

LDCTL PSAPOFF, Rs
PSAP, Rs

Operation: PSAPOFF (8:15) ← Rs (8:15)

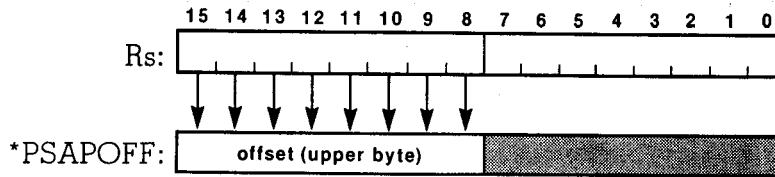

***PSAP in nonsegmented mode**

In the nonsegmented Z8002, the mnemonic "PSAP" should be used in the assembly language statement and indicates the same control register as the mnemonic "PSAPOFF". In the segmented Z8001, care must be exercised when changing the two PSAP register values so that an interrupt occurring between the changing of PSAPSEG and PSAPOFF is handled correctly. This is typically accomplished by first disabling interrupts before changing PSAPSEG and PSAPOFF.

Load From Control Register

LDCTL Rd, FCW

Operation:
 Rd (2:7) ← FCW (2:7)
 Rd (11:15) ← FCW (11:15)
 (Z8001 only)
 Rd (11:14) ← FCW (11:14)
 (Z8002 only)
 Rd (0:1) ← 0
 Rd (8:10) ← 0
 Rd (15) ← 0
 (Z8002 only)

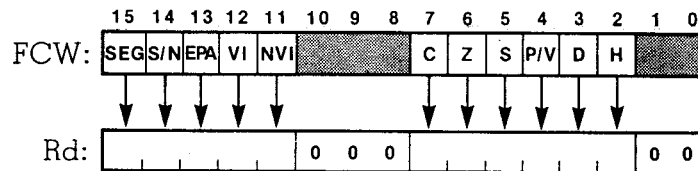

LDCTL Rd, REFRESH

Operation:
 Rd (1:8) ← REFRESH (1:8)
 Rd (0) ← 0
 Rd (9:15) ← UNDEFINED

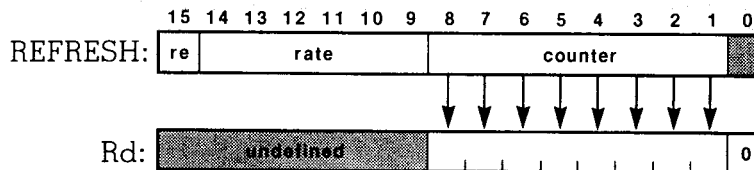

LDCTL Rd, PSAPSEG

Operation: Rd (8:14) ← PSAPSEG (8:14)
Rd (0:7) ← 0
Rd (15) ← 0

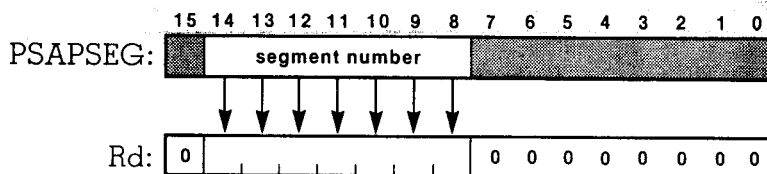

This instruction may not be used in the nonsegmented version.

LDCTL Rd, PSAPOFF
Rd, PSAP

Operation: Rd (8:15) ← PSAPOFF (8:15)
Rd (0:7) ← 0

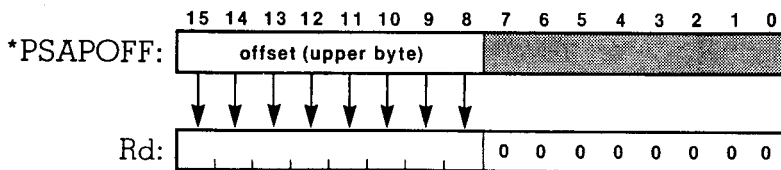

***PSAP in nonsegmented mode**

In nonsegmented mode, the mnemonic PSAP should be used in the assembly language statement, and it indicates the same control register as the mnemonic PSAPOFF.

LDCTL Rd, NSPSEG

Operation: Rd (0:15) ← NSPSEG (0:15)

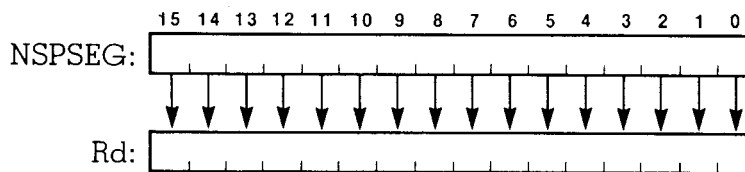

This instruction is not available in nonsegmented mode.

LDCTL Rd, NSPOFF
Rd, NSP

Operation: Rd (0:15) ← NSPOFF (0:15)

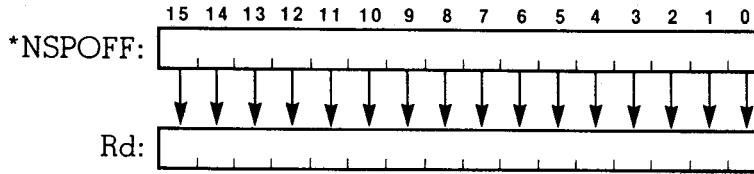

***NSP in nonsegmented mode**

In nonsegmented mode, the mnemonic NSP should be used in the assembly language statement, and it indicates the same control register as the mnemonic NSPOFF.

Flags: No flags affected, except when the destination is the Flag and Control Word (LDCTL FCW, Rs), in which case all the flags are loaded from the source register.

Source Addressing Mode	Assembler Language Syntax	Nonsegmented Mode		Segmented Mode							
		Instruction Format	Cycles	Instruction Format	Cycles						
	LDCTL FCW, Rs	<table border="1"><tr><td>01111101</td><td>Rs</td><td>1010</td></tr></table>	01111101	Rs	1010	7	<table border="1"><tr><td>01111101</td><td>Rs</td><td>1010</td></tr></table>	01111101	Rs	1010	7
01111101	Rs	1010									
01111101	Rs	1010									
	LDCTL REFRESH, Rs	<table border="1"><tr><td>01111101</td><td>Rs</td><td>1011</td></tr></table>	01111101	Rs	1011	7	<table border="1"><tr><td>01111101</td><td>Rs</td><td>1011</td></tr></table>	01111101	Rs	1011	7
01111101	Rs	1011									
01111101	Rs	1011									
	LDCTL PSAPSEG, Rs	<table border="1"><tr><td>01111101</td><td>Rs</td><td>1100</td></tr></table>	01111101	Rs	1100	7	<table border="1"><tr><td>01111101</td><td>Rs</td><td>1100</td></tr></table>	01111101	Rs	1100	7
01111101	Rs	1100									
01111101	Rs	1100									
	LDCTL PSAPOFF, Rs PSAP, Rs	<table border="1"><tr><td>01111101</td><td>Rs</td><td>1101</td></tr></table>	01111101	Rs	1101	7	<table border="1"><tr><td>01111101</td><td>Rs</td><td>1101</td></tr></table>	01111101	Rs	1101	7
01111101	Rs	1101									
01111101	Rs	1101									
	LDCTL NSPSEG, Rs	<table border="1"><tr><td>01111101</td><td>Rs</td><td>1110</td></tr></table>	01111101	Rs	1110	7	<table border="1"><tr><td>01111101</td><td>Rs</td><td>1110</td></tr></table>	01111101	Rs	1110	7
01111101	Rs	1110									
01111101	Rs	1110									
	LDCTL NSPOFF, Rs NSP, Rs	<table border="1"><tr><td>01111101</td><td>Rs</td><td>1111</td></tr></table>	01111101	Rs	1111	7	<table border="1"><tr><td>01111101</td><td>Rs</td><td>1111</td></tr></table>	01111101	Rs	1111	7
01111101	Rs	1111									
01111101	Rs	1111									
Destination Addressing Mode	Assembler Language Syntax	Nonsegmented Mode		Segmented Mode							
		Instruction Format	Cycles	Instruction Format	Cycles						
	LDCTL Rd, FCW	<table border="1"><tr><td>01111101</td><td>Rd</td><td>0010</td></tr></table>	01111101	Rd	0010	7	<table border="1"><tr><td>01111101</td><td>Rd</td><td>0010</td></tr></table>	01111101	Rd	0010	7
01111101	Rd	0010									
01111101	Rd	0010									
	LDCTL Rd, REFRESH	<table border="1"><tr><td>01111101</td><td>Rd</td><td>0011</td></tr></table>	01111101	Rd	0011	7	<table border="1"><tr><td>01111101</td><td>Rd</td><td>0011</td></tr></table>	01111101	Rd	0011	7
01111101	Rd	0011									
01111101	Rd	0011									
	LDCTL Rd, PSAPSEG	<table border="1"><tr><td>01111101</td><td>Rd</td><td>0100</td></tr></table>	01111101	Rd	0100	7	<table border="1"><tr><td>01111101</td><td>Rd</td><td>0100</td></tr></table>	01111101	Rd	0100	7
01111101	Rd	0100									
01111101	Rd	0100									
	LDCTL Rd, PSAPOFF	<table border="1"><tr><td>01111101</td><td>Rd</td><td>0101</td></tr></table>	01111101	Rd	0101	7	<table border="1"><tr><td>01111101</td><td>Rd</td><td>0101</td></tr></table>	01111101	Rd	0101	7
01111101	Rd	0101									
01111101	Rd	0101									
	LDCTL Rd, NSPSEG	<table border="1"><tr><td>01111101</td><td>Rd</td><td>0110</td></tr></table>	01111101	Rd	0110	7	<table border="1"><tr><td>01111101</td><td>Rd</td><td>0110</td></tr></table>	01111101	Rd	0110	7
01111101	Rd	0110									
01111101	Rd	0110									
	LDCTL Rd, NSPOFF Rd, NSP	<table border="1"><tr><td>01111101</td><td>Rd</td><td>0111</td></tr></table>	01111101	Rd	0111	7	<table border="1"><tr><td>01111101</td><td>Rd</td><td>0111</td></tr></table>	01111101	Rd	0111	7
01111101	Rd	0111									
01111101	Rd	0111									

LDCTLB

Load Control Byte

LDCTLB dst, src

dst: FLAGS
 src: R
 or
 dst: R
 src: FLAGS

Operation: dst ← src

This instruction is used to load the FLAGS register or to transfer its contents into a general-purpose register. Note that this is not a privileged instruction.

Load Into FLAGS Register

LDCTLB FLAGS, Rbs)

FLAGS (2:7) ← src (2:7)

The contents of the source (a byte register) are loaded into the FLAGS register. The lower two bits of the FLAGS register and the entire source register are unaffected.

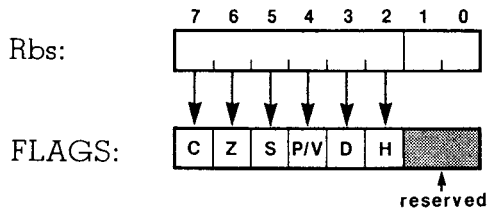

Load From FLAGS Register

(LDCTLB Rbd, FLAGS)

dst (2:7) ← FLAGS (2:7)
 dst (0:1) ← 0

The contents of the upper six bits of the FLAGS register are loaded into the destination (a byte register). The lower two bits of the destination register are cleared to zero. The FLAGS register is unaffected.

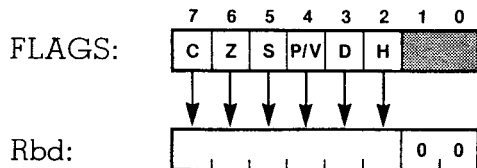

Flags: When the FLAGS register is the destination, all the flags are loaded from the source. When the FLAGS register is the source, none of the flags are affected.

	Assembler Language Syntax	Nonsegmented Mode		Segmented Mode	
		Instruction Format	Cycles	Instruction Format	Cycles
	LDCTLB FLAGS, Rbs	10001100 Rs 1001	7	10001100 Rs 1001	7
	LDCTLB Rbd, FLAGS	10001100 Rd 0001	7	10001100 Rd 0001	7

LDDR

Load, Decrement and Repeat

LDDR dst, src, r dst: IR
 LDDRB src: IR

Operation:

dst ← src
 AUTODECREMENT dst and src (by 1 if byte, by 2 if word)
 r ← r - 1
 repeat until r = 0

This instruction is used for block transfers of strings of data. The contents of the location addressed by the source register are loaded into the location addressed by the destination register. The source and destination registers are then decremented by one if LDDRB, or by two if LDDR, thus moving the pointers to the previous elements in the strings. The word register specified by "r" (used as a counter) is then decremented by one. The entire operation is repeated until the result of decrementing r is zero. This instruction can transfer from 1 to 65536 bytes or from 1 to 32768 words (the value for r must not be greater than 32768 for LDDR).

The effect of decrementing the pointers during the transfer is important if the source and destination strings overlap with the source string starting at a lower memory address. Placing the pointers at the highest address of the strings and decrementing the pointers ensures that the source string will be copied without destroying the overlapping area.

This instruction can be interrupted after each execution of the basic operation. The program counter value of the start of this instruction is saved before the interrupt request is accepted, so that the instruction can be properly resumed. Seven cycles should be added to this instruction's execution time for each interrupt request that is accepted.

Flags:
C: Unaffected
Z: Undefined
S: Unaffected
V: Set
D: Unaffected
H: Unaffected

Addressing Mode	Assembler Language Syntax	Nonsegmented Mode		Segmented Mode																	
		Instruction Format	Cycles ²	Instruction Format	Cycles ²																
IR:	LDDR @Rd ¹ , @Rs ¹ , r LDDRB @Rd ¹ , @Rs ¹ , r	<table border="1"> <tr> <td>1011101</td> <td>W</td> <td>Rs</td> <td>1001</td> </tr> <tr> <td>0000</td> <td>r</td> <td>Rd</td> <td>0000</td> </tr> </table>	1011101	W	Rs	1001	0000	r	Rd	0000	11 + 9n	<table border="1"> <tr> <td>1011101</td> <td>W</td> <td>Rs</td> <td>1001</td> </tr> <tr> <td>0000</td> <td>r</td> <td>Rd</td> <td>0000</td> </tr> </table>	1011101	W	Rs	1001	0000	r	Rd	0000	11 + 9n
1011101	W	Rs	1001																		
0000	r	Rd	0000																		
1011101	W	Rs	1001																		
0000	r	Rd	0000																		

Example:

In nonsegmented mode, if register R1 contains %202A, register R2 contains %404A, the words at locations %4040 through %404A all contain %FFFF, and register R3 contains 6, the instruction

```
LDDR @R1, @R2, R3
```

will leave the value %FFFF in the words at locations %2020 through %202A, the value %201E in R1, the value %403E in R2, and 0 in R3. The V flag will be set. In segmented mode, register pairs would be used instead of R1 and R2.

Note 1: Word register in nonsegmented mode, register pair in segmented mode.

Note 2: n = number of data elements transferred.

LDI

Load and Increment

LDI dst, src, r dst: IR
LDIB src: IR

Operation: dst ← src
 AUTOINCREMENT dst and src (by 1 if byte, by 2 if word)
 r ← r - 1

This instruction is used for block transfers of strings of data. The contents of the location addressed by the source register are loaded into the location addressed by the destination register. The source and destination registers are then incremented by one if LDIB, or by two if LDI, thus moving the pointers to the next elements in the strings. The word register specified by "r" (used as a counter) is then decremented by one.

Flags: **C:** Unaffected
 Z: Undefined
 S: Unaffected
 V: Set if the result of decrementing r is zero, cleared otherwise
 D: Unaffected
 H: Unaffected

Addressing Mode	Assembler Language Syntax	Nonsegmented Mode		Segmented Mode																	
		Instruction Format	Cycles	Instruction Format	Cycles																
IR:	LDI @Rd1, @Rs1, r LDIB @Rd1, @Rs1, r	<table border="1"> <tr> <td>1011101</td> <td>W</td> <td>Rs</td> <td>0001</td> </tr> <tr> <td>0000</td> <td>r</td> <td>Rd</td> <td>1000</td> </tr> </table>	1011101	W	Rs	0001	0000	r	Rd	1000	20	<table border="1"> <tr> <td>1011101</td> <td>W</td> <td>Rs</td> <td>0001</td> </tr> <tr> <td>0000</td> <td>r</td> <td>Rd</td> <td>1000</td> </tr> </table>	1011101	W	Rs	0001	0000	r	Rd	1000	20
1011101	W	Rs	0001																		
0000	r	Rd	1000																		
1011101	W	Rs	0001																		
0000	r	Rd	1000																		

Example: This instruction can be used in a "loop" of instructions which transfers a string of data from one location to another, but an intermediate operation on each data element is required. The following sequence transfers a string of 80 bytes, but tests for a special value (%0D, an ASCII return character) which terminates the loop if found. This example assumes nonsegmented mode. In segmented mode, register pairs would be used instead of R1 and R2.

```

LD          R3, #80          !initialize counter!
LDA        R1, DSTBUF       !load start addresses!
LDA        R2, SRCBUF

LOOP:
CPB        @R2, #%0D        !check for return character!
JR         EQ, DONE         !exit loop if found!
LDIB      @R1, @R2, R3      !transfer next byte!
JR         NOV, LOOP        !repeat until counter = 0!

DONE:

```

Note 1: Word register in nonsegmented mode, register pair in segmented mode.

Load, Increment and Repeat

LDIR dst, src, r
LDIRB

dst: IR
 src: IR

Operation:

dst ← src
 AUTOINCREMENT dst and src (by 1 if byte; by two if word)
 r ← r - 1
 repeat until R = 0

This instruction is used for block transfers of strings of data. The contents of the location addressed by the source register are loaded into the location addressed by the destination register. The source and destination registers are then incremented by one if LDIRB, or by two if LDIR, thus moving the pointers to the next elements in the strings. The word register specified by "r" (used as a counter) is then decremented by one. The entire operation is repeated until the result of decrementing r is zero. This instruction can transfer from 1 to 65536 bytes or from 1 to 32768 words (the value for r must not be greater than 32768 for LDIR).

The effect of incrementing the pointers during the transfer is important if the source and destination strings overlap with the source string starting at a higher memory address. Placing the pointers at the lowest address of the strings and incrementing the pointers ensures that the source string will be copied without destroying the overlapping area.

This instruction can be interrupted after each execution of the basic operation. The program counter value of the start of this instruction is saved before the interrupt request is accepted, so that the instruction can be properly resumed. Seven cycles should be added to this instruction's execution time for each interrupt request that is accepted.

Flags:
C: Unaffected
Z: Undefined
S: Unaffected
V: Set
D: Unaffected
H: Unaffected

Addressing Mode	Assembler Language Syntax	Nonsegmented Mode		Segmented Mode																	
		Instruction Format	Cycles ²	Instruction Format	Cycles ²																
IR:	LDIR @Rd!, @Rs!, r LDIRB @Rd!, @Rs!, r	<table border="1"> <tr> <td>1011101</td> <td>W</td> <td>Rs</td> <td>0001</td> </tr> <tr> <td>0000</td> <td>r</td> <td>Rd</td> <td>0000</td> </tr> </table>	1011101	W	Rs	0001	0000	r	Rd	0000	11 + 9n	<table border="1"> <tr> <td>1011101</td> <td>W</td> <td>Rs</td> <td>0001</td> </tr> <tr> <td>0000</td> <td>r</td> <td>Rd</td> <td>0000</td> </tr> </table>	1011101	W	Rs	0001	0000	r	Rd	0000	11 + 9n
1011101	W	Rs	0001																		
0000	r	Rd	0000																		
1011101	W	Rs	0001																		
0000	r	Rd	0000																		

Example:

The following sequence of instructions can be used in nonsegmented mode to copy a buffer of 512 words (1024 bytes) from one area to another. The pointers to the start of the source and destination are set, the number of words to transfer is set, and then the transfer takes place.

```
LDA R1, DSTBUF  
LDA R2, SRCBUF  
LD R3, #512  
LDIR @R1, @R2, R3
```

In segmented mode, R1 and R2 must be replaced by register pairs.

Note 1: Word register in nonsegmented mode, register pair in segmented mode.

Note 2: n = number of data elements transferred.

LDM

Load Multiple

LDM dst, src, n

dst: R
 src: IR, DA, X
 or
 dst: IR, DA, X
 src: R

Operation: dst ← src(n words)

The contents of n source words are loaded into the destination. The contents of the source are not affected. The value of n lies between 1 and 16, inclusive. This instruction moves information between memory and registers; registers are accessed in increasing order starting with the specified register; R0 follows R15. The instruction can be used either to load multiple registers into memory (e.g. to save the contents of registers upon subroutine entry) or to load multiple registers from memory (e.g. to restore the contents of registers upon subroutine exit).

The instruction encoding contains values from 0 to 15 in the "num" field corresponding to values of 1 to 16 for n, the number of registers to be loaded or saved.

The starting address is computed once at the start of execution, and incremented by two for each register loaded. If the original address computation involved a register, the register's value will not be affected by the address incrementation during execution. Similarly, modifying that register during a load from memory will not affect the address used by this instruction.

Flags: No flags affected

Load Multiple - Registers From Memory

Source Addressing Mode	Assembler Language Syntax	Nonsegmented Mode		Segmented Mode																										
		Instruction Format	Cycles	Instruction Format	Cycles																									
IR:	LDM Rd, @Rs!, #n	<table border="1"> <tr> <td>00</td> <td>011100</td> <td>Rs≠0</td> <td>0001</td> </tr> <tr> <td>0000</td> <td>Rd</td> <td>0000</td> <td>num</td> </tr> </table>	00	011100	Rs≠0	0001	0000	Rd	0000	num	11 + 3n	<table border="1"> <tr> <td>00</td> <td>011100</td> <td>Rs≠0</td> <td>0001</td> </tr> <tr> <td>0000</td> <td>Rd</td> <td>0000</td> <td>num</td> </tr> </table>	00	011100	Rs≠0	0001	0000	Rd	0000	num	11 + 3n									
		00	011100	Rs≠0	0001																									
0000	Rd	0000	num																											
00	011100	Rs≠0	0001																											
0000	Rd	0000	num																											
DA:	LDM Rd, address, #n	<table border="1"> <tr> <td>01</td> <td>011100</td> <td>0000</td> <td>0001</td> </tr> <tr> <td>0000</td> <td>Rd</td> <td>0000</td> <td>num</td> </tr> <tr> <td colspan="4">address</td> </tr> </table>	01	011100	0000	0001	0000	Rd	0000	num	address				14 + 3n	SS	<table border="1"> <tr> <td>01</td> <td>011100</td> <td>0000</td> <td>0001</td> </tr> <tr> <td>0000</td> <td>Rd</td> <td>0000</td> <td>num</td> </tr> <tr> <td>0</td> <td>segment</td> <td colspan="2">offset</td> </tr> </table>	01	011100	0000	0001	0000	Rd	0000	num	0	segment	offset		15 + 3n
		01	011100	0000	0001																									
		0000	Rd	0000	num																									
address																														
01	011100	0000	0001																											
0000	Rd	0000	num																											
0	segment	offset																												
SL	<table border="1"> <tr> <td>01</td> <td>011100</td> <td>0000</td> <td>0001</td> </tr> <tr> <td>0000</td> <td>Rd</td> <td>0000</td> <td>num</td> </tr> <tr> <td>1</td> <td>segment</td> <td>0000</td> <td>0000</td> </tr> <tr> <td colspan="4">offset</td> </tr> </table>	01	011100	0000	0001	0000	Rd	0000	num	1	segment	0000	0000	offset				17 + 3n												
01	011100	0000	0001																											
0000	Rd	0000	num																											
1	segment	0000	0000																											
offset																														

Load Multiple - Registers From Memory (Continued)

Source Addressing Mode	Assembler Language Syntax	Nonsegmented Mode		Segmented Mode																									
		Instruction Format	Cycles	Instruction Format	Cycles																								
X:	LDM Rd, addr(Rs), #n	<table border="1"> <tr> <td>01</td> <td>011100</td> <td>Rs≠0</td> <td>0001</td> </tr> <tr> <td>0000</td> <td>Rd</td> <td>0000</td> <td>num</td> </tr> <tr> <td colspan="4">address</td> </tr> </table>	01	011100	Rs≠0	0001	0000	Rd	0000	num	address				15 + 3n	<table border="1"> <tr> <td>01</td> <td>011100</td> <td>Rs≠0</td> <td>0001</td> </tr> <tr> <td>0000</td> <td>Rd</td> <td>0000</td> <td>num</td> </tr> <tr> <td>0</td> <td>segment</td> <td colspan="2">offset</td> </tr> </table>	01	011100	Rs≠0	0001	0000	Rd	0000	num	0	segment	offset		15 + 3n
		01	011100	Rs≠0	0001																								
0000	Rd	0000	num																										
address																													
01	011100	Rs≠0	0001																										
0000	Rd	0000	num																										
0	segment	offset																											
<table border="1"> <tr> <td>01</td> <td>011100</td> <td>Rs≠0</td> <td>0001</td> </tr> <tr> <td>0000</td> <td>Rd</td> <td>0000</td> <td>num</td> </tr> <tr> <td>1</td> <td>segment</td> <td>0000</td> <td>0000</td> </tr> <tr> <td colspan="4">offset</td> </tr> </table>	01	011100	Rs≠0	0001	0000	Rd	0000	num	1	segment	0000	0000	offset				18 + 3n												
01	011100	Rs≠0	0001																										
0000	Rd	0000	num																										
1	segment	0000	0000																										
offset																													

Load Multiple - Memory From Registers

Destination Addressing Mode	Assembler Language Syntax	Nonsegmented Mode		Segmented Mode																									
		Instruction Format	Cycles	Instruction Format	Cycles																								
IR:	LDM@Rd ¹ , Rs, #n	<table border="1"> <tr> <td>00</td> <td>011100</td> <td>Rd≠0</td> <td>1001</td> </tr> <tr> <td>0000</td> <td>Rs</td> <td>0000</td> <td>num</td> </tr> </table>	00	011100	Rd≠0	1001	0000	Rs	0000	num	11 + 3n	<table border="1"> <tr> <td>00</td> <td>011100</td> <td>Rd≠0</td> <td>1001</td> </tr> <tr> <td>0000</td> <td>Rs</td> <td>0000</td> <td>num</td> </tr> </table>	00	011100	Rd≠0	1001	0000	Rs	0000	num	11 + 3n								
00	011100	Rd≠0	1001																										
0000	Rs	0000	num																										
00	011100	Rd≠0	1001																										
0000	Rs	0000	num																										
DA:	LDM address, Rs, #n	<table border="1"> <tr> <td>01</td> <td>011100</td> <td>0000</td> <td>1001</td> </tr> <tr> <td>0000</td> <td>Rs</td> <td>0000</td> <td>num</td> </tr> <tr> <td colspan="4">address</td> </tr> </table>	01	011100	0000	1001	0000	Rs	0000	num	address				14 + 3n	<table border="1"> <tr> <td>01</td> <td>011100</td> <td>0000</td> <td>1001</td> </tr> <tr> <td>0000</td> <td>Rs</td> <td>0000</td> <td>num</td> </tr> <tr> <td>0</td> <td>segment</td> <td colspan="2">offset</td> </tr> </table>	01	011100	0000	1001	0000	Rs	0000	num	0	segment	offset		15 + 3n
		01	011100	0000	1001																								
0000	Rs	0000	num																										
address																													
01	011100	0000	1001																										
0000	Rs	0000	num																										
0	segment	offset																											
<table border="1"> <tr> <td>01</td> <td>011100</td> <td>0000</td> <td>1001</td> </tr> <tr> <td>0000</td> <td>Rs</td> <td>0000</td> <td>num</td> </tr> <tr> <td>1</td> <td>segment</td> <td>0000</td> <td>0000</td> </tr> <tr> <td colspan="4">offset</td> </tr> </table>	01	011100	0000	1001	0000	Rs	0000	num	1	segment	0000	0000	offset				17 + 3n												
01	011100	0000	1001																										
0000	Rs	0000	num																										
1	segment	0000	0000																										
offset																													
X:	LDM addr(Rd), Rs, #n	<table border="1"> <tr> <td>01</td> <td>011100</td> <td>Rd≠0</td> <td>1001</td> </tr> <tr> <td>0000</td> <td>Rs</td> <td>0000</td> <td>num</td> </tr> <tr> <td colspan="4">address</td> </tr> </table>	01	011100	Rd≠0	1001	0000	Rs	0000	num	address				15 + 3n	<table border="1"> <tr> <td>01</td> <td>011100</td> <td>Rd≠0</td> <td>1001</td> </tr> <tr> <td>0000</td> <td>Rs</td> <td>0000</td> <td>num</td> </tr> <tr> <td>0</td> <td>segment</td> <td colspan="2">offset</td> </tr> </table>	01	011100	Rd≠0	1001	0000	Rs	0000	num	0	segment	offset		15 + 3n
		01	011100	Rd≠0	1001																								
0000	Rs	0000	num																										
address																													
01	011100	Rd≠0	1001																										
0000	Rs	0000	num																										
0	segment	offset																											
<table border="1"> <tr> <td>01</td> <td>011100</td> <td>Rd≠0</td> <td>1001</td> </tr> <tr> <td>0000</td> <td>Rs</td> <td>0000</td> <td>num</td> </tr> <tr> <td>1</td> <td>segment</td> <td>0000</td> <td>0000</td> </tr> <tr> <td colspan="4">offset</td> </tr> </table>	01	011100	Rd≠0	1001	0000	Rs	0000	num	1	segment	0000	0000	offset				18 + 3n												
01	011100	Rd≠0	1001																										
0000	Rs	0000	num																										
1	segment	0000	0000																										
offset																													

Example:

In nonsegmented mode, if register R5 contains 5, R6 contains %0100, and R7 contains 7, the statement

```
LDM @R6, R5, #3
```

will leave the values 5, %0100, and 7 at word locations %0100, %0102, and %0104, respectively, and none of the registers will be affected. In segmented mode, a register pair would be used instead of R6.

Note 1: Word register in nonsegmented mode, register pair in segmented mode.

Note 2: n = number of registers.

LDPS

Privileged Instruction

Load Program Status

LDPS src

src: IR, DA, X

Operation: PS ← src

The contents of the source operand are loaded into the Program Status (PS), loading the Flags and Control Word (FCW) and the program counter (PC). The new value of the FCW does not become effective until the next instruction, so that the status pins will not be affected by the new control bits until after the LDPS instruction execution is completed. The next instruction executed is that addressed by the new contents of the PC. The contents of the source are not affected.

This instruction is used to set the Program Status of a program and is particularly useful for setting the System/Normal mode of a program to Normal mode, or for running a nonsegmented program in the segmented Z8001 version. The PC segment number is not affected by the LDPS instruction in nonsegmented mode.

The format of the source operand (Program Status block) depends on the current Segmentation mode (not on the version of the Z8000) and is illustrated in the following figure:



(SHADED AREA IS RESERVED—MUST BE ZERO)

Flags: All flags are loaded from source registers.

Source Addressing Mode	Assembler Language Syntax	Nonsegmented Mode		Segmented Mode																					
		Instruction Format	Cycles	Instruction Format	Cycles																				
IR:	LDPS @Rs1	<table border="1"> <tr> <td>00</td> <td>111001</td> <td>Rs≠0</td> <td>0000</td> </tr> </table>	00	111001	Rs≠0	0000	12	<table border="1"> <tr> <td>00</td> <td>111001</td> <td>Rs≠0</td> <td>0000</td> </tr> </table>	00	111001	Rs≠0	0000	16												
00	111001	Rs≠0	0000																						
00	111001	Rs≠0	0000																						
DA:	LDPS address	<table border="1"> <tr> <td>01</td> <td>111001</td> <td>0000</td> <td>0000</td> </tr> <tr> <td colspan="4" style="text-align: center;">address</td> </tr> </table>	01	111001	0000	0000	address				16	<table border="1"> <tr> <td>01</td> <td>111001</td> <td>0000</td> <td>0000</td> </tr> <tr> <td>SS</td> <td>0</td> <td>segment</td> <td>offset</td> </tr> </table>	01	111001	0000	0000	SS	0	segment	offset	20				
		01	111001	0000	0000																				
address																									
01	111001	0000	0000																						
SS	0	segment	offset																						
X:	LDPS addr(Rs)	<table border="1"> <tr> <td>01</td> <td>111001</td> <td>Rs≠0</td> <td>0000</td> </tr> <tr> <td colspan="4" style="text-align: center;">address</td> </tr> </table>	01	111001	Rs≠0	0000	address				17	<table border="1"> <tr> <td>01</td> <td>111001</td> <td>0000</td> <td>0000</td> </tr> <tr> <td>SL</td> <td>1</td> <td>segment</td> <td>0000 0000</td> </tr> <tr> <td colspan="4" style="text-align: center;">offset</td> </tr> </table>	01	111001	0000	0000	SL	1	segment	0000 0000	offset				22
		01	111001	Rs≠0	0000																				
		address																							
01	111001	0000	0000																						
SL	1	segment	0000 0000																						
offset																									
<table border="1"> <tr> <td>01</td> <td>111001</td> <td>Rs≠0</td> <td>0000</td> </tr> <tr> <td>SS</td> <td>0</td> <td>segment</td> <td>offset</td> </tr> </table>	01	111001	Rs≠0	0000	SS	0	segment	offset	20	<table border="1"> <tr> <td>01</td> <td>111001</td> <td>Rs≠0</td> <td>0000</td> </tr> <tr> <td>SL</td> <td>1</td> <td>segment</td> <td>0000 0000</td> </tr> <tr> <td colspan="4" style="text-align: center;">offset</td> </tr> </table>	01	111001	Rs≠0	0000	SL	1	segment	0000 0000	offset				23		
01	111001	Rs≠0	0000																						
SS	0	segment	offset																						
01	111001	Rs≠0	0000																						
SL	1	segment	0000 0000																						
offset																									

Example:

In nonsegmented 8002 version, if the program counter contains %2550, register R3 contains %5000, location %5000 contains %1800, and location %5002 contains %A000, the instruction

LDPS @R3

will leave the value %A000 in the program counter, and the FCW value will be %1800 (indicating Normal Mode, interrupts enabled, and all flags cleared.)

LDR

Load Relative

LDR dst, src	dst: R
LDRB	src: RA
LDRL	or
	dst: RA
	src: R

Operation: dst ← src

The contents of the source operand are loaded into the destination. The contents of the source are not affected. The relative addressing mode is calculated by adding the displacement in the instruction to the updated value of the program counter (PC) to derive the operand's address. In segmented mode, the segment number of the computer address is the same as the segment number of the PC. The updated PC value is taken to be the address of the instruction byte following the LDR, LDRB, or LDRL instruction, while the displacement is a 16-bit signed value in the range -32768 to +32767.

Status pin information during the access to memory for the data operand will be Program Reference, (1100) instead of Data Memory request (1000).

The assembler automatically calculates the displacement by subtracting the PC value of the following instruction from the address given by the programmer.

This instruction must be used to modify memory locations containing program information, such as the Program Status Area, if program and data space are allocated to different segments.

Flags: No flags affected

Load Relative Register

Source Addressing Mode	Assembler Language Syntax	Nonsegmented Mode		Segmented Mode																	
		Instruction Format	Cycles	Instruction Format	Cycles																
RA:	LDR Rd, address LDRB Rbd, address	<table border="1"> <tr> <td>0011000</td> <td>W</td> <td>0000</td> <td>Rd</td> </tr> <tr> <td colspan="4">displacement</td> </tr> </table>	0011000	W	0000	Rd	displacement				14	<table border="1"> <tr> <td>0011000</td> <td>W</td> <td>0000</td> <td>Rd</td> </tr> <tr> <td colspan="4">displacement</td> </tr> </table>	0011000	W	0000	Rd	displacement				14
	0011000	W	0000	Rd																	
displacement																					
0011000	W	0000	Rd																		
displacement																					
	LDRL RRd, address	<table border="1"> <tr> <td>00110101</td> <td>0000</td> <td>Rd</td> </tr> <tr> <td colspan="3">displacement</td> </tr> </table>	00110101	0000	Rd	displacement			17	<table border="1"> <tr> <td>00110101</td> <td>0000</td> <td>Rd</td> </tr> <tr> <td colspan="3">displacement</td> </tr> </table>	00110101	0000	Rd	displacement			17				
00110101	0000	Rd																			
displacement																					
00110101	0000	Rd																			
displacement																					

Load Relative Memory

Destination Addressing Mode	Assembler Language Syntax	Nonsegmented Mode		Segmented Mode																	
		Instruction Format	Cycles	Instruction Format	Cycles																
RA:	LDR address, Rs LDRB address, Rbs	<table border="1"> <tr> <td>0011001</td> <td>W</td> <td>0000</td> <td>Rs</td> </tr> <tr> <td colspan="4">displacement</td> </tr> </table>	0011001	W	0000	Rs	displacement				14	<table border="1"> <tr> <td>0011001</td> <td>W</td> <td>0000</td> <td>Rs</td> </tr> <tr> <td colspan="4">displacement</td> </tr> </table>	0011001	W	0000	Rs	displacement				14
	0011001	W	0000	Rs																	
displacement																					
0011001	W	0000	Rs																		
displacement																					
	LDRL address, RRs	<table border="1"> <tr> <td>00110111</td> <td>0000</td> <td>Rs</td> </tr> <tr> <td colspan="3">displacement</td> </tr> </table>	00110111	0000	Rs	displacement			17	<table border="1"> <tr> <td>00110111</td> <td>0000</td> <td>Rs</td> </tr> <tr> <td colspan="3">displacement</td> </tr> </table>	00110111	0000	Rs	displacement			17				
00110111	0000	Rs																			
displacement																					
00110111	0000	Rs																			
displacement																					

Example:

LDR R2, DATA

!register R2 is loaded with the value in the!
!location named DATA!

Privileged Instruction

MBIT

Multi-Micro Bit Test

MBIT

Operation: $S \leftarrow 1$ if \overline{MI} high (inactive); 0 otherwise

This instruction is used to synchronize multiple processors' exclusive access to shared hardware resources. The multi-micro input pin (\overline{MI}) is tested, and the S flag is cleared if the pin is low (active); otherwise, the S flag is set, indicating that the pin is high (inactive).

After the MBIT instruction is executed, the S flag can be used to determine whether a requested resource is available or not. If the S flag is clear, then the resource is not available; if the S flag is set, then the resource is available for use by this CPU.

Flags:

- C:** Unaffected
- Z:** Undefined
- S:** Set if \overline{MI} is high; cleared otherwise
- V:** Unaffected
- D:** Unaffected
- H:** Unaffected

	Assembler Language Syntax	Nonsegmented Mode		Segmented Mode	
		Instruction Format	Cycles	Instruction Format	Cycles
	MBIT	0111101100001010	7	0111101100001010	7

Example: The following sequence of instructions can be used to wait for the availability of a resource.

```

    LOOP:
            MBIT          !test multi-micro input!
            JR    PL,LOOP  !repeat until resource is available!
AVAILABLE:
    
```

MREQ dst

dst: R

Operation:

```

Z ← 0
if  $\overline{MI}$  low (active) then S ← 0
                         $\overline{MO}$  forced high (inactive)
else  $\overline{MO}$  forced low (active)
    repeat dst ← dst - 1
    until dst = 0
    if  $\overline{MI}$  low (active) then S ← 1
                            else S ← 0
                                 $\overline{MO}$  forced high (inactive)

Z ← 1
    
```

This instruction is used to synchronize multiple processors' exclusive access to shared hardware resources. A request for a resource is signalled through the multi-micro input and output pins (\overline{MI} and \overline{MO}), with the S and Z flags indicating the availability of the resource after the MREQ instruction has been executed.

First, the Z flag is cleared. Then the \overline{MI} pin is tested. If the \overline{MI} pin is low (active), the S flag is cleared and the \overline{MO} pin is forced high (inactive), thus indicating that the resource is not available and removing any previous request by the CPU from the \overline{MO} line.

If the \overline{MI} pin is high (inactive), indicating that the resource may be available, a sequence of machine operations occurs. First, the \overline{MO} pin is forced low (active), signalling a request by the CPU for the resource. Next, a finite delay to allow for propagation of the signal to other processors is accomplished by repeatedly decrementing the contents of the destination (a word register) until its value is zero. Then the \overline{MI} pin is tested to determine whether the request for the resource was acknowledged. If the \overline{MI} pin is low (active), the S flag is set to one, indicating that the resource is available and access is granted. If the \overline{MI} pin is still high (inactive), the S flag is cleared to zero, and the \overline{MO} pin is forced high (inactive), indicating that the request was not granted and removing the request signal for the \overline{MO} .

Finally, in either case, the Z flag is set to one, indicating that the original test of the \overline{MI} pin caused a request to be made.

S flag	Z flag	\overline{MO}	Indicates
0	0	high	Request not signalled (resource not available)
0	1	high	Request not granted (resource not available)
1	1	low	Request granted (resource available)

Flags:

- C:** Unaffected
- Z:** Set if request was signalled; cleared otherwise
- S:** Set if request was signalled and granted; cleared otherwise
- V:** Unaffected
- D:** Unaffected
- H:** Unaffected

Destination Addressing Mode	Assembler Language Syntax	Nonsegmented Mode		Segmented Mode									
		Instruction Format	Cycles ¹	Instruction Format	Cycles ¹								
R:	MREQ Rd	<table border="1"> <tr> <td>01</td> <td>111011</td> <td>Rd</td> <td>1101</td> </tr> </table>	01	111011	Rd	1101	12+7n	<table border="1"> <tr> <td>01</td> <td>111011</td> <td>Rd</td> <td>1101</td> </tr> </table>	01	111011	Rd	1101	12+7n
01	111011	Rd	1101										
01	111011	Rd	1101										

Example:

```

TRY:
    LD    R0,#50    !allow for propagation delay!
    MREQ  R0        !multi-micro request with delay!
                    !in register R0!
    JR    MI,AVAILABLE
    JR    Z,NOT_GRANTED
NOT_AVAILABLE:  .
                .
                .
NOT_GRANTED:    .
                .
                .
                JR  TRY
AVAILABLE:      .
                .
                .
                MRES
                    !release resource!

```

Note 1: If the request is made, n = number of times the destination is decremented. If the request is not made, n = 0.

Privileged Instruction

MRES Multi-Micro Reset

MRES

Operation: \overline{MO} is forced high (inactive)

This instruction is used to synchronize multiple processors' exclusive access to shared hardware resources. The multi-micro output pin \overline{MO} is forced high (inactive). Forcing \overline{MO} high (inactive) indicates that a resource controlled by the CPU is available for use by other processors.

Flags: No flags affected.

Assembler Language Syntax	Nonsegmented Mode		Segmented Mode	
	Instruction Format	Cycles	Instruction Format	Cycles
MRES	01111011 00001001	5	01111011 00001001	5

Example: MRES !signal that resource controlled by this CPU!
!is available to other processors!

MSET

Multi-Micro Set

Privileged Instruction

MSET

Operation: \overline{MO} is forced low (active)

This instruction is used to synchronize multiple processors' exclusive access to shared hardware resources. The multi-micro output pin \overline{MO} is forced low (active). Forcing \overline{MO} low (active) is used either to indicate that a resource controlled by the CPU is not available to other processors, or to signal a request for a resource controlled by some other processor.

Flags: No flags affected.

	Assembler Language Syntax	Nonsegmented Mode		Segmented Mode	
		Instruction Format	Cycles	Instruction Format	Cycles
	MSET	01111011 00001000	5	01111011 00001000	5

Example: MSET !CPU controlled resource not available!

MULT Multiply

MULT dst, src
MULTL

dst: R
src: R, IM, IR, DA, X

Operation:

Word
dst (0:31) ← dst (0:15) × src (0:15)
Long
dst (0:63) ← dst (0:31) × src (0:15)

The low-order half of the destination operand (multiplicand) is multiplied by the source operand (multiplier) and the product is stored in the destination. The contents of the source are not affected. Both operands are treated as signed, two's complement integers. For MULT, the destination is a register pair and the source is a word value; for MULTL, the destination is a register quadruple and the source is a long word value.

For proper instruction execution, the "dst field" in the instruction format encoding must be even for MULT and must be a multiple of 4 (0, 4, 8, 12) for MULTL. If the source operand in MULTL is a register, the "src field" must be even.

The initial contents of the high-order half of the destination register do not affect the operation of this instruction and are overwritten by the result. The carry flag is set to indicate that the upper half of the destination register is required to represent the result; if the carry flag is clear, the product can be correctly represented in the same precision as the multiplicand and the upper half of the destination merely holds a sign extension.

The following table gives execution times for word and long word operands in each possible addressing mode.

src	Word			Long Word		
	NS	SS	SL	NS	SS	SL
R	70	70	70	$282 + 7 * n$	$282 + 7 * n$	$282 + 7 * n$
IM	70	70	70	$282 + 7 * n$	$282 + 7 * n$	$282 + 7 * n$
IR	70	70	70	$282 + 7 * n$	$282 + 7 * n$	$282 + 7 * n$
DA	71	72	74	$283 + 7 * n$	$284 + 7 * n$	$286 + 7 * n$
X	72	72	75	$284 + 7 * n$	$284 + 7 * n$	$287 + 7 * n$

(n = number of bits equal to one in the absolute value of the low-order 16 bits of the destination operand)

When the multiplier is zero, the execution time of Multiply is reduced to the following times:

src	Word			Long Word		
	NS	SS	SL	NS	SS	SL
R	18	18	18	30	30	30
IM	18	18	18	30	30	30
IR	18	18	18	30	30	30
DA	19	20	22	31	32	34
X	20	20	23	32	32	35

Flags:

- C:** MULT—set if product is less than -2^{15} or greater than or equal to 2^{15} ; cleared otherwise; MULTL—set if product is less than 2^{31} or greater than or equal to 2^{31} ; cleared otherwise
- Z:** Set if the result is zero; cleared otherwise
- S:** Set if the result is negative; cleared otherwise
- V:** Cleared
- D:** Unaffected
- H:** Unaffected

Source Addressing Mode	Assembler Language Syntax	Nonsegmented Mode		Segmented Mode																								
		Instruction Format	Cycles ²	Instruction Format	Cycles ²																							
R:	MULT RRd, Rs	<table border="1"><tr><td>10</td><td>011001</td><td>Rs</td><td>Rd</td></tr></table>	10	011001	Rs	Rd		<table border="1"><tr><td>10</td><td>011001</td><td>Rs</td><td>Rd</td></tr></table>	10	011001	Rs	Rd																
	10	011001	Rs	Rd																								
10	011001	Rs	Rd																									
MULTL RQd, RRs	<table border="1"><tr><td>10</td><td>011000</td><td>Rs</td><td>Rd</td></tr></table>	10	011000	Rs	Rd	<table border="1"><tr><td>10</td><td>011000</td><td>Rs</td><td>Rd</td></tr></table>		10	011000	Rs	Rd																	
10	011000	Rs	Rd																									
10	011000	Rs	Rd																									
IM:	MULT RRd, #data	<table border="1"><tr><td>00</td><td>011001</td><td>0000</td><td>Rd</td></tr><tr><td colspan="4">data</td></tr></table>	00	011001	0000	Rd		data				<table border="1"><tr><td>00</td><td>011001</td><td>0000</td><td>Rd</td></tr><tr><td colspan="4">data</td></tr></table>		00	011001	0000	Rd	data										
	00	011001	0000	Rd																								
data																												
00	011001	0000	Rd																									
data																												
MULTL RQd, #data	<table border="1"><tr><td>00</td><td>011000</td><td>0000</td><td>Rd</td></tr><tr><td>31</td><td colspan="2">data (high)</td><td>16</td></tr><tr><td>15</td><td colspan="2">data (low)</td><td>0</td></tr></table>	00	011000	0000	Rd	31		data (high)		16	15	data (low)		0	<table border="1"><tr><td>00</td><td>011000</td><td>0000</td><td>Rd</td></tr><tr><td>31</td><td colspan="2">data (high)</td><td>16</td></tr><tr><td>15</td><td colspan="2">data (low)</td><td>0</td></tr></table>	00	011000	0000	Rd	31	data (high)		16	15	data (low)		0	
00	011000	0000	Rd																									
31	data (high)		16																									
15	data (low)		0																									
00	011000	0000	Rd																									
31	data (high)		16																									
15	data (low)		0																									
IR:	MULT RRd, @Rs ¹	<table border="1"><tr><td>00</td><td>011001</td><td>Rs≠0</td><td>Rd</td></tr></table>	00	011001	Rs≠0	Rd	<table border="1"><tr><td>00</td><td>011001</td><td>Rs≠0</td><td>Rd</td></tr></table>	00	011001	Rs≠0	Rd																	
	00	011001	Rs≠0	Rd																								
00	011001	Rs≠0	Rd																									
MULTL RQd, @Rs ¹	<table border="1"><tr><td>00</td><td>011000</td><td>Rs≠0</td><td>Rd</td></tr></table>	00	011000	Rs≠0	Rd	<table border="1"><tr><td>00</td><td>011000</td><td>Rs≠0</td><td>Rd</td></tr></table>	00	011000	Rs≠0	Rd																		
00	011000	Rs≠0	Rd																									
00	011000	Rs≠0	Rd																									
DA:	MULT Rd, address	<table border="1"><tr><td>01</td><td>011001</td><td>0000</td><td>Rd</td></tr><tr><td colspan="4">address</td></tr></table>	01	011001	0000	Rd	address				SS <table border="1"><tr><td>01</td><td>011001</td><td>0000</td><td>Rd</td></tr><tr><td>0</td><td>segment</td><td colspan="2">offset</td></tr></table>	01	011001	0000	Rd	0	segment	offset										
		01	011001	0000	Rd																							
	address																											
	01	011001	0000	Rd																								
0	segment	offset																										
MULTL RQd, address	<table border="1"><tr><td>01</td><td>011000</td><td>0000</td><td>Rd</td></tr><tr><td colspan="4">address</td></tr></table>	01	011000	0000	Rd	address				SL <table border="1"><tr><td>01</td><td>011001</td><td>0000</td><td>Rd</td></tr><tr><td>1</td><td>segment</td><td>0000</td><td>0000</td></tr><tr><td colspan="4">offset</td></tr></table>	01	011001	0000	Rd	1	segment	0000	0000	offset									
01	011000	0000	Rd																									
address																												
01	011001	0000	Rd																									
1	segment	0000	0000																									
offset																												
X:	MULT RRd, addr(Rs)	<table border="1"><tr><td>01</td><td>011001</td><td>Rs≠0</td><td>Rd</td></tr><tr><td colspan="4">address</td></tr></table>	01	011001	Rs≠0	Rd	address				SS <table border="1"><tr><td>01</td><td>011001</td><td>Rs≠0</td><td>Rd</td></tr><tr><td>0</td><td>segment</td><td colspan="2">offset</td></tr></table>	01	011001	Rs≠0	Rd	0	segment	offset										
		01	011001	Rs≠0	Rd																							
	address																											
	01	011001	Rs≠0	Rd																								
0	segment	offset																										
MULTL RQd, addr(Rs)	<table border="1"><tr><td>01</td><td>011000</td><td>Rs≠0</td><td>Rd</td></tr><tr><td colspan="4">address</td></tr></table>	01	011000	Rs≠0	Rd	address				SL <table border="1"><tr><td>01</td><td>011001</td><td>Rs≠0</td><td>Rd</td></tr><tr><td>1</td><td>segment</td><td>0000</td><td>0000</td></tr><tr><td colspan="4">offset</td></tr></table>	01	011001	Rs≠0	Rd	1	segment	0000	0000	offset									
01	011000	Rs≠0	Rd																									
address																												
01	011001	Rs≠0	Rd																									
1	segment	0000	0000																									
offset																												
			SS <table border="1"><tr><td>01</td><td>011000</td><td>Rs≠0</td><td>Rd</td></tr><tr><td>0</td><td>segment</td><td colspan="2">offset</td></tr></table>	01	011000	Rs≠0	Rd	0	segment	offset																		
		01	011000	Rs≠0	Rd																							
0	segment	offset																										
	SL <table border="1"><tr><td>01</td><td>011000</td><td>Rs≠0</td><td>Rd</td></tr><tr><td>1</td><td>segment</td><td>0000</td><td>0000</td></tr><tr><td colspan="4">offset</td></tr></table>	01	011000	Rs≠0	Rd	1	segment	0000	0000	offset																		
01	011000	Rs≠0	Rd																									
1	segment	0000	0000																									
offset																												

Example:

If register RQ0 (composed of register pairs RR0 and RR2) contains %2222222200000031 (RR2 contains decimal 49), the statement

MULTL RQ0,#10

will leave the value %00000000000001EA (decimal 490) in RQ0.

Note 1: Word register in nonsegmented mode, register pair in segmented mode.

Note 2: Execution times for each instruction are given in the preceding tables.

NEG

Negate

NEG dst
NEGB

dst: R, IR, DA, X

Operation: dst ← -dst

The contents of the destination are negated, that is, replaced by its two's complement value. Note that %8000 for NEG and %80 for NEGB are replaced by themselves since in two's complement representation the negative number with greatest magnitude has no positive counterpart; for these two cases, the V flag is set.

Flags:
C: Cleared if the result is zero; set otherwise, which indicates a "borrow"
Z: Set if the result is zero; cleared otherwise
S: Set if the result is negative; cleared otherwise
V: Set if the result is %8000 for NEG, or %80 for NEGB; cleared otherwise
D: Unaffected
H: Unaffected

Destination Addressing Mode	Assembler Language Syntax	Nonsegmented Mode		Segmented Mode																								
		Instruction Format	Cycles	Instruction Format	Cycles																							
R:	NEG Rd NEGB Rbd	<table border="1"><tr><td>10</td><td>00110</td><td>W</td><td>Rd</td><td>0010</td></tr></table>	10	00110	W	Rd	0010	7	<table border="1"><tr><td>10</td><td>00110</td><td>W</td><td>Rd</td><td>0010</td></tr></table>	10	00110	W	Rd	0010	7													
10	00110	W	Rd	0010																								
10	00110	W	Rd	0010																								
IR:	NEG @Rd ¹ NEGB @Rd ¹	<table border="1"><tr><td>00</td><td>00110</td><td>W</td><td>Rd≠0</td><td>0010</td></tr></table>	00	00110	W	Rd≠0	0010	12	<table border="1"><tr><td>00</td><td>00110</td><td>W</td><td>Rd≠0</td><td>0010</td></tr></table>	00	00110	W	Rd≠0	0010	12													
00	00110	W	Rd≠0	0010																								
00	00110	W	Rd≠0	0010																								
DA:	NEG address NEGB address	<table border="1"><tr><td>01</td><td>00110</td><td>W</td><td>0000</td><td>0010</td></tr><tr><td colspan="4">address</td></tr></table>	01	00110	W	0000	0010	address				15	SS <table border="1"><tr><td>01</td><td>00110</td><td>W</td><td>0000</td><td>0010</td></tr><tr><td>0</td><td>segment</td><td colspan="2">offset</td></tr></table>	01	00110	W	0000	0010	0	segment	offset		16					
			01	00110	W	0000	0010																					
address																												
01	00110	W	0000	0010																								
0	segment	offset																										
X:	NEG addr(Rd) NEGB addr(Rd)	<table border="1"><tr><td>01</td><td>00110</td><td>W</td><td>Rd≠0</td><td>0010</td></tr><tr><td colspan="4">address</td></tr></table>	01	00110	W	Rd≠0	0010	address				16	SL <table border="1"><tr><td>01</td><td>00110</td><td>W</td><td>0000</td><td>0010</td></tr><tr><td>1</td><td>segment</td><td>0000</td><td>0000</td></tr><tr><td colspan="5">offset</td></tr></table>	01	00110	W	0000	0010	1	segment	0000	0000	offset					18
			01	00110	W	Rd≠0	0010																					
address																												
01	00110	W	0000	0010																								
1	segment	0000	0000																									
offset																												
				SS <table border="1"><tr><td>01</td><td>00110</td><td>W</td><td>Rd≠0</td><td>0010</td></tr><tr><td>0</td><td>segment</td><td colspan="2">offset</td></tr></table>	01	00110	W	Rd≠0	0010	0	segment	offset		16														
				01	00110	W	Rd≠0	0010																				
0	segment	offset																										
				SL <table border="1"><tr><td>01</td><td>00110</td><td>W</td><td>Rd≠0</td><td>0010</td></tr><tr><td>1</td><td>segment</td><td>0000</td><td>0000</td></tr><tr><td colspan="5">offset</td></tr></table>	01	00110	W	Rd≠0	0010	1	segment	0000	0000	offset					19									
01	00110	W	Rd≠0	0010																								
1	segment	0000	0000																									
offset																												

Example: If register R8 contains %051F, the statement
NEG R8
will leave the value %FAE1 in R8.

Note 1: Word register in nonsegmented mode, register pair in segmented mode.

NOP

No Operation

NOP

Operation: No operation is performed.

Flags: No flags affected

	Assembler Language Syntax	Nonsegmented Mode		Segmented Mode					
		Instruction Format	Cycles	Instruction Format	Cycles				
	NOP	<table border="1"><tr><td>10001101</td><td>00000111</td></tr></table>	10001101	00000111	7	<table border="1"><tr><td>10001101</td><td>00000111</td></tr></table>	10001101	00000111	7
10001101	00000111								
10001101	00000111								

OR**Or****OR** dst, src
ORBdst: R
src: R, IM, IR, DA, X**Operation:** dst ← dst or src

The source operand is logically ORed with the destination operand and the result is stored in the destination. The contents of the source are not affected. The OR operation results in a one bit being stored whenever either of the corresponding bits in the two operands is one; otherwise a zero bit is stored.

Flags: **C:** Unaffected
Z: Set if the result is zero; cleared otherwise
S: Set if the most significant bit of the result is set; cleared otherwise
P: OR—unaffected; ORB—set if parity of the result is even; cleared otherwise
D: Unaffected
H: Unaffected

Source Addressing Mode	Assembler Language Syntax	Nonsegmented Mode		Segmented Mode																			
		Instruction Format	Cycles	Instruction Format	Cycles																		
R:	OR Rd, Rs ORB Rbd, Rbs	<table border="1"><tr><td>10</td><td>00010</td><td>W</td><td>Rs</td><td>Rd</td></tr></table>	10	00010	W	Rs	Rd	4	<table border="1"><tr><td>10</td><td>00010</td><td>W</td><td>Rs</td><td>Rd</td></tr></table>	10	00010	W	Rs	Rd	4								
10	00010	W	Rs	Rd																			
10	00010	W	Rs	Rd																			
IM:	OR Rd, #data	<table border="1"><tr><td>00</td><td>000101</td><td>0000</td><td>Rd</td></tr><tr><td colspan="4">data</td></tr></table>	00	000101	0000	Rd	data				7	<table border="1"><tr><td>00</td><td>000101</td><td>0000</td><td>Rd</td></tr><tr><td colspan="4">data</td></tr></table>	00	000101	0000	Rd	data				7		
	00	000101	0000	Rd																			
data																							
00	000101	0000	Rd																				
data																							
	ORB Rbd, #data	<table border="1"><tr><td>00</td><td>000100</td><td>0000</td><td>Rd</td></tr><tr><td>data</td><td colspan="3">data</td></tr></table>	00	000100	0000	Rd	data	data			7	<table border="1"><tr><td>00</td><td>000100</td><td>0000</td><td>Rd</td></tr><tr><td>data</td><td colspan="3">data</td></tr></table>	00	000100	0000	Rd	data	data			7		
00	000100	0000	Rd																				
data	data																						
00	000100	0000	Rd																				
data	data																						
IR:	OR Rd, @Rs! ORB Rbd, @Rs!	<table border="1"><tr><td>00</td><td>00010</td><td>W</td><td>Rs≠0</td><td>Rd</td></tr></table>	00	00010	W	Rs≠0	Rd	7	<table border="1"><tr><td>00</td><td>00010</td><td>W</td><td>Rs≠0</td><td>Rd</td></tr></table>	00	00010	W	Rs≠0	Rd	7								
00	00010	W	Rs≠0	Rd																			
00	00010	W	Rs≠0	Rd																			
DA:	OR Rd, address ORB Rbd, address	<table border="1"><tr><td>01</td><td>00010</td><td>W</td><td>0000</td><td>Rd</td></tr><tr><td colspan="4">address</td></tr></table>	01	00010	W	0000	Rd	address				9	SS <table border="1"><tr><td>01</td><td>00010</td><td>W</td><td>0000</td><td>Rd</td></tr><tr><td>0</td><td>segment</td><td colspan="2">offset</td></tr></table>	01	00010	W	0000	Rd	0	segment	offset		10
		01	00010	W	0000	Rd																	
		address																					
01	00010	W	0000	Rd																			
0	segment	offset																					
<table border="1"><tr><td>01</td><td>00010</td><td>W</td><td>0000</td><td>Rd</td></tr><tr><td>1</td><td>segment</td><td>0000</td><td>0000</td><td>offset</td></tr></table>	01	00010	W	0000	Rd	1	segment	0000	0000	offset	SL												
01	00010	W	0000	Rd																			
1	segment	0000	0000	offset																			
<table border="1"><tr><td>01</td><td>00010</td><td>W</td><td>Rs≠0</td><td>Rd</td></tr><tr><td colspan="4">address</td></tr></table>	01	00010	W	Rs≠0	Rd	address				SS <table border="1"><tr><td>0</td><td>segment</td><td colspan="2">offset</td></tr></table>	0	segment	offset										
01	00010	W	Rs≠0	Rd																			
address																							
0	segment	offset																					
X:	OR Rd, addr(Rs) ORB Rbd, addr(Rs)	<table border="1"><tr><td>01</td><td>00010</td><td>W</td><td>Rs≠0</td><td>Rd</td></tr><tr><td colspan="4">address</td></tr></table>	01	00010	W	Rs≠0	Rd	address				10	SS <table border="1"><tr><td>01</td><td>00010</td><td>W</td><td>Rs≠0</td><td>Rd</td></tr><tr><td>0</td><td>segment</td><td colspan="2">offset</td></tr></table>	01	00010	W	Rs≠0	Rd	0	segment	offset		10
		01	00010	W	Rs≠0	Rd																	
address																							
01	00010	W	Rs≠0	Rd																			
0	segment	offset																					
<table border="1"><tr><td>01</td><td>00010</td><td>W</td><td>Rs≠0</td><td>Rd</td></tr><tr><td>1</td><td>segment</td><td>0000</td><td>0000</td><td>address</td></tr></table>	01	00010	W	Rs≠0	Rd	1	segment	0000	0000	address	SL												
01	00010	W	Rs≠0	Rd																			
1	segment	0000	0000	address																			

Example:

If register RL3 contains %C3 (11000011) and the source operand is the immediate value %7B (01111011), the statement

ORB RL3, #%7B

will leave the value %FB (11111011) in RL3.

Note 1: Word register in nonsegmented mode, register pair in segmented mode.

OTDR (SOTDR)

Privileged Instruction

(Special) Output, Decrement and Repeat

OTDR dst, src, r dst: IR
 OTDRB src: IR
 SOTDR
 SOTDRB

Operation:

dst ← src
 AUTODECREMENT src (by 1 if byte, by 2 if word)
 r ← r - 1
 repeat until r = 0

This instruction is used for block output of strings of data. OTDR and OTDRB are used for normal I/O operation; SOTDR and SOTDRB are used for special I/O operation. The contents of the memory location addressed by the source register are loaded into the I/O port addresses by the destination word register. I/O port addresses are 16 bits. The source register is then decremented by one if a byte instruction, or by two if a word instruction, thus moving the pointer to the previous element of the string in memory. The word register specified by "r" (used as a counter) is then decremented by one. The address of I/O port in the destination register is unchanged. The entire operation is repeated until the result of decrementing r is zero. This instruction can output from 1 to 65536 bytes or 32768 word (the value for r must not be greater than 32768 for OTDR or SOTDR).

This instruction can be interrupted after each execution of the basic operation. The program counter value of the start of this instruction is saved before the interrupt request is accepted, so that the instruction can be properly resumed. Seven more cycles should be added to this instruction's execution time for each interrupt request that is accepted.

Flags: C: Unaffected
 Z: Undefined
 S: Unaffected
 V: Set
 D: Unaffected
 H: Unaffected

Addressing Mode	Assembler Language Syntax	Nonsegmented Mode		Segmented Mode																	
		Instruction Format	Cycles ²	Instruction Format	Cycles ²																
IR:	OTDR @Rd,@Rs1, r	<table border="1"> <tr> <td>0011101</td> <td>W</td> <td>Rs</td> <td>101S</td> </tr> <tr> <td>0000</td> <td>r</td> <td>Rd</td> <td>0000</td> </tr> </table>	0011101	W	Rs	101S	0000	r	Rd	0000	11 + 10n	<table border="1"> <tr> <td>0011101</td> <td>W</td> <td>Rs</td> <td>101S</td> </tr> <tr> <td>0000</td> <td>r</td> <td>Rd</td> <td>0000</td> </tr> </table>	0011101	W	Rs	101S	0000	r	Rd	0000	11 + 10n
	0011101		W	Rs	101S																
0000	r	Rd	0000																		
0011101	W	Rs	101S																		
0000	r	Rd	0000																		
OTDRB @Rd,@Rs1, r	SOTDR @Rd,@Rs1, r	SOTDRB @Rd,@Rs1, r																			

Example:

In nonsegmented mode, if register R11 contains %0FFF, register R12 contains %B006, and R13 contains 6, the instruction

```
OTDR @R11, @R12, R13
```

will output the string of words from locations %B006 to %AFFC in descending order to port %0FFF. R12 will contain %AFFA, and R13 will contain 0. R11 will not be affected. The V flag will be set. In segmented mode, R12 would be replaced by a register pair.

Note 1: Word register in nonsegmented mode, register pair in segmented mode.

Note 2: n = number of data elements transferred.

OTIR (SOTIR)

Privileged Instruction

(Special) Output, Increment and Repeat

OTIR dst, src, r dst: IR
 OTIRB src: IR
 SOTIR
 SOTIRB

Operation:

dst ← src
 AUTOINCREMENT src (by 1 if byte, by 2 if word)
 r ← r - 1
 repeat until r = 0

This instruction is used for block output of strings of data. OTIR and OTIRB are used for normal I/O operation; SOTIR and SOTIRB are used for special I/O operation. The contents of the memory location addressed by the source register are loaded into the I/O port addressed by the destination word register. I/O port addresses are 16 bits. The source register is then incremented by one if a byte instruction, or by two if a word instruction, thus moving the pointer to the next element of the string in memory. The word register specified by "r" (used as a counter) is then decremented by one. The address of I/O port in the destination register is unchanged. The entire operation is repeated until the result of decrementing r is zero. This instruction can output from 1 to 65536 bytes or 32768 words (the value for r must not be greater than 32768 for OTIR or SOTIR).

This instruction can be interrupted after each execution of the basic operation. The program counter value of the start of this instruction is saved before the interrupt request is accepted, so that the instruction can be properly resumed. Seven more cycles should be added to this instruction's execution time for each interrupt request that is accepted.

Flags: **C:** Unaffected
 Z: Undefined
 S: Unaffected
 V: Set
 D: Unaffected
 H: Unaffected

Addressing Mode	Assembler Language Syntax	Nonsegmented Mode		Segmented Mode																	
		Instruction Format	Cycles	Instruction Format	Cycles																
IR:	OTIR @Rd, @Rs!, r OTIRB @Rd, @Rs!, r SOTIR @Rd, @Rs!, r SOTIRB @Rd, @Rs!, r	<table border="1"> <tr> <td>0011101</td> <td>W</td> <td>Rs</td> <td>001S</td> </tr> <tr> <td>0000</td> <td>r</td> <td>Rd</td> <td>0000</td> </tr> </table>	0011101	W	Rs	001S	0000	r	Rd	0000	11 + 10n	<table border="1"> <tr> <td>0011101</td> <td>W</td> <td>Rs</td> <td>001S</td> </tr> <tr> <td>0000</td> <td>r</td> <td>Rd</td> <td>0000</td> </tr> </table>	0011101	W	Rs	001S	0000	r	Rd	0000	11 + 10n
		0011101	W	Rs	001S																
0000	r	Rd	0000																		
0011101	W	Rs	001S																		
0000	r	Rd	0000																		

Example:

In nonsegmented mode, the following sequence of instructions can be used to output a string of bytes to the specified I/O port. The pointers to the I/O port and the start of the source string are set, the number of bytes to output is set, and then the output is accomplished.

```
LD      R1, #PORT
LDA     R2, SRCBUF
LD      R3, #LENGTH
OTIRB   @R1, @R2, R3
```

In segmented mode, a register pair would be used instead of R2.

Note 1: Word register in nonsegmented mode, register pair in segmented mode.

Note 2: n = number of data elements transferred.

OUT (SOUT)

Privileged Instruction

(Special) Output

OUT dst, src dst: IR, DA
OUTB src: R
SOUT dst, src dst: DA
SOUTB src: R

Operation: dst ← src

The contents of the source register are loaded into the destination, an Output or Special Output port. OUT and OUTB are used for normal I/O operation; SOUT and SOUTB are used for special I/O operation.

Flags: No flags affected.

Destination Addressing Mode	Assembler Language Syntax	Nonsegmented Mode		Segmented Mode									
		Instruction Format	Cycles	Instruction Format	Cycles								
IR:	OUT @Rd, Rs	<table border="1"><tr><td>0011111</td><td>W</td><td>Rd</td><td>Rs</td></tr></table>	0011111	W	Rd	Rs	10	<table border="1"><tr><td>0011111</td><td>W</td><td>Rd</td><td>Rs</td></tr></table>	0011111	W	Rd	Rs	10
	0011111	W	Rd	Rs									
0011111	W	Rd	Rs										
OUTB @Rd, Rbs													
DA:	OUT port, Rs	<table border="1"><tr><td>0011101</td><td>W</td><td>Rs</td><td>011S</td></tr></table>	0011101	W	Rs	011S	12	<table border="1"><tr><td>0011101</td><td>W</td><td>Rs</td><td>011S</td></tr></table>	0011101	W	Rs	011S	12
	0011101	W	Rs	011S									
0011101	W	Rs	011S										
OUTB port, Rbs	<table border="1"><tr><td colspan="4">port</td></tr></table>	port				<table border="1"><tr><td colspan="4">port</td></tr></table>	port						
port													
port													
	SOUT port, Rs												
	SOUTB port, Rbs												

Example: If register R6 contains %5252, the instruction
 OUT %1120, R6
 will output the value %5252 to the port %1120.

Privileged Instruction

OUTD (SOUTD)

(Special) Output and Decrement

OUTD dst, src, r dst: IR
OUTDB src: IR
SOUTD
SOUTDB

Operation: dst ← src
 AUTODECREMENT src (by 1 if byte, by 2 if word)
 r ← r - 1

This instruction is used for block output of strings of data. OUTD and OUTDB are used for normal I/O operation; SOUTD and SOUTDB are used for special I/O operation. The contents of the memory location addressed by the source register are loaded into the I/O port addressed by the destination word register. I/O port addresses are 16 bits. The source register is then decremented by one if a byte instruction, or by two if a word instruction, thus moving the pointer to the previous element of the string in memory. The word register specified by "r" (used as a counter) is then decremented by one. The address of the I/O port in the source register is unchanged.

Flags: **C:** Unaffected
 Z: Undefined
 S: Unaffected
 V: Set if the result of decrementing r is zero; cleared otherwise
 D: Unaffected
 H: Unaffected

Addressing Mode	Assembler Language Syntax	Nonsegmented Mode		Segmented Mode																	
		Instruction Format	Cycles	Instruction Format	Cycles																
IR:	OUTD @Rd, @Rs!, r OUTDB @Rd, @Rs!, r SOUTD @Rd, @Rs!, r SOUTDB @Rd, @Rs!, r	<table border="1"> <tr> <td>0011101</td> <td>W</td> <td>Rs</td> <td>101S</td> </tr> <tr> <td>0000</td> <td>r</td> <td>Rd</td> <td>1000</td> </tr> </table>	0011101	W	Rs	101S	0000	r	Rd	1000	21	<table border="1"> <tr> <td>0011101</td> <td>W</td> <td>Rs</td> <td>101S</td> </tr> <tr> <td>0000</td> <td>r</td> <td>Rd</td> <td>1000</td> </tr> </table>	0011101	W	Rs	101S	0000	r	Rd	1000	21
0011101	W	Rs	101S																		
0000	r	Rd	1000																		
0011101	W	Rs	101S																		
0000	r	Rd	1000																		

Example: In segmented mode, if register R2 contains the I/O port address %0030, register RR6 contains %12005552 (segment %12, offset %5552), the word at memory location %12005552 contains %1234, and register R8 contains %1001, the instruction

OUTD @R2, @RR6, R8

will output the value %1234 to port %0030 and leave the value %12005550 in RR6, and %1000 in R8. Register R2 will not be affected. The V flag will be cleared. In nonsegmented mode, a word register would be used instead of RR6.

Note 1: Word register in nonsegmented mode, register pair in segmented mode.

OUTI (SOUTI)

Privileged Instruction

(Special) Output and Increment

OUTI dst, src, r dst: IR
OUTIB src: IR
SOUTI
SOUTIB

Operation: dst ← src
 AUTOINCREMENT src (by 1 if byte, by 2 if word)
 r ← r - 1

This instruction is used for block output of strings of data. OUTI and OUTIB are used for normal I/O operation; SOUTI and SOUTIB are used for special I/O operation. The contents of the memory location addressed by the source register are loaded into the I/O port addressed by the destination word register. I/O port addresses are 16-bit. The source register is then incremented by one if a byte instruction, or by two if a word instruction, thus moving the pointer to the next element of the string in memory. The word register specified by "r" (used as a counter) is then decremented by one. The address of the I/O port in the source register is unchanged.

Flags: **C:** Unaffected
 Z: Undefined
 S: Unaffected
 V: Set if the result of decrementing r is zero; cleared otherwise
 D: Unaffected
 H: Unaffected

Addressing Mode	Assembler Language Syntax	Nonsegmented Mode		Segmented Mode																	
		Instruction Format	Cycles	Instruction Format	Cycles																
IR:	OUTI @Rd, @Rs ^l , r OUTIB @Rd, @Rs ^l , r SOUTI @Rd, @Rs ^l , r SOUTIB @Rd, @Rs ^l , r	<table border="1"> <tr> <td>0011101</td> <td>W</td> <td>Rs</td> <td>001S</td> </tr> <tr> <td>0000</td> <td>r</td> <td>Rd</td> <td>1000</td> </tr> </table>	0011101	W	Rs	001S	0000	r	Rd	1000	21	<table border="1"> <tr> <td>0011101</td> <td>W</td> <td>Rs</td> <td>001S</td> </tr> <tr> <td>0000</td> <td>r</td> <td>Rd</td> <td>1000</td> </tr> </table>	0011101	W	Rs	001S	0000	r	Rd	1000	21
0011101	W	Rs	001S																		
0000	r	Rd	1000																		
0011101	W	Rs	001S																		
0000	r	Rd	1000																		

Example:

This instruction can be used in a "loop" of instructions which outputs a string of data, but an intermediate operation on each element is required. The following sequence outputs a string of 80 ASCII characters (bytes) with the most significant bit of each byte set or reset to provide even parity for the entire byte. Bit 7 of each character is initially zero. This example assumes nonsegmented mode. In segmented mode, R2 would be replaced with a register pair.

```
LD          R1, #PORT          !load I/O address!
LDA        R2, SRCSTART        !load start of string!
LD         R3, #80             !initialize counter!
LOOP:
TESTB     @R2                  !test byte parity!
JR        PE, EVEN
SETB     @R2, #7               !force even parity!
EVEN:
OUTIB    @R1, @R2, R3          !output next byte!
JR       NOV, LOOP             !repeat until counter = 0!
DONE:
```

Note 1: Word register in nonsegmented mode, register pair in segmented mode.

POP

Pop

POP dst, src
POPL

dst: R, IR, DA, X
 src: IR

Operation: dst ← src
 AUTOINCREMENT src (by 2 if word, by 4 if long)

The contents of the location addressed by the source register (a stack pointer) are loaded into the destination. The source register is then incremented by a value which equals the size in bytes of the destination operand, thus removing the top element of the stack by changing the stack pointer. Any register except R0 (or RR0 in segmented mode) can be used as a stack pointer.

With the POPL instruction, the same register cannot be used in both the source and destination addressing fields.

Flags: No flags affected

Destination Addressing Mode	Assembler Language Syntax	Nonsegmented Mode		Segmented Mode																
		Instruction Format	Cycles	Instruction Format	Cycles															
R:	POP Rd, @Rs ¹	<table border="1"><tr><td>10</td><td>010111</td><td>Rs ≠ 0</td><td>Rd</td></tr></table>	10	010111	Rs ≠ 0	Rd	8	<table border="1"><tr><td>10</td><td>010111</td><td>Rs ≠ 0</td><td>Rd</td></tr></table>	10	010111	Rs ≠ 0	Rd	8							
	10	010111	Rs ≠ 0	Rd																
10	010111	Rs ≠ 0	Rd																	
POPL RRd, @Rs ¹	<table border="1"><tr><td>10</td><td>010101</td><td>Rs ≠ 0</td><td>Rd</td></tr></table>	10	010101	Rs ≠ 0	Rd	12	<table border="1"><tr><td>10</td><td>010101</td><td>Rs ≠ 0</td><td>Rd</td></tr></table>	10	010101	Rs ≠ 0	Rd	12								
10	010101	Rs ≠ 0	Rd																	
10	010101	Rs ≠ 0	Rd																	
IR:	POP @Rd ¹ , @Rs ¹	<table border="1"><tr><td>00</td><td>010111</td><td>Rs ≠ 0</td><td>Rd ≠ 0</td></tr></table>	00	010111	Rs ≠ 0	Rd ≠ 0	12	<table border="1"><tr><td>00</td><td>010111</td><td>Rs ≠ 0</td><td>Rd ≠ 0</td></tr></table>	00	010111	Rs ≠ 0	Rd ≠ 0	12							
	00	010111	Rs ≠ 0	Rd ≠ 0																
00	010111	Rs ≠ 0	Rd ≠ 0																	
POPL @Rd ¹ , @Rs ¹	<table border="1"><tr><td>00</td><td>010101</td><td>Rs ≠ 0</td><td>Rd ≠ 0</td></tr></table>	00	010101	Rs ≠ 0	Rd ≠ 0	19	<table border="1"><tr><td>00</td><td>010101</td><td>Rs ≠ 0</td><td>Rd ≠ 0</td></tr></table>	00	010101	Rs ≠ 0	Rd ≠ 0	19								
00	010101	Rs ≠ 0	Rd ≠ 0																	
00	010101	Rs ≠ 0	Rd ≠ 0																	
DA:	POP address, @Rs ¹	<table border="1"><tr><td>01</td><td>010111</td><td>Rs ≠ 0</td><td>0000</td></tr><tr><td colspan="3">address</td></tr></table>	01	010111	Rs ≠ 0	0000	address			16	SS <table border="1"><tr><td>01</td><td>010111</td><td>Rs ≠ 0</td><td>0000</td></tr><tr><td>0</td><td>segment</td><td colspan="2">offset</td></tr></table>	01	010111	Rs ≠ 0	0000	0	segment	offset		16
		01	010111	Rs ≠ 0	0000															
	address																			
	01	010111	Rs ≠ 0	0000																
0	segment	offset																		
<table border="1"><tr><td>01</td><td>010111</td><td>Rs ≠ 0</td><td>0000</td></tr><tr><td>1</td><td>segment</td><td colspan="2">offset</td></tr></table>	01	010111	Rs ≠ 0	0000	1	segment	offset		SL	18										
01	010111	Rs ≠ 0	0000																	
1	segment	offset																		
POPL address, @Rs ¹	<table border="1"><tr><td>01</td><td>010101</td><td>Rs ≠ 0</td><td>0000</td></tr><tr><td colspan="3">address</td></tr></table>	01	010101	Rs ≠ 0	0000	address			23	SS <table border="1"><tr><td>01</td><td>010101</td><td>Rs ≠ 0</td><td>0000</td></tr><tr><td>0</td><td>segment</td><td colspan="2">offset</td></tr></table>	01	010101	Rs ≠ 0	0000	0	segment	offset		23	
	01	010101	Rs ≠ 0	0000																
address																				
01	010101	Rs ≠ 0	0000																	
0	segment	offset																		
<table border="1"><tr><td>01</td><td>010101</td><td>Rs ≠ 0</td><td>0000</td></tr><tr><td>1</td><td>segment</td><td colspan="2">offset</td></tr></table>	01	010101	Rs ≠ 0	0000	1	segment	offset		SL	25										
01	010101	Rs ≠ 0	0000																	
1	segment	offset																		

Destination Addressing Mode	Assembler Language Syntax	Nonsegmented Mode		Segmented Mode																			
		Instruction Format	Cycles	Instruction Format	Cycles																		
X:	POP addr(Rd), @Rs ¹	<table border="1"> <tr> <td>01</td> <td>010111</td> <td>Rs ≠ 0</td> <td>Rd ≠ 0</td> </tr> <tr> <td colspan="4">address</td> </tr> </table>	01	010111	Rs ≠ 0	Rd ≠ 0	address				16	<table border="1"> <tr> <td>SS</td> <td>01</td> <td>010111</td> <td>Rs ≠ 0</td> <td>Rd ≠ 0</td> </tr> <tr> <td></td> <td>0</td> <td>segment</td> <td colspan="2">offset</td> </tr> </table>	SS	01	010111	Rs ≠ 0	Rd ≠ 0		0	segment	offset		16
	01	010111	Rs ≠ 0	Rd ≠ 0																			
	address																						
	SS	01	010111	Rs ≠ 0	Rd ≠ 0																		
	0	segment	offset																				
		<table border="1"> <tr> <td>SL</td> <td>01</td> <td>010111</td> <td>Rs ≠ 0</td> <td>Rd ≠ 0</td> </tr> <tr> <td></td> <td>1</td> <td>segment</td> <td colspan="2">0000 0000</td> </tr> <tr> <td colspan="5">offset</td> </tr> </table>	SL	01	010111	Rs ≠ 0	Rd ≠ 0		1	segment	0000 0000		offset					19					
SL	01	010111	Rs ≠ 0	Rd ≠ 0																			
	1	segment	0000 0000																				
offset																							
	POPL addr(Rd), @Rs ¹	<table border="1"> <tr> <td>01</td> <td>010101</td> <td>Rs ≠ 0</td> <td>Rd ≠ 0</td> </tr> <tr> <td colspan="4">address</td> </tr> </table>	01	010101	Rs ≠ 0	Rd ≠ 0	address				23	<table border="1"> <tr> <td>SS</td> <td>01</td> <td>010101</td> <td>Rs ≠ 0</td> <td>Rd ≠ 0</td> </tr> <tr> <td></td> <td>0</td> <td>segment</td> <td colspan="2">offset</td> </tr> </table>	SS	01	010101	Rs ≠ 0	Rd ≠ 0		0	segment	offset		23
01	010101	Rs ≠ 0	Rd ≠ 0																				
address																							
SS	01	010101	Rs ≠ 0	Rd ≠ 0																			
	0	segment	offset																				
				<table border="1"> <tr> <td>SL</td> <td>01</td> <td>010101</td> <td>Rs ≠ 0</td> <td>Rd ≠ 0</td> </tr> <tr> <td></td> <td>1</td> <td>segment</td> <td colspan="2">0000 0000</td> </tr> <tr> <td colspan="5">offset</td> </tr> </table>	SL	01	010101	Rs ≠ 0	Rd ≠ 0		1	segment	0000 0000		offset					26			
SL	01	010101	Rs ≠ 0	Rd ≠ 0																			
	1	segment	0000 0000																				
offset																							

Example:

In nonsegmented mode, if register R12 (a stack pointer) contains %1000, the word at location %1000 contains %0055, and register R3 contains %0022, the instruction

POP R3, @R12

will leave the value %0055 in R3 and the value %1002 in R12. In segmented mode, a register pair must be used as the stack pointer instead of R12.

Note 1: Word register in nonsegmented mode, register pair in segmented mode.

PUSH

Push

PUSH dst, src
PUSHL

dst: IR
 src: R, IM, IR, DA, X

Operation: AUTODECREMENT dst (by 2 if word, by 4 if long)
 dst ← src

The contents of the destination register (a stack pointer) are decremented by a value which equals the size in bytes of the source operand. Then the source operand is loaded into the location addressed by the updated destination register, thus adding a new element to the top of the stack by changing the stack pointer. Any register except R0 (or RRO in segmented mode) can be used as a stack pointer.

With PUSHL, the same register cannot be used for both the source and destination addressing fields.

Flags: No flags affected

Source Addressing Mode	Assembler Language Syntax	Nonsegmented Mode		Segmented Mode																	
		Instruction Format	Cycles	Instruction Format	Cycles																
R:	PUSH @Rd ¹ , Rs	<table border="1"><tr><td>10</td><td>010011</td><td>Rd≠0</td><td>Rs</td></tr></table>	10	010011	Rd≠0	Rs	9	<table border="1"><tr><td>10</td><td>010011</td><td>Rd≠0</td><td>Rs</td></tr></table>	10	010011	Rd≠0	Rs	9								
	10	010011	Rd≠0	Rs																	
10	010011	Rd≠0	Rs																		
PUSHL @Rd ¹ , RRs	<table border="1"><tr><td>10</td><td>010001</td><td>Rd≠0</td><td>Rs</td></tr></table>	10	010001	Rd≠0	Rs	12	<table border="1"><tr><td>10</td><td>010001</td><td>Rd≠0</td><td>Rs</td></tr></table>	10	010001	Rd≠0	Rs	12									
10	010001	Rd≠0	Rs																		
10	010001	Rd≠0	Rs																		
IM:	PUSH @Rd ¹ , #data	<table border="1"><tr><td>00</td><td>001101</td><td>Rd≠0</td><td>1001</td></tr><tr><td colspan="4">data</td></tr></table>	00	001101	Rd≠0	1001	data				12	<table border="1"><tr><td>00</td><td>001101</td><td>Rd≠0</td><td>1001</td></tr><tr><td colspan="4">data</td></tr></table>	00	001101	Rd≠0	1001	data				12
		00	001101	Rd≠0	1001																
data																					
00	001101	Rd≠0	1001																		
data																					
IR:	PUSH @Rd ¹ , @Rs ¹	<table border="1"><tr><td>00</td><td>010011</td><td>Rd≠0</td><td>Rs≠0</td></tr></table>	00	010011	Rd≠0	Rs≠0	13	<table border="1"><tr><td>00</td><td>010011</td><td>Rd≠0</td><td>Rs≠0</td></tr></table>	00	010011	Rd≠0	Rs≠0	13								
	00	010011	Rd≠0	Rs≠0																	
00	010011	Rd≠0	Rs≠0																		
PUSHL @Rd ¹ , @Rs ¹	<table border="1"><tr><td>00</td><td>010001</td><td>Rd≠0</td><td>Rs≠0</td></tr></table>	00	010001	Rd≠0	Rs≠0	20	<table border="1"><tr><td>00</td><td>010001</td><td>Rd≠0</td><td>Rs≠0</td></tr></table>	00	010001	Rd≠0	Rs≠0	20									
00	010001	Rd≠0	Rs≠0																		
00	010001	Rd≠0	Rs≠0																		
DA:	PUSH @Rd ¹ , address	<table border="1"><tr><td>01</td><td>010011</td><td>Rd≠0</td><td>0000</td></tr><tr><td colspan="4">address</td></tr></table>	01	010011	Rd≠0	0000	address				14	<table border="1"><tr><td>01</td><td>010011</td><td>Rd≠0</td><td>0000</td></tr><tr><td>0</td><td>segment</td><td colspan="2">offset</td></tr></table>	01	010011	Rd≠0	0000	0	segment	offset		14
		01	010011	Rd≠0	0000																
		address																			
01	010011	Rd≠0	0000																		
0	segment	offset																			
<table border="1"><tr><td>01</td><td>010011</td><td>Rd≠0</td><td>0000</td></tr><tr><td>1</td><td>segment</td><td colspan="2">offset</td></tr></table>	01	010011	Rd≠0	0000	1	segment	offset		16												
01	010011	Rd≠0	0000																		
1	segment	offset																			
<table border="1"><tr><td>01</td><td>010001</td><td>Rd≠0</td><td>0000</td></tr><tr><td colspan="4">address</td></tr></table>	01	010001	Rd≠0	0000	address				21	<table border="1"><tr><td>01</td><td>010001</td><td>Rd≠0</td><td>0000</td></tr><tr><td>0</td><td>segment</td><td colspan="2">offset</td></tr></table>	01	010001	Rd≠0	0000	0	segment	offset		21		
01	010001	Rd≠0	0000																		
address																					
01	010001	Rd≠0	0000																		
0	segment	offset																			
<table border="1"><tr><td>01</td><td>010001</td><td>Rd≠0</td><td>0000</td></tr><tr><td>1</td><td>segment</td><td colspan="2">offset</td></tr></table>	01	010001	Rd≠0	0000	1	segment	offset		23												
01	010001	Rd≠0	0000																		
1	segment	offset																			

Source Addressing Mode	Assembler Language Syntax	Nonsegmented Mode		Segmented Mode																				
		Instruction Format	Cycles	Instruction Format	Cycles																			
X:	PUSH @Rd1, addr(Rs)	<table border="1"> <tr> <td>01</td> <td>010011</td> <td>Rd≠0</td> <td>Rs≠0</td> </tr> <tr> <td colspan="4">address</td> </tr> </table>	01	010011	Rd≠0	Rs≠0	address				14	<table border="1"> <tr> <td rowspan="2">SS</td> <td>01</td> <td>010011</td> <td>Rd≠0</td> <td>Rs≠0</td> </tr> <tr> <td>0</td> <td>segment</td> <td colspan="2">offset</td> </tr> </table>	SS	01	010011	Rd≠0	Rs≠0	0	segment	offset		14		
		01	010011	Rd≠0	Rs≠0																			
	address																							
	SS	01	010011	Rd≠0	Rs≠0																			
0		segment	offset																					
<table border="1"> <tr> <td>01</td> <td>010011</td> <td>Rd≠0</td> <td>Rs≠0</td> </tr> <tr> <td colspan="4">offset</td> </tr> </table>	01	010011	Rd≠0	Rs≠0	offset				<table border="1"> <tr> <td rowspan="2">SL</td> <td>01</td> <td>010011</td> <td>Rd≠0</td> <td>Rs≠0</td> </tr> <tr> <td>1</td> <td>segment</td> <td colspan="2">0000 0000</td> </tr> <tr> <td colspan="5">offset</td> </tr> </table>	SL	01	010011	Rd≠0	Rs≠0	1	segment	0000 0000		offset					17
01	010011	Rd≠0	Rs≠0																					
offset																								
SL	01	010011	Rd≠0	Rs≠0																				
	1	segment	0000 0000																					
offset																								
PUSHL @Rd1, addr(Rs)	<table border="1"> <tr> <td>01</td> <td>010001</td> <td>Rd≠0</td> <td>Rs≠0</td> </tr> <tr> <td colspan="4">address</td> </tr> </table>	01	010001	Rd≠0	Rs≠0	address				21	<table border="1"> <tr> <td rowspan="2">SS</td> <td>01</td> <td>010001</td> <td>Rd≠0</td> <td>Rs≠0</td> </tr> <tr> <td>0</td> <td>segment</td> <td colspan="2">offset</td> </tr> </table>	SS	01	010001	Rd≠0	Rs≠0	0	segment	offset		21			
	01	010001	Rd≠0	Rs≠0																				
address																								
SS	01	010001	Rd≠0	Rs≠0																				
	0	segment	offset																					
<table border="1"> <tr> <td>01</td> <td>010001</td> <td>Rd≠0</td> <td>Rs≠0</td> </tr> <tr> <td colspan="4">offset</td> </tr> </table>	01	010001	Rd≠0	Rs≠0	offset				<table border="1"> <tr> <td rowspan="2">SL</td> <td>01</td> <td>010001</td> <td>Rd≠0</td> <td>Rs≠0</td> </tr> <tr> <td>1</td> <td>segment</td> <td colspan="2">0000 0000</td> </tr> <tr> <td colspan="5">offset</td> </tr> </table>	SL	01	010001	Rd≠0	Rs≠0	1	segment	0000 0000		offset					24
01	010001	Rd≠0	Rs≠0																					
offset																								
SL	01	010001	Rd≠0	Rs≠0																				
	1	segment	0000 0000																					
offset																								

Example:

In nonsegmented mode, if register R12 (a stack pointer) contains %1002, the word at location %1000 contains %0055, and register R3 contains %0022, the instruction

PUSH @R12, R3

will leave the value %0022 in location %1000 and the value %1000 in R12. In segmented mode, a register pair must be used as the stack pointer instead of R12.

RES

Reset Bit

RES dst, src
RESB

dst: R, IR, DA, X
src: IM
or
dst: R
src: R

Operation: dst(src) ← 0

This instruction clears the specified bit within the destination operand without affecting any other bits in the destination. The source (the bit number) can be specified as either an immediate value (Static), or as a word register which contains the value (Dynamic). In the second case, the destination operand must be a register, and the source operand must be R0 through R7 for RESB, or R0 through R15 for RES. The bit number is a value from 0 to 7 for RESB, or 0 to 15 for RES, with 0 indicating the least significant bit.

Only the lower four bits of the source operand are used to specify the bit number for RES, while only the lower three bits of the source operand are used with RESB. When the source operand is an immediate value, the "src field" in the instruction format encoding contains the bit number in the lowest four bits for RES, or the lowest three bits for RESB.

Flags: No flags affected

Reset Bit Static

Destination Addressing Mode	Assembler Language Syntax	Nonsegmented Mode		Segmented Mode																					
		Instruction Format	Cycles	Instruction Format	Cycles																				
R:	RES Rd, #b	<table border="1"><tr><td>10</td><td>10001</td><td>W</td><td>Rd</td><td>b</td></tr></table>	10	10001	W	Rd	b	4	<table border="1"><tr><td>10</td><td>10001</td><td>W</td><td>Rd</td><td>b</td></tr></table>	10	10001	W	Rd	b	4										
	10	10001	W	Rd	b																				
10	10001	W	Rd	b																					
RESB Rbd, #b	<table border="1"><tr><td>00</td><td>10001</td><td>W</td><td>Rd≠0</td><td>b</td></tr></table>	00	10001	W	Rd≠0	b	11	<table border="1"><tr><td>00</td><td>10001</td><td>W</td><td>Rd≠0</td><td>b</td></tr></table>	00	10001	W	Rd≠0	b	11											
00	10001	W	Rd≠0	b																					
00	10001	W	Rd≠0	b																					
IR:	RES @Rd ¹ , #b	<table border="1"><tr><td>01</td><td>10001</td><td>W</td><td>0000</td><td>b</td></tr><tr><td colspan="5">address</td></tr></table>	01	10001	W	0000	b	address					13	SS <table border="1"><tr><td>01</td><td>10001</td><td>W</td><td>0000</td><td>b</td></tr><tr><td>0</td><td>segment</td><td colspan="3">offset</td></tr></table>	01	10001	W	0000	b	0	segment	offset			14
	01	10001	W	0000	b																				
address																									
01	10001	W	0000	b																					
0	segment	offset																							
RESB @Rd ¹ , #b	<table border="1"><tr><td>01</td><td>10001</td><td>W</td><td>0000</td><td>b</td></tr><tr><td>1</td><td>segment</td><td>0000</td><td>0000</td><td></td></tr><tr><td colspan="5">offset</td></tr></table>	01	10001	W	0000	b	1	segment	0000	0000		offset					SL	16							
01	10001	W	0000	b																					
1	segment	0000	0000																						
offset																									
DA:	RES address, #b	<table border="1"><tr><td>01</td><td>10001</td><td>W</td><td>Rd≠0</td><td>b</td></tr><tr><td colspan="5">address</td></tr></table>	01	10001	W	Rd≠0	b	address					14	SS <table border="1"><tr><td>01</td><td>10001</td><td>W</td><td>Rd≠0</td><td>b</td></tr><tr><td>0</td><td>segment</td><td colspan="3">offset</td></tr></table>	01	10001	W	Rd≠0	b	0	segment	offset			14
	01	10001	W	Rd≠0	b																				
address																									
01	10001	W	Rd≠0	b																					
0	segment	offset																							
RESB address, #b	<table border="1"><tr><td>01</td><td>10001</td><td>W</td><td>Rd≠0</td><td>b</td></tr><tr><td>1</td><td>segment</td><td>0000</td><td>0000</td><td></td></tr><tr><td colspan="5">offset</td></tr></table>	01	10001	W	Rd≠0	b	1	segment	0000	0000		offset					SL	17							
01	10001	W	Rd≠0	b																					
1	segment	0000	0000																						
offset																									
X:	RES addr(Rd), #b	<table border="1"><tr><td>01</td><td>10001</td><td>W</td><td>Rd≠0</td><td>b</td></tr><tr><td colspan="5">address</td></tr></table>	01	10001	W	Rd≠0	b	address					14	SS <table border="1"><tr><td>01</td><td>10001</td><td>W</td><td>Rd≠0</td><td>b</td></tr><tr><td>0</td><td>segment</td><td colspan="3">offset</td></tr></table>	01	10001	W	Rd≠0	b	0	segment	offset			14
	01	10001	W	Rd≠0	b																				
address																									
01	10001	W	Rd≠0	b																					
0	segment	offset																							
RESB addr(Rd), #b	<table border="1"><tr><td>01</td><td>10001</td><td>W</td><td>Rd≠0</td><td>b</td></tr><tr><td>1</td><td>segment</td><td>0000</td><td>0000</td><td></td></tr><tr><td colspan="5">offset</td></tr></table>	01	10001	W	Rd≠0	b	1	segment	0000	0000		offset					SL	17							
01	10001	W	Rd≠0	b																					
1	segment	0000	0000																						
offset																									

Reset Bit Dynamic

Source Addressing Mode	Assembler Language Syntax	Nonsegmented Mode		Segmented Mode																					
		Instruction Format	Cycles	Instruction Format	Cycles																				
R:	RES Rd, Rs RESB Rbd, Rs	<table border="1"> <tr> <td>00</td> <td>10001</td> <td>W</td> <td>0000</td> <td>Rs</td> </tr> <tr> <td>0000</td> <td>Rd</td> <td>0000</td> <td>0000</td> <td></td> </tr> </table>	00	10001	W	0000	Rs	0000	Rd	0000	0000		10	<table border="1"> <tr> <td>00</td> <td>10001</td> <td>W</td> <td>0000</td> <td>Rs</td> </tr> <tr> <td>0000</td> <td>Rd</td> <td>0000</td> <td>0000</td> <td></td> </tr> </table>	00	10001	W	0000	Rs	0000	Rd	0000	0000		10
00	10001	W	0000	Rs																					
0000	Rd	0000	0000																						
00	10001	W	0000	Rs																					
0000	Rd	0000	0000																						

Example: If register RL3 contains %B2 (10110010), the instruction
RESB RL3, #1
will leave the value %B0 (10110000) in RL3.

Note 1: Word register in nonsegmented mode, register pair in segmented mode.

RESFLG

Reset Flag

RESFLG flag

flag: C, Z, S, P, V

Operation: FLAGS (4:7) ← FLAGS (4:7) AND NOT instruction (4:7)

Any combination of the C, Z, S, P or V flags are cleared to zero if the corresponding bits in the instruction are one. If the bit in the instruction corresponding to a flag is zero, the flag will not be affected. All other bits in the FLAGS register are unaffected. Note that the P and V flags are represented by the same bit.

There may be one, two, three, or four operands in the assembly language statement, in any order.

Flags:

- C:** Cleared if specified, unaffected otherwise
- Z:** Cleared if specified, unaffected otherwise
- S:** Cleared if specified, unaffected otherwise
- P/V:** Cleared if specified, unaffected otherwise
- D:** Unaffected
- H:** Unaffected

Assembler Language Syntax	Nonsegmented Mode		Segmented Mode	
	Instruction Format	Cycles	Instruction Format	Cycles
RESFLG flags	10 001101 CZSPV 0011	7	10 001101 CZSPV 0011	7

Example: If the C, S, and V flags are set (1) and the Z flag is clear (0), the statement
RESFLG C, V
will leave the S flag set (1), and the C, Z, and V flags cleared (0).

RET Return

RET cc

Operation:	Nonsegmented if cc is true then $PC \leftarrow @SP$ $SP \leftarrow SP + 2$	Segmented if cc is true then $PC \leftarrow @SP$ $SP \leftarrow SP + 4$
-------------------	---	--

This instruction is used to return to a previously executed procedure at the end of a procedure entered by a CALL or CALR instruction. If the condition specified by "cc" is satisfied by the flags in the FCW, then the contents of the location addressed by the processor stack pointer are popped into the program counter (PC). The next instruction executed is that addressed by the new contents of the PC. See section 6.6.1 for a list of condition codes. The stack pointer used is R15 in nonsegmented mode, or RR14 in segmented mode. If the condition is not satisfied, then the instruction following the RET instruction is executed. If no condition is specified, the return is taken regardless of the flag settings.

Flags: No flags affected

Addressing Mode	Assembler Language Syntax	Nonsegmented Mode		Segmented Mode	
		Instruction Format	Cycles ¹	Instruction Format	Cycles ¹
	RET cc	10 011110 0000 cc	10/7	10 011110 0000 cc	13/7

Example: In nonsegmented mode, if the program counter contains %2550, the stack pointer (R15) contains %3000, location %3000 contains %1004, and the Z flag is clear, then the instruction

RET NZ

will leave the value %3002 in the stack pointer and the program counter will contain %1004 (the address of the next instruction to be executed).

Note 1: The two values correspond to return taken and return not taken.

Rotate Left through Carry

RLC
RLCB

dst: R
src: IM

Operation:

Do src times: (src = 1 or 2)
 $tmp \leftarrow c$
 $c \leftarrow dst(msb)$
 $dst(n + 1) \leftarrow dst(n)$ (for $n = msb - 1$ to 0)
 $dst(0) \leftarrow tmp$

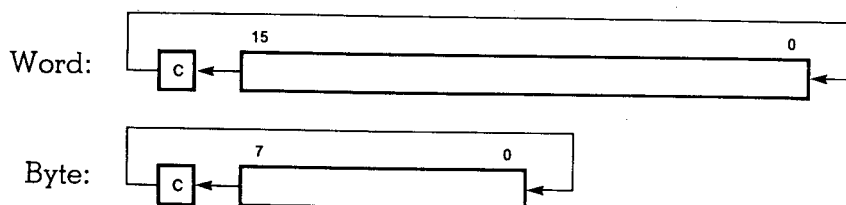

The contents of the destination operand with the C flag are rotated left one bit position if the source operand is 1, or two bit positions if the source operand is 2. The most significant bit (msb) of the destination operand replaces the C flag and the previous value of the C flag is moved to the bit 0 position of the destination during each rotation.

The source operand may be omitted from the assembly language statement and thus defaults to the value 1.

Flags:

- C:** Set if the last bit rotated from the most significant bit position was 1; cleared otherwise
- Z:** Set if the result is zero; cleared otherwise
- S:** Set if the most significant bit of the result is set; cleared otherwise
- V:** Set if arithmetic overflow occurs, that is, if the sign of the destination changed during rotation; cleared otherwise
- D:** Unaffected
- H:** Unaffected

Destination Addressing Mode	Assembler Language Syntax ¹	Nonsegmented Mode		Segmented Mode	
		Instruction Format ²	Cycles ³	Instruction Format ²	Cycles ³
R:	RLC Rd, #n RLCB Rbd, #n	<div style="border: 1px solid black; padding: 2px; display: inline-block;"> 10 11001 W Rd 10 S 0 </div>	6/7	<div style="border: 1px solid black; padding: 2px; display: inline-block;"> 10 11001 W Rd 10 S 0 </div>	6/7

Example:

If the Carry flag is clear (= 0) and register R0 contains %800F (1000000000001111), the statement

RLC R0,#2

will leave the value %003D (0000000000111101) in R0 and clear the Carry flag.

Note 1: n = source operand.

Note 2: s = 0 for rotation by 1 bit; s = 1 for rotation by 2 bits.

Note 3: The given execution times are for rotation by 1 and 2 bits respectively.

RLDB

Rotate Left Digit

RLDB link, src

src: R

link: R

Operation:

tmp (0:3) ← link (0:3)

link (0:3) ← src (4:7)

src (4:7) ← src (0:3)

src (0:3) ← tmp (0:3)

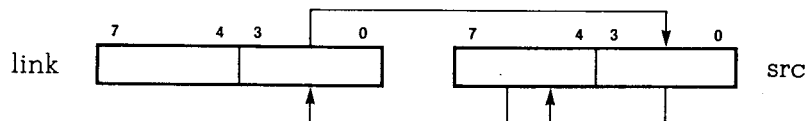

The low digit of the link byte register is logically concatenated to the source byte register. The resulting three-digit quantity is rotated to the left by one BCD digit (four bits). The lower digit of the source is moved to the upper digit of the source; the upper digit of the link and the lower digit of the link are moved to the lower digit of the source. The upper digit of the link is unaffected. In multiple-digit BCD arithmetic, this instruction can be used to shift to the left a string of BCD digits, thus multiplying it by a power of ten. The link serves to transfer digits between successive bytes of the string. This is analogous to the use of the Carry flag in multiple precision shifting using the RLC instruction.

The same byte register must not be used as both the source and the link.

Flags:

C: Unaffected

Z: Set if the link is zero after the operation; cleared otherwise

S: Undefined

V: Unaffected

D: Unaffected

H: Unaffected

Destination Addressing Mode	Assembler Language Syntax	Nonsegmented Mode		Segmented Mode									
		Instruction Format	Cycles	Instruction Format	Cycles								
R:	RLDB Rbl, Rbs	<table border="1"> <tr> <td>10</td> <td>111110</td> <td>Rbs</td> <td>Rbl</td> </tr> </table>	10	111110	Rbs	Rbl	9	<table border="1"> <tr> <td>10</td> <td>111110</td> <td>Rbs</td> <td>Rbl</td> </tr> </table>	10	111110	Rbs	Rbl	9
10	111110	Rbs	Rbl										
10	111110	Rbs	Rbl										

Example:

If location 100 contains the BCD digits 0,1 (00000001), location 101 contains 2,3 (00100011), and location 102 contains 4,5 (01000101)

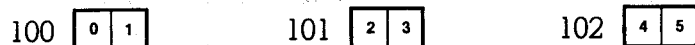

the sequence of statements

	LD	R3,#3	!set loop counter for 3 bytes! !(6 digits)!
	LDA	R2,#102	!set pointer to low-order digits!
	CLRB	RH1	!zero-fill low-order digit!
LOOP:	LDB	RL1,@R2	!get next two digits!
	RLDB	RH1,RL1	!shift digits left one position!
	LDB	@R2,RL1	!replace shifted digits!
	DEC	R2	!advance pointer!
	DJNZ	R3, LOOP	!repeat until counter is zero!

will leave the digits 1,2 (00010010) in location 100, the digits 3,4 (00110100) in location 101, and the digits 5,0 (01010000) in location 102.

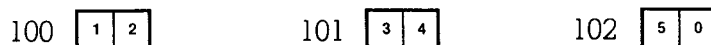

In segmented mode, R2 would be replaced by a register pair.

RR

Rotate Right

RR dst, src
RRB

dst: R
src: IM

Operation:

Do src times: (src = 1 or 2)
 tmp ← dst
 c ← tmp (0)
 dst (msb) ← tmp (0)
 dst (n - 1) ← tmp (n) (for n = 1 to msb)

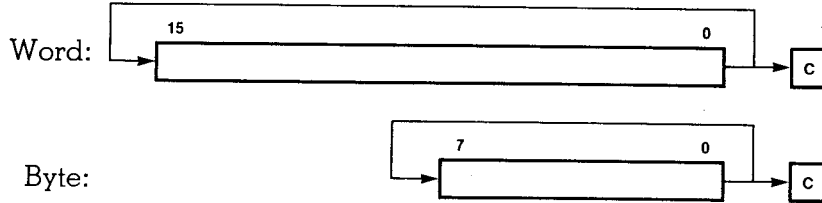

The contents of the destination operand are rotated right one bit position if the source operand is 1, or two bit positions if the source operand is 2. The least significant bit of the destination operand is moved to the most significant bit (msb) and also replaces the C flag.

The source operand may be omitted from the assembly language statement and thus defaults to the value 1.

Flags:

- C:** Set if the last bit rotated from the least significant position was 1; cleared otherwise
- Z:** Set if the result is zero; cleared otherwise
- S:** Set if the most significant bit of the result is set; cleared otherwise
- V:** Set if arithmetic overflow occurs, that is, if the sign of the destination changed during rotation; cleared otherwise
- D:** Unaffected
- H:** Unaffected

Destination Addressing Mode	Assembler Language Syntax	Nonsegmented Mode		Segmented Mode																											
		Instruction Format ¹	Cycles ²	Instruction Format ¹	Cycles ²																										
R:	RR Rd, #n RRB Rbd, #n	<table border="1" style="display: inline-table;"><tr><td>1</td><td>0</td><td>1</td><td>1</td><td>0</td><td>0</td><td>1</td><td>W</td><td>Rd</td><td>0</td><td>1</td><td>S</td><td>0</td></tr></table>	1	0	1	1	0	0	1	W	Rd	0	1	S	0	6/7	<table border="1" style="display: inline-table;"><tr><td>1</td><td>0</td><td>1</td><td>1</td><td>0</td><td>0</td><td>1</td><td>W</td><td>Rd</td><td>0</td><td>1</td><td>S</td><td>0</td></tr></table>	1	0	1	1	0	0	1	W	Rd	0	1	S	0	6/7
1	0	1	1	0	0	1	W	Rd	0	1	S	0																			
1	0	1	1	0	0	1	W	Rd	0	1	S	0																			

Example:

If register RL6 contains %31 (00110001), the statement
 RRB RL6
 will leave the value %98 (10011000) in RL6 and the Carry flag will be set to one.

Note 1: s = 0 for rotation by 1 bit; s = 1 for rotation by 2 bits.

Note 2: The given execution times are for rotation by 1 and 2 bits respectively.

Rotate Right through Carry

RRC dst, src dst: R
RRCB src: IM

Operation:

Do src times: (src = 1 or 2)
 tmp ← c
 c ← dst (0)
 dst (n) ← dst (n + 1) (for n = 0 to msb - 1)
 dst (msb) ← tmp

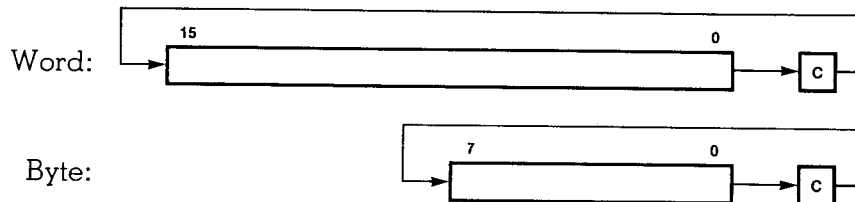

The contents of the destination operand with the C flag are rotated one bit position if the source operand is 1, or two bit positions if the source operand is 2. The least significant bit of the destination operand replaces the C flag and the previous value of the C flag is moved to the most significant bit (msb) position of the destination during each rotation.

The source operand may be omitted from the assembly language statement and thus defaults to the value 1.

Flags:

- C:** Set if the last bit rotated from the least significant bit position was 1; cleared otherwise
- Z:** Set if the result is zero; cleared otherwise
- S:** Set if the most significant bit of the result is set; cleared otherwise
- V:** Set if arithmetic overflow occurs, that is, if the sign of the destination changed during rotation; cleared otherwise
- D:** Unaffected
- H:** Unaffected

Destination Addressing Mode	Assembler Language Syntax	Nonsegmented Mode		Segmented Mode																	
		Instruction Format ¹	Cycles ²	Instruction Format ¹	Cycles ²																
	RRC Rd, #n RRCB Rbd, #n	<table border="1" style="display: inline-table;"><tr><td>10</td><td>11</td><td>001</td><td>W</td><td>Rd</td><td>11</td><td>S</td><td>0</td></tr></table>	10	11	001	W	Rd	11	S	0	6/7	<table border="1" style="display: inline-table;"><tr><td>10</td><td>11</td><td>001</td><td>W</td><td>Rd</td><td>11</td><td>S</td><td>0</td></tr></table>	10	11	001	W	Rd	11	S	0	6/7
10	11	001	W	Rd	11	S	0														
10	11	001	W	Rd	11	S	0														

Example:

If the Carry flag is clear (= 0) and the register R0 contains %00DD (000000011011101), the statement

RRC R0,#2

will leave the value %8037 (10000000110111) in R0 and clear the Carry flag.

Note 1: s = 0 for rotation by 1 bit; s = 1 for rotation by 2 bits

Note 2: The given execution times are for rotation by 1 and 2 bits respectively.

RRDB

Rotate Right Digit

RRDB link, src

src: R
link: R

Operation:

tmp (0:3) ← link (0:3)
link (0:3) ← src (0:3)
src (0:3) ← src (4:7)
src (4:7) ← tmp (0:3)

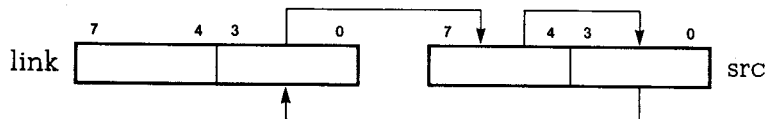

The low digit of the link byte register is logically concatenated to the source byte register. The resulting three-digit quantity is rotated to the right by one BCD digit (four bits).

The lower digit of the source is moved to the lower digit of the link; the upper digit of the source is moved to the lower digit of the source and the lower digit of the link is moved to the upper digit of the source.

The upper digit of the link is unaffected. In multiple-digit BCD arithmetic, this instruction can be used to shift to the right a string of BCD digits, thus dividing it by a power of ten. The link serves to transfer digits between successive bytes of the string. This is analogous to the use of the carry flag in multiple precision shifting using the RRC instruction.

The same byte register must not be used as both the source and the link.

Flags:

C: Unaffected
Z: Set if the link is zero after the operation; cleared otherwise
S: Undefined
V: Unaffected
D: Unaffected
H: Unaffected

Destination Addressing Mode	Assembler Language Syntax	Nonsegmented Mode		Segmented Mode	
		Instruction Format	Cycles	Instruction Format	Cycles
R:	RRDB Rbl, Rbs	<div style="border: 1px solid black; padding: 2px; display: inline-block;"> 10 111100 Rbs Rbl </div>	9	<div style="border: 1px solid black; padding: 2px; display: inline-block;"> 10 111100 Rbs Rbl </div>	9

Example:

If location 100 contains the BCD digits 1,2 (00010010), location 101 contains 3,4 (00110100), and location 102 contains 5,6 (01010110)

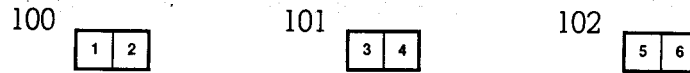

the sequence of statements

	LD	R3,#3	!set loop counter for 3 bytes (6 digits)!
	LDA	R2,100	!set pointer to high-order digits!
	CLRB	RH1	!zero-fill high-order digit!
LOOP:	LDB	RL1,@R2	!get next two digits!
	RRDB	RH1,RL1	!shift digits right one position!
	LDB	@R2,RL1	!replace shifted digits!
	INC	R2	!advance pointer!
	DJNZ	R3,LOOP	!repeat until counter is zero!

will leave the digits 0,1 (00000001) in location 100, the digits 2,3 (00100011) in location 101, and the digits 4,5 (01000101) in location 102. RH1 will contain 6, the remainder from dividing the string by 10.

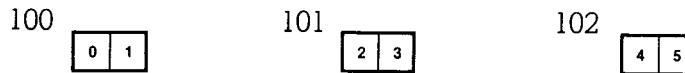

In segmented mode, R2 would be replaced by a register pair.

Privileged Instruction

SC src

src: IM

Operation:

Nonsegmented

SP ← SP - 4

@SP ← PS

SP ← SP - 2

@SP ← instruction

PS ← System Call PS

Segmented

SP ← SP - 6

@SP ← PS

SP ← SP - 2

@SP ← instruction

PS ← System Call PS

This instruction is used for controlled access to operating system software in a manner similar to a trap or interrupt. The current program status (PS) is pushed on the system processor stack, and then the instruction itself, which includes the source operand (an 8-bit value) is pushed. The PS includes the Flag and Control Word (FCW), and the updated program counter (PC). (The updated program counter value used is the address of the first instruction byte following the SC instruction.)

The system stack pointer is always used (R15 in nonsegmented mode, or RR14 in segmented mode), regardless of whether system or normal mode is in effect. The new PS is then loaded from the Program Status block associated with the System Call trap (see section 6.2.4), and control is passed to the procedure whose address is the program counter value contained in the new PS. This procedure may inspect the source operand on the top of the stack to determine the particular software service desired.

The following figure illustrates the format of the saved program status in the system stack:

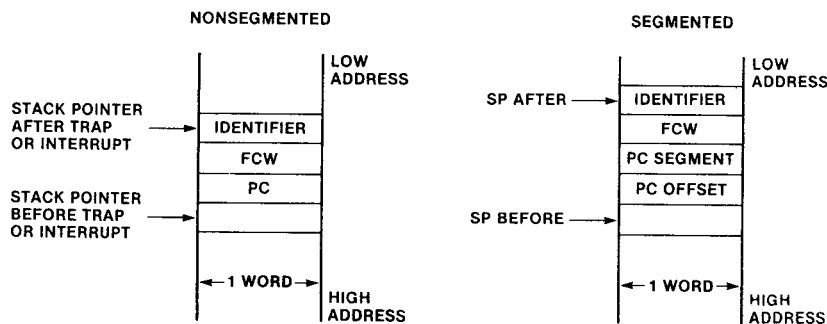

The Z8001 version always executes the segmented mode of the System Call instruction, regardless of the current mode, and sets the Segmentation Mode bit (SEG) to segmented mode (= 1) at the start of the SC instruction execution. Both the Z8001 and Z8002 versions set the System/Normal Mode bit (S/N) to system mode (= 1) at the start of the SC instruction execution. The status pins reflect the setting of these control bits during the execution of the SC instruction. However, the setting of SEG and S/N does not affect the value of these bits in the old FCW pushed onto the stack. The new value of the FCW is not effective until the next instruction, so that the status pins will not be affected by the new control bits until after the SC instruction execution is completed.

The "src field" in the instruction format encoding contains the source operand. The "src field" values range from 0 to 255 corresponding to the source values 0 to 255.

Flags:

No flags affected

Shift Dynamic Arithmetic

SDA dst, src
SDAB
SDAL

dst: R
 src: R

Operation:

Right

Do src times:

- c ← dst (0)
- dst (n) ← dst (n + 1) (for n = 0 to msb - 1)
- dst (msb) ← dst (msb)

Do src times:

- c ← dst (msb)
- dst (n + 1) ← dst (n) (for n = msb - 1 to 0)
- dst (0) ← 0

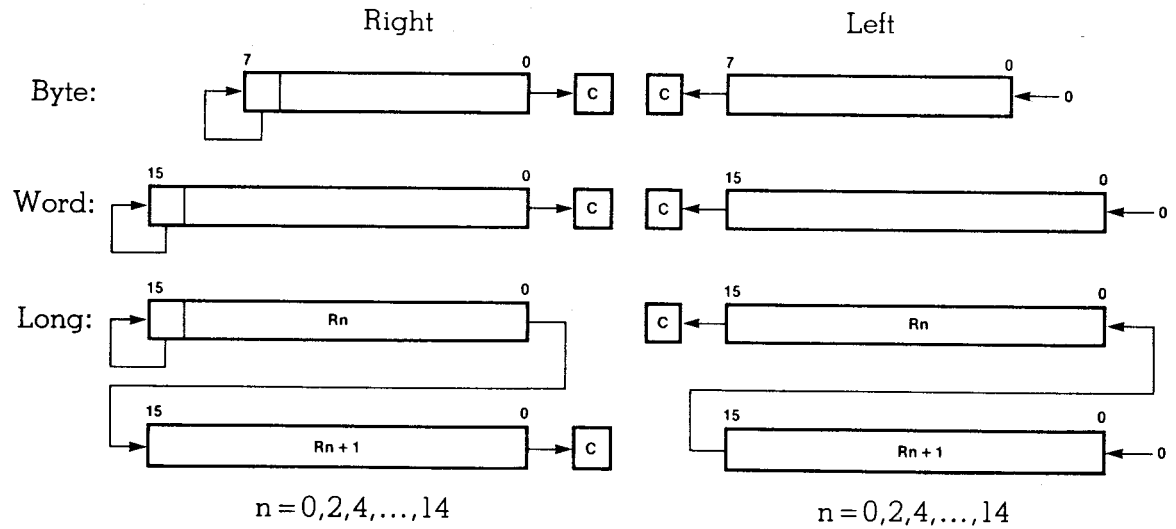

The destination operand is shifted arithmetically left or right by the number of bit positions specified by the contents of the source operand, a word register. The shift count ranges from -8 to +8 for SDAB, from -16 to +16 for SDA and from -32 to +32 for SDAL. If the value is outside the specified range, the operation is undefined. The source operand is represented as a 16-bit two's complement value. Positive values specify a left shift, while negative values specify a right shift. A shift of zero positions does not affect the destination; however, the flags are set according to the destination value. The sign bit is replicated in shifts to the right, and the C flag is loaded from bit 0 of the destination. The least significant bit is filled with 0 in shifts to the left, and the C flag is loaded from the most significant bit (msb) of the destination.

Flags:

- C:** Set if the last bit shifted from the destination was 1, cleared otherwise
- Z:** Set if the result is zero; cleared otherwise
- S:** Set if the result is negative; cleared otherwise
- V:** Set if arithmetic overflow occurs, that is, if the sign of the destination changed during shifting; cleared otherwise
- D:** Unaffected
- H:** Unaffected

Destination Addressing Mode	Assembler Language Syntax	Nonsegmented Mode		Segmented Mode																	
		Instruction Format	Cycles ¹	Instruction Format	Cycles ¹																
R:	SDA Rd, Rs	<table border="1"> <tr><td>10</td><td>110011</td><td>Rd</td><td>1011</td></tr> <tr><td>0000</td><td>Rs</td><td>0000</td><td>0000</td></tr> </table>	10	110011	Rd	1011	0000	Rs	0000	0000	15 + 3n	<table border="1"> <tr><td>10</td><td>110011</td><td>Rd</td><td>1011</td></tr> <tr><td>0000</td><td>Rs</td><td>0000</td><td>0000</td></tr> </table>	10	110011	Rd	1011	0000	Rs	0000	0000	15 + 3n
	10	110011	Rd	1011																	
	0000	Rs	0000	0000																	
10	110011	Rd	1011																		
0000	Rs	0000	0000																		
SDAB Rbd, Rs	<table border="1"> <tr><td>10</td><td>110010</td><td>Rd</td><td>1011</td></tr> <tr><td>0000</td><td>Rs</td><td>0000</td><td>0000</td></tr> </table>	10	110010	Rd	1011	0000	Rs	0000	0000	15 + 3n	<table border="1"> <tr><td>10</td><td>110010</td><td>Rd</td><td>1011</td></tr> <tr><td>0000</td><td>Rs</td><td>0000</td><td>0000</td></tr> </table>	10	110010	Rd	1011	0000	Rs	0000	0000	15 + 3n	
10	110010	Rd	1011																		
0000	Rs	0000	0000																		
10	110010	Rd	1011																		
0000	Rs	0000	0000																		
SDAL RRd, Rs	<table border="1"> <tr><td>10</td><td>110011</td><td>Rd</td><td>1111</td></tr> <tr><td>0000</td><td>Rs</td><td>0000</td><td>0000</td></tr> </table>	10	110011	Rd	1111	0000	Rs	0000	0000	15 + 3n	<table border="1"> <tr><td>10</td><td>110011</td><td>Rd</td><td>1111</td></tr> <tr><td>0000</td><td>Rs</td><td>0000</td><td>0000</td></tr> </table>	10	110011	Rd	1111	0000	Rs	0000	0000	15 + 3n	
10	110011	Rd	1111																		
0000	Rs	0000	0000																		
10	110011	Rd	1111																		
0000	Rs	0000	0000																		

Example:

If register R5 contains %C705 (1100011100000101) and register R1 contains -2 (%FFFE or 1111111111111110), the statement

SDA R5,R1

performs an arithmetic right shift of two bit positions, leaves the value %F1C1 (1111000111000001) in R5, and clears the Carry flag.

Note 1: n = number of bit positions; the execution time for n = 0 is the same as for n = 1.

Destination Addressing Mode	Assembler Language Syntax	Nonsegmented Mode		Segmented Mode																	
		Instruction Format	Cycles	Instruction Format	Cycles																
R:	SDL Rd, Rs	<table border="1"> <tr><td>10</td><td>110011</td><td>Rd</td><td>0011</td></tr> <tr><td>0000</td><td>Rs</td><td>0000</td><td>0000</td></tr> </table>	10	110011	Rd	0011	0000	Rs	0000	0000	15 + 3n	<table border="1"> <tr><td>10</td><td>110011</td><td>Rd</td><td>0011</td></tr> <tr><td>0000</td><td>Rs</td><td>0000</td><td>0000</td></tr> </table>	10	110011	Rd	0011	0000	Rs	0000	0000	15 + 3n
	10	110011	Rd	0011																	
	0000	Rs	0000	0000																	
10	110011	Rd	0011																		
0000	Rs	0000	0000																		
SDLB Rbd, Rs	<table border="1"> <tr><td>10</td><td>110010</td><td>Rd</td><td>0011</td></tr> <tr><td>0000</td><td>Rs</td><td>0000</td><td>0000</td></tr> </table>	10	110010	Rd	0011	0000	Rs	0000	0000	15 + 3n	<table border="1"> <tr><td>10</td><td>110010</td><td>Rd</td><td>0011</td></tr> <tr><td>0000</td><td>Rs</td><td>0000</td><td>0000</td></tr> </table>	10	110010	Rd	0011	0000	Rs	0000	0000	15 + 3n	
10	110010	Rd	0011																		
0000	Rs	0000	0000																		
10	110010	Rd	0011																		
0000	Rs	0000	0000																		
SDLL RRd, Rs	<table border="1"> <tr><td>10</td><td>110011</td><td>Rd</td><td>0111</td></tr> <tr><td>0000</td><td>Rs</td><td>0000</td><td>0000</td></tr> </table>	10	110011	Rd	0111	0000	Rs	0000	0000	15 + 3n	<table border="1"> <tr><td>10</td><td>110011</td><td>Rd</td><td>0111</td></tr> <tr><td>0000</td><td>Rs</td><td>0000</td><td>0000</td></tr> </table>	10	110011	Rd	0111	0000	Rs	0000	0000	15 + 3n	
10	110011	Rd	0111																		
0000	Rs	0000	0000																		
10	110011	Rd	0111																		
0000	Rs	0000	0000																		

Example:

If register RL5 contains %B3 (10110011) and register R1 contains 4 (00000000000000100), the statement

SDLB RL5,R1

performs a logical left shift of four bit positions, leaves the value %30 (00110000) in RL5, and sets the Carry flag.

Note 1: n = number of bit positions; the execution time for n = 0 is the same as for n = 1.

SET Set Bit

SET dst, src
SETB

dst: R, IR, DA, X
src: IM
or
dst: R
src: R

Operation: dst(src) ← 1

Sets the specified bit within the destination operand without affecting any other bits in the destination. The source (the bit number) can be specified as either an immediate value (Static), or as a word register which contains the value (Dynamic). In the second case, the destination operand must be a register, and the source operand must be R0 through R7 for SETB, or R0 through R15 for SET. The bit number is a value from 0 to 7 for SETB or 0 to 15 for SET, with 0 indicating the least significant bit.

Only the lower four bits of the source operand are used to specify the bit number for SET, while only the lower three bits of the source operand are used with SETB. When the source operand is an immediate value, the "src field" in the instruction format encoding contains the bit number in the lowest four bits for SET, or the lowest three bits for SETB.

Flags: No flags affected

Set Bit Static

Destination Addressing Mode	Assembler Language Syntax	Nonsegmented Mode		Segmented Mode																												
		Instruction Format	Cycles	Instruction Format	Cycles																											
R:	SET Rd, #b	<table border="1"><tr><td>10</td><td>10010</td><td>W</td><td>Rd</td><td>b</td></tr></table>	10	10010	W	Rd	b	4	<table border="1"><tr><td>10</td><td>10010</td><td>W</td><td>Rd</td><td>b</td></tr></table>	10	10010	W	Rd	b	4																	
	10	10010	W	Rd	b																											
10	10010	W	Rd	b																												
SETB Rbd, #b	<table border="1"><tr><td>00</td><td>10010</td><td>W</td><td>Rd≠0</td><td>b</td></tr></table>	00	10010	W	Rd≠0	b	<table border="1"><tr><td>00</td><td>10010</td><td>W</td><td>Rd≠0</td><td>b</td></tr></table>	00	10010	W	Rd≠0	b																				
00	10010	W	Rd≠0	b																												
00	10010	W	Rd≠0	b																												
IR:	SET @Rd!, #b	<table border="1"><tr><td>00</td><td>10010</td><td>W</td><td>Rd≠0</td><td>b</td></tr></table>	00	10010	W	Rd≠0	b	11	<table border="1"><tr><td>00</td><td>10010</td><td>W</td><td>Rd≠0</td><td>b</td></tr></table>	00	10010	W	Rd≠0	b	11																	
	00	10010	W	Rd≠0	b																											
00	10010	W	Rd≠0	b																												
SETB @Rd!, #b	<table border="1"><tr><td>01</td><td>10010</td><td>W</td><td>0000</td><td>b</td></tr><tr><td colspan="5">address</td></tr></table>	01	10010	W	0000	b	address					<table border="1"><tr><td>01</td><td>10010</td><td>W</td><td>0000</td><td>b</td></tr><tr><td>0</td><td>segment</td><td colspan="3">offset</td></tr></table>	01	10010	W	0000	b	0	segment	offset												
01	10010	W	0000	b																												
address																																
01	10010	W	0000	b																												
0	segment	offset																														
DA:	SET address, #b	<table border="1"><tr><td>01</td><td>10010</td><td>W</td><td>0000</td><td>b</td></tr><tr><td colspan="5">address</td></tr></table>	01	10010	W	0000	b	address					13	<table border="1"><tr><td>01</td><td>10010</td><td>W</td><td>0000</td><td>b</td></tr><tr><td>1</td><td>segment</td><td colspan="3">0000 0000</td></tr><tr><td colspan="5">offset</td></tr></table>	01	10010	W	0000	b	1	segment	0000 0000			offset					14		
	01	10010	W	0000	b																											
address																																
01	10010	W	0000	b																												
1	segment	0000 0000																														
offset																																
SETB address, #b	<table border="1"><tr><td>01</td><td>10010</td><td>W</td><td>0000</td><td>b</td></tr><tr><td colspan="5">address</td></tr></table>	01	10010	W	0000	b	address					<table border="1"><tr><td>01</td><td>10010</td><td>W</td><td>0000</td><td>b</td></tr><tr><td>0</td><td>segment</td><td colspan="3">offset</td></tr></table>	01	10010	W	0000	b	0	segment	offset												
01	10010	W	0000	b																												
address																																
01	10010	W	0000	b																												
0	segment	offset																														
X:	SET addr(Rd), #b	<table border="1"><tr><td>01</td><td>10010</td><td>W</td><td>Rd≠0</td><td>b</td></tr><tr><td colspan="5">address</td></tr></table>	01	10010	W	Rd≠0	b	address					14	<table border="1"><tr><td>01</td><td>10010</td><td>W</td><td>Rs≠0</td><td>b</td></tr><tr><td>0</td><td>segment</td><td colspan="3">offset</td></tr></table>	01	10010	W	Rs≠0	b	0	segment	offset			14							
	01	10010	W	Rd≠0	b																											
address																																
01	10010	W	Rs≠0	b																												
0	segment	offset																														
SETB addr(Rd), #b	<table border="1"><tr><td>01</td><td>10010</td><td>W</td><td>Rs≠0</td><td>b</td></tr><tr><td>1</td><td>segment</td><td colspan="3">0000 0000</td></tr><tr><td colspan="5">offset</td></tr></table>	01	10010	W	Rs≠0	b	1	segment	0000 0000			offset					<table border="1"><tr><td>01</td><td>10010</td><td>W</td><td>Rs≠0</td><td>b</td></tr><tr><td>1</td><td>segment</td><td colspan="3">0000 0000</td></tr><tr><td colspan="5">offset</td></tr></table>	01	10010	W	Rs≠0	b	1	segment	0000 0000			offset				
01	10010	W	Rs≠0	b																												
1	segment	0000 0000																														
offset																																
01	10010	W	Rs≠0	b																												
1	segment	0000 0000																														
offset																																

Set Bit Dynamic

Addressing Mode	Assembler Language Syntax	Nonsegmented Mode		Segmented Mode																					
		Instruction Format	Cycles	Instruction Format	Cycles																				
R:	SET Rd, Rs SETB Rbd, Rs	<table border="1"> <tr> <td>00</td> <td>10010</td> <td>W</td> <td>0000</td> <td>Rs</td> </tr> <tr> <td>0000</td> <td>Rd</td> <td colspan="3">0000 0000</td> </tr> </table>	00	10010	W	0000	Rs	0000	Rd	0000 0000			10	<table border="1"> <tr> <td>00</td> <td>10010</td> <td>W</td> <td>0000</td> <td>Rs</td> </tr> <tr> <td>0000</td> <td>Rd</td> <td colspan="3">0000 0000</td> </tr> </table>	00	10010	W	0000	Rs	0000	Rd	0000 0000			10
00	10010	W	0000	Rs																					
0000	Rd	0000 0000																							
00	10010	W	0000	Rs																					
0000	Rd	0000 0000																							

Example: If register RL3 contains %B2 (10110010) and register R2 contains the value 6, the instruction
SETB RL3, R2
will leave the value %F2 (11110010) in RL3.

Note 1: Word register in nonsegmented mode, register pair in segmented mode.

SETFLG

Set Flag

SETFLG flag

Flag: C, Z, S, P, V

Operation: FLAGS (4:7) ← FLAGS (4:7) OR instruction (4:7)

Any combination of the C, Z, S, P or V flags are set to one if the corresponding bits in the instruction are one. If the bit in the instruction corresponding to a flag is zero, the flag will not be affected. All other bits in the FLAGS register are unaffected. Note that the P and V flags are represented by the same bit.

There may be one, two, three, or four operands in the assembly language statement, in any order.

Flags:

- C:** Set if specified; unaffected otherwise
- Z:** Set if specified; unaffected otherwise
- S:** Set if specified; unaffected otherwise
- P/V:** Set if specified; unaffected otherwise
- D:** Unaffected
- H:** Unaffected

Assembler Language Syntax	Nonsegmented Mode		Segmented Mode	
	Instruction Format	Cycles	Instruction Format	Cycles
SETFLG flags	10001101 CZSPV 0001	7	10001101 CZSPV 0001	7

Example: If the C, Z, and S flags are all clear (0), and the P flag is set (1), the statement
 SETFLG C
 will leave the C and P flags set (1), and the Z and S flags cleared (0).

SLA

Shift Left Arithmetic

SLA dst, src
SLAB
SLAL

dst: R
 src: IM

Operation:

Do src times:

$c \leftarrow \text{dst}(\text{msb})$
 $\text{dst}(n + 1) \leftarrow \text{dst}(n)$ (for $n = \text{msb} - 1$ to 0)
 $\text{dst}(0) \leftarrow 0$

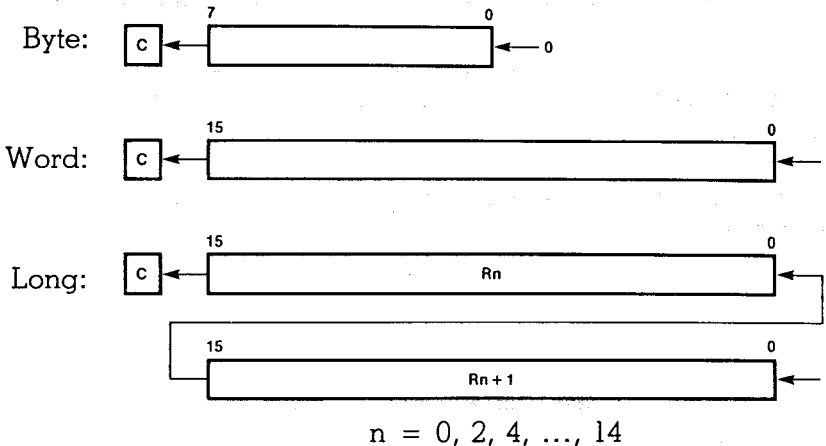

The destination operand is shifted arithmetically left the number of bit positions specified by the source operand. For SLAB, the source is in the range 0 to 8; for SLA, the source is in the range 0 to 16; for SLAL, the source is in the range 0 to 32. A shift of zero positions does not affect the destination; however, the flags are set according to the destination value. The least significant bit of the destination is filled with 0, and the C flag is loaded from the sign bit of the destination. This operation is the equivalent of a multiplication of the destination by a power of two with overflow indication.

The src field is encoded in the instruction format as the 8- or 16-bit two's complement positive value of the source operand. For each operand size, the operation is undefined if the source operand is not in the specified range.

The source operand may be omitted from the assembly language statement and thus defaults to the value 1.

Flags:

- C:** Set if the last bit shifted from the destination was 1; cleared otherwise
- Z:** Set if the result is zero; cleared otherwise
- S:** Set if the result is negative; cleared otherwise
- V:** Set if arithmetic overflow occurs, that is, if the sign of the destination changed during shifting; cleared otherwise
- D:** Unaffected
- H:** Unaffected

Destination Addressing Mode	Assembler Language Syntax	Nonsegmented Mode		Segmented Mode																	
		Instruction Format	Cycles ¹	Instruction Format	Cycles ¹																
R:	SLA Rd, #b	<table border="1"> <tr> <td>10</td> <td>110011</td> <td>Rd</td> <td>1001</td> </tr> <tr> <td colspan="4" style="text-align: center;">b</td> </tr> </table>	10	110011	Rd	1001	b				13 + 3b	<table border="1"> <tr> <td>10</td> <td>110011</td> <td>Rd</td> <td>1001</td> </tr> <tr> <td colspan="4" style="text-align: center;">b</td> </tr> </table>	10	110011	Rd	1001	b				13 + 3b
	10	110011	Rd	1001																	
	b																				
10	110011	Rd	1001																		
b																					
SLAB Rbd, #b	<table border="1"> <tr> <td>10</td> <td>110010</td> <td>Rd</td> <td>1001</td> </tr> <tr> <td colspan="2" style="text-align: center;">b</td> <td colspan="2" style="text-align: center;">b</td> </tr> </table>	10	110010	Rd	1001	b		b		13 + 3b	<table border="1"> <tr> <td>10</td> <td>110010</td> <td>Rd</td> <td>1001</td> </tr> <tr> <td colspan="2" style="text-align: center;">b</td> <td colspan="2" style="text-align: center;">b</td> </tr> </table>	10	110010	Rd	1001	b		b		13 + 3b	
10	110010	Rd	1001																		
b		b																			
10	110010	Rd	1001																		
b		b																			
SLAL RRd, #b	<table border="1"> <tr> <td>10</td> <td>110011</td> <td>Rd</td> <td>1101</td> </tr> <tr> <td colspan="4" style="text-align: center;">b</td> </tr> </table>	10	110011	Rd	1101	b				13 + 3b	<table border="1"> <tr> <td>10</td> <td>110011</td> <td>Rd</td> <td>1101</td> </tr> <tr> <td colspan="4" style="text-align: center;">b</td> </tr> </table>	10	110011	Rd	1101	b				13 + 3b	
10	110011	Rd	1101																		
b																					
10	110011	Rd	1101																		
b																					

Example:

If register pair RR2 contains %1234ABCD, the statement
 SLAL RR2, #8
 will leave the value %34ABCD00 in RR2 and clear the Carry flag.

Note 1: b = number of bit positions; the execution time for b = 0 is the same as for b = 1.

SLL

Shift Left Logical

SLL dst, src
SLB
SLLL

dst: R
 src: IM

Operation:

Do src times:
 $c \leftarrow \text{dst}(\text{msb})$
 $\text{dst}(n + 1) \leftarrow \text{dst}(n)$ (for $n = \text{msb} - 1$ to 0)
 $\text{dst}(0) \leftarrow 0$

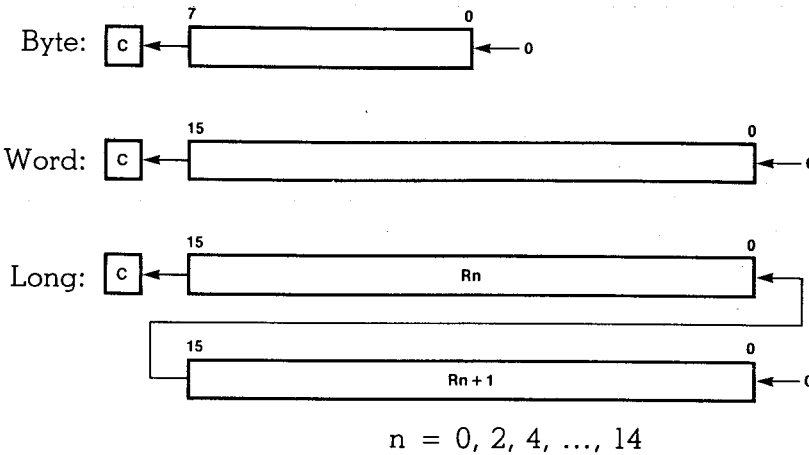

The destination operand is shifted logically left by the number of bit positions specified by the source operand. For SLLB, the source is in the range 0 to 8; for SLL, the source is in the range 0 to 16; for SLLL, the source is in the range 0 to 32. A shift of zero positions does not affect the destination; however, the flags are set according to the destination value. The least significant bit of the destination is filled with 0, and the C flag is loaded from the most significant bit (msb) of the destination. This instruction performs an unsigned multiplication of the destination by a power of two.

The src field is encoded in the instruction format as the 8- or 16-bit positive value of the source operand. For each operand size, the operation is undefined if the source operand is not in the specified range.

The source operand may be omitted from the assembly language statement and thus defaults to the value 1.

Flags:

C: Set if the last bit shifted from the destination was 1; cleared otherwise
Z: Set if the result is zero; cleared otherwise
S: Set if the most significant bit of the result is set; cleared otherwise
V: Undefined
D: Unaffected
H: Unaffected

Destination Addressing Mode	Assembler Language Syntax	Nonsegmented Mode		Segmented Mode																	
		Instruction Format	Cycles ¹	Instruction Format	Cycles ¹																
R:	SLL Rd, #b	<table border="1"> <tr> <td>10</td> <td>110011</td> <td>Rd</td> <td>0001</td> </tr> <tr> <td colspan="4" style="text-align: center;">b</td> </tr> </table>	10	110011	Rd	0001	b				13 + 3b	<table border="1"> <tr> <td>10</td> <td>110011</td> <td>Rd</td> <td>0001</td> </tr> <tr> <td colspan="4" style="text-align: center;">b</td> </tr> </table>	10	110011	Rd	0001	b				13 + 3b
	10	110011	Rd	0001																	
	b																				
10	110011	Rd	0001																		
b																					
SLLB Rbd, #b	<table border="1"> <tr> <td>10</td> <td>110010</td> <td>Rd</td> <td>0001</td> </tr> <tr> <td colspan="2" style="text-align: center;">b</td> <td colspan="2" style="text-align: center;">b</td> </tr> </table>	10	110010	Rd	0001	b		b		13 + 3b	<table border="1"> <tr> <td>10</td> <td>110010</td> <td>Rd</td> <td>0001</td> </tr> <tr> <td colspan="2" style="text-align: center;">b</td> <td colspan="2" style="text-align: center;">b</td> </tr> </table>	10	110010	Rd	0001	b		b		13 + 3b	
10	110010	Rd	0001																		
b		b																			
10	110010	Rd	0001																		
b		b																			
SLLL RRd, #b	<table border="1"> <tr> <td>10</td> <td>110011</td> <td>Rd</td> <td>0101</td> </tr> <tr> <td colspan="4" style="text-align: center;">b</td> </tr> </table>	10	110011	Rd	0101	b				13 + 3b	<table border="1"> <tr> <td>10</td> <td>110011</td> <td>Rd</td> <td>0101</td> </tr> <tr> <td colspan="4" style="text-align: center;">b</td> </tr> </table>	10	110011	Rd	0101	b				13 + 3b	
10	110011	Rd	0101																		
b																					
10	110011	Rd	0101																		
b																					

Example: If register R3 contains %4321 (0100001100100001), the statement
SLL R3,#1
will leave the value %8642 (1000011001000010) in R3 and clear the carry flag.

Note 1: b = number of bit positions; the execution time for b = 0 is the same as for b = 1.

SRA

Shift Right Arithmetic

SRA dst, src
SRAB
SRAL

dst: R
 src: IM

Operation:

Do src times:

$c \leftarrow \text{dst}(0)$
 $\text{dst}(n) \leftarrow \text{dst}(n + 1)$ (for $n = 0$ to $\text{msb} - 1$)
 $\text{dst}(\text{msb}) \leftarrow \text{dst}(\text{msb})$

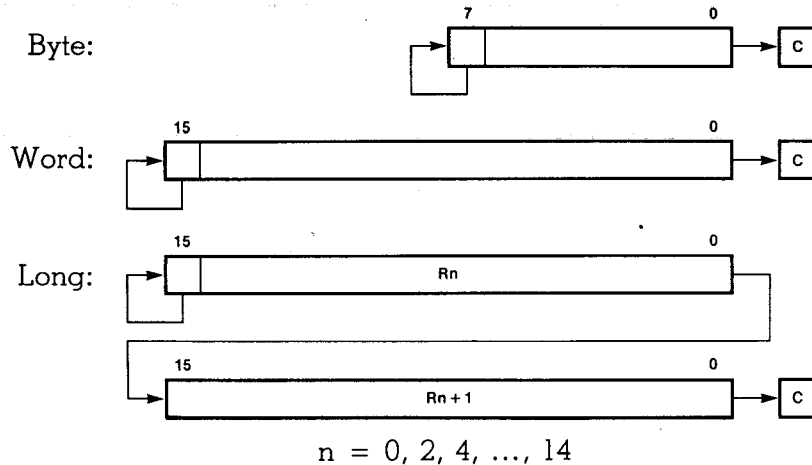

The destination operand is shifted arithmetically right by the number of bit positions specified by the source operands. For SRAB, the source is in the range 0 to 8; for SRA, the source is in the range 0 to 16; for SRAL, the source is in the range 0 to 32. A shift of zero positions does not affect the destination, however, the flags are set according to the destination value. The most significant bit (msb) of the destination is replicated, and the C flag is loaded from bit 0 of the destination, this instruction performs a signed division of the destination by a power of two.

The src field is encoded in the instruction format as the 8- or 16-bit two's complement negative of the source operand. For each operand size, the operation is undefined if the source operand is not in the specified range.

The source operand may be omitted from the assembly language statement and thus defaults to the value 1.

Flags:

- C:** Set if the last bit shifted from the destination was 1; cleared otherwise
- Z:** Set if the result is zero; cleared otherwise
- S:** Set if the result is negative; cleared otherwise
- V:** Cleared
- D:** Unaffected
- H:** Unaffected

Destination Addressing Mode	Assembler Language Syntax	Nonsegmented Mode		Segmented Mode																	
		Instruction Format	Cycles ¹	Instruction Format	Cycles ¹																
R:	SRA Rd, #b	<table border="1"> <tr> <td>10</td> <td>110011</td> <td>Rd</td> <td>1001</td> </tr> <tr> <td colspan="4" style="text-align: center;">-b</td> </tr> </table>	10	110011	Rd	1001	-b				13+3b	<table border="1"> <tr> <td>10</td> <td>110011</td> <td>Rd</td> <td>1001</td> </tr> <tr> <td colspan="4" style="text-align: center;">-b</td> </tr> </table>	10	110011	Rd	1001	-b				13+3b
	10	110011	Rd	1001																	
	-b																				
10	110011	Rd	1001																		
-b																					
SRAB Rbd, #b	<table border="1"> <tr> <td>10</td> <td>110010</td> <td>Rd</td> <td>1001</td> </tr> <tr> <td colspan="2" style="text-align: center;">-b</td> <td colspan="2" style="text-align: center;">-b</td> </tr> </table>	10	110010	Rd	1001	-b		-b		13+3b	<table border="1"> <tr> <td>10</td> <td>110010</td> <td>Rd</td> <td>1001</td> </tr> <tr> <td colspan="2" style="text-align: center;">-b</td> <td colspan="2" style="text-align: center;">-b</td> </tr> </table>	10	110010	Rd	1001	-b		-b		13+3b	
10	110010	Rd	1001																		
-b		-b																			
10	110010	Rd	1001																		
-b		-b																			
SRAL RRd, #b	<table border="1"> <tr> <td>10</td> <td>110011</td> <td>Rd</td> <td>1101</td> </tr> <tr> <td colspan="4" style="text-align: center;">-b</td> </tr> </table>	10	110011	Rd	1101	-b				13+3b	<table border="1"> <tr> <td>10</td> <td>110011</td> <td>Rd</td> <td>1101</td> </tr> <tr> <td colspan="4" style="text-align: center;">-b</td> </tr> </table>	10	110011	Rd	1101	-b				13+3b	
10	110011	Rd	1101																		
-b																					
10	110011	Rd	1101																		
-b																					

Example: If register RH6 contains %3B (00111011), the statement
SRAB RH6,#2
will leave the value %0E (00001110) in RH6 and set the carry flag.

Note 1: b = number of bit positions; the execution time for b = 0 is the same as for b = 1.

SRL

Shift Right Logical

SRL dst, src
SRLB
SRL

dst: R
 src: IM

Operation:

Do src times:

$c \leftarrow \text{dst}(0)$
 $\text{dst}(n) \leftarrow \text{dst}(n + 1)$ (for $n = 0$ to $\text{msb} - 1$)
 $\text{dst}(\text{msb}) \leftarrow 0$

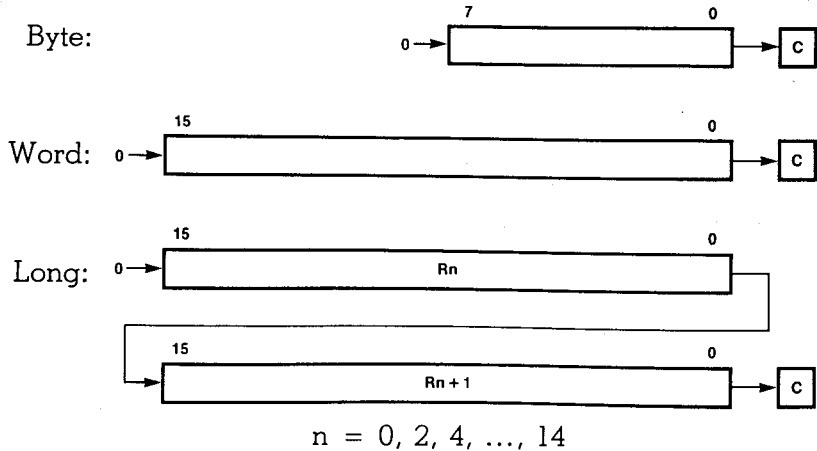

The destination operand is shifted logically right by the number of bit positions specified by the source operand. For SRLB, the source operand is in the range 0 to 8; for SRL, the source is in the range 0 to 16; for SRLL, the source is in the range 0 to 32. A shift of zero positions does not affect the destination, however, the flags are set according to the destination value. The most significant bit (msb) of the destination is filled with 0, and the C flag is loaded from bit 0 of the destination. This instruction performs an unsigned division of the destination by a power of two.

The src field is encoded in the instruction format as the 8- or 16-bit negative value of the source operand in two's complement rotation. For each operand size, the operation is undefined if the source operand is not in the range specified above.

The source operand may be omitted from the assembly language statement and thus defaults to the value of 1.

Flags:

- C:** Set if the last bit shifted from the destination was 1; cleared otherwise
- Z:** Set if the result is zero; cleared otherwise
- S:** Set if the most significant bit of the result is one; cleared otherwise
- V:** Undefined
- D:** Unaffected
- H:** Unaffected

Destination Addressing Mode	Assembler Language Syntax	Nonsegmented Mode		Segmented Mode																	
		Instruction Format	Cycles ¹	Instruction Format	Cycles ¹																
R:	SRL Rd, #b	<table border="1"> <tr> <td>10</td> <td>110011</td> <td>Rd</td> <td>0001</td> </tr> <tr> <td colspan="4" style="text-align: center;">-b</td> </tr> </table>	10	110011	Rd	0001	-b				13 + 3b	<table border="1"> <tr> <td>10</td> <td>110011</td> <td>Rd</td> <td>0001</td> </tr> <tr> <td colspan="4" style="text-align: center;">-b</td> </tr> </table>	10	110011	Rd	0001	-b				13 + 3b
	10	110011	Rd	0001																	
	-b																				
10	110011	Rd	0001																		
-b																					
SRLB Rbd, #b	<table border="1"> <tr> <td>10</td> <td>110010</td> <td>Rd</td> <td>0001</td> </tr> <tr> <td colspan="2" style="text-align: center;">-b</td> <td colspan="2" style="text-align: center;">-b</td> </tr> </table>	10	110010	Rd	0001	-b		-b		13 + 3b	<table border="1"> <tr> <td>10</td> <td>110010</td> <td>Rd</td> <td>0001</td> </tr> <tr> <td colspan="2" style="text-align: center;">-b</td> <td colspan="2" style="text-align: center;">-b</td> </tr> </table>	10	110010	Rd	0001	-b		-b		13 + 3b	
10	110010	Rd	0001																		
-b		-b																			
10	110010	Rd	0001																		
-b		-b																			
SRLl RRd, #b	<table border="1"> <tr> <td>10</td> <td>110011</td> <td>Rd</td> <td>0101</td> </tr> <tr> <td colspan="4" style="text-align: center;">-b</td> </tr> </table>	10	110011	Rd	0101	-b				13 + 3b	<table border="1"> <tr> <td>10</td> <td>110011</td> <td>Rd</td> <td>0101</td> </tr> <tr> <td colspan="4" style="text-align: center;">-b</td> </tr> </table>	10	110011	Rd	0101	-b				13 + 3b	
10	110011	Rd	0101																		
-b																					
10	110011	Rd	0101																		
-b																					

Example: If register R0 contains %1111 (0001000100010001), the statement
SRL R0,#6
will leave the value %0044 (0000000001000100) in R0 and clear the carry flag.

Note 1: b = number of bit positions; the execution time for b = 0 is the same as for b = 1.

SUB

Subtract

SUB dst, src
SUBB
SUBL

dst: R
 src: R, IM, IR, DA, X

Operation: dst ← dst - src

The source operand is subtracted from the destination operand and the result is stored in the destination. The contents of the source are not affected. Subtraction is performed by adding the two's complement of the source operand to the destination operand.

Flags:

- C:** Cleared if there is a carry from the most significant bit; set otherwise, indicating a "borrow"
- Z:** Set if the result is zero; cleared otherwise
- S:** Set if the result is negative; cleared otherwise
- V:** Set if arithmetic overflow occurs, that is, if the operands were of opposite signs and the sign of the result is the same as the sign of the source; cleared otherwise
- D:** SUB, SUBL—unaffected; SUBB—set
- H:** SUB, SUBL—unaffected; SUBB—cleared if there is a carry from the most significant bit of the low-order four bits of the result; set otherwise, indicating a "borrow"

Source Addressing Mode	Assembler Language Syntax	Nonsegmented Mode		Segmented Mode																								
		Instruction Format	Cycles	Instruction Format	Cycles																							
R:	SUB Rd, Rs	<table border="1"><tr><td>10</td><td>00001</td><td>W</td><td>Rs</td><td>Rd</td></tr></table>	10	00001	W	Rs	Rd	4	<table border="1"><tr><td>10</td><td>00001</td><td>W</td><td>Rs</td><td>Rd</td></tr></table>	10	00001	W	Rs	Rd	4													
	10	00001	W	Rs	Rd																							
10	00001	W	Rs	Rd																								
SUBB Rbd, Rbs	<table border="1"><tr><td>10</td><td>010010</td><td>RRs</td><td>RRd</td></tr></table>	10	010010	RRs	RRd	8	<table border="1"><tr><td>10</td><td>010010</td><td>RRs</td><td>RRd</td></tr></table>	10	010010	RRs	RRd	8																
10	010010	RRs	RRd																									
10	010010	RRs	RRd																									
IM:	SUB Rd, #data	<table border="1"><tr><td>00</td><td>000010</td><td>0000</td><td>Rd</td></tr><tr><td colspan="4">data</td></tr></table>	00	000010	0000	Rd	data				7	<table border="1"><tr><td>00</td><td>000010</td><td>0000</td><td>Rd</td></tr><tr><td colspan="4">data</td></tr></table>	00	000010	0000	Rd	data				7							
	00	000010	0000	Rd																								
	data																											
00	000010	0000	Rd																									
data																												
SUBB Rbd, #data	<table border="1"><tr><td>00</td><td>000011</td><td>0000</td><td>Rd</td></tr><tr><td>data</td><td>data</td><td colspan="2"></td></tr></table>	00	000011	0000	Rd	data	data			7	<table border="1"><tr><td>00</td><td>000011</td><td>0000</td><td>Rd</td></tr><tr><td>data</td><td>data</td><td colspan="2"></td></tr></table>	00	000011	0000	Rd	data	data			7								
00	000011	0000	Rd																									
data	data																											
00	000011	0000	Rd																									
data	data																											
SUBL RRd, #data	<table border="1"><tr><td>00</td><td>010010</td><td>0000</td><td>Rd</td></tr><tr><td>31</td><td>data (high)</td><td>16</td><td></td></tr><tr><td>15</td><td>data (low)</td><td>0</td><td></td></tr></table>	00	010010	0000	Rd	31	data (high)	16		15	data (low)	0		14	<table border="1"><tr><td>00</td><td>010010</td><td>0000</td><td>Rd</td></tr><tr><td>31</td><td>data (high)</td><td>16</td><td></td></tr><tr><td>15</td><td>data (low)</td><td>0</td><td></td></tr></table>	00	010010	0000	Rd	31	data (high)	16		15	data (low)	0		14
00	010010	0000	Rd																									
31	data (high)	16																										
15	data (low)	0																										
00	010010	0000	Rd																									
31	data (high)	16																										
15	data (low)	0																										
IR:	SUB Rd, @Rs ¹	<table border="1"><tr><td>00</td><td>00001</td><td>W</td><td>Rs ≠ 0</td><td>Rd</td></tr></table>	00	00001	W	Rs ≠ 0	Rd	7	<table border="1"><tr><td>00</td><td>00001</td><td>W</td><td>Rs ≠ 0</td><td>Rd</td></tr></table>	00	00001	W	Rs ≠ 0	Rd	7													
	00	00001	W	Rs ≠ 0	Rd																							
00	00001	W	Rs ≠ 0	Rd																								
SUBB Rbd, @Rs ¹	<table border="1"><tr><td>00</td><td>010010</td><td>Rs ≠ 0</td><td>Rd</td></tr></table>	00	010010	Rs ≠ 0	Rd	14	<table border="1"><tr><td>00</td><td>010010</td><td>Rs ≠ 0</td><td>Rd</td></tr></table>	00	010010	Rs ≠ 0	Rd	14																
00	010010	Rs ≠ 0	Rd																									
00	010010	Rs ≠ 0	Rd																									

Source Addressing Mode	Assembler Language Syntax	Nonsegmented Mode		Segmented Mode																					
		Instruction Format	Cycles	Instruction Format	Cycles																				
DA:	SUB Rd, address SUBB Rbd, address	<table border="1"><tr><td>01</td><td>00001</td><td>W</td><td>0000</td><td>Rd</td></tr><tr><td colspan="5">address</td></tr></table>	01	00001	W	0000	Rd	address					9	SS <table border="1"><tr><td>01</td><td>00001</td><td>W</td><td>0000</td><td>Rd</td></tr><tr><td>0</td><td>segment</td><td colspan="3">offset</td></tr></table>	01	00001	W	0000	Rd	0	segment	offset			10
		01	00001	W	0000	Rd																			
	address																								
	01	00001	W	0000	Rd																				
0	segment	offset																							
<table border="1"><tr><td>01</td><td>00001</td><td>W</td><td>0000</td><td>Rd</td></tr><tr><td>1</td><td>segment</td><td colspan="3">0000 0000</td></tr><tr><td colspan="5">offset</td></tr></table>	01	00001	W	0000	Rd	1	segment	0000 0000			offset					SL	12								
01	00001	W	0000	Rd																					
1	segment	0000 0000																							
offset																									
SUBL RRd, address	<table border="1"><tr><td>01</td><td>010010</td><td>0000</td><td>Rd</td></tr><tr><td colspan="4">address</td></tr></table>	01	010010	0000	Rd	address				15	SS <table border="1"><tr><td>01</td><td>010010</td><td>0000</td><td>Rd</td></tr><tr><td>0</td><td>segment</td><td colspan="3">offset</td></tr></table>	01	010010	0000	Rd	0	segment	offset			16				
	01	010010	0000	Rd																					
address																									
01	010010	0000	Rd																						
0	segment	offset																							
<table border="1"><tr><td>01</td><td>010010</td><td>0000</td><td>Rd</td></tr><tr><td>1</td><td>segment</td><td colspan="3">0000 0000</td></tr><tr><td colspan="5">offset</td></tr></table>	01	010010	0000	Rd	1	segment	0000 0000			offset					SL	18									
01	010010	0000	Rd																						
1	segment	0000 0000																							
offset																									
X:	SUB Rd, addr(Rs) SUBB Rbd, addr(Rs)	<table border="1"><tr><td>01</td><td>00001</td><td>W</td><td>Rs≠0</td><td>Rd</td></tr><tr><td colspan="5">address</td></tr></table>	01	00001	W	Rs≠0	Rd	address					10	SS <table border="1"><tr><td>01</td><td>00001</td><td>W</td><td>Rs≠0</td><td>Rd</td></tr><tr><td>0</td><td>segment</td><td colspan="3">offset</td></tr></table>	01	00001	W	Rs≠0	Rd	0	segment	offset			10
		01	00001	W	Rs≠0	Rd																			
	address																								
	01	00001	W	Rs≠0	Rd																				
0	segment	offset																							
<table border="1"><tr><td>01</td><td>00001</td><td>W</td><td>Rs≠0</td><td>Rd</td></tr><tr><td>1</td><td>segment</td><td colspan="3">0000 0000</td></tr><tr><td colspan="5">offset</td></tr></table>	01	00001	W	Rs≠0	Rd	1	segment	0000 0000			offset					SL	13								
01	00001	W	Rs≠0	Rd																					
1	segment	0000 0000																							
offset																									
SUBL RRD, addr(Rs)	<table border="1"><tr><td>01</td><td>010010</td><td>Rs≠0</td><td>Rd</td></tr><tr><td colspan="4">address</td></tr></table>	01	010010	Rs≠0	Rd	address				16	SS <table border="1"><tr><td>01</td><td>010010</td><td>Rs≠0</td><td>Rd</td></tr><tr><td>0</td><td>segment</td><td colspan="3">offset</td></tr></table>	01	010010	Rs≠0	Rd	0	segment	offset			16				
	01	010010	Rs≠0	Rd																					
address																									
01	010010	Rs≠0	Rd																						
0	segment	offset																							
<table border="1"><tr><td>01</td><td>010010</td><td>Rs≠0</td><td>Rd</td></tr><tr><td>1</td><td>segment</td><td colspan="3">0000 0000</td></tr><tr><td colspan="5">offset</td></tr></table>	01	010010	Rs≠0	Rd	1	segment	0000 0000			offset					SL	19									
01	010010	Rs≠0	Rd																						
1	segment	0000 0000																							
offset																									

Example: If register R0 contains %0344, the statement
SUB R0, # %AA
will leave the value %029A in R0.

Note 1: Word register in nonsegmented mode, register pair in segmented mode.

TCC

Test Condition Code

TCC cc, dst
TCCB

dst: R

Operation: if cc is satisfied then
dst (0) ← 1

This instruction is used to create a Boolean data value based on the flags set by a previous operation. The flags in the FCW are tested to see if the condition specified by "cc" is satisfied. If the condition is satisfied, then the least significant bit of the destination is set. If the condition is not satisfied, bit zero of the destination is not cleared but retains its previous value. All other bits in the destination are unaffected by this instruction.

Flags: No flags affected

Destination Addressing Mode	Assembler Language Syntax	Nonsegmented Mode		Segmented Mode											
		Instruction Format	Cycles	Instruction Format	Cycles										
R:	TCC cc, Rd TCCB cc, Rbd	<table border="1"><tr><td>10</td><td>10111</td><td>W</td><td>Rd</td><td>cc</td></tr></table>	10	10111	W	Rd	cc	5	<table border="1"><tr><td>10</td><td>10111</td><td>W</td><td>Rd</td><td>cc</td></tr></table>	10	10111	W	Rd	cc	5
10	10111	W	Rd	cc											
10	10111	W	Rd	cc											

Example: If register R1 contains 0, and the Z flag is set, the statement
TCC EQ,R1
will leave the value 1 in R1.

TEST

Test

TEST dst
TESTB
TESTL

dst: R, IR, DA, X

Operation: dst OR 0

The destination operand is tested (logically ORed with zero), and the Z, S and P flags are set to reflect the attributes of the result. The flags may then be used for logical conditional jumps. The contents of the destination are not affected.

Flags:
C: Unaffected
Z: Set if the result is zero; cleared otherwise
S: Set if the most significant bit of the result is set; cleared otherwise
P: TEST—unaffected; TESTL—undefined; TESTB—set if parity of the result is even; cleared otherwise
D: Unaffected
H: Unaffected

Destination Addressing Mode	Assembler Language Syntax	Nonsegmented Mode		Segmented Mode																			
		Instruction Format	Cycles	Instruction Format	Cycles																		
R:	TEST Rd TESTB Rbd	<table border="1"><tr><td>10</td><td>00110</td><td>W</td><td>Rd</td><td>0100</td></tr></table>	10	00110	W	Rd	0100	7	<table border="1"><tr><td>10</td><td>00110</td><td>W</td><td>Rd</td><td>0100</td></tr></table>	10	00110	W	Rd	0100	7								
	10	00110	W	Rd	0100																		
10	00110	W	Rd	0100																			
TESTL RRd	<table border="1"><tr><td>10</td><td>011100</td><td></td><td>Rd</td><td>1000</td></tr></table>	10	011100		Rd	1000	13	<table border="1"><tr><td>10</td><td>011100</td><td></td><td>Rd</td><td>1000</td></tr></table>	10	011100		Rd	1000	13									
10	011100		Rd	1000																			
10	011100		Rd	1000																			
IR:	TEST @Rd ¹ TESTB @Rd ¹	<table border="1"><tr><td>00</td><td>00110</td><td>W</td><td>Rs≠0</td><td>0100</td></tr></table>	00	00110	W	Rs≠0	0100	8	<table border="1"><tr><td>00</td><td>00110</td><td>W</td><td>Rs≠0</td><td>0100</td></tr></table>	00	00110	W	Rs≠0	0100	8								
	00	00110	W	Rs≠0	0100																		
00	00110	W	Rs≠0	0100																			
TESTL @Rd ¹	<table border="1"><tr><td>00</td><td>011100</td><td></td><td>Rs≠0</td><td>1000</td></tr></table>	00	011100		Rs≠0	1000	13	<table border="1"><tr><td>00</td><td>011100</td><td></td><td>Rs≠0</td><td>1000</td></tr></table>	00	011100		Rs≠0	1000	13									
00	011100		Rs≠0	1000																			
00	011100		Rs≠0	1000																			
DA:	TEST address TESTB address	<table border="1"><tr><td>01</td><td>00110</td><td>W</td><td>0000</td><td>0100</td></tr><tr><td colspan="4">address</td></tr></table>	01	00110	W	0000	0100	address				11	<table border="1"><tr><td>01</td><td>00110</td><td>W</td><td>0000</td><td>0100</td></tr><tr><td>0</td><td>segment</td><td colspan="2">offset</td></tr></table>	01	00110	W	0000	0100	0	segment	offset		12
		01	00110	W	0000	0100																	
	address																						
	01	00110	W	0000	0100																		
0	segment	offset																					
<table border="1"><tr><td>01</td><td>00110</td><td>W</td><td>0000</td><td>0100</td></tr><tr><td>1</td><td>segment</td><td colspan="2">0000 0000</td></tr><tr><td colspan="5">address</td></tr></table>	01	00110	W	0000	0100	1	segment	0000 0000		address					14								
01	00110	W	0000	0100																			
1	segment	0000 0000																					
address																							
TESTL address	<table border="1"><tr><td>01</td><td>011100</td><td></td><td>0000</td><td>1000</td></tr><tr><td colspan="4">address</td></tr></table>	01	011100		0000	1000	address				16	<table border="1"><tr><td>01</td><td>011100</td><td></td><td>0000</td><td>1000</td></tr><tr><td>0</td><td>segment</td><td colspan="2">offset</td></tr></table>	01	011100		0000	1000	0	segment	offset		17	
	01	011100		0000	1000																		
address																							
01	011100		0000	1000																			
0	segment	offset																					
<table border="1"><tr><td>01</td><td>011100</td><td></td><td>0000</td><td>1000</td></tr><tr><td>1</td><td>segment</td><td colspan="2">0000 0000</td></tr><tr><td colspan="5">offset</td></tr></table>	01	011100		0000	1000	1	segment	0000 0000		offset					19								
01	011100		0000	1000																			
1	segment	0000 0000																					
offset																							

Destination Addressing Mode	Assembler Language Syntax	Nonsegmented Mode		Segmented Mode																						
		Instruction Format	Cycles	Instruction Format	Cycles																					
X:	TEST addr(Rd) TESTB addr(Rd)	<table border="1"> <tr> <td>01</td> <td>00110</td> <td>W</td> <td>Rd≠0</td> <td>0100</td> </tr> <tr> <td colspan="5">address</td> </tr> </table>	01	00110	W	Rd≠0	0100	address					12	<table border="1"> <tr> <td rowspan="2">SS</td> <td>01</td> <td>00110</td> <td>W</td> <td>Rd≠0</td> <td>0100</td> </tr> <tr> <td>0</td> <td>segment</td> <td colspan="3">offset</td> </tr> </table>	SS	01	00110	W	Rd≠0	0100	0	segment	offset			12
		01	00110	W	Rd≠0	0100																				
	address																									
	SS	01	00110	W	Rd≠0	0100																				
0		segment	offset																							
<table border="1"> <tr> <td>01</td> <td>00110</td> <td>W</td> <td>Rd≠0</td> <td>0100</td> </tr> <tr> <td>1</td> <td>segment</td> <td colspan="3">0000 0000</td> </tr> <tr> <td colspan="5">offset</td> </tr> </table>	01	00110	W	Rd≠0	0100	1	segment	0000 0000			offset					15										
01	00110	W	Rd≠0	0100																						
1	segment	0000 0000																								
offset																										
TESTL addr(Rd)	<table border="1"> <tr> <td>01</td> <td>011100</td> <td>Rd≠0</td> <td>1000</td> </tr> <tr> <td colspan="4">address</td> </tr> </table>	01	011100	Rd≠0	1000	address				17	<table border="1"> <tr> <td rowspan="2">SS</td> <td>01</td> <td>011100</td> <td>Rd≠0</td> <td>1000</td> </tr> <tr> <td>0</td> <td>segment</td> <td colspan="2">offset</td> </tr> </table>	SS	01	011100	Rd≠0	1000	0	segment	offset		17					
	01	011100	Rd≠0	1000																						
address																										
SS	01	011100	Rd≠0	1000																						
	0	segment	offset																							
<table border="1"> <tr> <td>01</td> <td>011100</td> <td>Rd≠0</td> <td>1000</td> </tr> <tr> <td>1</td> <td>segment</td> <td colspan="2">0000 0000</td> </tr> <tr> <td colspan="4">offset</td> </tr> </table>	01	011100	Rd≠0	1000	1	segment	0000 0000		offset				20													
01	011100	Rd≠0	1000																							
1	segment	0000 0000																								
offset																										

Example: If register R5 contains %FFFF (1111111111111111), the statement
TEST R5
will set the S flag, clear the Z flag, and leave the other flags unaffected.

Note 1: Word register in nonsegmented mode, register pair in segmented mode.

TRDRB

Translate, Decrement and Repeat

TRDRB dst, src, R

dst: IR

src: IR

Operation:

dst ← src [dst]
 AUTODECREMENT dst by 1
 r ← r - 1
 repeat until r = 0

This instruction is used to translate a string of bytes from one code to another code. The contents of the location addressed by the destination register (the "target byte") are used as an index into a table of translation values whose lowest address is contained in the source register. The index is computed by adding the target byte to the address contained in the source register. The addition is performed following the rules for address arithmetic, with the target byte treated as an unsigned 8-bit value extended with high-order zeros. The sum is used as the address of an 8-bit translation value within the table that replaces the original contents of the location addressed by the destination register.

The destination register is then decremented by one, thus moving the pointer to the previous element in the string. The word register specified by "r" (used as a counter) is then decremented by one. The entire operation is repeated until the result of decrementing r is zero. This instruction can translate from 1 to 65536 bytes. The original contents of register RH1 are lost and are replaced by an undefined value. The source register is unchanged.

Because the 8-bit target byte is added to the source register to obtain the address of a translation value, the table may contain 256 bytes. A smaller table size may be used where it is known that not all possible 8-bit target byte values will occur.

This instruction can be interrupted after each execution of the basic operation. The program counter of the start of this instruction is saved before the interrupt request is accepted, so the instruction can be properly resumed. Seven cycles should be added to this instruction's execution time for each interrupt request that is accepted.

Flags:
C: Unaffected
Z: Undefined
S: Unaffected
V: Set
D: Unaffected
H: Unaffected

Addressing Mode	Assembler Language Syntax	Nonsegmented Mode		Segmented Mode																	
		Instruction Format	Cycles	Instruction Format	Cycles																
IR:	TRDRB @Rbd ¹ , @Rbs ¹ , r	<table border="1"> <tr> <td>10</td> <td>111000</td> <td>Rd</td> <td>1100</td> </tr> <tr> <td>0000</td> <td>r</td> <td>Rs</td> <td>0000</td> </tr> </table>	10	111000	Rd	1100	0000	r	Rs	0000	11 + 14n	<table border="1"> <tr> <td>10</td> <td>111000</td> <td>Rd</td> <td>1100</td> </tr> <tr> <td>0000</td> <td>r</td> <td>Rs</td> <td>0000</td> </tr> </table>	10	111000	Rd	1100	0000	r	Rs	0000	11 + 14n
10	111000	Rd	1100																		
0000	r	Rs	0000																		
10	111000	Rd	1100																		
0000	r	Rs	0000																		

Example:

In nonsegmented mode, if register R6 contains %4002, the bytes at locations %4000 through %4002 contain the values %00, %40, %80, respectively, register R9 contains %1000, the translation table from location %1000 through %10FF contains 0, 1, 2, ..., %7F, 0, 1, 2, ..., %7F (the second zero is located at %1080), and register R12 contains 3, the instruction

TRDRB @R6, @R9, R12

will leave the values %00, %40, %00 in byte locations %4000 through %4002, respectively. Register R6 will contain %3FFF, and R12 will contain 0. R9 will not be affected. The V flag will be set, and the contents of RH1 will be replaced by an undefined value. In segmented mode, R6 and R9 would be replaced by register pairs. In segmented mode, register pairs must be used instead of R6 and R9.

BEFORE			
%4000	0 0 0 0 0 0 0 0	%1000	0 0 0 0 0 0 0 0
%4001	0 1 0 0 0 0 0 0	%1001	0 0 0 0 0 0 0 1
%4002	1 0 0 0 0 0 0 0	%1002	0 0 0 0 0 0 1 0
		•	•
		•	•
		•	•
		•	•
		%107F	0 1 1 1 1 1 1 1
		%1080	0 0 0 0 0 0 0 0
		%1081	0 0 0 0 0 0 0 1
		%1082	0 0 0 0 0 0 1 0
		•	•
		•	•
		•	•
		%10FF	0 1 1 1 1 1 1 1

AFTER			
%4000	0 0 0 0 0 0 0 0		
%4001	0 1 0 0 0 0 0 0		
%4002	0 0 0 0 0 0 0 0		

Note 1: Word register in nonsegmented mode, register pair in segmented mode.
Note 2: n = number of data elements translated.

TRIB

Translate and Increment

TRIB dst, src, R

dst: IR

src: IR

Operation:

dst ← src[dst]
AUTOINCREMENT dst by 1
r ← r - 1

This instruction is used to translate a string of bytes from one code to another code. The contents of the location addressed by the destination register (the "target byte") are used as an index into a table of translation values whose lowest address is contained in the source register. The index is computed by adding the target byte to the address contained in the source register. The addition is performed following the rules for address arithmetic, with the target byte treated as an unsigned 8-bit value extended with high-order zeros. The sum is used as the address of an 8-bit translation value within the table which replaces the original contents of the location addressed by the destination register. The destination register is then incremented by one, thus moving the pointer to the next element in the string. The word register specified by "r" (used as a counter) is then decremented by one. The original contents of register RH1 are lost and are replaced by an undefined value. The source register is unchanged.

Because the 8-bit target byte is added to the source register to obtain the address of a translation value, the table may contain 256 bytes. A smaller table size may be used where it is known that not all possible 8-bit target byte values will occur.

Flags:

C: Unaffected
Z: Undefined
S: Unaffected
V: Set if the result of decrementing r is zero; cleared otherwise
D: Unaffected
H: Unaffected

Addressing Mode	Assembler Language Syntax	Nonsegmented Mode		Segmented Mode																	
		Instruction Format	Cycles	Instruction Format	Cycles																
	TRIB @Rd!, @Rs!, r	<table border="1"><tr><td>10</td><td>111000</td><td>Rd</td><td>0000</td></tr><tr><td>0000</td><td>r</td><td>Rs</td><td>0000</td></tr></table>	10	111000	Rd	0000	0000	r	Rs	0000	25	<table border="1"><tr><td>10</td><td>111000</td><td>Rd</td><td>0000</td></tr><tr><td>0000</td><td>r</td><td>Rs</td><td>0000</td></tr></table>	10	111000	Rd	0000	0000	r	Rs	0000	25
10	111000	Rd	0000																		
0000	r	Rs	0000																		
10	111000	Rd	0000																		
0000	r	Rs	0000																		

Example:

This instruction can be used in a "loop" of instructions which translate a string of data from one code to any other desired code, but an intermediate operation on each data element is required. The following sequence translates a string of 1000 bytes to the same string of bytes, with all ASCII "control characters" (values less than 32, see Appendix C) translated to the "blank" character (value = 32). A test, however, is made for the special character "return" (value = 13) which terminates the loop. The translation table contains 256 bytes. The first 33 (0-32) entries all contain the value 32, and all other entries contain their own index in the table, counting from zero. This example assumes nonsegmented mode. In segmented mode, R4 and R5 would be replaced by register pairs.

```

LD          R3, #1000          !initialize counter!
LDA        R4, STRING         !load start addresses!
LDA        R5, TABLE

LOOP:
CPB        @R4, #13           !check for return character!
JR         EQ, DONE           !exit loop if found!
TRIB      @R4, @R5, R3       !translate next byte!
JR         NOV, LOOP          !repeat until counter = 0!

DONE:

```

TABLE+0	0 0 1 0 0 0 0 0
TABLE+1	0 0 1 0 0 0 0 0
TABLE+2	0 0 1 0 0 0 0 0
•	•
•	•
•	•
TABLE+32	0 0 1 0 0 0 0 0
TABLE+33	0 0 1 0 0 0 0 1
TABLE+34	0 0 1 0 0 0 1 0
•	•
•	•
•	•
TABLE+255	1 1 1 1 1 1 1 1

Note 1: Word register in nonsegmented mode, register pair in segmented mode.

TRIRB

Translate, Increment and Repeat

TRIRB dst, src, R

dst: IR
src: IR

Operation:

dst ← src[dst]
 AUTOINCREMENT dst by 1
 r ← r - 1
 repeat until r = 0

This instruction is used to translate a string of bytes from one code to another code. The contents of the location addressed by the destination register (the "target byte") are used as an index into a table of translation values whose lowest address is contained in the source register. The index is computed by adding the target byte to the address contained in the source register. The addition is performed following the rules for address arithmetic, with the target byte treated as an unsigned 8-bit value extended with high-order zeros. The sum is used as the address of an 8-bit translation value within the table which replaces the original contents of the location addressed by the destination register. The destination register is then incremented by one, thus moving the pointer to the next element in the string. The word register specified by "r" (used as a counter) is then decremented by one. The entire operation is repeated until the result of decrementing r is zero. This instruction can translate from 1 to 65536 bytes. The original contents of register RH1 are lost and are replaced by an undefined value. The source register is unaffected.

Because the 8-bit target byte is added to the source register to obtain the address of a translation value, the table may contain 256 bytes. A smaller table size may be used where it is known that not all possible 8-bit target byte values will occur.

This instruction can be interrupted after each execution of the basic operation. The program counter of the start of this instruction is saved before the interrupt request is accepted, so that the instruction can be properly resumed. Seven cycles should be added to this instruction's execution time for each interrupt request that is accepted.

Flags:

C: Unaffected
Z: Undefined
S: Unaffected
V: Set
D: Unaffected
H: Unaffected

Addressing Mode	Assembler Language Syntax	Nonsegmented Mode		Segmented Mode																	
		Instruction Format	Cycles ²	Instruction Format	Cycles ²																
IR:	TRIRB @Rd ¹ , @Rs ¹ , r	<table border="1"> <tr> <td>10</td> <td>111000</td> <td>Rd</td> <td>0100</td> </tr> <tr> <td>0000</td> <td>r</td> <td>Rs</td> <td>0000</td> </tr> </table>	10	111000	Rd	0100	0000	r	Rs	0000	11 + 14n	<table border="1"> <tr> <td>10</td> <td>111000</td> <td>Rd</td> <td>0100</td> </tr> <tr> <td>0000</td> <td>r</td> <td>Rs</td> <td>0000</td> </tr> </table>	10	111000	Rd	0100	0000	r	Rs	0000	11 + 14n
10	111000	Rd	0100																		
0000	r	Rs	0000																		
10	111000	Rd	0100																		
0000	r	Rs	0000																		

Example:

The following sequence of instructions can be used to translate a string of 80 bytes from one code to another. The pointers to the string and the translation table are set, the number of bytes to translate is set, and then the translation is accomplished. After executing the last instruction, the V flag is set and the contents of RH1 are lost. The example assumes nonsegmented mode. In segmented mode, R4 and R5 would be replaced by register pairs.

```
LDA  R4, STRING
LDA  R5, TABLE
LD   R3, #80
TRIRB @R4, @R5, R3
```

Note 1: Word register in nonsegmented mode, register pair in segmented mode.

Note 2: n = number of data elements translated.

Translate, Test, Decrement and Repeat

TRTDRB src 1, src 2, R

src 1: IR

src 2: IR

Operation:

$RH1 \leftarrow \text{src } 2[\text{src } 1]$
 AUTODECREMENT src1 by 1
 $r \leftarrow r - 1$
 repeat until $RH1 < > 0$ or $r = 0$

This instruction is used to scan a string of bytes testing for bytes with special meaning. The contents of the location addressed by the first source register (the "target byte") are used as an index into a table of translation values whose lowest address is contained in the second source register. The index is computed by adding the target byte to the address contained in the second source register. The addition is performed following the rules for address arithmetic, with the target byte treated as an unsigned 8-bit value extended with high-order zeros. The sum is used as the address of an 8-bit value within the table which is loaded into register RH1. The Z flag is set if the value loaded into RH1 is zero; otherwise the Z flag is cleared. The contents of the locations addressed by the source registers are not affected. The first source register is then decremented by one, thus moving the pointer to the previous element in the string. The word register specified by "r" (used as a counter) is then decremented by one. The entire operation is repeated until either the Z flag is clear, indicating that a non-zero translation value was loaded into RH1, or until the result of decrementing r is zero. This instruction can translate and test from 1 to 65536 bytes.

Target byte values which have corresponding zero translation-table entry values are to be scanned over, while target byte values which have corresponding non-zero translation-table entry values are to be detected. Because the 8-bit target byte is added to the second source register to obtain the address of a translation value, the table may contain 256 bytes. A smaller table size may be used where it is known that not all possible 8-bit target byte values will occur.

This instruction can be interrupted after each execution of the basic operation. The program counter of the start of this instruction is saved before the interrupt request is accepted, so that the instruction can be properly resumed. Seven cycles should be added to this instruction's execution time for each interrupt request that is accepted.

Flags:

- C:** Unaffected
- Z:** Set if the translation value loaded into RH1 is zero; cleared otherwise
- S:** Unaffected
- V:** Set if the result of decrementing r is zero; cleared otherwise
- D:** Unaffected
- H:** Unaffected

Addressing Mode	Assembler Language Syntax	Nonsegmented Mode		Segmented Mode																	
		Instruction Format	Cycles ²	Instruction Format	Cycles ²																
IR:	TRTDRB@Rs1 ¹ ,@Rs2 ¹ ,r	<table border="1"> <tr> <td>10</td> <td>111000</td> <td>src 1</td> <td>1110</td> </tr> <tr> <td>0000</td> <td>r</td> <td>src 2</td> <td>1110</td> </tr> </table>	10	111000	src 1	1110	0000	r	src 2	1110	11 + 14n	<table border="1"> <tr> <td>10</td> <td>111000</td> <td>src 1</td> <td>1110</td> </tr> <tr> <td>0000</td> <td>r</td> <td>src 2</td> <td>1110</td> </tr> </table>	10	111000	src 1	1110	0000	r	src 2	1110	11 + 14n
10	111000	src 1	1110																		
0000	r	src 2	1110																		
10	111000	src 1	1110																		
0000	r	src 2	1110																		

Example:

In nonsegmented mode, if register R6 contains %5002, the bytes at locations %4000 through %4002 contain the values %00, %40, %80, respectively, register R9 contains %1000, the translation table from location %1000 through %10FF contains 0, 1, 2, ..., %7F, 0, 1, 2, ..., %7F (the second zero is located at %1080), and register R12 contains 3, the instruction

```
TRTDRB @R6, @R9, R12
```

will leave the value %40 in RH1 (which was loaded from location %1040). Register R6 will contain %4000, and R12 will contain 1. R9 will not be affected. The Z and V flags will be cleared. In segmented mode, register pairs must be used instead of R6 and R9.

BEFORE

%4000	0 0 0 0 0 0 0 0
%4001	0 1 0 0 0 0 0 0
%4002	1 0 0 0 0 0 0 0

%1000	0 0 0 0 0 0 0 0
%1001	0 0 0 0 0 0 0 1
%1002	0 0 0 0 0 0 1 0
•	•
•	•
•	•
%107F	0 1 1 1 1 1 1 1
%1080	0 0 0 0 0 0 0 0
%1081	0 0 0 0 0 0 0 1
%1082	0 0 0 0 0 0 1 0
•	•
•	•
•	•
%10FF	0 1 1 1 1 1 1 1

Note 1: Word register in nonsegmented mode, register pair in segmented mode.

Note 2: n = number of data elements translated.

Example:

This instruction can be used in a "loop" of instructions which translate and test a string of data, but an intermediate operation on each data element is required. The following sequence outputs a string of 72 bytes, with each byte of the original string translated from its 7-bit ASCII code to an 8-bit value with odd parity. Lower case characters are translated to upper case, and any embedded control characters are skipped over. The translation table contains 128 bytes, which assumes that the most significant bit of each byte in the string to be translated is always zero. The first 32 entries and the 128th entry are zero, so that ASCII control characters and the "delete" character (%7F) are suppressed. The given instruction sequence is for nonsegmented mode. In segmented mode, register pairs would be used instead of R3 and R4.

```
LD          R5, #72          !initialize counter!
LDA        R3, STRING       !load start address!
LDA        R4, TABLE

LOOP:      TRTIB           @R3, @R4, R5      !translate and test next byte!
           JR             Z, LOOP          !skip control character!
           OUTB          PORTn, RH1       !output characters!
           JR             NOV, LOOP        !repeat until counter = 0!

DONE:
```

Note 1: Word register in nonsegmented mode, register pair in segmented mode.

Example:

The following sequence of instructions can be used in nonsegmented mode to scan a string of 80 bytes, testing for special characters as defined by corresponding non-zero translation table entry values. The pointers to the string and translation table are set, the number of bytes to scan is set, and then the translation and testing is done. The Z and V flags can be tested after the operation to determine if a special character was found and whether the end of the string has been reached. The translation value loaded into RH1 might then be used to index another table, or to select one of a set of sequences of instructions to execute next. In segmented mode, R4 and R5 must be replaced with register pairs.

```
                LDA        R4, STRING
                LDA        R5, TABLE
                LD         R6, #80
                TRTIRB    @R4, @R5, R6
                JR         NZ, SPECIAL
END_OF_STRING:  .
                .
                .
SPECIAL:       JR         OV, LAST_CHAR_SPECIAL
                .
                .
                .
LAST_CHAR_SPECIAL:
```

Note 1: Word register in nonsegmented mode, register pair in segmented mode.

Note 2: n = number of data elements translated.

TSET

Test and Set

TSET dst
TSETB

dst: R, IR, DA, X

Operation:

$S \leftarrow \text{dst}(\text{msb})$
 $\text{dst}(0:\text{msb}) \leftarrow 111\dots111$

Tests the most significant bit of the destination operand, copying its value into the S flag, then sets the entire destination to all 1 bits. This instruction provides a locking mechanism which can be used to synchronize software processes which require exclusive access to certain data or instructions at one time.

During the execution of this instruction, $\overline{\text{BUSRQ}}$ is not honored in the time between loading the destination from memory and storing the destination to memory. For systems with one processor, this ensures that the testing and setting of the destination will be completed without any intervening accesses. This instruction should not be used to synchronize software processes residing on separate processors where the destination is a shared memory location, unless this locking mechanism can be guaranteed to function correctly with multi-processor accesses.

Flags:

C: Unaffected
Z: Unaffected
S: Set if the most significant bit of the destination was 1; cleared otherwise
V: Unaffected
D: Unaffected
H: Unaffected

Addressing Mode	Assembler Language Syntax	Nonsegmented Mode		Segmented Mode																					
		Instruction Format	Cycles	Instruction Format	Cycles																				
R:	TSET Rd TESTB Rbd	<table border="1" style="display: inline-table;"><tr><td>10</td><td>00110</td><td>W</td><td>Rd</td><td>0110</td></tr></table>	10	00110	W	Rd	0110	7	<table border="1" style="display: inline-table;"><tr><td>10</td><td>00110</td><td>W</td><td>Rd</td><td>0110</td></tr></table>	10	00110	W	Rd	0110	7										
10	00110	W	Rd	0110																					
10	00110	W	Rd	0110																					
IR:	TSET @Rd! TSETB @Rd!	<table border="1" style="display: inline-table;"><tr><td>00</td><td>00110</td><td>W</td><td>Rd≠0</td><td>0110</td></tr></table>	00	00110	W	Rd≠0	0110	11	<table border="1" style="display: inline-table;"><tr><td>00</td><td>00110</td><td>W</td><td>Rd≠0</td><td>0110</td></tr></table>	00	00110	W	Rd≠0	0110	11										
00	00110	W	Rd≠0	0110																					
00	00110	W	Rd≠0	0110																					
DA:	TSET address TSETB address	<table border="1" style="display: inline-table;"><tr><td>01</td><td>00110</td><td>W</td><td>0000</td><td>0110</td></tr><tr><td colspan="5" style="text-align: center;">address</td></tr></table>	01	00110	W	0000	0110	address					14	<table border="1" style="display: inline-table;"><tr><td>01</td><td>00110</td><td>W</td><td>0000</td><td>0110</td></tr><tr><td>SS</td><td>0</td><td>segment</td><td colspan="2">offset</td></tr></table>	01	00110	W	0000	0110	SS	0	segment	offset		15
01	00110	W	0000	0110																					
address																									
01	00110	W	0000	0110																					
SS	0	segment	offset																						
				<table border="1" style="display: inline-table;"><tr><td>01</td><td>00110</td><td>W</td><td>0000</td><td>0110</td></tr><tr><td>SL</td><td>1</td><td>segment</td><td colspan="2">0000 0000</td></tr><tr><td colspan="5" style="text-align: center;">offset</td></tr></table>	01	00110	W	0000	0110	SL	1	segment	0000 0000		offset					17					
01	00110	W	0000	0110																					
SL	1	segment	0000 0000																						
offset																									
X:	TSET addr(Rd) TSETB addr(Rd)	<table border="1" style="display: inline-table;"><tr><td>01</td><td>00110</td><td>W</td><td>Rd≠0</td><td>0110</td></tr><tr><td colspan="5" style="text-align: center;">address</td></tr></table>	01	00110	W	Rd≠0	0110	address					15	<table border="1" style="display: inline-table;"><tr><td>01</td><td>00110</td><td>W</td><td>Rd≠0</td><td>0110</td></tr><tr><td>SS</td><td>0</td><td>segment</td><td colspan="2">offset</td></tr></table>	01	00110	W	Rd≠0	0110	SS	0	segment	offset		15
01	00110	W	Rd≠0	0110																					
address																									
01	00110	W	Rd≠0	0110																					
SS	0	segment	offset																						
				<table border="1" style="display: inline-table;"><tr><td>01</td><td>00110</td><td>W</td><td>Rd≠0</td><td>0110</td></tr><tr><td>SL</td><td>1</td><td>segment</td><td colspan="2">0000 0000</td></tr><tr><td colspan="5" style="text-align: center;">offset</td></tr></table>	01	00110	W	Rd≠0	0110	SL	1	segment	0000 0000		offset					18					
01	00110	W	Rd≠0	0110																					
SL	1	segment	0000 0000																						
offset																									

Example:

A simple mutually-exclusive critical region may be implemented by the following sequence of statements:

```
ENTER:
TSET      SEMAPHORE
JR        MI,ENTER      !loop until resource con-
                        !trolled by SEMAPHORE!
                        .
                        .
                        .
!Critical Region—only one software process!
!executes this code at a time!
                        .
                        .
                        .
CLR       SEMAPHORE     !release resource controlled!
                        !by SEMAPHORE!
```

XOR

Exclusive Or

XOR dst, src
XORB

dst: R
 src: R, IM, IR, DA, X

Operation: dst ← dst XOR src

The source operand is logically EXCLUSIVE ORed with the destination operand and the result is stored in the destination. The contents of the source are not affected. The EXCLUSIVE OR operation results in a one bit being stored whenever the corresponding bits in the two operands are different; otherwise, a zero bit is stored.

Flags: **C:** Unaffected
Z: Set if the result is zero; cleared otherwise
S: Set if the most significant bit of the result is set; cleared otherwise
P: XOR—unaffected; XORB—set if parity of the result is even; cleared otherwise
D: Unaffected
H: Unaffected

Source Addressing Mode	Assembler Language Syntax	Nonsegmented Mode		Segmented Mode																			
		Instruction Format	Cycles	Instruction Format	Cycles																		
R:	XOR Rd, Rs XORB Rbd, Rbs	<table border="1" style="display: inline-table;"><tr><td>10</td><td>00100</td><td>W</td><td>Rs</td><td>Rd</td></tr></table>	10	00100	W	Rs	Rd	4	<table border="1" style="display: inline-table;"><tr><td>10</td><td>00100</td><td>W</td><td>Rs</td><td>Rd</td></tr></table>	10	00100	W	Rs	Rd	4								
10	00100	W	Rs	Rd																			
10	00100	W	Rs	Rd																			
IM:	XOR Rd, #data	<table border="1" style="display: inline-table;"><tr><td>00</td><td>001001</td><td>0000</td><td>Rd</td></tr><tr><td colspan="4" style="text-align: center;">data</td></tr></table>	00	001001	0000	Rd	data				7	<table border="1" style="display: inline-table;"><tr><td>00</td><td>001001</td><td>0000</td><td>Rd</td></tr><tr><td colspan="4" style="text-align: center;">data</td></tr></table>	00	001001	0000	Rd	data				7		
	00	001001	0000	Rd																			
data																							
00	001001	0000	Rd																				
data																							
	XORB Rbd, #data	<table border="1" style="display: inline-table;"><tr><td>00</td><td>001000</td><td>0000</td><td>Rd</td></tr><tr><td>data</td><td>data</td><td colspan="2"></td></tr></table>	00	001000	0000	Rd	data	data			7	<table border="1" style="display: inline-table;"><tr><td>00</td><td>001000</td><td>0000</td><td>Rd</td></tr><tr><td>data</td><td>data</td><td colspan="2"></td></tr></table>	00	001000	0000	Rd	data	data			7		
00	001000	0000	Rd																				
data	data																						
00	001000	0000	Rd																				
data	data																						
IR:	XOR Rd, @Rs! XORB Rbd, @Rs!	<table border="1" style="display: inline-table;"><tr><td>00</td><td>00100</td><td>W</td><td>Rs≠0</td><td>Rd</td></tr></table>	00	00100	W	Rs≠0	Rd	7	<table border="1" style="display: inline-table;"><tr><td>00</td><td>00100</td><td>W</td><td>Rs≠0</td><td>Rd</td></tr></table>	00	00100	W	Rs≠0	Rd	7								
00	00100	W	Rs≠0	Rd																			
00	00100	W	Rs≠0	Rd																			
DA:	XOR Rd, address XORB Rbd, address	<table border="1" style="display: inline-table;"><tr><td>01</td><td>00100</td><td>W</td><td>0000</td><td>Rd</td></tr><tr><td colspan="4" style="text-align: center;">address</td></tr></table>	01	00100	W	0000	Rd	address				9	SS <table border="1" style="display: inline-table;"><tr><td>01</td><td>00100</td><td>W</td><td>0000</td><td>Rd</td></tr><tr><td>0</td><td>segment</td><td colspan="2">offset</td></tr></table>	01	00100	W	0000	Rd	0	segment	offset		10
			01	00100	W	0000	Rd																
address																							
01	00100	W	0000	Rd																			
0	segment	offset																					
				SL <table border="1" style="display: inline-table;"><tr><td>01</td><td>00100</td><td>W</td><td>0000</td><td>Rd</td></tr><tr><td>1</td><td>segment</td><td>0000</td><td>0000</td><td></td></tr><tr><td colspan="5" style="text-align: center;">offset</td></tr></table>	01	00100	W	0000	Rd	1	segment	0000	0000		offset					12			
01	00100	W	0000	Rd																			
1	segment	0000	0000																				
offset																							
X:	XOR Rd, addr(Rs) XORB Rbd, addr(Rs)	<table border="1" style="display: inline-table;"><tr><td>01</td><td>00100</td><td>W</td><td>Rs≠0</td><td>Rd</td></tr><tr><td colspan="4" style="text-align: center;">address</td></tr></table>	01	00100	W	Rs≠0	Rd	address				10	SS <table border="1" style="display: inline-table;"><tr><td>01</td><td>00100</td><td>W</td><td>Rs≠0</td><td>Rd</td></tr><tr><td>0</td><td>segment</td><td colspan="2">offset</td></tr></table>	01	00100	W	Rs≠0	Rd	0	segment	offset		10
			01	00100	W	Rs≠0	Rd																
address																							
01	00100	W	Rs≠0	Rd																			
0	segment	offset																					
				SL <table border="1" style="display: inline-table;"><tr><td>01</td><td>00100</td><td>W</td><td>Rs≠0</td><td>Rd</td></tr><tr><td>1</td><td>segment</td><td>0000</td><td>0000</td><td></td></tr><tr><td colspan="5" style="text-align: center;">offset</td></tr></table>	01	00100	W	Rs≠0	Rd	1	segment	0000	0000		offset					13			
01	00100	W	Rs≠0	Rd																			
1	segment	0000	0000																				
offset																							

Example:

If register RL3 contains %C3 (11000011) and the source operand is the immediate value %7B (01111011), the statement

```
XORB RL3, #%7B
```

will leave the value %B8 (10111000) in RL3.

Note 1: Word register in nonsegmented mode, register pair in segmented mode.

6.8 EPA Instruction Templates

There are seven "templates" for EPA instructions. These templates correspond to EPA instructions, which combine EPU operations with possible transfers between memory and an EPU, between CPU registers and EPU registers, and between the Flag byte of the CPU's FCW and the EPU. Each of these templates is described on the following pages. The description assumes that the EPA control bit in the CPU's FCW has been set to 1. In addition, the description is from the point of view of the CPU—that is, only CPU activities are described; the operation of the EPU is implied,

but the full specification of the instruction depends upon the implementation of the EPU and is beyond the scope of this manual.

Fields ignored by the CPU are shaded in the diagrams of the templates. The 2-bit field in bit positions 0 and 1 of the first word of each template would normally be used as an identification field for selecting one of up to four EPUs in a multiple EPU system configuration. Other shaded fields would typically contain opcodes for instructing an EPU as to the operation it is to perform in addition to the data transfer specified by the template.

Extended Instruction

Load Memory from EPU

Operation: Memory ← EPU

The CPU performs the indicated address calculation and generates n EPU memory write transactions. The n words are supplied by an EPU and are stored in n consecutive memory locations starting with the effective address.

Flags/Registers: No flags or CPU registers are affected by this instruction.

Execution Time: $10 + 3n$ cycles.

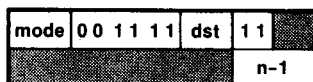

		Clock Cycles			
mode	dst	NS	SS	SL	
0 0	IR (dst ≠ 0)	11 + 3n			
0 1	X (dst ≠ 0)	15 + 3n	15 + 3n	18 + 3n	
0 1	DA (dst = 0)	14 + 3n	15 + 3n	17 + 3n	

Extended Instruction

Load EPU from Memory

Operation: EPU ← Memory

The CPU performs the indicated address calculation and generates n EPU memory read transactions. The n consecutive words are fetched from the memory locations starting with the effective address. The data is read by an EPU and operated upon according to the EPA instruction encoded into the shaded fields.

Flags/Registers: No flags or CPU registers are affected by this instruction.

Execution Time: $10 + 3n$ cycles

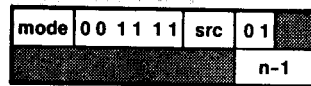

mode	src	NS	Clock Cycles	
			SS	SL
0 0	IR (src ≠ 0)	$11 + 3n$		
0 1	X (src ≠ 0)	$15 + 3n$	$15 + 3n$	$18 + 3n$
0 1	DA (src = 0)	$14 + 3n$	$15 + 3n$	$17 + 3n$

Extended Instruction

Load CPU from EPU

Operation: CPU ← EPU registers

The contents of n words are transferred from an EPU to consecutive CPU registers starting with register *dst*. CPU registers are transferred consecutively, with register 0 following register 15.

Flags/Registers: No flags are affected by this instruction.

Execution Time: $11 + 3n$ cycles.

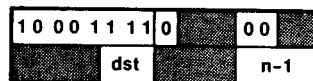

Extended Instruction

Load EPU from CPU

Operation: EPU ← CPU registers

The contents of n words are transferred to an EPU from consecutive CPU registers starting with register *src*. CPU registers are transferred consecutively, with register 0 following register 15.

Flags/Registers: No flags are affected by this instruction.

Execution Time: $11 + 3n$ cycles.

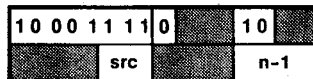

Extended Instruction

Load FCW from EPU

Operation: Flags ← EPU

The Flags in the CPU's Flag and Control Word are loaded with information from an EPU on AD lines AD₀-AD₇.

Flags/Registers: The contents of CPU register 0 are undefined after the execution of this instruction.

Execution Time: 14 cycles.

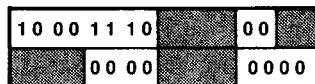

Extended Instruction

Load EPU from FCW

Operation: EPU ← Flags

The Flags in the CPU's Flag and Control Word are transferred to an EPU on AD lines AD₀-AD₇.

Flags/Registers: The flags in the FCW are unaffected by this instruction.

Execution Time: 14 cycles.

10 00 11 10		10	
	00 00		0000

Extended Instruction

Internal EPU Operation

Operation: Internal EPU Operation

The CPU treats this template as a No Op. It is typically used to initiate an internal EPU operation.

Execution Time: 14 cycles.

10 00 11 10		01	

Zillog
Zillog
Zillog
Zillog
Zillog

Chapter 7 Exceptions

7.1 Introduction

The Z8000 CPU supports three types of exceptions (conditions that can alter the normal flow of program execution):

- interrupts
- traps
- reset

Interrupts are asynchronous events typically triggered by peripheral devices needing attention. They cause the processor to temporarily suspend its present program execution in order to service the requesting device. Traps are synchronous events that are responses by the CPU to certain events detected during the

attempted execution of an instruction. Thus, the major distinction between traps and interrupts is their origin: a trap condition is always reproducible by re-executing the program that created the traps, whereas an interrupt is generally independent of the currently executing task. A reset overrides all other conditions, including all interrupts and traps. It occurs when the RESET line is activated, and it causes certain control registers to be initialized. The action that the Z8000 CPU takes in response to an interrupt, trap, or reset is similar; hence, they are treated together in this chapter.

7.2 Interrupts

Three kinds of interrupts are activated by three different pins on the Z8000 CPU. (Interrupt handling for all interrupts is discussed in Section 7.6.)

7.2.1 Non-Maskable Interrupt (NMI).

This type of interrupt cannot be disabled (masked) by software. It is typically reserved for highest-priority external events that require immediate attention.

7.2.2 Vectored Interrupt (VI). One result of any interrupt or trap is that a 16-bit identifier word is pushed onto the system stack (see Section 7.6.2). This word may be used to identify the source of the interrupt or trap. In vectored interrupts, this identifier is also used by the

CPU hardware as a pointer to select a particular interrupt service routine. The processing of vectored interrupts is thus considerably faster than would be the case if a general trap handler had to first examine the identifier, then branch off to the appropriate service routine. These interrupts can be disabled by software.

7.2.3 Nonvectored Interrupts (NVI). These interrupts also result in an identifier word being pushed onto the system stack. However, the CPU does not use the identifier as a vector to select a service routine: all non-vectored interrupts are serviced by the same routine. They can be disabled by software.

7.3 Traps

The Z8001 and Z8002 CPUs support three traps generated internally. The Z8001 supports a fourth trap, which is generated externally (but synchronously) by the Memory Management Unit. Since a trap always occurs when all its defining conditions are present, traps cannot be disabled. (Trap handling operations are discussed in Section 7.6.)

7.3.1 Extended Instruction Trap. This trap occurs when the CPU encounters an extended instruction (see Section 6.2.10) while the EPA bit in the FCW is cleared. This trap allows the program to simulate the operations of the EPU when none is present in the system or to abort the program.

7.3.2 Privileged Instruction Trap. This trap occurs whenever an attempt is made to execute a privileged instruction while the CPU is in system mode (S/N bit in the FCW is cleared).

This trap allows the operating system to detect and prevent operation (such as I/O) that could crash the system.

7.3.3 System Call Trap. This trap occurs whenever a System Call (SC) instruction is executed. It allows an orderly transition to be made between normal mode and system mode.

7.3.4 Segment Trap. This trap occurs whenever the SEGT line is asserted on a Z8001, regardless of the state of the SEG bit in the FCW. This trap is generated by external memory management hardware, such as the Z8010 Memory Management Unit (MMU), and is the result of detecting a memory access violation (such as an offset larger than the assigned segment length) or a write warning (a write into the lowest 256 bytes of a stack). See the *MMU Technical Manual* for more information on memory management hardware.

7.4 Reset

A reset initializes selected control registers of the CPU to system specifiable values. A reset can occur at the end of any clock cycle, provided the $\overline{\text{RESET}}$ line is Low.

A system reset overrides all other considerations, including interrupts, traps, bus requests, and stop requests. A reset should be used to initialize a system as part of the power-up sequence.

Within five clock cycles of the $\overline{\text{RESET}}$ becoming Low, $\text{AD}_0\text{-AD}_{15}$ are 3-stated; $\overline{\text{AS}}$, $\overline{\text{DS}}$, $\overline{\text{MREQ}}$, $\overline{\text{BUSACK}}$, and $\overline{\text{MO}}$ are forced high; $\text{ST}_0\text{-ST}_3$ and $\text{SN}_0\text{-SN}_6$ are forced Low. The $\text{R}/\overline{\text{W}}$, $\text{B}/\overline{\text{W}}$, and $\text{N}/\overline{\text{S}}$ lines are undefined. $\overline{\text{RESET}}$ must be held Low five clock cycles to properly reset the CPU.

7.5 Interrupt Disabling

Vectored and nonvectored interrupts can be enabled or disabled independently via software by setting or clearing appropriate control bits in the Flag and Control Word (FCW). Two control bits in the FCW control the maskable interrupt: VIE and NVIE. When VIE is 1, vectored interrupts are enabled; when NVIE is 1, non-vectored interrupts are enabled. These two flags may be set or cleared together or separately. In addition, these control bits are set when the FCW is loaded. Any control bit

7.6 Interrupt and Trap Handling

The CPU response to a trap or interrupt request consists of five steps: acknowledging the external request (for interrupts and segment traps), saving the old program status information, loading a new program status, executing the service routine, and returning to the interrupted task.

7.6.1 Acknowledge Cycle. An external acknowledge cycle is required only for externally generated requests. As described in Chapter 9, the main effect of such a cycle is to receive from the external device a 16-bit identifier word, which will be saved with the old program status. Before the acknowledge cycle, the CPU enters segmented (Z8001 only) system mode. (The $\text{N}/\overline{\text{S}}$ line indicates that a transition has been made to system mode.) The CPU remains in this mode until it begins to execute the exception service routine, at which time its mode is dictated by the FCW.

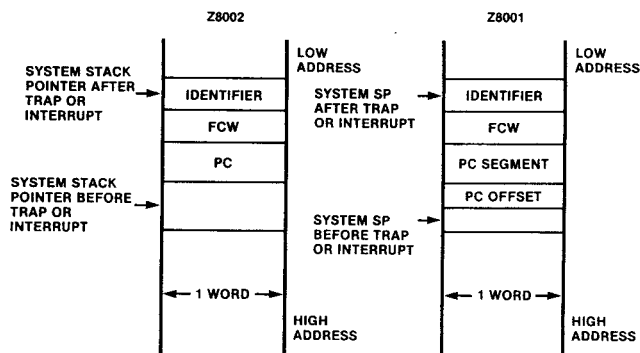

Figure 7-1. Format of Saved Program Status in the System Stack

Three clock cycles after $\overline{\text{RESET}}$ has returned to High, consecutive memory read cycles are executed in system mode to initialize the Program Status registers. In the Z8001, the first cycle reads the Flag and Control Word from location 0002 of segment number 0, the next reads the 7-bit Program Counter segment number from location 0004, the next reads the 16-bit PC offset from location 0006, and the following initial instruction fetch cycle starts the program. In the Z8002, the first cycle reads the PC from location 0004 and the following initial instruction fetch cycle starts the program. Each of these fetches is made from the program address space.

may be changed by the occurrence of an interrupt or trap and then be restored to its previous setting by an Interrupt Return (IRET) instruction.

When a type of interrupt has been disabled, the CPU ignores any interrupt request on the corresponding input pin. Because maskable interrupt requests are not retained by the CPU, the request signal must be asserted until the CPU acknowledges the request.

7.6.2 Status Saving. The old program status information is saved by being pushed on the system stack in the following order: the Program Counter (PC: 16 bits for Z8002; 16-bit offset followed by 7-bit segment number for Z8001); the Flag and Control Word (FCW); and finally, the interrupt/trap identifier word. The identifier word contains the reason or source of the trap or interrupt. For internal traps, the identifier is the first word of the trapped instruction. For segment trap or interrupts, the identifier is the value on the data bus read by the CPU during the interrupt-acknowledge or trap-acknowledge cycle. The format of the saved program status in the system stack is illustrated in Figure 7.1.

The following table shows the PC value that is pushed on the stack for each type of interrupt and trap.

Exception:	PC Value Is Address of:
Extended Instruction Trap	Second Word of Instruction
Privileged Instruction Trap	Next Instruction (Single Word Privileged Instruction)
	Second Word of Instruction (Multiple Word Privileged Instruction)
System Call Trap	Next Instruction
Segment Trap	Next Instruction* †
All Interrupts	Next Instruction†

* Assumes successful completion of instruction fetch

† If executing an interruptable instruction (e.g. LDIR), then the next instruction is the current instruction.

7.6 Interrupt and Trap Handling
(Continued)

7.6.3 Loading New Program Status. After saving the current program status, the new program status (PC and FCW) is automatically loaded from the Program Status Area in system program memory. The particular status words fetched from the Program Status Area are a function of the type of trap or interrupt and (for vectored interrupt) of the interrupt vector. Figure 7.2 shows the format of the Program Status Area.

For each kind of interrupt or trap other than a vectored interrupt, there is a single program status block that is automatically loaded into the Program Status registers (which includes the Flag and Control Word and the Program Counter).

Note that the size of each program status block depends on the version of the Z8000 (two words for the nonsegmented Z8002 and four words for the segmented Z8001).

For all vectored interrupts, the same Flag and Control Word (FCW) is loaded from the corresponding program status block. However, the appropriate Program Counter (PC) value is selected from up to 256 (Z8002) or 128 (Z8001) different values in the Program Status Area.

The low-order eight bits of the identifier placed on the data bus by the interrupting device is multiplied by two and used as an offset into the Program Status Area following the FCW for vectored interrupts. On the Z8002, the identifier value 0 selects the first PC value, the value 1 selects the second PC, and so on up to the identifier value 255. On the Z8001, the identifier value 0 selects the first PC value, the value 2 selects the second PC, and so on up to the identifier value 254, which selects the 128th PC value.

The Program Status Area is addressed by a special control register, the Program Status Area Pointer, or PSAP. This pointer is one word for the nonsegmented Z8002 and two words for the segmented Z8001. As shown in Figure 7.2, the pointer contains a segment number (if applicable) and the high-order byte of a 16-bit offset address. The low-order byte is assumed to contain zeros; thus the Program Status Area must start on a 256-byte address boundary. The programmer accesses the PSAP using the Load Control Register instruction (LDCTL).

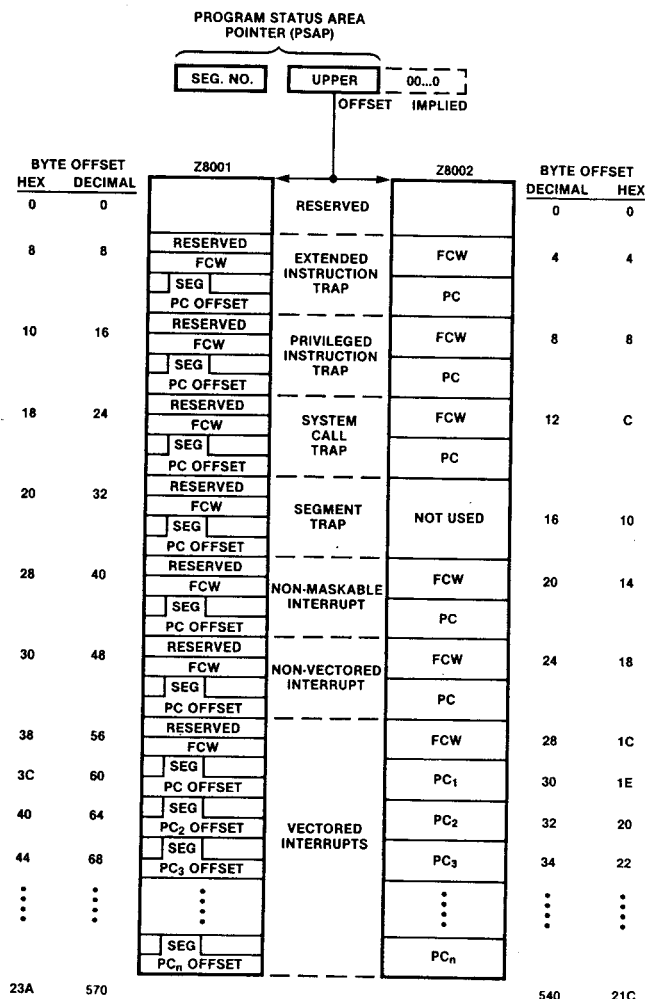

Figure 7-2. Program Status Area

7.6 Interrupt and Trap Handling (Continued)

7.6.4 Executing the Service Routine. Loading the new program status automatically initializes the Program Counter to the starting address of the service routine to process the interrupt or trap. This program is now executed. Because a new FCW was loaded, the maskable interrupts can be disabled for the initial processing of the service routine by a suitable choice of FCW. This allows critical information to be stored before subsequent interrupts are handled. Service routines that enable interrupts before exiting permit interrupts to be handled in a nested fashion.

7.6.5 Returning from an Interrupt or Trap.

Upon completion, the service routine can execute an Interrupt Return instruction, IRET, to

cause execution to continue at the point where the interrupt or trap occurred. IRET causes information to be popped from the system stack in the following order: the identifier is discarded, the saved FCW and PC are restored. The newly loaded FCW takes effect with the next fetched instruction, which is determined by the restored Program Counter.

On Z8001 CPUs, IRET executed in nonsegmented mode mimics the execution of IRET on Z8002 CPUs. Thus, care must be taken on Z8001 CPUs to remove the PC segment number from the system stack before executing IRET in nonsegmented mode.

7.7 Priority

Because it is possible for several exceptions to occur simultaneously, the CPU enforces a priority scheme for deciding which event will be honored first. The following gives the descending priority order:

- *Reset*
- *Internal Trap* (i.e., privileged instruction, system call, extended instruction)
- *Non-Maskable Interrupt*
- *Segment Trap* (Z8001 only)
- *Vectored Interrupt*
- *Nonvectored Interrupt*

This is how the priority system works:

- Whenever a reset is requested, it is immediately performed.
- If several non-reset exceptions occur simultaneously, the one that has the highest priority and is also enabled (traps and non-maskable interrupts are always enabled) is acknowledged, old status is saved, and new status is loaded. The new status consists of the starting address of the service routine (PC) and a new FCW that may disable vectored and nonvectored interrupts.
- If any enabled exceptions remain, the highest-priority one is acknowledged, the old status is saved, and the new status is loaded. Note that in this case, the old status is the PC and FCW of the first exception's service routine.

- This process is repeated until no enabled exceptions remain. At that point, the current PC and FCW will contain the status values for the *lowest priority* exception that was acknowledged.
- The execution of the service routines now proceeds in reverse priority order. That is, the lowest priority exception is serviced first.
- After all the exceptions have been serviced, the original status is restored and execution resumes.

Within each of the classes above, there can be multiple-interrupt sources. The internal traps are mutually exclusive and therefore need no priority resolution within that class. The other types arise from external sources; thus when multiple devices share the same request line, the possibility arises that more than one device may request service from the CPU simultaneously. Either all the interrupt sources must be serviced simultaneously (as with the MMU) or competing requests must be resolved external to the CPU, for example, by means of a daisy-chain or priority interrupt controller. This resolution is done during the interrupt acknowledge cycle.

Zilog
Zilog
Zilog
Zilog
Zilog

Chapter 8 Refresh

8.1 Introduction

The Z8000 CPU has an internal mechanism for refreshing dynamic memory. This mechanism can be activated in two ways:

- When the Refresh Enable (RE) bit in the CPU Refresh Counter is set to one (Figure 8.1), memory refresh is performed periodically at a rate specified by the RATE field in the counter. (See Section 8.3.)

- When the $\overline{\text{STOP}}$ line is activated, the CPU generates memory refreshes continuously. (See Section 8.4.)

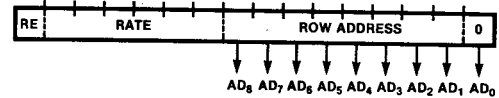

Figure 8-1. Refresh Control Register

8.2 Refresh Cycles

The refresh mechanism is a way of generating a special kind of bus transaction called a *refresh cycle*, which is described in Chapter 9. A refresh cycle is three clock cycles long and may be inserted immediately after the last clock cycle of any transaction.

During a refresh cycle, the status lines are set to 0001 and the address lines AD_0 - AD_8 are

undefined. The ROW value determines the memory row that is being refreshed on this cycle. Since memory is word-organized, AD_0 is always zero. After the refresh cycle is complete, the ROW field is incremented by two, thus stepping through 256 rows.

8.3 Periodic Refresh

The Refresh Enable (RE) bit controls only Periodic Refresh; refresh cycles may be generated using the $\overline{\text{STOP}}$ line, regardless of the state of RE. When RE is set to one, the value of the 6-bit RATE field determines the time between successive refreshes (the refresh period). When $\text{RATE} = 0$, the refresh period is 256 clock cycles; when $\text{RATE} = n$, the refresh period is $4n$ clock cycles. (Thus, if there is a 4 MHz clock, the refresh period can be from 1 μs to 64 μs .)

The LDCTL instruction is used to set the refresh rate, to set or clear RE, or to initialize or read the ROW field. (See Section 6.7 for a detailed discussion of this instruction.)

The refresh cycle is generated as soon as possible after the refresh period has elapsed. This usually means after the last clock cycle of the next transaction. If the CPU receives a trap

or an interrupt simultaneously with a Periodic Refresh request, the refresh operation is performed first.

When the CPU does not have control of the bus (that is, when $\overline{\text{BUSACK}}$ is asserted and the CPU enters Bus-Disconnect state) or when the $\overline{\text{WAIT}}$ line is activated, the CPU cannot issue refresh cycles. To deal with this situation, both Z8000 CPUs have internal circuitry that records when the refresh period has elapsed and refresh cycles cannot be generated. When the CPU regains control of the bus, or when the $\overline{\text{WAIT}}$ line is reactivated, it immediately issues the skipped refresh cycles. The internal circuitry can record up to two such skipped refresh operations.

After a reset operation, Periodic Refresh is disabled (RE is cleared) and the internal circuitry that counts skipped refreshes is cleared.

8.4 Stop-State Refresh

The CPU has three internal operating states: Running, Stop, and Bus-Disconnect states (see Section 2.8). Stop state is entered when the $\overline{\text{STOP}}$ line is activated, and while the CPU is in this state, it generates three clock cycle

refresh transactions continuously. When $\overline{\text{STOP}}$ is found High again, one more refresh cycle is performed, then the remaining clock cycles of the instruction fetch are executed. (See Appendix A for more timing information.)

Zillog
Zillog
Zillog
Zillog
Zillog

9.3 CPU Pins

The CPU pins can be grouped into five categories according to their functions (Figure 9.1).

9.3.1 Transaction Pins. These signals provide timing, control, and data transfer for Z-Bus transactions.

AD₀-AD₁₅. *Address/Data (Output, active High, 3-state).* These multiplexed data and address lines carry I/O addresses, memory addresses, and data during Z-Bus transactions. For the Z8001, only the offset portion of memory addresses is carried on these lines.

SN₀-SN₇. *Segment Number (Z8001 only, Output, active High, 3-state).* These lines contain the segment number portion of a memory address.

ST₀-ST₃. *(Output, active, High, 3-state).* These lines indicate the kind of transaction occurring on the bus and give additional information about the transaction (such as the address space for memory transactions).

AS. *Address Strobe (Output, active Low, 3-state).* The rising edge of AS indicates the beginning of a transaction and shows that the Address, ST₀-ST₃, N \bar{S} , R \bar{W} , and B \bar{W} signals are valid.

DS. *Data Strobe (Output, active Low, 3-state).* DS provides timing for data movement to or from the CPU.

R \bar{W} . *Read/Write (Output, Low = Write, 3-state).* This signal determines the direction of data transfer for memory, I/O, or EPU transfer transactions.

B \bar{W} . *Byte/Word (Output, Low = Word, 3-state).* This signal indicates whether a byte or word of data is to be transmitted during a transaction.

WAIT. *(Input, active Low).* A Low on this line indicates that the responding device needs more time to complete a transaction.

MREQ. *Memory Request (Output, active Low, 3-state).* A falling edge on this line indicates that the address/data bus is holding a memory address.

9.3.2 Bus Control Pins. These pins carry signals for requesting and obtaining control of the bus from the CPU.

BUSREQ. *Bus Request (Input, active Low).* A Low indicates that a bus requester has obtained or is trying to obtain control of the bus.

BUSACK. *Bus Acknowledge (Output, active Low).* A Low on this line indicates that the CPU has relinquished control of the bus in response to a bus request.

9.3.3 Interrupt/Trap Pins. These pins convey interrupt and external trap requests to the CPU.

NMI. *Non-Maskable Interrupt (Input, active Low).* A High-to-Low transition on \bar{NMI} requests a non-maskable interrupt.

NVI. *Non-Vectored Interrupt (Input, active Low).* A Low on this line requests a non-vectored interrupt.

VI. *Vectored Interrupt (Input, active Low).* A Low on this line requests a vectored interrupt.

SEGT. *Segment Trap (Z8001 only, Input, active Low).* A Low on this line requests a segment trap.

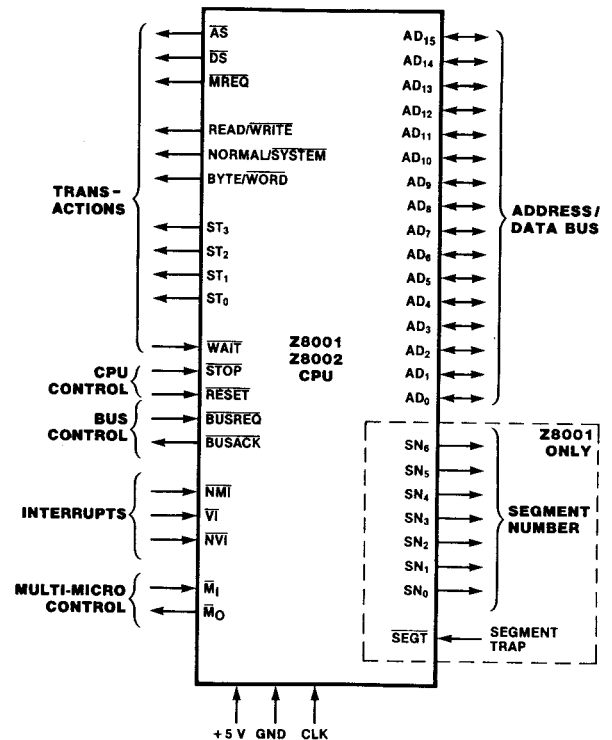

Figure 9-1. Pin Functions

9-3. CPU Pins
(Continued)

9.3.4 Multi-Micro Pins. These pins are the Z8000's interface to the Z-Bus resource request lines.

MI. Multi-Micro In (Input, active Low). This input is used to sample the state of the resource request lines.

MO. Multi-Micro Out (Output, active Low). This line is used by the CPU to make resource requests.

9.3.5 CPU Control. These pins carry signals which control the overall operation of the CPU.

STOP. (Input, active Low). This line is used to suspend CPU operation during the fetch of the first word of an instruction.

RESET. (Input, active Low). A Low on this line resets the CPU.

9.4 Transactions

Data transfers to and from the CPU are accomplished through the use of transactions. Figure 9.2 shows the general timing for a transaction.

All transactions start with Address Strobe (\overline{AS}) being driven Low and then raised High by the CPU. On the rising edge of \overline{AS} , the status lines ST_0 - ST_3 are valid; these lines indi-

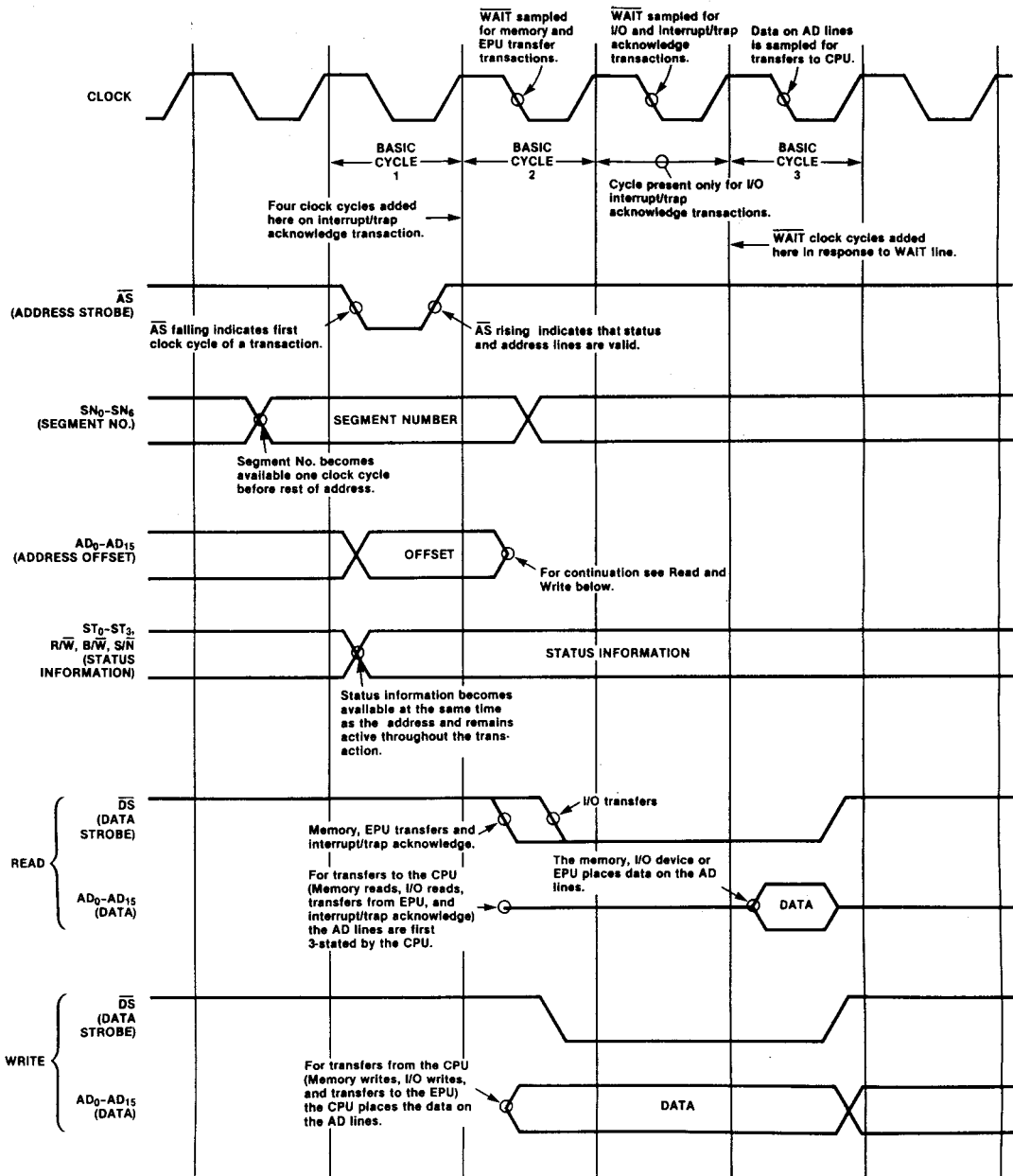

Figure 9-2. Transaction Timing

9-4. Transactions
(Continued)

cate the type of transaction being initiated (see Table 9.1; the six types of transactions are discussed in the sections that follow.) Associated with the status lines are three other lines that become valid at this time. These are Normal/System (N/\bar{S}), Read/Write (R/\bar{W}), and Byte/Word (B/\bar{W}). Except where indicated below, N/\bar{S} designates the operating mode of the CPU, R/\bar{W} designates the direction of data transfer (read to the CPU, write from the CPU), and B/\bar{W} designates the length of the data item being transferred.

If the transaction requires an address, it too is valid on the rising edge of \bar{AS} . No address is required for interrupt acknowledge, EPU transfer, or internal operation transactions. (In the Z8001, the segment number lines SN_0 - SN_6 are valid one clock cycle earlier to allow for external memory management hardware. See Chapter 2 for more information.)

The CPU uses Data Strobe (\bar{DS}) to time the actual data transfer. (Note that refresh and internal operation transactions do not transfer any data and thus do not activate \bar{DS} .) For write operations ($R/\bar{W} = \text{Low}$), a Low on \bar{DS} indicates that valid data from the bus master is on the AD_0 - AD_{15} lines. For read operations ($R/\bar{W} = \text{High}$), the bus master makes AD_0 - AD_{15} 3-state before driving \bar{DS} Low so that the addressed device can put its data on the bus. The bus master samples this data on the falling clock edge just before raising \bar{DS} High.

9.4.1 WAIT. As shown in Figure 9.2, \overline{WAIT} is sampled on a falling clock edge one cycle before data is sampled by the CPU (Read) or \bar{DS} rises (Read or Write). If \overline{WAIT} is Low, another cycle is added to the transaction before data is sampled or \bar{DS} rises. In this added cycle and all subsequent cycles added due to \overline{WAIT} being Low, \overline{WAIT} is again sampled on the falling edge and, if it is Low, another cycle is added to the transaction. In this way, the transaction can be extended to an arbitrary length to accommodate (for example) slow memories or I/O devices that are not yet ready for data transfer.

It must be emphasized that the \overline{WAIT} input is synchronous. Thus, it must meet the setup and hold times given in Appendix A in order for the CPU to function correctly. This requires asynchronously generated \overline{WAIT} signals to be synchronized before they are input into the CPU.

9.4.2 Memory Transactions. Memory Transactions move data to or from memory when the CPU makes a memory access. Thus, they are generated during program execution to fetch instructions from memory (Chapter 4) and to fetch and store memory data (Chapter 5). They are also generated to store old program status and fetch new program status during interrupt and trap handling and after reset (Chapter 7).

As shown in Figure 9.3, a memory transaction is three clock cycles long unless

Kind of Transaction	ST ₃ -ST ₀	Additional Information
Internal Operation	0000	
Refresh	0001	
I/O Transaction	{ 0010 0011	Standard I/O Special I/O
Interrupt Acknowledge Transaction	{ 0100 0101 0110 0111	Segment Trap Non-Maskable Interrupt Non-Vectored Interrupt Vectored Interrupt
Memory Transaction	{ 1000 1001 1010 1011 1100 1101	Data Address Space Stack Address Space, Data Address Space, EPU Transfer Stack Address Space, EPU Transfer Program Address Space, Program Address Space, First Word of Instruction
EPU Transfer	1110	
Reserved	1111	

Table 9-1. Status Codes

9-4. Transactions
(Continued)

extended as explained above in **WAIT**. The status pins, besides indicating a memory transaction, give the following information:

- Whether the memory access is to the data (1000, 1010), stack (1001, 1011), or program (1100, 1101) address space (Chapter 3).
- Whether the first word of an instruction is being fetched (1101).
- Whether the data for the access is to be supplied (write) or captured (read) by an Extended Processing Unit (1010, 1011).

Status codes 1000 and 1001 may also indicate that the EPU is to capture or supply the data.

For the Z8002, the full memory address will be on AD₀-AD₁₅ when \overline{AS} rises. For the Z8001, the offset portion of the segmented address will be on AD₀-AD₁₅ and the segment number portion will be on SN₀-SN₆ when \overline{AS} rises. The segment portion will also be on SN₀-SN₆ approximately one cycle before AD₀-AD₁₅ is valid.

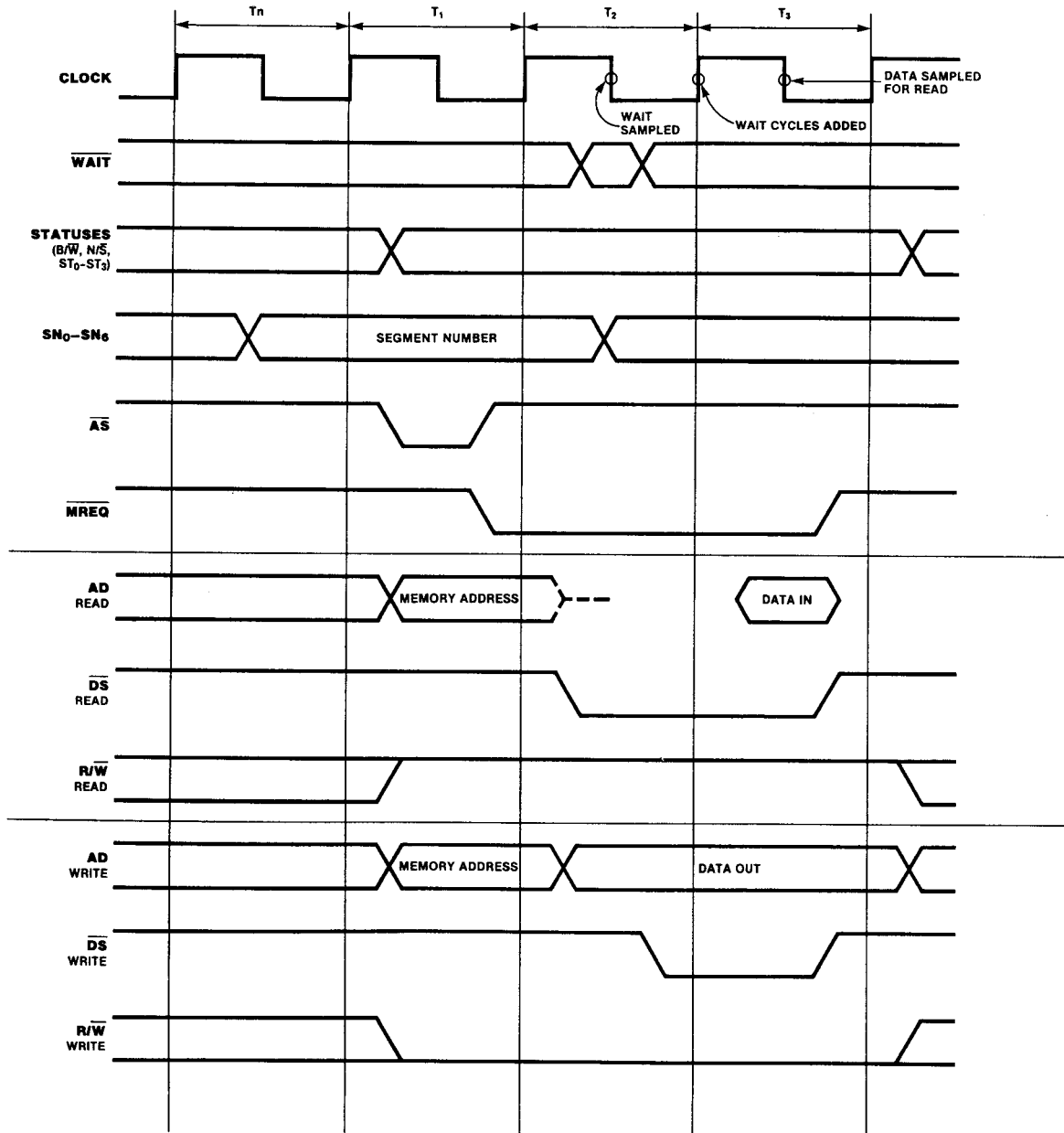

Figure 9-3. Memory Read and Write Transaction

9-4. Transactions
(Continued)

Bytes transferred to or from odd memory (address bit 0 is 1) locations are always transmitted on lines AD₀-AD₇ (bit 0 on AD₀). Bytes transferred to or from even memory locations (address bit 0 is 0) are always transmitted on lines AD₈-AD₁₅ (bits 0 on AD₈). Thus, the memory attached to a Z8000 will look like that shown in Figure 9.4. For byte reads (B/ \overline{W} High, R/ \overline{W} High) the CPU uses only the byte whose address it output. For byte writes (B/ \overline{W} High, R/ \overline{W} Low), the memory should store only the byte whose address was output by the CPU. For word transfers, (B/ \overline{W} = Low), all 16 bits are captured by the CPU (Read: R/ \overline{W} = High) or stored by the memory (Write: R/ \overline{W} = Low).

As explained more fully in Section 9.5, a Z8001 CPU and an Extended Processing Unit act like a single CPU with the CPU providing addresses, status and timing information and the EPU providing or capturing data.

9.4.3 I/O Transactions. I/O transactions move data to or from peripherals or CPU support devices (e.g., MMUs). They are generated during the execution of I/O instructions.

As shown in Figure 9.5, I/O transactions are four clock cycles long at minimum, and they

may be lengthened by the addition of WAIT cycles. The extra clock cycles allow for slower peripheral operation.

The status lines indicate whether the access is to the Standard I/O (0010) or Special I/O (0011) Address Spaces. The $\overline{N/S}$ line is always Low, indicating system mode. The I/O address is found on AD₀-AD₁₅ when \overline{AS} rises. Since the I/O address is always 16 bits long, the segment number lines are undefined on Z8001 CPUs. For byte transfers (B/ \overline{W} = High) in Standard I/O space, addresses must be odd; for byte transfers in Special I/O space, addresses must be even.

Word data (B/ \overline{W} = Low) to or from the CPU is transmitted on AD₀-AD₁₅. Byte data (B/ \overline{W} = High) is transmitted on AD₀-AD₇ for Standard I/O and on AD₈-AD₁₅ for Special I/O. This allows peripheral devices or CPU support devices to attach to only eight of the 16 AD₀-AD₁₅ lines. The Read/Write line (R/ \overline{W}) indicates the direction of the data transfer: peripheral-to-CPU (Read: R/ \overline{W} = High) or CPU-to-peripheral (Write: R/ \overline{W} = Low).

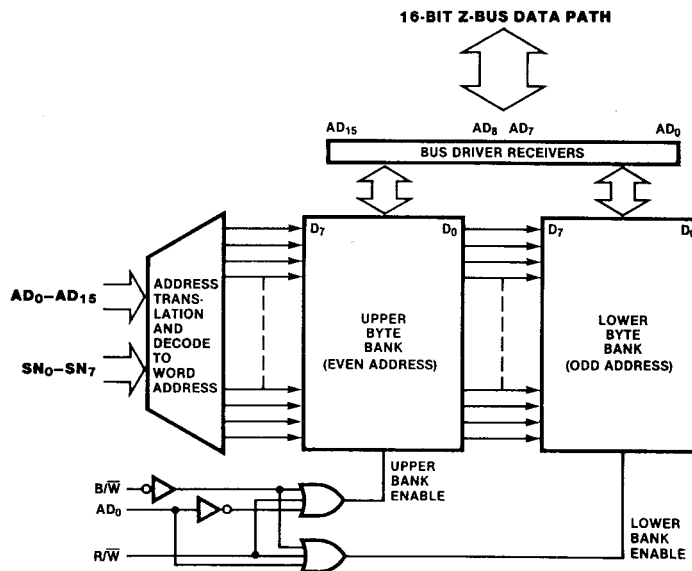

Figure 9-4. Memory Organization

9-4. Transactions
(Continued)

9.4.4 EPU Transfer Transactions. These transactions move data between the CPU and an Extended Processing Unit (EPU), thus allowing the CPU to transfer data to or from an EPU or to read or write an EPU's Status Registers. They are generated during the execution of the EPA instruction.

EPU transfer transactions have the same form as memory transactions (Figure 9.3) and thus are three clock cycles long, unless extended by $\overline{\text{WAIT}}$. No address is generated, and there is only one status code that can be used on the $\text{ST}_0\text{-ST}_3$ lines (1110). In a multiple

EPU system, the EPU which is to participate in a transaction is selected implicitly, as described in Section 9.5, rather than by an address.

The data transferred is 16-bit words ($\text{B}/\overline{\text{W}} = \text{Low}$), except for transfers between the Flags byte of the FCW and an EPU. In this case, a byte of data is transferred on $\text{AD}_0\text{-AD}_7$ ($\text{B}/\overline{\text{W}} = \text{High}$). The Read/Write line ($\text{R}/\overline{\text{W}}$) indicates the direction of the data transfer. The $\text{N}/\overline{\text{S}}$ line indicates either system mode (Low) or normal mode (High).

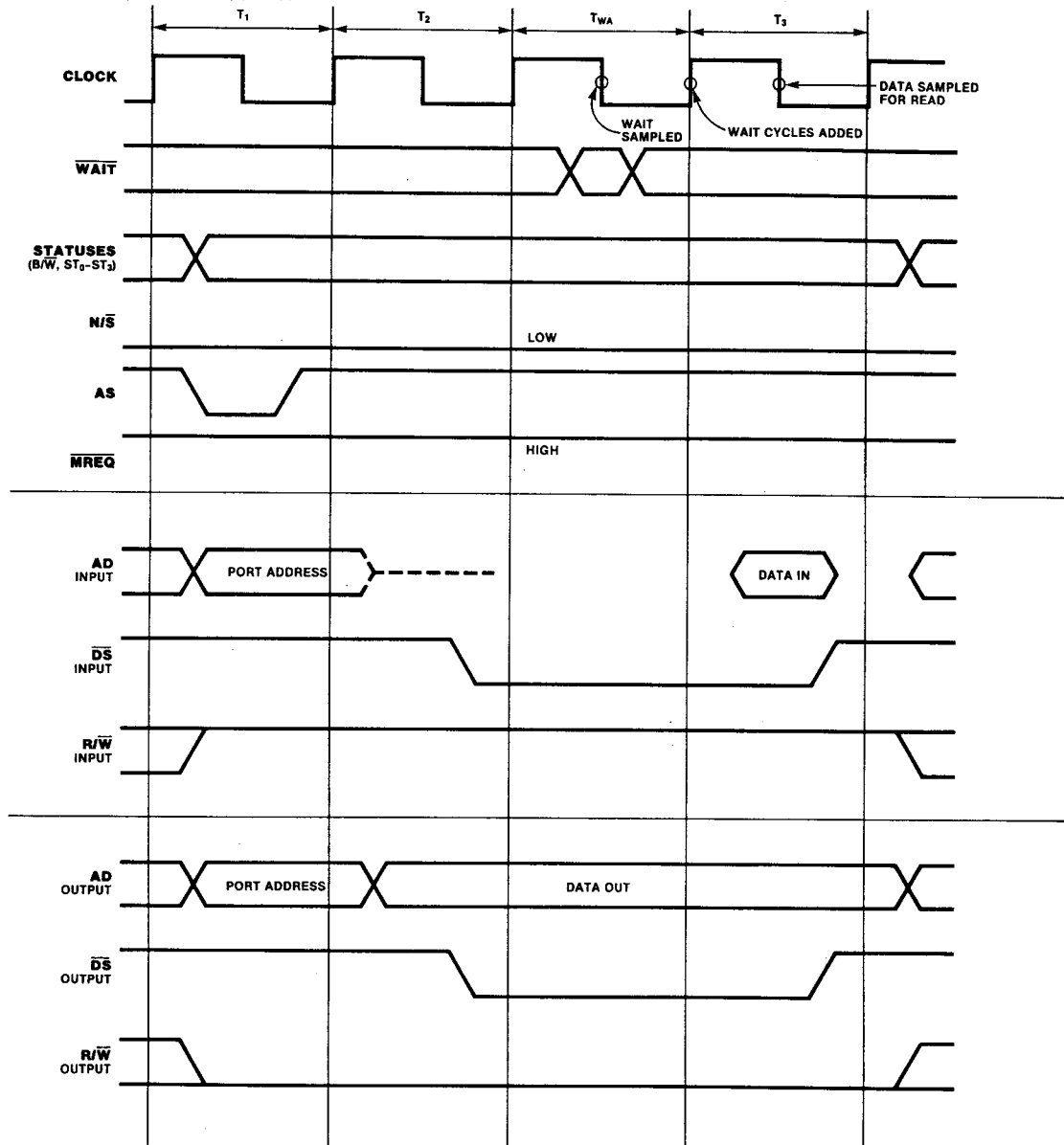

Figure 9-5. Input/Output Transaction

9.4. Transactions
(Continued)

9.4.5 Interrupt/Trap Acknowledge Transactions. These transactions acknowledge an interrupt or trap and read a 16-bit identifier word from the device that generated the interrupt or trap. The transactions are generated automatically by the hardware when an interrupt or segment trap is detected.

These transactions are eight clock cycles long at a minimum (as shown in Figure 9-6), having five automatic WAIT cycles. The WAIT cycles are used to give the interrupt priority daisy chain (or other priority resolution device) time to settle before the identifier word is read. (Consult the *Z-Bus Summary* for more information on the operation of the priority daisy-chain).

The status lines identify the type of exception that is being acknowledged. The possibilities are Segment Trap (0100), Non-Maskable Interrupt (0101), Non-Vectored Interrupt (0110), and Vectored Interrupt (0111). No address is generated. The $\overline{N/S}$ line indicates

System mode (Low), the R/\overline{W} line indicated Read (High), and the B/\overline{W} line indicates Word (Low).

The only item of data transferred is the identifier word, which is always 16 bits long and is captured from the AD_0-AD_{15} lines on the falling clock edge just before \overline{DS} is raised High.

As shown in Figure 9-6, there are two places where \overline{WAIT} is sampled, and thus a \overline{WAIT} cycle may be inserted. The first serves to delay the falling edge of \overline{DS} to allow the daisy chain a longer time to settle, and the second serves to delay the point at which data is read.

9.4.6 Internal Operations and Refresh Transactions. There are two kinds of bus transactions made by the CPU that do not transfer data: internal operations and memory refresh. Both transactions look like a memory transaction, except that Data Strobe remains High and no data is transferred.

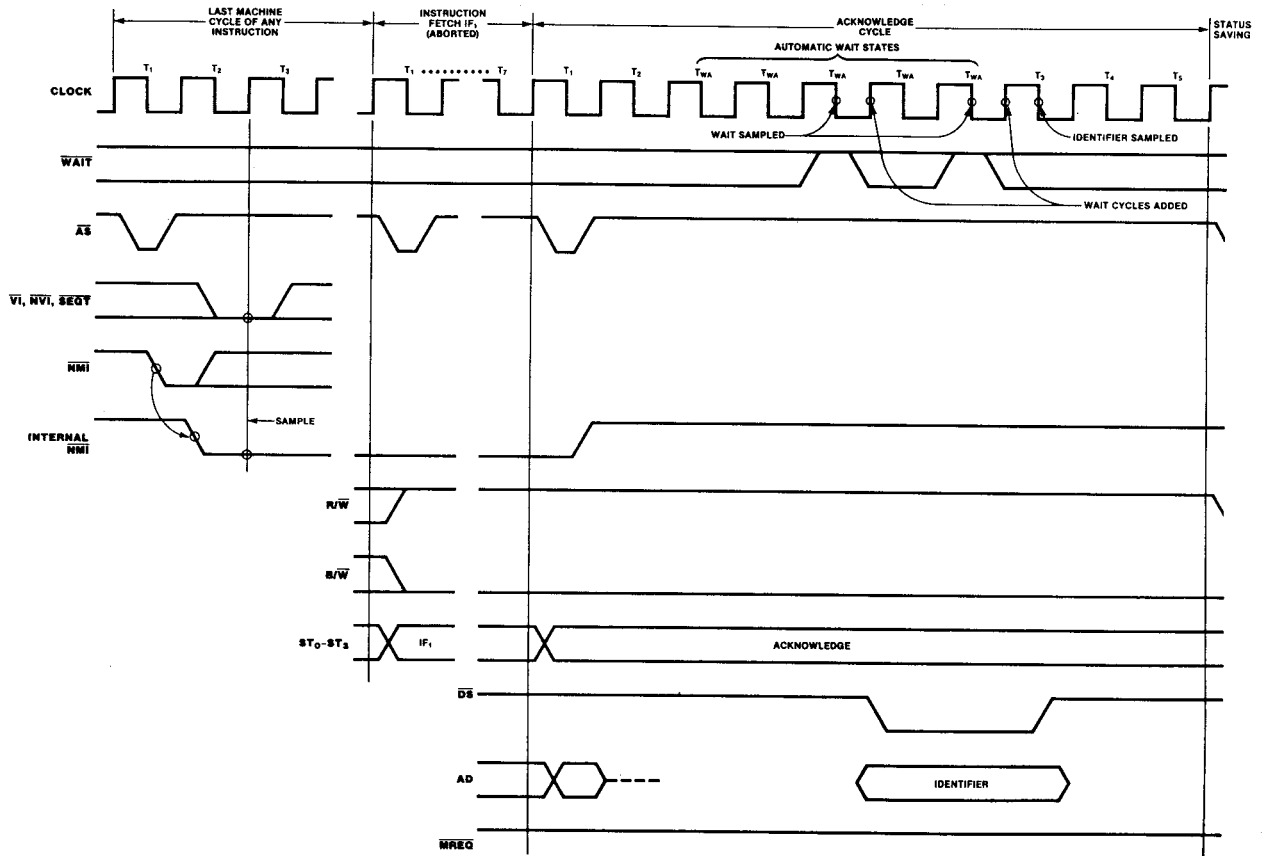

Figure 9-6. Interrupt and Segment Trap Request and Acknowledge Transition.

9-4. Transactions
(Continued)

For internal operation transaction (shown in Figure 9.7), the Address and Segment Number lines contain arbitrary data when the Address Strobe goes High. The R/\overline{W} line indicates Read (High); the B/\overline{W} line is undefined, and N/\overline{S} is the same as for the immediately preceding transaction. This transaction is initiated to maintain a minimum transaction rate while the CPU is doing a long internal operation.

A memory refresh transaction (shown in Figure 9.8) is generated by the Z8000 CPU's

refresh mechanism as described in Chapter 8 and can come immediately after the final clock cycle of any other transaction. The memory refresh counter's 9-bit ROW field is output on AD_0-AD_8 during the normal time for addresses. This transaction can be used to generate refreshes for dynamic RAMs. The value of N/\overline{S} , R/\overline{W} , and B/\overline{W} is the same as for the immediately preceding transaction.

\overline{WAIT} is not sampled during internal operation or refresh cycles.

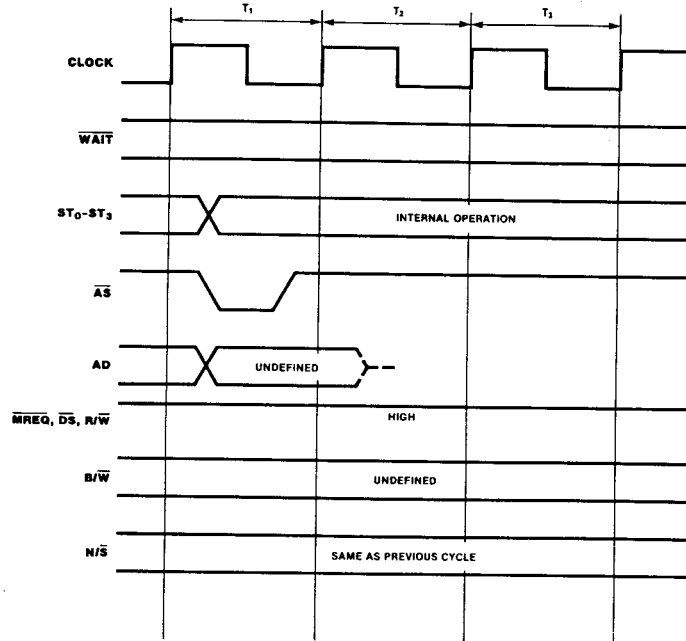

Figure 9-7. Internal Operation Timing

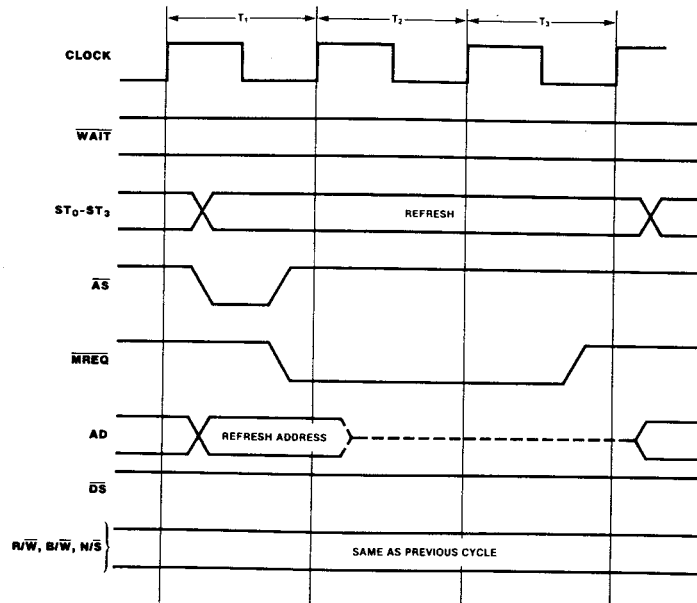

Figure 9-8. Memory Refresh Timing

9.5 CPU and Extended Processing Unit Interaction

A Z8000 CPU and one or more Extended Processing Units (EPUs) work together like a single CPU component, with the CPU providing address, status and timing signals and the EPU supplying and capturing data. The EPU monitors the status and timing signals output by the CPU so that it will know when to participate in a memory or EPU transfer transaction. When the EPU is to participate in a memory transaction, the CPU puts its AD lines in 3-state while \overline{DS} is Low, so that the EPU may use them.

In order to know which transaction it is to participate in, the EPU must track the following sequence of events:

- When the CPU fetches the first word of an instruction ($ST_3-ST_0 = 1101$), the EPU must also capture the instruction returned by memory. If the instruction is an extended instruction, it will have an ID field which indicates (along with the second instruction) whether or not the EPU is to execute the instruction.
- If the instruction is to be executed by the EPU, the next non-refresh transaction by the CPU will fetch the second word on the instruction ($ST_3-ST_0 = 1100$). The EPU must also capture this word.
- If the first word of the instruction indicates the immediate addressing mode, the next one to 16 non-refresh transactions by the CPU will fetch the immediate data ($ST_3-ST_0 = 1100$, $R/\overline{W} = \text{High}$, $B/\overline{W} = \text{Low}$) one word at a time.
- If the instruction involves a read or write to memory, there will be zero or more program fetches by the CPU ($ST_3-ST_0 = 1100$) to obtain the address portion of the extended instruction. The next one to 16 non-refresh transactions by the CPU will transfer data between memory and the EPU ($ST_3-ST_0 = 1000, 1001, 1010, \text{ or } 1011$). The

EPU must supply the data (Write, R/\overline{W} Low) or capture the data (Read, R/\overline{W} High) for each transaction, just as if it were part of the CPU. In both cases, the CPU will 3-state its AD lines while data is being transferred (\overline{DS} Low). EPU memory transfers are always word-oriented (B/\overline{W} Low).

- If the instruction involves a transfer between the CPU and EPU, the next one to 16 non-refresh transactions by the CPU will transfer data between the EPU and CPU ($ST_3-ST_0 = 1110$).

Note that in order to follow this sequence, an EPU will have to monitor the \overline{BUSACK} line to verify that the transaction it is monitoring on the bus was generated by the CPU. It should also be noted that in a multiple EPU system, there is no indication on the bus as to which EPU is cooperating with the CPU at any given time. This must be determined by the EPUs from the extended instructions they capture.

A final aspect of CPU-EPU interaction is the use of the CPU's \overline{STOP} pin. When an EPU begins to execute an extended instruction, the CPU can continue fetching and executing instructions. If the CPU fetches another extended instruction before the first one has completed execution, the EPU must activate the CPU's \overline{STOP} pin to stop the CPU (as described in Section 9.7) until the instruction completes execution.

Besides determining whether or not to participate in the execution of an EPA instruction, the EPU must determine from the first two instruction words

- Whether or not a memory access will be made and how many words of instruction will be fetched before the data is transferred.
- The number of words of data to be transferred for memory or EPU-CPU transfers.

9.6 Requests

There are three kinds of request signals that the Z-Bus supports and the Z8000 CPU participates in. These are

- *Interrupt/Trap requests*, which another device initiates and the CPU accepts and acknowledges.
- *Bus requests*, which another potential bus master initiates and the CPU accepts and acknowledges.
- *Resource requests*, which any device capable of implementing the request protocol (usually the CPU) can request. No component has control of the resource by default.

The CPU supports an additional request beyond those of the Z-Bus:

- *Stop request*, which another device initiates and the CPU accepts.

When a request is made, it is answered according to its type: for interrupt/trap requests, an interrupt/trap acknowledge transaction is initiated (Section 9.4.4); for bus requests, an acknowledge signal is sent (Sections 9.6.2 and 9.6.3); for Stop request, the CPU enters the Stop/Refresh state. In all cases except Stop, the Z-Bus provides for a daisy-chain priority mechanism to arbitrate between simultaneous requests.

9-6. Requests
(Continued)

9.6.1 Interrupt/Trap Request. The Z8000 CPU supports three interrupts and one external trap (segment trap) as shown in Figure 9.6. The Interrupt Request line ($\overline{\text{INT}}$) of a device that is capable of generating an interrupt may be tied to any of the three Z8000 interrupt pins ($\overline{\text{NMI}}$, $\overline{\text{NVI}}$, $\overline{\text{VI}}$). Several devices can be connected to one pin, the devices arranged in a priority daisy chain (see the *Z-Bus Summary*). The segment trap pin ($\overline{\text{SEGT}}$) is activated by the memory management hardware. The CPU uses the same protocol for handling requests on any of these pins. Here is the sequence of events that is followed:

- Any High-to-Low transition on the $\overline{\text{NMI}}$ input is asynchronously edge-detected, and the internal $\overline{\text{NMI}}$ latch is set. At the beginning of the last clock cycle in the last machine cycle of any instruction, the $\overline{\text{VI}}$, $\overline{\text{NVI}}$, and $\overline{\text{SEGT}}$ inputs are sampled along with the state of the internal $\overline{\text{NMI}}$ latch.
- If an interrupt or trap is detected, the subsequent initial instruction fetch cycle is exercised, but aborted. (Thus, $\overline{\text{AS}}$ falls and rises, but $\overline{\text{DS}}$ does not.)

- The next machine cycle is the interrupt acknowledge transaction (see Section 9.4.4) that results in an identifier word from the highest-priority interrupting device being read off the AD lines.
- This word, along with the program status information, is stored on the system stack, and new status information is loaded (see Chapter 7).

For more information about the system-level aspects of the interrupt structure, consult the *Z-Bus Summary*.

9.6.2 Bus Request. To generate transactions on the bus, a potential bus master (such as the DMA Controller) must gain control of the bus by making a bus request (shown in Figure 9.9). A bus request is initiated by pulling $\overline{\text{BUSREQ}}$ Low. Several bus requesters may be wired to the $\overline{\text{BUSREQ}}$ pin; priorities are resolved externally to the CPU, usually by a priority daisy chain (see the *Z-Bus Summary*).

The asynchronous $\overline{\text{BUSREQ}}$ signal generates an internal $\overline{\text{BUSREQ}}$, which is synchronous. If the external $\overline{\text{BUSREQ}}$ is Low at the beginning

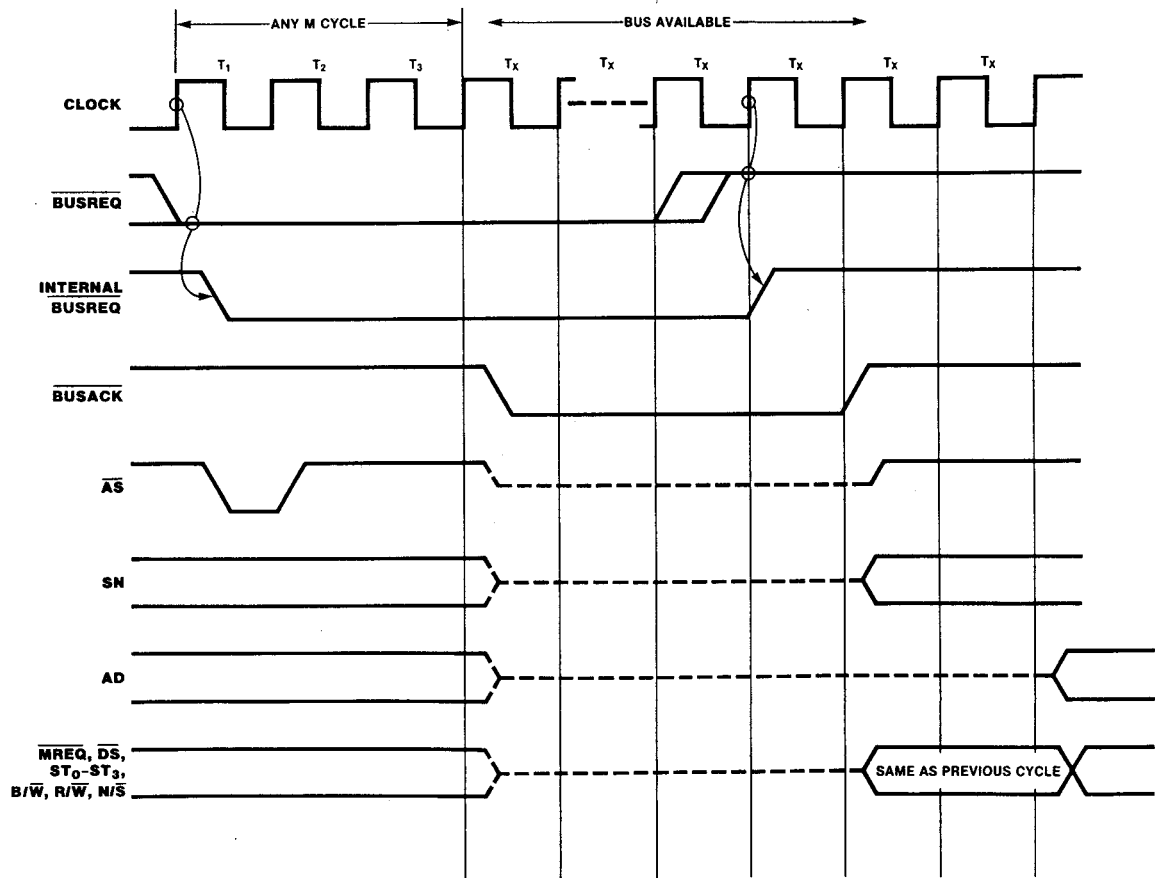

Figure 9-9. Bus Request/Acknowledge Timing

9.6. Requests
(Continued)

of any machine cycle, the internal $\overline{\text{BUSREQ}}$ will cause the bus acknowledge line ($\overline{\text{BUSACK}}$) to be asserted after the current machine cycle is completed. The CPU then enters Bus-Disconnect state and gives up control of the bus. All CPU Output pins, except $\overline{\text{BUSREQ}}$ and $\overline{\text{MO}}$, are 3-stated.

The CPU regains control of the bus two clock cycles after $\overline{\text{BUSREQ}}$ rises. Any device desiring control of the bus must wait at least two cycles after $\overline{\text{BUSREQ}}$ has risen before pulling it down again.

9.6.3 Resource Request. The CPU generates resource requests by executing the Multi-Micro Request (MREQ) instruction. The CPU tests the availability of the shared resource by examining $\overline{\text{MI}}$. If $\overline{\text{MI}}$ is High, the resource is available, otherwise the CPU must try again later. The $\overline{\text{MO}}$ pin is used to make the resource request. $\overline{\text{MO}}$ is pulled Low, then, after a delay

for arbitration of priority, $\overline{\text{MI}}$ is tested again. If it is Low, the CPU has control of the resource; if it is still High, the request was not granted. In the case of failure, $\overline{\text{MO}}$ must be deactivated. But if successful, $\overline{\text{MO}}$ must be kept active until the CPU is ready to release the resource whereupon $\overline{\text{MO}}$ is deactivated by an MRES instruction.

The Z-Bus Summary describes an arbitration scheme that is implemented with a resource request daisy chain.

9.6.4 Stop Request. As shown in Figure 9-10, the $\overline{\text{STOP}}$ pin is normally sampled on the falling clock edge immediately preceding an initial instruction fetch cycle. If $\overline{\text{STOP}}$ is found Low, the CPU enters Stop/Refresh state and a stream of memory refresh cycles is inserted after the third clock cycle in the instruction fetch. The ROW field in the Refresh Counter is incremented by two after every refresh cycle.

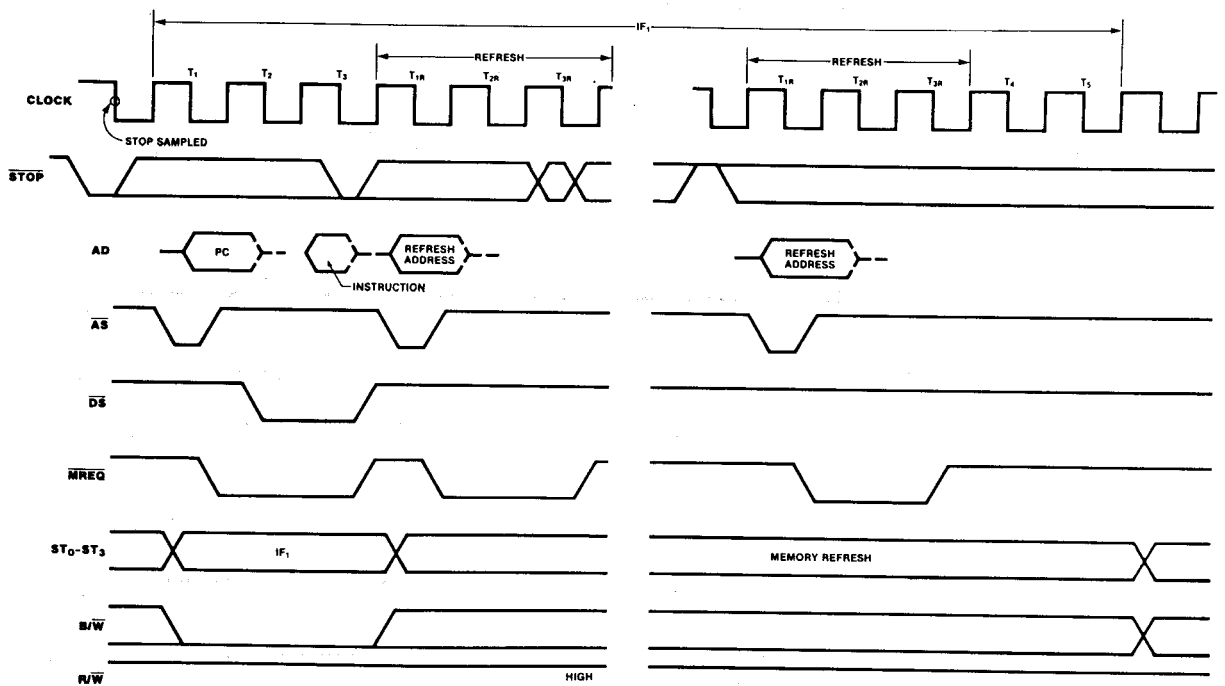

Figure 9-10. Stop Timing

9-6. Requests
(Continued)

When \overline{STOP} is found High again, the next refresh cycle is completed, then the original instruction fetch continues.

If the EPA bit in the FCW is set (indicating an EPU is in the system), the \overline{STOP} line is also sampled on the on the falling clock edge immediately preceding the second word of an

instruction fetch—if the first word indicates an extended instruction. Thus, the \overline{STOP} line may be used by an EPU to deactivate the CPU whenever the CPU fetches an extended instruction before the EPU has finished processing an earlier one. The \overline{STOP} line may also be used to externally single-step the CPU.

9.7 Reset

A hardware reset puts the Z8000 in a known state and initializes selected control registers of the CPU to system specifiable values (as described in Chapter 7). A reset will begin at the end of any clock cycle, if the \overline{RESET} line is low.

A system reset overrides all other operations of the chip, including interrupts, traps, bus requests and stop requests. A reset should be used to initialize a system as part of the power-up sequence.

Within five clock cycles of the \overline{RESET} line becoming low (Figure 9-11) AD_0-AD_{15} are

3-stated; \overline{AS} , \overline{DS} , \overline{MREQ} , \overline{BUSACK} , and \overline{MO} are forced High; and ST_0-ST_3 and SN_0-SN_6 are forced low. The R/\overline{W} , B/\overline{W} and N/\overline{S} lines are undefined. Reset must be held low at least five clock cycles.

After \overline{RESET} has returned High for three clock cycles, consecutive memory-read transactions are executed in the system mode to initialize the Program Status Registers. These correspond to the memory accesses described in Chapter 7.

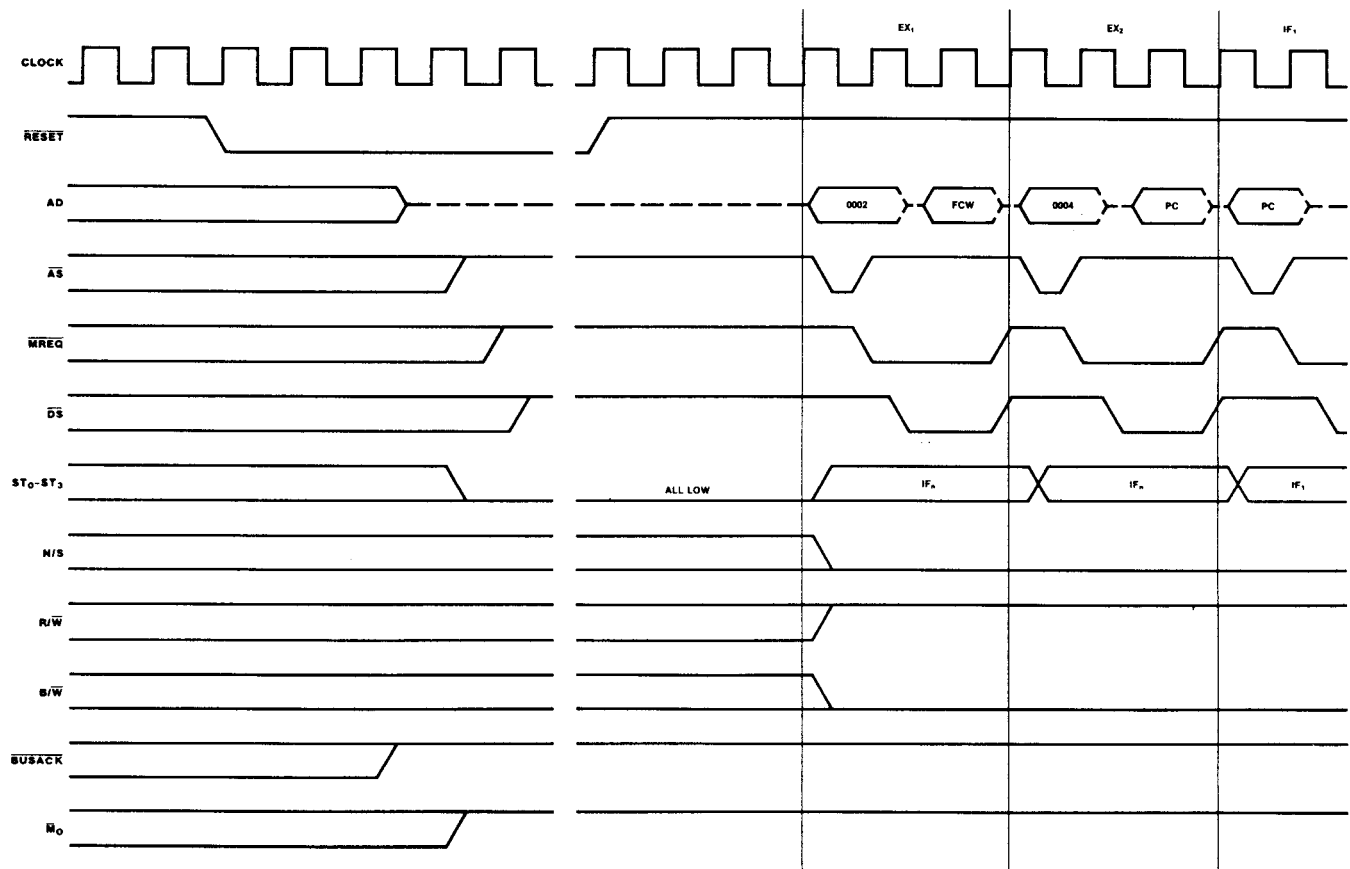

Figure 9-11. Reset Timing