

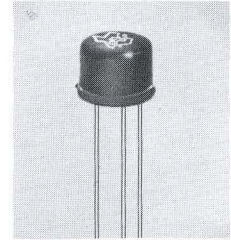

N-P-N DOUBLE-DIFFUSED SILICON MESA TRANSISTOR

High-Speed Medium Power Transistor

- 2 Watts at 25°C case temperature
- Beta 20 to 60
- 10-ohm saturation resistance (max)



TYPE 2N696
BULLETIN NO. DLS-1146 SEPTEMBER 1959

environmental tests

Each unit is heat cycled from -65°C to +175°C for ten cycles. A rigorous tumbling test subjects each unit to 12 mechanical shocks of up to 500 G's to ensure mechanical reliability. Each unit is thoroughly tested to determine the electrical characteristics. Production samples are life tested at regularly scheduled periods to ensure maximum reliability under extreme operating conditions.

mechanical data

The transistor is in a JEDEC TO-5 hermetically sealed, welded package with glass-to-metal hermetic seal between case and leads. Approximate weight is 1.0 gram. The case is black enameled.

THE COLLECTOR IS IN ELECTRICAL CONTACT WITH THE CASE

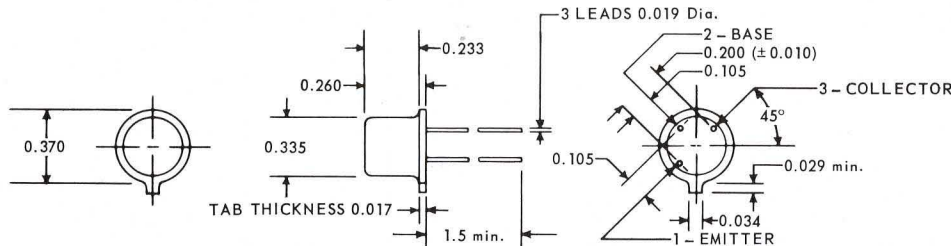

DIMENSIONS ARE MAXIMUM IN INCHES UNLESS OTHERWISE SPECIFIED

maximum ratings at 25°C ambient (unless otherwise noted)

Collector - Base Voltage	60 v
Collector - Emitter Voltage ($R_{BE} = 10$ ohms. See note 1)	40 v
Emitter - Base Voltage	5 v
Total Device Dissipation (See note 2)	0.6 w
Total Device Dissipation at case temperature 25°C (See note 3)	2 w
Storage Temperature Range	-65°C to +175°C

electrical characteristics at 25°C ambient (unless otherwise noted)

PARAMETERS		TEST CONDITIONS		min.	max.	unit
I_{CBO}	Collector Reverse Current	$V_{CB} = 30$ v	$I_E = 0$	—	1.0	μ a
I_{CBO}	Collector Reverse Current at 150°C	$V_{CB} = 30$ v	$I_E = 0$	—	100	μ a
BV_{CBO}	Collector-Base Breakdown Voltage	$I_{CBO} = 100$ μ a	$I_E = 0$	60	—	v
BV_{CER}^*	Collector-Emitter Breakdown Voltage	$I_{CER} = 100$ ma	$R_{BE} = 10$ ohms	40	—	v
BV_{EBO}	Emitter-Base Breakdown Voltage	$I_{EBO} = 100$ μ a	$I_C = 0$	5	—	v
h_{FE}^*	D-C Forward Current Transfer Ratio	$I_C = 150$ ma	$V_{CE} = 10$ v	20	60	—
V_{BE}^*	Base-Emitter Voltage	$I_C = 150$ ma	$I_B = 15$ ma	—	1.3	v
$V_{CE(sat)}^*$	Collector-Emitter Saturation Voltage	$I_C = 150$ ma	$I_B = 15$ ma	—	1.5	v
h_{fe}	A-C Common-Emitter Forward Current Transfer Ratio	$I_C = 50$ ma	$V_{CE} = 10$ v $f = 20$ mc	2.0	—	—
C_{ob}	Collector Capacitance	$I_E = 0$	$V_{CB} = 10$ v $f = 1$ mc	—	35	$\mu\mu$ f

* Pulse conditions: length = 300 μ s; duty cycle < 2%.

Note 1 — This is the voltage at which h_{FB} approaches one when $R_{BE} = 10$ ohms. When the emitter-base diode has a reverse voltage applied, peak collector-emitter voltage equal to BV_{CBO} minus V_{EB} may be allowed. Such conditions may be encountered in class B or C amplifiers and oscillators.

Note 2 — Derate linearly to +175°C ambient at the rate of 4 mw/C°

Note 3 — Derate linearly to +175°C case at the rate of 13 1/3 mw/C°

TYPICAL CHARACTERISTICS

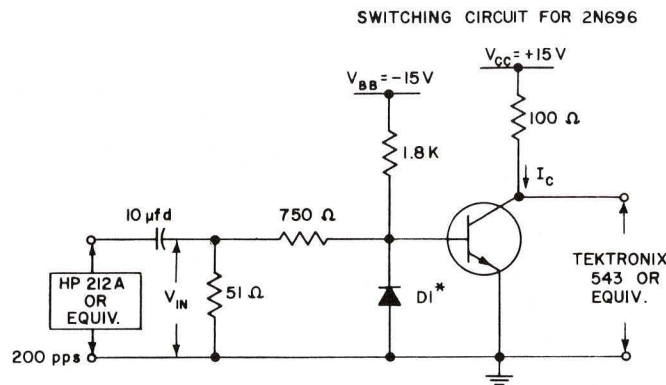
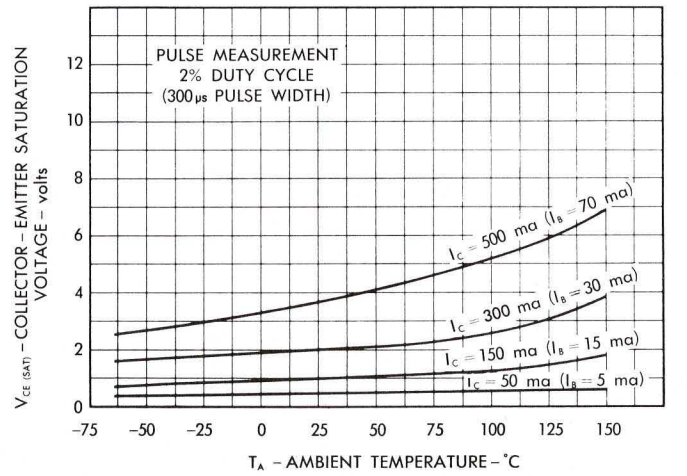
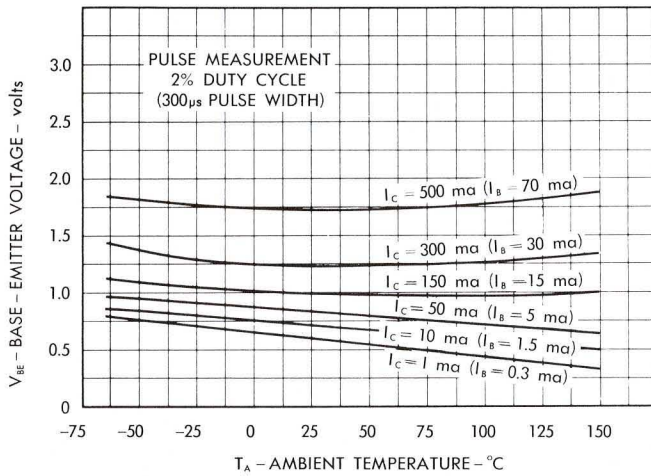
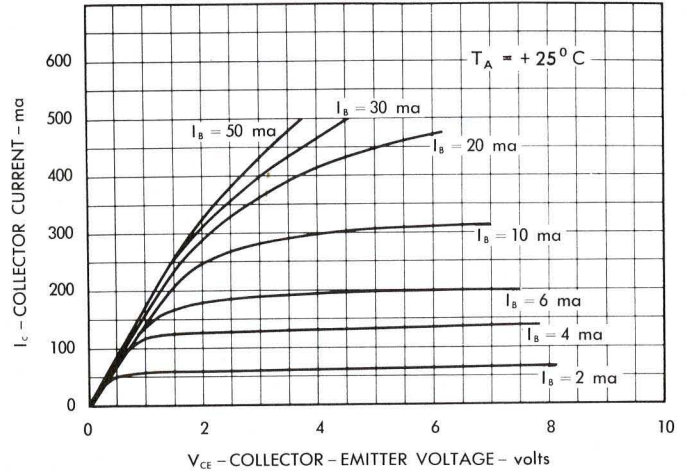
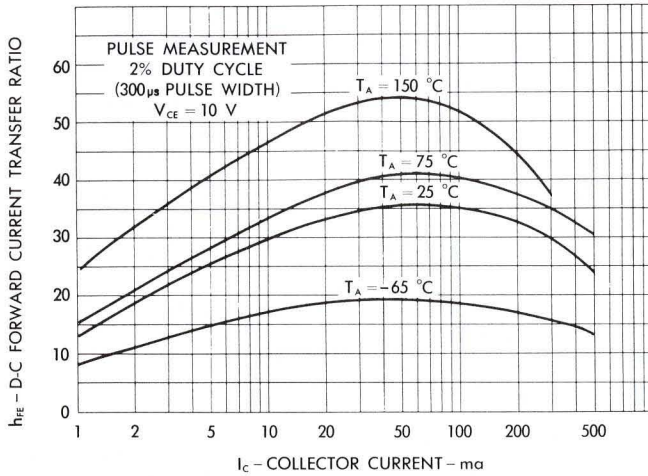

CIRCUIT CONDITIONS

- $I_C = 150 \text{ ma}$
- $I_{B1} = 10 \text{ ma}$
- $I_{B2} = -10 \text{ ma}$

* DI IS A HIGH-SPEED COMPUTER DIODE TI IN914

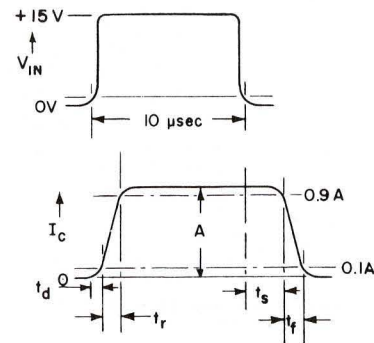

TYPICAL SWITCHING TIMES

- $t_d = 40 \text{ m}\mu\text{sec}$
- $t_r = 110 \text{ m}\mu\text{sec}$
- $t_s = 140 \text{ m}\mu\text{sec}$
- $t_f = 105 \text{ m}\mu\text{sec}$