

FEAST™ Fast Ethernet Controller with Full Duplex Capability

FEATURES

- Dual Speed CSMA/CD Engine (10 Mbps and 100 Mbps)
- Compliant with IEEE 802.3 100BASE-T Specification
- Supports 100BASE-TX, 100BASE-T4, and 10BASE-T Physical Interfaces
- 32 Bit Wide Data Path (into Packet Buffer Memory)
- Support for 32 and 16 Bit Buses
- Support for 32, 16 and 8 Bit CPU Accesses
- Synchronous, Asynchronous and Burst DMA Interface Mode Options
- 128 Kbyte External Memory
- Built-in Transparent Arbitration for Slave Sequential Access Architecture
- Early TX, Early RX Functions
- Flat MMU Architecture with Symmetric Transmit and Receive Structures and Queues
- MII (Media Independent Interface) Compliant MAC-PHY Interface Running at Nibble Rate
- MII Management Serial Interface
- Seven Wire Interface to 10 Mbps ENDEC
- EEPROM-Based Setup
- Full Duplex Capability
- 208 Pin QFP and TQFP Package

GENERAL DESCRIPTION

The SMC91C100FD is designed to facilitate the implementation of first generation Fast Ethernet adapters and connectivity products. For this first generation of products, flexibility dominates over integration. The SMC91C100FD is a digital device that implements the MAC portion of the CSMA/CD protocol at 10 and 100 Mbps, and couples it with a lean and fast data and control path system architecture to ensure the CPU to packet RAM data movement does not cause a bottleneck at 100 Mbps.

Total memory size is 128 Kbytes, equivalent to a total chip storage (transmit plus receive) of 64 outstanding packets. The SMC91C100FD is software compatible with the SMC9000 family of products and can use existing SMC9000 drivers (ODI, IPX, and NDIS) in 16 and 32 bit Intel X86 based environments.

Memory management is handled using a unique MMU (Memory Management Unit) architecture and a 32-bit wide data path. This I/O mapped architecture can sustain back-to-back frame

TABLE OF CONTENTS

FEATURES	1
GENERAL DESCRIPTION1
PIN CONFIGURATION	4
DESCRIPTION OF PIN FUNCTIONS	5
FUNCTIONAL DESCRIPTION	15
DATA STRUCTURES AND REGISTERS	18
BOARD SETUP INFORMATION	63
APPLICATION CONSIDERATIONS	66
OPERATIONAL DESCRIPTION	76
MAXIMUM GUARANTEED RATINGS*	76
DC ELECTRICAL CHARACTERISTICS	76
TIMING DIAGRAMS	80

SMC[®]

80 Arkay Drive
Hauppauge, NY. 11788
(516) 435-6000
FAX (516) 231-6004

transmission and reception for superior data throughput and optimal performance. It also dynamically allocates buffer memory in an efficient buffer utilization scheme, reducing software tasks and relieving the host CPU from performing these housekeeping functions. The total memory size is 128 Kbytes (external), equivalent to a total chip storage (transmit and receive) of 64 outstanding packets.

FEAST provides a flexible slave interface for easy connectivity with industry-standard buses. The Bus Interface Unit (BIU) can handle synchronous as well as asynchronous buses, with different signals being used for each one. FEAST's bus interface supports synchronous buses like the VESA local bus, as well as burst mode DMA for EISA environments. Asynchronous bus support for ISA is supported even though ISA cannot sustain 100 Mbps traffic. Fast Ethernet could be adopted for ISA-based nodes on the basis of the aggregate traffic benefits.

Two different interfaces are supported on the network side. The first is a conventional seven wire ENDEC interface that connects to the SMC83C694 for 10BASE-T and coax 10 Mbps Ethernet networks. The second interface follows

the MII (Media Independent Interface) specification draft standard, consisting of 4 bit wide data transfers at the nibble rate. This interface is applicable to 10 Mbps or 100 Mbps networks. Three of the SMC91C100FD's pins are used to interface to the two-line MII serial management protocol. Four I/O ports (one input and three output pins) are provided for SMC83C694 configuration.

The SMC91C100FD is based on the SMC91C100 FEAST, functional revision G modified to add full duplex capability. Also added is a software-controlled option to allow collisions to discard receive packets. Previously, the SMC91C100 supported a "Diagnostic Full Duplex" mode. Under this mode the transmit packet is looped internally and received by the MAC. This mode was enabled using the FDUPLX bit in the TCR. In order to avoid confusion, the new, broader full duplex function of the SMC91C100FD is designated as Switched Full Duplex, and the TCR bit enabling it is designated as SWFDUP. When the SMC91C100FD is configured for SWFDUP, its transmit and receive paths will operate independently and some CSMA/CD functions will be disabled. When the controller is not configured for SWFDUP it will follow the CSMA/CD protocol.

PIN CONFIGURATION

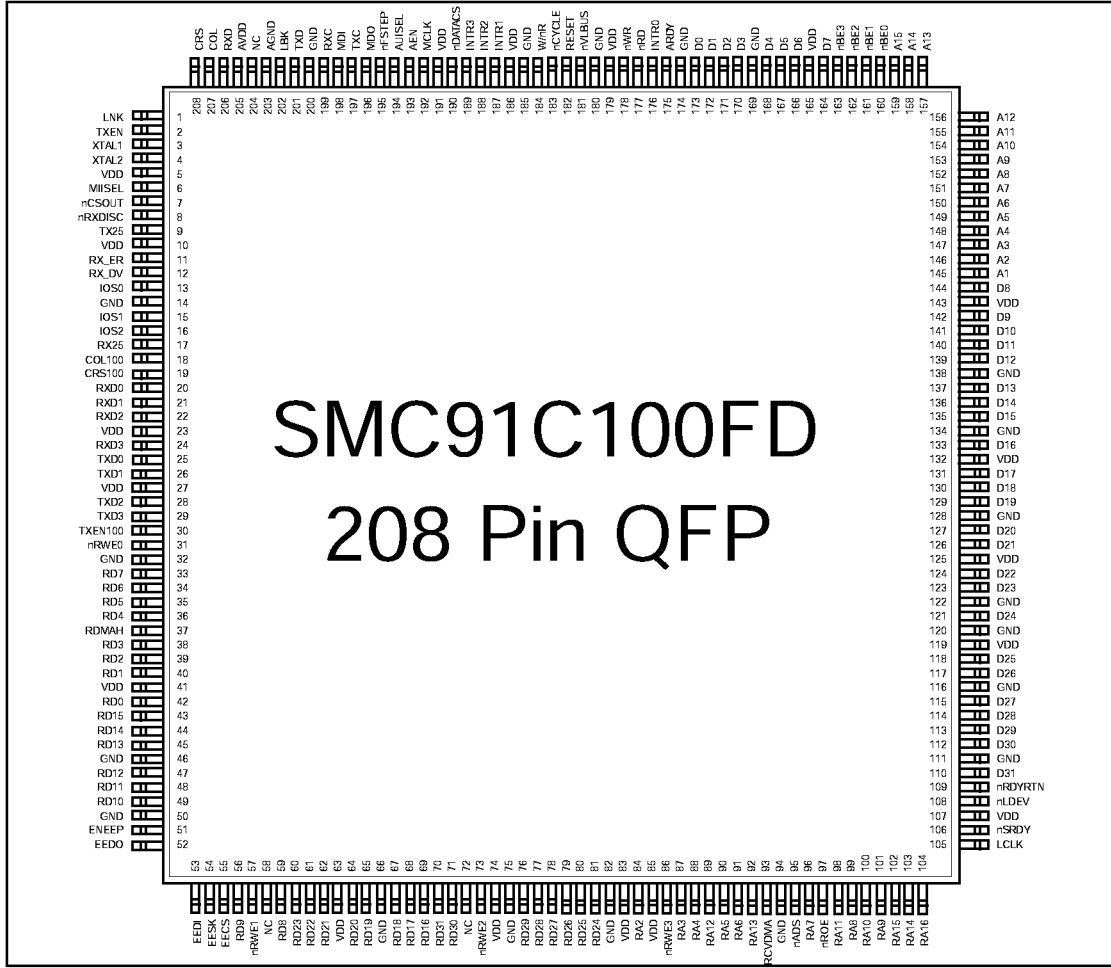

DESCRIPTION OF PIN FUNCTIONS

PIN NO.	NAME	SYMBOL	BUFFER TYPE	DESCRIPTION
148-159	Address	A4-A15	I	Input. Decoded by SMC91C100FD to determine access to its registers.
145-147	Address	A1-A3	I	Input. Used by SMC91C100FD for internal register selection.
193	Address Enable	AEN	I	Input. Used as an address qualifier. Address decoding is only enabled when AEN is low.
160-163	nByte Enable	nBE0-nBE3	I	Input. Used during SMC91C100FD register accesses to determine the width of the access and the register(s) being accessed. nBE0-nBE3 are ignored when nDATACS is low (burst accesses) because 32 bit transfers are assumed.
173-170, 168-166, 164, 144, 142-139, 137-135, 133, 131-129, 127, 126, 124, 123, 121, 118, 117, 115-112, 110	Data Bus	D0-D31	I/O24	Bidirectional. 32 bit data bus used to access the SMC91C100FD's internal registers. Data bus has weak internal pullups. Supports direct connection to the system bus without external buffering. For 16 bit systems, only D0-D15 are used.
182	Reset	RESET	IS	Input. This input is not considered active unless it is active for at least 100ns to filter narrow glitches.
95	nAddress Strobe	nADS	IS	Input. For systems that require address latching, the rising edge of nADS indicates the latching moment for A1-A15 and AEN. All SMC91C100FD internal functions of A1-A15, AEN are latched except for nLDEV decoding.
183	nCycle	nCYCLE	I	Input. This active low signal is used to control SMC91C100FD EISA burst mode synchronous bus cycles.
184	Write/ nRead	W/nR	IS	Input. Defines the direction of synchronous cycles. Write cycles when high, read cycles when low.

DESCRIPTION OF PIN FUNCTIONS

PIN NO.	NAME	SYMBOL	BUFFER TYPE	DESCRIPTION
181	nVL Bus Access	nVLBUS	I with pullup	Input. When low, the SMC91C100FD synchronous bus interface is configured for VL Bus accesses. Otherwise, the SMC91C100FD is configured for EISA DMA burst accesses. Does not affect the asynchronous bus interface.
105	Local Bus Clock	LCLK	I	Input. Used to interface synchronous buses. Maximum frequency is 50 MHz. Limited to 8.33 MHz for EISA DMA burst mode.
175	nAsynchronous Ready	nARDY	OD16	Open drain output. nARDY may be used when interfacing asynchronous buses to extend accesses. Its rising (access completion) edge is controlled by the XTAL1 clock and, therefore, asynchronous to the host CPU or bus clock.
106	nSynchronous Ready	nSRDY	O16	Output. This output is used when interfacing synchronous buses and nVLBUS=0 to extend accesses. This signal remains normally inactive, and its falling edge indicates completion. This signal is synchronous to the bus clock LCLK.
109	nReady Return	nRDYRTN	I	Input. This input is used to complete synchronous read cycles. In EISA burst mode it is sampled on falling LCLK edges, and synchronous cycles are delayed until it is sampled high.
176, 187-189	Interrupt	INTR0-INTR3	O24	Outputs. Only one of these interrupts is selected to be used; the other three are tri-stated. The selection is determined by the value of INT SEL 1-0 bits in the Configuration Register.
108	nLocal Device	nLDEV	O16	Output. This active low output is asserted when AEN is low and A4-A15 decode to the SMC91C100FD address programmed into the high byte of the Base Address Register. nLDEV is a combinatorial decode of unlatched address and AEN signals.
177	nRead Strobe	nRD	IS	Input. Used in asynchronous bus interfaces.
178	nWrite Strobe	nWR	IS	Input. Used in asynchronous bus interfaces.

DESCRIPTION OF PIN FUNCTIONS

PIN NO.	NAME	SYMBOL	BUFFER TYPE	DESCRIPTION
190	nData Path Chip Select	nDATA_CS	I with pullup	Input. When nDATA_CS is low, the Data Path can be accessed regardless of the values of AEN, A1-A15 and the content of the BANK SELECT Register. nDATA_CS provides an interface for bursting to and from the SMC91C100FD 32 bits at a time.
54	EEPROM Clock	EESK	O4	Output. 4 μ sec clock used to shift data in and out of the serial EEPROM.
55	EEPROM Select	EECS	O4	Output. Serial EEPROM chip select. Used for selection and command framing of the serial EEPROM.
52	EEPROM Data Out	EEDO	O4	Output. Connected to the DI input of the serial EEPROM.
53	EEPROM Data In	EEDI	I with pulldown	Input. Connected to the DO output of the serial EEPROM.
13, 15, 16	I/O Base	IOS0-IOS2	I with pullup	Input. External switches can be connected to these lines to select between predefined EEPROM configurations.
51	Enable EEPROM	ENEPP	I with pullup	Input. Enables (when high or open) SMC91C100FD accesses to the serial EEPROM. Must be grounded if no EEPROM is connected to the SMC91C100FD.
42, 40-38, 36-33	RAM Data Bus	RD0-RD7	I/O4 with pullups	Bidirectional. Carries the local buffer memory read and write data. Reads are always 32 bits wide. Writes are controlled individually at the byte level. Floated if FLTST=1 during RECEIVE FRAME STATUS WORD writes for packet forwarding information (RA2-RA16=0, RCVDMA=1, nRWE0-nRWE3=0).
59, 56, 49-47, 45-43, 69-67, 65, 64, 62-60, 81-76, 71, 70	RAM Data Bus	RD8-RD31	I/O4 with pullups	Bidirectional. Carries the local buffer memory read and write data. Reads are always 32 bits wide. Writes are controlled individually at the byte level.

DESCRIPTION OF PIN FUNCTIONS

PIN NO.	NAME	SYMBOL	BUFFER TYPE	DESCRIPTION
84, 87, 88, 90, 91, 96, 99, 101, 100, 98, 89, 92, 103, 102, 104	RAM Address Bus	RA2-RA16	O4	Outputs. This bus specifies the buffer RAM doubleword being accessed by the SMC91C100FD.
97		nROE	O4	Output. Active low signal used to read a doubleword from buffer RAM.
31, 57, 73, 86		nRWE0- RWE3	O4	Outputs. Active low signals used to write any byte, word or dword in RAM.
93	Receive DMA	RCVDMA	O4	Output. This pin is active during SMC91C100FD write memory cycles of receive packets.
3 4	Crystal 1 Crystal 2	XTAL1 XTAL2	lclk	An external 25 MHz crystal is connected across these pins. If a TTL clock is supplied instead, it should be connected to XTAL1 and XTAL2 should be left open.
5, 10, 23, 27, 41, 63, 74, 83, 85, 107, 119, 125, 132, 143, 165, 179, 186, 191	Power	VDD		+5V power supply pins.
205	Analog Power	AVDD		+5V analog power supply pins.
14, 32, 46, 50, 66, 75, 82, 94, 111, 116, 120, 122, 128, 134, 138, 169, 174, 180, 185, 200	Ground	GND		Ground pins.
203	Analog Ground	AGND		Analog ground pin.

DESCRIPTION OF PIN FUNCTIONS

PIN NO.	NAME	SYMBOL	BUFFER TYPE	DESCRIPTION
2	Transmit Enable	TXEN	O4	Output. Used for 10 Mbps ENDEC. This pin stays low when MIISEL is high.
201	Transmit Data	TXD	O4	Output. NRZ Transmit Data for 10 Mbps ENDEC interface.
208	Carrier Sense	CRS	I with pulldown	Input. Carrier sense from 10 Mbps ENDEC interface. This pin is ignored when MIISEL is high.
207	Collision Detect	COL	I with pulldown	Input. Collision detection indication from 10 Mbps ENDEC interface. This pin is ignored when MIISEL is high.
206	Receive Data	RXD	I with pullup	Input. NRZ Receive Data from 10 Mbps ENDEC interface. This pin is ignored when MIISEL is high.
197	Transmit Clock	TXC	I with pullup	Input. 10 MHz transmit clock used in 10 Mbps operation. This pin is ignored when MIISEL is high.
199	Receive Clock	RXC	I with pullup	Input. 10 MHz receive clock recovered by the 10 Mbps ENDEC. This pin is ignored when MIISEL is high.
202	Loopback	LBK	O4	Output. Active when LOOP bit is set (TCR bit 1). Independent of port selection (MIISEL=X).
1	nLink Status	nLNK	I with pullup	Input. General purpose input port used to convey LINK status (EPHSR bit 14). Independent of port selection (MIISEL=X).
195	nFullstep	nFSTEP	O4	Output. Non volatile output pin. Driven by inverse of FULLSTEP (CONFIG bit 10). Independent of port selection (MIISEL=X).
6	MII Select	MIISEL	O4	Output. Non volatile output pin. Driven by MII SELECT (CONFIG bit 15). High indicates the MII port is selected, low indicates the 10 Mbps ENDEC is selected.
194	AUI Select	AUISEL	O4	Output. Non volatile output pin. Driven by AUI SELECT (CONFIG bit 8). Independent of port selection (MIISEL=X).
30	Transmit Enable 100 Mbps	TXEN100	O12	Output to MII PHY. Envelope to 100 Mbps transmission. This pin stays low if MIISEL is low.
19	Carrier Sense 100 Mbps	CRS100	I with pulldown	Input from MII PHY. Envelope of packet reception used for deferral and backoff purposes. This pin is ignored when MIISEL is low.

DESCRIPTION OF PIN FUNCTIONS

PIN NO.	NAME	SYMBOL	BUFFER TYPE	DESCRIPTION
12	Receive Data Valid	RX_DV	I with pulldown	Input from MII PHY. Envelope of data valid reception. Used for receive data framing. This pin is ignored when MIISEL is low.
18	Collision Detect 100 Mbps	COL100	I with pulldown	Input from MII PHY. Collision detection input. This pin is ignored when MIISEL is low.
25, 26, 28, 29	Transmit Data	TXD0-TXD3	O12	Outputs. Transmit Data nibble to MII PHY.
9	Transmit Clock	TX25	I with pullup	Input. Transmit clock input from MII. Nibble rate clock (25 MHz). This pin is ignored when MIISEL is low.
17	Receive Clock	RX25	I with pullup	Input. Receive clock input from MII PHY. Nibble rate clock. This pin is ignored when MIISEL is low.
20, 21, 22, 24	Receive Data	RXD0-RXD3	I	Inputs. Received Data nibble from MII PHY. These pins are ignored when MIISEL is low.
198	Management Data Input	MDI	I with pulldown	MII management data input.
196	Management Data Output	MDO	O4	MII management data output.
192	Management Clock	MCLK	O4	MII management clock.
11	Receive Error	RX_ER	I with pulldown	Input. Indicates a code error detected by PHY. Used by the SMC91C100FD to discard the packet being received. The error indication reported for this event is the same as a bad CRC (Receive Status Word bit 13). This pin is ignored when MIISEL is low.
7	nChip Select Output	nCSOUT	O4	Output. Chip Select provided for mapping of PHY functions into SMC91C100FD decoded space. Active on accesses to SMC91C100FD's eight lower addresses when the BANK SELECTED is 7.

DESCRIPTION OF PIN FUNCTIONS

PIN NO.	NAME	SYMBOL	BUFFER TYPE	DESCRIPTION
8	nReceive Packet Discard	nRXDISC	I with pullup	Input. Used to discard the receive packet being stored in memory. Assertion of the pin during a packet reception results in the interruption of packet reception into memory. The memory allocated to the packet and the packet number in use are freed. The input is driven asynchronously and is synchronized internally by the SMC91C100FD. Pin assertion may take place at any time during the receive DMA packet. The assertion has no effect if there is no packet being DMAed to memory or if asserted during the last DMA write to memory. Works for both MII and ENDEC. The typical use of nRXDISC is with the SMC91C100FD in PRMS mode with an external associative memory use for address filtering. *Note: The pin must be asserted for a minimum of 80ns.
37		RDMAH	O4	Output. Active when the first dword of the address is written (RCVDMA=1, RA10-RA4=0, RA3-RA2=X).

Buffer Types

O4	Output buffer with 2mA source and 4mA sink
O12	Output buffer with 6mA source and 12mA sink
O16	Output buffer with 8mA source and 16mA sink
O24	Output buffer with 12mA source and 24mA sink
OD16	Open drain buffer with 16mA sink
I/O4	Bidirectional buffer with 2mA source and 4mA sink
I/O24	Bidirectional buffer with 12mA source and 24mA sink
I	Input buffer with TTL levels
IS	Input buffer with Schmitt Trigger Hysteresis
Iclk	Clock input buffer

DC levels and conditions defined in the DC Electrical Characteristics section.

Table 1 - SMC91C100FD Pin Requirements

FUNCTION	PIN SYMBOLS	NUMBER OF PINS
System Address Bus	A1-A15, AEN, nBE0-nBE3	20
System Data Bus	D0-D31	32
System Control Bus	RESET, nADS, LCLK, ARDY, nRDYRTN, nSRDY, INTRO-INTR3, nLDEV, nRD, nWR, nDATACS, nCYCLE, W/nR, nVLBUS	17
Serial EEPROM	EEDI, EEDO, EECS, EESK, ENEEP, IOS0-IOS2	8
RAM Data Bus	RD0-RD31	32
RAM Address Bus	RA2-RA16	15
RAM Control Bus	nROE, nRWE0-nRWE3, RCVDMA, RDMAH	7
Crystal Oscillator	XTAL1, XTAL2	2
Power	VDD, AVDD	19
Ground	GND, AGND	21
External ENDEC 10 Mbps	TXEN, TXD, CRS, COL, RXD, TXC, RXC, LBK, nLNK, nFSTEP, AUISEL, MIISEL	12
Physical Interface 100 Mbps	TXEN100, CRS100, COL100, RX_DV, RX_ER, TXD0-TXD3, RXD0-RXD3, MDI, MDO, MCLK	16
Clocks	TX25, RX25	2
Miscellaneous	nCSOUT, nRXDISC	2
TOTAL		205

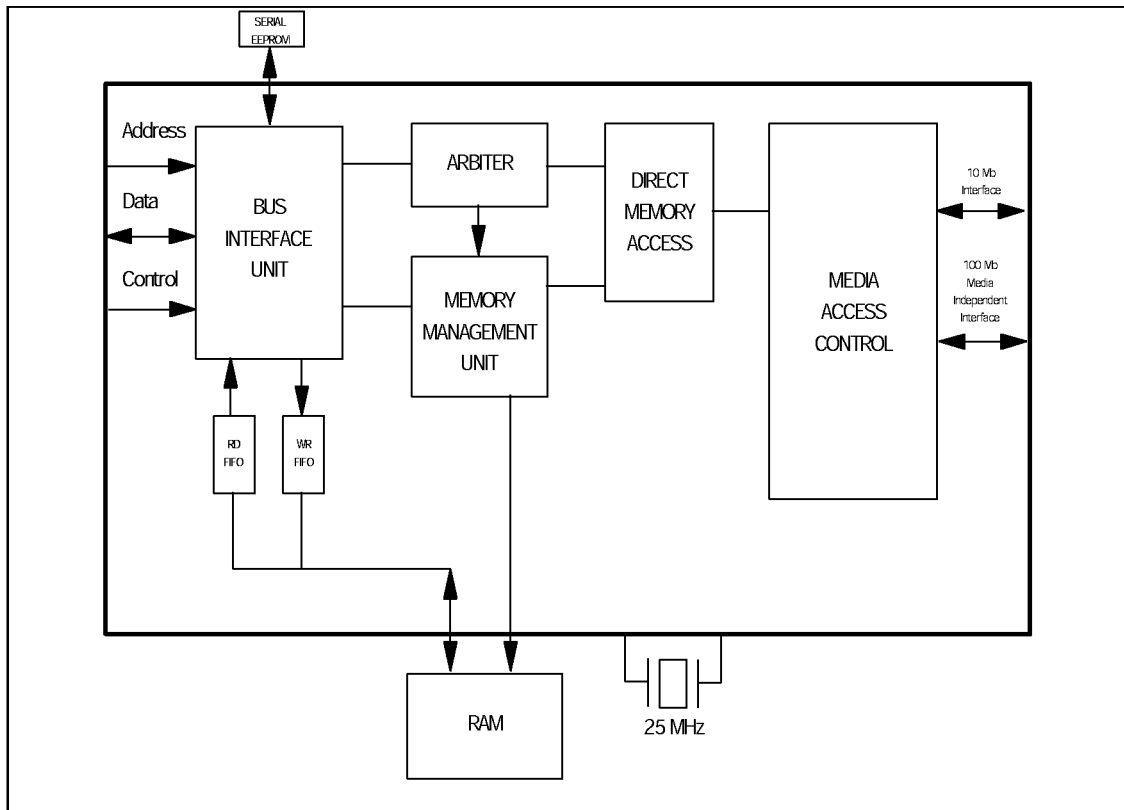

FIGURE 1 - SMC91C100FD BLOCK DIAGRAM

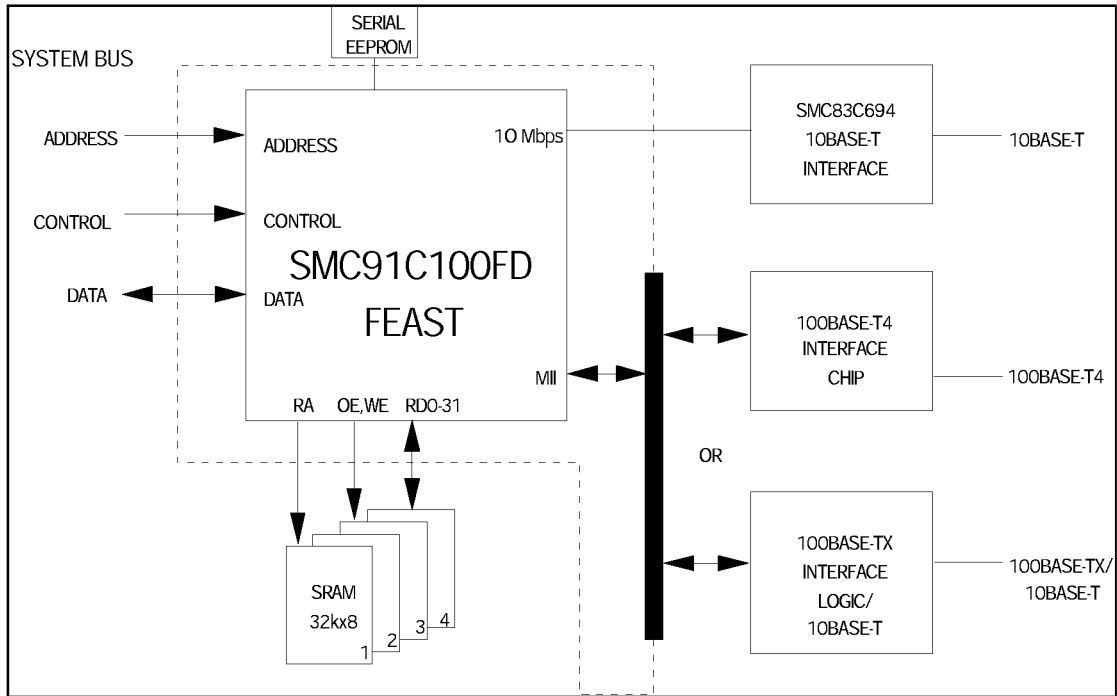

FIGURE 2 - SMC91C100FD SYSTEM DIAGRAM

FUNCTIONAL DESCRIPTION

DESCRIPTION OF BLOCKS

Clock Generator Block

- 1) The XTAL1 and XTAL2 pins are to be connected to a 25 MHz crystal.
- 2) TXCLK and RXCLK are 10 MHz clock inputs. These clocks are generated by the external ENDEC in 10 Mbps mode and are only used by the CSMA/CD block.
- 3) TX25 is an input clock. It will be the nibble rate of the particular PHY connected to the MII (2.5 MHz for a 10 Mbps PHY, and 25 MHz for a 100 Mbps PHY).
- 4) RX25 - This is the MII nibble rate receive clock used for sampling received data nibbles and running the receive state machine. (2.5 MHz for a 10 Mbps PHY, and 25 MHz for a 100 Mbps PHY).
- 5) LCLK - Bus clock - Used by the BIU for synchronous accesses. Maximum frequency is 50 MHz for VL BUS mode, and 8.33 MHz for EISA slave DMA.

CSMA/CD BLOCK

This is a 16 bit oriented block, with fully-independent Transmit and Receive logic. The data path in and out of the block consists of two 16-bit wide uni-directional FIFOs interfacing the DMA block. The DMA port of the FIFO stores 32 bits to exploit the 32 bit data path into memory, but the FIFOs themselves are 16 bit wide. The Control Path consists of a set of registers interfaced to the CPU via the BIU.

DMA Block

This block accesses packet memory on the CSMA/CD's behalf, fetching transmit data and storing received data. It interfaces the CSMA/CD Transmit and Receive FIFOs on one side, and the Arbiter block on the other. To increase the bandwidth into memory, a 50 MHz clock is used by the DMA block, and the data path is 32 bits wide.

For example, during active reception at 100 Mbps, the CSMA/CD block will write a word into the Receive FIFO every 160ns. The DMA will read the FIFO and accumulate two words on the output port to request a memory cycle from the Arbiter every 320ns.

DMA will discard a packet if nRXDISC is asserted for a minimum of 80ns during a reception. If asserted late, the DMA will receive the packet normally. The nRXDISC is defined valid for the DMA interface for as long as the RCVDMA signal is active.

The DMA machine is able to support full duplex operation. Independent receive and transmit counters are used. Transmit and receive cycles are alternated when simultaneous receive and transmit accesses are needed.

Arbiter Block

The Arbiter block sequences accesses to packet RAM requested by the BIU and by the DMA blocks. BIU requests represent pipelined CPU accesses to the Data Register, while DMA requests represent CSMA/CD data movement. The external memory used is a 25ns SRAM.

The Arbiter is also responsible for controlling the nRWE0-nRWE3 lines as a function of the bytes being written. Read accesses are always 32 bit wide, and the Arbiter steers the appropriate byte(s) to the appropriate lanes as a function of the address.

The CPU Data Path consists of two uni-directional FIFOs mapped at the Data Register location. These FIFOs can be accessed in any combination of bytes, word, or doublewords. The Arbiter will indicate 'Not Ready' whenever a cycle is initiated that cannot be satisfied by the present state of the FIFO.

MMU Block

The Hardware Memory Management Unit allocates memory and transmit and receive packet queues. It also determines the value of the transmit and receive interrupts as a function of the queues. The page size is 2k, with a maximum memory size of 128k. MIR and MCR values are interpreted in 512 byte units.

BIU Block

The Bus Interface Unit can handle synchronous as well as asynchronous buses; different signals are used for each one. Transparent latches are added on the address path using rising nADS for latching.

When working with an asynchronous bus like ISA, the read and write operations are controlled by the edges of nRD and nWR. ARDY is used for notifying the system that it should extend the access cycle. The leading edge of ARDY is generated by the leading edge of nRD or nWR while the trailing edge of ARDY is controlled by the internal SMC91C100FD clock and, therefore, asynchronous to the bus.

In the synchronous VL Bus type mode, nCYCLE and LCLK are used to for read and write operations. Completion of the cycle may be determined by using nSRDY. nSRDY is controlled by LCLK and synchronous to the bus.

Direct 32 bit access to the Data Path is supported by using the nDATAACS input. By asserting nDATAACS, external DMA type of devices will bypass the BIU address decoders and can sequentially access memory with no CPU intervention. nDATAACS accesses can be used in the EISA DMA burst mode (nVLBUS=1) or in asynchronous cycles. These cycles MUST be 32 bit cycles. Please refer to the corresponding timing diagrams for details on these cycles.

The BIU is implemented using the following principles:

- 1) Address decoding is based on the values of A15-A4 and AEN.
- 2) Address latching is performed by using transparent latches that are transparent when nADS=0 and nRD=1, nWR=1 and latch on nADS rising edge.
- 3) Byte, word and doubleword accesses to all registers and Data Path are supported except a doubleword write to offset Ch will only write the BANK SELECT REGISTER (offset Fh).
- 4) No bus byte swapping is implemented (no eight bit mode).
- 5) Word swapping as a function of A1 is implemented for 16 bit bus support.
- 6) The asynchronous interface uses nRD and nWR strobes. If necessary, ARDY is negated on the leading edge of the strobe. The ARDY trailing edge is controlled by CLK.

- 7) The VLBUS synchronous interface uses LCLK, nADS, and W/nR as defined in the VESA specification as well as nCYCLE to control read and write operations and generate nSRDY.
- 8) EISA burst DMA cycles to and from the DATA REGISTER are supported as defined in the EISA Slave Mode "C" specification when nDATACS is driven by nDAK.
- 9) Synchronous and asynchronous cycles can be mixed as long as they are not active simultaneously.
- 10) Address and bank selection can be bypassed to generate 32 bit Data Path accesses by activating the nDATACS pin.

MAC-PHY Interface Block

Two separate interfaces are defined, one for the 10 Mbps bit rate interface and one for the MII 100 Mbps and 10 Mbps nibble rate interface. The 10 Mbps ENDEC interface comprises the signals used for interfacing Ethernet ENDECs. The 100 Mbps interface follows the MII for 100 Mbps 802.3 networks proposal, and it is based on transferring nibbles between the MAC and the PHY.

For the MII interface, transmit data is clocked out using the TX25 clock input, while receive data is clocked in using RX25.

In 100 Mbps mode, the SMC91C100FD provides the following interface signals to the PHY:

- For transmission: TXEN100 TXD0-3 TX25
- For reception: RX_DV RX_ER RXD0-3 RX25
- For CSMA/CD state machines: CRS100 COL100

A transmission begins by TXEN100 going active (high), and TXD0-TXD3 having the first valid preamble nibble. TXD0 carries the least significant bit of the nibble (that is the one that would go first out of the EPH at 100 Mbps), while TXD3 carries the most significant bit of the nibble. TXEN100 and TXD0-TXD3 are clocked by the SMC91C100FD using TX25 rising edges. TXEN100 goes inactive at the end of the packet on the last nibble of the CRC.

During a transmission, COL100 might become active to indicate a collision. COL100 is asynchronous to the SMC91C100FD's clocks and will be synchronized internally to TX25.

Reception begins when RX_DV (receive data valid) is asserted. A preamble pattern or flag octet will be present at RXD0-RXD3 when RX_DV is activated. The SMC91C100FD requires no training sequence beyond a full flag octet for reception. RX_DV as well as RXD0-RXD3 are sampled on RX25 rising edges. RXD0 carries the least significant bit and RXD3 the most significant bit of the nibble. RX_DV goes inactive when the last valid nibble of the packet (CRC) is presented at RXD0-RXD3.

RX_ER might be asserted during packet reception to signal the SMC91C100FD that the present receive packet is invalid. The SMC91C100FD will discard the packet by treating it as a CRC error.

When MIISEL=1, RXD0-RXD3 should always be aligned to packet nibbles, therefore, opening flag detection does not consider misaligned cases. Opening flag detection expects the 5Dh pattern and will not reject the packet on non-preamble patterns. When MIISEL=0 the opening flag detection expects a "10101011" pattern and will use it for determining nibble alignment.

CRS100 is used as a frame envelope signal for the CSMA/CD MAC state machines (deferral and backoff functions), but it is not used for receive framing functions. CRS100 is an asynchronous signal and it will be active whenever there is activity on the cable, including SMC91C100FD transmissions and collisions.

Switching between the ENDEC and MII interfaces is controlled by the MII SELECT bit in the CONFIG REGISTER. The MIISEL pin reflects the value of this bit and may be used to control external multiplexing logic.

Note that given the modular nature of the MII, TX25 and RX25 cannot be assumed to be free running clocks. The SMC91C100FD will not rely on the presence of TX25 and RX25 during reset and will use its own internal clock whenever a timeout on TX25 is detected.

MII Management Interface Block

PHY management through the MII management interface is supported by the SMC91C100FD by providing the means to drive a tri-statable data output, a clock, and reading an input. Timing and framing for each management command is to be generated by the CPU.

Serial EEPROM Interface Block

This block is responsible for reading the serial EEPROM upon hardware reset (or equivalent command) and defining defaults for some key registers. A write operation is also implemented by this block, that under CPU command will program specific locations in the EEPROM. This block is an autonomous state machine and controls the internal Data Bus of the SMC91C100FD during active operation.

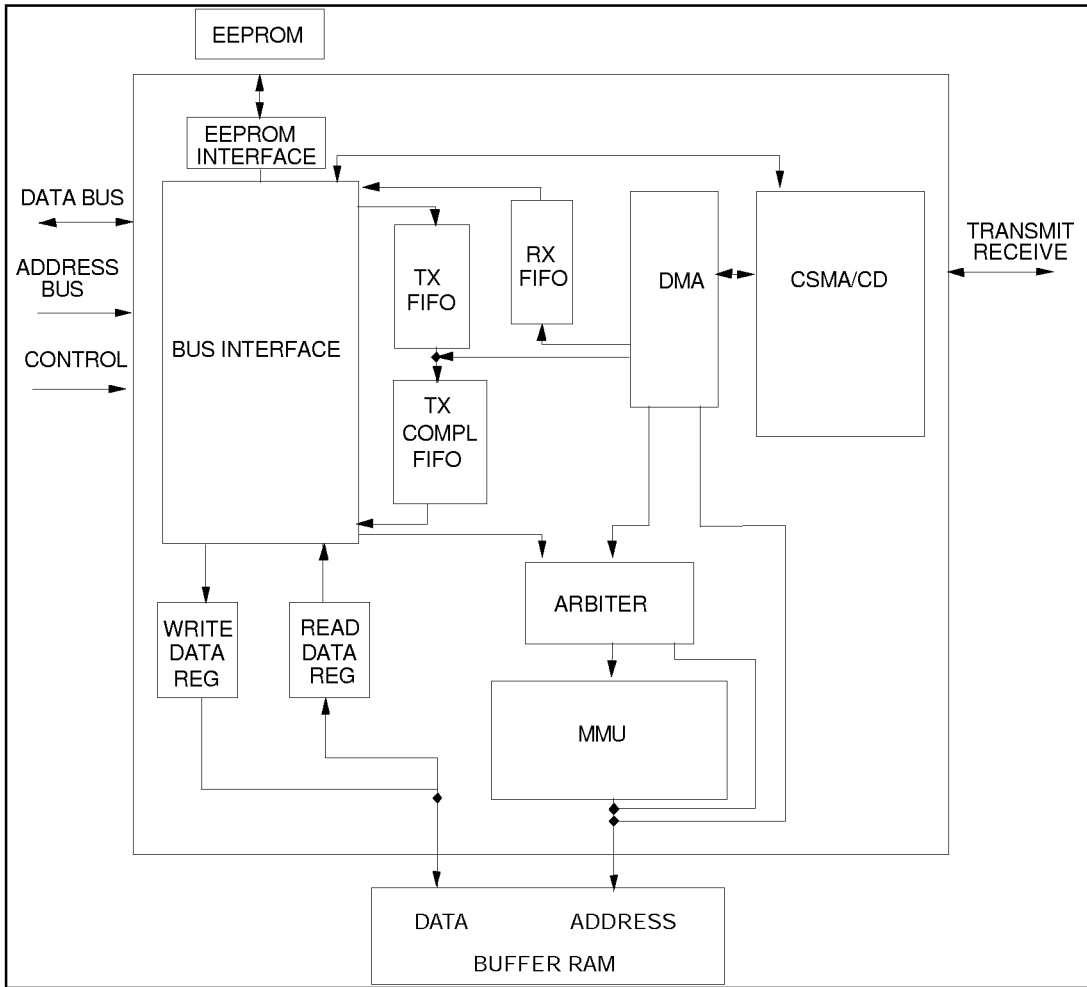

FIGURE 3 - SMC91C100FD INTERNAL BLOCK DIAGRAM WITH DATA PATH

DATA STRUCTURES AND REGISTERS

PACKET FORMAT IN BUFFER MEMORY

The packet format in memory is similar for the Transmit and Receive areas. The first word is

reserved for the status word. The next word is used to specify the total number of bytes, and it is followed by the data area. The data area holds the packet itself.

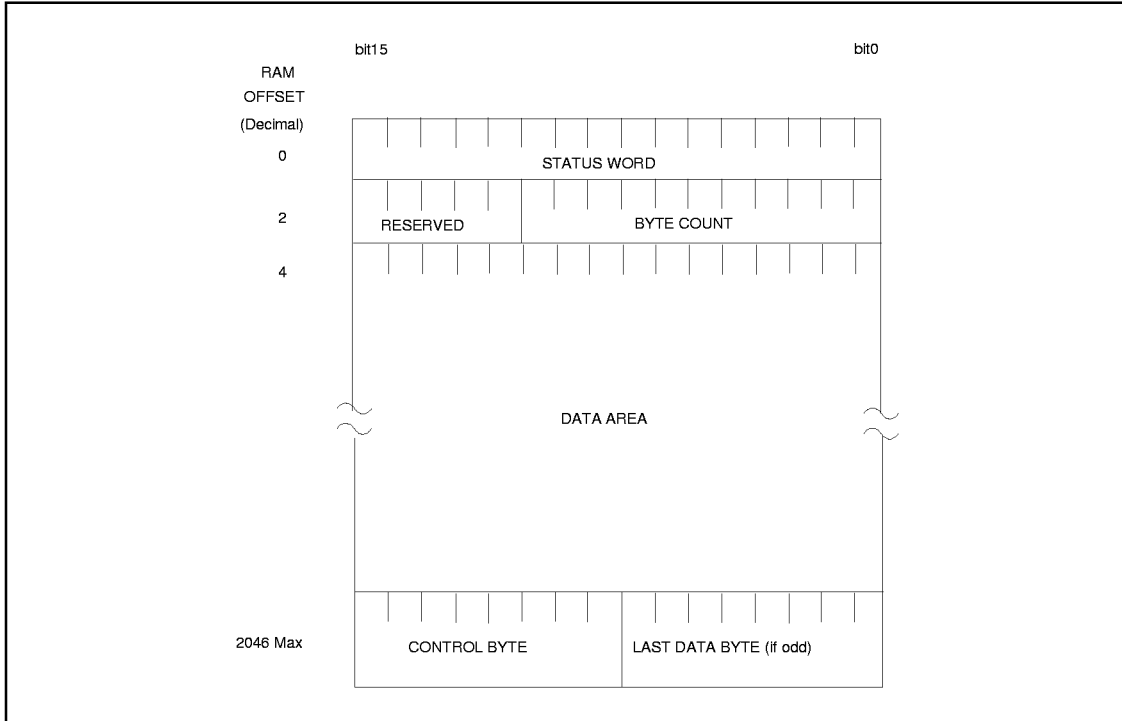

FIGURE 4 - DATA PACKET FORMAT

	TRANSMIT PACKET	RECEIVE PACKET
STATUS WORD	Written by CSMA upon transmit completion (see Status Register)	Written by CSMA upon receive completion (see RX Frame Status Word)
BYTE COUNT	Written by CPU	Written by CSMA
DATA AREA	Written/modified by CPU	Written by CSMA
CONTROL BYTE	Written by CPU to control odd/even data bytes	Written by CSMA; also has odd/even bit

BYTE COUNT - Divided by two, it defines the total number of words including the STATUS WORD, the BYTE COUNT WORD, the DATA AREA and the CONTROL BYTE.

The receive byte count always appears as even; the ODDFRM bit of the receive status word indicates if the low byte of the last word is relevant.

The transmit byte count least significant bit will be assumed 0 by the controller regardless of the value written in memory.

DATA AREA - The data area starts at offset 4 of the packet structure and can extend up to 2043 bytes.

The data area contains six bytes of DESTINATION ADDRESS followed by six bytes of SOURCE ADDRESS, followed by a variable-length number of bytes. On transmit, all bytes are provided by the CPU, including the source address. The SMC91C100FD does not insert its own source address. On receive, all bytes are provided by the CSMA side.

The 802.3 Frame Length word (Frame Type in Ethernet) is not interpreted by the SMC91C100FD. It is treated transparently as data both for transmit and receive operations.

CONTROL BYTE - For transmit packets the CONTROL BYTE is written by the CPU as:

X	X	ODD	CRC	0	0	0	0
---	---	-----	-----	---	---	---	---

ODD - If set, indicates an odd number of bytes, with the last byte being right before the CONTROL BYTE. If clear, the number of data bytes is even and the byte before the CONTROL BYTE is not transmitted.

CRC - When set, CRC will be appended to the frame. This bit has only meaning if the NOCRC bit in the TCR is set.

For receive packets the CONTROL BYTE is written by the controller as:

0	1	ODD	0	0	0	0	0
---	---	-----	---	---	---	---	---

ODD - If set, indicates an odd number of bytes, with the last byte being right before the CONTROL BYTE. If clear, the number of data bytes is even

and the byte before the CONTROL BYTE should be ignored.

RECEIVE FRAME STATUS WORD

This word is written at the beginning of each receive frame in memory. It is not available as a register.

HIGH BYTE	ALGN ERR	BROD CAST	BAD CRC	ODD FRM	TOOLNG	TOO SHORT		
LOW BYTE	HASH VALUE						MULT CAST	
	5	4	3	2	1	0		

ALGNERR - Frame had alignment error. When MII SEL=1 alignment error is set when BADCRC=1 and an odd number of nibbles was received between SFD and RX_DV going inactive. When MII SEL=0 alignment error is set when BADCRC=1 and the number of bits received between SFD and the CRS going inactive is not an octet multiple.

BROADCAST - Receive frame was broadcast.

BADCRC - Frame had CRC error, or RX_ER was asserted during reception.

ODDFRM - This bit when set indicates that the received frame had an odd number of bytes.

TOOLNG - Frame length was longer than 802.3 maximum size (1518 bytes on the cable).

TOOSHORT - Frame length was shorter than 802.3 minimum size (64 bytes on the cable).

HASH VALUE - Provides the hash value used to index the Multicast Registers. Can be used by receive routines to speed up the group address search. The hash value consists of the six most significant bits of the CRC calculated on the Destination Address, and maps into the 64 bit multicast table. Bits 5,4,3 of the hash value select a byte of the multicast table, while bits 2,1,0 determine the bit within the byte selected. Examples of the address mapping:

ADDRESS	HASH VALUE 5-0	MULTICAST TABLE BIT
ED 00 00 00 00 00	000 000	MT-0 bit 0
0D 00 00 00 00 00	010 000	MT-2 bit 0
01 00 00 00 00 00	100 111	MT-4 bit 7
2F 00 00 00 00 00	111 111	MT-7 bit 7

MULTICAST - Receive frame was multicast. If hash value corresponds to a multicast table bit that is set, and the address was a multicast, the

packet will pass address filtering regardless of other filtering criteria.

I/O SPACE

The base I/O space is determined by the IOS0-IOS2 inputs and the EEPROM contents. To limit the I/O space requirements to 16 locations, the registers are assigned to different banks. The last

word of the I/O area is shared by all banks and can be used to change the bank in use. Registers are described using the following convention:

OFFSET	NAME		TYPE		SYMBOL			
HIGH BYTE	bit 15	bit 14	bit 13	bit 12	bit 11	bit 10	bit 9	bit 8
	X	X	X	X	X	X	X	X
LOW BYTE	bit 7	bit 6	bit 5	bit 4	bit 3	bit 2	bit 1	bit 0
	X	X	X	X	X	X	X	X

OFFSET - Defines the address offset within the IOBASE where the register can be accessed at, provided the bank select has the appropriate value.

The offset specifies the address of the even byte (bits 0-7) or the address of the complete word.

The odd byte can be accessed using address (offset + 1).

Some registers (like the Interrupt Ack., or like Interrupt Mask) are functionally described as two eight bit registers, in that case the offset of each one is independently specified.

Regardless of the functional description, all registers can be accessed as doublewords, words or bytes.

The default bit values upon hard reset are highlighted below each register.

Table 2 - Internal I/O Space Mapping

	BANK0	BANK1	BANK2	BANK3
0	TCR	CONFIG	MMU COMMAND	MT0-1
2	EPH STATUS	BASE	PNR	MT2-3
4	RCR	IA0-1	FIFO PORTS	MT4-5
6	COUNTER	IA2-3	POINTER	MT6-7
8	MIR	IA4-5	DATA	MGMT
A	MCR	GENERAL	DATA	REVISION
C	RESERVED (0)	CONFIG	INTERRUPT	ERCV
E	BANK SELECT	BANK SELECT	BANK SELECT	BANK SELECT

A special BANK (BANK7) exists to support the addition of external registers.

BANK SELECT REGISTER

OFFSET E	NAME BANK SELECT REGISTER				TYPE READ/WRITE		SYMBOL BSR	
HIGH BYTE	0	0	1	1	0	0	1	1
	0	0	1	1	0	0	1	1
LOW BYTE						BS2	BS1	BS0
	X	X	X	X	X	0	0	0

BS2, BS1, BS0 Determine the bank presently in use. This register is always accessible and is used to select the register bank in use.

The upper byte always reads as 33h and can be used to help determine the I/O location of the SMC91C100FD.

The BANK SELECT REGISTER is always accessible regardless of the value of BS0-2.

Note that the bank select register can be accessed as a doubleword at offset Ch, as a word at offset Eh, or as at offset Fh, however

a doubleword write to offset Ch will write the BANK SELECT REGISTER but will not write the registers Ch and Dh.

BANK 7 has no internal registers other than the BANK SELECT REGISTER itself. On valid cycles where BANK7 is selected (BS0=BS1=BS2=1), and A3=0, nCSOUT is activated to facilitate implementation of external registers.

Note: BANK7 does not exist in SMC91C9x devices. For backward S/W compatibility BANK7 accesses should be done if the Revision Control register indicates the device is the SMC91C100FD.

BANK 0

OFFSET	NAME	TYPE	SYMBOL
0	TRANSMIT CONTROL REGISTER	READ/WRITE	TCR

This register holds bits programmed by the CPU to control some of the protocol transmit options.

HIGH BYTE	SWFDU P	0	EPH LOOP	STP SQET	FDUPLX	MON_ CSN	0	NOCRC
	0	0	0	0	0	0	0	0
LOW BYTE	PAD_EN	0	0	0	0	FORCOL	LOOP	TXENA
	0	0	0	0	0	0	0	0

SWFDUP - Enables Switched Full Duplex mode. In this mode, transmit state machine is inhibited from recognizing carrier sense, so deferrals will not occur. Also inhibits collision count, therefore, the collision related status bits in the EPHSR are not valid (CTR_ROL, LATCOL, SQET, 16COL, MULCOL, and SNGLCOL). Uses COL100 as flow control, limiting backoff and jam to 1 clock each before inter-frame gap, then retry will occur after IFG. If COL100 is active during preamble, full preamble will be output before jam. When SWFDUP is high, the values of FDUPLX and MON_CSN have no effect. This bit should be low for non-MII operation.

EPH_LOOP - Internal loopback at the EPH block. Serial data is internally looped back when set. Defaults low. When EPH_LOOP is high the following transmit outputs are forced inactive: TXD0-TXD3 = 0h, TXEN100 = TXEN = 0, TXD = 1. The following and external inputs are blocked: CRS=CRS100=0, COL=COL100=0, RX_DV=RX_ER=0.

STP_SQET - Stop transmission on SQET error. If set, stops and disables transmitter on SQE test

error. Does not stop on SQET error and transmits next frame if clear. Defaults low.

FDUPLX - When set it enables Full Duplex operation. This will cause frames to be received if they pass the address filter regardless of the source for the frame. When clear the node will not receive a frame sourced by itself.

MON_CSN - When set the SMC91C100FD monitors carrier while transmitting. It must see its own carrier by the end of the preamble. If it is not seen, or if carrier is lost during transmission, the transmitter aborts the frame without CRC and turns itself off and sets the LOST CARR bit in the EPHSR. When this bit is clear the transmitter ignores its own carrier. Defaults low. Should be 0 for MII operation.

NOCRC - Does not append CRC to transmitted frames when set. Allows software to insert the desired CRC. Defaults to zero, namely CRC inserted.

PAD_EN - When set, the SMC91C100FD will pad transmit frames shorter than 64 bytes with 00. Does not pad frames when reset.

FORCOL - When set, the FORCOL bit will force a collision by not deferring deliberately. This bit is set and cleared only by the CPU. When TXENA is enabled with no packets in the queue and while the FORCOL bit is set, the SMC91C100FD will transmit a preamble pattern the next time a carrier is seen on the line. If a packet is queued, a preamble and SFD will be transmitted. This bit defaults low to normal operation. NOTE: The LATCOL bit in the EPHSR, setting up as a result of FORCOL, will reset TXENA to 0. In order to force another collision, TXENA must be set to 1 again.

LOOP - Loopback. General purpose output port used to control the LBK pin. Typically used to put the PHY chip in loopback mode.

TXENA - Transmit enabled when set. Transmit is disabled if clear. When the bit is cleared the SMC91C100FD will complete the current transmission before stopping. When stopping due to an error, this bit is automatically cleared.

BANK 0

OFFSET	NAME	TYPE	SYMBOL
2	EPH STATUS REGISTER	READ ONLY	EPHSR

This register stores the status of the last transmitted frame. This register value, upon individual transmit packet completion, is stored as the first word in the memory area allocated to the packet. Packet interrupt processing should use the

copy in memory as the register itself will be updated by subsequent packet transmissions. The register can be used for real time values (like TXENA and LINK OK). If TXENA is cleared the register holds the last packet completion status.

HIGH BYTE	TX UNRN	LINK_ OK	RX_ OVRN	CTR_ ROL	EXC_ DEF	LOST CARR	LATCOL	0
	0	-nLNK pin	0	0	0	0	0	0
LOW BYTE	TX DEFR	LTX BRD	SQET	16COL	LTX MULT	MUL COL	SNGL COL	TX_SUC
	0	0	0	0	0	0	0	0

TXUNRN - Transmit Under Run. Set if under run occurs, it also clears TXENA bit in TCR. Cleared by setting TXENA high. This bit may only be set if early TX is being used.

LINK_OK - General purpose input port driven by nLNK pin inverted. Typically used for Link Test. A transition on the value of this bit generates an interrupt.

RX_OVRN - Upon receive overrun, the receiver temporarily asserts this bit. The receiver stays enabled and subsequent frames are received normally if memory becomes available. The RX_OVRN INT bit in the Interrupt Status Register will also be set and stay set until cleared by the CPU. Note that receive overruns could occur only if receive memory allocations fail.

CTR_ROL - Counter Roll Over. When set one or more 4 bit counters have reached maximum count (15). Cleared by reading the ECR register.

EXC_DEF - Excessive Deferral. When set last/current transmit was deferred for more than 1518 * 2 byte times. Cleared at the end of every packet sent.

LOST_CARR - Lost Carrier Sense. When set indicates that Carrier Sense was not present at end of preamble. Valid only if MON_CSN is enabled. This condition causes TXENA bit in TCR to be reset. Cleared by setting TXENA bit in TCR.

LATCOL - Late collision detected on last transmit frame. If set a late collision was detected (later than 64 byte times into the frame). When detected the transmitter jams and turns itself off clearing the TXENA bit in TCR. Cleared by setting TXENA in TCR.

TX_DEFR - Transmit Deferred. When set, carrier was detected during the first 6.4 μs of the inter frame gap. Cleared at the end of every packet sent.

LTX_BRD - Last transmit frame was a broadcast. Set if frame was broadcast. Cleared at the start of every transmit frame.

SQET - Signal Quality Error Test. In MII, SQET bit is always set after first transmit, except if SWFDUP=1. As a consequence, the STP_SQET bit in the TCR register cannot be set as it will always result in transmit fatal error. In non-MII systems, the transmitter opens a 1.6 μ s window 0.8 μ s after transmission is completed and the receiver returns inactive. During this window, the transmitter expects to see the SQET signal from the transceiver. The absence of this signal is a 'Signal Quality Error' and is reported in this status bit. Transmission stops and EPH INT is set if STP_SQET in the TCR is also set when SQET is set. This bit is cleared by setting TXENA high.

16COL - 16 collisions reached. Set when 16 collisions are detected for a transmit frame. TXENA bit in TCR is reset. Cleared when TXENA is set high.

LTX_MULT - Last transmit frame was a multicast. Set if frame was a multicast. Cleared at the start of every transmit frame.

MULCOL - Multiple collision detected for the last transmit frame. Set when more than one collision was experienced. Cleared when TX_SUC is high at the end of the packet being sent.

SNGLCOL - Single collision detected for the last transmit frame. Set when a collision is detected. Cleared when TX_SUC is high at the end of the packet being sent.

TX_SUC - Last transmit was successful. Set if transmit completes without a fatal error. This bit is cleared by the start of a new frame transmission or when TXENA is set high. Fatal errors are:

- 16 collisions (1/2 duplex mode only)

- SQET fail and STP_SQET = 1 (1/2 duplex mode only)

- FIFO Underrun

- Carrier lost and MON_CSN = 1 (1/2 duplex mode only)

- Late collision (1/2 duplex mode only)

BANK 0

OFFSET	NAME	TYPE	SYMBOL
4	RECEIVE CONTROL REGISTER	READ/WRITE	RCR

HIGH BYTE	SOFT RST	FILT CAR	ABORT_ENB	0	Reserved	Reserved	STRIP CRC	RXEN
	0	0	0	0	0	0	0	0
LOW BYTE	Reserved	Reserved	Reserved	Reserved	Reserved	ALMUL	PRMS	RX_ABORT
	0	0	0	0	0	0	0	0

SOFT_RST - Software-Activated Reset. Active high. Initiated by writing this bit high and terminated by writing the bit low. The SMC91C100FD's configuration is not preserved except for Configuration, Base, and IA0-IA5 Registers. EEPROM is not reloaded after software reset.

FILT_CAR - Filter Carrier. When set filters leading edge of carrier sense for 12 bit times (3 nibble times). Otherwise recognizes a receive frame as soon as carrier sense is active. (Does NOT filter RX DV on MII!)

ABORT_ENB - Enables abort of receive when collision occurs. Defaults low. When set, the SMC91C100FD will automatically abort a packet being received when the appropriate collision input is activated (COL100 for MII, COL for non-MII). This bit has no effect if the SWFDUP bit in the TCR is set.

STRIP_CRC - When set it strips the CRC on received frames. When clear the CRC is stored in memory following the packet. Defaults low.

RXEN - Enables the receiver when set. If cleared, completes receiving current frame and then goes idle. Defaults low on reset.

ALMUL - When set accepts all multicast frames (frames in which the first bit of DA is '1'). When clear accepts only the multicast frames that match the multicast table setting. Defaults low.

PRMS - Promiscuous mode. When set receives all frames. Does not receive its own transmission unless it is in Full Duplex!

RX_ABORT - This bit is set if a receive frame was aborted due to length longer than 2K bytes. The frame will not be received. The bit is cleared by RESET or by the CPU writing it low.

Reserved - Must be 0.

BANK 0

OFFSET	NAME	TYPE	SYMBOL
6	COUNTER REGISTER	READ ONLY	ECR

Counts four parameters for MAC statistics. When any counter reaches 15 an interrupt is issued. All

counters are cleared when reading the register and do not wrap around beyond 15.

HIGH BYTE	NUMBER OF EXC. DEFERRED TX	NUMBER OF DEFERRED TX
	0 0 0 0	0 0 0 0
LOW BYTE	MULTIPLE COLLISION COUNT	SINGLE COLLISION COUNT
	0 0 0 0	0 0 0 0

Each four bit counter is incremented every time the corresponding event, as defined in the EPH STATUS REGISTER bit description, occurs. Note that the counters can only increment once per enqueued transmit packet, never faster, limiting the rate of interrupts that can be generated by the counters. For example if a packet is successfully transmitted after one collision the SINGLE COLLISION COUNT field is incremented by one. If a packet experiences between 2 to 16 collisions, the MULTIPLE COLLISION COUNT field is incremented by one. If a packet experiences

deferral the NUMBER OF DEFERRED TX field is incremented by one, even if the packet experienced multiple deferrals during its collision retries.

The COUNTER REGISTER facilitates maintaining statistics in the AUTO RELEASE mode where no transmit interrupts are generated on successful transmissions.

Reading the register in the transmit service routine will be enough to maintain statistics.

BANK 0

OFFSET	NAME	TYPE	SYMBOL
8	MEMORY INFORMATION REGISTER	READ ONLY	MIR

HIGH BYTE	FREE MEMORY AVAILABLE (IN BYTES * 256 * M)							
	1	1	1	1	1	1	1	1
LOW BYTE	MEMORY SIZE (IN BYTES *256 * M)							
	1	1	1	1	1	1	1	1

FREE MEMORY AVAILABLE - This register can be read at any time to determine the amount of free memory. The register defaults to the **MEMORY SIZE** upon reset or upon the **RESET MMU** command.

MEMORY SIZE - This register can be read to determine the total memory size.

All memory related information is represented in $256 * M$ byte units, where the multiplier M is determined by the **MCR** upper byte.

These register default to **FFh**, which should be interpreted as **256**.

BANK 0

OFFSET A	NAME MEMORY CONFIGURATION REGISTER	TYPE Lower Byte - READ/WRITE Upper Byte - READ ONLY	SYMBOL MCR
HIGH BYTE		MEMORY SIZE MULTIPLIER	
	0 0 1 1	0 1	0 1
LOW BYTE	MEMORY RESERVED FOR TRANSMIT (IN BYTES * 256 * M)		
	0 0 0 0	0 0	0 0

MEMORY RESERVED FOR TRANSMIT - Programming this value allows the host CPU to reserve memory to be used later for transmit, limiting the amount of memory that receive packets can use. When programmed for zero, the memory allocation between transmit and receive is completely dynamic. When programmed for a non-zero value, the allocation is dynamic if the free memory exceeds the programmed value, while receive allocation requests are denied if the free memory is less or equal to the programmed value. This register defaults to zero upon reset. It is not affected by the RESET MMU command.

The value written to the MCR is a reserved memory space **IN ADDITION TO ANY MEMORY CURRENTLY IN USE**. If the memory allocated for

transmit plus the reserved space for transmit is required to be constant (rather than grow with transmit allocations) the CPU should update the value of this register after allocating or releasing memory.

The contents of the MIR as well as the low byte of the MCR are specified in units of $256 * M$ bytes, where M is the Memory Size Multiplier. M=2 for the SMC91C100FD. A value of 04h in the lower byte of the MCR is equal to one 2K page ($4 * 256 * 2 = 2K$); since memory must be reserved in multiples of pages, bits 0 and 1 of the MCR should be written to 1 only when the entire memory is being reserved for transmit (i.e., low byte of MCR = FFh).

BANK1

OFFSET	NAME	TYPE	SYMBOL
0	CONFIGURATION REGISTER	READ/WRITE	CR

The Configuration Register holds bits that define the adapter configuration and are not expected to change during run-time. This register is part of the EEPROM saved setup.

HIGH BYTE	MII SELECT			NO WAIT		FULL STEP	0	AUI SELECT
	1	0	1	0	0	0	0	0
LOW BYTE	1	0	Reserved			INT SEL1	INT SELO	
	1	0	1	1	0	0	0	1

MII SELECT - Used to select the network interface port. When set, the SMC91C100FD will use its MII port and interface a PHY device at the nibble rate. When clear, the SMC91C100FD will use its 10 Mbps ENDEC interface. This bit drives the MII SEL pin. Switching between ports should be done with transmitter and receiver disabled and no transmit/receive packets in progress.

NO WAIT - When set, does not request additional wait states. An exception to this are accesses to the Data Register if not ready for a transfer. When clear, negates IOCHRDY for two to three clocks on any cycle to the SMC91C100FD.

FULL STEP - This bit is a general purpose output port. Its inverse value drives pin nFSTEP and it is

typically connected to SEL pin of the SMC83C694. It can be used to select the signaling mode for the AUI or as a general purpose non-volatile configuration pin. Defaults low.

AUI SELECT - This bit is a general purpose output port. Its value drives pin AUISEL and it is typically connected to MODE1 pin of the SMC83C694. It can be used to select AUI vs. 10BASE-T, or as a general purpose non-volatile configuration pin. Defaults low.

Reserved - Must be 0.

INT SEL1-0 - Used to select one out of four interrupt pins. The three unused interrupts are tristated.

INT SEL1	INT SELO	INTERRUPT PIN USED
0	0	INTR0
0	1	INTR1
1	0	INTR2
1	1	INTR3

BANK 1

OFFSET	NAME	TYPE	SYMBOL
2	BASE ADDRESS REGISTER	READ/WRITE	BAR

This register holds the I/O address decode option chosen for the SMC91C100FD. It is part of the

EEPROM saved setup and is not usually modified during run-time.

HIGH BYTE	A15	A14	A13	A9	A8	A7	A6	A5
	0	0	0	1	1	0	0	0
LOW BYTE	Reserved							1
	0	0	0	0	0	0	0	1

A15 - A13 and A9 - A5 - These bits are compared against the I/O address on the bus to determine the IOBASE for the SMC91C100FD's registers. The 64k I/O space is fully decoded by the SMC91C100FD down to a 16 location space, therefore the unspecified address lines A4, A10, A11 and A12 must be all zeros.

All bits in this register are loaded from the serial EEPROM. The I/O base decode defaults to 300h (namely, the high byte defaults to 18h).

Reserved - Must be 0.

BANK 1

OFFSET 4 THROUGH 9	NAME INDIVIDUAL ADDRESS REGISTERS	TYPE READ/WRITE	SYMBOL IAR
-----------------------	---	--------------------	---------------

These registers are loaded starting at word location 20h of the EEPROM upon hardware reset or EEPROM reload. The registers can be modified by the software driver, but a STORE operation will

not modify the EEPROM Individual Address contents. Bit 0 of Individual Address 0 register corresponds to the first bit of the address on the cable.

HIGH BYTE	ADDRESS 0							
	0	0	0	0	0	0	0	0
LOW BYTE	ADDRESS 1							
	0	0	0	0	0	0	0	0
HIGH BYTE	ADDRESS 2							
	0	0	0	0	0	0	0	0
LOW BYTE	ADDRESS 3							
	0	0	0	0	0	0	0	0
HIGH BYTE	ADDRESS 4							
	0	0	0	0	0	0	0	0
LOW BYTE	ADDRESS 5							
	0	0	0	0	0	0	0	0

BANK 1

OFFSET A	NAME GENERAL PURPOSE REGISTER	TYPE READ/WRITE	SYMBOL GPR
HIGH BYTE	HIGH DATA BYTE		
	0	0	0
	0	0	0
	0	0	0
	0	0	0
	0	0	0
LOW BYTE	LOW DATA BYTE		
	0	0	0
	0	0	0
	0	0	0
	0	0	0
	0	0	0

This register can be used as a way of storing and retrieving non-volatile information in the EEPROM to be used by the software driver. The storage is word oriented, and the EEPROM word address to be read or written is specified using the six lowest bits of the Pointer Register.

This register can also be used to sequentially program the Individual Address area of the

EEPROM, that is normally protected from accidental Store operations.

This register will be used for EEPROM read and write only when the EEPROM SELECT bit in the Control Register is set. This allows generic EEPROM read and write routines that do not affect the basic setup of the SMC91C100FD.

BANK 1

OFFSET C	NAME CONTROL REGISTER				TYPE READ/WRITE		SYMBOL CTR	
HIGH BYTE	0	RCV_ BAD	0	1	AUTO RELEAS E	0	1	0
	0	0	0	1	0	0	1	0
LOW BYTE	LE ENABLE	CR ENABLE	TE ENABLE	1	0	EEPRO M SELECT	RELOAD	STORE
	0	0	0	1	0	0	0	0

RCV_BAD - When set, bad CRC packets are received. When clear bad CRC packets do not generate interrupts and their memory is released. Note: nRXDISC, when asserted, overrides RCV_BAD. Also, RCV_BAD does not modify the function of RCV DISCARD in the early receive register.

AUTO RELEASE - When set, transmit pages are released by transmit completion if the transmission was successful (when TX_SUC is set). In that case there is no status word associated with its packet number, and successful packet numbers are not even written into the TX COMPLETION FIFO. A sequence of transmit packets will generate an interrupt only when the sequence is completely transmitted (TX EMPTY INT will be set), or when a packet in the sequence experiences a fatal error (TX INT will be set). Upon a fatal error TXENA is cleared and the transmission sequence stops. The packet number that failed, is present in the FIFO PORTS register, and its pages are not released, allowing the CPU to restart the sequence after corrective action is taken.

LE ENABLE - Link Error Enable. When set it enables the LINK_OK bit transition as one of the interrupts merged into the EPH INT bit. Clearing

the LE ENABLE bit after an EPH INT interrupt, caused by a LINK_OK transition, will acknowledge the interrupt. LE ENABLE defaults low (disabled).

CR ENABLE - Counter Roll over Enable. When set, it enables the CTR_ROL bit as one of the interrupts merged into the EPH INT bit. Reading the COUNTER register after an EPH INT interrupt caused by a counter rollover, will acknowledge the interrupt. CR ENABLE defaults low (disabled).

TE ENABLE - Transmit Error Enable. When set it enables Transmit Error as one of the interrupts merged into the EPH INT bit. An EPH INT interrupt caused by a transmitter error is acknowledged by setting TXENA bit in the TCR register to 1 or by clearing the TE ENABLE bit. TE ENABLE defaults low (disabled). Transmit Error is any condition that clears TXENA with TX_SUC staying low as described in the EPHSR register.

EEPROM SELECT - This bit allows the CPU to specify which registers the EEPROM RELOAD or STORE refers to. When high, the General Purpose Register is the only register read or written. When low, RELOAD reads Configuration, Base and Individual Address, and STORE writes the Configuration and Base registers.

RELOAD - When set it will read the EEPROM and update relevant registers with its contents. Clears upon completing the operation.

STORE - When set, stores the contents of all relevant registers in the serial EEPROM. Clears upon completing the operation.

Note: When an EEPROM access is in progress the STORE and RELOAD bits will be read back as

high. The remaining 14 bits of this register will be invalid. During this time attempted read/write operations, other than polling the EEPROM status, will NOT have any effect on the internal registers. The CPU can resume accesses to the SMC91C100FD after both bits are low. A worst case RELOAD operation initiated by RESET or by software takes less than 750 μ s.

BANK2

OFFSET	NAME	TYPE	SYMBOL
0	MMU COMMAND REGISTER	WRITE ONLY BUSY Bit Readable	MMUCR

This register is used by the CPU to control the memory allocation, de-allocation, TX FIFO and RX FIFO control. The three command bits determine the command issued as described below:

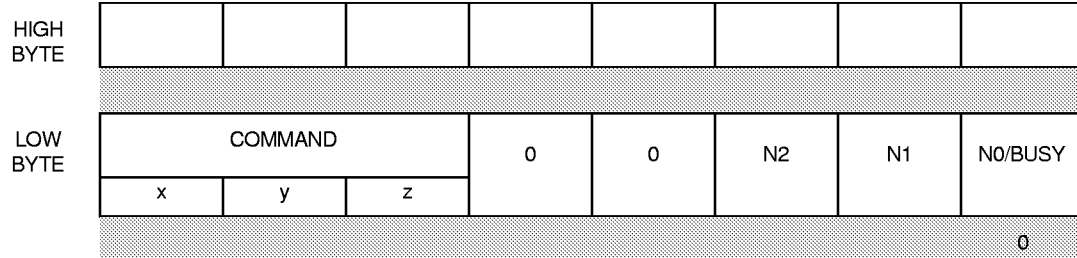

COMMAND SET:

xyz

- 000 0) NOOP - NO OPERATION
- 001 1) ALLOCATE MEMORY FOR TX - N2,N1,N0 defines the amount of memory requested as (value + 1) * 256 bytes. Namely N2,N1,N0 = 1 will request 2 * 256 = 512 bytes. A shift-based divide by 256 of the packet length yields the appropriate value to be used as N2,N1,N0. Immediately generates a completion code at the ALLOCATION RESULT REGISTER. Can optionally generate an interrupt on successful completion. N2,N1,N0 are ignored by the SMC91C100FD but should be implemented in SMC91C100FD software drivers for SMC9000 compatibility.
- 010 2) RESET MMU TO INITIAL STATE - Frees all memory allocations, clears relevant interrupts, resets packet FIFO pointers.
- 011 3) REMOVE FRAME FROM TOP OF RX FIFO - To be issued after CPU has completed processing of present receive frame. This command removes the receive packet number from the RX FIFO and brings the next receive frame (if any) to the RX area (output of RX FIFO).
- 100 4) REMOVE AND RELEASE TOP OF RX FIFO - Like 3) but also releases all memory used by the packet presently at the RX FIFO output. The MMU busy time after issuing REMOVE and RELEASE command depends on the time when the busy bit is cleared. The time from issuing REMOVE and RELEASE command on the last receive packet to the time when receive FIFO is empty depends on RX INT bit turning low. An alternate approach can be checking the read RX FIFO register.

- 101 5) **RELEASE SPECIFIC PACKET** - Frees all pages allocated to the packet specified in the **PACKET NUMBER REGISTER**. Should not be used for frames pending transmission. Typically used to remove transmitted frames, after reading their completion status. Can be used following 3) to release receive packet memory in a more flexible way than 4).
- 110 6) **ENQUEUE PACKET NUMBER INTO TX FIFO** - This is the normal method of transmitting a packet just loaded into RAM. The packet number to be enqueued is taken from the **PACKET NUMBER REGISTER**.
- 111 7) **RESET TX FIFOs** - This command will reset both TX FIFOs: The TX FIFO holding the packet numbers awaiting transmission and the TX Completion FIFO. This command provides a mechanism for canceling packet transmissions, and reordering or bypassing the transmit queue. The **RESET TX FIFOs** command should only be used when the transmitter is disabled. Unlike the **RESET MMU** command, the **RESET TX FIFOs** does not release any memory.

Note 1: Bits N2, N1, N0 bits are ignored by the SMC91C 100FD but should be used for command 0 to preserve software compatibility with the SMC91C92 and future devices. They should be zero for all other commands.

Note 2: When using the **RESET TX FIFOs** command, the CPU is responsible for releasing the memory associated with outstanding packets, or re-enqueuing them. Packet numbers in the completion FIFO can be read via the FIFO ports register before issuing the command.

Note 3: MMU commands releasing memory (commands 4 and 5) should only be issued if the corresponding packet number has memory allocated to it.

COMMAND SEQUENCING

A second allocate command (command 1) should not be issued until the present one has completed. Completion is determined by reading the **FAILED** bit of the allocation result register or through the allocation interrupt.

A second release command (commands 4, 5) should not be issued if the previous one is still being processed. The **BUSY** bit indicates that a release command is in progress. After issuing

command 5, the contents of the **PNR** should not be changed until **BUSY** goes low. After issuing command 4, command 3 should not be issued until **BUSY** goes low.

BUSY BIT - Readable at bit 0 of the MMU command register address. When set indicates that MMU is still processing a release command. When clear, MMU has already completed last release command. **BUSY** and **FAILED** bits are set upon the trailing edge of command.

BANK 2

OFFSET	NAME	TYPE	SYMBOL
2	PACKET NUMBER REGISTER	READ/WRITE	PNR
0	0	PACKET NUMBER AT TX AREA	
0	0	0	0
0	0	0	0

PACKET NUMBER AT TX AREA - The value written into this register determines which packet number is accessible through the TX area. Some MMU commands use the number stored in this

register as the packet number parameter. This register is cleared by a RESET or a RESET MMU Command.

OFFSET	NAME	TYPE	SYMBOL
3	ALLOCATION RESULT REGISTER	READ ONLY	ARR
FAILED	0	ALLOCATED PACKET NUMBER	
1	0	0	0
0	0	0	0

This register is updated upon an ALLOCATE MEMORY MMU command.

FAILED - A zero indicates a successful allocation completion. If the allocation fails the bit is set and only cleared when the pending allocation is satisfied. Defaults high upon reset and reset MMU command. For polling purposes, the ALLOC_INT in the Interrupt Status Register should be used because it is synchronized to the read operation. Sequence:

- 1) Allocate Command
- 2) Poll ALLOC_INT bit until set
- 3) Read Allocation Result Register

ALLOCATED PACKET NUMBER - Packet number associated with the last memory allocation request. The value is only valid if the FAILED bit is clear.

Note: For software compatibility with future versions, the value read from the ARR after an allocation request is intended to be written into the PNR as is, without masking higher bits (provided FAILED = 0).

BANK 2

OFFSET	NAME	TYPE	SYMBOL
4	FIFO PORTS REGISTER	READ ONLY	FIFO

This register provides access to the read ports of the Receive FIFO and the Transmit completion FIFO. The packet numbers to be processed by the

interrupt service routines are read from this register.

HIGH BYTE	EMPTY	0	RX FIFO PACKET NUMBER						
	1	0	0	0	0	0	0	0	0
LOW BYTE	EMPTY	0	TX DONE PACKET NUMBER						
	1	0	0	0	0	0	0	0	0

EMPTY - No receive packets queued in the RX FIFO. For polling purposes, uses the RCV_INT bit in the Interrupt Status Register.

TOP OF RX FIFO PACKET NUMBER - Packet number presently at the output of the RX FIFO. Only valid if EMPTY is clear. The packet is removed from the RX FIFO using MMU Commands 3) or 4).

EMPTY - No transmit packets in completion queue. For polling purposes, uses the TX_INT bit in the Interrupt Status Register.

TX DONE PACKET NUMBER - Packet number presently at the output of the TX Completion FIFO. Only valid if EMPTY is clear. The packet is removed when a TX INT acknowledge is issued.

Note: For software compatibility with future versions, the value read from each FIFO register is intended to be written into the PNR as is, without masking higher bits (provided EMPTY and EMPTY = 0 respectively).

BANK 2

OFFSET	NAME	TYPE	SYMBOL
6	POINTER REGISTER	READ/WRITE NOT EMPTY is a read only bit	PTR

HIGH BYTE	RCV	AUTO INCR.	READ	ETEN	NOT EMPTY	POINTER HIGH		
	0	0	0	0	0	0	0	0
LOW BYTE	POINTER LOW							
	0	0	0	0	0	0	0	0

POINTER REGISTER - The value of this register determines the address to be accessed within the transmit or receive areas. It will auto-increment on accesses to the data register when **AUTO INCR.** is set. The increment is by one for every byte access, by two for every word access, and by four for every double word access. When **RCV** is set the address refers to the receive area and uses the output of RX FIFO as the packet number, when **RCV** is clear the address refers to the transmit area and uses the packet number at the Packet Number Register.

READ - Determines the type of access to follow. If the **READ** bit is high the operation intended is a read. If the **READ** bit is low the operation is a write. Loading a new pointer value, with the **READ** bit high, generates a pre-fetch into the Data Register for read purposes.

Readback of the pointer will indicate the value of the address last accessed by the CPU (rather than the last pre-fetched). This allows any interrupt

routine that uses the pointer, to save it and restore it without affecting the process being interrupted.

The Pointer Register should not be loaded until the Data Register FIFO is empty. The **NOT EMPTY** bit of this register can be read to determine if the FIFO is empty. On reads, if **IOCHRDY** is not connected to the host, the Data Register should not be read before 370ns after the pointer was loaded to allow the Data Register FIFO to fill.

If the pointer is loaded using 8 bit writes, the low byte should be loaded first and the high byte last.

ETEN - When set enables **EARLY** Transmit underrun detection. Normal operation when clear.

NOT EMPTY - When set indicates that the Write Data FIFO is not empty yet. The CPU can verify that the FIFO is empty before loading a new pointer value. This is a read only bit.

Note: If **AUTO INCR.** is not set, the pointer must be loaded with a dword aligned value.

BANK 2

OFFSET 8 THROUGH Bh	NAME DATA REGISTER				TYPE READ/WRITE		SYMBOL DATA	
DATA HIGH								
X	X	X	X	X	X	X	X	X
DATA LOW								
X	X	X	X	X	X	X	X	X

DATA REGISTER - Used to read or write the data buffer byte/word presently addressed by the pointer register.

This register is mapped into two uni-directional FIFOs that allow moving words to and from the SMC91C100FD regardless of whether the pointer address is even, odd or dword aligned. Data goes through the write FIFO into memory, and is pre-fetched from memory into the read FIFO. If byte accesses are used, the appropriate (next) byte can be accessed through the Data Low or Data High

registers. The order to and from the FIFO is preserved. Byte, word and dword accesses can be mixed on the fly in any order.

This register is mapped into two consecutive word locations to facilitate double word move operations regardless of the actual bus width (16 or 32 bits). The DATA register is accessible at any address in the 8 through Ah range, while the number of bytes being transferred is determined by A1 and nBE0-nBE3. The FIFOs are 12 bytes each.

BANK 2

OFFSET C	NAME INTERRUPT STATUS REGISTER				TYPE READ ONLY	SYMBOL IST	
RX_DISC INT	ERCV INT	EPH INT	RX_OVRN INT	ALLOC INT	TX EMPTY INT	TX INT	RCV INT
0	0	0	0	0	1	0	0

OFFSET C	NAME INTERRUPT ACKNOWLEDGE REGISTER				TYPE WRITE ONLY	SYMBOL ACK	
RX_DISC INT	ERCV INT		RX_OVRN INT		TX EMPTY INT	TX INT	

OFFSET D	NAME INTERRUPT MASK REGISTER				TYPE READ/WRITE	SYMBOL MSK	
RX_DISC INT	ERCV INT	EPH INT	RX_OVRN INT	ALLOC INT	TX EMPTY INT	TX INT	RCV INT
0	0	0	0	0	0	0	0

This register can be read and written as a word or as two individual bytes.

The Interrupt Mask Register bits enable the appropriate bits when high and disable them when low. An enabled bit being set will cause a hardware interrupt.

EPH INT - Set when the Ethernet Protocol Handler section indicates one out of various possible special conditions. This bit merges exception type of interrupt sources, whose service time is not critical to the execution speed of the low level drivers. The exact nature of the interrupt can be obtained from the EPH Status Register (EPHSR),

and enabling of these sources can be done via the Control Register. The possible sources are:

LINK - Link Test transition
 CTR_ROL - Statistics counter roll over
 TXENA cleared - A fatal transmit error occurred forcing TXENA to be cleared. TX_SUC will be low and the specific reason will be reflected by the bits:

- TXUNRN - Transmit underrun
- SQET - SQE Error
- LOST CARR - Lost Carrier
- LATCOL - Late Collision
- 16COL - 16 collisions

RX_DISC INT - Set when the nRXDISC PIN COUNTER in the ERVC register increments to a value of FF. The RX_DISC INT bit latches the condition for the purpose of being polled or generating an interrupt, and will only be cleared by writing the acknowledge register with the RX_DISC INT bit set.

RX_OVRN INT - Set when 1) the receiver aborts due to an overrun due to a failed memory allocation, 2) the receiver aborts due to a packet length of greater than 2K bytes, or 3) the receiver aborts due to the RCV DISCRD bit in the ERVC register set. The RX_OVRN INT bit latches the condition for the purpose of being polled or generating an interrupt, and will only be cleared by writing the acknowledge register with the RX_OVRN INT bit set.

ALLOC INT - Set when an MMU request for TX pages allocation is completed. This bit is the complement of the FAILED bit in the ALLOCATION RESULT register. The ALLOC INT ENABLE bit should only be set following an allocation command, and cleared upon servicing the interrupt.

TX EMPTY INT - Set if the TX FIFO goes empty, can be used to generate a single interrupt at the end of a sequence of packets enqueued for transmission. This bit latches the empty condition, and the bit will stay set until it is specifically cleared by writing the acknowledge register with the TX EMPTY INT bit set. If a real time reading of the FIFO empty is desired, the bit should be first cleared and then read.

The TX EMPTY INT ENABLE should only be set after the following steps:

- a) a packet is enqueued for transmission
- b) the previous empty condition is cleared (acknowledged)

TX INT - Set when at least one packet transmission was completed. The first packet number to be serviced can be read from the FIFO PORTS register. The TX INT bit is always the logic complement of the TEMPT bit in the FIFO PORTS register. After servicing a packet number, its TX INT interrupt is removed by writing the Interrupt Acknowledge Register with the TX INT bit set.

RCV INT - Set when a receive interrupt is generated. The first packet number to be serviced can be read from the FIFO PORTS register. The RCV INT bit is always the logic complement of the REMPT bit in the FIFO PORTS register.

ERCV INT - Early receive interrupt. Set whenever a receive packet is being received, and the number of bytes received into memory exceeds the value programmed as ERVC THRESHOLD (Bank 3, Offset Ch). ERVC INT stays set until acknowledged by writing the INTERRUPT ACKNOWLEDGE REGISTER with the ERVC INT bit set.

Note: If the driver uses AUTO RELEASE mode it should enable TX EMPTY INT as well as TX INT. TX EMPTY INT will be set when the complete sequence of packets is transmitted. TX INT will be set if the sequence stops due to a fatal error on any of the packets in the sequence.

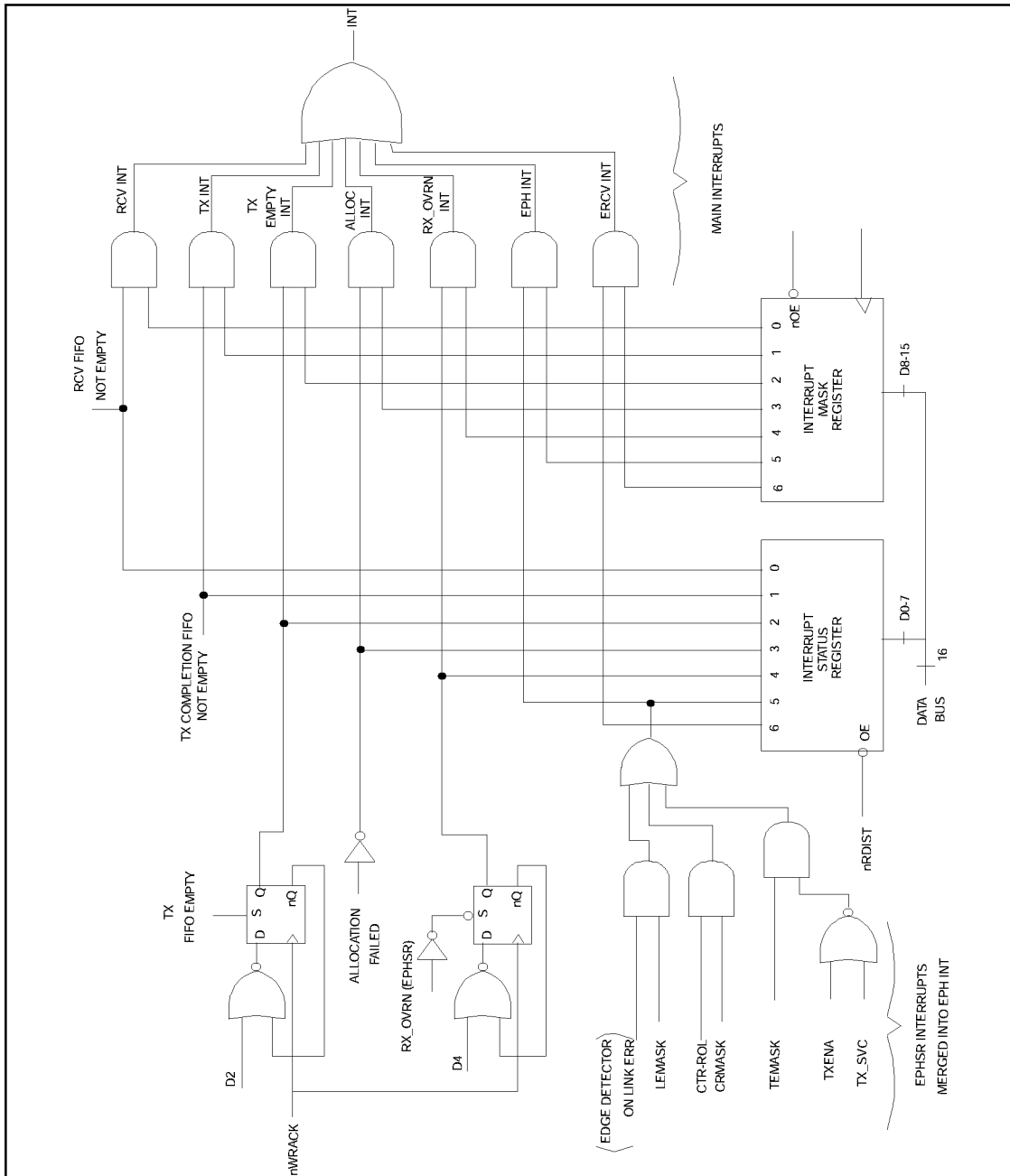

FIGURE 5 - INTERRUPT STRUCTURE

BANK3

OFFSET 0 THROUGH 7	NAME MULTICAST TABLE	TYPE READ/WRITE	SYMBOL MT
LOW BYTE	MULTICAST TABLE 0		
0	0	0	0
HIGH BYTE	MULTICAST TABLE 1		
0	0	0	0
LOW BYTE	MULTICAST TABLE 2		
0	0	0	0
HIGH BYTE	MULTICAST TABLE 3		
0	0	0	0
LOW BYTE	MULTICAST TABLE 4		
0	0	0	0
HIGH BYTE	MULTICAST TABLE 5		
0	0	0	0
LOW BYTE	MULTICAST TABLE 6		
0	0	0	0
HIGH BYTE	MULTICAST TABLE 7		
0	0	0	0

The 64 bit multicast table is used for group address filtering. The hash value is defined as the six most significant bits of the CRC of the destination addresses. The three msb's determine the register to be used (MT0-MT7), while the other three determine the bit within the register.

If the appropriate bit in the table is set, the packet is received.

If the ALMUL bit in the RCR register is set, all multicast addresses are received regardless of the multicast table values.

Hashing is only a partial group addressing filtering scheme, but being the hash value available as part of the receive status word, the receive routine can reduce the search time significantly. With the proper memory structure, the search is limited to comparing only the multicast addresses that have the actual hash value in question.

BANK 3

OFFSET	NAME				TYPE		SYMBOL	
8	MANAGEMENT INTERFACE				READ/WRITE		MGMT	
HIGH BYTE	FLTST	MSK_CRS100						
	0	0	1	1	0	0	1	1
LOW BYTE					MDOE	MCLK	MDI	MDO
	0	0	1	1	0	0	MDI Pin	0

FLTST - Facilitates the inclusion of packet forwarding information on the receive packet memory structure. When 0, RD0-RD7 is always driven. When 1, RD0-RD7 is floated during RECEIVE FRAME STATUS WORD writes (RA2-RA16=0, RCVDMA=1, nRWE0-nRWE3=0).

MSK_CRS100 - Disables CRS100 detection during transmit in half duplex mode (SWFDUP=0).

MDO - MII Management output. The value of this bit drives the MDO pin.

MDI - MII Management input. The value of the MDI pin is readable using this bit.

MDCLK - MII Management clock. The value of this bit drives the MDCLK pin.

MDOE - MII Management output enable. When high pin MDO is driven, when low pin MDO is tri-stated.

The purpose of this interface, along with the corresponding pins is to implement MII PHY management in software.

BANK 3

OFFSET A	NAME REVISION REGISTER	TYPE READ ONLY	SYMBOL REV
HIGH BYTE	[Empty Register]		
	0 0 1 1	0 0	1 1
LOW BYTE	CHIP	REV	
	1 0 0 0	0 0	0 0

CHIP - Chip ID. Can be used by software drivers to identify the device used.

REV - Revision ID. Incremented for each revision of a given device.

OFFSET C	NAME EARLY RCV REGISTER	TYPE READ/WRITE	SYMBOL ERCV
HIGH BYTE	nRXDISC PIN COUNTER		
	0 0 0 0	0 0	0 0
LOW BYTE	RCV DISCRD	0 0	ERCV THRESHOLD
	0 0 0	1 1	1 1 1 1 1

nRXDISC PIN COUNTER - 8-bit counter increments when a packet is discarded due to the nRXDISC pin being active. This counter will be reset to 00 when read. A count of FF will set the RX_DISC INT. The count will wrap around to 00 after FF.

RCV DISCRD - Set to discard a packet being received. Will discard packets only in the process of being received. When set prior to the end of receive packet, bit 4 (RXOVRN) of the interrupt status register will be set to indicate that the packet

was discarded. Otherwise, the packet will be received normally and bit 0 set (RCVINT) in the interrupt status register. RCV DISCRD is self clearing.

ERCV THRESHOLD - Threshold for ERCV interrupt. Specified in 64 byte multiples. Whenever the number of bytes written in memory for the presently received packet exceeds the ERCV THRESHOLD, ERCV INT bit of the INTERRUPT STATUS REGISTER is set.

BANK7

OFFSET 0 THROUGH 7	NAME EXTERNAL REGISTERS	TYPE	SYMBOL
-----------------------	----------------------------	------	--------

nCSOUT is driven low by the SMC91C100FD when a valid access to the EXTERNAL REGISTER range occurs.

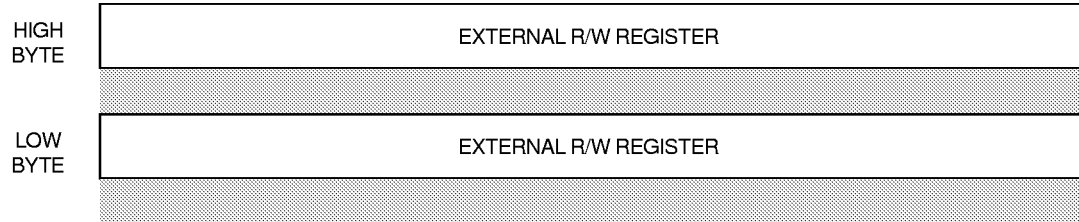

CYCLE	nCSOUT	SMC91C100FD DATA BUS
AEN=0 A3=0 A4-15 matches I/O BASE BANK SELECT = 7	Driven low. Transparently latched on nADS rising edge.	Ignored on writes. Tri-stated on reads.
BANK SELECT = 4,5,6	High	Ignore cycle.
Otherwise	High	Normal SMC91C100FD cycle.

TYPICAL FLOW OF EVENTS FOR TRANSMIT

S/W DRIVER

MAC SIDE

- 1 ISSUE ALLOCATE MEMORY FOR TX - N BYTES - the MMU attempts to allocate N bytes of RAM.
- 2 WAIT FOR SUCCESSFUL COMPLETION CODE - Poll until the ALLOC INT bit is set or enable its mask bit and wait for the interrupt. The TX packet number is now at the Allocation Result Register.
- 3 LOAD TRANSMIT DATA - Copy the TX packet number into the Packet Number Register. Write the Pointer Register, then use a block move operation from the upper layer transmit queue into the Data Register.
- 4 ISSUE "ENQUEUE PACKET NUMBER TO TX FIFO" - This command writes the number present in the Packet Number Register into the TX FIFO. The transmission is now enqueued. No further CPU intervention is needed until a transmit interrupt is generated.
- 5
- 6
- 7 SERVICE INTERRUPT - Read Interrupt Status Register. If it is a transmit interrupt, read the TX Done Packet Number from the Fifo Ports Register. Write the packet number into the Packet Number Register. The corresponding status word is now readable from memory. If status word shows successful transmission, issue RELEASE packet number command to free up the memory used by this packet. Remove packet number from completion FIFO by writing TX INT Acknowledge Register.

The enqueued packet will be transferred to the MAC block as a function of TXENA (nTCR) bit and of the deferral process (1/2 duplex mode only) state.

Upon transmit completion the first word in memory is written with the status word. The packet number is moved from the TX FIFO into the TX completion FIFO. Interrupt is generated by the TX completion FIFO being not empty.

TYPICAL FLOW OF EVENTS FOR RECEIVE

S/W DRIVER	MAC SIDE
1 ENABLE RECEPTION - By setting the RXEN bit.	
2	A packet is received with matching address. Memory is requested from MMU. A packet number is assigned to it. Additional memory is requested if more pages are needed.
3	The internal DMA logic generates sequential addresses and writes the receive words into memory. The MMU does the sequential to physical address translation. If overrun, packet is dropped and memory is released.
4	When the end of packet is detected, the status word is placed at the beginning of the receive packet in memory. Byte count is placed at the second word. If the CRC checks correctly the packet number is written into the RX FIFO. The RX FIFO, being not empty, causes RCV INT (interrupt) to be set. If CRC is incorrect the packet memory is released and no interrupt will occur.
5 SERVICE INTERRUPT - Read the Interrupt Status Register and determine if RCV INT is set. The next receive packet is at receive area. (Its packet number can be read from the FIFO Ports Register). The software driver can process the packet by accessing the RX area, and can move it out to system memory if desired. When processing is complete the CPU issues the REMOVE AND RELEASE FROM TOP OF RX command to have the MMU free up the used memory and packet number.	

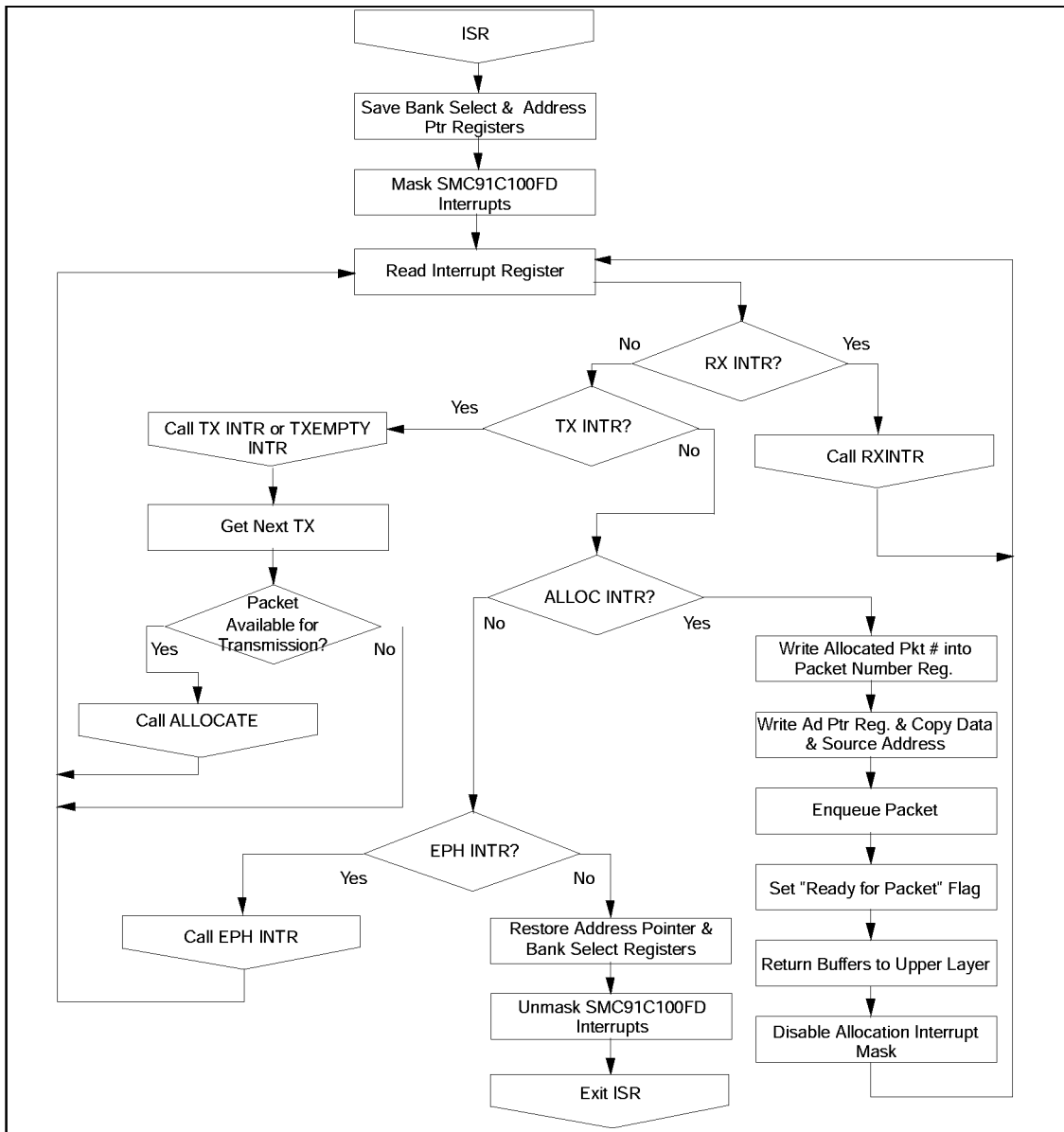

FIGURE 6 - INTERRUPT SERVICE ROUTINE

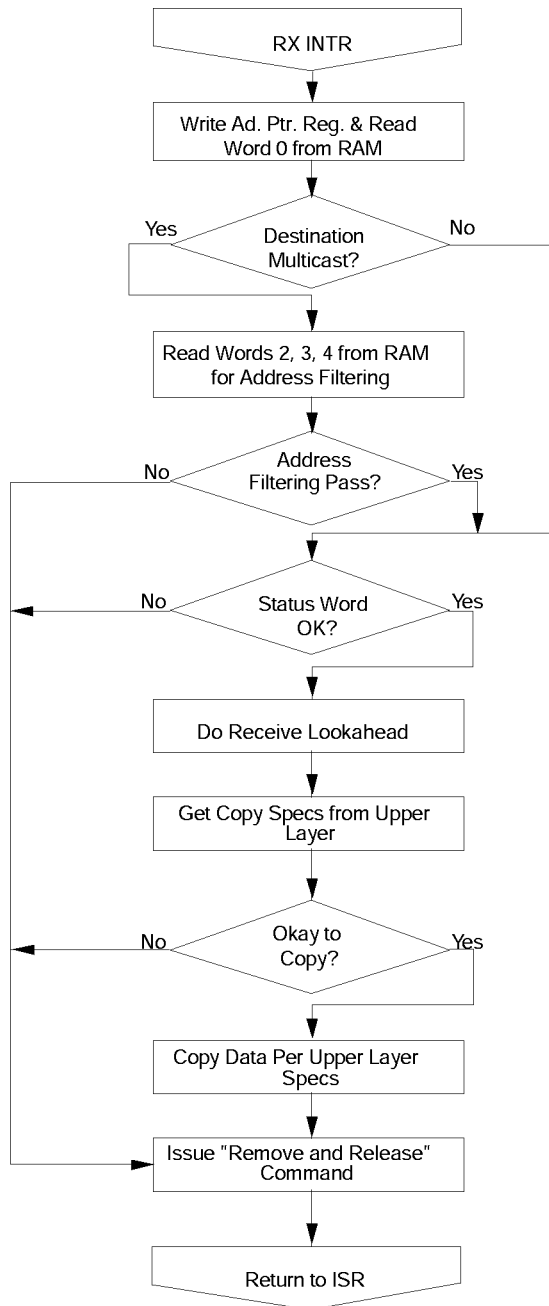

FIGURE 7 - RX INTR

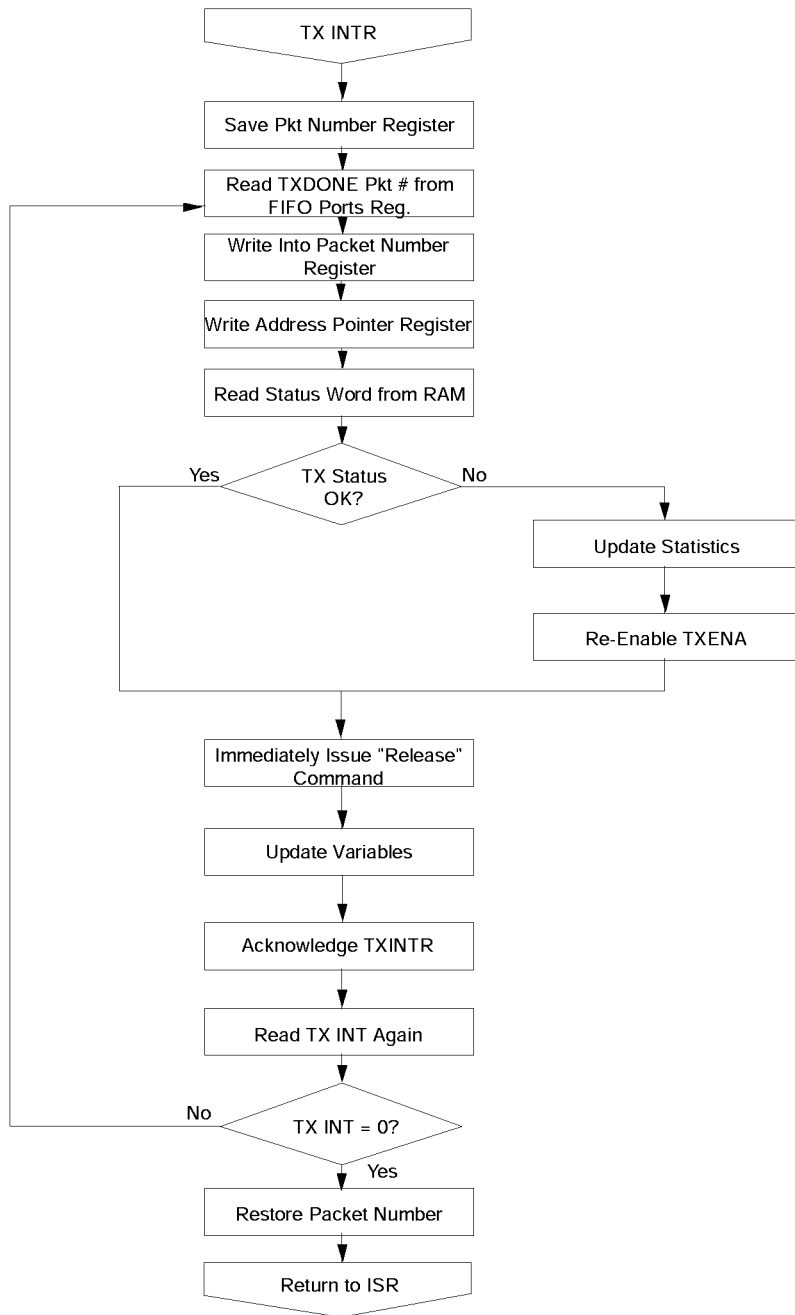

FIGURE 8 - TX INTR

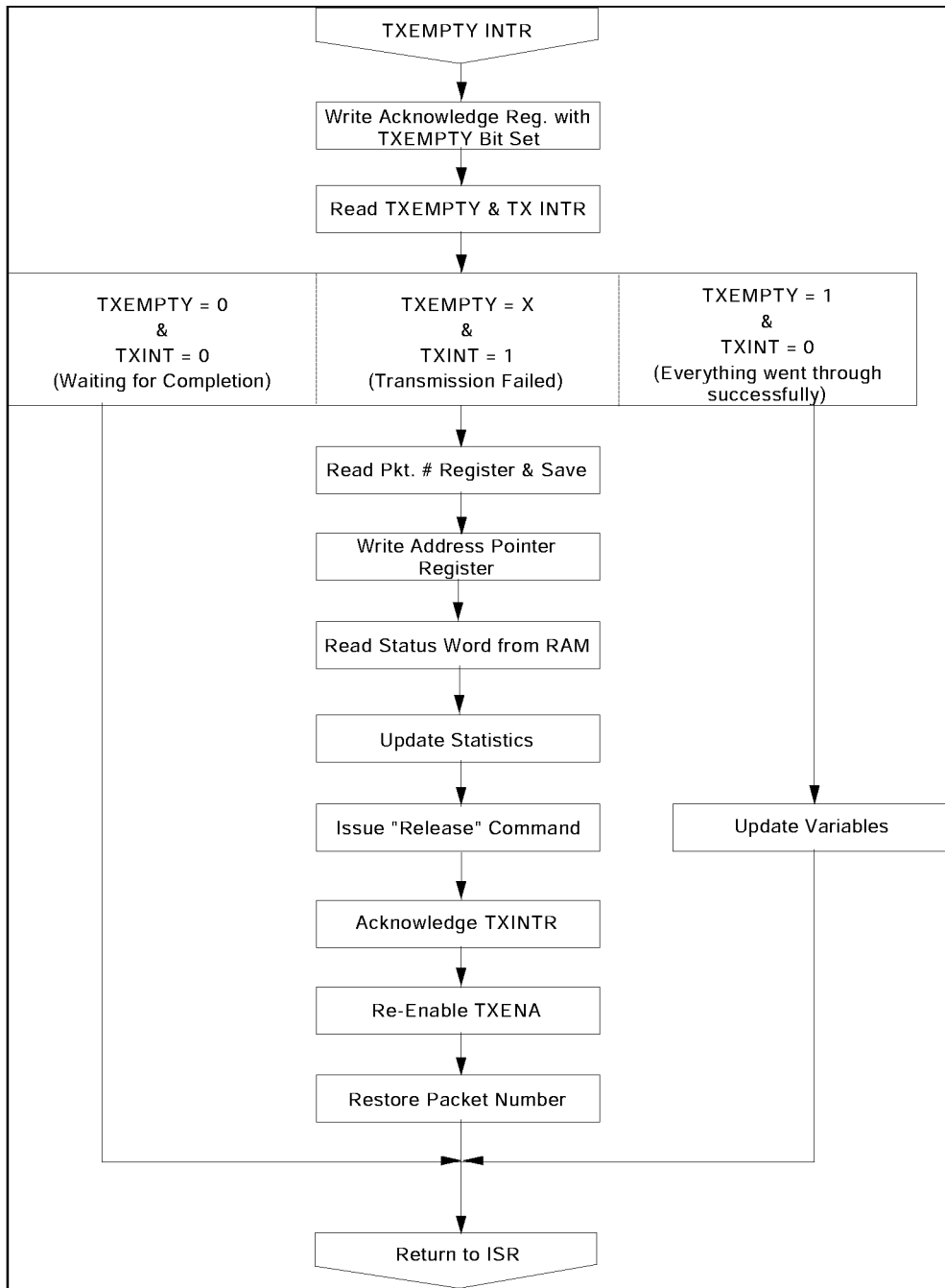

FIGURE 9 - TXEMPTY INTR (ASSUMES AUTO RELEASE OPTION SELECTED)

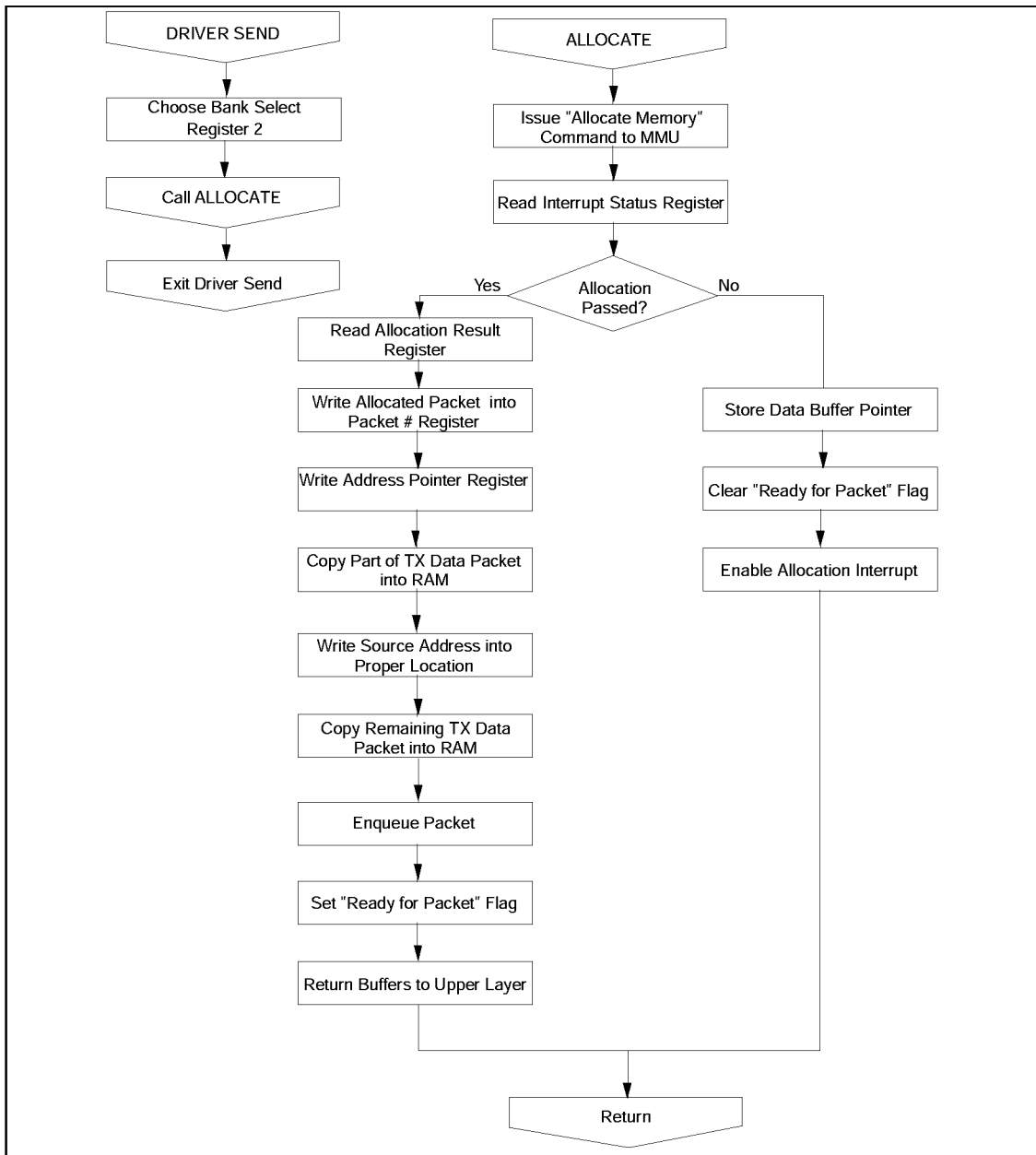

FIGURE 10 - DRIVE SEND AND ALLOCATE ROUTINES

MEMORY PARTITIONING

Unlike other controllers, the SMC91C100FD does not require a fixed memory partitioning between transmit and receive resources. The MMU allocates and de-allocates memory upon different events. An additional mechanism allows the CPU to prevent the receive process from starving the transmit memory allocation.

Memory is always requested by the side that needs to write into it, that is: the CPU for transmit or the MAC for receive. The CPU can control the number of bytes it requests for transmit but it cannot determine the number of bytes the receive process is going to demand. Furthermore, the receive process requests will be dependent on network traffic, in particular on the arrival of broadcast and multicast packets that might not be for the node, and that are not subject to upper layer software flow control.

In order to prevent unwanted traffic from using too much memory, the CPU can program a "memory reserved for transmit" parameter. If the free memory falls below the "memory reserved for transmit" value, MMU requests from the MAC block will fail and the packets will overrun and be ignored. Whenever enough memory is released, packets can be received again. If the reserved value is too large, the node might lose data which is an abnormal condition. If the value is kept at zero, memory allocation is handled on first-come first-served basis for the entire memory capacity.

Note that with the memory management built into the SMC91C100FD, the CPU can dynamically program this parameter. For instance, when the driver does not need to enqueue transmissions, it can allow more memory to be allocated for receive (by reducing the value of the reserved memory). Whenever the driver needs to burst transmissions it can reduce the receive memory allocation. The driver program the parameter as a function of the following variables:

- 1) Free memory (read only register)
- 2) Memory size (read only register)

The reserved memory value can be changed on the fly. If the MEMORY RESERVED FOR TX value is increased above the FREE MEMORY, receive packets in progress are still received, but no new packets are accepted until the FREE MEMORY increases above the MEMORY RESERVED value.

INTERRUPT GENERATION

The interrupt strategy for the transmit and receive processes is such that it does not represent the bottleneck in the transmit and receive queue management between the software driver and the controller. For that purpose there is no register reading necessary before the next element in the queue (namely transmit or receive packet) can be handled by the controller. The transmit and receive results are placed in memory.

The receive interrupt will be generated when the receive queue (FIFO of packets) is not empty and receive interrupts are enabled. This allows the interrupt service routine to process many receive packets without exiting, or one at a time if the ISR just returns after processing and removing one.

There are two types of transmit interrupt strategies:

- 1) One interrupt per packet.
- 2) One interrupt per sequence of packets.

The strategy is determined by how the transmit interrupt bits and the AUTO RELEASE bit are used.

TX INT bit - Set whenever the TX completion FIFO is not empty.

TX EMPTY INT bit - Set whenever the TX FIFO is empty.

AUTO RELEASE - When set, successful transmit packets are not written into completion FIFO, and their memory is released automatically.

1) One interrupt per packet: enable TX INT, set AUTO RELEASE=0. The software driver can find the completion result in memory and process the interrupt one packet at a time. Depending on the completion code the driver will take different actions. Note that the transmit process is working in parallel and other transmissions might be taking place. The SMC91C100FD is virtually queuing the packet numbers and their status words.

In this case, the transmit interrupt service routine can find the next packet number to be serviced by reading the TX DONE PACKET NUMBER at the FIFO PORTS register. This eliminates the need for the driver to keep a list of packet numbers being transmitted. The numbers are queued by the SMC91C100FD and provided back to the CPU as their transmission completes.

2) One interrupt per sequence of packets: Enable TX EMPTY INT and TX INT, set AUTO RELEASE=1. TX EMPTY INT is generated only after transmitting the last packet in the FIFO.

TX INT will be set on a fatal transmit error allowing the CPU to know that the transmit process has stopped and therefore the FIFO will not be emptied.

This mode has the advantage of a smaller CPU overhead, and faster memory de-allocation. Note that when AUTO RELEASE=1 the CPU is not provided with the packet numbers that completed successfully.

Note: The pointer register is shared by any process accessing the SMC91C100FD memory. In order to allow processes to be interruptable, the interrupting process is responsible for reading the pointer value before modifying it, saving it, and restoring it before returning from the interrupt.

Typically there would be three processes using the pointer:

- 1) Transmit loading (sometimes interrupt driven)
- 2) Receive unloading (interrupt driven)
- 3) Transmit Status reading (interrupt driven).

1) and 3) also share the usage of the Packet Number Register. Therefore saving and restoring the PNR is also required from interrupt service routines.

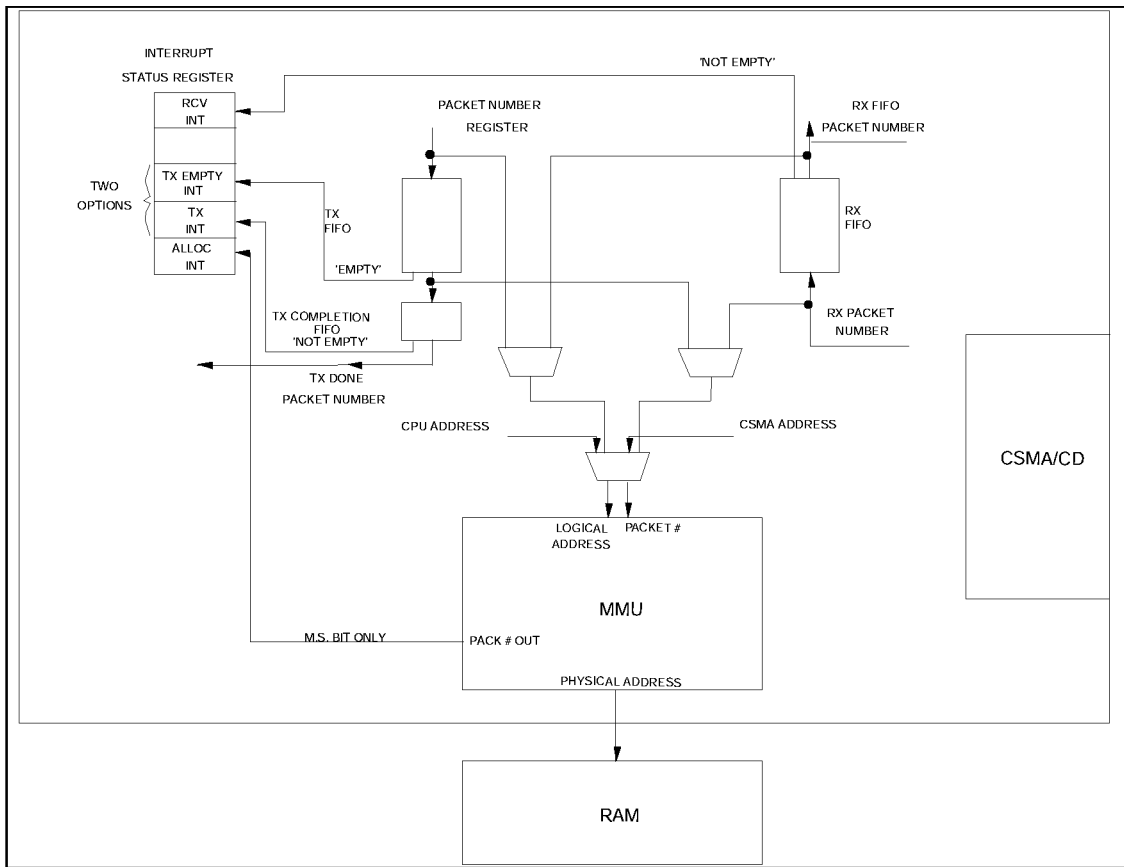

FIGURE 11 - INTERRUPT GENERATION FOR TRANSMIT, RECEIVE, MMU

BOARD SETUP INFORMATION

The following parameters are obtained from the EEPROM as board setup information:

ETHERNET INDIVIDUAL ADDRESS
 I/O BASE ADDRESS
 10BASET or AUI INTERFACE
 MII or ENDEC INTERFACE
 INTERRUPT LINE SELECTION

All the above mentioned values are read from the EEPROM upon hardware reset. Except for the INDIVIDUAL ADDRESS, the value of the IOS switches determines the offset within the EEPROM for these parameters, in such a way that many identical boards can be plugged into the same system by just changing the IOS jumpers.

In order to support a software utility based installation, even if the EEPROM was never programmed, the EEPROM can be written using the SMC91C100FD. One of the IOS combination is associated with a fixed default value for the key parameters (I/O BASE, INTERRUPT) that can always be used regardless of the EEPROM based value being programmed. This value will be used if all IOS pins are left open or pulled high.

The EEPROM is arranged as a 64 x 16 array. The specific target device is the 9346 1024-bit Serial EEPROM. All EEPROM accesses are done in words. All EEPROM addresses in the spec are specified as word addresses.

REGISTER	EEPROM WORD ADDRESS
Configuration Register Base Register	IOS Value * 4 (IOS Value * 4) + 1

INDIVIDUAL ADDRESS 20-22 hex

If IOS2-IOS0 = 7, only the INDIVIDUAL ADDRESS is read from the EEPROM. Currently assigned values are assumed for the other registers. These values are default if the EEPROM read operation follows hardware reset.

The EEPROM SELECT bit is used to determine the type of EEPROM operation: a) normal or b) general purpose register.

a) NORMAL EEPROM OPERATION - EEPROM SELECT bit = 0

On EEPROM read operations (after reset or after setting RELOAD high) the CONFIGURATION REGISTER and BASE REGISTER are updated with the EEPROM values at locations defined by the IOS2-0 pins. The INDIVIDUAL ADDRESS registers are updated with the values stored in the INDIVIDUAL ADDRESS area of the EEPROM.

On EEPROM write operations (after setting the STORE bit) the values of the CONFIGURATION REGISTER and BASE REGISTER are written in the EEPROM locations defined by the IOS2-IOS0 pins.

The three least significant bits of the CONTROL REGISTER (EEPROM SELECT, RELOAD and STORE) are used to control the EEPROM. Their values are not stored nor loaded from the EEPROM.

b) GENERAL PURPOSE REGISTER - EEPROM SELECT bit = 1

On EEPROM read operations (after setting RELOAD high) the EEPROM word address defined by the POINTER REGISTER 6 least significant bits is read into the GENERAL PURPOSE REGISTER.

On EEPROM write operations (after setting the STORE bit) the value of the GENERAL PURPOSE REGISTER is written at the EEPROM word address defined by the POINTER REGISTER 6 least significant bits.

RELOAD and STORE are set by the user to initiate read and write operations respectively. Polling the value until read low is used to determine completion. When an EEPROM access is in progress the STORE and RELOAD bits of CTR will readback as both bits high. No other bits of the SMC91C100FD can be read or written until

the EEPROM operation completes and both bits are clear. This mechanism is also valid for reset initiated reloads.

Note: If no EEPROM is connected to the SMC91C100FD, for example for some embedded applications, the ENEEP pin should be grounded and no accesses to the EEPROM will be attempted. Configuration, Base, and Individual Address assume their default values upon hardware reset and the CPU is responsible for programming them for their final value.

IOS2-0	WORD ADDRESS	16 BITS	
		CONFIGURATION REG.	BASE REG.
000	0h	CONFIGURATION REG.	
	1h		BASE REG.
001	4h	CONFIGURATION REG.	
	5h		BASE REG.
010	8h	CONFIGURATION REG.	
	9h		BASE REG.
011	Ch	CONFIGURATION REG.	
	Dh		BASE REG.
100	10h	CONFIGURATION REG.	
	11h		BASE REG.
101	14h	CONFIGURATION REG.	
	15h		BASE REG.
110	18h	CONFIGURATION REG.	
	19h		BASE REG.
XXX	20h		IA0-1
	21h		IA2-3
	22h		IA4-5

FIGURE 12 - 64 X 16 SERIAL EEPROM MAP

APPLICATION CONSIDERATIONS

The SMC91C100FD is envisioned to fit a few different bus types. This section describes the basic guidelines, system level implications and sample configurations for the most relevant bus types. All applications are based on buffered architectures with a private SRAM bus.

FAST ETHERNET SLAVE ADAPTER

Slave non-intelligent board implementing 100 Mbps and 10 Mbps speeds.

Adapter requires:

- a) SMC91C100FD chip
- b) Four SRAMs (32k x 8 - 25ns)
- c) Serial EEPROM (93C46)
- d) Mbps ENDEC and transceiver chip

- e) Mbps MII compliant PHY
- f) Some bus specific glue logic

Target systems:

- a) VL Local Bus 32 bit systems
- b) High-end ISA or non-burst EISA machines
- c) EISA 32 bit slave

VL Local Bus 32 Bit Systems

On VL Local Bus and other 32 bit embedded systems the SMC91C100FD is accessed as a 32 bit peripheral in terms of the bus interface. All registers except the DATA REGISTER will be accessed using byte or word instructions. Accesses to the DATA REGISTER could use byte, word, or dword instructions.

Table 3 - VL Local Bus Signal Connections

VL BUS SIGNAL	SMC91C100 SIGNAL	NOTES
A2-A15	A2-A15	Address bus used for I/O space and register decoding, latched by nADS rising edge, and transparent on nADS low time.
M/nIO	AEN	Qualifies valid I/O decoding - enabled access when low. This signal is latched by nADS rising edge and transparent on nADS low time.
W/nR	W/nR	Direction of access. Sampled by the SMC91C100FD on first rising clock that has nCYCLE active. High on writes, low on reads.
nRDYRTN	nRDYRTN	Ready return. Direct connection to VL bus.
nLRDY	nSRDY and some logic	nSRDY has the appropriate functionality and timing to create the VL nLRDY except that nLRDY behaves like an open drain output most of the time.
LCLK	LCLK	Local Bus Clock. Rising edges used for synchronous bus interface transactions.

Table 3 - VL Local Bus Signal Connections

VL BUS SIGNAL	SMC91C100 SIGNAL	NOTES																																								
nRESET	RESET	Connected via inverter to the SMC91C100FD.																																								
nBE0 nBE1 nBE2 nBE3	nBE0 nBE1 nBE2 nBE3	Byte enables. Latched transparently by nADS rising edge.																																								
nADS	nADS, nCYCLE	Address Strobe is connected directly to the VL bus. nCYCLE is created typically by using nADS delayed by one LCLK.																																								
IRQn	INTR0-INTR3	Typically uses the interrupt lines on the ISA edge connector of VL bus																																								
D0-D31	D0-D31	<p>32 bit data bus. The bus byte(s) used to access the device are a function of nBE0-nBE3:</p> <table border="1"> <thead> <tr> <th><u>nBE0</u></th> <th><u>nBE1</u></th> <th><u>nBE2</u></th> <th><u>nBE3</u></th> <th></th> </tr> </thead> <tbody> <tr> <td>0</td> <td>0</td> <td>0</td> <td>0</td> <td>Double word access</td> </tr> <tr> <td>0</td> <td>0</td> <td>1</td> <td>1</td> <td>Low word access</td> </tr> <tr> <td>1</td> <td>1</td> <td>0</td> <td>0</td> <td>High word access</td> </tr> <tr> <td>0</td> <td>1</td> <td>1</td> <td>1</td> <td>Byte 0 access</td> </tr> <tr> <td>1</td> <td>0</td> <td>1</td> <td>1</td> <td>Byte 1 access</td> </tr> <tr> <td>1</td> <td>1</td> <td>0</td> <td>1</td> <td>Byte 2 access</td> </tr> <tr> <td>1</td> <td>1</td> <td>1</td> <td>0</td> <td>Byte 3 access</td> </tr> </tbody> </table> <p>Not used = tri-state on reads, ignored on writes. Note that nBE2 and nBE3 override the value of A1, which is tied low in this application.</p>	<u>nBE0</u>	<u>nBE1</u>	<u>nBE2</u>	<u>nBE3</u>		0	0	0	0	Double word access	0	0	1	1	Low word access	1	1	0	0	High word access	0	1	1	1	Byte 0 access	1	0	1	1	Byte 1 access	1	1	0	1	Byte 2 access	1	1	1	0	Byte 3 access
<u>nBE0</u>	<u>nBE1</u>	<u>nBE2</u>	<u>nBE3</u>																																							
0	0	0	0	Double word access																																						
0	0	1	1	Low word access																																						
1	1	0	0	High word access																																						
0	1	1	1	Byte 0 access																																						
1	0	1	1	Byte 1 access																																						
1	1	0	1	Byte 2 access																																						
1	1	1	0	Byte 3 access																																						
nLDEV	nLDEV	nLDEV is a totem pole output. nLDEV is active on valid decodes of A15-A4 and AEN=0.																																								
UNUSED PINS																																										
VCC	nRD nWR																																									
GND	A1 nVLBUS																																									
OPEN	nDATACS																																									

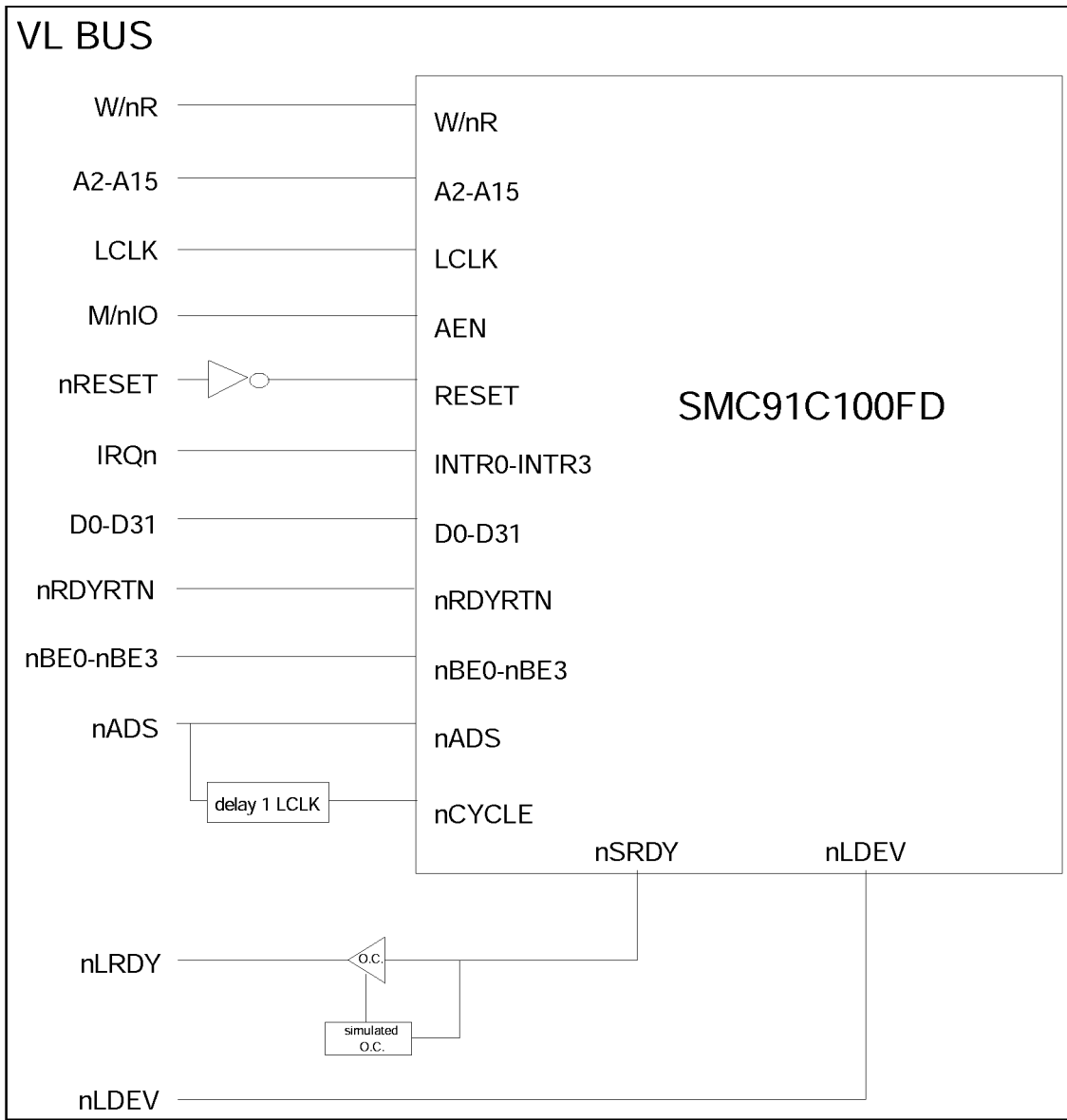

FIGURE 13 - SMC91C100FD ON VL BUS

HIGH-END ISA OR NON-BURST EISA MACHINES

On ISA machines, the SMC91C100FD is (8 bit peripheral) is provided. The signal accessed as a 16 bit peripheral. No support for XT connections are listed in the following table:

Table 4 - High-End ISA or Non-Burst EISA Machines Signal Connectors

ISA BUS SIGNAL	SMC91C100FD SIGNAL	NOTES																
A1-A15	A1-A15	Address bus used for I/O space and register decoding.																
AEN	AEN	Qualifies valid I/O decoding - enabled access when low.																
nIORD	nRD	I/O Read strobe - asynchronous read accesses. Address is valid before leading edge.																
nIOWR	nWR	I/O Write strobe - asynchronous write access. Address is valid before leading edge. Data is latched on trailing edge.																
IOCHRDY	ARDY	This signal is negated on leading nRD, nWR if necessary. It is then asserted on CLK rising edge after the access condition is satisfied.																
RESET	RESET																	
A0	nBE0																	
nSBHE	nBE1																	
IRQn	INTR0-INTR3																	
D0-D15	D0-D15	16 bit data bus. The bus byte(s) used to access the device are a function of nBE0 and nBE1: <table border="0"> <tr> <td><u>nBE0</u></td> <td><u>nBE1</u></td> <td><u>D0-D7</u></td> <td><u>D8-D15</u></td> </tr> <tr> <td>0</td> <td>0</td> <td>Lower</td> <td>Upper</td> </tr> <tr> <td>0</td> <td>1</td> <td>Lower</td> <td>Not used</td> </tr> <tr> <td>1</td> <td>0</td> <td>Not used</td> <td>Upper</td> </tr> </table> Not used = tri-state on reads, ignored on writes	<u>nBE0</u>	<u>nBE1</u>	<u>D0-D7</u>	<u>D8-D15</u>	0	0	Lower	Upper	0	1	Lower	Not used	1	0	Not used	Upper
<u>nBE0</u>	<u>nBE1</u>	<u>D0-D7</u>	<u>D8-D15</u>															
0	0	Lower	Upper															
0	1	Lower	Not used															
1	0	Not used	Upper															
nIOCS16	nLDEV buffered	nLDEV is a totem pole output. Must be buffered using an open collector driver. nLDEV is active on valid decodes of A15-A4 and AEN=0.																
UNUSED PINS																		
GND	LCLK nADS																	

Table 4 - High-End ISA or Non-Burst EISA Machines Signal Connectors

ISA BUS SIGNAL	SMC91C100FD SIGNAL	NOTES
VCC	nBE2 nBE3 nCYCLE W/nR nRDYRTN	No upper word access.

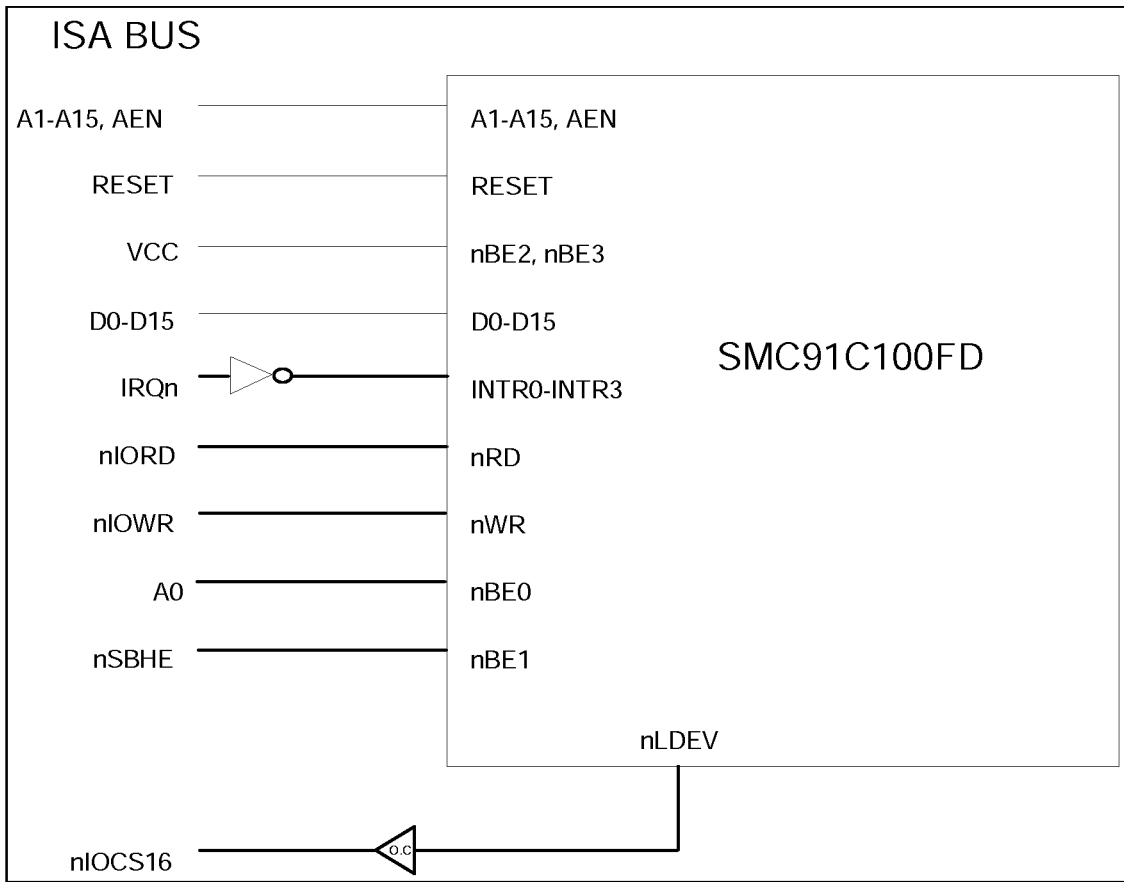

FIGURE 14 - SMC91C100FD ON ISA BUS

EISA 32 BIT SLAVE

On EISA the SMC91C100FD is accessed as a 32 bit I/O slave, along with a Slave DMA type "C" data path option. As an I/O slave, the SMC91C100FD uses asynchronous accesses. In creating nRD and nWR inputs, the timing information is externally derived from nCMD edges. Given that the access will be at least 1.5 to 2 clocks (more than 180ns at least) there is no need to negate EXRDY, simplifying the EISA interface implementation. As a DMA Slave, the

SMC91C100FD accepts burst transfers and is able to sustain the peak rate of one doubleword every BCLK. Doubleword alignment is assumed for DMA transfers. Up to three extra bytes in the beginning and at the end of the transfer should be moved by the CPU using I/O accesses to the Data Register. The SMC91C100FD will sample EXRDY and postpone DMA cycles if the memory cycle solicits wait states.

Table 5 - EISA 32 Bit Slave Signal Connections

EISA BUS SIGNAL	SMC91C100FD SIGNAL	NOTES
LA2-LA15	A2-A15	Address bus used for I/O space and register decoding, latched by nADS (nSTART) trailing edge.
M/nIO AEN	AEN	Qualifies valid I/O decoding - enabled access when low. These signals are externally ORed. Internally the AEN pin is latched by nADS rising edge and transparent while nADS is low.
Latched W-R combined with nCMD	nRD	I/O Read strobe - asynchronous read accesses. Address is valid before its leading edge. Must not be active during DMA bursts if DMA is supported.
Latched W-R combined with nCMD	nWR	I/O Write strobe - asynchronous write access. Address is valid before leading edge . Data latched on trailing edge. Must not be active during DMA bursts if DMA is supported.
nSTART	nADS	Address strobe is connected to EISA nSTART.
RESDRV	RESET	
nBE0 nBE1 nBE2 nBE3	nBE0 n BE1 nBE2 nBE3	Byte enables. Latched on nADS rising edge.
IRQn	INTR0-INTR3	Interrupts used as active high edge triggered

Table 5 - EISA 32 Bit Slave Signal Connections

EISA BUS SIGNAL	SMC91C100FD SIGNAL	NOTES																																								
D0-D31	D0-D31	<p>32 bit data bus. The bus byte(s) used to access the device are a function of nBE0-nBE3:</p> <table border="1" data-bbox="745 323 1045 575"> <thead> <tr> <th>nBE0</th> <th>nBE1</th> <th>nBE2</th> <th>nBE3</th> <th></th> </tr> </thead> <tbody> <tr> <td>0</td> <td>0</td> <td>0</td> <td>0</td> <td>Double word access</td> </tr> <tr> <td>0</td> <td>0</td> <td>1</td> <td>1</td> <td>Low word access</td> </tr> <tr> <td>1</td> <td>1</td> <td>0</td> <td>0</td> <td>High word access</td> </tr> <tr> <td>0</td> <td>1</td> <td>1</td> <td>1</td> <td>Byte 0 access</td> </tr> <tr> <td>1</td> <td>0</td> <td>1</td> <td>1</td> <td>Byte 1 access</td> </tr> <tr> <td>1</td> <td>1</td> <td>0</td> <td>1</td> <td>Byte 2 access</td> </tr> <tr> <td>1</td> <td>1</td> <td>1</td> <td>0</td> <td>Byte 3 access</td> </tr> </tbody> </table> <p>Not used = tri-state on reads, ignored on writes. Note that nBE2 and nBE3 override the value of A1, which is tied low in this application. Other combinations of nBE are not supported by the SMC91C100FD. Software drivers are not anticipated to generate them.</p>	nBE0	nBE1	nBE2	nBE3		0	0	0	0	Double word access	0	0	1	1	Low word access	1	1	0	0	High word access	0	1	1	1	Byte 0 access	1	0	1	1	Byte 1 access	1	1	0	1	Byte 2 access	1	1	1	0	Byte 3 access
nBE0	nBE1	nBE2	nBE3																																							
0	0	0	0	Double word access																																						
0	0	1	1	Low word access																																						
1	1	0	0	High word access																																						
0	1	1	1	Byte 0 access																																						
1	0	1	1	Byte 1 access																																						
1	1	0	1	Byte 2 access																																						
1	1	1	0	Byte 3 access																																						
nEX32 nNOWS (optional additional logic)	nLDEV	<p>nLDEV is a totem pole output. nLDEV is active on valid decodes of SMC91C100FD pins A15-A4, and AEN=0. nNOWS is similar to nLDEV except that it should go inactive on nSTART rising. nNOWS can be used to request compressed cycles (1.5 BCLK long, nRD/nWR will be 1/2 BCLK wide).</p>																																								
THE FOLLOWING SIGNALS SUPPORT SLAVE DMA TYPE "C" BURST CYCLES																																										
BCLK	LCLK	EISA Bus Clock. Data transfer clock for DMA bursts.																																								
nDAK<n>	nDATACS	DMA Acknowledge. Active during Slave DMA cycles. Used by the SMC91C100FD as nDATACS direct access to data path.																																								
nIORC	W/nR	Indicates the direction and timing of the DMA cycles. High during SMC91C100FD writes, low during SMC91C100FD reads.																																								
nIOWC	nCYCLE	Indicates slave DMA writes.																																								
nEXRDY	nRDYRTN	EISA bus signal indicating whether a slave DMA cycle will take place on the next BCLK rising edge, or should be postponed. nRDYRTN is used as an input in the slave DMA mode to bring in EXRDY.																																								

Table 5 - EISA 32 Bit Slave Signal Connections

EISA BUS SIGNAL	SMC91C100FD SIGNAL	NOTES
UNUSED PINS		
VCC	nVLBUS	
GND	A1	

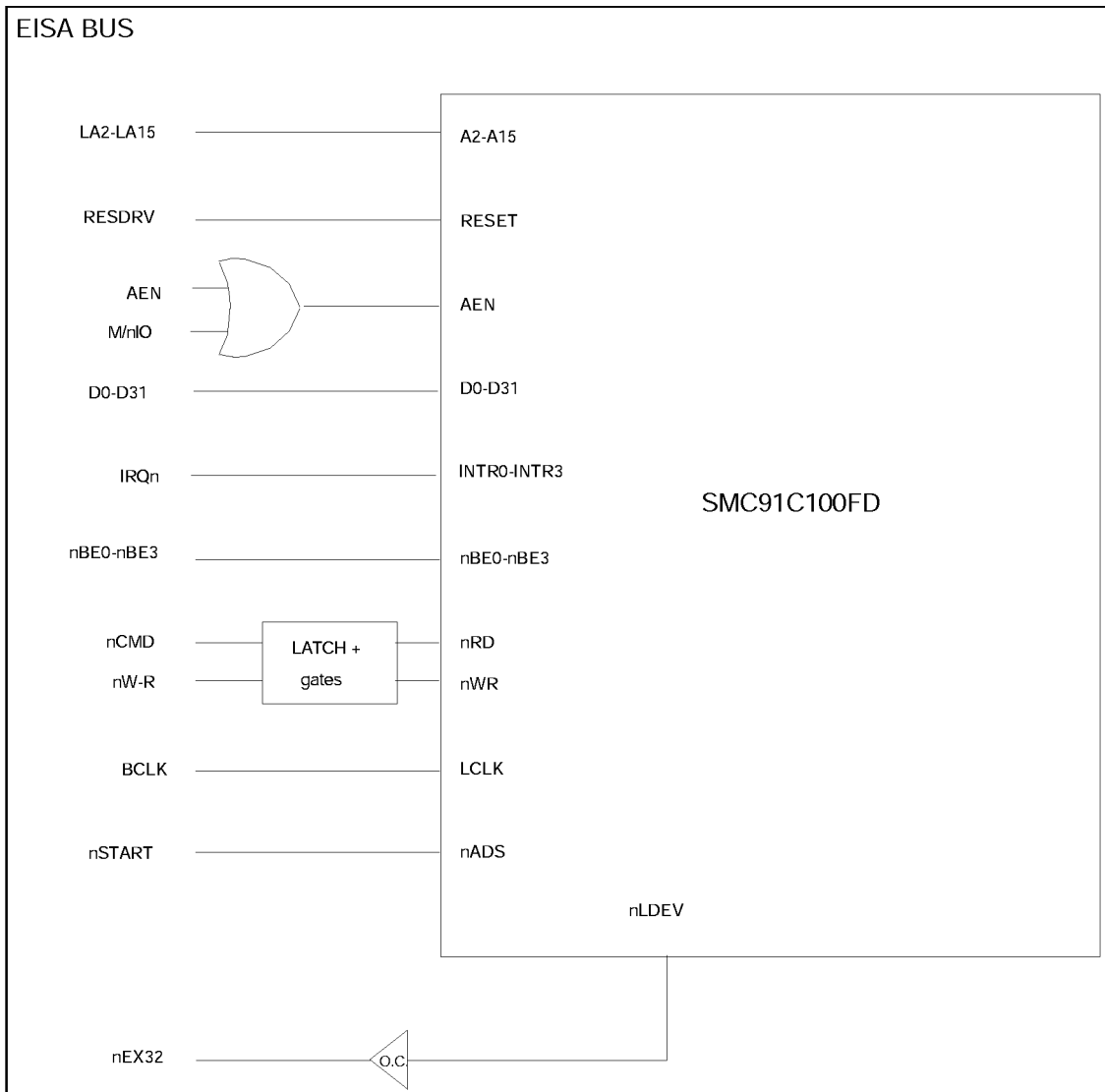

FIGURE 15 - SMC91C100FD ON EISA BUS

OPERATIONAL DESCRIPTION

MAXIMUM GUARANTEED RATINGS*

Operating Temperature Range	0 EC to +70EC
Storage Temperature Range	-55EC°to + 150EC
Lead Temperature Range (soldering, 10 seconds)	+325EC
Positive Voltage on any pin, with respect to Ground	$V_{CC} + 0.3V$
Negative Voltage on any pin, with respect to Ground	-0.3V
Maximum V_{CC}	+7V

*Stresses above those listed above could cause permanent damage to the device. This is a stress rating only and functional operation of the device at any other condition above those indicated in the operation sections of this specification is not implied.

Note: When powering this device from laboratory or system power supplies, it is important that the Absolute Maximum Ratings not be exceeded or device failure can result. Some power supplies exhibit voltage spikes on their outputs when the AC power is switched on or off. In addition, voltage transients on the AC power line may appear on the DC output. If this possibility exists, it is suggested that a clamp circuit be used.

DC ELECTRICAL CHARACTERISTICS

($T_A = 0EC - 70EC$, $V_{CC} = +5.0 V \pm 10\%$)

PARAMETER	SYMBOL	MIN	TYP	MAX	UNITS	COMMENTS
I Type Input Buffer						
Low Input Level	V_{ILI}			0.8	V	TTL Levels
High Input Level	V_{IHI}	2.0			V	
IS Type Input Buffer						
Low Input Level	V_{ILIS}			0.8	V	Schmitt Trigger
High Input Level	V_{IHIS}	2.2			V	Schmitt Trigger
Schmitt Trigger Hysteresis	V_{HYS}		250		mV	
I_{CLK} Input Buffer						
Low Input Level	V_{ILCK}			0.4	V	
High Input Level	V_{IHCK}	3.0			V	

PARAMETER	SYMBOL	MIN	TYP	MAX	UNITS	COMMENTS
Input Leakage (All I and IS buffers except pins with pullups/pulldowns)						
Low Input Leakage	I_{IL}	-10		+10	A	$V_{IN} = 0$
High Input Leakage	I_{IH}	-10		+10	A	$V_{IN} = V_{CC}$
IP Type Buffers						
Input Current	I_{IL}	-150	-75		A	$V_{IN} = 0$
ID Type Buffers						
Input Current	I_{IH}		+75	+150	A	$V_{IN} = V_{CC}$
O4 Type Buffer						
Low Output Level	V_{OL}			0.4	V	$I_{OL} = 4 \text{ mA}$
High Output Level	V_{OH}	2.4			V	$I_{OH} = -2 \text{ mA}$
Output Leakage	I_{OL}	-10		+10	A	$V_{IN} = 0 \text{ to } V_{CC}$
I/O4 Type Buffer						
Low Output Level	V_{OL}			0.4	V	$I_{OL} = 4 \text{ mA}$
High Output Level	V_{OH}	2.4			V	$I_{OH} = -2 \text{ mA}$
Output Leakage	I_{OL}	-10		+10	A	$V_{IN} = 0 \text{ to } V_{CC}$
O12 Type Buffer						
Low Output Level	V_{OL}			0.5	V	$I_{OL} = 12 \text{ mA}$
High Output Level	V_{OH}	2.4			V	$I_{OH} = -6 \text{ mA}$
Output Leakage	I_{OL}	-10		+10	A	$V_{IN} = 0 \text{ to } V_{CC}$

PARAMETER	SYMBOL	MIN	TYP	MAX	UNITS	COMMENTS
O16 Type Buffer						
Low Output Level	V_{OL}			0.5	V	$I_{OL} = 16 \text{ mA}$
High Output Level	V_{OH}	2.4			V	$I_{OH} = -8 \text{ mA}$
Output Leakage	I_{OL}	-10		+10	A	$V_{IN} = 0 \text{ to } V_{CC}$
OD16 Type Buffer						
Low Output Level	V_{OL}			0.5	V	$I_{OL} = 16 \text{ mA}$
Output Leakage	I_{OL}	-10		+10	A	$V_{IN} = 0 \text{ to } V_{CC}$
O24 Type Buffer						
Low Output Level	V_{OL}			0.5	V	$I_{OL} = 24 \text{ mA}$
High Output Level	V_{OH}	2.4			V	$I_{OH} = -12 \text{ mA}$
Output Leakage	I_{OL}	-10		+10	A	$V_{IN} = 0 \text{ to } V_{CC}$
I/O24 Type Buffer						
Low Output Level	V_{OL}			0.5	V	$I_{OL} = 24 \text{ mA}$
High Output Level	V_{OH}	2.4			V	$I_{OH} = -12 \text{ mA}$
Output Leakage	I_{OL}	-10		+10	A	$V_{IN} = 0 \text{ to } V_{CC}$
Supply Current Active	I_{CC}		60	95	mA	All outputs open.
Supply Current Standby	I_{CSBY}		8		mA	

CAPACITANCE $T_A = 25^\circ\text{C}$; $f_c = 1\text{MHz}$; $V_{CC} = 5\text{V}$

PARAMETER	SYMBOL	LIMITS			UNIT	TEST CONDITION
		MIN	TYP	MAX		
Clock Input Capacitance	C_{IN}			20	pF	All pins except pin under test tied to AC ground
Input Capacitance	C_{IN}			10	pF	
Output Capacitance	C_{OUT}			20	pF	

CAPACITIVE LOAD ON OUTPUTS

nARDY, D0-D31 (non VLBUS)	240 pF
D0-D31 in VLBUS	45 pF
All other outputs	45 pF

TIMING DIAGRAMS



FIGURE 16 - ASYNCHRONOUS CYCLE - $nADS=0$

	PARAMETER	MIN	TYP	MAX	UNITS
t1	A1-A15, AEN, nBE0-nBE3 Valid and nADS Low Setup to nRD, nWR Active	25			ns
t2	A1-A15, AEN, nBE0-nBE3 Hold After nRD, nWR Inactive (Assuming nADS Tied Low)	20			ns
t3	nRD Low to Valid Data			40	ns
t4	nRD High to Data Floating			30	ns
t5	Data Setup to nWR Inactive	30			ns
t5A	Data Hold After nWR Inactive	5			ns

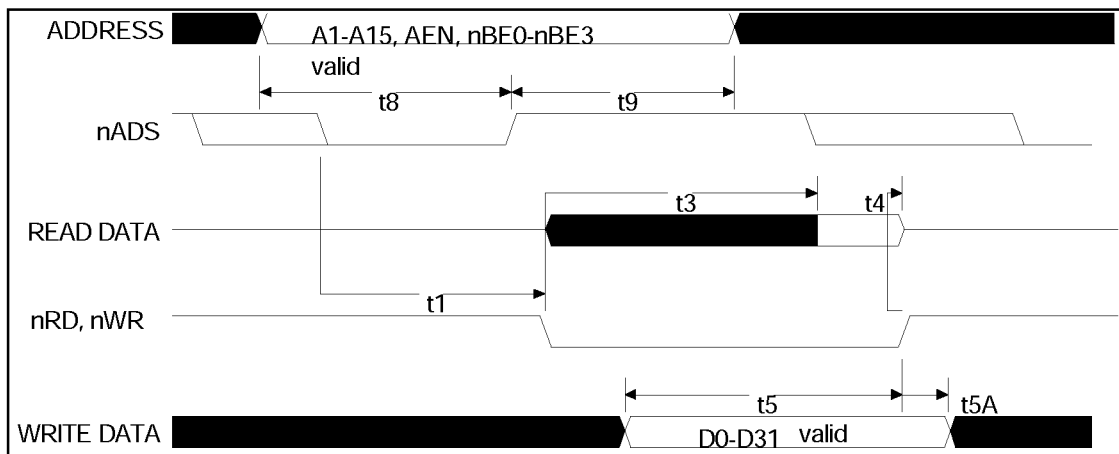

FIGURE 17 - ASYNCHRONOUS CYCLE - USING nADS

	PARAMETER	MIN	TYP	MAX	UNITS
t1	A1-A15, AEN, nBE0-nBE3 Valid and nADS Low Setup to nRD, nWR Active	25			ns
t3	nRD Low to Valid Data			40	ns
t4	nRD High to Data Floating			30	ns
t5	Data Setup to nWR Inactive	30			ns
t5A	Data Hold After nWR Inactive	5			ns
t8	A1-A15, AEN, nBE0-nBE3 Setup to nADS Rising	10			ns
t9	A1-A15, AEN, nBE0-nBE3 Hold after nADS Rising	15			ns

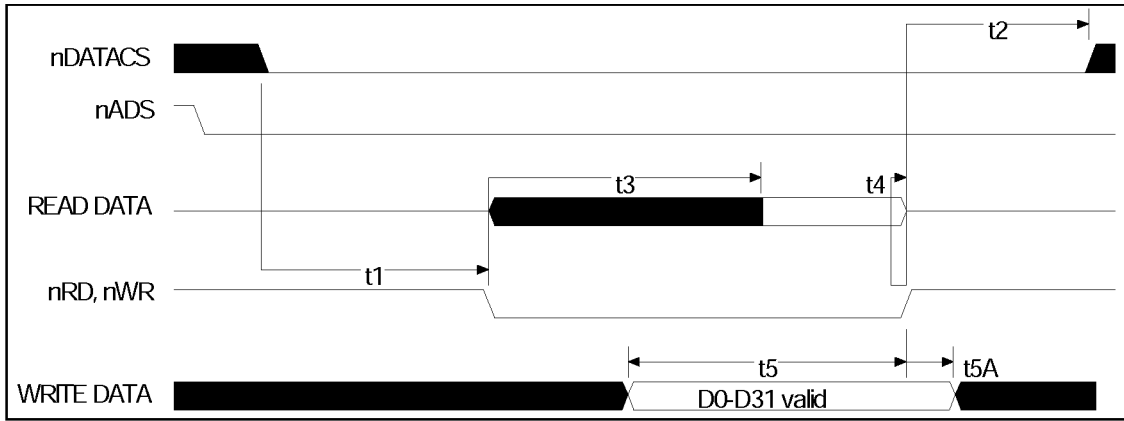

FIGURE 18 - ASYNCHRONOUS CYCLE - nADS=0

(nDATAACS Used to Select Data Register; Must Be 32 Bit Access)

	PARAMETER	MIN	TYP	MAX	UNITS
t1	A1-A15, AEN, nBE0-nBE3 Valid and nADS Low Setup to nRD, nWR Active	25			ns
t2	A1-A15, AEN, nBE0-nBE3 Hold After nRD, nWR Inactive (Assuming nADS Tied Low)	20			ns
t3	nRD Low to Valid Data			40	ns
t4	nRD High to Data Floating			30	ns
t5	Data Setup to nWR Inactive	30			ns
t5A	Data Hold After nWR Inactive	5			ns

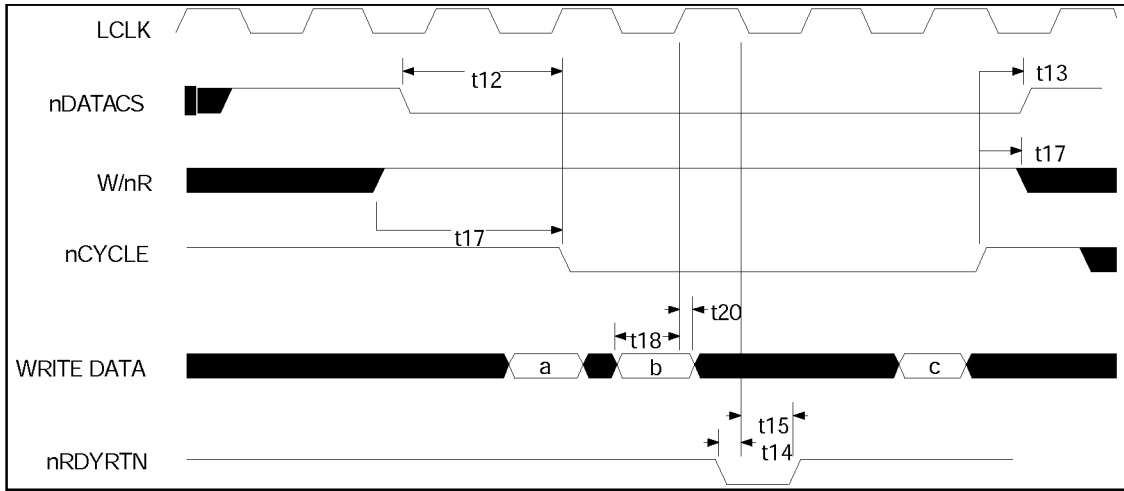

FIGURE 19 - BURST WRITE CYCLES - $nVLBUS=1$

	PARAMETER	MIN	TYP	MAX	UNITS
t12	nDATACS Setup to Either nCYCLE or W/nR Falling	60			ns
t13	nDATACS Hold after Either nCYCLE or W/nR Rising	30			ns
t14	nRDYRTN Setup to LCLK Falling	15			ns
t15	nRDYRTN Hold after LCLK Falling	2			ns
t17	nCYCLE High and W/nR High Overlap	50			ns
t18	Data Setup to LCLK Rising (Write)	13			ns
t20	Data Hold from LCLK Rising (Write)	5			ns

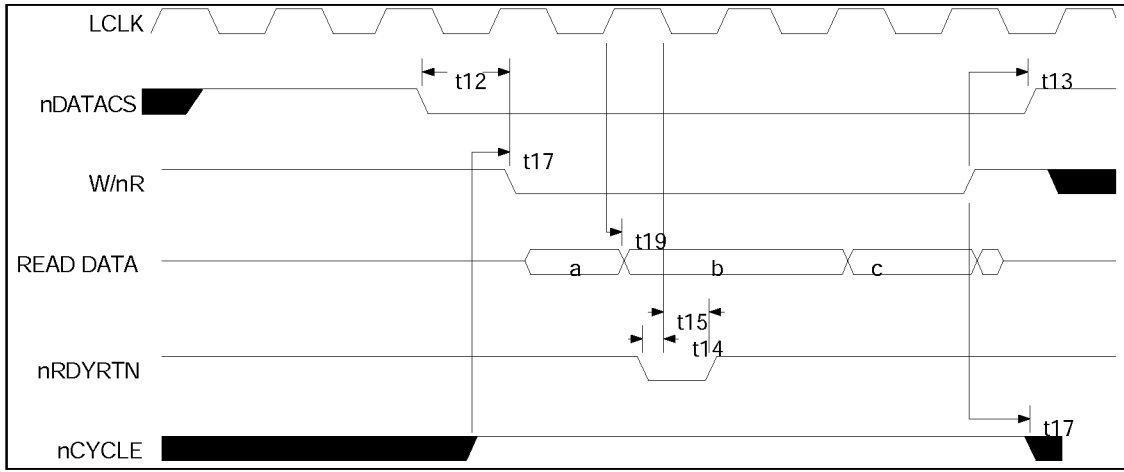

FIGURE 20 - BURST READ CYCLES - nVLBUS=1

	PARAMETER	MIN	TYP	MAX	UNITS
t12	nDATACS Setup to Either nCYCLE or W/nR Falling	60			ns
t13	nDATACS Hold after Either nCYCLE or W/nR Rising	30			ns
t14	nRDYRTN Setup to LCLK Falling	15			ns
t15	nRDYRTN Hold after LCLK Falling	2			ns
t17	nCYCLE High and W/nR High Overlap	50			ns
t19	Data Delay from LCLK Rising (Read)	5*		38**	ns

Note *: (holdt.)

Note **: (Setupt.)

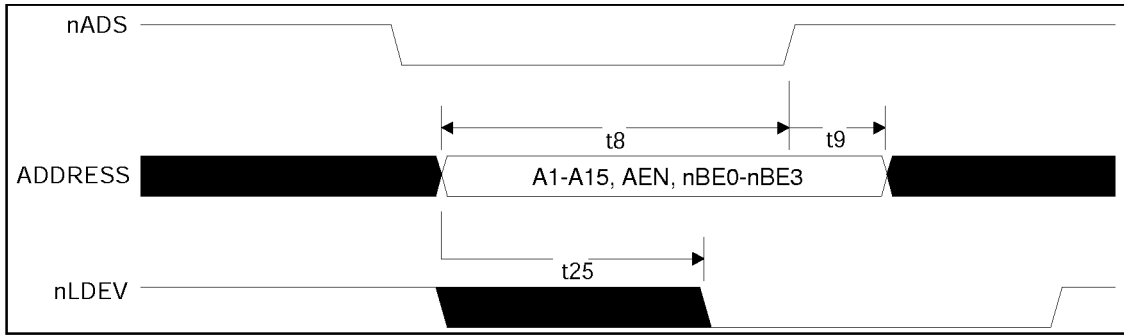

FIGURE 21 - ADDRESS LATCHING FOR ALL MODES

	PARAMETER	MIN	TYP	MAX	UNITS
t8	A1-A15, AEN, nBE0-nBE3 Setup to nADS Rising	10			ns
t9	A1-A15, AEN, nBE0-nBE3 Hold After nADS Rising	15			ns
t25	A4-A15, AEN to nLDEV Delay			20	ns

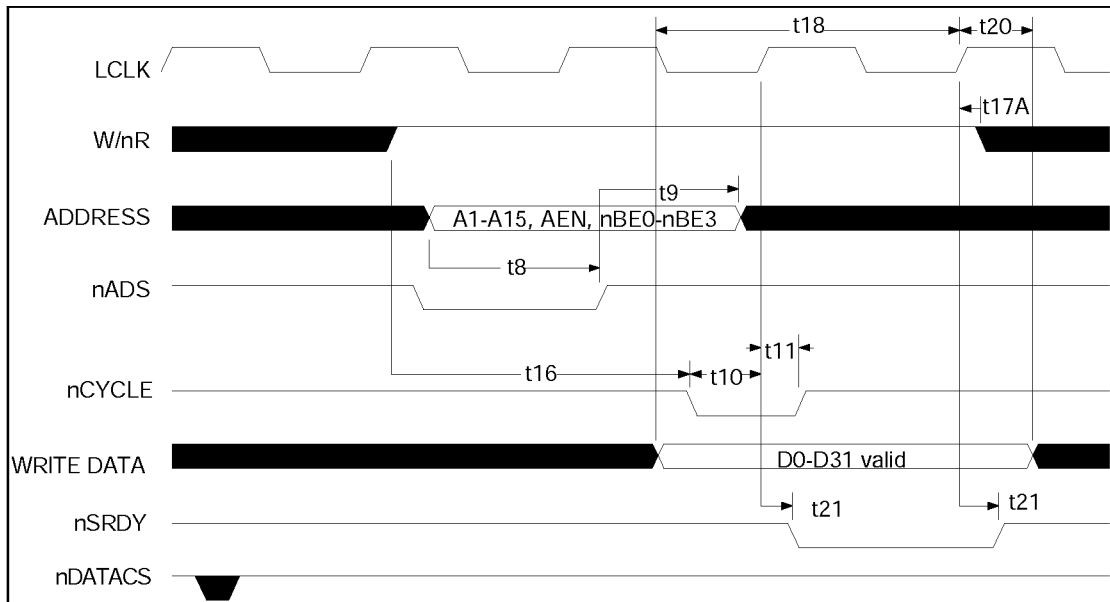

FIGURE 22 - SYNCHRONOUS WRITE CYCLE - nVLBUS=0

	PARAMETER	MIN	TYP	MAX	UNITS
t8	A1-A15, AEN, nBE0-nBE3 Setup to nADS Rising	10			ns
t9	A1-A15, AEN, nBE0-nBE3 Hold After nADS Rising	15			ns
t10	nCYCLE Setup to LCLK Rising	7			ns
t11	nCYCLE Hold after LCLK Rising (Non-Burst Mode)	3			ns
t16	W/nR Setup to nCYCLE Active	30			ns
t17A	W/nR Hold after LCLK Rising with nLRDY Active	5			ns
t18	Data Setup to LCLK Rising (Write)	13			ns
t20	Data Hold from LCLK Rising (Write)	5			ns
t21	nLRDY Delay from LCLK Rising			10	ns

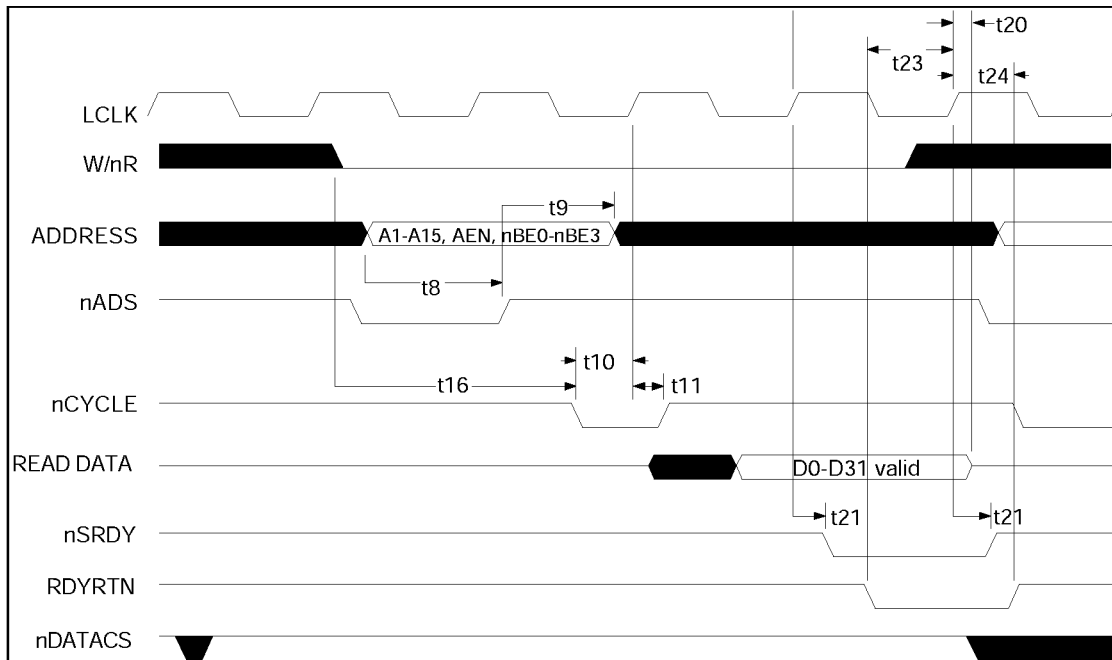

FIGURE 23 - SYNCHRONOUS READ CYCLE - nVLBUS=0

	PARAMETER	MIN	TYP	MAX	UNITS
t8	A1-A15, AEN, nBE0-nBE3 Setup to nADS Rising	10			ns
t9	A1-A15, AEN, nBE0-nBE3 Hold After nADS Rising	15			ns
t10	nCYCLE Setup to LCLK Rising	7			ns
t11	nCYCLE Hold after LCLK Rising (Non-Burst Mode)	3			ns
t16	W/nR Setup to nCYCLE Active	30			ns
t20	Data Hold from LCLK Rising (Read)	5			ns
t21	nLRDY Delay from LCLK Rising			10	ns
t23	nRDYRTN Setup to LCLK Rising	7			ns
t24	nRDYRTN Hold after LCLK Rising	3			ns

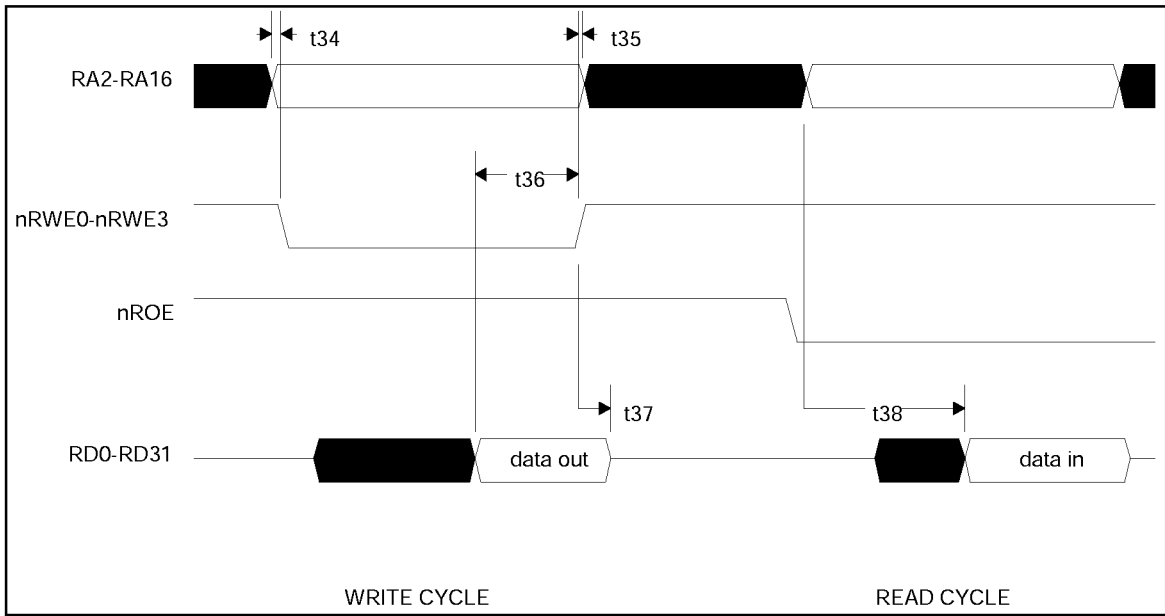

FIGURE 24 - SRAM INTERFACE

	PARAMETER	MIN	TYP	MAX	UNITS
t34	RA2-RA16 Setup to nRWE-0-nRWE3 Falling	0			ns
t35	RA2-RA16 Hold After nRWE-0-nRWE3, nROE Rising	0			ns
t36	Write - RD0-RD31 Setup to nRWE0-nRWE3 Rising	12			ns
t37	Write - RD0-RD31 Hold after nRWE0-nRWE3 Rising	0			ns
t38	Read - RA2-RA16 Valid to RD0-RD31 Valid			25	ns

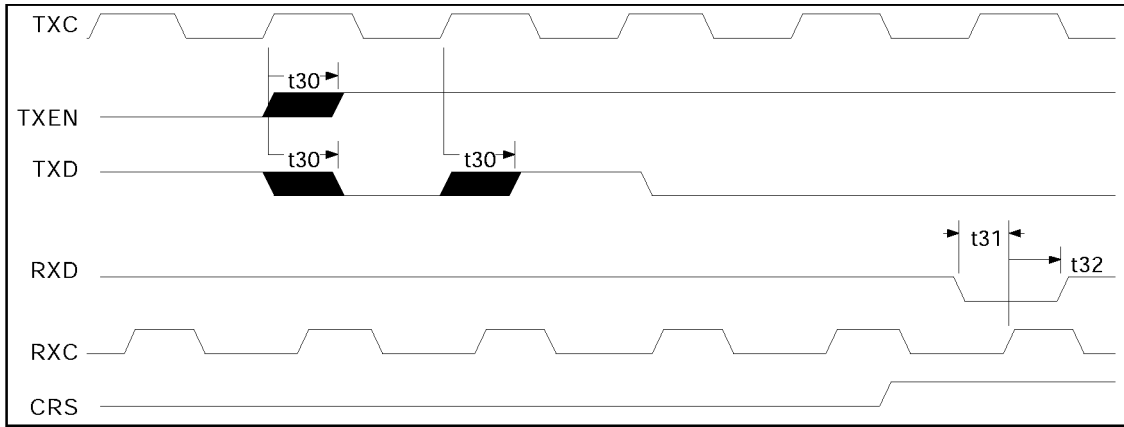

FIGURE 25 - ENDEC INTERFACE - 10 MBPS

	PARAMETER	MIN	TYP	MAX	UNITS
t30	TXD, TXEN Delay from TXC Rising	0		40	ns
t31	RXD Setup to RXC Rising	10			ns
t32	RXD Hold After RXC Rising	30			ns

Notes:

1. CRS input might be asynchronous to RXC.
2. RXC starts after CRS goes active. RXC stops after CRS goes inactive.
3. COL is an asynchronous input.

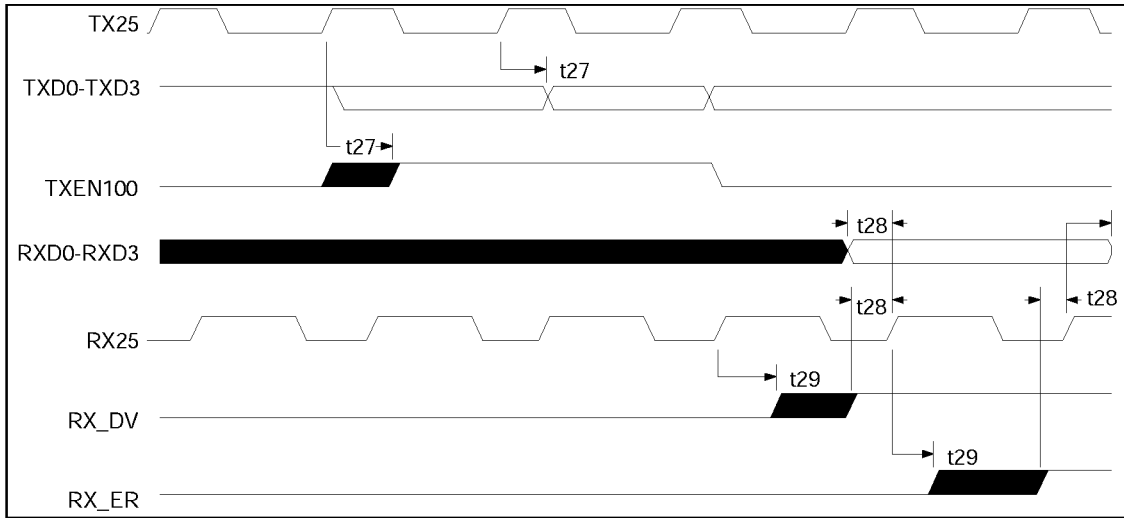

FIGURE 26 - MII INTERFACE

	PARAMETER	MIN	TYP	MAX	UNITS
t27	TXD0-TXD3, TXEN100 Delay from TX25 Rising	0		15	ns
t28	RXD0-RXD3, RX_DV, RX_ER Setup to RX25 Rising	10			ns
t29	RXD0-RXD3, RX_DV, RX_ER Hold After RX25 Rising	10			ns

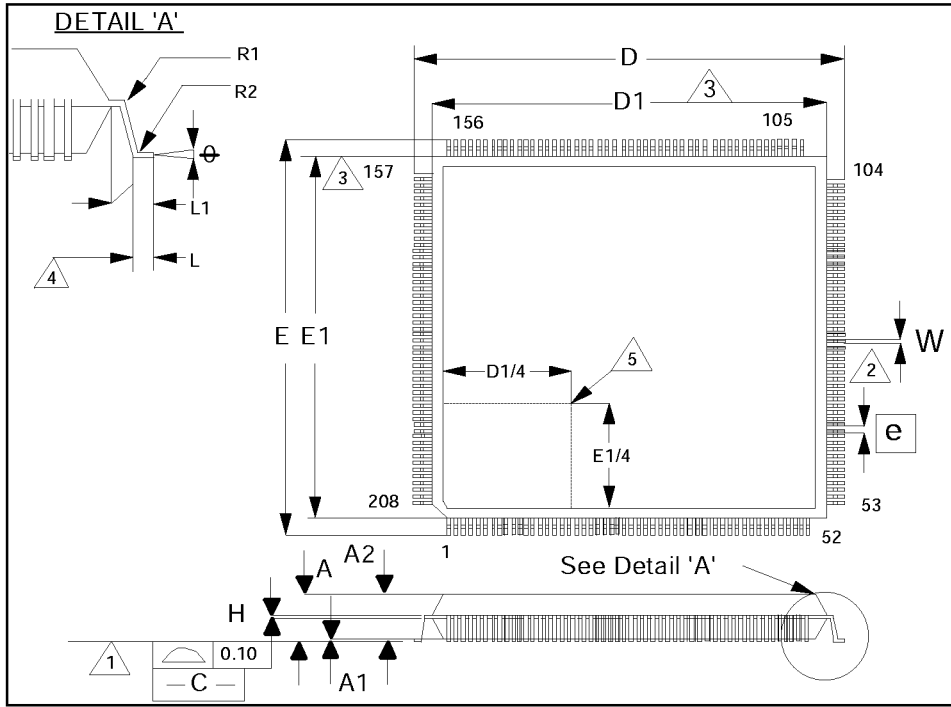

FIGURE 27 - 208 PIN QFP PACKAGE OUTLINES

	MIN	NOM	MAX
A			4.07
A1	0.05		0.5
A2	3.17		3.67
D	30.35	30.60	30.85
D1	27.90	28.00	28.10
E	30.35	30.60	30.85
E1	27.90	28.00	28.10
H	0.09		0.23
L	0.35	0.5	0.65
L1		1.30	
e	0.50BSC		
θ	0E		7E
W	0.10		0.30
R1		0.20	
R2		0.30	

Notes:

- ① Coplanarity is 0.100 mm maximum
- ② Tolerance on the position of the leads is 0.08 mm maximum
- ③ Package body dimensions D1 and E1 do not include the mold protrusion. Maximum mold protrusion is 0.25 mm
- ④ Dimensions for foot length L when measured at the centerline of the leads are given at the table. Dimension for foot length L when measured at the gauge plane 0.25 mm above the seating plane, is 0.6 mm
- ⑤ Details of pin 1 identifier are optional but must be located within the zone indicated
- 6 Controlling dimension: millimeter