

**PHILIPS**

Data handbook



Electronic  
components  
and materials

# Electron tubes

Book S13

1986

Sensors

# SENSORS

	<i>page</i>
<b>Selection guide</b>	
Magnetic field sensors . . . . .	1
Pressure sensors . . . . .	1
Temperature sensors . . . . .	1
Inductive proximity detectors . . . . .	1
<b>Type number survey (alpha-numerical) . . . . .</b>	<b>2</b>
<b>General</b>	
Introduction to magnetic-field sensors . . . . .	3
Introduction to temperature sensors . . . . .	21
<b>Device data in alpha-numerical sequence</b>	
Magnetic field sensors . . . . .	27
Pressure sensors . . . . .	41
Temperature sensors . . . . .	59
Inductive proximity detectors . . . . .	77
<b>Index of all devices in semiconductor Data Handbooks. . . . .</b>	<b>103</b>

**NOTE:** for optoelectronic sensors see Handbook Devices for optoelectronics.



## DATA HANDBOOK SYSTEM

Our Data Handbook System comprises more than 60 books with specifications on electronic components, subassemblies and materials. It is made up of four series of handbooks:

ELECTRON TUBES	BLUE
SEMICONDUCTORS	RED
INTEGRATED CIRCUITS	PURPLE
COMPONENTS AND MATERIALS	GREEN

The contents of each series are listed on pages iv to viii.

The data handbooks contain all pertinent data available at the time of publication, and each is revised and reissued periodically.

When ratings or specifications differ from those published in the preceding edition they are indicated with arrows in the page margin. Where application information is given it is advisory and does not form part of the product specification.

Condensed data on the preferred products of Philips Electronic Components and Materials Division is given in our Preferred Type Range catalogue (issued annually).

Information on current Data Handbooks and on how to obtain a subscription for future issues is available from any of the Organizations listed on the back cover.

Product specialists are at your service and enquiries will be answered promptly.

## ELECTRON TUBES (BLUE SERIES)

The blue series of data handbooks comprises:

- T1 Tubes for r.f. heating**
- T2a Transmitting tubes for communications, glass types**
- T2b Transmitting tubes for communications, ceramic types**
- T3 Klystrons**
- T4 Magnetrons for microwave heating**
- T5 Cathode-ray tubes**  
Instrument tubes, monitor and display tubes, C.R. tubes for special applications
- T6 Geiger-Müller tubes**
- T8 Colour display systems**  
Colour TV picture tubes, colour data graphic display tube assemblies, deflection units
- T9 Photo and electron multipliers**
- T10 Plumbicon camera tubes and accessories**
- T11 Microwave semiconductors and components**
- T12 Vidicon and Newvicon camera tubes**
- T13 Image intensifiers and infrared detectors**
- T15 Dry reed switches**
- T16 Monochrome tubes and deflection units**  
Black and white TV picture tubes, monochrome data graphic display tubes, deflection units

## SEMICONDUCTORS (RED SERIES)

The red series of data handbooks comprises:

- S1 Diodes**  
Small-signal silicon diodes, voltage regulator diodes ( $< 1,5 \text{ W}$ ), voltage reference diodes, tuner diodes, rectifier diodes
- S2a Power diodes**
- S2b Thyristors and triacs**
- S3 Small-signal transistors**
- S4a Low-frequency power transistors and hybrid modules**
- S4b High-voltage and switching power transistors**
- S5 Field-effect transistors**
- S6 R.F. power transistors and modules**
- S7 Surface mounted semiconductors**
- S8 Devices for optoelectronics**  
Photosensitive diodes and transistors, light-emitting diodes, displays, photocouplers, infrared sensitive devices, photoconductive devices.
- S9 Power MOS transistors**
- S10 Wideband transistors and wideband hybrid IC modules**
- S11 Microwave transistors**
- S12 Surface acoustic wave devices**
- S13 Semiconductor sensors**

## INTEGRATED CIRCUITS (PURPLE SERIES)

The purple series of data handbooks comprises:

### EXISTING SERIES

Superseded by:

<b>IC1</b>	<b>Bipolar ICs for radio and audio equipment</b>	<b>IC01N</b>
<b>IC2</b>	<b>Bipolar ICs for video equipment</b>	<b>IC02Na and IC02Nb</b>
<b>IC3</b>	<b>ICs for digital systems in radio, audio and video equipment</b>	<b>IC01N, IC02Na and IC02Nb</b>
<b>IC4</b>	<b>Digital integrated circuits CMOS HE4000B family</b>	
<b>IC5</b>	<b>Digital integrated circuits – ECL ECL10 000 (GX family), ECL100 000 (HX family), dedicated designs</b>	<b>IC08N</b>
<b>IC6</b>	<b>Professional analogue integrated circuits</b>	
<b>IC7</b>	<b>Signetics bipolar memories</b>	
<b>IC8</b>	<b>Signetics analogue circuits</b>	<b>IC11N</b>
<b>IC9</b>	<b>Signetics TTL logic</b>	<b>IC09N and IC15N</b>
<b>IC10</b>	<b>Signetics Integrated Fuse Logic (IFL)</b>	<b>IC13N</b>
<b>IC11</b>	<b>Microprocessors, microcomputers and peripheral circuitry</b>	<b>IC14N</b>

## NEW SERIES

<b>IC01N</b>	<b>Radio, audio and associated systems</b> Bipolar, MOS	(published 1985)
<b>IC02Na</b>	<b>Video and associated systems</b> Bipolar, MOS Types MAB8031AH to TDA1524A	(published 1985)
<b>IC02Nb</b>	<b>Video and associated systems</b> Bipolar, MOS Types TDA2501 to TEA1002	(published 1985)
<b>IC03N</b>	<b>Integrated circuits for telephony</b>	(published 1985)
<b>IC04N</b>	<b>HE4000B logic family</b> CMOS	
<b>IC05N</b>	<b>HE4000B logic family – uncased ICs</b> CMOS	(published 1984)
<b>IC06N</b>	<b>High-speed CMOS; PC54/74HC/HCT/HCU</b> Logic family	(published 1985)
<b>Supplement to IC06N</b>	<b>High-speed CMOS; PC74HC/HCT/HCU</b> Logic family	(published 1985)
<b>IC07N</b>	<b>High-speed CMOS; PC54/74HC/HCT/HCU – uncased ICs</b> Logic family	
<b>IC08N</b>	<b>ECL 10K and 100K logic families</b>	(published 1984)
<b>IC09N</b>	<b>TTL logic series</b>	(published 1984)
<b>IC10N</b>	<b>Memories</b> MOS, TTL, ECL	
<b>IC11N</b>	<b>Linear LSI</b>	(published 1985)
<b>IC12N</b>	<b>Semi-custom gate arrays &amp; cell libraries</b> ISL, ECL, CMOS	
<b>IC13N</b>	<b>Semi-custom</b> Integrated Fuse Logic	(published 1985)
<b>IC14N</b>	<b>Microprocessors, microcontrollers &amp; peripherals</b> Bipolar, MOS	(published 1985)
<b>IC15N</b>	<b>FAST TTL logic series</b>	(published 1984)

### Note

Books available in the new series are shown with their date of publication.



## COMPONENTS AND MATERIALS (GREEN SERIES)

The green series of data handbooks comprises:

- C1 Programmable controller modules**  
PLC modules, PC20 modules
- C2 Television tuners, coaxial aerial input assemblies, surface acoustic wave filters**
- C3 Loudspeakers**
- C4 Ferroxcube potcores, square cores and cross cores**
- C5 Ferroxcube for power, audio/video and accelerators**
- C6 Synchronous motors and gearboxes**
- C7 Variable capacitors**
- C8 Variable mains transformers**
- C9 Piezoelectric quartz devices**
- C10 Connectors**
- C11 Varistors, thermistors and sensors**
- C12 Potentiometers, encoders and switches**
- C13 Fixed resistors**
- C14 Electrolytic and solid capacitors**
- C15 Ceramic capacitors**
- C16 Permanent magnet materials**
- C17 Stepping motors and associated electronics**
- C18 Direct current motors**
- C19 Piezoelectric ceramics**
- C20 Wire-wound components for TVs and monitors**
- C21\* Assemblies for industrial use**  
HNIL FZ/30 series, NORbits 60-, 61-, 90-series, input devices
- C22 Film capacitors**

\* To be issued shortly.

## Magnetic field sensors

type	field range	supply voltage V	T <sub>amb</sub> °C	sensitivity $\frac{\text{mV/V}}{\text{kA/m}}$	bridge resistance k $\Omega^*$	page
	kA/m					
KMZ10A	-0,5 to + 0,5	5	-40 to 150	14	1,7 $\pm$ 0,5	29
KMZ10B	-2,0 to + 2,0	5	-40 to 150	4	1,7 $\pm$ 0,5	33
KMZ10C	-7,5 to + 7,5	5	-40 to 150	1,5	1,4 + 0,4	37

## Pressure sensors

type	pressure range bar	supply voltage V	T <sub>amb</sub> °C	sensitivity (T <sub>amb</sub> = 25 °C) mV/Vbar	bridge resistance $\Omega^*$	page
KP100A	+ 1 to 2	7,5	-40 to 105	13	1800	43
KP101A	0 to 1,2	5	-40 to 125	50	1600	47
KPZ20G	-1 to 2	7,5	-40 to 125	10,5 $\pm$ 3,5	2000	51
KPZ21G	-1 to 10	7,5	-40 to 125	3,5 $\pm$ 3,5	2000	55

## Temperature sensors

type	temperature range °C	resistance R . . at T <sub>amb</sub> and I (R25 or R100)			continuous sensor current mA*	page
		$\Omega$	°C	mA		
KTY81-110	-55 to 150	1000 $\pm$ 1%	25	1	10	61
	-120	1000 $\pm$ 2%	25	1	10	61
KTY81-210	-55 to 150	2000 $\pm$ 1%	25	0,5	10	65
	-220	2000 $\pm$ 2%	25	0,5	10	65
KTY83-110	-55 to 175	1000 $\pm$ 1%	25	1	10	69
	-120	1000 $\pm$ 2%	25	1	10	69
KTY84-130	0 to 300	1000 $\pm$ 3%	100	2	10	73
	-150	1000 $\pm$ 5%	100	2	10	73

## Proximity detectors

type	switching distance mm	supply voltage V	max. output current		T <sub>amb</sub> °C	page
			mA	at V <sub>B</sub> V		
OM286; M	1 to 5	4,5 to 30	250	24	-40 to 85	79
OM287; M	1 to 5	-4,5 to -30	250	-24	-40 to 85	79
OM386B	1 to 5	10 to 30	250	10 to 30	-40 to 85	85
OM387B	1 to 5	-10 to -30	250	-10 to -30	-40 to 85	85
OM386M	1 to 5	10 to 30	200	10 to 30	-40 to 85	91
OM387M	1 to 5	-10 to -30	200	-10 to -30	-40 to 85	91
OM388B	2 to 5	10 to 30	250	10 to 30	-40 to 85	97
OM389B	2 to 5	-10 to -30	250	-10 to -30	-40 to 85	97

**Note:** For optoelectronic sensors see Handbook Devices for optoelectronics.

\* At T<sub>amb</sub> = 25 °C.

# TYPE NUMBER SURVEY

		page
KMZ10A	magnetic field sensor, $-0,5$ to $+ 0,5$ kA/m	29
KMZ10B	magnetic field sensor, $-2,0$ to $+ 2,0$ kA/m	33
KMZ10C	magnetic field sensor, $-7,5$ to $+ 7,5$ kA/m	37
KP100A	pressure sensor, 0 to 2 bar	43
KP101A	pressure sensor, 0 to 1,2 bar	47
KPZ20G	pressure sensor, $-1$ to 2 bar	51
KPZ21G	pressure sensor, $-1$ to 10 bar	55
KTY81-100 series (KTY81-110 and 120)	temperature sensors, $-55$ to $150$ °C, $1000$ $\Omega$	61
KTY81-200 series (KTY81-210 and 220)	temperature sensors, $-55$ to $150$ °C, $2000$ $\Omega$	65
KTY83-100 series (KTY83-110 and 120)	temperature sensors, $-55$ to $175$ °C	69
KTY84-100 series (KTY84-130 and 150)	temperature sensors, 0 to $300$ °C	73
OM286; M	proximity detector, 250 mA	79
OM287; M	same as OM286; M but with reverse polarity	79
OM386B	proximity detector, 250 mA	85
OM387B	same as OM386B but with reverse polarity	85
OM386M	proximity detector, 200 mA	91
OM387M	same as OM386M but with reverse polarity	91
OM388B	proximity detector, 250 mA	97
OM389B	same as OM388B but with reverse polarity	97

**Note:** For optoelectronic sensors see Handbook Devices for optoelectronics.

## INTRODUCTION TO MAGNETIC FIELD SENSORS

## MAGNETIC FIELD SENSORS

The KMZ10 is a highly-sensitive magnetic-field sensor and provides an excellent means of measuring both linear and angular displacement. This is because even quite small movement of actuating components in machinery (metal rods, cogs, cams etc.) can create measurable changes in magnetic field. Examples where this property is put to good effect can be found in instrumentation and control equipment, which often requires position sensors capable of detecting displacements in the region of tenths of a millimetre, and in electronic ignition systems, which must be able to determine the angular position of an internal-combustion engine with great accuracy.

If the KMZ10 is to be used to maximum advantage, however, it's important to have a clear understanding of its operating principles and characteristics, and of how its behaviour may be affected by external influences and by its magnetic history.

**KMZ10 MAGNETIC FIELD SENSORS**

	KMZ10A	KMZ10B	KMZ10C	units
$H_{max}$ (typ)	500	2000	7,500	A/m
open-circuit sensitivity	12,0	5,0	1,1	(mV/V)/(kA/M)

## KMZ10 OPERATING PRINCIPLES

The KMZ10 makes use of the *magnetoresistive effect*, the well known property of a current-carrying magnetic material to change its resistivity in the presence of an external magnetic field. This change is brought about by rotation of the magnetization relative to the current direction. In the case of permalloy for example (a ferromagnetic alloy containing 20% iron and 80% nickel), a 90° rotation of the magnetization (due to the application of a magnetic field normal to the current direction) will produce a 2 to 3% change in resistivity.

In the KMZ10, four permalloy strips, are arranged in a meander pattern on a silicon substrate (Fig.1), and connected to form the four arms of a Wheatstone bridge. The degree of bridge imbalance is then used to indicate the magnetic field strength, or more precisely, the variation in magnetic field in the plane of the permalloy strips normal to the direction of current.

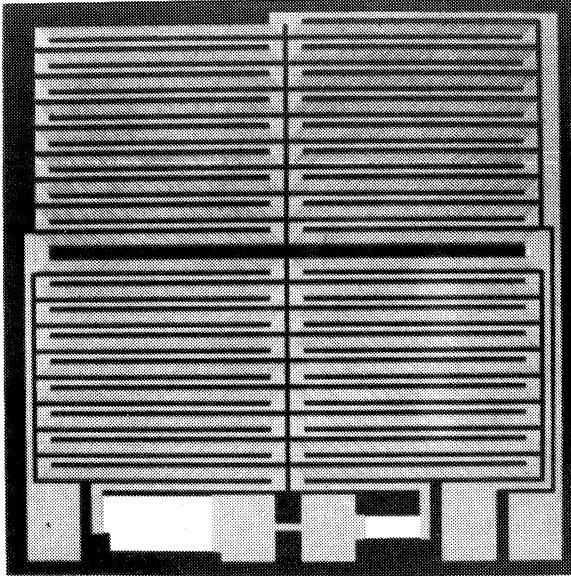

(a)

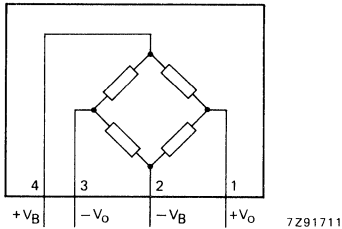

(b)

Fig.1 (a) The KMZ10 chip is made up of four permalloy strips arranged in a meander pattern and connected to form the four arms of a Wheatstone bridge. The chip incorporates special resistors that are trimmed during manufacture to give zero offset at  $25^\circ\text{C}$ .

(b) Bridge configuration of the KMZ10.  $V_B$  – supply voltage,  $V_o$  – output voltage

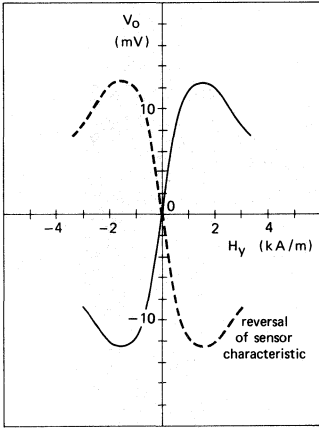

(a)

Fig.2

- (a) Sensor characteristic. The unbroken line shows the characteristics of a 'normal' sensor (with the magnetization oriented in the +x direction), and the broken line shows the characteristic of a 'flipped' sensor.
- (b) Dimensional drawing of the KMZ10 showing pinning and magnetic field direction for normal operation

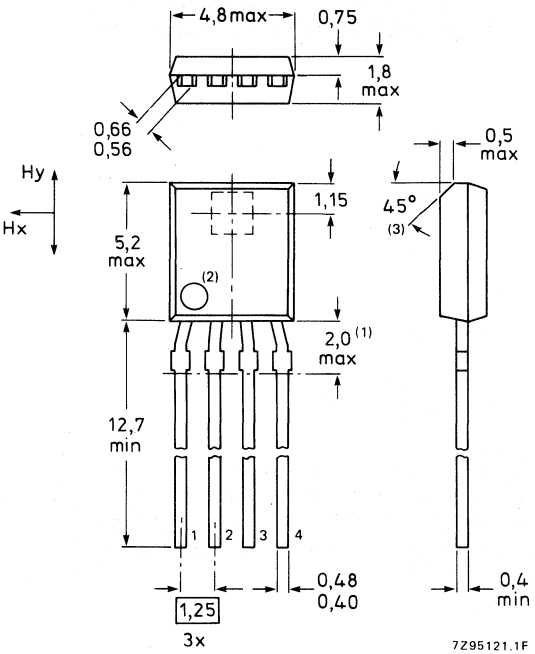

(b)

### KMZ10 CHARACTERISTIC BEHAVIOUR

During manufacture, a strong magnetic field is applied parallel to the strip axis. This imparts a preferred magnetization direction to the permalloy strips. So even in the absence of an external magnetic field, the magnetization will always tend to align with the strips.

The internal magnetization of the sensor strips therefore has two stable positions, so that if for any reason, the sensor should come under the influence of a powerful magnetic field opposing the internal aligning field, the magnetization may flip from one position to the other, and the strips become magnetized in the opposite direction (from say the  $+x$  to the  $-x$  direction). As Fig.2 shows, this can lead to drastic changes in sensor characteristics.

In Fig.2 the unbroken line shows the characteristics of a normal sensor (i.e. with the sensor magnetization oriented in the  $+x$  direction), and the broken line shows the characteristics of a 'flipped' sensor.

The field,  $H_x$  say, needed to flip the sensor magnetization (and hence the characteristic) depends on the magnitude of the transverse field  $H_y$  — the greater the field  $H_y$ , the smaller the field  $H_x$ . This is quite reasonable when you think of it, since the greater the field  $H_y$ , the closer the magnetization's rotation approaches  $90^\circ$ , and hence the easier it will be to flip it into a corresponding stable position in the  $-x$  direction.

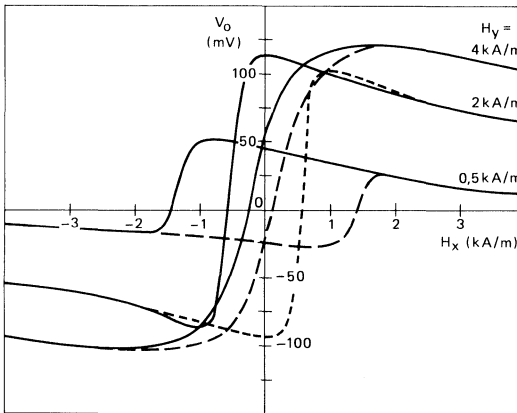

7Z91681

Fig.3 Sensor output  $V_O$  versus  $H_x$  for several values of  $H_y$ . The curves illustrate several things: first, that the sensor exhibits hysteresis, second, that the flipping is not instantaneous, and third, that sensitivity falls with increasing  $H_x$



This is illustrated in Fig.3, which shows sensor output signal  $V_0$  versus  $H_X$  for several values of  $H_Y$ .

Take the curve for  $H_Y = 0,5 \text{ kA/m}$ . For such a low transverse field, the sensor characteristic is stable for all positive values of  $H_X$ , and a reverse field of around  $1 \text{ kA/m}$  is required before flipping occurs. At  $H_Y = 4 \text{ kA/m}$ , on the other hand, the sensor will flip at even positive values of  $H_X$  (at around  $1 \text{ kA/m}$ ).

Figure 3 also illustrates that the flipping itself is not instantaneous; this is because not all the permalloy strips flip at the same rate. Also in Fig.3 you can see the hysteresis effect exhibited by the sensor. Finally, Fig.3 and Fig.4 show that the sensitivity of the sensor falls with increasing  $H_X$ . This again is reasonable since the moment imposed on the magnetization by  $H_X$  directly opposes that imposed by  $H_Y$ , thereby reducing the degree of bridge imbalance and hence the output signal for a given value of  $H_Y$ .

From the foregoing discussions we arrive at the following general recommendations for operating the KMZ10:

- to assure stable operation, avoid operating the sensor in an environment where it's likely to be subjected to negative external fields  $H_X$ . Preferably, apply a positive auxiliary field  $H_X$  of sufficient magnitude to prevent any likelihood of flipping within the operating range (i.e. the range of  $H_Y$ ) you intend to use the sensor

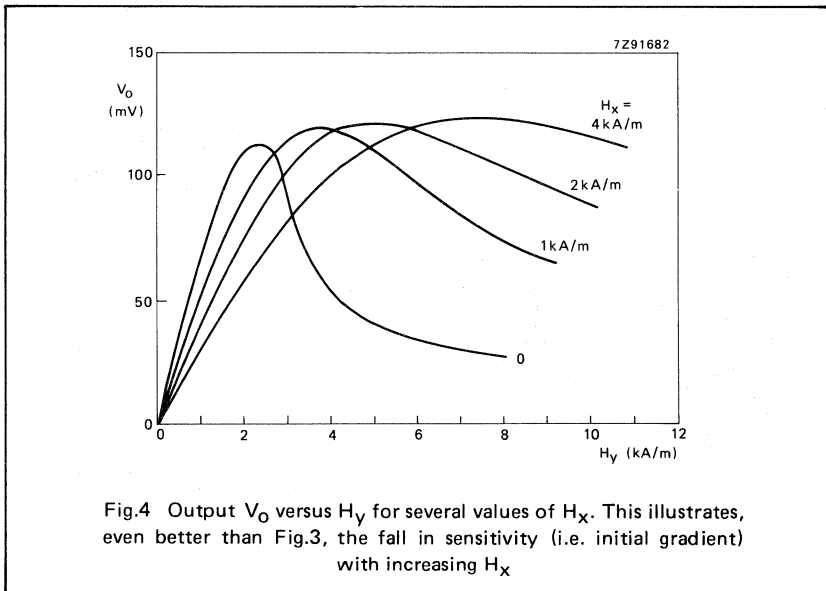

Fig.4 Output  $V_0$  versus  $H_Y$  for several values of  $H_X$ . This illustrates, even better than Fig.3, the fall in sensitivity (i.e. initial gradient) with increasing  $H_X$



## Effect of temperature on behaviour

Figure 6 shows that the bridge resistance increases linearly with temperature. This variation comes, of course, from the fact that the bridge resistors themselves (i.e. the permalloy strips) vary with temperature, and as we see below, it can be put to good effect when operating with a constant-current supply. Figure 6 shows only the variation for a typical KMZ10B sensor. The data sheets show also the spread in this variation due to manufacturing tolerances, and this should be taken into account when incorporating the sensor into practical circuits.

Not just the bridge resistance but the sensitivity too varies with temperature. This can be seen from Fig.7 which plots output voltage against transverse field  $H_y$  for various temperatures. The figures shows that sensitivity falls with increasing temperature. The reason for this is rather complicated and is connected with the energy-band structure of the permalloy strips.

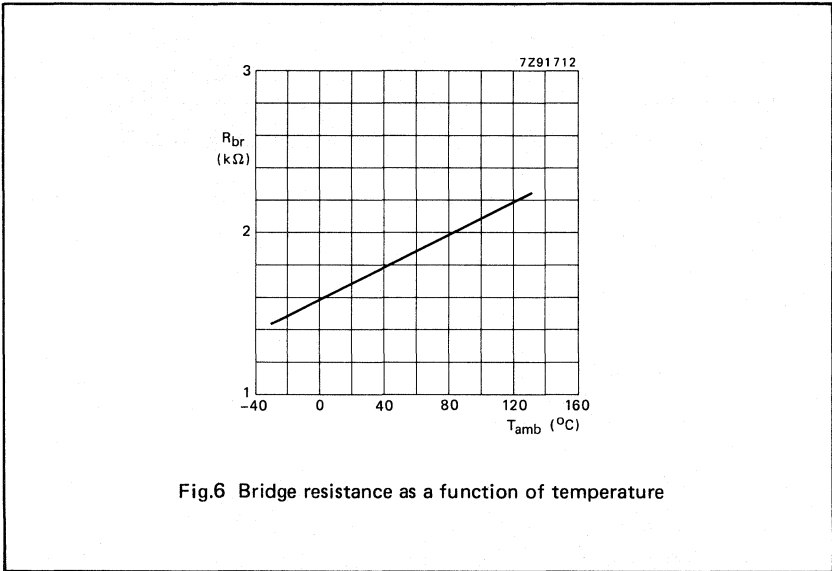

Fig.6 Bridge resistance as a function of temperature

Figure 8 is similar to Fig.7 but with the sensor powered by a constant-current supply. The figure shows that with a constant current supply, the temperature dependence of sensitivity is significantly reduced. This is a direct result of the increase of bridge resistance with temperature (Fig.5) which partially compensates the fall in sensitivity by increasing the voltage across the bridge and hence the output voltage. The figure, therefore, adequately demonstrates the advantages of operating with constant current.

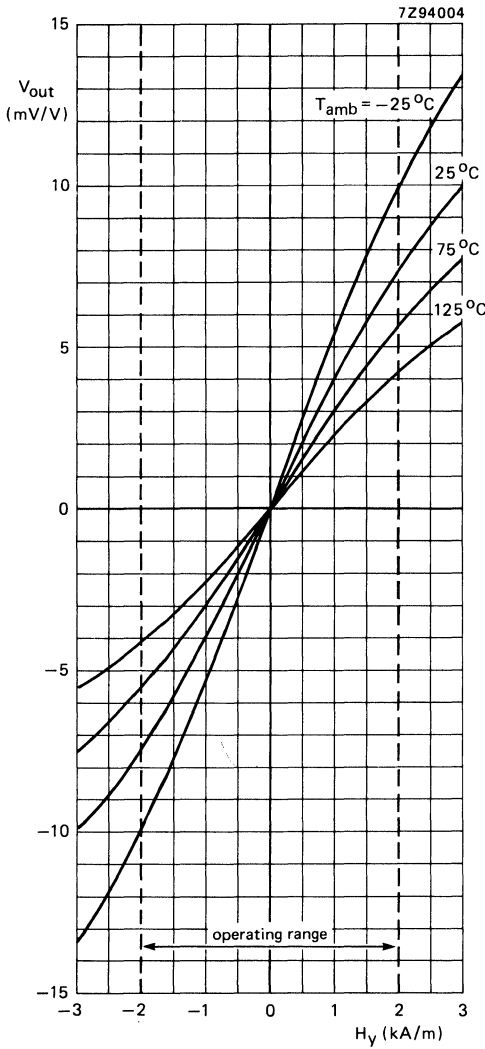

Fig.7 Output voltage  $V_O$  (as a fraction of the supply voltage) versus transverse field  $H_Y$  for several temperatures. The figure illustrates that sensitivity falls with increasing temperature

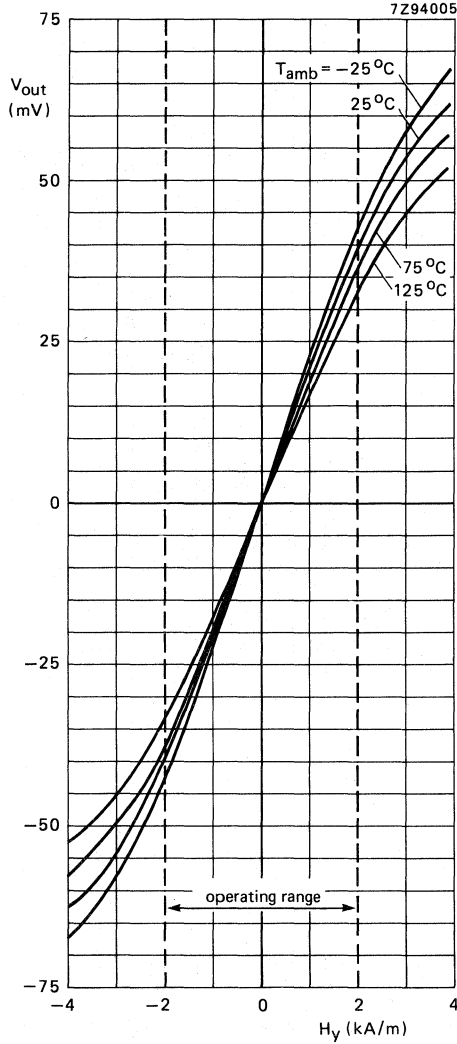

Fig.8 Output voltage  $V_O$  versus transverse field  $H_y$  for several temperatures, with the sensor powered by a constant-current supply. The reduction in temperature dependence of sensitivity is a result of the increase of bridge resistance with temperature, which increases the bridge voltage to partially compensate the fall in sensitivity

USING THE KMZ10

Displacement measurement using permanent magnets

Figures 9 and 10 show probably one of the simplest arrangements for using a sensor/permanent-magnet combination to measure linear displacement, and exposes some of the problems likely to be encountered if proper account is not taken of the effects described above.

When the sensor is placed in the field of a permanent magnet, it's exposed to magnetic fields in both the x and y directions. If the magnet is oriented with its axis parallel to the sensor strips (i.e. in the x direction) as shown in Fig.9(a),  $H_x$  then provides the auxiliary field and the variation in  $H_y$  can be used as a measure of x displacement. Figure 9(b) shows how both  $H_x$  and  $H_y$  vary with x, and Fig.9(c) shows the corresponding output signal as a function of x.

In the example shown in Fig.9,  $H_x$  never exceeds  $\pm \hat{H}_x$  (the field that can cause flipping of the sensor) and the sensor characteristic remains stable and well-behaved throughout the measuring range.

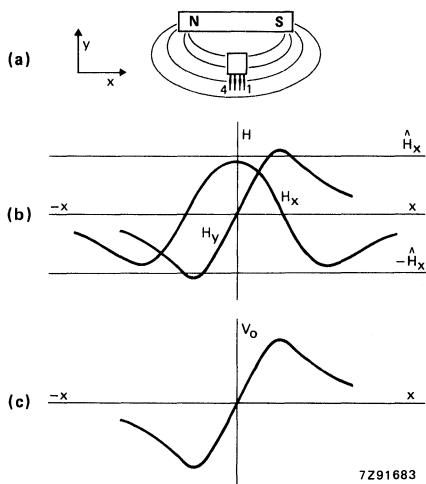

Fig.9 Sensor output in the field of a permanent magnet as a function of its displacement  $x$  parallel to the magnetic axis. The magnet provides both the auxiliary and transverse fields. In the example shown, the auxiliary field is always less than the field  $\hat{H}_x$  that will cause flipping. Note the pinning arrangement in this figure, which indicates that the sensor is viewed from the rear. Reversal of the sensor relative to the permanent will reverse the characteristic

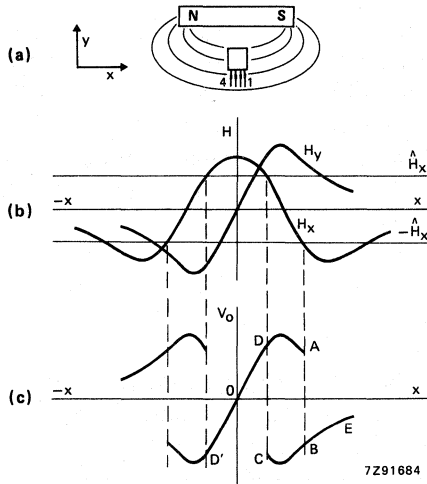

Fig.10 Sensor output in the setup of Fig.9, but in which the auxiliary field sometimes exceeds  $H_x$

Consider now the example shown in Fig.10. Here for certain values of  $x$ ,  $H_x$  exceeds  $\pm\hat{H}_x$ , (Fig.10(b)). This could happen if, for example, the magnet were powerful or if the sensor should pass close to the magnet, and as Fig.10(c) shows, the effects on the output signal can be drastic.

Suppose the sensor is initially on the transverse axis of the magnet ( $x=0$  say).  $H_y$  will be zero and  $H_x$  will be at its maximum value ( $>\hat{H}_x$ ). So the sensor will be oriented in the  $+x$  direction and the output voltage will vary as in Fig.9(a). As the sensor moves in the  $+x$  direction  $H_y$  and hence  $V_o$  increases, and  $H_x$  falls to zero and then increase negatively until it exceeds  $-\hat{H}_x$ . At this point the sensor characteristic flips and the output voltage reverses, moving from A to B in Fig.10(c). Further increase of  $x$  causes the sensor voltage to move along BE. If the sensor is moved in the opposite direction, however,  $H_x$  increases until it exceeds  $+\hat{H}_x$  and  $V_o$  moves from B to C. At this point the sensor characteristic again flips and  $V_o$  moves from C to D.

Under these conditions, then, the sensor characteristic will trace the hysteresis loop ABCD, and a similar loop in the  $-x$  direction. Figure 10(c) is, in fact, an idealized case and the reversals are never as abrupt as shown in this figure. It does, however, illustrate the effects that can occur if the sensor is placed close to a powerful permanent magnet. Note that under certain

circumstances, particularly where there are likely to be temporary or fluctuating external fields, it may be advantageous to operate under these conditions, since over the region  $DD'$  the field of the permanent magnet will have a stabilizing effect on the sensor (i.e. it will tend to correct any flipping of the sensor due to transient magnetic fields). Note also that reversal of the permanent magnet will give rise to the same sensor characteristic as shown in Figs.9(c) and 10(c) (i.e. with positive slope) since the sensor will then be forced to operate in its flipped state.

Figure 11 shows the sensor characteristic at distances of 10 mm and 20 mm from a permanent magnet, and amply illustrates the effects shown in Figs.9 and 10.

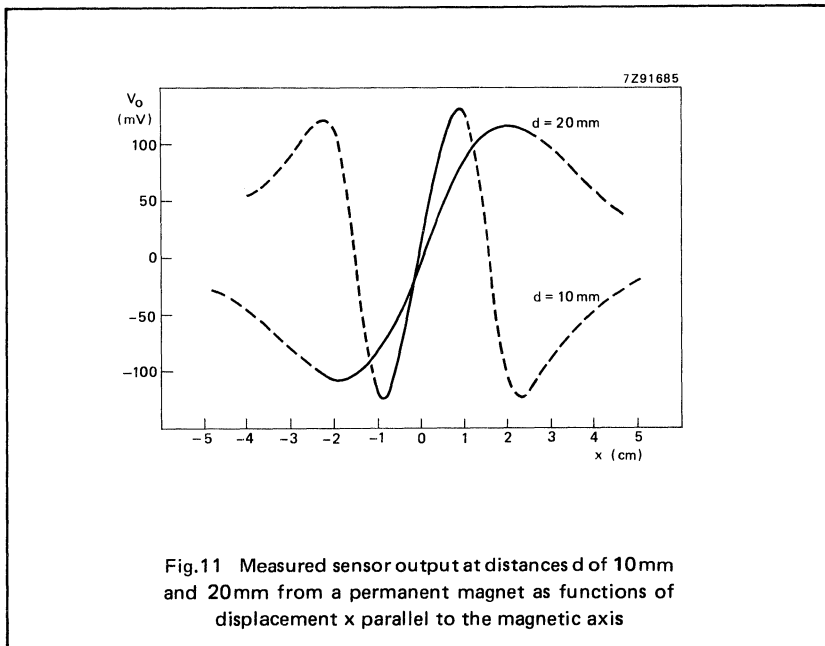

### One-point position measurement with the KZM10

Figure 12(a) shows how a KMZ10B may be used to make position measurements of a metal object, a steel plate for instance. The sensor is located between the plate and a permanent magnet oriented with its magnetic axis normal to the axis of the plate. A discontinuity in the plate's structure, such as a hole or region of non-magnetic material, will disturb the magnetic field and produce a variation in the output signal from the sensor.



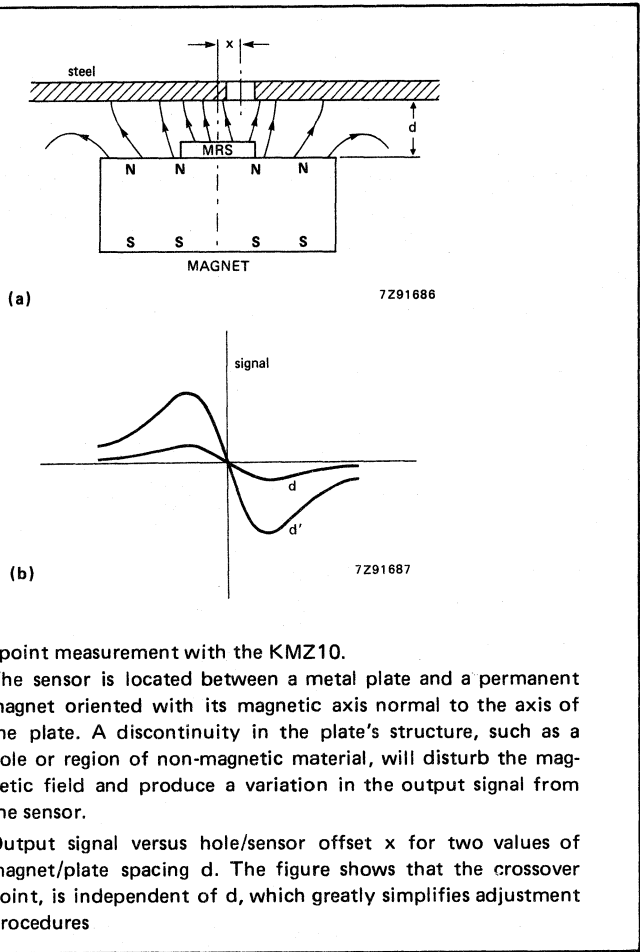

Fig.12 One-point measurement with the KMZ10.

- (a) The sensor is located between a metal plate and a permanent magnet oriented with its magnetic axis normal to the axis of the plate. A discontinuity in the plate's structure, such as a hole or region of non-magnetic material, will disturb the magnetic field and produce a variation in the output signal from the sensor.
- (b) Output signal versus hole/sensor offset  $x$  for two values of magnet/plate spacing  $d$ . The figure shows that the crossover point, is independent of  $d$ , which greatly simplifies adjustment procedures

This is shown in Fig.12(b) which gives the sensor output signal versus hole/sensor offset  $x$ , for two values of magnet/plate spacing  $d$ . The interesting point of this figure is that the crossover point, i.e. the point where the hole and sensor precisely coincide, is independent of  $d$ . The obvious advantage of this setup is that precise location of the sensor/magnet combination is unimportant for one-point position measurements, so adjustment procedures in a practical device would be greatly simplified. Although not shown in Fig.12(b), the crossover point is also independent of temperature. This is not surprising since it is effectively a null measurement, and it could be a major advantage in practical applications.

Angular position measurement with the KMZ10

Figure 13 shows a practical setup for measuring angular position using a KMZ10C. The sensor itself is located in the magnetic field produced by two RES190 permanent magnets fixed to a rotatable frame. The output of the sensor will then be a measure of the rotation of the frame (Fig.15). Taking the zero position for measurement to be parallel to the x axis of the sensor (i.e. with the magnetic field in the  $H_x$  direction), then the device can measure rotation up to around  $\pm 85^\circ$ . Beyond that and the sensor is in danger of flipping.

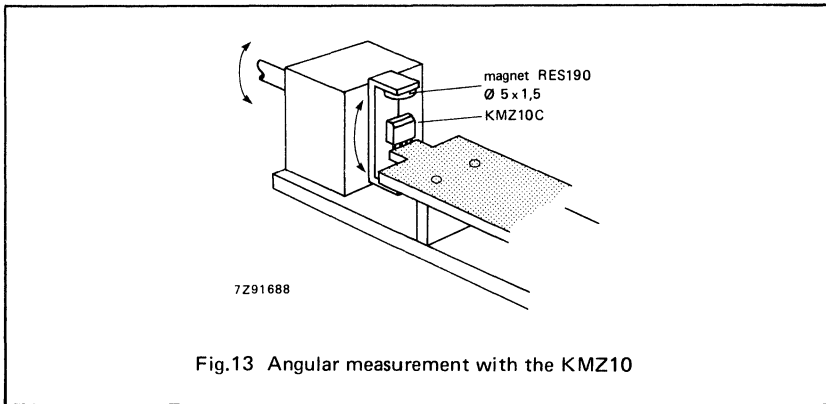

Fig.13 Angular measurement with the KMZ10

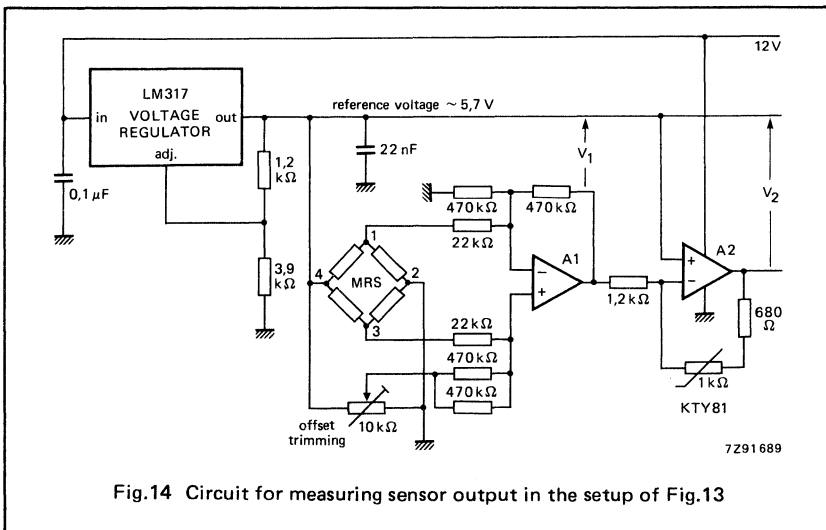
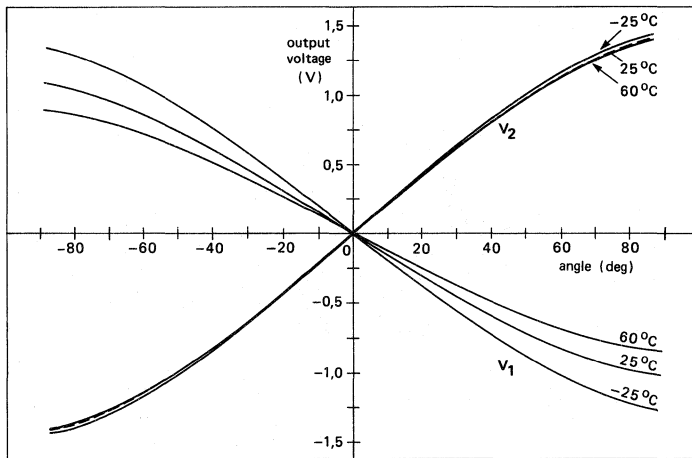

Fig.14 Circuit for measuring sensor output in the setup of Fig.13

Figure 14 shows a circuit for measuring the sensor output in the setup of Fig.13. The output signal of the sensor bridge is amplified by opamps A<sub>1</sub> and A<sub>2</sub>. A KTY81 silicon temperature sensor in the feedback loop of A<sub>2</sub> varies the gain of the amp to provide temperature compensation for the output signal. Fig.15 shows the effectiveness of this temperature compensation by comparing the output V<sub>2</sub> of A<sub>2</sub> with the direct output V<sub>1</sub> from opamp A<sub>1</sub> for a range of temperatures.



7291690

Fig.15 Effect of temperature compensation in the circuit of Fig.14. The figure compares the uncompensated output V<sub>1</sub> of opamp A<sub>1</sub> with the compensated output V<sub>2</sub> of opamp A<sub>2</sub>

## Current measurement with the KMZ10

Finally Figs.16 and 17 show two ways in which the KMZ10B can be used to measure electric current. This could be useful, for example, in headlamp-failure systems in automobiles or in clamp-on (non-contacting) meters as used in the power industry.

Fig.16 is a rather simple setup in which the sensor measures the magnetic field generated by the current-carrying wire. Fig.17 is a more sophisticated arrangement in which the current-carrying wire is wrapped around a ferrite core, with the sensor located in the air gap between its ends. This arrangement provides a more accurate means of measuring current and lends itself more to

precision applications. What's important to bear in mind in both these examples, however, is that they allow current measurement without any break in or interference with the circuit — and thereby they provide a distinct advantage over thermistor-based systems.

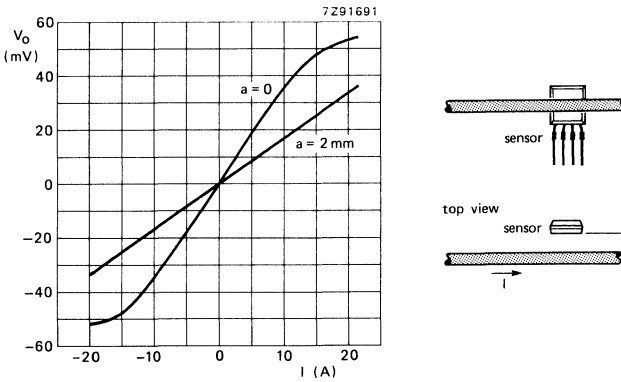

Fig.16 Simple setup for measuring current with a KMZ10 sensor. The sensor simply measures the magnetic field generated by a current-carrying wire

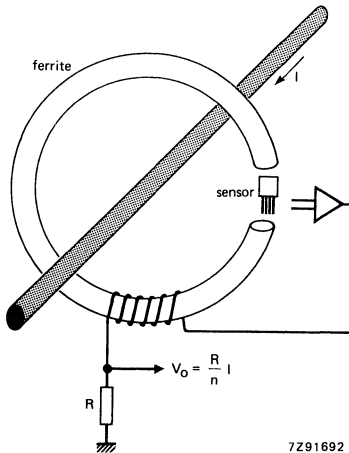

Fig.17 Current measurement with the KMZ10 sensor. In this setup a current-carrying wire is wrapped around a ferrite core, with the sensor located in the air gap between its ends



## INTRODUCTION TO TEMPERATURE SENSORS

## SILICON TEMPERATURE SENSORS

### General

With their high accuracy and reliability, the KTY81/83/84 silicon temperature sensors provide an attractive alternative to more conventional sensors using NTC or PTC thermistors.

They use n-type silicon with a doping level between  $10^{14}$  and  $10^{15}/\text{cm}^3$ , providing a nominal resistance of about  $1000 \Omega$ . Note, however, that variants of the KTY81 series exist, the KTY81-210 and KTY81-220, with a nominal resistance of  $2000 \Omega$ .

### QUICK REFERENCE DATA

KTY81-110	$R_{25} = 1000 \Omega \pm 1\%$	} SOD-70 encapsulation
KTY81-120	$R_{25} = 1000 \Omega \pm 2\%$	
KTY81-210	$R_{25} = 2000 \Omega \pm 1\%$	
KTY81-220	$R_{25} = 2000 \Omega \pm 2\%$	
KTY83-110	$R_{25} = 1000 \Omega \pm 1\%$	} DO-34 encapsulation
KTY83-120	$R_{25} = 1000 \Omega \pm 2\%$	
KTY84-130	$R_{100} = 1000 \Omega \pm 3\%$	} DO-34 encapsulation
KTY84-150	$R_{100} = 1000 \Omega \pm 5\%$	

### Resistance-temperature characteristics – manufacturing tolerances

Silicon temperature sensors are normally produced to quite fine tolerances:  $\Delta R$  between  $\pm 1\%$  and  $\pm 2\%$  (see quick reference data). Figure 1 illustrates how these tolerances are specified for the KTY81 and KTY83 sensors. The tolerance on resistance quoted in our data sheets is given by the resistance spread  $\Delta R$  measured at  $25^\circ\text{C}$ .

Because of spread in the slope of the resistance-temperature characteristic,  $\Delta R$  will increase each side of the  $25^\circ\text{C}$  point to produce the butterfly curve shown in Fig. 1. To give an indication of this spread in slope, we also quote the ratio of resistance at two other temperatures ( $-55^\circ\text{C}$  and  $100^\circ\text{C}$ ) to the nominal resistance at  $25^\circ\text{C}$ , i.e.  $R_{-55}/R_{25}$  and  $R_{100}/R_{25}$ .

The user, however, is usually more interested in the temperature spread  $\pm \Delta T$  (standard deviation). So we also provide this in the data sheets as a graph of  $\Delta T$  versus  $T$ .

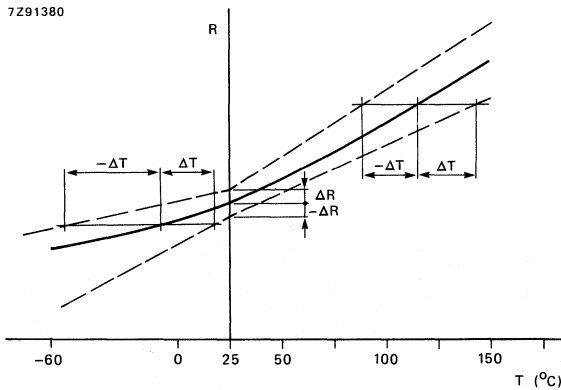

Fig.1 Resistance and temperature tolerances of the KTY81 and KTY83 sensors (exaggerated for clarity).

For the high-temperature KTY84, we specify the resistance spread at 100 °C. This is, however, an extrapolation from the measured spread at 25 °C.

**Resistance-temperature characteristics – linearization**

The resistance-temperature characteristics of the KTY81 and KTY83 temperature sensors are non linear, and in some applications, e.g. control systems requiring high accuracy, linearization becomes necessary.

A simple way to do this is to shunt the sensor (resistance  $R_T$ ) with a fixed resistor  $R$  (Fig. 2). The resistance  $RR_T/(R+R_T)$  of the parallel combination then effectively becomes a linear function of temperature, and the output voltage  $V_T$  of the linearizing circuit can be used to regulate the control system.

If the circuit is powered by a constant-voltage source, a resistor can be connected in series with the sensor, the voltages across the sensor and across the resistor will then again be approximately linear functions of temperature.

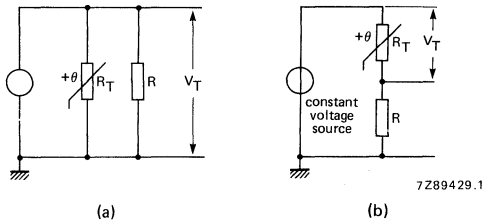

Fig.2 Linearization of sensor characteristics

- a) with a resistor  $R$  shunted across the sensor
- b) with a resistor  $R$  in series with the sensor and the system powered by a constant-voltage source

The value of the series or parallel resistor depends on the required operating-temperature range of the sensor. A method for finding this resistance is described here that gives zero temperature error at three equidistant points  $T_a$ ,  $T_b$  and  $T_c$  say.

Consider the parallel arrangement. If the resistance of the sensor at the three points is  $R_a$ ,  $R_b$  and  $R_c$ , and the corresponding resistance of the parallel arrangement  $R_{pa}$ ,  $R_{pb}$  and  $R_{pc}$ , the requirement for linearity at the three points is

$$R_{pa} - R_{pb} = R_{pb} - R_{pc}$$

i.e.

$$\frac{RR_a}{R + R_a} - \frac{RR_b}{R + R_b} = \frac{RR_b}{R + R_b} - \frac{RR_c}{R + R_c}$$

So

$$R = \frac{R_b (R_a + R_c) - 2R_a R_c}{R_a + R_c - 2R_b} \tag{2}$$

The same resistor turns out to be suitable for the series arrangement as well.

As an example, Fig. 3 shows the deviation from linearity to be expected from a nominal KTY81 sensor linearized over the temperature range 0 to 100 °C with a linearizing resistance of 2870  $\Omega$ .



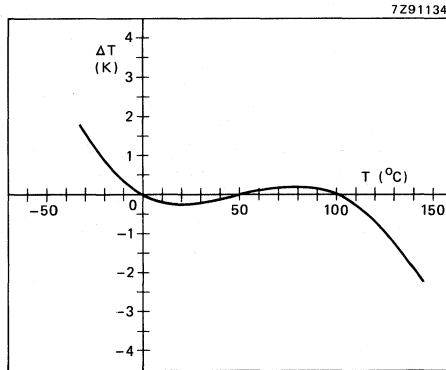

Fig.3 Temperature error  $\Delta T$  to be expected from a nominal KTY83 sensor linearized over the temperature range 0 to 100 °C (linearizing resistance 2870  $\Omega$ ).

Note: because the KTY84 is chiefly intended for use at higher temperatures, say above 100 °C, its almost linear characteristic at these temperatures often renders linearization unnecessary.

### Effect of tolerances on linearized sensor characteristics

In practical applications with an arbitrary sensor, the total uncertainty in the sensor reading will be a combination of spread due to manufacturing tolerances and linearization errors.

As an example, Fig.4 shows the combined effect of manufacturing-tolerances and linearization errors for the KTY81 sensor linearized over the temperature range 0 to 100 °C. Calibration of the subsequent circuitry (op amps, control circuitry etc.) can reduce this error significantly. Figure 5a shows the temperature error of the system with (linear) output circuitry calibrated at 50 °C, and Fig.5b shows the error of the same system calibrated at 0 and 100 °C.

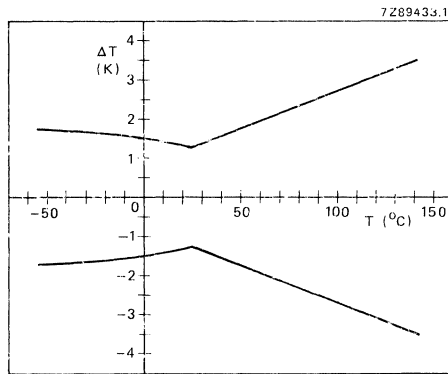

(a)

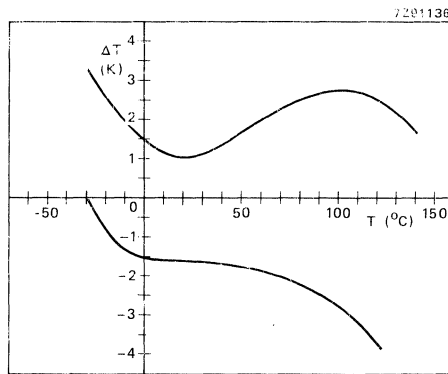

(b)

Fig. 4

- a) absolute error  $\Delta T$  expected of a silicon temperature sensor.
- b) combined effect of manufacturing-tolerances and linearization errors for the KTY83 sensor.

7Z91137

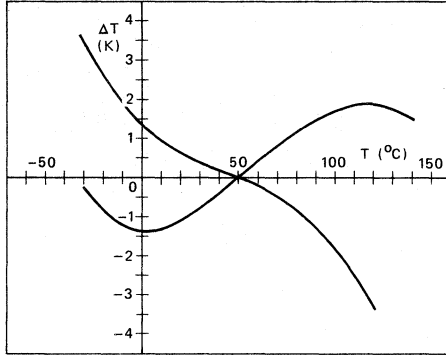

(a)

7Z91138

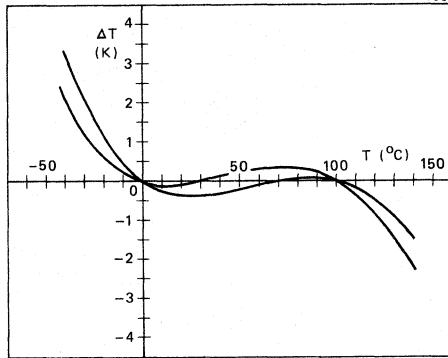

(b)

Fig.5

a) temperature error of system with linear output circuitry calibrated at 50  $^{\circ}\text{C}$

b) error of the same system calibrated at 0 and 100  $^{\circ}\text{C}$ .

## MAGNETIC FIELD SENSORS



# DEVELOPMENT DATA

This data sheet contains advance information and specifications are subject to change without notice.

KMZ10A

## MAGNETIC FIELD SENSOR

The KMZ10A is a magnetic field sensor employing the magneto-resistive effect of thin film permalloy. Its properties enable this sensor to be used in a wide range of applications for current and field measurement, revolution counters, angular or linear position measurement and proximity detectors, etc.

### QUICK REFERENCE DATA

Bridge supply voltage	$V_B$	typ.	5 V
Magnetic field range	$H_y$	=	$\pm 0,5$ kA/m
Auxiliary field	$H_x$	=	0,5 kA/m
Sensitivity	s	typ.	$14 \frac{\text{mV/V}}{\text{kA/m}}$
Operating temperature	$T_{op}$		-40 to +150 °C

### MECHANICAL AND ELECTRICAL DATA

Dimensions in mm

Fig. 1 VO-52B.

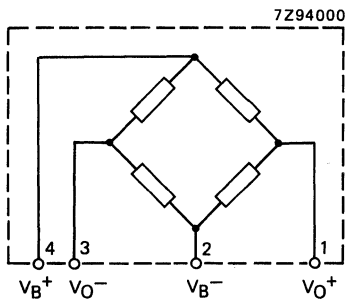

$V_B$  = supply voltage  
 $V_O$  = output voltage

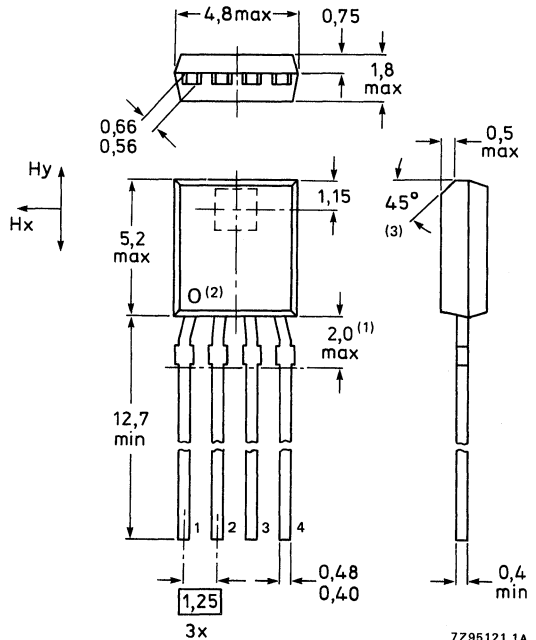

- (1) Terminal dimensions uncontrolled within this area
- (2) Until October 1985
- (3) Starting October 1985.

**RATINGS**

Limiting values in accordance with the Absolute Maximum System (IEC 134)

Bridge supply voltage	$V_B$	max.	9 V
Total power dissipation up to $T_{amb} = 130\text{ }^\circ\text{C}$	$P_{tot}$	max.	90 mW
Storage temperature	$T_{stg}$		-65 to +150 $^\circ\text{C}$
Operating temperature	$T_{op}$		-40 to +150 $^\circ\text{C}$

**THERMAL RESISTANCE**

From junction to ambient	$R_{th\ j-a}$	=	180 K/W
--------------------------	---------------	---	---------

**CHARACTERISTICS**

$T_{amb} = 25\text{ }^\circ\text{C}$  and  $H_x = 0,5\text{ kA/m}$  (1) unless otherwise specified

Bridge supply voltage	$V_B$	typ.	5 V
Magnetic field range (1)	$H_y$		-0,5 to +0,5 kA/m
Open circuit sensitivity (1)	s		$14 \pm 3 \frac{\text{mV/V}}{\text{kA/m}}$
Temperature coefficient of sensitivity $V_B = \text{constant}; T_j = -25\text{ to } +125\text{ }^\circ\text{C}$ $I_B = \text{constant}; T_j = -25\text{ to } +125\text{ }^\circ\text{C}$	$\alpha_s$	typ.	-0,4 %/K
	$\alpha_s$	typ.	-0,15 %/K
Bridge resistance	$R_{br}$		$1,7 \pm 0,5\text{ k}\Omega$
Temperature coefficient of bridge resistance at $T_j = -25\text{ to } +125\text{ }^\circ\text{C}$	$\alpha_{Rbr}$	typ.	+0,3 %/K
Off-set voltage with offset trimming (2) without offset trimming	$V_{off}$		-1,5 to +1,5 mV/V
	$V_{off}$		-20 to +20 mV/V
Temperature coefficient of offset voltage at $T_j = -25\text{ to } +125\text{ }^\circ\text{C}$	$\alpha_{Voff}$		-6 to +6 $\frac{\mu\text{V/V}}{\text{K}}$
Linearity deviation of output voltage at $H_y = 0\text{ to } 50\%$ $H_y = 0\text{ to } 80\%$ $H_y = 0\text{ to } 100\%$		$\leq$	0,8 % (3)
		$\leq$	2,5 % (3)
		$\leq$	4,0 % (3)
Hysteresis of output voltage		$\leq$	0,5 % (3)
Operating frequency	f	max.	1 MHz

Note: Before first operation or if to be operated outside the SOAR (Fig. 2) the sensor has to be reset by application of an auxiliary field  $H_x = 3\text{ kA/m}$ .

(1) No disturbing field ( $H_d$ ) allowed; for stable operation under disturbing conditions see Fig. 2 (SOAR) and see Fig. 8 for decrease of sensitivity.

(2) Offset trimming to be introduced approx. end 1985.

(3) Full scale.

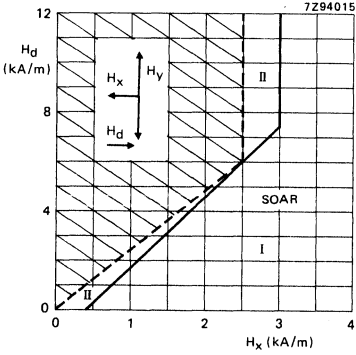

Fig. 2 Safe Operating Area (possible disturbing field  $H_d$  versus auxiliary field  $H_x$ )

I Region of permissible operation

II Permissible extension if  $H_y < 0,15$  kA/m.

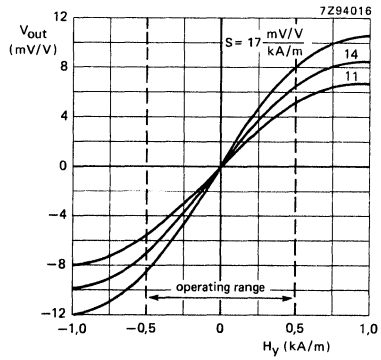

Fig. 3  $V_B = \text{constant}$ ;  
 $H_x = 0,5$  kA/m;  $T_{amb} = 25$  °C.

DEVELOPMENT DATA

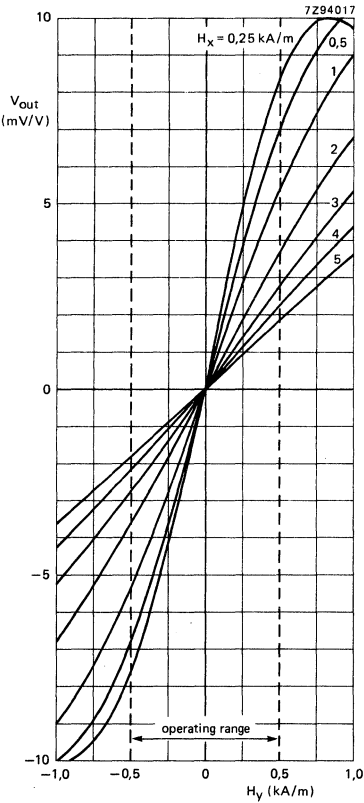

Fig. 4  $V_B = \text{constant}$ ;  $T_{amb} = 25$  °C.

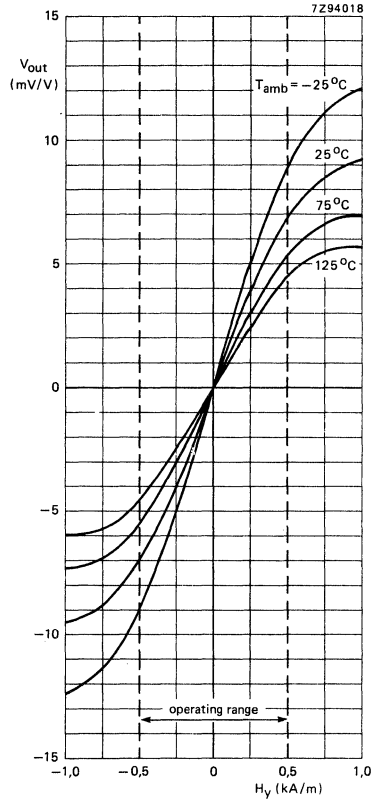

Fig. 5  $V_B = \text{constant}$ ;  $H_x = 0,5$  kA/m.



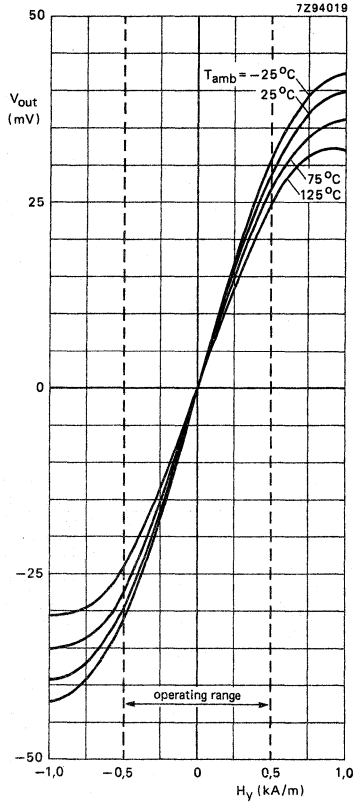

Fig. 6  $I_B = \text{constant} = 3 \text{ mA}$ ;  $H_x = 0,5 \text{ kA/m}$ .

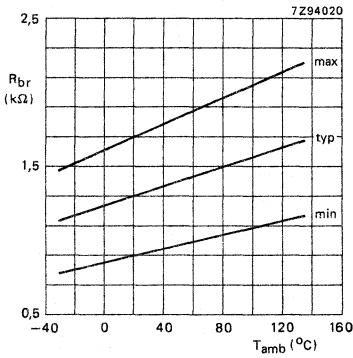

Fig. 7 Bridge resistance.

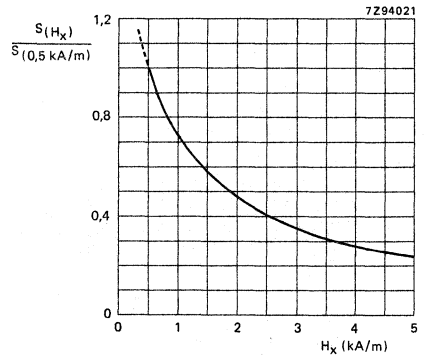

Fig. 8 Relative sensitivity (ratio of sensitivity at certain  $H_x$  and sensitivity at  $H_x = 0,5 \text{ kA/m}$ ).

# DEVELOPMENT DATA

This data sheet contains advance information and specifications are subject to change without notice.

KMZ10B

## MAGNETIC FIELD SENSOR

The KMZ10B is a magnetic field sensor employing the magneto-resistive effect of thin film permalloy. Its properties enable this sensor to be used in a wide range of applications for current and field measurement, revolution counters, angular or linear position measurement and proximity detectors, etc.

### QUICK REFERENCE DATA

Bridge supply voltage	$V_B$	typ.	5 V
Magnetic field range	$H_y$	=	$\pm 2,0$ kA/m
Auxiliary field	$H_x$	=	3 kA/m
Sensitivity	s	typ.	$4 \frac{\text{mV/V}}{\text{kA/m}}$
Operating temperature	$T_{op}$		-40 to +150 °C

### MECHANICAL AND ELECTRICAL DATA

Dimensions in mm

Fig. 1 VO-52B.

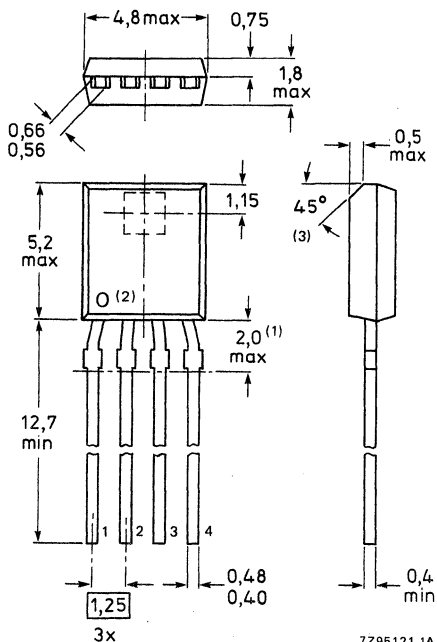
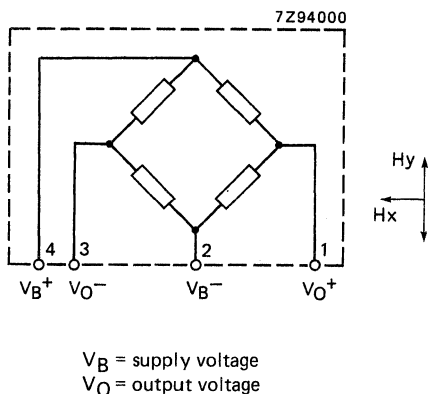

(1) Terminal dimensions uncontrolled within this area

(2) Until October 1985.

(3) Starting October 1985.

**RATINGS**

Limiting values in accordance with the Absolute Maximum System (IEC 134)

Bridge supply voltage	$V_B$	max.	12 V
Total power dissipation up to $T_{amb} = 130\text{ }^\circ\text{C}$	$P_{tot}$	max.	120 mW
Storage temperature	$T_{stg}$		-65 to +150 $^\circ\text{C}$
Operating temperature	$T_{op}$		-40 to +150 $^\circ\text{C}$

**THERMAL RESISTANCE**

From junction to ambient	$R_{th\ j-a}$	=	180 K/W
--------------------------	---------------	---	---------

**CHARACTERISTICS**

$T_{amb} = 25\text{ }^\circ\text{C}$  and  $H_x = 3\text{ kA/m}$  unless otherwise specified

Bridge supply voltage	$V_B$	typ.	5 V
Magnetic field range	$H_Y$		-2,0 to +2,0 kA/m
Open circuit sensitivity	s		$4,0 \pm 0,8 \frac{\text{mV/V}}{\text{kA/m}}$
Temperature coefficient of sensitivity $V_B = \text{constant}; T_j = -25\text{ to } +125\text{ }^\circ\text{C}$ $I_B = \text{constant}; T_j = -25\text{ to } +125\text{ }^\circ\text{C}$	$\alpha_s$	typ.	-0,4 %/K
	$\alpha_s$	typ.	-0,1 %/K
Bridge resistance	$R_{br}$		$1,7 \pm 0,5\text{ k}\Omega$
Temperature coefficient of bridge resistance at $T_j = -25\text{ to } +125\text{ }^\circ\text{C}$	$\alpha R_{br}$	typ.	+0,3 %/K
Off-set voltage with offset trimming*	$V_{off}$		-1,5 to +1,5 mV/V
without offset trimming	$V_{off}$		-20 to +20 mV/V
Temperature coefficient of offset voltage at $T_j = -25\text{ to } +125\text{ }^\circ\text{C}$	$\alpha V_{off}$		-3 to +3 $\frac{\mu\text{V/V}}{\text{K}}$
Linearity deviation of output voltage at $H_Y = 0\text{ to } 50\%$		$\leq$	0,5 % **
$H_Y = 0\text{ to } 80\%$		$\leq$	1,7 % **
$H_Y = 0\text{ to } 100\%$		$\leq$	2,0 % **
Hysteresis of output voltage		$\leq$	0,5 % **
Operating frequency	f	max.	1 MHz

Note: see KMZ10A.

\* Offset trimming to be introduced approx. end 1985.

\*\* Full scale.

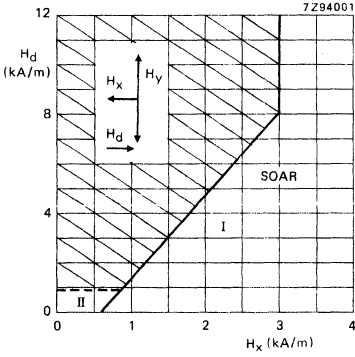

Fig. 2 Safe Operating Area (possible disturbing field  $H_d$  versus auxiliary field  $H_x$ )

- I Region of permissible operation
- II Permissible extension if  $H_y < 1$  kA/m.

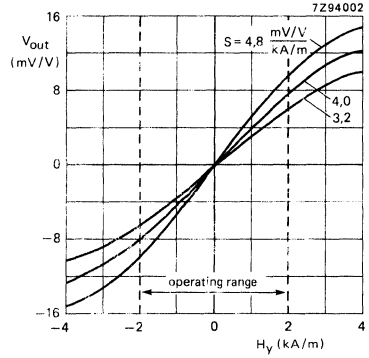

Fig. 3  $V_B = \text{constant}$ ;  
 $H_x = 3$  kA/m;  $T_{amb} = 25$  °C.

DEVELOPMENT DATA

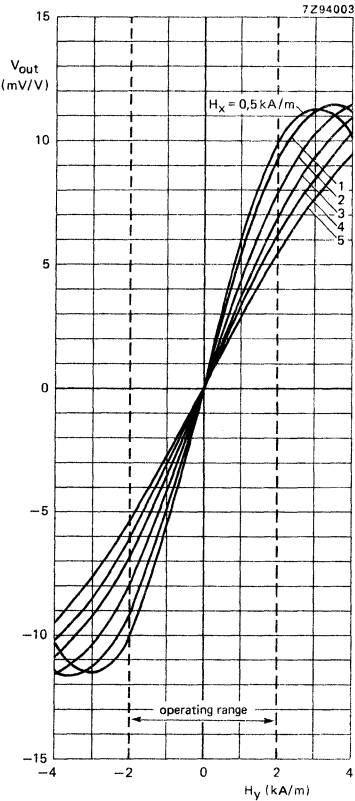

Fig. 4  $V_B = \text{constant}$ ;  $T_{amb} = 25$  °C.

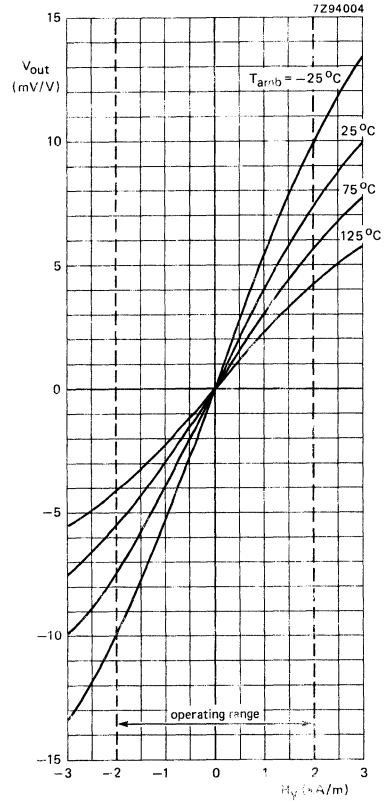

Fig. 5  $V_B = \text{constant}$ ;  $H_x = 3$  kA/m.

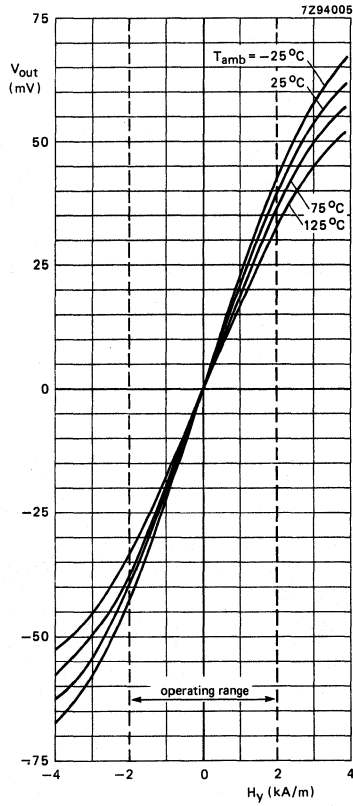

Fig. 6  $I_B = \text{constant} = 3 \text{ mA}$ ;  $H_x = 3 \text{ kA/m}$ .

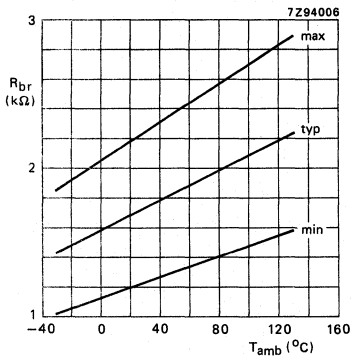

Fig. 7 Bridge resistance.

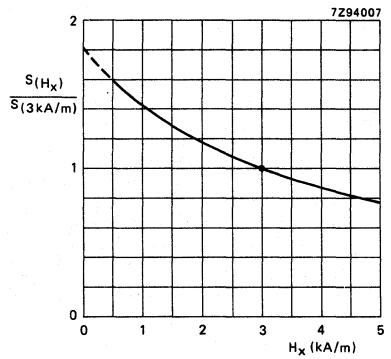

Fig. 8 Relative sensitivity (ratio of sensitivity at certain  $H_x$  and sensitivity at  $H = 3 \text{ kA/m}$ ).



**RATINGS**

Limiting values in accordance with the Absolute Maximum System (IEC 134)

Bridge supply voltage	$V_B$	max.	10 V
Total power dissipation up to $T_{amb} = 130\text{ }^\circ\text{C}$	$P_{tot}$	max.	100 mW
Storage temperature	$T_{stg}$		-65 to + 150 $^\circ\text{C}$
Operating temperature	$T_{op}$		-40 to + 150 $^\circ\text{C}$

**THERMAL RESISTANCE**

From junction to ambient	$R_{th\ j-a}$	=	180 K/W
--------------------------	---------------	---	---------

**CHARACTERISTICS**

$T_{amb} = 25\text{ }^\circ\text{C}$  and  $H_x = 3\text{ kA/m}$  unless otherwise specified

Bridge supply voltage	$V_B$	typ.	5 V
Magnetic field range	$H_y$		-7,5 to + 7,5 kA/m
Open circuit sensitivity	$s$		$1,5 \pm 0,5 \frac{mV/V}{kA/m}$
Temperature coefficient of sensitivity $V_B = \text{constant}; T_j = -25\text{ to } + 125\text{ }^\circ\text{C}$	$\alpha_s$	typ.	-0,5 %/K
$I_B = \text{constant}; T_j = -25\text{ to } + 125\text{ }^\circ\text{C}$	$\alpha_s$	typ.	-0,15 %/K
Bridge resistance	$R_{br}$		$1,4 \pm 0,4\text{ k}\Omega$
Temperature coefficient of bridge resistance at $T_j = -25\text{ to } + 125\text{ }^\circ\text{C}$	$\alpha_{Rbr}$	typ.	+ 0,35 %/K
Off-set voltage with offset trimming*	$V_{off}$		-1,5 to + 1,5 mV/V
without offset trimming	$V_{off}$		-20 to + 20 mV/V
Temperature coefficient of offset voltage at $T_j = -25\text{ to } + 125\text{ }^\circ\text{C}$	$\alpha V_{off}$		-2 to + 2 $\frac{\mu V/V}{K}$
Linearity deviation of output voltage at $H_y = 0\text{ to } 50\%$		$\leq$	0,8 % **
$H_y = 0\text{ to } 80\%$		$\leq$	2,4 % **
$H_y = 0\text{ to } 100\%$		$\leq$	2,7 % **
Hysteresis of output voltage		$\leq$	0,5 % **
Operating frequency	$f$	max.	1 MHz

Note: see KMZ10A.

\* Offset trimming to be introduced approx. end 1985.

\*\* Full scale.

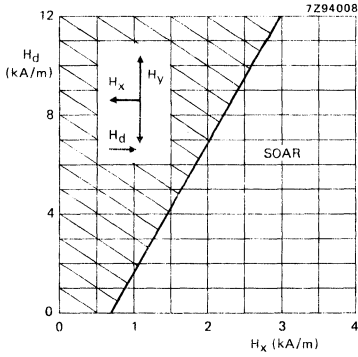

Fig. 2 Safe Operating Area (possible disturbing field  $H_d$  versus auxiliary field  $H_x$ ).

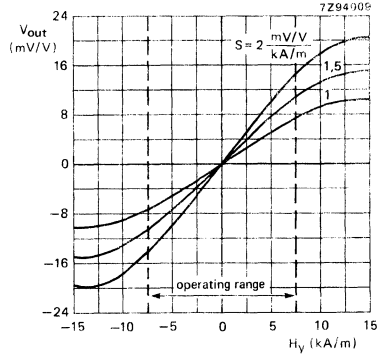

Fig. 3  $V_B = \text{constant}$ ;  
 $H_x = 3 \text{ kA/m}$ ;  $T_{\text{amb}} = 25 \text{ }^\circ\text{C}$ .

DEVELOPMENT DATA

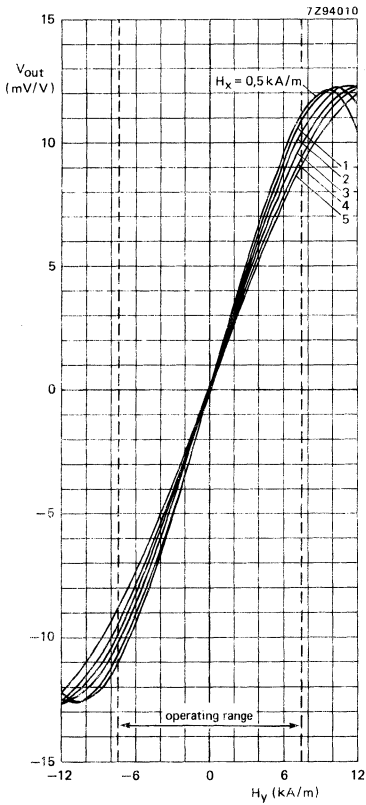

Fig. 4  $V_B = \text{constant}$ ;  $T_{\text{amb}} = 25 \text{ }^\circ\text{C}$ .

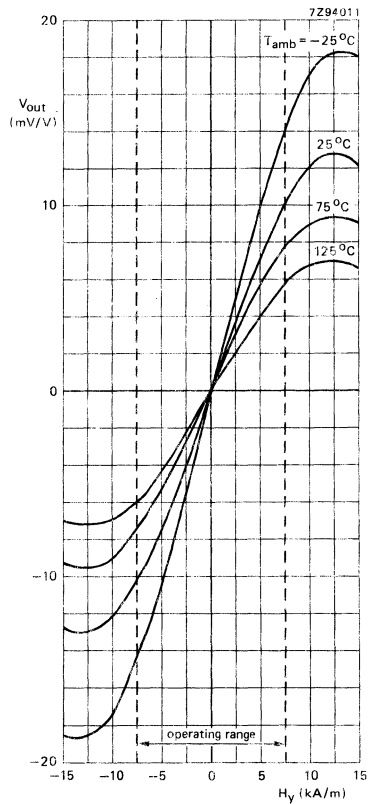

Fig. 5  $V_B = \text{constant}$ ;  $H_x = 3 \text{ kA/m}$ .



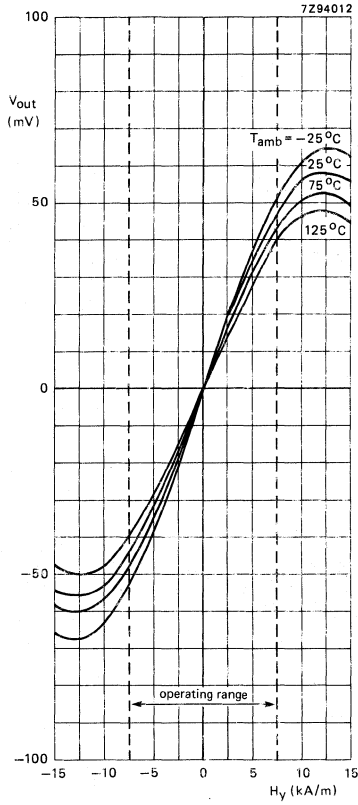

Fig. 6  $I_B = \text{constant} = 3 \text{ mA}$ ;  $H_x = 3 \text{ kA/m}$ .

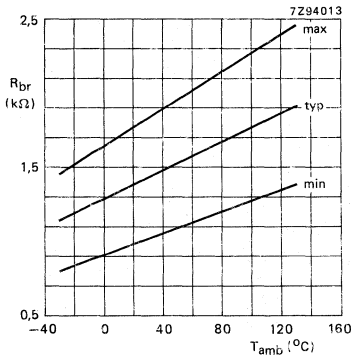

Fig. 7 Bridge resistance.

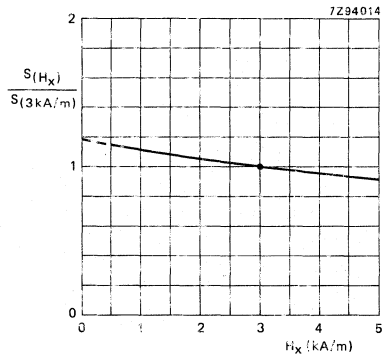

Fig. 8 Relative sensitivity (ratio of sensitivity at certain  $H_x$  and sensitivity at  $H = 3 \text{ kA/m}$ ).

PRESSURE SENSORS



# DEVELOPMENT DATA

This data sheet contains advance information and specifications are subject to change without notice.

KP100A

## MONOLITHIC PRESSURE SENSOR

The KP100A is designed to measure absolute pressure up to 2 bar. The device includes temperature compensation.

### QUICK REFERENCE DATA

Pressure range	$P_{typ}$	0 to 2 bar
Supply voltage	$V_B$	typ. 7,5 V
Operating ambient temperature	$T_{amb}$	-40 to + 105 °C

### MECHANICAL DATA

Dimensions in mm

Fig. 1.

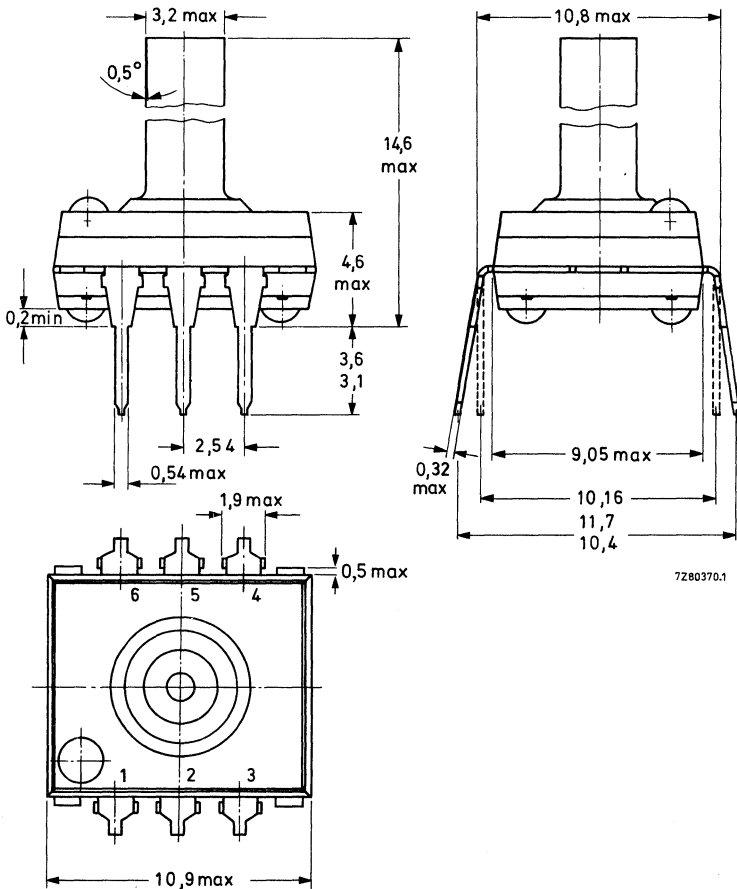

**RATINGS**

Limiting values in accordance with the Absolute Maximum System (IEC 134)

Supply voltage	$V_B$	max.	12 V
Maximum pressure	$P_{max}$	max.	$2 \times P_{typ}$ or 4 bar
Destructive pressure	$P_{des}$	min.	7 bar
Operating ambient temperature	$T_{amb}$		-40 to + 105 °C
Lead soldering temperature at $t_{sld} < 10$ s	$T_{sld}$	max.	260 °C*

**CHARACTERISTICS**

Supply voltage	$V_B$	typ.	7,5 V
Pressure range	$P_{typ}$		0 to + 2 bar
Sensitivity $T_{amb} = 25$ °C	s	typ.	13 mV/Vbar
Temperature coefficient of sensitivity with temperature compensation $T_{amb}$ between -40 and + 85 °C	$\alpha_{scomp}$	typ.	$\pm 0,02$ %/K
Temperature coefficient of sensitivity $T_{amb}$ between -40 and + 85 °C	$\alpha_s$	typ.	-0,2 %/K
Bridge resistance (see Fig. 2) $T_{amb} = 25$ °C	$R_{br}$	typ.	1800 $\Omega$
Offset voltage $T_{amb} = 25$ °C	$V_{off}$	typ.	$\pm 5$ mV/V
Temperature coefficient of offset voltage $T_{amb}$ between -40 and + 85 °C	$\alpha_{off}$	typ.	$\pm 0,04$ %/K
Non-linearity, hysteresis and repeatability $P_{typ}$ between 0 and 2 bar		max.	1 %

**APPLICATION NOTE**

This pressure sensor is primarily intended for barometric measurements. It is advisable to apply non-aggressive and isolating pressure media only.

For application in dirty environments and with aggressive pressure media the KPZ10 pressure sensor series are advised.

\* Solderability may be affected by high temperature storage over longer periods.

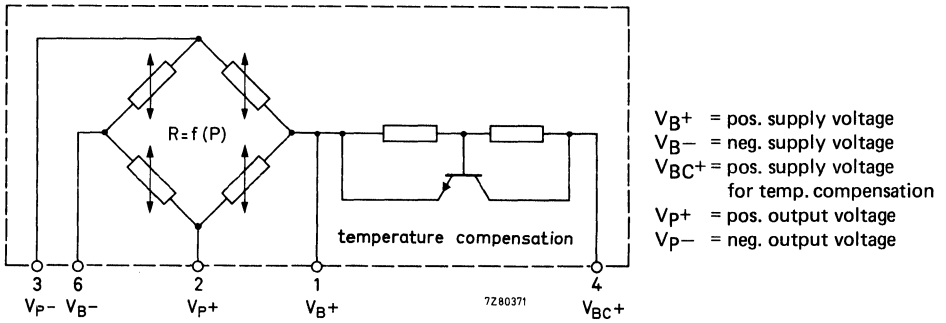

Fig. 2 Schematic diagram.

DEVELOPMENT DATA

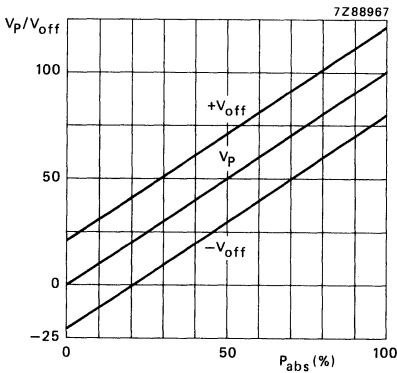

Fig. 3  $V_B = \text{constant}$ ;  $T_{\text{amb}} = \text{constant}$ .

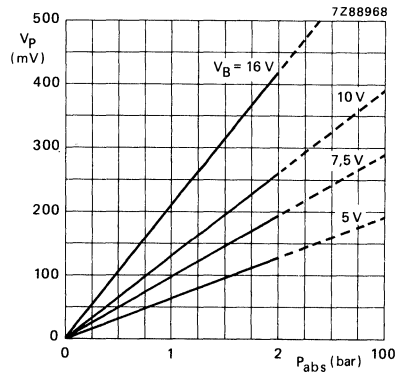

Fig. 4  $V_{\text{off}} = 0$ ;  $T_{\text{amb}} = 25^\circ\text{C}$ ; without temperature compensation.

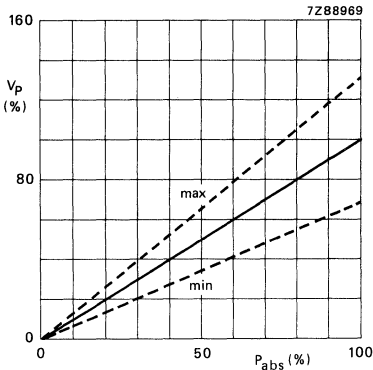

Fig. 5  $V_B = \text{constant}$ ;  $V_{\text{off}} = 0$ ;  $T_{\text{amb}} = \text{constant}$ .

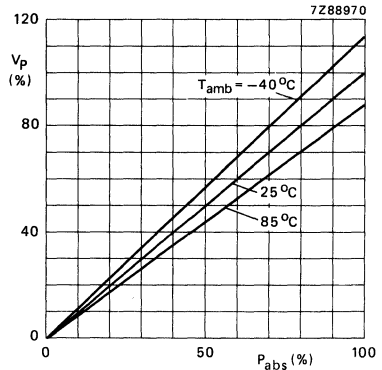

Fig. 6  $V_B = \text{constant}$ ;  $V_{\text{off}} = 0$ ; without temperature compensation.



# DEVELOPMENT DATA

This data sheet contains advance information and specifications are subject to change without notice.

KP101A

## MONOLITHIC PRESSURE SENSOR

The KP101A is designed for measurement of atmospheric pressures up to 1,2 bars. The sensor comprises a monolithic silicon vacuum cell incorporating diffused strain gauge resistors and integral sensitivity temperature compensation.

The housing is a plastic moulded 6-pin DIL package with a rigid capillary tube for the pressure connection.

### QUICK REFERENCE DATA

Absolute pressure range	P	0 to 1,2 bar
Supply voltage	$V_B$	typ. 5 V
Operating ambient temperature	$T_{amb}$	-40 to + 125 °C

### MECHANICAL DATA

Dimensions in mm

Fig. 1.

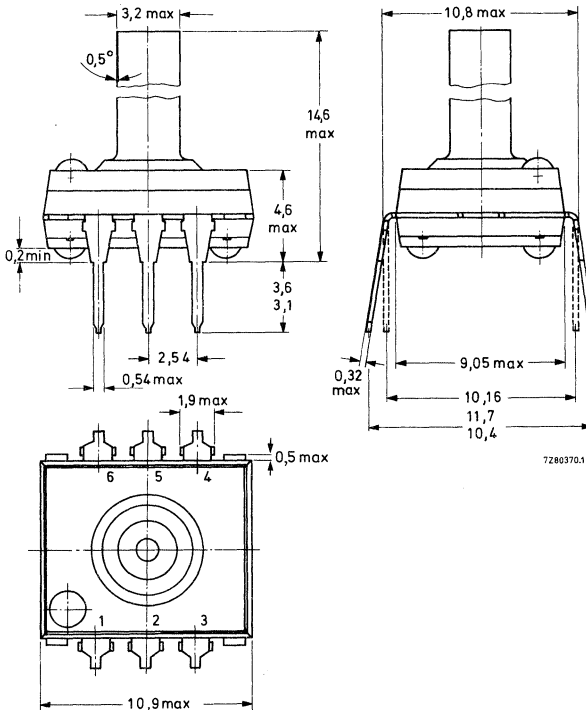



**RATINGS**

Limiting values in accordance with the Absolute Maximum System (IEC 134)

Supply voltage	$V_B$	max.	12 V
Maximum pressure (absolute)	$P_{max}$	max.	2,5 bar
Destructive pressure (absolute)	$P_{des}$	min.	6 bar
Operating ambient temperature	$T_{amb}$		-40 to + 125 °C
Lead soldering temperature at $t_{sld} < 10$ s	$T_{sld}$	max.	260 °C

**CHARACTERISTICS**

Absolute pressure range	P		0 to 1,2 bar
Bridge resistance (see Fig. 2) $T_{amb} = 25$ °C	$R_{br}$		1600 ± 500 Ω

**Without temperature compensation**

Supply voltage (terminals 1 and 6)	$V_B$	typ.	5 V
Sensitivity at $T_{amb} = 25$ °C	s	typ.	100 mV/bar (70 to 140)

Temperature coefficient of sensitivity $T_{amb}$ between -40 and + 85 °C	$\alpha_s$	typ.	-0,22 %/K
---	------------	------	-----------

Offset voltage $T_{amb} = 25$ °C	$V_{off}$		-25 to + 25 mV
-------------------------------------	-----------	--	----------------

Temperature coefficient of offset voltage $T_{amb}$ between -40 and + 85 °C	$\alpha V_{off}$	typ.	± 0,04 %/K
--	------------------	------	------------

Non-linearity, hysteresis and repeatability between 0 and 1,2 bar		≤	0,6 %
--	--	---	-------

Hysteresis with temperature*		≤	0,5 %
------------------------------	--	---	-------

**With temperature compensation**

Supply voltage (terminals 4 and 6)	$V_B$	typ.	5 V
Sensitivity at $T_{amb} = 25$ °C	$s_{comp}$	typ.	50 mV/bar (25 to 75)

Temperature coefficient of sensitivity $T_{amb}$ between -40 and + 85 °C	$\alpha s_{comp}$	typ.	± 0,03 %/K
---	-------------------	------	------------

Offset voltage $T_{amb} = 25$ °C	$V_{off comp}$	typ.	± 15 mV
-------------------------------------	----------------	------	---------

Temperature coefficient of offset voltage $T_{amb}$ between -40 and + 85 °C	$\alpha V_{off comp}$	typ.	± 0,06 %/K
--	-----------------------	------	------------

Non-linearity, hysteresis and repeatability between 0 and 1,2 bar		≤	0,6 %
--	--	---	-------

\* Measured with a linear temperature cycle from -10 °C to + 85 °C with a periodic time of not less than 30 minutes.

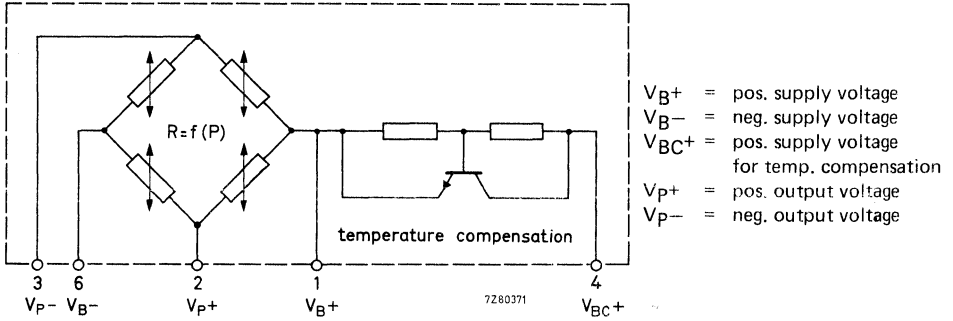

Fig. 2 Schematic diagram.

DEVELOPMENT DATA

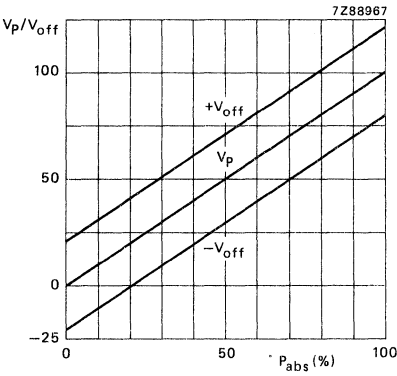

Fig. 3  $V_B = \text{constant}$ ;  $T_{\text{amb}} = \text{constant}$ .

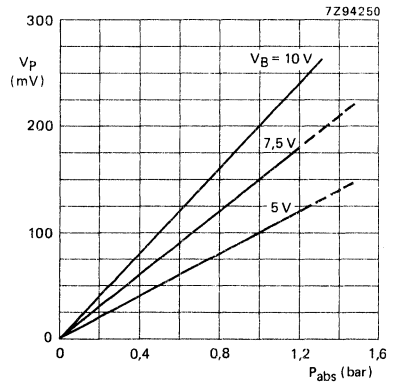

Fig. 4  $V_{\text{off}} = 0$ ;  $T_{\text{amb}} = 25^\circ\text{C}$ ; without temperature compensation.

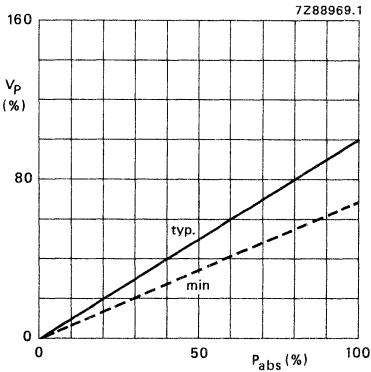

Fig. 5  $V_B = \text{constant}$ ;  $V_{\text{off}} = 0$ ;  $T_{\text{amb}} = \text{constant}$ .

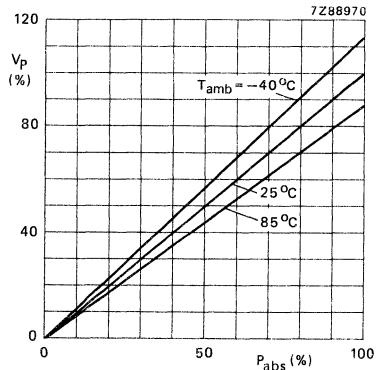

Fig. 6  $V_B = \text{constant}$ ; offset omitted; without temperature compensation.





**RATINGS**

Limiting values in accordance with the Absolute Maximum System (IEC 134)

Supply voltage	$V_B$	max.	16 V
Maximum pressure	$P_{max}$	max.	5 bar
Destructive pressure	$P_{des}$	min.	10 bar
Operating ambient temperature	$T_{amb}$		-40 to + 125 °C
Storage temperature	$T_{stg}$	max.	140 °C
Lead soldering temperature at $t_{sld} < 10$ s	$T_{sld}$	max.	260 °C*

**CHARACTERISTICS**

Supply voltage	$V_B$	typ.	7,5 V
Pressure range	$P_{typ}$		-1 to + 2 bar
Sensitivity			
$T_{amb} = 25$ °C	$s$		$10,5 \pm 3,5$ mV/Vbar
Temperature coefficient of sensitivity			
$T_{amb}$ between -40 and + 85 °C	$\alpha_s$	typ.	-0,15 %/K
Bridge resistance			
$T_{amb} = 25$ °C	$R_{br}$	typ.	2000 $\Omega$
Offset voltage			
$T_{amb} = 25$ °C	$V_{off}$	max.	$\pm 5$ mV/V
Temperature coefficient of offset voltage			
$T_{amb}$ between -40 and + 85 °C	$\alpha_{off}$	max.	$\pm 0,05$ %/K
Non-linearity and hysteresis at $T_{amb} = 25$ °C			
$P_{typ}$ between -1 and 2 bar		max.	$\pm 0,7$ %

Fig. 2 Schematic diagram.

$V_B$  = supply voltage  
 $V_P$  = output voltage

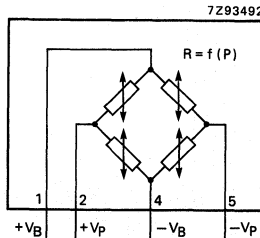

\* Solderability may be affected by high temperature storage over longer periods.

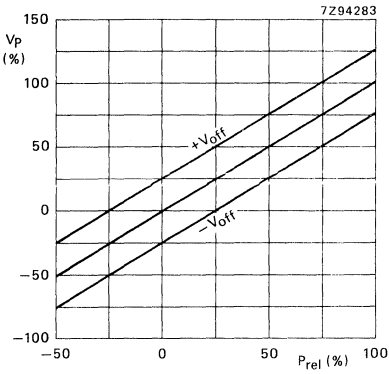

Fig. 3  $V_B = \text{constant}$ ;  $T_{amb} = \text{constant}$ .

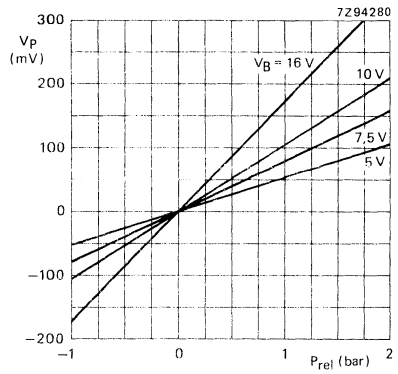

Fig. 4  $V_{off} = 0$ ;  $T_{amb} = 25^\circ\text{C}$ .

DEVELOPMENT DATA

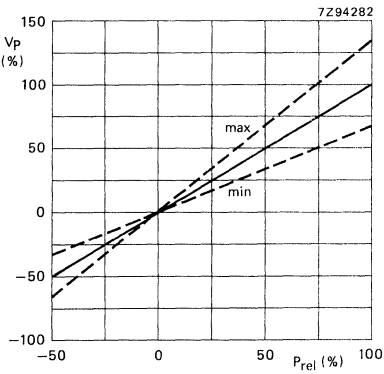

Fig. 5  $V_B = \text{constant}$ ;  $V_{off} = 0$ ;  
 $T_{amb} = \text{constant}$ .

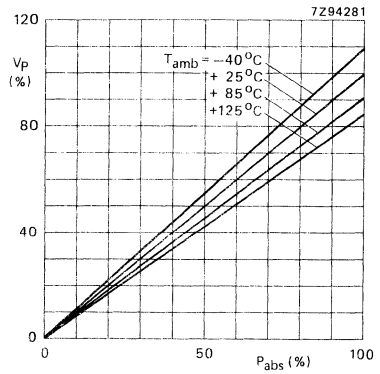

Fig. 6  $V_B = \text{constant}$ ; offset omitted.



# DEVELOPMENT DATA

This data sheet contains advance information and specifications are subject to change without notice.

KPZ21G

## THIN-FILM PRESSURE SENSOR

The KPZ21G is designed for measurement of relative pressures up to 10 bar and for a wide range of gases or fluids. The sensor employs thin-film semiconductor strain gauges deposited on a beryllium copper isolating diaphragm. Sealing is obtained by pressure contact using an O-ring in a groove provided in the transfer-moulded body and electrical connections are made via silverplated leads-outs to form a dual-in-line configuration.

All pressure media, which do not attack CuBe, epoxy novolack plastic, epoxy glue and assembly parts, may be used.

### QUICK REFERENCE DATA

Pressure range	P	-1 to 10 bar
Supply voltage	$V_B$	typ. 7,5 V
Operating ambient temperature	$T_{amb}$	-40 to +125 °C

### MECHANICAL DATA

Dimensions in mm

Fig. 1.

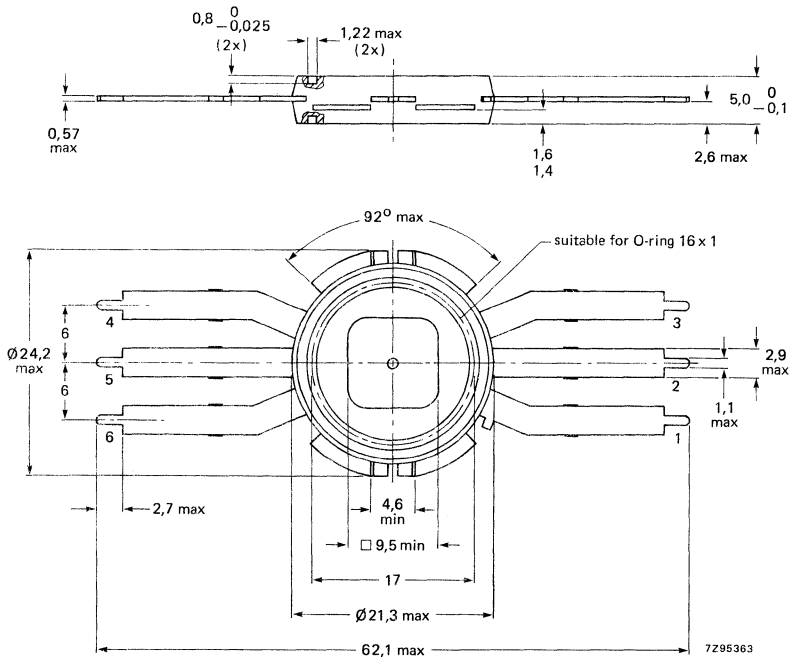



**RATINGS**

Limiting values in accordance with the Absolute Maximum System (IEC 134)

Supply voltage	$V_B$	max.	16 V
Maximum pressure	$P_{max}$	max.	20 bar
Destructive pressure	$P_{des}$	min.	30 bar
Operating ambient temperature	$T_{amb}$		-40 to + 125 °C
Storage temperature	$T_{stg}$	max.	140 °C
Lead soldering temperature at $t_{slid} < 10$ s	$T_{slid}$	max.	260 °C*

**CHARACTERISTICS**

Supply voltage	$V_B$	typ.	7,5 V
Pressure range	$P_{typ}$		-1 to + 10 bar
Sensitivity			
$T_{amb} = 25$ °C	$s$		$3,5 \pm 1$ mV/Vbar
Temperature coefficient of sensitivity			
$T_{amb}$ between -40 and + 85 °C	$\alpha_s$	typ.	-0,14 %/K
Bridge resistance			
$T_{amb} = 25$ °C	$R_{br}$	typ.	2000 $\Omega$
Offset voltage			
$T_{amb} = 25$ °C	$V_{off}$	max.	$\pm 5$ mV/V
Temperature coefficient of offset voltage			
$T_{amb}$ between -40 and + 85 °C	$\alpha_{off}$	max.	$\pm 0,05$ %/K
Non-linearity and hysteresis			
$P_{typ}$ between 0 and 10 bar		max.	$\pm 0,7$ %

Fig. 2 Schematic diagram.

$V_B$  = supply voltage  
 $V_P$  = output voltage

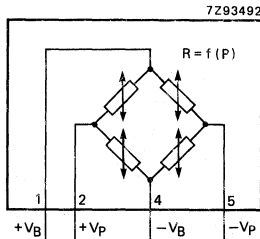

\* Solderability may be affected by high temperature storage over longer periods.

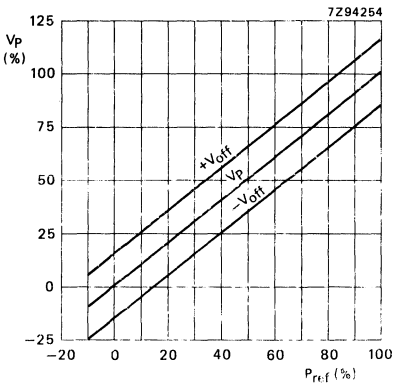

Fig. 3  $V_B = \text{constant}$ ;  $T_{amb} = \text{constant}$ .

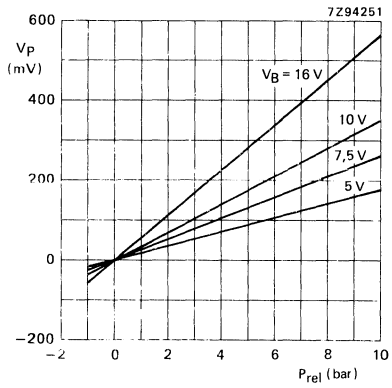

Fig. 4  $V_{off} = 0$ ;  $T_{amb} = 25\text{ }^\circ\text{C}$ .

DEVELOPMENT DATA

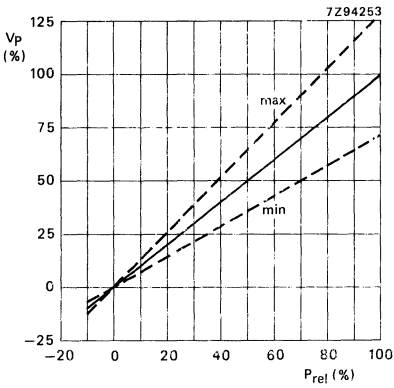

Fig. 5  $V_B = \text{constant}$ ;  $V_{off} = 0$ ;  
 $T_{amb} = \text{constant}$ .

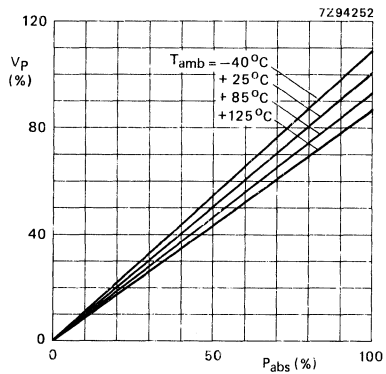

Fig. 6  $V_B = \text{constant}$ ; offset omitted.



## TEMPERATURE SENSORS



## SILICON TEMPERATURE SENSORS

These sensors have a positive temperature coefficient of resistance and are for use in measurement and control.

### QUICK REFERENCE DATA

Resistance at  $T_{amb} = 25\text{ }^{\circ}\text{C}$   
 $I = 1\text{ mA}$

KTY81-110	R <sub>25</sub>	1000 $\Omega \pm 1\%$
KTY81-120	R <sub>25</sub>	1000 $\Omega \pm 2\%$

Measuring temperature range

-55 to +150  $^{\circ}\text{C}$

### MECHANICAL DATA

Dimensions in mm

Fig. 1 SOD-70.

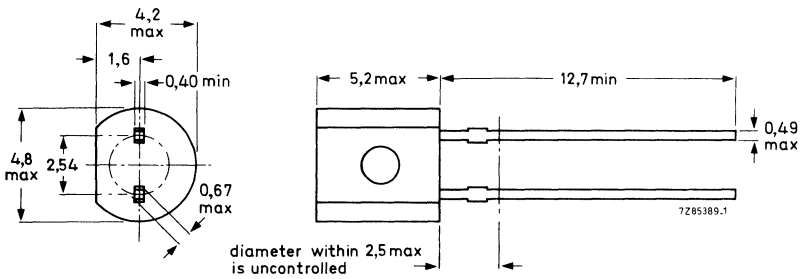

## RATINGS

Limiting values in accordance with the Absolute Maximum System (IEC 134)

Continuous sensor current in free air

$$T_{amb} = 25 \text{ }^{\circ}\text{C}$$

$I_D$  max. 10 mA

$$T_{amb} = 150 \text{ }^{\circ}\text{C}$$

$I_D$  max. 2 mA

## CHARACTERISTICS

$T_{amb} = 25 \text{ }^{\circ}\text{C}$  unless otherwise specified

Resistance

$$I = 1 \text{ mA}$$

KTY81-110  $R_{25}$  typ. 1000  $\Omega$   
990 to 1010  $\Omega$

KTY81-120  $R_{25}$  typ. 1000  $\Omega$   
980 to 1020  $\Omega$

Temperature coefficient

$$R_{100}/R_{25}$$

typ. 0,75 %/K

$$R_{-55}/R_{25}$$

$$1,69 \pm 0,02$$

$$0,49 \pm 0,01$$

Thermal time constant\*

in still air

typ. 50 s

in still liquid\*\*

typ. 5 s

in flowing liquid\*\*

typ. 3 s

Measuring temperature range

-55 to +150  $^{\circ}\text{C}$

Ambient temperatures and corresponding resistance values of sensor

$T_{amb}$ $^{\circ}\text{C}$	resistance $\Omega$
-55	495
-50	514
-40	568
-30	625
-20	686
-10	750
0	817
10	887
20	961
25	1000
30	1039
40	1120

$T_{amb}$ $^{\circ}\text{C}$	resistance $\Omega$
50	1205
60	1295
70	1390
80	1489
90	1591
100	1696
110	1804
120	1915
130	2017
140	2120
150	2225

\* The thermal time constant is the time the sensor needs to reach 63,2% of the total temperature difference. For instance, the time needed to reach a temperature of 72,4  $^{\circ}\text{C}$ , when a sensor with an initial temperature of 25  $^{\circ}\text{C}$  is put into an ambient with a temperature of 100  $^{\circ}\text{C}$ .

\*\* Inert liquid FC43 of 3M.

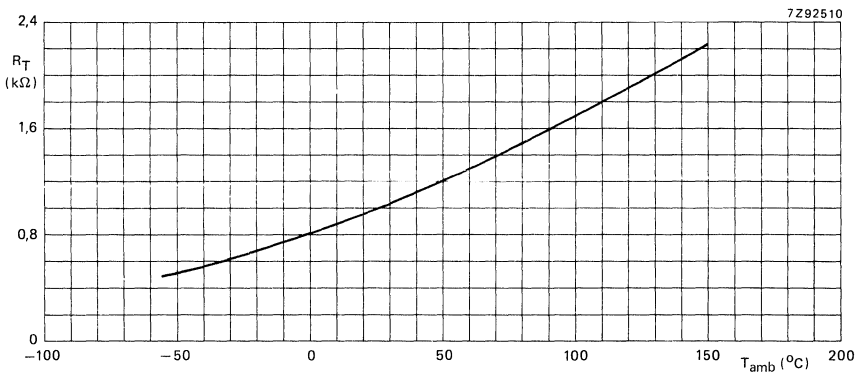

Fig. 2 Resistance value of sensor at I = 1 mA as a function of temperature.

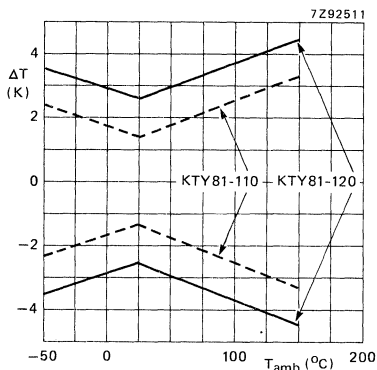

Fig. 3 Absolute error  $\Delta T$  (standard deviation) expected from a KTY81-100 temperature sensor.

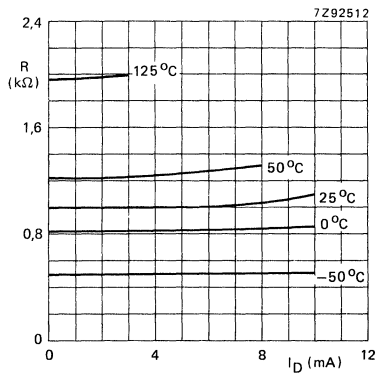

Fig. 4 Sensor resistance versus operating current.

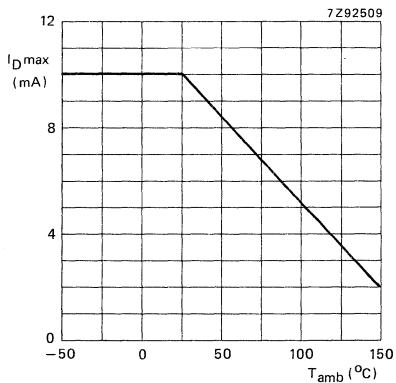

Fig. 5 Maximum operating current for safe operation.





## SILICON TEMPERATURE SENSORS

These sensors have a positive temperature coefficient of resistance and are for use in measurement and control.

## QUICK REFERENCE DATA

Resistance at  $T_{amb} = 25\text{ }^{\circ}\text{C}$   
 $I = 0,5\text{ mA}$

KTY81-210	R <sub>25</sub>	2000 $\Omega \pm 1\%$
KTY81-220	R <sub>25</sub>	2000 $\Omega \pm 2\%$

Measuring temperature range

-55 to +150  $^{\circ}\text{C}$

## MECHANICAL DATA

Dimensions in mm

Fig. 1 SOD-70.

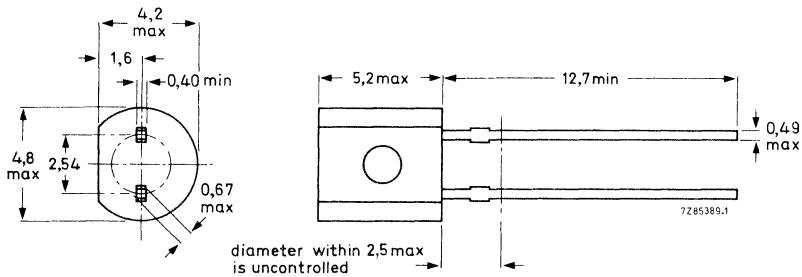

## RATINGS

Limiting values in accordance with the Absolute Maximum System (IEC 134)

Continuous sensor current in free air

$T_{amb} = 25\text{ }^{\circ}\text{C}$

$I_D$  max. 10 mA

$T_{amb} = 150\text{ }^{\circ}\text{C}$

$I_D$  max. 2 mA

## CHARACTERISTICS

$T_{amb} = 25\text{ }^{\circ}\text{C}$  unless otherwise specified

Resistance

$I = 0,5\text{ mA}$

KTY81-210

$R_{25}$  typ. 2000  $\Omega$   
1980 to 2020  $\Omega$

KTY81-220

$R_{25}$  typ. 2000  $\Omega$   
1960 to 2040  $\Omega$

Temperature coefficient

$R_{100}/R_{25}$

typ. 0,75 %/K

$R_{-55}/R_{25}$

$1,69 \pm 0,02$

$0,49 \pm 0,01$

Thermal time constant\*

in still air

typ. 50 s

in still liquid\*\*

typ. 5 s

in flowing liquid\*\*

typ. 3 s

Measuring temperature range

$-55$  to  $+150\text{ }^{\circ}\text{C}$

Ambient temperatures and corresponding resistance values of sensor

$T_{amb}$ $^{\circ}\text{C}$	resistance $\Omega$
-55	990
-50	1028
-40	1136
-30	1250
-20	1372
-10	1500
0	1634
10	1774
20	1922
25	2000
30	2078
40	2240

$T_{amb}$ $^{\circ}\text{C}$	resistance $\Omega$
50	2410
60	2590
70	2780
80	2978
90	3182
100	3392
110	3593
120	3800
125	3904
130	4005
140	4180
150	4306

\* The thermal time constant is the time the sensor needs to reach 63,2% of the total temperature difference. For instance, the time needed to reach a temperature of  $72,4\text{ }^{\circ}\text{C}$ , when a sensor with an initial temperature of  $25\text{ }^{\circ}\text{C}$  is put into an ambient with a temperature of  $100\text{ }^{\circ}\text{C}$ .

\*\* Inert liquid FC43 of 3M.

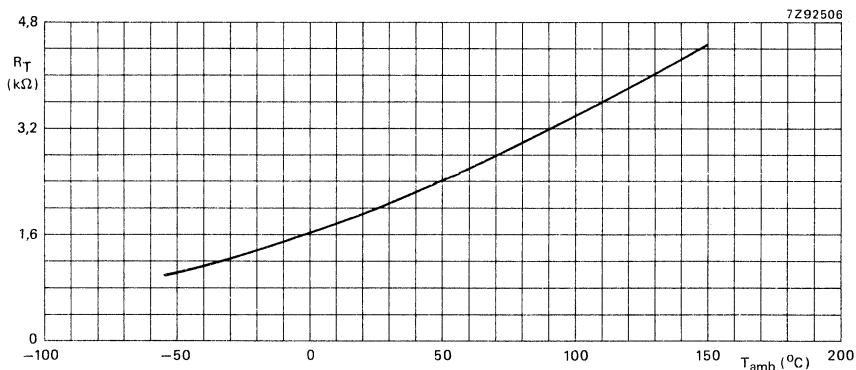

Fig. 2 Resistance value of sensor at I = 0,5 mA as a function of temperature.

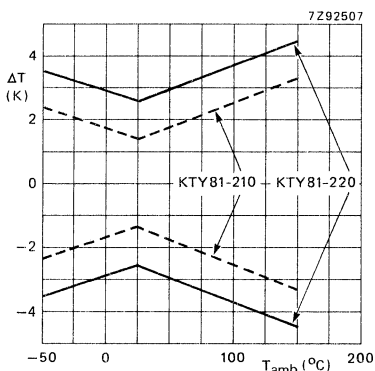

Fig. 3 Absolute error  $\Delta T$  (standard deviation) expected from a KTY81-200 temperature sensor.

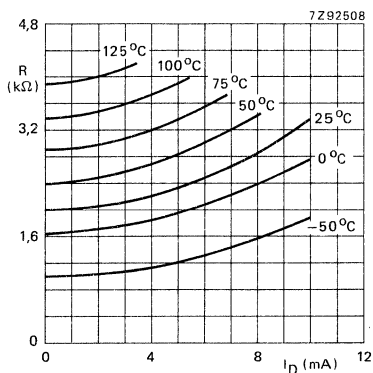

Fig. 4 Sensor resistance versus operating current.

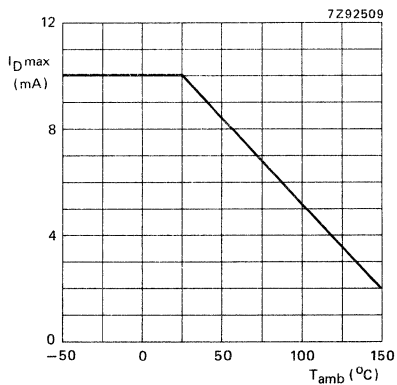

Fig. 5 Maximum operating current for safe operation.



## SILICON TEMPERATURE SENSORS

These sensors have a positive temperature coefficient of resistance and are for use in measurement and control.

### QUICK REFERENCE DATA

Resistance at  $T_{amb} = 25\text{ }^{\circ}\text{C}$   
 $I = 1\text{ mA}$

KTY83-110	$R_{25}$	$1000\ \Omega \pm 1\ \%$
KTY83-120	$R_{25}$	$1000\ \Omega \pm 2\ \%$

Measuring temperature range

-55 to + 175  $^{\circ}\text{C}$

### MECHANICAL DATA

Dimensions in mm

Fig. 1 DO-34 (SOD-68).

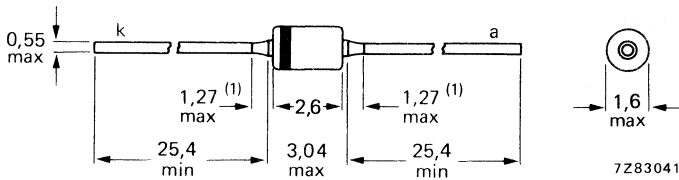

(1) Lead diameter in this zone uncontrolled.

## RATINGS

Limiting values in accordance with the Absolute Maximum System (IEC 134)

Continuous sensor current in free air

$$T_{amb} = 25\text{ }^{\circ}\text{C}$$

$I_D$  max. 10 mA

$$T_{amb} = 175\text{ }^{\circ}\text{C}$$

$I_D$  max. 2 mA

## CHARACTERISTICS

$T_{amb} = 25\text{ }^{\circ}\text{C}$  unless otherwise specified

Resistance

$$I = 1\text{ mA}$$

KTY83-110  $R_{25}$  typ. 1000  $\Omega$   
990 to 1010  $\Omega$

KTY83-120  $R_{25}$  typ. 1000  $\Omega$   
980 to 1020  $\Omega$

Temperature coefficient

$$R_{100}/R_{25}$$

typ. 0,75 %/K

$$R_{-55}/R_{25}$$

$$1,68 \pm 0,02$$

$$0,49 \pm 0,01$$

Thermal time constant\*

in still air

typ. 40 s

in still liquid\*\*

typ. 1 s

in flowing liquid\*\*

typ. 0,5 s

Measuring temperature range

-55 to +175  $^{\circ}\text{C}$

Ambient temperatures and corresponding resistance values of sensor

$T_{amb}$ $^{\circ}\text{C}$	resistance $\Omega$
-55	495
-50	520
-40	572
-30	627
-20	687
-10	750
0	817
10	887
20	961
25	1000
30	1039
40	1121

$T_{amb}$ $^{\circ}\text{C}$	resistance $\Omega$
50	1206
60	1295
70	1387
80	1483
90	1583
100	1687
110	1794
120	1905
125	1962
130	2020
140	2138
150	2260

\* The thermal time constant is the time the sensor needs to reach 63,2% of the total temperature difference. For instance, the time needed to reach a temperature of 72,4  $^{\circ}\text{C}$ , when a sensor with an initial temperature of 25  $^{\circ}\text{C}$  is put into an ambient with a temperature of 100  $^{\circ}\text{C}$ .

\*\* Inert liquid FC43 of 3M.

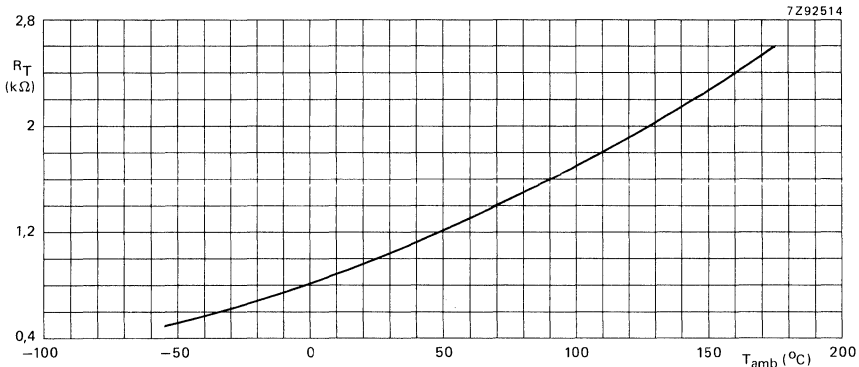

Fig. 2 Resistance value of sensor at  $I = 1 \text{ mA}$  as a function of temperature.

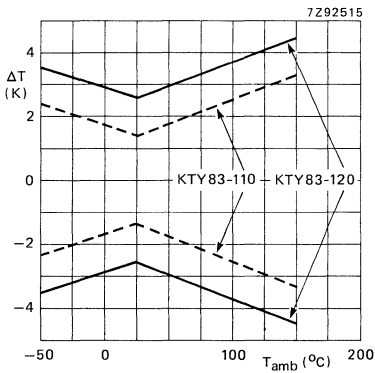

Fig. 3 Absolute error  $\Delta T$  (standard deviation) expected from a KTY83-100 temperature sensor.

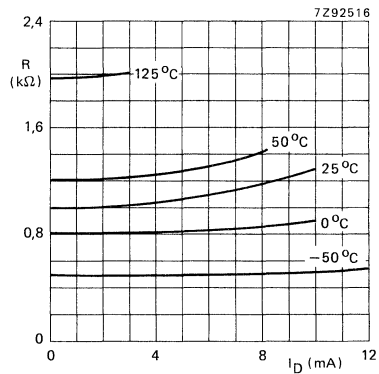

Fig. 4 Series resistance versus operating current.

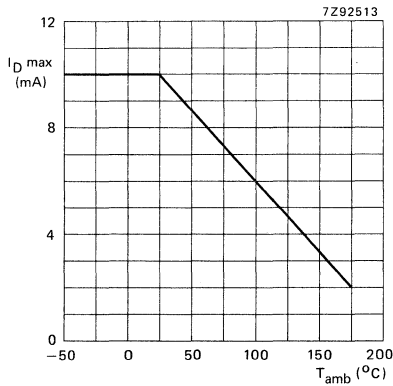

Fig. 5 Maximum operating current for safe operation.





# DEVELOPMENT DATA

This data sheet contains advance information and specifications are subject to change without notice.

# KTY84-100 SERIES

## SILICON TEMPERATURE SENSORS

These sensors have a positive temperature coefficient of resistance and are for use in measurement and control.

### QUICK REFERENCE DATA

Resistance at  $T_{amb} = 100\text{ }^{\circ}\text{C}$   
 $I = 2\text{ mA}$

KTY84-130	R <sub>100</sub>	1000 $\Omega \pm 3\%$
KTY84-150	R <sub>100</sub>	1000 $\Omega \pm 5\%$

Measuring temperature range

0 to + 300  $^{\circ}\text{C}$

### MECHANICAL DATA

Dimensions in mm

Fig. 1 DO-34 (SOD-68).

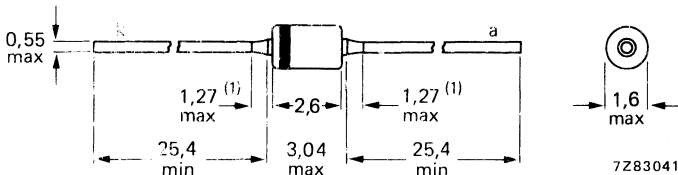

(1) Lead diameter in this zone uncontrolled.

The sensor has to be operated in the forward biased condition.

## RATINGS

Limiting values in accordance with the Absolute Maximum System (IEC 134)

Continuous sensor current in free air

$$T_{amb} = 25 \text{ }^{\circ}\text{C}$$

$I_D$  max; 10 mA

$$T_{amb} = 300 \text{ }^{\circ}\text{C}$$

$I_D$  max. 4 mA

## CHARACTERISTICS

Resistance

$$I = 2 \text{ mA}; T_{amb} = 100 \text{ }^{\circ}\text{C} \text{ 1)}$$

KTY84-130  $R_{100}$  typ. 1000  $\Omega$   
970 to 1030  $\Omega$

KTY84-150  $R_{100}$  typ. 1000  $\Omega$   
950 to 1050  $\Omega$

Temperature coefficient

$$R_{250}/R_{100}$$

typ. 0,60 %/K

$$R_{25}/R_{100}$$

$2,185 \pm 0,04$

$0,592 \pm 0,01$

Thermal time constant 2)

in still air

typ. 40 s

in still liquid 3)

typ. 1 s

in flowing liquid 3)

typ. 0,5 s

Measuring temperature range

0 to + 300  $^{\circ}\text{C}$

Storage temperature

-55 to + 300  $^{\circ}\text{C}$

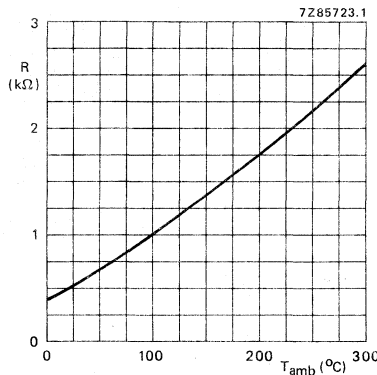

Fig. 2 Resistance value of sensor at  $I = 2 \text{ mA}$  as a function of ambient temperature.

- 1) For operation over 200  $^{\circ}\text{C}$  a current  $I \geq 2 \text{ mA}$  is prescribed.
- 2) The thermal time constant is the time the sensor needs to reach 63,2% of the total temperature difference. For instance, the time needed to reach a temperature of 72,4  $^{\circ}\text{C}$ , when a sensor with an initial temperature of 25  $^{\circ}\text{C}$  is put into an ambient with a temperature of 100  $^{\circ}\text{C}$ .
- 3) Inert liquid FC43 of 3M.

## RESISTANCE VALUES for KTY84

Degree C	Resistance ( $\Omega$ )
0	486
10	528
20	572
30	618
40	666
50	716
60	769
70	823
80	880
90	939
100	1000
110	1063
120	1128
130	1195
140	1264
150	1336
160	1409
170	1485
180	1563
190	1643
200	1725
210	1809
220	1896
230	1984
240	2076
250	2170
260	2263
270	2359
280	2458
290	2559
300	2662

DEVELOPMENT DATA



**HYBRID INTEGRATED CIRCUITS FOR  
INDUCTIVE PROXIMITY DETECTORS**

## HYBRID INTEGRATED CIRCUITS FOR INDUCTIVE PROXIMITY DETECTORS

OM-	L x W mm (max.)	V <sub>S</sub> V	I <sub>O</sub> mA	false polarity protection	short-circuit/ overload prot.	R <sub>x</sub>	
						discr.	integr.
286	35,2 x 5	4,5 - 30	50 - 250*	supply	no	yes	no
287	35,2 x 5	4,5 - 30	50 - 250*	supply	no	yes	no
286M	22,6 x 5	4,5 - 30	50 - 250*	supply	no	yes	no
287M	22,6 x 5	4,5 - 30	50 - 250*	supply	no	yes	no
386B	43,6 x 5	10 - 30	250	supply/load	yes	yes	yes
387B	43,6 x 5	10 - 30	250	supply/load	yes	yes	yes
386M	22,5 x 5**	10 - 30	200	supply/load	yes	yes	yes
387M	22,5 x 5**	10 - 30	200	supply/load	yes	yes	yes
388B	25,6 x 8,2	10 - 30	250	supply/load	yes	yes	yes
389B	25,6 x 8,2	10 - 30	250	supply/load	yes	yes	yes

\* Depending upon supply voltage (for odd-numbered types: reverse polarity).

\*\* After assembling.

**NOTE:** The 300-series provide the possibility of directly connecting a LED for function control, without additional power dissipation.

## HYBRID INTEGRATED CIRCUITS FOR INDUCTIVE PROXIMITY DETECTORS

Hybrid integrated circuits intended for inductive proximity detectors in tubular construction, especially the M8 hollow stud. The OM286 and OM286M are for positive supply voltage and the OM287 and OM287M are for negative supply voltage. The circuit consists of an oscillator, a rectifier stage, a Schmitt trigger and an output stage. The circuit performs a make function: when actuated the current flows through the load, which can be e.g. the coil of an electromagnetic relay, a LED or a photocoupler.

The output transistor is protected against transients from the inductive load by a voltage regulator diode. The circuit is protected against false polarity connection of the supply voltage.

The devices OM286/OM287 are thick-film circuits and the OM287M/OM287M are thin-film circuits deposited on ceramic substrates. They may be potted, together with the oscillator coil and a resistor ( $R_X$ ), in a non-magnetic tube.

### QUICK REFERENCE DATA

D.C. supply voltage range	$V_B$	4,5 to 30 V
Output current at $V_B = 24$ V	$I_O$	max. 250 mA
Operating (switching) distance (depends on $R_X$ value and oscillator coil)	S	1 to 5 mm
Differential travel (hysteresis in switching distance)	H	3 to 10 %
Operating (switching) frequency	f	< 5 kHz
Operating substrate temperature range*	$T_s$	-40 to +85 °C
Substrate length of OM286 and OM287	L	35,0 ± 0,2 mm
Substrate length of OM286M and OM287M	L	22,4 ± 0,2 mm
Substrate width	W	4,8 ± 0,2 mm
Height of circuit including substrate	h	max. 1,7 mm

### MECHANICAL DATA

Dimensions in mm

Fig. 1a and 1b (next page).

\* The tube, potting and connection materials are the main limiting factors for the operating temperature range of a completely assembled proximity detector.



MECHANICAL DATA

Dimensions in mm

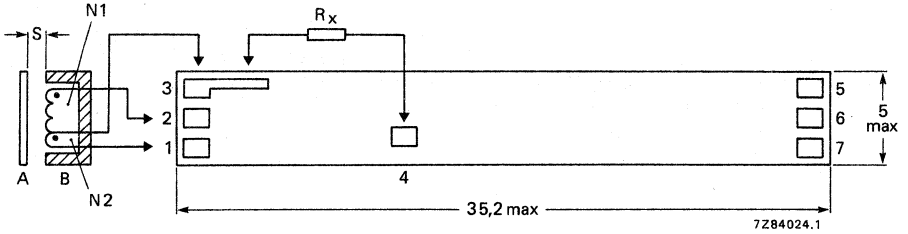

Fig. 1a OM286/OM287.

A = metal actuator  
B = open potcore or  
potcore half with coil

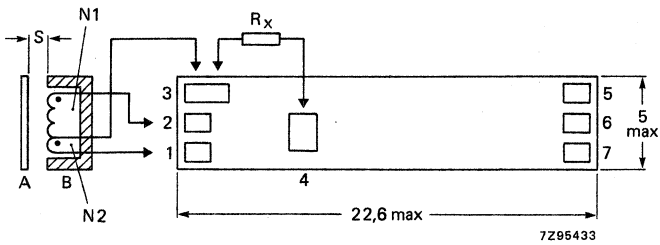

Fig. 1b OM286M/OM287M.

Mechanical outline and connections: note that the supply polarities to points 5 and 7 are given for the OM286 and OM286M; for the OM287 and OM287M the polarities are point 5:  $-V_B$ , and point 7:  $+V_B$ . S is the operating distance.

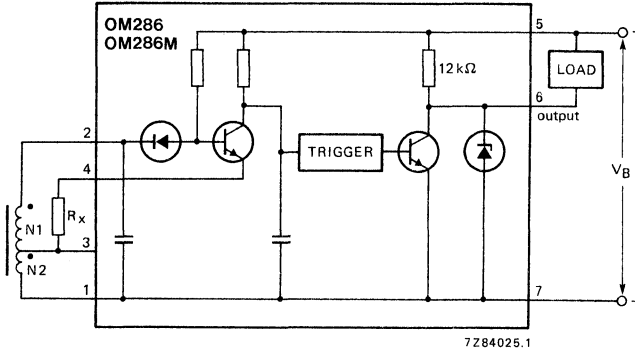

Fig. 2 Circuit diagram of OM286 and OM286M.

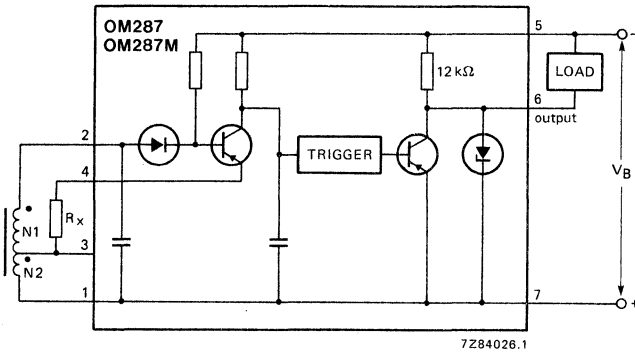

Fig. 3 Circuit diagram of OM287 and OM287M.

**RATINGS**

Limiting values in accordance with the Absolute Maximum System (IEC 134)

D.C. supply voltage	$V_B$	max.	30 V
Output current	$I_o$	max.	250 mA
Storage temperature	$T_{stg}$		-40 to +125 °C
Operating substrate temperature	$T_s$		-40 to +85 °C

**CHARACTERISTICS**

**Conditions** (unless otherwise specified)

D.C. supply voltage	$V_B$	24 V
External resistor ( $R_X$ ) and oscillator coil Device embedded in brass tube	see operating distance table below	
Substrate temperature	$T_s$	25 °C

**Performances**

Supply current			
output stage "ON"		typ.	9,0 mA
output stage "OFF"	$I_B$	typ.	7,7 mA
Voltage drop			
$I_o = 250$ mA	$V_d$	max.	1 V
$I_o = 10$ mA		max.	0,25 V

Operating (switching) distance\*

type	oscillator coil number of turns		average operating distance S in mm at $R_X$ ( $\Omega$ )			recommended potcore	oscillator frequency kHz
	N1	N2	200	250	300		
M8	32	16	1	1,5	—	$\phi$ 5,8 mm (Neosid)	800
M12	40	10	2	3	—	P9 Philips**	600
M18	46	4	3	4	5	P14 Philips**	600

Differential travel (in % of S)	H	3 to 10 %
Operating frequency (according to EN 50010)	f	< 5 kHz

\* The operating distance S depends on the oscillator coil, the material of the metal actuator and  $R_X$ . For measuring purposes a square steel sheet (St 37) with dimensions such that a circle with the diameter of the core can be inscribed, and 1 mm thickness can be used.  $R_X$  must not be chosen outside the range of 200 to 300  $\Omega$ . Influence of supply voltage: -1  $\mu$ m/V for  $V_B = 15$  to 30 V.

Temperature coefficient of S:

- M8 : 0,2 %/K
- M12: 0,17 %/K
- M18: 0,1 %/K

\*\* Grade 3B7/3H1.

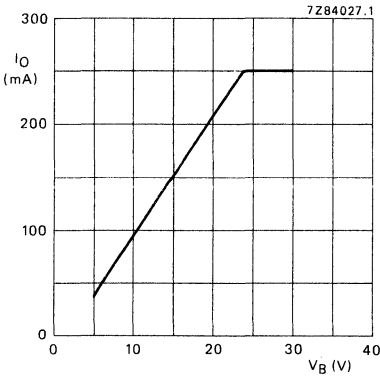

Fig. 4 Maximum allowable output current as a function of supply voltage; T<sub>S</sub> = 25 °C.

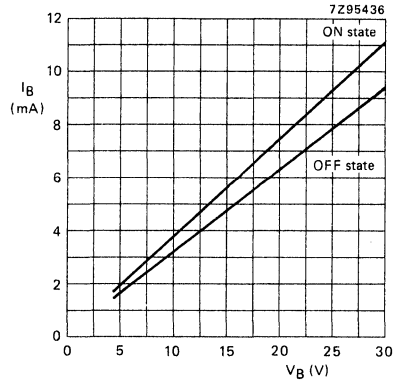

Fig. 5 Supply current as a function of supply voltage; T<sub>S</sub> = 25 °C; typical values.

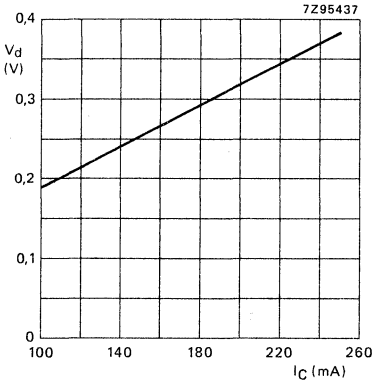

Fig. 6 Voltage drop as a function of output current; V<sub>B</sub> = 24 V; T<sub>S</sub> = 25 °C; typical values.

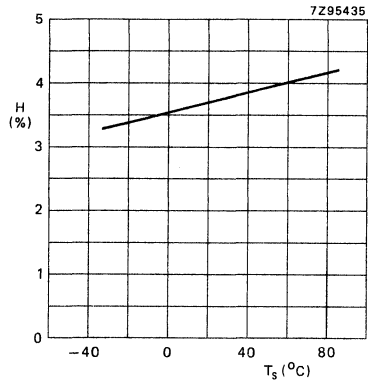
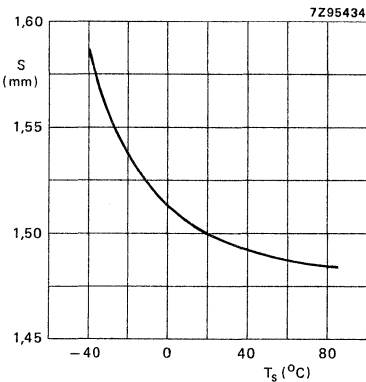

Fig. 7 Hysteresis as a function of substrate temperature; typical values.



Potcore φ 5,8 mm Neosid  
osc. coil N1 = 32, N2 = 16 turns  
R<sub>X</sub> = 200 Ω.

Fig. 8 Operating distance as a function of substrate temperature.

### MOUNTING RECOMMENDATIONS

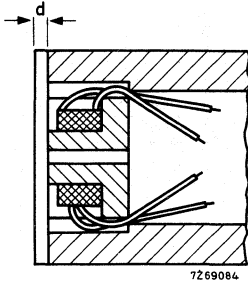

If a protective cap is incorporated, it should be as thin as possible, because its thickness  $d$  forms part of the operating distance  $S$ .

A brass stud wall should not extend beyond the potcore. The exact value of  $S$  with its spread is determined by a number of variables, e.g.

- value of the adjustment resistor  $R_x$
- the oscillator coil
- the metal of the actuator
- the material and shape of the housing.

Fig. 9 Insertion of potcore in brass tube.

#### Soldering recommendations

Use normal 60/40 solder; use a soldering iron with a fine point; soldering time as short as possible and it should not exceed 2,5 s per soldering point ( $T_{SID} = \text{max. } 250 \text{ } ^\circ\text{C}$ ).

The substrate is preferably preheated to a temperature of  $100 \text{ } ^\circ\text{C}$  with a minimum of  $80 \text{ } ^\circ\text{C}$  and a maximum of  $125 \text{ } ^\circ\text{C}$ .

#### Potting recommendations

First cover the hybrid IC with about 0,5 mm of silicone rubber, let it harden and, with the parts inserted in the tube, fill up the tube with an epoxy.

## HYBRID INTEGRATED CIRCUITS FOR INDUCTIVE PROXIMITY DETECTORS

Hybrid integrated circuits intended for inductive proximity detectors in tubular construction, especially the M8 hollow stud. The OM386B is for positive supply voltage and the OM387B is for negative supply voltage. The circuit consists of a voltage regulator, an oscillator, a rectifier stage, a Schmitt trigger, an output stage and a protection circuit.

The circuit performs a make function: when actuated the current flows through the load, which can be e.g. the coil of an electromagnetic relay, a LED or a photocoupler.

### Features:

- protection against short-circuit and overload
- protection of output transistor against transients by a voltage regulator diode
- protection against false polarity of the three connection leads
- choice between two methods to adjust the operating (switching) distance i.e. trimming a resistor integrated on the substrate or mounting a resistor
- possibility of connecting a LED for function control

The devices are thin-film circuits deposited on ceramic substrates. They may be potted, together with the oscillator coil, in a non-magnetic tube.

### QUICK REFERENCE DATA

D.C. supply voltage range	$V_B$	10 to 30 V
Output current at $V_B = 10$ to 30 V	$I_o$	max. 250 mA
Operating (switching) distance (depends on $R_x$ value and oscillator coil)	S	1 to 5 mm
Differential travel (hysteresis in switching distance)	H	3 to 10 %
Operating (switching) frequency	f	< 5 kHz
Operating substrate temperature range*	$T_s$	-40 to +85 °C
Substrate length	L	43,4 ± 0,2 mm
Substrate width	W	4,8 ± 0,2 mm
Height of circuit including substrate	h	max. 1,7 mm

### MECHANICAL DATA

Dimensions in mm

Fig. 1 (see next page).

\* The tube, potting and connection materials are the main limiting factors for the operating temperature range of a completely assembled proximity detector.

OM386B  
OM387B

MECHANICAL DATA (outline and connections)

Dimensions in mm

Fig. 1.

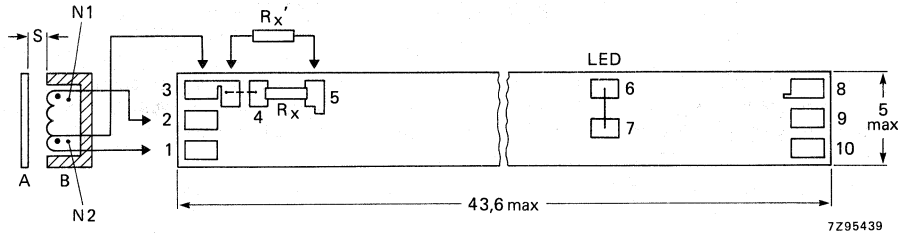

A = metal actuator; B = open potcore or potcore half with coil.

Mechanical outline and connections: note that the supply polarities to points 8 and 10 are given for the OM386B; for the OM387B the polarities are point 8:  $-V_B$ , and point 10:  $+V_B$ .

S is the operating distance.

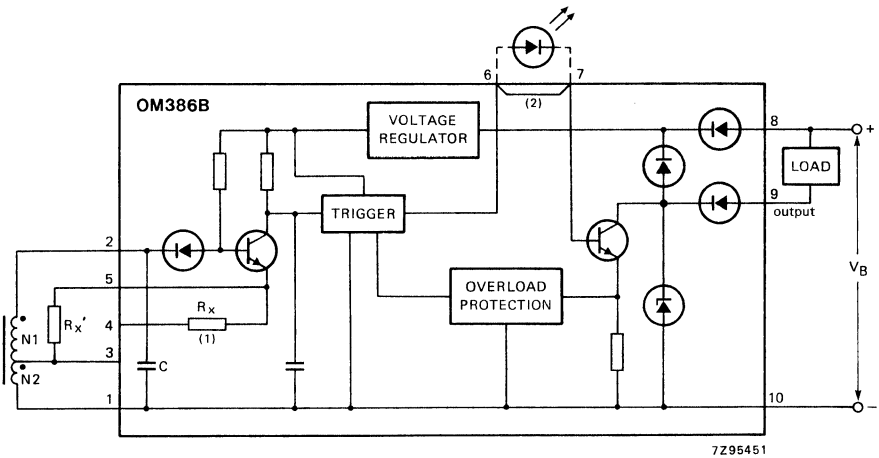

Fig. 2 Circuit diagram of OM386B.

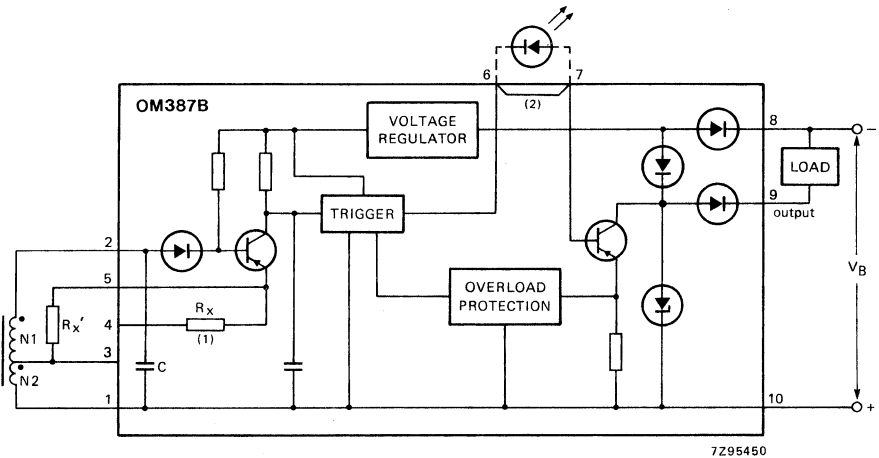

Fig. 3 Circuit diagram of OM387B.

- (1)  $R_x$  is integrated on the substrate and suitable for trimming (laser or sandblasting). To use integrated resistance  $R_x$  it is necessary to connect point 3 to 4.
- (2) If a LED is to be connected, the jumper between points 6 and 7 should be removed.



**RATINGS**

Limiting values in accordance with the Absolute Maximum System (IEC 134)

D.C. supply voltage	$V_B$	max.	30 V
Output current	$I_O$	max.	250 mA
Storage temperature	$T_{stg}$		-40 to +125 °C
Operating substrate temperature	$T_s$		-40 to +85 °C

**CHARACTERISTICS**

**Conditions** (unless otherwise specified)

D.C. supply voltage	$V_B$		24 V
External resistor ( $R_X$ ) and oscillator coil Device embedded in brass tube		see operating distance table below	
Substrate temperature	$T_s$		25 °C

**Performances**

Supply current			
output stage "ON"		typ.	8,4 mA
output stage "OFF"	$I_B$	typ.	4,8 mA
Voltage drop			
$I_O = 250$ mA	$V_d$	max.	1,9 V
$I_O = 10$ mA		max.	1,0 V

Operating (switching) distance\*

type	oscillator coil number of turns		average operating distance S in mm at $R_X$ ( $\Omega$ )			recommended potcore	oscillator frequency kHz
	N1	N2	200	250	300		
M8	32	16	1	1,5	—	$\phi$ 5,8 mm (Neosid)	800
M12	40	10	2	3	—	P9 Philips**	600
M18	46	4	3	4	5	P14 Philips**	600

Differential travel (in % of S)	H		3 to 10 %
Operating frequency (according to EN 50010)	f	<	5 kHz

\* The operating distance S depends on the oscillator coil, the material of the metal actuator and  $R_X$ . For measuring purposes a square steel sheet (St 37) with dimensions such that a circle with the diameter of the core can be inscribed, and 1 mm thickness can be used.  $R_X$  must not be chosen outside the range of 200 to 300  $\Omega$ .

\*\* Grade 3B7/3H1.

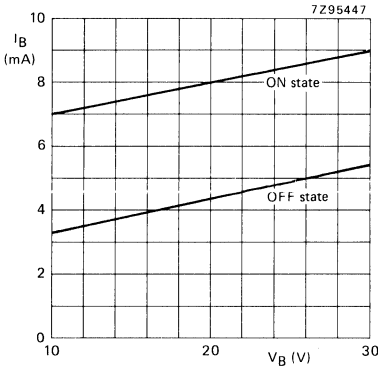

Fig. 4 Supply current as a function of supply voltage;  $T_S = 25\text{ }^\circ\text{C}$ .

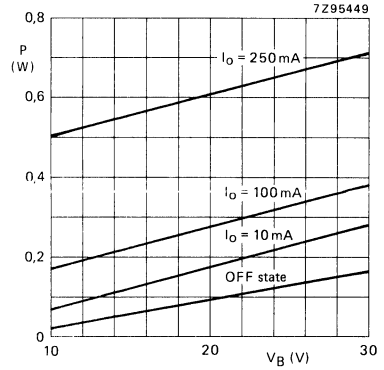

Fig. 5 Power dissipation as a function of supply voltage.

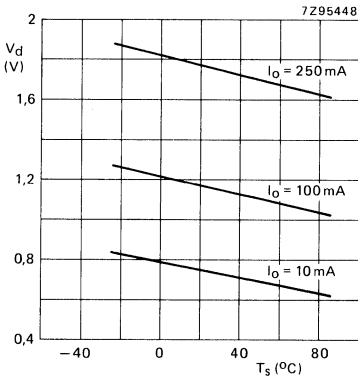

Fig. 6 Voltage drop as a function of substrate temperature.

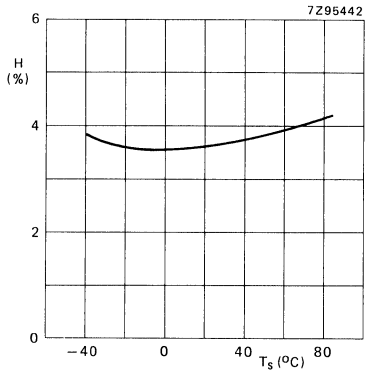
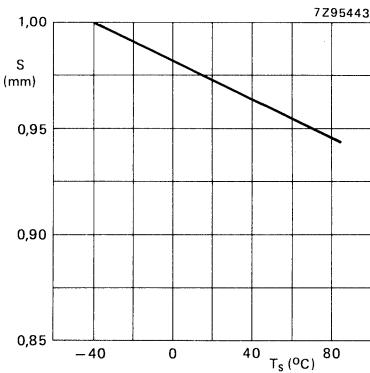

Fig. 7 Hysteresis as a function of substrate temperature.



Conditions relating to Figs 7 and 8:  
 potcore  $\phi$  5,8 mm Neosid  
 osc. coil  $N_1 = 32$ ,  $N_2 = 16$  turns  
 $R_X = 200\ \Omega$ .

Fig. 8 Operating distance as a function of substrate temperature.

### MOUNTING RECOMMENDATIONS

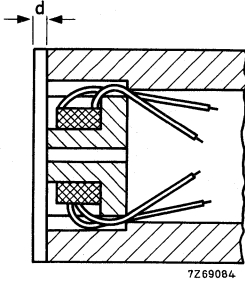

If a protective cap is incorporated, it should be as thin as possible, because its thickness  $d$  forms part of the operating distance  $S$ .

A brass stud wall should not extend beyond the potcore. The exact value of  $S$  with its spread is determined by a number of variables, e.g.

- value of the adjustment resistor  $R_x$
- the oscillator coil
- the metal of the actuator
- the material and shape of the housing.

Fig. 9 Insertion of potcore in brass tube.

#### Soldering recommendations

Use normal 60/40 solder; use a soldering iron with a fine point; soldering time as short as possible and it should not exceed 2,5 s per soldering point ( $T_{sld} = \text{max. } 250 \text{ }^\circ\text{C}$ ).

The substrate is preferably preheated to a temperature of  $100 \text{ }^\circ\text{C}$  with a minimum of  $80 \text{ }^\circ\text{C}$  and a maximum of  $125 \text{ }^\circ\text{C}$ .

#### Potting recommendations

First cover the hybrid IC with about 0,5 mm of silicone rubber, let it harden and with the parts inserted in the tube, fill up the tube with an epoxy.

## HYBRID INTEGRATED CIRCUITS FOR INDUCTIVE PROXIMITY DETECTORS

Hybrid integrated circuits intended for inductive proximity detectors in tubular construction, especially the M8 hollow stud. The OM386M is for positive supply voltage and the OM387M is for negative supply voltage. The circuit consists of a voltage regulator, an oscillator, a rectifier stage, a Schmitt trigger, an output stage and a protection circuit.

The circuit performs a make function: when actuated the current flows through the load, which can be e.g. the coil of an electromagnetic relay, a LED or a photocoupler.

Compared to the types OM386B/OM387B the substrate length is drastically reduced.

### Features:

- extra-small dimensions
- protection against short-circuit and overload
- protection of output transistor against transients by a voltage regulator diode
- protection against false polarity of the three connection leads
- choice between two methods to adjust the operating (switching) distance i.e. trimming a resistor integrated on the substrate or mounting a resistor
- possibility of connecting a LED for function control

The devices are thin-film circuits deposited on ceramic substrates. They may be potted, together with the oscillator coil, in a non-magnetic tube.

### QUICK REFERENCE DATA

D.C. supply voltage range	$V_B$	10 to 30 V
Output current at $V_B = 10$ to 30 V	$I_o$	max. 200 mA
Operating (switching) distance (depends on $R_x$ value and oscillator coil)	S	1 to 5 mm
Differential travel (hysteresis in switching distance)	H	3 to 10 %
Operating (switching) frequency	f	< 5 kHz
Operating substrate temperature range*	$T_s$	-40 to +85 °C
Substrate length after assembly	L	22,3 ± 0,2 mm
Substrate width	W	4,8 ± 0,2 mm
Thickness of assembled hybrid (two parts glued together back to back)	h	max. 3,8 mm

### MECHANICAL DATA

Dimensions in mm

Fig. 1 (see next page).

\* The tube, potting and connection materials are the main limiting factors for the operating temperature range of a completely assembled proximity detector.

MECHANICAL DATA (outline and connections)

Dimensions in mm

Fig. 1.

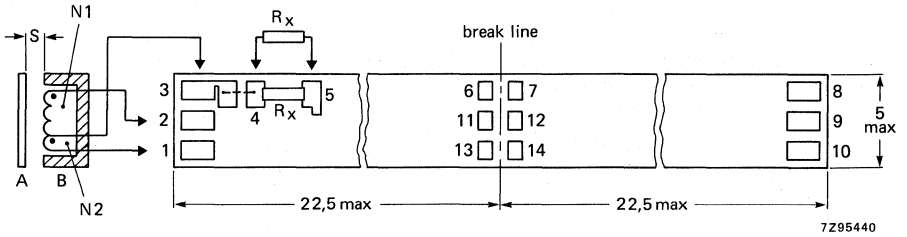

A = metal actuator; B = open potcore or potcore half with coil.

Mechanical outline and connections: note that the supply polarities to points 8 and 10 are given for the OM386M; for the OM387M the polarities are point 8:  $-V_B$ , and point 10:  $+V_B$ .

S is the operating distance.



**RATINGS**

Limiting values in accordance with the Absolute Maximum System (IEC 134)

D.C. supply voltage	$V_B$	max.	30 V
Output current	$I_O$	max.	200 mA
Storage temperature	$T_{stg}$		-40 to +125 °C
Operating substrate temperature	$T_s$		-40 to +85 °C

**CHARACTERISTICS**

**Conditions** (unless otherwise specified)

D.C. supply voltage	$V_B$		24 V
External resistor ( $R_X$ ) and oscillator coil		see operating distance table below	
Device embedded in brass tube			
Substrate temperature	$T_s$		25 °C

**Performances**

Supply current			
output stage "ON"		typ.	7,4 mA
output stage "OFF"	$I_B$	typ.	4,8 mA
Voltage drop			
$I_O = 200$ mA	$V_d$	max.	1,9 V
$I_O = 10$ mA		max.	1,0 V

Operating (switching) distance\*

type	oscillator coil number of turns		average operating distance S in mm at $R_X$ ( $\Omega$ )			recommended potcore	oscillator frequency kHz
	N1	N2	200	250	300		
M8	32	16	1	1,5	—	$\phi$ 5,8 mm (Neosid)	800
M12	40	10	2	3	—	P9 Philips**	600
M18	46	4	3	4	5	P14 Philips**	600

Differential travel (in % of S)	H		3 to 10 %
Operating frequency (according to EN 50010)	f	<	5 kHz

\* The operating distance S depends on the oscillator coil, the material of the metal actuator and  $R_X$ . For measuring purposes a square steel sheet (St. 37) with dimensions such that a circle with the diameter of the core can be inscribed, and 1 mm thickness can be used.  $R_X$  must not be chosen outside the range of 200 to 300  $\Omega$ .

\*\* Grade 3B7/3H1.

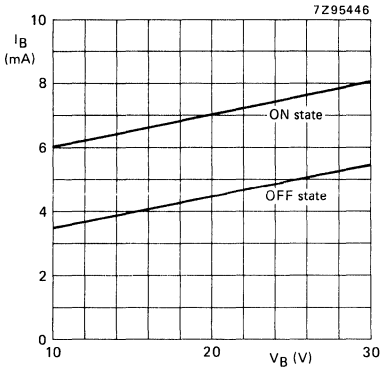

Fig. 4 Supply current as a function of supply voltage;  $T_s = 25^\circ\text{C}$ .

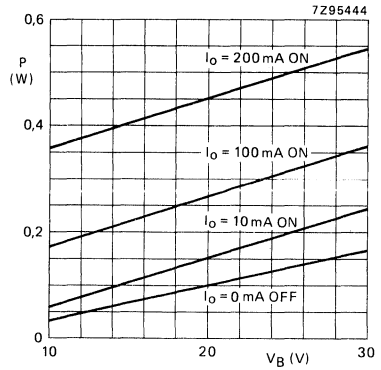

Fig. 5 Power dissipation as a function of supply voltage.

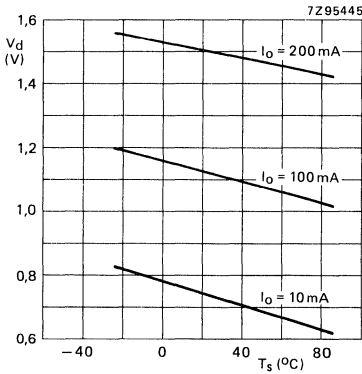

Fig. 6 Voltage drop as a function of substrate temperature.

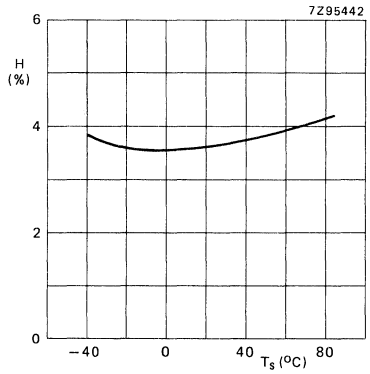
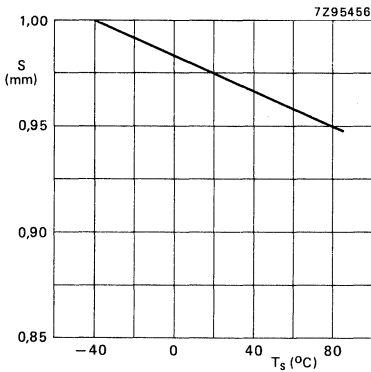

Fig. 7 Hysteresis as a function of substrate temperature.



Conditions relating to Figs 7 and 8:  
 potcore  $\phi$  5,8 mm Neosid  
 osc. coil  $N_1 = 32$ ,  $N_2 = 16$  turns  
 $R_x = 200 \Omega$ .

Fig. 8 Operating distance as a function of substrate temperature.



**MOUNTING RECOMMENDATIONS**

**A. Assembling and connecting the two half substrates:**

- Use the breakline to break the substrate in two pieces.
- Apply glue (e.g. epoxy Ablebond 293-1) to the blank sides of the two parts.
- After hardening of the glue connect the pads according to Fig. 9.

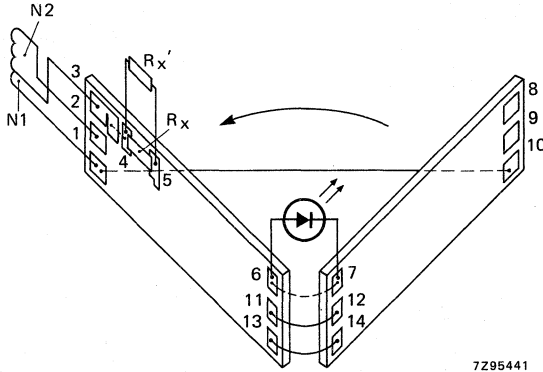

Fig. 9 If no LED is used, connect point 6 to point 7; connect points 11 and 12, point 13 to 14 and point 1 to point 10.

**B. If a protective cap is incorporated, it should be as thin as possible, because its thickness  $d$  forms part of the operating distance  $S$ .**

A brass stud wall should not extend beyond the potcore. The exact value of  $S$  with its spread is determined by a number of variables, e.g.

- value of the adjustment resistor  $R_x$
- the oscillator coil
- the metal of the actuator
- the material and shape of the housing.

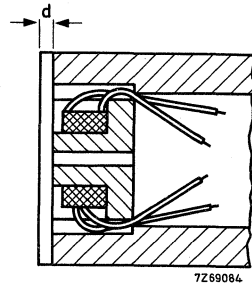

Fig. 10 Insertion of potcore in brass tube.

**Soldering recommendations**

Use normal 60/40 solder; use a soldering iron with a fine point; soldering time as short as possible and it should not exceed 2,5 s per soldering point ( $T_{sld} = \text{max. } 250 \text{ } ^\circ\text{C}$ ).

**Potting recommendations**

First cover the hybrid IC with about 0,5 mm of silicone rubber, let it harden and with the parts inserted in the tube, fill up the tube with an epoxy.

## HYBRID INTEGRATED CIRCUITS FOR INDUCTIVE PROXIMITY DETECTORS

Hybrid integrated circuits intended for inductive proximity detectors in tubular construction, especially the M12 hollow stud. The OM388B is for positive supply voltage and the OM389B is for negative supply voltage. The circuit consists of a voltage regulator, an oscillator, a rectifier stage, a Schmitt trigger, an output stage and a protection circuit.

The circuit performs a make function: when actuated the current flows through the load, which can be e.g. the coil of an electromagnetic relay, a LED or a photocoupler.

### Features:

- protection against short-circuit and overload
- protection of output transistor against transients by a voltage regulator diode
- protection against false polarity of the three connection leads
- choice between two methods to adjust the operating (switching) distance i.e. trimming a resistor integrated on the substrate or mounting a resistor
- possibility of connecting a LED for function control

The devices are thin-film circuits deposited on ceramic substrates. They may be potted, together with the oscillator coil, in a non-magnetic tube.

### QUICK REFERENCE DATA

D.C. supply voltage range	$V_B$	10 to 30 V
Output current at $V_B = 10$ to 30 V	$I_o$	max. 250 mA
Operating (switching) distance (depends on $R_x$ value and oscillator coil)	S	2 to 5 mm
Differential travel (hysteresis in switching distance)	H	3 to 10 %
Operating (switching) frequency	f	< 5 kHz
Operating substrate temperature range*	$T_s$	-40 to +85 °C
Substrate length	L	25,4 ±0,2 mm
Substrate width	W	8,0 ±0,2 mm
Height of circuit including substrate	h	max. 1,7 mm

### MECHANICAL DATA

Dimensions in mm

Fig. 1 (see next page).

\* The tube, potting and connection materials are the main limiting factors for the operating temperature range of a completely assembled proximity detector.

OM388B  
OM389B

MECHANICAL DATA (outline and connections).

Dimensions in mm

Fig. 1.

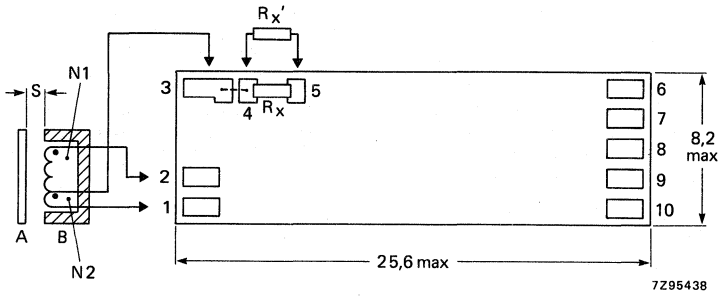

A = metal actuator; B = open potcore or potcore half with coil.

Mechanical outline and connections: note that the supply polarities to points 8 and 10 are given for the OM388B; for the OM389B the polarities are point 8:  $-V_B$  and point 10:  $+V_B$ .

S is the operating distance.

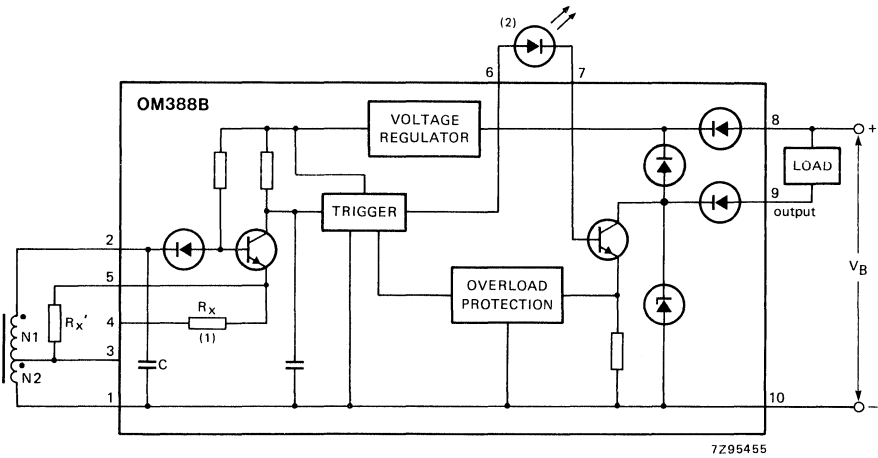

Fig. 2 Circuit diagram of OM388B.

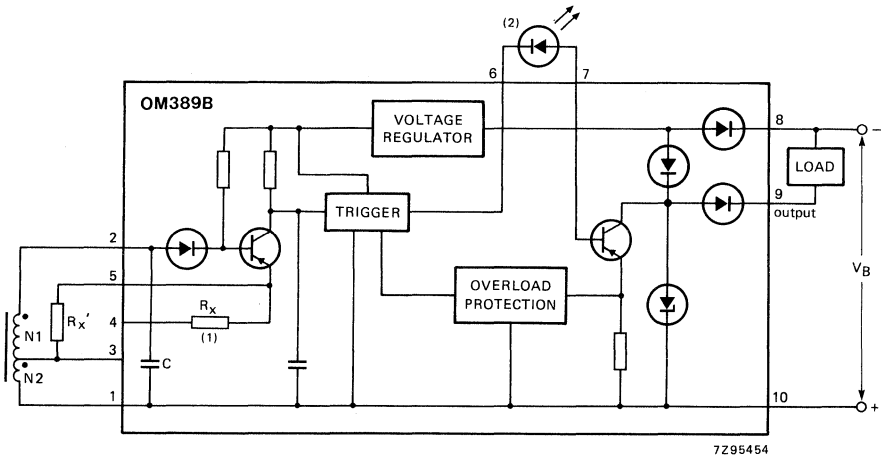

Fig. 3 Circuit diagram of OM389B.

- (1)  $R_x$  is integrated on the substrate and suitable for trimming (laser or sandblasting). To use integrated resistance  $R_x$  it is necessary to connect point 3 to 4.
- (2) If no LED is used, point 6 is to be connected to point 7.

**RATINGS**

Limiting values in accordance with the Absolute Maximum System (IEC 134)

D.C. supply voltage	$V_B$	max.	30 V
Output current	$I_O$	max.	250 mA
Storage temperature	$T_{stg}$		-40 to +125 °C
Operating substrate temperature	$T_s$		-40 to +85 °C

**CHARACTERISTICS**

**Conditions** (unless otherwise specified)

D.C. supply voltage	$V_B$	24 V
External resistor ( $R_X$ ) and oscillator coil Device embedded in brass tube	see operating distance table below	
Substrate temperature	$T_s$	25 °C

**Performances**

Supply current			
output stage "ON"		typ.	8,4 mA
output stage "OFF"	$I_B$	typ.	4,8 mA
Voltage drop			
$I_O = 250$ mA	$V_d$	max.	1,9 V
$I_O = 10$ mA		max.	1,0 V

Operating (switching) distance\*

type	oscillator coil number of turns		average operating distance S in mm at $R_X$ ( $\Omega$ )			recommended potcore	oscillator frequency kHz
	N1	N2	200	250	300		
M12	40	10	2	3	—	P9 Philips**	600
M18	46	4	3	4	5	P14 Philips**	600

Differential travel (in % of S)	H	3 to 10 %
Operating frequency (according to EN 50010)	f	< 5 kHz

\* The operating distance S depends on the oscillator coil, the material of the metal actuator and  $R_X$ . For measuring purposes a square steel sheet (St 37) with dimensions such that a circle with the diameter of the core can be inscribed, and 1 mm thickness can be used.  $R_X$  must not be chosen outside the range of 200 to 300  $\Omega$ .

\*\* Grade 3B7/3H1.

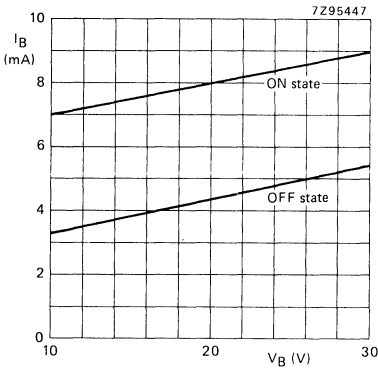

Fig. 4 Supply current as a function of supply voltage;  $T_S = 25^\circ\text{C}$ .

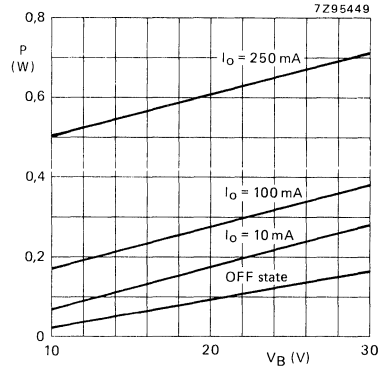

Fig. 5 Power dissipation as a function of supply voltage.

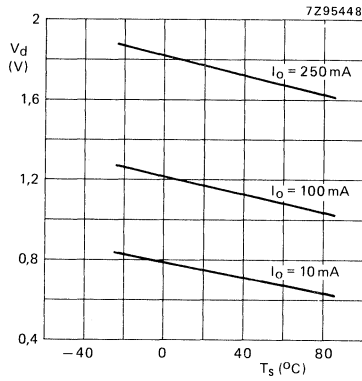

Fig. 6 Voltage drop as a function of substrate temperature.

### MOUNTING RECOMMENDATIONS

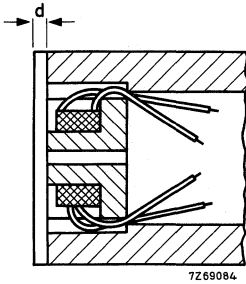

Fig. 7 Insertion of potcore in brass tube.

#### Soldering recommendations

Use normal 60/40 solder; use a soldering iron with a fine point; soldering time as short as possible and it should not exceed 2,5 s per soldering point ( $T_{sld} = \text{max. } 250 \text{ }^\circ\text{C}$ ).

The substrate is preferably preheated to a temperature of  $100 \text{ }^\circ\text{C}$  with a minimum of  $80 \text{ }^\circ\text{C}$  and a maximum of  $125 \text{ }^\circ\text{C}$ .

#### Potting recommendations

First cover the hybrid IC with about 0,5 mm of silicone rubber, let it harden and with the parts inserted in the tube, fill up the tube with an epoxy.

If a protective cap is incorporated, it should be as thin as possible, because its thickness  $d$  forms part of the operating distance  $S$ .

A brass stud wall should not extend beyond the potcore. The exact value of  $S$  with its spread is determined by a number of variables, e.g.

- value of the adjustment resistor  $R_x$
- the oscillator coil
- the metal of the actuator
- the material and shape of the housing.

## INDEX OF TYPE NUMBERS

The inclusion of a type number in this publication does not necessarily imply its availability.

type no.	book	section	type no.	book	section	type no.	book	section
BA220	S1	SD	BAS29	S7/S1	Mm/SD	BAV101	S7/S1	Mm/SD
BA221	S1	SD	BAS31	S7/S1	Mm/SD	BAV102	S7/S1	Mm/SD
BA223	S1	T	BAS32	S7/S1	Mm/SD	BAV103	S7/S1	Mm/SD
BA281	S1	SD	BAS35	S7/S1	Mm/SD	BAW56	S7/S1	Mm/SD
BA314	S1	Vrg	BAS45	S1	SD	BAW62	S1	SD
BA315	S1	Vrg	BAS56	S1	SD	BAX12	S1	SD
BA316	S1	SD	BAT17	S7/S1	Mm/T	BAX14	S1	SD
BA317	S1	SD	BAT18	S7/S1	Mm/T	BAX18	S1	SD
BA318	S1	SD	BAT54	S1	SD	BAY80	S1	SD
BA423	S1	T	BAT74	S1	SD	BB112	S1	T
BA480	S1	T	BAT81	S1	T	BB119	S1	T
BA481	S1	T	BAT82	S1	T	BB130	S1	T
BA482	S1	T	BAT83	S1	T	BB204B	S1	T
BA483	S1	T	BAT85	S1	T	BB204G	S1	T
BA484	S1	T	BAT86	S1	T	BB212	S1	T
BA682	S1	T	BAV10	S1	SD	BB405B	S1	T
BA683	S1	T	BAV18	S1	SD	BB417	S1	T
BAS11	S1	SD	BAV19	S1	SD	BB809	S1	T
BAS15	S1	SD	BAV20	S1	SD	BB909A	S1	T
BAS16	S7/S1	Mm/SD	BAV21	S1	SD	BB909B	S1	T
BAS17	S7/S1	Mm/Vrg	BAV23	S7/S1	Mm/SD	BBY31	S7/S1	Mm/T
BAS19	S7/S1	Mm/SD	BAV45	S1	Sp	BBY40	S7/S1	Mm/T
BAS20	S7/S1	Mm/SD	BAV70	S7/S1	Mm/SD	BC107	S3	Sm
BAS21	S7/S1	Mm/SD	BAV99	S7/S1	Mm/SD	BC108	S3	Sm
BAS28	S7/S1	Mm/SD	BAV100	S7/S1	Mm/SD	BC109	S3	Sm

Mm = Microminiature semiconductors  
for hybrid circuits

SD = Small-signal diodes

Sp = Special diodes

T = Tuner diodes

Vrg = Voltage regulator diodes

Sm = Small-signal transistors



# INDEX

type no.	book	section	type no.	book	section	type no.	book	section
BC140	S3	Sm	BC818	S7	Mm	BCX51	S7	Mm
BC141	S3	Sm	BC846	S7	Mm	BCX52	S7	Mm
BC146	S3	Sm	BC847	S7	Mm	BCX53	S7	Mm
BC160	S3	Sm	BC848	S7	Mm	BCX54	S7	Mm
BC161	S3	Sm	BC849	S7	Mm	BCX55	S7	Mm
BC177	S3	Sm	BC850	S7	Mm	BCX56	S7	Mm
BC178	S3	Sm	BC856	S7	Mm	BCX68	S7	Mm
BC179	S3	Sm	BC857	S7	Mm	BCX69	S7	mm
BC200	S3	Sm	BC858	S7	Mm	BCX70*	S7	Mm
BC264A	S5	FET	BC859	S7	Mm	BCX71*	S7	Mm
BC264B	S5	FET	BC860	S7	Mm	BCY56	S3	Sm
BC264C	S5	FET	BC868	S7	Mm	BCY57	S3	Sm
BC264D	S5	FET	BC869	S7	Mm	BCY58	S3	Sm
BC327;A	S3	Sm	BCF29;R	S7	Mm	BCY59	S3	Sm
BC328	S3	Sm	BCF30;R	S7	Mm	BCY70	S3	Sm
BC337;A	S3	Sm	BCF32;R	S7	Mm	BCY71	S3	Sm
BC338	S3	Sm	BCF33;R	S7	Mm	BCY72	S3	Sm
BC368	S3	Sm	BCF70;R	S7	Mm	BCY78	S3	Sm
BC369	S3	Sm	BCF81;R	S7	Mm	BCY79	S3	Sm
BC375	S3	Sm	BCV61	S7	Mm	BCY87	S3	Sm
BC376	S3	Sm	BCV62	S7	Mm	BCY88	S3	Sm
BC546	S3	Sm	BCV71;R	S7	Mm	BCY89	S3	Sm
BC547	S3	Sm	BCV72;R	S7	Mm	BD131	S4a	P
BC548	S3	Sm	BCW29;R	S7	Mm	BD132	S4a	P
BC549	S3	Sm	BCW30;R	S7	Mm	BD135	S4a	P
BC550	S3	Sm	BCW31;R	S7	Mm	BD136	S4a	P
BC556	S3	Sm	BCW32;R	S7	Mm	BD137	S4a	P
BC557	S3	Sm	BCW33;R	S7	Mm	BD138	S4a	P
BC558	S3	Sm	BCW60*	S7	Mm	BD139	S4a	P
BC559	S3	Sm	BCW61*	S7	Mm	BD140	S4a	P
BC560	S3	Sm	BCW69;R	S7	Mm	BD201	S4a	P
BC635	S3	Sm	BCW70;R	S7	Mm	BD202	S4a	P
BC636	S3	Sm	BCW71;R	S7	Mm	BD203	S4a	P
BC637	S3	Sm	BCW72;R	S7	Mm	BD204	S4a	P
BC638	S3	Sm	BCW81;R	S7	Mm	BD226	S4a	P
BC639	S3	Sm	BCW89;R	S7	Mm	BD227	S4a	P
BC640	S3	Sm	BCX17;R	S7	Mm	BD228	S4a	P
BC807	S7	Mm	BCX18;R	S7	Mm	BD229	S4a	P
BC808	S7	Mm	BCX19;R	S7	Mm	BD230	S4a	P
BC817	S7	Mm	BCX20;R	S7	Mm	BD231	S4a	P

\* = series

FET = Field-effect transistors

Mm = Microminiature semiconductors  
for hybrid circuits

P = Low-frequency power transistors

Sm = Small-signal transistors

type no.	book	section	type no.	book	section	type no.	book	section
BD233	S4a	P	BD433	S4a	P	BD843	S4a	P
BD234	S4a	P	BD434	S4a	P	BD844	S4a	P
BD235	S4a	P	BD435	S4a	P	BD845	S4a	P
BD236	S4a	P	BD436	S4a	P	BD846	S4a	P
BD237	S4a	P	BD437	S4a	P	BD847	S4a	P
BD238	S4a	P	BD438	S4a	P	BD848	S4a	P
BD239	S4a	P	BD645	S4a	P	BD849	S4a	P
BD239A	S4a	P	BD646	S4a	P	BD850	S4a	P
BD239B	S4a	P	BD647	S4a	P	BD933	S4a	P
BD239C	S4a	P	BD648	S4a	P	BD934	S4a	P
BD240	S4a	P	BD649	S4a	P	BD935	S4a	P
BD240A	S4a	P	BD650	S4a	P	BD936	S4a	P
BD240B	S4a	P	BD651	S4a	P	BD937	S4a	P
BD240C	S4a	P	BD652	S4a	P	BD938	S4a	P
BD241	S4a	P	BD675	S4a	P	BD939	S4a	P
BD241A	S4a	P	BD676	S4a	P	BD940	S4a	P
BD241B	S4a	P	BD677	S4a	P	BD941	S4a	P
BD241C	S4a	P	BD678	S4a	P	BD942	S4a	P
BD242	S4a	P	BD679	S4a	P	BD943	S4a	P
BD242A	S4a	P	BD680	S4a	P	BD944	S4a	P
BD242B	S4a	P	BD681	S4a	P	BD945	S4a	P
BD242C	S4a	P	BD682	S4a	P	BD946	S4a	P
BD243	S4a	P	BD683	S4a	P	BD947	S4a	P
BD243A	S4a	P	BD684	S4a	P	BD948	S4a	P
BD243B	S4a	P	BD813	S4a	P	BD949	S4a	P
BD243C	S4a	P	BD814	S4a	P	BD950	S4a	P
BD244	S4a	P	BD815	S4a	P	BD951	S4a	P
BD244A	S4a	P	BD816	S4a	P	BD952	S4a	P
BD244B	S4a	P	BD817	S4a	P	BD953	S4a	P
BD244C	S4a	P	BD818	S4a	P	BD954	S4a	P
BD329	S4a	P	BD825	S4a	P	BD955	S4a	P
BD330	S4a	P	BD826	S4a	P	BD956	S4a	P
BD331	S4a	P	BD827	S4a	P	BDT20	S4a	P
BD332	S4a	P	BD828	S4a	P	BDT21	S4a	P
BD333	S4a	P	BD829	S4a	P	BDT29	S4a	P
BD334	S4a	P	BD830	S4a	P	BDT29A	S4a	P
BD335	S4a	P	BD839	S4a	P	BDT29B	S4a	P
BD336	S4a	P	BD840	S4a	P	BDT29C	S4a	P
BD337	S4a	P	BD841	S4a	P	BDT30	S4a	P
BD338	S4a	P	BD842	S4a	P	BDT30A	S4a	P

P = Low-frequency power transistors

# INDEX

type no.	book	section	type no.	book	section	type no.	book	section
BDT30B	S4a	P	BDT63B	S4a	P	BDV91	S4a	P
BDT30C	S4a	P	BDT63C	S4a	P	BDV92	S4a	P
BDT31	S4a	P	BDT64	S4a	P	BDV93	S4a	P
BDT31A	S4a	P	BDT64A	S4a	P	BDV94	S4a	P
BDT31B	S4a	P	BDT64B	S4a	P	BDV95	S4a	P
BDT31C	S4a	P	BDT64C	S4a	P	BDV96	S4a	P
BDT32	S4a	P	BDT65	S4a	P	BDW55	S4a	P
BDT32A	S4a	P	BDT65A	S4a	P	BDW56	S4a	P
BDT32B	S4a	P	BDT65B	S4a	P	BDW57	S4a	P
BDT32C	S4a	P	BDT65C	S4a	P	BDW58	S4a	P
BDT41	S4a	P	BDT81	S4a	P	BDW59	S4a	P
BDT41A	S4a	P	BDT82	S4a	P	BDW60	S4a	P
BDT41B	S4a	P	BDT83	S4a	P	BDX35	S4a	P
BDT41C	S4a	P	BDT84	S4a	P	BDX36	S4a	P
BDT42	S4a	P	BDT85	S4a	P	BDX37	S4a	P
BDT42A	S4a	P	BDT86	S4a	P	BDX42	S4a	P
BDT42B	S4a	P	BDT87	S4a	P	BDX43	S4a	P
BDT42C	S4a	P	BDT88	S4a	P	BDX44	S4a	P
BDT51	S4a	P	BDT91	S4a	P	BDX45	S4a	P
BDT52	S4a	P	BDT92	S4a	P	BDX46	S4a	P
BDT53	S4a	P	BDT93	S4a	P	BDX47	S4a	P
BDT54	S4a	P	BDT94	S4a	P	BDX62	S4a	P
BDT55	S4a	P	BDT95	S4a	P	BDX62A	S4a	P
BDT56	S4a	P	BDT96	S4a	P	BDX62B	S4a	P
BDT57	S4a	P	BDV64	S4a	P	BDX62C	S4a	P
BDT58	S4a	P	BDV64A	S4a	P	BDX63	S4a	P
BDT60	S4a	P	BDV64B	S4a	P	BDX63A	S4a	P
BDT60A	S4a	P	BDV64C	S4a	P	BDX63B	S4a	P
BDT60B	S4a	P	BDV65	S4a	P	BDX63C	S4a	P
BDT60C	S4a	P	BDV65A	S4a	P	BDX64	S4a	P
BDT61	S4a	P	BDV65B	S4a	P	BDX64A	S4a	P
BDT61A	S4a	P	BDV65C	S4a	P	BDX64B	S4a	P
BDT61B	S4a	P	BDV66A	S4a	P	BDX64C	S4a	P
BDT61C	S4a	P	BDV66B	S4a	P	BDX65	S4a	P
BDT62	S4a	P	BDV66C	S4a	P	BDX65A	S4a	P
BDT62A	S4a	P	BDV66D	S4a	P	BDX65B	S4a	P
BDT62B	S4a	P	BDV67A	S4a	P	BDX65C	S4a	P
BDT62C	S4a	P	BDV67B	S4a	P	BDX66	S4a	P
BDT63	S4a	P	BDV67C	S4a	P	BDX66A	S4a	P
BDT63A	S4a	P	BDV67D	S4a	P	BDX66B	S4a	P

P = Low-frequency power transistors

type no.	book	section	type no.	book	section	type no.	book	section
BDX66C	S4a	P	BF410A	S5	FET	BF623	S7	Mm
BDX67	S4a	P	BF410B	S5	FET	BF660;R	S7	Mm
BDX67A	S4a	P	BF410C	S5	FET	BF689K	S10	WBT
BDX67B	S4a	P	BF410D	S5	FET	BF763	S10	WBT
BDX67C	S4a	P	BF419	S4b	HVP	BF767	S7	Mm
BDX68	S4a	P	BF420	S3	Sm	BF819	S4b	HVP
BDX68A	S4a	P	BF421	S3	Sm	BF820	S7	Mm
BDX68B	S4a	P	BF422	S3	Sm	BF821	S7	Mm
BDX68C	S4a	P	BF423	S3	Sm	BF822	S7	Mm
BDX69	S4a	P	BF450	S3	Sm	BF823	S7	Mm
BDX69A	S4a	P	BF451	S3	Sm	BF824	S7	Mm
BDX69B	S4a	P	BF457	S4b	HVP	BF857	S4b	HVP
BDX69C	S4a	P	BF458	S4b	HVP	BF858	S4b	HVP
BDX77	S4a	P	BF459	S4b	HVP	BF859	S4b	HVP
BDX78	S4a	P	BF469	S4b	HVP	BF869	S4b	HVP
BDX91	S4a	P	BF470	S4b	HVP	BF870	S4b	HVP
BDX92	S4a	P	BF471	S4b	HVP	BF871	S4b	HVP
BDX93	S4a	P	BF472	S4b	HVP	BF872	S4b	HVP
BDX94	S4a	P	BF483	S3	Sm	BF926	S3	Sm
BDX95	S4a	P	BF485	S3	Sm	BF936	S3	Sm
BDX96	S4a	P	BF487	S3	Sm	BF939	S3	Sm
BDY90	S4a	P	BF494	S3	Sm	BF960	S5	FET
BDY90A	S4a	P	BF495	S3	Sm	BF964	S5	FET
BDY91	S4a	P	BF496	S3	Sm	BF966	S5	FET
BDY92	S4a	P	BF510	S7/S5	Mm/FET	BF967	S3	Sm
BF198	S3	Sm	BF511	S7/S5	Mm/FET	BF970	S3	Sm
BF199	S3	Sm	BF512	S7/S5	Mm/FET	BF979	S3	Sm
BF240	S3	Sm	BF513	S7/S5	Mm/FET	BF980	S5	FET
BF241	S3	Sm	BF536	S7	Mm	BF981	S5	FET
BF245A	S5	FET	BF550;R	S7	Mm	BF982	S5	FET
BF245B	S5	FET	BF569	S7	Mm	BF989	S7/S5	Mm/FET
BF245C	S5	FET	BF579	S7	Mm	BF990	S7/S5	Mm/FET
BF247A	S5	FET	BF583	S4b	HVP	BF991	S7/S5	Mm/FET
BF247B	S5	FET	BF585	S4b	HVP	BF992	S7/S5	Mm/FET
BF247C	S5	FET	BF587	S4b	HVP	BF994	S7/S5	Mm/FET
BF256A	S5	FET	BF591	S4b	HVP	BF996	S7/S5	Mm/FET
BF256B	S5	FET	BF593	S4b	HVP	BFG23	S10	WBT
BF256C	S5	FET	BF620	S7	Mm	BFG32	S10	WBT
BF324	S3	Sm	BF621	S7	Mm	BFG34	S10	WBT
BF370	S3	Sm	BF622	S7	Mm	BFG51	S10	WBT

FET = Field-effect transistors  
 HVP = High-voltage power transistors  
 Mm = Microminiature semiconductors  
 for hybrid circuits

P = Low-frequency power transistors  
 Sm = Small-signal transistors  
 WBT = Wideband hybrid IC transistors

# INDEX

type no.	book	section	type no.	book	section	type no.	book	section
BFG65	S10	WBT	BFR31	S5/S7	FET/Mm	BFW17A	S10	WBT
BFG90A	S10	WBT	BFR49	S10	WBT	BFW30	S10	WBT
BFQ91A	S10	WBT	BFR53;R	S7	Mm	BFW61	S5	FET
BFQ96	S10	WBT	BFR54	S3	Sm	BFW92	S10	WBT
BFP90A	S10	WBT	BFR64	S10	WBT	BFW92A	S10	WBT
BFP91A	S10	WBT	BFR65	S10	WBT	BFW93	S10	WBT
BFP96	S10	WBT	BFR84	S5	FET	BFX29	S3	Sm
BFQ10	S5	FET	BFR90	S10	WBT	BFX30	S3	Sm
BFQ11	S5	FET	BFR90A	S10	WBT	BFX34	S3	Sm
BFQ12	S5	FET	BFR91	S10	WBT	BFX84	S3	Sm
BFQ13	S5	FET	BFR91A	S10	WBT	BFX85	S3	Sm
BFQ14	S5	FET	BFR92;R	S7	Mm	BFX86	S3	Sm
BFQ15	S5	FET	BFR92A;R	S7	Mm	BFX87	S3	Sm
BFQ16	S5	FET	BFR93;R	S7	Mm	BFX88	S3	Sm
BFQ17	S7	Mm	BFR93A;R	S7	Mm	BFX89	S10	WBT
BFQ18A	S7	Mm	BFR94	S10	WBT	BFY50	S3	Sm
BFQ19	S7	Mm	BFR95	S10	WBT	BFY51	S3	Sm
BFQ22S	S10	WBT	BFR96	S10	WBT	BFY52	S3	Sm
BFQ23	S10	WBT	BFR96S	S10	WBT	BFY55	S3	Sm
BFQ23C	S10	WBT	BFR101A;B	S7/S5	Mm/FET	BFY90	S10	WBT
BFQ24	S10	WBT	BFS17;R	S7	Mm	BG2000	S1	RT
BFQ32	S10	WBT	BFS18;R	S7	Mm	BG2097	S1	RT
BFQ32C	S10	WBT	BFS19;R	S7	Mm	BGD102	S10	WBM
BFQ32S	S10	WBT	BFS20;R	S7	Mm	BGD102E	S10	WBM
BFQ33	S10	WBT	BFS21	S5	FET	BGD104	S10	WBM
BFQ34	S10	WBT	BFS21A	S5	FET	BGD104E	S10	WBM
BFQ34T	S10	WBT	BFS22A	S6	RFP	BGX11*	S2b	ThM
BFQ42	S6	RFP	BFS23A	S6	RFP	BGX12*	S2b	ThM
BFQ43	S6	RFP	BFT24	S10	WBT	BGX13*	S2b	ThM
BFQ51	S10	WBT	BFT25;R	S7	Mm	BGX14*	S2b	ThM
BFQ51C	S10	WBT	BFT44	S3	Sm	BGX15*	S2b	ThM
BFQ52	S10	WBT	BFT45	S3	Sm	BGX17*	S2b	ThM
BFQ53	S10	WBT	BFT46	S7/S5	Mm/FET	BGX25	S2a	ThM
BFQ63	S10	WBT	BFT92;R	S7	Mm	BGY22	S6	RFP
BFQ65	S10	WBT	BFT93;R	S7	Mm	BGY22A	S6	RFP
BFQ66	S10	WBT	BFW10	S5	FET	BGY23	S6	RFP
BFQ68	S10	WBT	BFW11	S5	FET	BGY23A	S6	RFP
BFQ136	S10	WBT	BFW12	S5	FET	BGY32	S6	RFP
BFR29	S5	FET	BFW13	S5	FET	BGY33	S6	RFP
BFR30	S5/S7	FET/Mm	BFW16A	S10	WBT	BGY35	S6	RFP

\* = series

FET = Field-effect transistors

Mm = Microminiature semiconductors  
for hybrid circuits

RFP = R.F. power transistors and modules

RT = Tripler

Sm = Small-signal transistors

ThM = Thyristor modules

WBM = Wideband hybrid IC modules

WBT = Wideband hybrid IC transistors

type no.	book	section	type no.	book	section	type no.	book	section
BGY36	S6	RFP	BLU45/12	S6	RFP	BLW33	S6	RFP
BGY40A	S6	RFP	BLU50	S6	RFP	BLW34	S6	RFP
BGY40B	S6	RFP	BLU51	S6	RFP	BLW50F	S6	RFP
BGY41A	S6	RFP	BLU52	S6	RFP	BLW60	S6	RFP
BGY41B	S6	RFP	BLU53	S6	RFP	BLW60C	S6	RFP
BGY43	S6	RFP	BLU60/12	S6	RFP	BLW76	S6	RFP
BGY45A	S6	RFP	BLU97	S6	RFP	BLW77	S6	RFP
BGY45B	S6	RFP	BLU98	S6	RFP	BLW78	S6	RFP
BGY46A	S6	RFP	BLU99	S6	RFP	BLW79	S6	RFP
BGY46B	S6	RFP	BLV10	S6	RFP	BLW80	S6	RFP
BGY47*	S6	RFP	BLV11	S6	RFP	BLW81	S6	RFP
BGY50	S10	WBM	BLV20	S6	RFP	BLW82	S6	RFP
BGY51	S10	WBM	BLV21	S6	RFP	BLW83	S6	RFP
BGY52	S10	WBM	BLV25	S6	RFP	BLW84	S6	RFP
BGY53	S10	WBM	BLV30	S6	RFP	BLW85	S6	RFP
BGY54	S10	WBM	BLV30/12	S6	RFP	BLW86	S6	RFP
BGY55	S10	WBM	BLV31	S6	RFP	BLW87	S6	RFP
BGY56	S10	WBM	BLV32F	S6	RFP	BLW89	S6	RFP
BGY57	S10	WBM	BLV33	S6	RFP	BLW90	S6	RFP
BGY58	S10	WBM	BLV33F	S6	RFP	BLW91	S6	RFP
BGY58A	S10	WBM	BLV36	S6	RFP	BLW95	S6	RFP
BGY59	S10	WBM	BLV37	S6	RFP	BLW96	S6	RFP
BGY60	S10	WBM	BLV45/12	S6	RFP	BLW97	S6	RFP
BGY61	S10	WBM	BLV57	S6	RFP	BLW98	S6	RFP
BGY65	S10	WBM	BLV59	S6	RFP	BLW99	S6	RFP
BGY67	S10	WBM	BLV75/12	S6	RFP	BLX13	S6	RFP
BGY67A	S10	WBM	BLV80/28	S6	RFP	BLX13C	S6	RFP
BGY70	S10	WBM	BLV90	S6	RFP	BLX14	S6	RFP
BGY71	S10	WBM	BLV91	S6	RFP	BLX15	S6	RFP
BGY74	S10	WBM	BLV92	S6	RFP	BLX39	S6	RFP
BGY75	S10	WBM	BLV93	S6	RFP	BLX65	S6	RFP
BGY84	S10	WBM	BLV94	S6	RFP	BLX65E	S6	RFP
BGY84A	S10	WBM	BLV95	S6	RFP	BLX67	S6	RFP
BGY85	S10	WBM	BLV96	S6	RFP	BLX68	S6	RFP
BGY85A	S10	WBM	BLV97	S6	RFP	BLX69A	S6	RFP
BGY93A	S6	RFP	BLV98	S6	RFP	BLX91A	S6	RFP
BGY93B	S6	RFP	BLV99	S6	RFP	BLX91CB	S6	RFP
BGY93C	S6	RFP	BLW29	S6	RFP	BLX92A	S6	RFP
BLU20/12	S6	RFP	BLW31	S6	RFP	BLX93A	S6	RFP
BLU30/12	S6	RFP	BLW32	S6	RFP	BLX94A	S6	RFP

\* = series

RFP = R.F. power transistors and modules

WBM = Wideband hybrid IC modules

# INDEX

type no.	book	section	type no.	book	section	type no.	book	section
BLX94C	S6	RFP	BS170	S5	FET	BSS61	S3	Sm
BLX95	S6	RFP	BSD10	S5	FET	BSS62	S3	Sm
BLX96	S6	RFP	BSD12	S5	FET	BSS63;R	S7	Mm
BLX97	S6	RFP	BSD20	S5/7	FET	BSS64;R	S7	Mm
BLX98	S6	RFP	BSD22	S5/7	FET	BSS68	S3	Sm
BLY85	S6	RFP	BSD212	S5	FET	BSS83	S5/7	FET/Mm
BLY87A	S6	RFP	BSD213	S5	FET	BST15	S7	Mm
BLY87C	S6	RFP	BSD214	S5	FET	BST16	S7	Mm
BLY88A	S6	RFP	BSD215	S5	FET	BST39	S7	Mm
BLY88C	S6	RFP	BSR12;R	S7	Mm	BST40	S7	Mm
BLY89A	S6	RFP	BSR13;R	S7	Mm	BST50	S7	Mm
BLY89C	S6	RFP	BSR14;R	S7	Mm	BST51	S7	Mm
BLY90	S6	RFP	BSR15;R	S7	Mm	BST52	S7	Mm
BLY91A	S6	RFP	BSR16;R	S7	Mm	BST60	S7	Mm
BLY91C	S6	RFP	BSR17;R	S7	Mm	BST61	S7	Mm
BLY92A	S6	RFP	BSR17A;R	S7	Mm	BST62	S7	Mm
BLY92C	S6	RFP	BSR18;R	S7	Mm	BST70A	S5	FET
BLY93A	S6	RFP	BSR18A;R	S7	Mm	BST72A	S5	FET
BLY93C	S6	RFP	BSR30	S7	Mm	BST74A	S5	FET
BLY94	S6	RFP	BSR31	S7	Mm	BST76A	S5	FET
BLY97	S6	RFP	BSR32	S7	Mm	BST78	S5	FET
BPF10	S8	PDT	BSR33	S7	Mm	BST80	S5	FET
BPF24	S8	PDT	BSR40	S7	Mm	BST82	S5	FET
BPW22A	S8	PDT	BSR41	S7	Mm	BST84	S5	FET
BPW50	S8	PDT	BSR42	S7	Mm	BST86	S5	FET
BPX25	S8	PDT	BSR43	S7	Mm	BST90	S5	FET
BPX29	S8	PDT	BSR50	S3	Sm	BST97	S5	FET
BPX40	S8	PDT	BSR51	S3	Sm	BST100	S5	FET
BPX41	S8	PDT	BSR52	S3	Sm	BST110	S5	FET
BPX42	S8	PDT	BSR56	S7/S5	Mm/FET	BST120	S5	FET
BPX71	S8	PDT	BSR57	S7/S5	Mm/FET	BST122	S5	FET
BPX72	S8	PDT	BSR58	S7/S5	Mm/FET	BSV15	S3	Sm
BPX95C	S8	PDT	BSR60	S3	Sm	BSV16	S3	Sm
BR100/03	S2b	Th	BSR61	S3	Sm	BSV17	S3	Sm
BR101	S3	Sm	BSR62	S3	Sm	BSV52;R	S7	Mm
BRY39	S3	Sm	BSS38	S3	Sm	BSV64	S3	Sm
BRY56	S3	Sm	BSS50	S3	Sm	BSV78	S5	FET
BRY61	S7	Mm	BSS51	S3	Sm	BSV79	S5	FET
BRY62	S7	Mm	BSS52	S3	Sm	BSV80	S5	FET
BS107	S5	FET	BSS60	S3	Sm	BSV81	S5	FET

FET = Field-effect transistors

Mm = Microminiature semiconductors  
for hybrid circuits

Sm = Small-signal transistors

PDT = Photodiodes or transistors

Th = Thyristors

RFP = R.F. power transistors and modules

type no.	book	section	type no.	book	section	type no.	book	section
BSW66A	S3	Sm	BTY91*	S2b	Th	BUX48;A	S4b	SP
BSW67A	S3	Sm	BU426	S4b	SP	BUX80	S4b	SP
BSW68A	S3	Sm	BU426A	S4b	SP	BUX81	S4b	SP
BSX19	S3	Sm	BU433	S4b	SP	BUX82	S4b	SP
BSX20	S3	Sm	BU505	S4b	SP	BUX83	S4b	SP
BSX45	S3	Sm	BU506	S4b	SP	BUX84	S4b	SP
BSX46	S3	Sm	BU506D	S4b	SP	BUX84F	S4b	SP
BSX47	S3	Sm	BU508A	S4b	SP	BUX85	S4b	SP
BSX59	S3	Sm	BU508D	S4b	SP	BUX85F	S4b	SP
BSX60	S3	Sm	BU705	S4b	SP	BUX86	S4b	SP
BSX61	S3	Sm	BU706	S4b	SP	BUX87	S4b	SP
BSY95A	S3	Sm	BU706D	S4b	SP	BUX88	S4b	SP
BT136*	S2b	Tri	BU806	S4b	SP	BUX90	S4b	SP
BT137*	S2b	Tri	BU807	S4b	SP	BUX98	S4b	SP
BT138*	S2b	Tri	BU804	S4b	SP	BUX98A	S4b	SP
BT139*	S2b	Tri	BU824	S4b	SP	BUX99	S4b	SP
BT149*	S2b	Th	BU826	S4b	SP	BUY89	S4b	SP
BT151*	S2b	Th	BUP22*	S4b	SP	BUZ10	S9	PM
BT152*	S2b	Th	BUP23*	S4b	SP	BUZ10A	S9	PM
BT153	S2b	Th	BUS11;A	S4b	SP	BUZ11	S9	PM
BT155*	S2b	Th	BUS12;A	S4b	SP	BUZ11A	S9	PM
BT157*	S2b	Th	BUS13;A	S4b	SP	BUZ14	S9	PM
BTV24*	S2b	Th	BUS14;A	S4b	SP	BUZ15	S9	PM
BTV34*	S2b	Tri	BUS21*	S4b	SP	BUZ20	S9	PM
BTV58*	S2b	Th	BUS22*	S4b	SP	BUZ21	S9	PM
BTV59*	S2b	Th	BUS23*	S4b	SP	BUZ23	S9	PM
BTV60*	S2b	Th	BUT11;A	S4b	SP	BUZ24	S9	PM
BTW23*	S2b	Th	BUT11F	S4b	SP	BUZ25	S9	PM
BTW38*	S2b	Th	BUT11AF	S4b	SP	BUZ30	S9	PM
BTW40*	S2b	Th	BUV82	S4b	SP	BUZ31	S9	PM
BTW42*	S2b	Th	BUV83	S4b	SP	BUZ32	S9	PM
BTW43*	S2b	Tri	BUV89	S4b	SP	BUZ33	S9	PM
BTW45*	S2b	Th	BUV90;A	S4b	SP	BUZ34	S9	PM
BTW58*	S2b	Th	BUW11;A	S4b	SP	BUZ35	S9	PM
BTW59*	S2b	Th	BUW12;A	S4b	SP	BUZ36	S9	PM
BTW63*	S2b	Th	BUW13;A	S4b	SP	BUZ40	S9	PM
BTW92*	S2b	Th	BUW84	S4b	SP	BUZ41A	S9	PM
BTX18*	S2b	Th	BUW85	S4b	SP	BUZ42	S9	PM
BTX94*	S2b	Tri	BUX46;A	S4b	SP	BUZ43	S9	PM
BTY79*	S2b	Th	BUX47;A	S4b	SP	BUZ44A	S9	PM

\* = series

PM = Power MOS transistors

SP = Low-frequency switching power transistors

Sm = Small-signal transistors

Th = Thyristors

Tri = Triacs



# INDEX

type no.	book	section	type no.	book	section	type no.	book	section
BUZ45	S9	PM	BY505	S1	R	BYV36*	S1	R
BUZ45A	S9	PM	BY509	S1	R	BYV39*	S2a	R
BUZ45B	S9	PM	BY527	S1	R	BYV42*	S2a	R
BUZ45C	S9	PM	BY584	S1	R	BYV43*	S2a	R
BUZ46	S9	PM	BY588	S1	R	BYV72*	S2a	R
BUZ50A	S9	PM	BY609	S1	R	BYV73*	S2a	R
BUZ50B	S9	PM	BY610	S1	R	BYV79*	S2a	R
BUZ53A	S9	PM	BY614	S1	R	BYV92*	S2a	R
BUZ54	S9	PM	BY619	S1	R	BYV95A	S1	R
BUZ54A	S9	PM	BY620	S1	R	BYV95B	S1	R
BUZ60	S9	PM	BY707	S1	R	BYV95C	S1	R
BUZ60B	S9	PM	BY708	S1	R	BYV96D	S1	R
BUZ63	S9	PM	BY709	S1	R	BYV96E	S1	R
BUZ63B	S9	PM	BY710	S1	R	BYW25*	S2a	R
BUZ64	S9	PM	BY711	S1	R	BYW29*	S2a	R
BUZ71	S9	PM	BY712	S1	R	BYW30*	S2a	R
BUZ71A	S9	PM	BY713	S1	R	BYW31*	S2a	R
BUZ72	S9	PM	BY714	S1	R	BYW54	S1	R
BUZ72A	S9	PM	BYD13*	S1	R	BYW55	S1	R
BUZ73A	S9	PM	BYD33*	S1	R	BYW56	S1	R
BUZ74	S9	PM	BYD73*	S1	R	BYW92*	S2a	R
BUZ74A	S9	PM	BYM56*	S1	R	BYW93*	S2a	R
BUZ76	S9	PM	BYQ28*	S2a	R	BYW94*	S2a	R
BUZ76A	S9	PM	BYR29*	S2a	R	BYW95A	S1	R
BUZ80	S9	PM	BYT79*	S2a	R	BYW95B	S1	R
BUZ80A	S9	PM	BYV10	S1	R	BYW95C	S1	R
BUZ83	S9	PM	BYV19*	S2a	R	BYW96D	S1	R
BUZ83A	S9	PM	BYV20*	S2a	R	BYW96E	S1	R
BUZ84	S9	PM	BYV21*	S2a	R	BYX25*	S2a	R
BUZ84A	S9	PM	BYV22*	S2a	R	BYX30*	S2a	R
BY228	S1	R	BYV23*	S2a	R	BYX32*	S2a	R
BY229*	S2a	R	BYV24*	S2a	R	BYX38*	S2a	R
BY249*	S2a	R	BYV26*	S1	R	BYX39*	S2a	R
BY260*	S2a	R	BYV27*	S1/S2a	R	BYX42*	S2a	R
BY261*	S2a	R	BYV28*	S1/S2a	R	BYX46*	S2a	R
BY329*	S2a	R	BYV29*	S2a	R	BYX50*	S2a	R
BY359*	S2a	R	BYV30*	S2a	R	BYX52*	S2a	R
BY438	S1	R	BYV32*	S2a	R	BYX56*	S2a	R
BY448	S1	R	BYV33*	S2a	R	BYX90G	S1	R
BY458	S1	R	BYV34*	S2a	R	BYX94	S1	R

\* = series

R = Rectifier diodes

PM = Power MOS transistors

type no.	book	section	type no.	book	section	type no.	book	section
BYX96*	S2a	R	CFX33	S11	M	CQV61A(L)	S8	LED
BYX97*	S2a	R	CNX21	S8	PhC	CQV62(L)	S8	LED
BYX98*	S2a	R	CNX35	S8	PhC	CQV70(L)	S8	LED
BYX99*	S2a	R	CNX36	S8	PhC	CQV70A(L)	S8	LED
BZD23	S1	Vrg	CNX37	S8	PhC	CQV71A(L)	S8	LED
BZT03	S1	Vrg	CNX38	S8	PhC	CQV72(L)	S8	LED
BZV10	S1	Vrf	CNX44	S8	PhC	CQV80L	S8	LED
BZV11	S1	Vrf	CNX48	S8	PhC	CQV80AL	S8	LED
BZV12	S1	Vrf	CNX62	S8	PhC	CQV81L	S8	LED
BZV13	S1	Vrf	CNY50	S8	PhC	CQV82L	S8	LED
BZV14	S1	Vrf	CNY52	S8	PhC	CQW10(L)	S8	LED
BZV37	S1	Vrf	CNY53	S8	PhC	CQW10A(L)	S8	LED
BZV46	S1	Vrg	CNY57	S8	PhC	CQW10B(L)	S8	LED
BZV49*	S1/S7	Vrg/Mm	CNY57A	S8	PhC	CQW11A(L)	S8	LED
BZV55*	S7	Mm	CNY62	S8	PhC	CQW11B(L)	S8	LED
BZV85*	S1	Vrg	CNY63	S8	PhC	CQW12(L)	S8	LED
BZW03*	S1	Vrg	CQ209S	S8	D	CQW12B(L)	S8	LED
BZW14	S1	Vrg	CQ216X	S8	D	CQW20A	S8	LED
BZW70*	S2a	TS	CQ216Y	S8	D	CQW21	S8	LED
BZW86*	S2a	TS	CQ327;R	S8	D	CQW22	S8	LED
BZW91*	S2a	TS	CQ330;R	S8	D	CQW24(L)	S8	LED
BZX55*	S1	Vrg	CQ331;R	S8	D	CQW54	S8	LED
BZX70*	S2a	Vrg	CQ332;R	S8	D	CQX10	S8	LED
BZX75*	S1	Vrg	CQ427;R	S8	D	CQX11	S8	LED
BZX79*	S1	Vrg	CQ430;R	S8	D	CQX12	S8	LED
BZX84*	S7/S1	Mm/Vrg	CQ431;R	S8	D	CQX24(L)	S8	LED
BZX90	S1	Vrf	CQ432;R	S8	D	CQX51	S8	LED
BZX91	S1	Vrf	CQF24	S8	Ph	CQX54(L)	S8	LED
BZX92	S1	Vrf	CQL10A	S8	Ph	CQX64(L)	S8	LED
BZX93	S1	Vrf	CQL13	S8	Ph	CQX74(L)	S8	LED
BZX94	S1	Vrf	CQL13A	S8	Ph	CQX74Y	S8	LED
BZY91*	S2a	Vrg	CQL14A	S8	Ph	CQY11B	S8	LED
BZY93*	S2a	Vrg	CQL14B	S8	Ph	CQY11C	S8	LED
BZY95*	S2a	Vrg	CQN10	S8	LED	CQY24B(L)	S8	LED
BZY96*	S2a	Vrg	CQN11	S8	LED	CQY49B	S8	LED
CFX13	S11	M	CQT10	S8	LED	CQY49C	S8	LED
CFX21	S11	M	CQT11	S8	LED	CQY50	S8	LED
CFX30	S11	M	CQT12	S8	LED	CQY52	S8	LED
CFX31	S11	M	CQV60(L)	S8	LED	CQY54A	S8	LED
CFX32	S11	M	CQV60A(L)	S8	LED	CQY58A	S8	LED

\* = series  
 D = Displays  
 LED = Light-emitting diodes  
 M = Microwave transistors  
 Mm = Microminiature semiconductors  
 Ph = Photoconductive devices

PhC = Photocouplers  
 R = Rectifier diodes  
 TS = Transient suppressor diodes  
 Vrf = Voltage reference diodes  
 Vrg = Voltage regulator diodes

# INDEX

type no.	book	section	type no.	book	section	type no.	book	section
CQY89A	S8	LED	LKE27010R	S11	M	OM350	S10	WBM
CQY94	S8	LED	LKE27025R	S11	M	OM360	S10	WBM
CQY94B(L)	S8	LED	LKE32002T	S11	M	OM361	S10	WBM
CQY95B	S8	LED	LKE32004T	S11	M	OM370	S10	WBM
CQY96(L)	S8	LED	LTE42005S	S11	M	OM386B	S13	SEN
CQY97A	S8	LED	LTE42008R	S11	M	OM386M	S13	SEN
KMZ10A	S13	SEN	LTE42012R	S11	M	OM387B	S13	SEN
KMZ10B	S13	SEN	LV1721E50R	S11	M	OM387M	S13	SEN
KMZ10C	S13	SEN	LV2024E45R	S11	M	OM388B	S13	SEN
KP100A	S13	SEN	LV2327E40R	S11	M	OM389B	S13	SEN
KP101A	S13	SEN	LV3742E16R	S11	M	OM931	S4a	P
KPZ20G	S13	SEN	LV3742E24R	S11	M	OM961	S4a	P
KPZ21G	S13	SEN	LWE2015R	S11	M	OSB9110	S2a	St
KTY81*	S13	SEN	LWE2025R	S11	M	OSB9115	S2a	St
KTY83*	S13	SEN	LZ1418E100RS11	M		OSB9210	S2a	St
KTY84*	S13	SEN	MKB12040WS	S11	M	OSB9215	S2a	St
LAE2001R	S11	M	MKB12100WS	S11	M	OSB9410	S2a	St
LAE4001Q	S11	M	MKB12140W	S11	M	OSB9415	S2a	St
LAE4001R	S11	M	MO6075B200ZS11	M		OSM9110	S2a	St
LAE4002S	S11	M	MO6075B400ZS11	M		OSM9115	S2a	St
LAE6000Q	S11	M	MRB12175YR	S11	M	OSM9210	S2a	St
LBE1004R	S11	M	MRB12350YR	S11	M	OSM9215	S2a	St
LBE1010R	S11	M	MS1011B700YS11	M		OSM9410	S2a	St
LBE2003S	S11	M	MS6075B800ZS11	M		OSM9415	S2a	St
LBE2005Q	S11	M	MSB12900Y	S11	M	OSM9510	S2a	St
LBE2008T	S11	M	MZ0912B75Y	S11	M	OSM9511	S2a	St
LBE2009S	S11	M	MZ0912B150YS11	M		OSM9512	S2a	St
LCE1010R	S11	M	OM286; M	S13	SEN	OSS9110	S2a	St
LCE2003S	S11	M	OM287; M	S13	SEN	OSS9115	S2a	St
LCE2005Q	S11	M	OM320	S10	WBM	OSS9210	S2a	St
LCE2008T	S11	M	OM321	S10	WBM	OSS9215	S2a	St
LCE2009S	S11	M	OM322	S10	WBM	OSS9410	S2a	St
LJE42002T	S11	M	OM323	S10	WBM	OSS9415	S2a	St
LKE1004R	S11	M	OM323A	S10	WBM	PBMF4391	S5	FET
LKE2002T	S11	M	OM335	S10	WBM	PBMF4392	S5	FET
LKE2004T	S11	M	OM336	S10	WBM	PBMF4393	S5	FET
LKE2015T	S11	M	OM337	S10	WBM	PDE1001U	S11	M
LKE21004R	S11	M	OM337A	S10	WBM	PDE1003U	S11	M
LKE21015T	S11	M	OM339	S10	WBM	PDE1005U	S11	M
LKE21050T	S11	M	OM345	S10	WBM	PDE1010U	S11	M

\* = series

FET = Field-effect transistors

LED = Light-emitting diodes

M = Microwave transistors

P = Low-frequency power transistors

St = Rectified stacks

WBM = Wideband hybrid IC modules

type no.	book	section	type no.	book	section	type no.	book	section
PEE1001U	S11	M	PVB42004X	S11	M	TIP30*	S4a	P
PEE1003U	S11	M	PZ1418B15U	S11	M	TIP31*	S4a	P
PEE1005U	S11	M	PZ1418B30U	S11	M	TIP32*	S4a	P
PEE1010U	S11	M	PZ1721B12U	S11	M	TIP33*	S4a	P
PH2222;R	S3	Sm	PZ1721B25U	S11	M	TIP34*	S4a	P
PH2222A;R	S3	Sm	PZ2024B10U	S11	M	TIP41*	S4a	P
PH2369	S3	Sm	PZ2024B20U	S11	M	TIP42*	S4a	P
PH2907;R	S3	Sm	PZB16035U	S11	M	TIP47	S4a	P
PH2907A;R	S3	Sm	PZB27020U	S11	M	TIP48	S4a	P
PH2955T	S4a	P	RPY58A	S8	Ph	TIP49	S4a	P
PH3055T	S4a	P	RPY76B	S8	Ph	TIP50	S4a	P
PH5415	S3	Sm	RPY86	S8	I	TIP110	S4a	P
PH5416	S3	Sm	RPY87	S8	I	TIP111	S4a	P
PH13002	S4b	SP	RPY88	S8	I	TIP112	S4a	P
PH13003	S4b	SP	RPY89	S8	I	TIP115	S4a	P
PHSD51	S2a	R	RPY90*	S8	I	TIP116	S4a	P
PKB3001U	S11	M	RPY91*	S8	I	TIP117	S4a	P
PKB3003U	S11	M	RPY93	S8	I	TIP120	S4a	P
PKB3005U	S11	M	RPY94	S8	I	TIP121	S4a	P
PKB12005U	S11	M	RPY95	S8	I	TIP122	S4a	P
PKB20010U	S11	M	RPY96	S8	I	TIP125	S4a	P
PKB23001U	S11	M	RPY97	S8	I	TIP126	S4a	P
PKB23003U	S11	M	RV3135B5X	S11	M	TIP127	S4a	P
PKB23005U	S11	M	RX1214B300YS11	M		TIP130	S4a	P
PKB25006T	S11	M	RXB12350Y	S11	M	TIP131	S4a	P
PKB32001U	S11	M	RZ1214B35Y	S11	M	TIP132	S4a	P
PKB32003U	S11	M	RZ1214B60W	S11	M	TIP135	S4a	P
PKB32005U	S11	M	RZ1214B65Y	S11	M	TIP136	S4a	P
PPC5001T	S11	M	RZ1214B125WS11	M		TIP137	S4a	P
PQC5001T	S11	M	RZ1214B125YS11	M		TIP140	S4a	P
PTB23001X	S11	M	RZ1214B150YS11	M		TIP141	S4a	P
PTB23003X	S11	M	RZ2833B45W	S11	M	TIP145	S4a	P
PTB23005X	S11	M	RZ3135B15U	S11	M	TIP146	S4a	P
PTB32001X	S11	M	RZ3135B15W	S11	M	TIP147	S4a	P
PTB32003X	S11	M	RZ3135B25U	S11	M	TIP2955	S4a	P
PTB32005X	S11	M	RZ3135B30W	S11	M	TIP3055	S4a	P
PTB42001X	S11	M	RZB12100Y	S11	M	1N821;A	S1	Vrf
PTB42002X	S11	M	RZB12350Y	S11	M	1N823;A	S1	Vrf
PTB42003X	S11	M	RZZ1214B300YS11	M		1N825;A	S1	Vrf
PV3742B4X	S11	M	TIP29*	S4a	P	1N827;A	S1	Vrf

\* = series

I = Infrared devices

M = Microwave transistors

P = Low-frequency power transistors

Ph = Photoconductive diodes

R = Rectifier diodes

Sm = Small-signal transistors

SP = Low-frequency switching power transistors

Vrf = Voltage reference diodes

# INDEX

type no.	book	section	type no.	book	section	type no.	book	section
1N829;A	S1	Vrf	1N6097	S2a	R	2N3926	S6	RFP
1N914	S1	SD	1N6098	S2a	R	2N3927	S6	RFP
1N916	S1	SD	2N918	S10	WBT	2N3966	S5	FET
1N3879	S2a	R	2N929	S3	Sm	2N4030	S3	Sm
1N3880	S2a	R	2N930	S3	Sm	2N4031	S3	Sm
1N3881	S2a	R	2N1613	S3	Sm	2N4032	S3	Sm
1N3882	S2a	R	2N1711	S3	Sm	2N4033	S3	Sm
1N3883	S2a	R	2N1893	S3	Sm	2N4091	S5	FET
1N3889	S2a	R	2N2219	S3	Sm	2N4092	S5	FET
1N3890	S2a	R	2N2219A	S3	Sm	2N4093	S5	FET
1N3891	S2a	R	2N2222	S3	Sm	2N4123	S3	Sm
1N3892	S2a	R	2N2222A	S3	Sm	2N4124	S3	Sm
1N3893	S2a	R	2N2297	S3	Sm	2N4125	S3	Sm
1N3909	S2a	R	2N2368	S3	Sm	2N4126	S3	Sm
1N3910	S2a	R	2N2369	S3	Sm	2N4391	S5	FET
1N3911	S2a	R	2N2369A	S3	Sm	2N4392	S5	FET
1N3912	S2a	R	2N2483	S3	Sm	2N4393	S5	FET
1N3913	S2a	R	2N2484	S3	Sm	2N4427	S6	RFP
1N4001G	S1	R	2N2904	S3	Sm	2N4856	S5	FET
1N4002G	S1	R	2N2904A	S3	Sm	2N4857	S5	FET
1N4003G	S1	R	2N2905	S3	Sm	2N4858	S5	FET
1N4004G	S1	R	2N2905A	S3	Sm	2N4859	S5	FET
1N4005G	S1	R	2N2906	S3	Sm	2N4860	S5	FET
1N4006G	S1	R	2N2906A	S3	Sm	2N4861	S5	FET
1N4007G	S1	R	2N2907	S3	Sm	2N5400	S3	Sm
1N4148	S1	SD	2N2907A	S3	Sm	2N5401	S3	Sm
1N4150	S1	SD	2N3019	S3	Sm	2N5415	S3	Sm
1N4151	S1	SD	2N3020	S3	Sm	2N5416	S3	Sm
1N4153	S1	SD	2N3053	S3	Sm	2N5550	S3	Sm
1N4446	S1	SD	2N3375	S6	RFP	2N5551	S3	Sm
1N4448	S1	SD	2N3553	S6	RFP	2N6659	S5	FET
1N4531	S1	SD	2N3632	S6	RFP	2N6660	S5	FET
1N4532	S1	SD	2N3822	S5	FET	2N6661	S5	FET
1N5059	S1	R	2N3823	S5	FET	61SV	S8	I
1N5060	S1	R	2N3866	S6	RFP	375CQY/B	S8	Ph
1N5061	S1	R	2N3903	S3	Sm	497CQF/A	S8	Ph
1N5062	S1	R	2N3904	S3	Sm	498CQL	S8	Ph
1N5832	S2a	R	2N3905	S3	Sm	56201d	S4b	A
1N5833	S2a	R	2N3906	S3	Sm	56201j	S4b	A
1N5834	S2a	R	2N3924	S6	RFP	56245	S3, 10	A

A = Accessories  
 FET = Field-effect transistors  
 I = Infrared devices  
 Ph = Photoconductive devices  
 R = Rectified diodes

RFP = R.F. power transistors and modules  
 SD = Small-signal diodes  
 Sm = Small-signal transistors  
 Vrf = Voltage reference diodes  
 WBT = Wideband transistors

type no.	book	section	type no.	book	section	type no.	book	section
56246	S3,	10 A	56359c	S2,	4b A	56379	S2,	4b A
56261a	S4b	A	56359d	S2,	4b A	56387a,b	S4b	A
56264a,b	S2a/b	A	56360a	S2,	4b A			
56295	S2a/b	A	56363	S2,	4b A			
56326	S4b	A	56364	S2,	4b A			
56339	S4b	A	56367	S2a/b	A			
56352	S4b	A	56368a	S2,	4b A			
56353	S4b	A	56368b	S2,	4b A			
56354	S4b	A	56369	S2,	4b A			
56359b	S2,	4b A	56378	S2,	4b A			

A = Accessories

NOTES

# Electronic components and materials for professional, industrial and consumer uses from the world-wide Philips Group of Companies

- Argentina:** PHILIPS ARGENTINA S.A., Div. Elcoma, Vedia 3892, 1430 BUENOS AIRES, Tel. 541-7141/7242/7343/7444/7545.
- Australia:** PHILIPS INDUSTRIES HOLDINGS LTD., Elcoma Division, 11 Waltham Street, ARTARMON, N.S.W. 2064, Tel. (02) 439 3322.
- Austria:** ÖSTERREICHISCHE PHILIPS BAUELEMENTE INDUSTRIE G.m.b.H., Triester Str. 64, A-1101 WIEN, Tel. 6291 11.
- Belgium:** N.V. PHILIPS & MBLE ASSOCIATED, 9 rue du Pavillon, B-1030 BRUXELLES, Tel. (02) 242 74 00.
- Brazil:** IBRAPE, Caixa Postal 7383, Av. Brigadeiro Faria Lima, 1735 SAO PAULO, SP, Tel. (011) 211-2600.
- Canada:** PHILIPS ELECTRONICS LTD., Elcoma Division, 601 Milner Ave., SCARBOROUGH, Ontario, M1B 1M8, Tel. 292-5161.
- Chile:** PHILIPS CHILENA S.A., Av. Santa Maria 0760, SANTIAGO, Tel. 39-4001.
- Colombia:** IND. PHILIPS DE COLOMBIA S.A., c/o IPRELENSO LTD., Cra. 21, No. 56-17, BOGOTA, D.E., Tel. 249 7624.
- Denmark:** MINIWATT A/S, Strandlodsvej 2, P.O. Box 1919, DK 2300 COPENHAGEN S, Tel. (01) 54 11 33.
- Finland:** OY PHILIPS AB, Elcoma Division, Kaivokatu 8, SF-00100 HELSINKI 10, Tel. 1 72 71.
- France:** R.T.C. LA RADIOTECHNIQUE-COMPELEC, 130 Avenue Ledru Rollin, F-75540 PARIS 11, Tel. 338 80-00.
- Germany (Fed. Republic):** VALVO, UB Bauelemente der Philips G.m.b.H., Valvo Haus, Burchardstrasse 19, D-2 HAMBURG 1, Tel. (040) 3296-0.
- Greece:** PHILIPS S.A. HELLENIQUE, Elcoma Division, 52, Av. Syngrou, ATHENS, Tel. 92 15 111.
- Hong Kong:** PHILIPS HONG KONG LTD., Elcoma Div., 15/F Philips Ind. Bldg., 24-28 Kung Yip St., KWAI CHUNG, Tel. (0)-24 51 21.
- India:** PEICO ELECTRONICS & ELECTRICALS LTD., Elcoma Dept., Band Box Building, 254-D Dr. Annie Besant Rd., BOMBAY - 400 025, Tel. 4220387/4220311.
- Indonesia:** P.T. PHILIPS-RALIN ELECTRONICS, Elcoma Div., Parim Bank Building, 2nd Fl., Jl. Jend. Sudirman, P.O. Box 223, JAKARTA, Tel. 716131.
- Ireland:** PHILIPS ELECTRICAL (IRELAND) LTD., Newstead, Clonskeagh, DUBLIN 14, Tel. 69 33 55.
- Italy:** PHILIPS S.p.A., Sezione Elcoma, Piazza IV Novembre 3, I-20124 MILANO, Tel. 2-6752.1.
- Japan:** NIHON PHILIPS CORP., Shuwa Shinagawa Bldg., 26-33 Takanawa 3-chome, Minato-ku, TOKYO (108), Tel. 448-5611.  
(IC Products) SIGNETICS JAPAN LTD., 8-7 Sanbancho Chiyoda-ku, TOKYO 102, Tel. (03) 230-1521.
- Korea (Republic of):** PHILIPS ELECTRONICS (KOREA) LTD., Elcoma Div., Philips House, 260-199 Itaewon-dong, Yongsan-ku, SEOUL, Tel. 794-4202.
- Malaysia:** PHILIPS MALAYSIA SDN. BERHAD, No. 4 Persiaran Barat, Petaling Jaya, P.O.B. 2163, KUALA LUMPUR, Selangor, Tel. 77 44 11.
- Mexico:** ELECTRONICA, S.A. de C.V., Carr. México-Toluca km. 62.5, TOLUCA, Edo. de México 50140, Tel. Toluca 91 (721) 613-00.
- Netherlands:** PHILIPS NEDERLAND, Marktgroep Elonco, Postbus 90050, 5600 PB EINDHOVEN, Tel. (040) 79 33 33.
- New Zealand:** PHILIPS NEW ZEALAND LTD., Elcoma Division, 110 Mt. Eden Road, C.P.O. Box 1041, AUCKLAND, Tel. 605-914.
- Norway:** NORSK A/S PHILIPS, Electronica Dept., Sandstuveien 70, OSLO 6, Tel. 68 02 00.
- Peru:** CADESA, Av. Alfonso Ugarte 1268, LIMA 5, Tel. 326070.
- Philippines:** PHILIPS INDUSTRIAL DEV. INC., 2246 Pasong Tamo, P.O. Box 911, Makati Comm. Centre, MAKATI-RIZAL 3116, Tel. 86-89-51 to 59.
- Portugal:** PHILIPS PORTUGUESA S.A.R.L., Av. Eng. Duarte Pacheco 6, 1009 LISBOA Codex, Tel. 68 31 21.
- Singapore:** PHILIPS PROJECT DEV. (Singapore) PTE LTD., Elcoma Div., Lorong 1, Toa Payoh, SINGAPORE 1231, Tel. 35 02 000.
- South Africa:** EDAC (PTY.) LTD., 3rd Floor Rainer House, Upper Railway Rd. & Ove St., New Doornfontein, JOHANNESBURG 2001, Tel. 614-2362/9.
- Spain:** MINIWATT S.A., Balmes 22, BARCELONA 7, Tel. 301 63 12.
- Sweden:** PHILIPS KOMPLEMENTER A.B., Lidingövägen 50, S-11584 STOCKHOLM 27, Tel. 08/7821000.
- Switzerland:** PHILIPS A.G., Elcoma Dept., Allmendstrasse 140-142, CH-8027 ZÜRICH, Tel. 01-488 22 11.
- Taiwan:** PHILIPS TAIWAN LTD., 3rd Fl., San Min Building, 57-1, Chung Shan N. Rd, Section 2, P.O. Box 22978, TAIPEI, Tel. (02)-5631717.
- Thailand:** PHILIPS ELECTRICAL CO. OF THAILAND LTD., 283 Silom Road, P.O. Box 961, BANGKOK, Tel. 233-6330-9.
- Turkey:** TÜRK PHILIPS TICARET A.S., Elcoma Department, İnönü Cad. No. 78-80, İSTANBUL, Tel. 43 59 10.
- United Kingdom:** MULLARD LTD., Mullard House, Torrington Place, LONDON WC1E 7HD, Tel. 01-580 6633.
- United States:** (Active Devices & Materials) AMPEREX SALES CORP., Providence Pike, SLATERSVILLE, R.I. 02876, Tel. (401) 762-9000.  
(Passive Devices) MEPCO/ELECTRA INC., Columbia Rd., MORRISTOWN, N.J. 07960, Tel. (201) 539-2000.  
(Passive Devices & Electromechanical Devices) CENTRALAB INC., 5855 N. Glen Park Rd., MILWAUKEE, WI 53201, Tel. (414) 228-7380.  
(IC Products) SIGNETICS CORPORATION, 811 East Arques Avenue, SUNNYVALE, California 94086, Tel. (408) 739-7700.
- Uruguay:** LUZILETRON S.A., Avda Uruguay 1287, P.O. Box 907, MONTEVIDEO, Tel. 91 43 21.
- Venezuela:** IND. VENEZOLANAS PHILIPS S.A., c/o MAGNETICA S.A. Calle 6, Ed. Las Tres Jotas, App. Post 78117, CARACAS, Tel. (02) 239 39 31

**For all other countries apply to:** Philips Electronic Components and Materials Division, International Business Relations, Building BAE, P.O. Box 218, 5600 MD EINDHOVEN, The Netherlands, Tel. +31 40 72 33 04, Telex 35000 phtcnl

This information is furnished for guidance, and with no guarantee as to its accuracy or completeness; its publication conveys no licence under any patent or other right, nor does the publisher assume liability for any consequence of its use; specifications and availability of goods mentioned in it are subject to change without notice; it is not to be reproduced in any way, in whole or in part, without the written consent of the publisher.