



INTEL CORP. 3065 Bowers Avenue, Santa Clara, California 95051 • (408) 246-7501

# MCS<sup>T.M.</sup>-4 Assembly Language Programming Manual

PRELIMINARY EDITION

December 1973

-- TABLE OF CONTENTS --

The INTELLEC 4 Microcomputer System  
Programming Manual

	<u>PAGE No.</u>
1.0 INTRODUCTION . . . . .	1-1
2.0 COMPUTER ORGANIZATION . . . . .	2-1
2.1 WORKING REGISTERS (INDEX REGISTERS) . . . . .	2-2
2.2 THE ACCUMULATOR . . . . .	2-3
2.3 MEMORIES . . . . .	2-3
2.3.1 READ-ONLY MEMORY . . . . .	2-3
2.3.2 PROGRAM RANDOM ACCESS MEMORY . . . . .	2-4
2.3.3 DATA RANDOM ACCESS MEMORY . . . . .	2-5
2.4 THE STACK . . . . .	2-7
2.5 INPUT/OUTPUT . . . . .	2-9
2.6 COMPUTER PROGRAM REPRESENTATION IN MEMORY . . . . .	2-10
2.7 MEMORY ADDRESSING . . . . .	2-13
2.7.1 DIRECT ADDRESSING . . . . .	2-13
2.7.2 SAME PAGE ADDRESSING . . . . .	2-14
2.7.3 INDIRECT ADDRESSING . . . . .	2-15
2.7.4 IMMEDIATE ADDRESSING . . . . .	2-16
2.7.5 PROGRAM RAM ADDRESSING . . . . .	2-16
2.7.6 DATA RAM ADDRESSING . . . . .	2-16
2.7.7 SUBROUTINES AND USE OF THE STACK FOR ADDRESSING . . . . .	2-17
2.8 CARRY BIT . . . . .	2-20
3.0 THE 4004 INSTRUCTION SET . . . . .	3-1
3.1 ASSEMBLY LANGUAGE . . . . .	3-1
3.1.1 HOW ASSEMBLY LANGUAGE IS USED . . . . .	3-1
3.1.2 STATEMENT MNEMONICS . . . . .	3-4

-- TABLE OF CONTENTS -- (Continued)

The INTELLEC 4 Microcomputer System  
Programming Manual

	<u>PAGE No.</u>
3.1.3 LABEL FIELD . . . . .	3-5
3.1.4 CODE FIELD . . . . .	3-6
3.1.5 OPERAND FIELD . . . . .	3-7
3.1.6 COMMENT FIELD . . . . .	3-11
3.2 DATA STATEMENTS . . . . .	3-12
3.2.1 TWO'S COMPLEMENT . . . . .	3-12
3.2.2 CONSTANT DATA . . . . .	3-15
3.3 INDEX REGISTER INSTRUCTIONS . . . . .	3-16
3.3.1 INC INCREMENT REGISTER . . . . .	3-17
3.3.2 FIN FETCH INDIRECT . . . . .	3-18
3.4 INDEX REGISTER TO ACCUMULATOR INSTRUCTIONS.	3-20
3.4.1 ADD ADD REGISTER TO ACCUMULATOR WITH CARRY . . . . .	3-21
3.4.2 SUB SUBTRACT REGISTER FROM ACCUM- ULATOR WITH BORROW . . . . .	3-22
3.4.3 LD LOAD ACCUMULATOR . . . . .	3-24
3.4.4 XCH EXCHANGE REGISTER AND ACCUM- ULATOR . . . . .	3-25
3.5 ACCUMULATOR INSTRUCTIONS . . . . .	3-26
3.5.1 CLB CLEAR BOTH . . . . .	3-27
3.5.2 CLC CLEAR CARRY . . . . .	3-27
3.5.3 IAC INCREMENT ACCUMULATOR . . . . .	3-28
3.5.4 CMC COMPLEMENT CARRY . . . . .	3-29
3.5.5 CMA COMPLEMENT ACCUMULATOR . . . . .	3-29
3.5.6 RAL ROTATE ACCUMULATOR LEFT THROUGH CARRY . . . . .	3-30
3.5.7 RAR ROTATE ACCUMULATOR RIGHT THROUGH CARRY . . . . .	3-31
3.5.8 TCC TRANSMIT CARRY AND CLEAR . . . . .	3-32
3.5.9 DAC DECREMENT ACCUMULATOR . . . . .	3-32

-- TABLE OF CONTENTS -- (Continued)

The INTELLEC 4 Microcomputer System  
Programming Manual

		<u>PAGE No.</u>
3.5.10	TCS TRANSFER CARRY SUBTRACT . . . . .	3-33
3.5.11	STC SET CARRY . . . . .	3-34
3.5.12	DAA DECIMAL ADJUST ACCUMULATOR . . . . .	3-34
3.5.13	KBP KEYBOARD PROCESS . . . . .	3-35
3.6	IMMEDIATE INSTRUCTIONS . . . . .	3-36
3.6.1	FIM FETCH IMMEDIATE . . . . .	3-36
3.6.2	LDM LOAD ACCUMULATOR . . . . .	3-37
3.7	TRANSFER OF CONTROL INSTRUCTIONS . . . . .	3-38
3.7.1	JUN JUMP UNCONDITIONALLY . . . . .	3-38
3.7.2	JIN JUMP INDIRECT . . . . .	3-40
3.7.3	JCN JUMP ON CONDITION . . . . .	3-41
3.7.4	ISZ INCREMENT AND SKIP IF ZERO . . . . .	3-43
3.8	SUBROUTINE LINKAGE COMMANDS . . . . .	3-45
3.8.1	JMS JUMP TO SUBROUTINE . . . . .	3-45
3.8.2	BBL BRANCH BACK AND LOAD . . . . .	3-46
3.9	NOP INSTRUCTION NO OPERATION . . . . .	3-48
3.10	MEMORY SELECTION INSTRUCTIONS . . . . .	3-48
3.10.1	DCL DESIGNATE COMMAND LINE . . . . .	3-48
3.10.2	SRC SEND REGISTER CONTROL . . . . .	3-50
3.11	INPUT/OUTPUT RAM INSTRUCTIONS . . . . .	3-53
3.11.1	RDM READ DATA RAM DATA CHARACTER . . . . .	3-54
3.11.2	RDn READ DATA RAM STATUS CHARACTER . . . . .	3-54
3.11.3	RDR READ ROM PORT . . . . .	3-55
3.11.4	WRM WRITE DATA RAM CHARACTER . . . . .	3-56
3.11.5	WRn WRITE DATA RAM STATUS CHARACTER . . . . .	3-57
3.11.6	WMP WRITE RAM PORT . . . . .	3-58

-- TABLE OF CONTENTS -- (Continued)

The INTELLEC 4 Microcomputer System  
Programming Manual

	<u>PAGE No.</u>
3.11.7 WRR WRITE ROM PORT . . . . .	3-59
3.11.8 ADM ADD DATA RAM TO ACCUMULATOR WITH CARRY . . . . .	3-60
3.11.9 SBM SUBTRACT DATA RAM FROM MEMORY WITH BORROW . . . . .	3-61
3.11.10 WPM WRITE PROGRAM RAM . . . . .	3-62
3.12 PSEUDO INSTRUCTION . . . . .	3-65
3.12.1 EQUATE FUNCTION . . . . .	3-65
3.12.2 ORIGIN FUNCTION . . . . .	3-66
4.0 PROGRAMMING TECHNIQUES . . . . .	4-1
4.1 CROSSING PAGE BOUNDARIES . . . . .	4-1
4.2 SUBROUTINES . . . . .	4-3
4.3 BRANCH TABLE PSEUDOSUBROUTINE . . . . .	4-5
4.4 LOGICAL OPERATIONS . . . . .	4-8
4.4.1 LOGICAL "AND" . . . . .	4-8
4.4.2 LOGICAL "OR" . . . . .	4-9
4.4.3 LOGICAL "XOR" EXCLUSIVE-OR . . . . .	4-11
4.5 MULTI-DIGIT ADDITION . . . . .	4-13
4.6 MULTI-DIGIT SUBTRACTION . . . . .	4-15
4.7 DECIMAL ADDITION . . . . .	4-18
4.8 DECIMAL SUBTRACTION . . . . .	4-20
4.9 FLOATING POINT NUMBERS . . . . .	4-24
APPENDIX "A" INSTRUCTION SUMMARY . . . . .	A-1
APPENDIX "B" INSTRUCTION MACHINE CODES . . . . .	B-1
APPENDIX "C" ASCII TABLES . . . . .	C-1
APPENDIX "D" BINARY-DECIMAL-HEXADECIMAL CONVERSION TABLES . . . . .	D-1

-- TERMS AND ABBREVIATIONS --

Address	A 12 bit number assigned to a read-only-memory or program random-access memory location corresponding to its sequential position.
Bit	The smallest unit of information which can be represented. (A bit may be in one of two states, 0 or 1).
Byte	A group of 8 contiguous bits occupying a single memory location.
Character	A group of 4 contiguous bits of data.
Instruction	The smallest single operation that the computer can be directed to execute.
Object Program	A program which can be loaded directly into the computer's memory and which requires no alteration before execution. An object program is usually on paper tape, and is produced by assembling a source program. Instructions are represented by binary machine code in an object program.
Program	A sequence of instructions which, taken as a group, allow the computer to accomplish a desired task.
Source Program	A program which is readable by a programmer but which must be transformed into object program format before it can be loaded into the computer and executed. Instructions in an assembly language source program are represented by their assembly language mnemonic.
System Program	A program written to help in the process of creating user programs.
User Program	A program written by the user to make the computer perform any desired task.
nnnB	nnn represents a number in binary format.
nnnH	nnn represents a number in hexadecimal format.

Note:

All numbers in this manual are assumed to be decimal unless otherwise specified.

0	0	1	1	R	P	0
---	---	---	---	---	---	---

A representation of a byte in memory. Bits which are fixed as 0 or 1 are indicated by 0 or 1; bits which may be either 0 or 1 in different circumstances are represented by letters; thus RP represents a three-bit field which contains one of the eight possible combinations of zeroes and ones.

## 1.0 INTRODUCTION

This manual has been written to help the reader program the INTEL 4004 microcomputer in assembly language, and to show how it is economical and practical to do so. Accordingly, this manual assumes that the reader has a good understanding of logic, but may be unfamiliar with programming concepts.

For those readers who do understand programming concepts, several features of the INTEL 4004 microcomputer are described below. They include:

- 4 bit parallel CPU on a single chip.
- 46 instructions, including conditional branching, subroutine capability, and binary and decimal arithmetic modes.
- Direct addressing for 32,768 bits of read-only memory, 5120 bits of data random-access memory and 32,768 bits of program random-access memory.
- Sixteen 4-bit index registers and a three 12-bit register stack.

INTEL 4004 microcomputer users will have widely differing programming needs. Some users may wish to write a few short programs, while other users may have extensive programming requirements.

For the user with limited programming needs, two system programs resident on the INTELLEC 4 (Intel's development system for the MCS-4 microcomputer) are provided; they are an Assembler and a System Monitor. Use of the INTELLEC 4 and its system programs is described in the INTELLEC 4 Operator's Manual.

For the user with extensive programming needs, cross assemblers are available which allow programs to be generated on a computer having a FORTRAN compiler whose word size is 32 bits or greater, limiting INTELLEC 4 use to final checkout of programs only.





## 2.0 COMPUTER ORGANIZATION

This section provides the programmer with a functional overview of the 4004 computer. Information is presented in this section at a level that provides a programmer with necessary background in order to write efficient programs.

To the programmer, the computer is represented as consisting of the following parts:

- (1) Sixteen working registers which serve as temporary storage for data, and provide the means for addressing memory.
- (2) The accumulator, in which data is processed.
- (3) Memories, which may hold program instructions or data (or sometimes both), and which must be addressed location by location in order to access stored information.
- (4) The stack, which is a device used to facilitate execution of subroutines, as described later in this section.
- (5) Input/Output, which is the interface between a program and the outside world.

## 2.1 WORKING REGISTERS (INDEX REGISTERS)

The 4004 provides the programmer with sixteen 4-bit registers. These may be referenced individually by the integers 0 through 15, or as 8 register pairs by the even integers from 0 through 14. The register pairs may also be referenced by the symbols 0P through 7P. These correspondences are shown as follows:

### INDIVIDUAL REGISTER REFERENCE

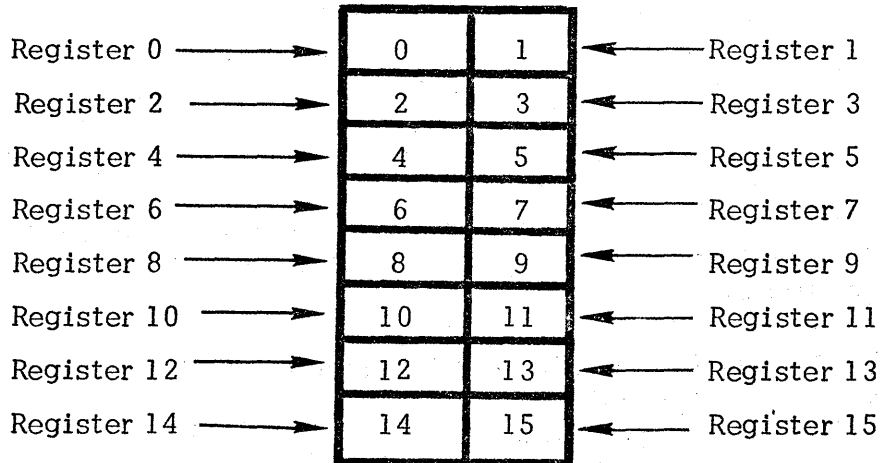

### REGISTER PAIR REFERENCE

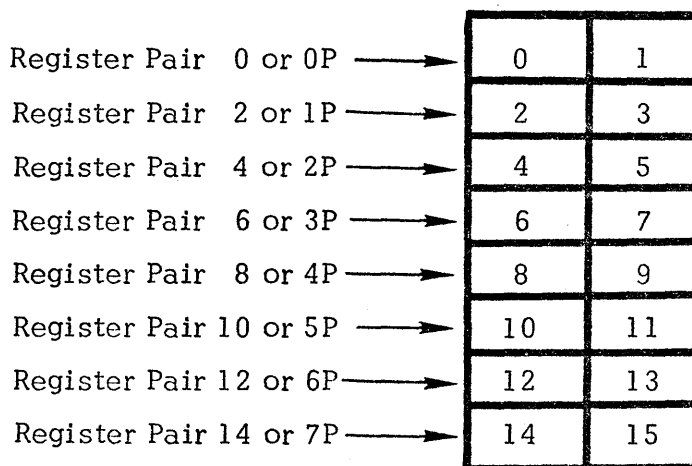

## 2.2 THE ACCUMULATOR

The accumulator is a special 4-bit register in which data may be transformed by program instructions.

## 2.3 MEMORIES

The 4004 can be used with three different types of memory which have different organizations and characteristics, and are used for different purposes. These are described below.

### 2.3.1 READ-ONLY MEMORY

Read-only memory (ROM) is used for storing program instructions and constant data which is never changed by the program. This is because the program can read locations in ROM, but can never alter (write) ROM locations.

ROM may be visualized as in Figure 2-1, as a sequence of bytes, each of which may store 8 bits (two hexadecimal digits). Up to 4096 bytes of ROM may be present, and an individual byte is addressed by its sequential number between 0 and 4095.

ROM is further divided into pages, each of which contains 256 bytes. Thus locations 0 through 255 comprise page 0 of ROM, location 256 through 511 comprise page 1 and so on.

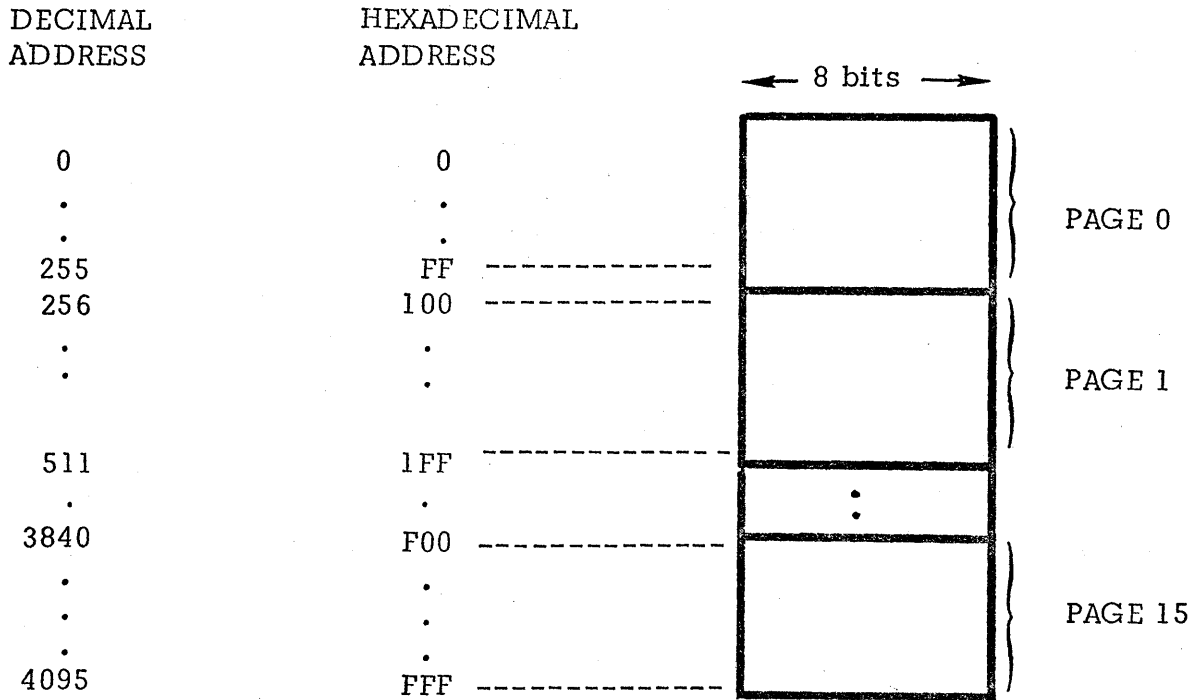

FIGURE 2-1.  
ROM ORGANIZATION

As described in Section 3, certain instructions function differently when located in the last byte (or bytes) of a page than when located elsewhere.

### 2.3.2 PROGRAM RANDOM ACCESS MEMORY

Program random access memory (RAM) is organized exactly like ROM. 4096 locations are always available, which are used to hold program instructions or data. Unlike ROM, however, program RAM locations can be altered by program instructions.

### 2.3.3 DATA RANDOM ACCESS MEMORY

As its name implies, data random access memory (DATA RAM) is used for the temporary storage of data by programs.

Figures 2-2 and 2-3 show how this memory is addressed:

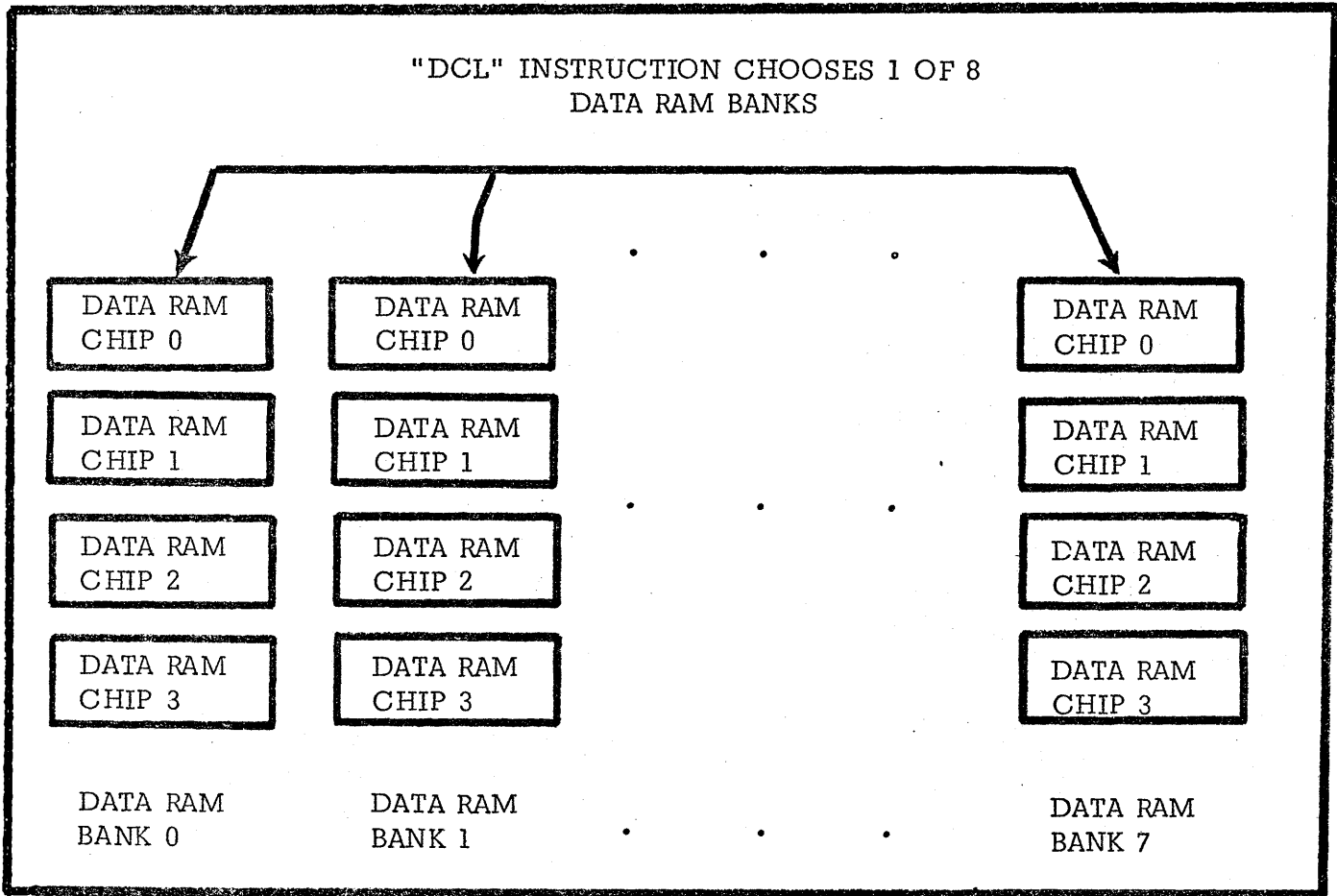

FIGURE 2-2.  
DATA RAM BANK ORGANIZATION.

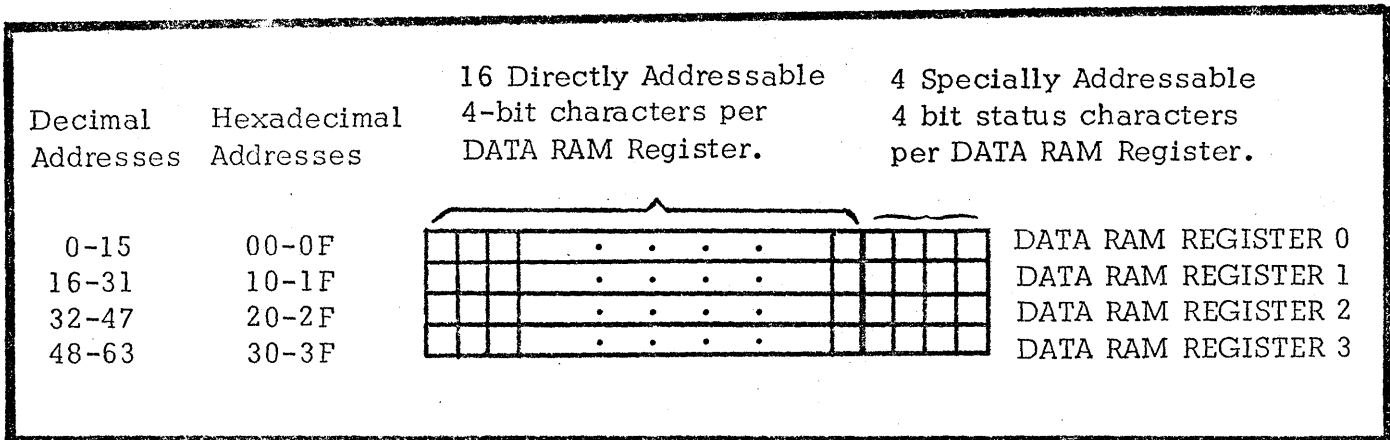

FIGURE 2-3.

DATA RAM CHIP 0 ORGANIZATION

In order to address a 4 bit character of DATA RAM, the programmer first uses a "DCL" instruction as described in Section 3.10.1 to choose one of a maximum of eight DATA RAM BANKS. An eight bit address is then sent via an "SRC" instruction as described in Section 3.10,2 which chooses one of four DATA RAM CHIPS within the DATA RAM BANK, one of four 16-character DATA RAM REGISTERS within the DATA RAM CHIP, and one of 16 4-bit characters within the DATA RAM REGISTER. Within any particular DATA RAM BANK, then, addresses 0-63 indicate which of the 64 directly addressable characters of DATA RAM CHIP 0 is to be addressed. Addresses 64-127 correspond to the characters of CHIP 1, addresses 128-191 correspond to CHIP 2, and addresses 192-255 correspond to CHIP 3.

In addition, each DATA RAM REGISTER has four 4-bit STATUS characters associated with it. These status characters may be read and written like the data characters, but are accessed by special instructions as described in Section 3.

## 2.4 THE STACK

The stack consists of three 12-bit registers used to hold addresses of program instructions. Since programs are always run in ROM or program RAM, the stack registers will always refer to ROM locations or program RAM locations.

Stack operations consist of writing an address to the stack, and reading an address from the stack. In order to understand these operations, it may be helpful to visualize the stack as three registers on the surface of a cylinder, as shown below:

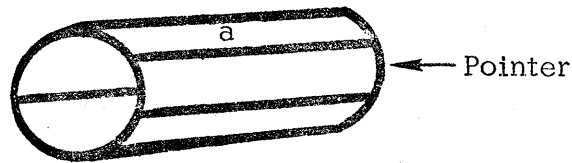

a represents an address

Each stack register is adjacent to the other two stack registers. The 4004 keeps a pointer to the next stack register available.

### Writing An Address To The Stack:

To perform a stack write operation;

- (1) The address is written into the register indicated by the pointer.
- (2) The pointer is advanced to the next sequential register.

Any register may be used to hold the first address written to the stack. More than three addresses may be written to the stack; however, this will cause a corresponding number of previously stored addresses to be overwritten and lost. This is illustrated in Figure 2-4.



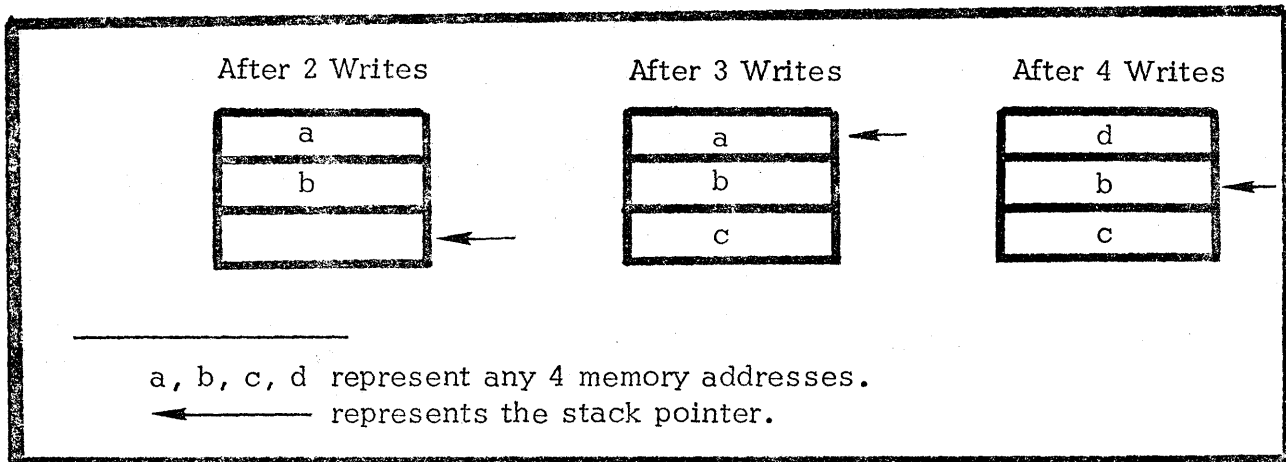

FIGURE 2-4.  
STACK WRITE OPERATIONS

Storing the fourth address (d) overwrites the first address stored (a).

Reading An Address From The Stack:

To perform a stack read operation;

- (1) The pointer is backed up one register.
- (2) The memory address indicated by the pointer is read.

The address read remains in the stack undisturbed. Thus, if 4 addresses are written to the stack and then three reads are performed, the stack will appear as in Figure 2-5.

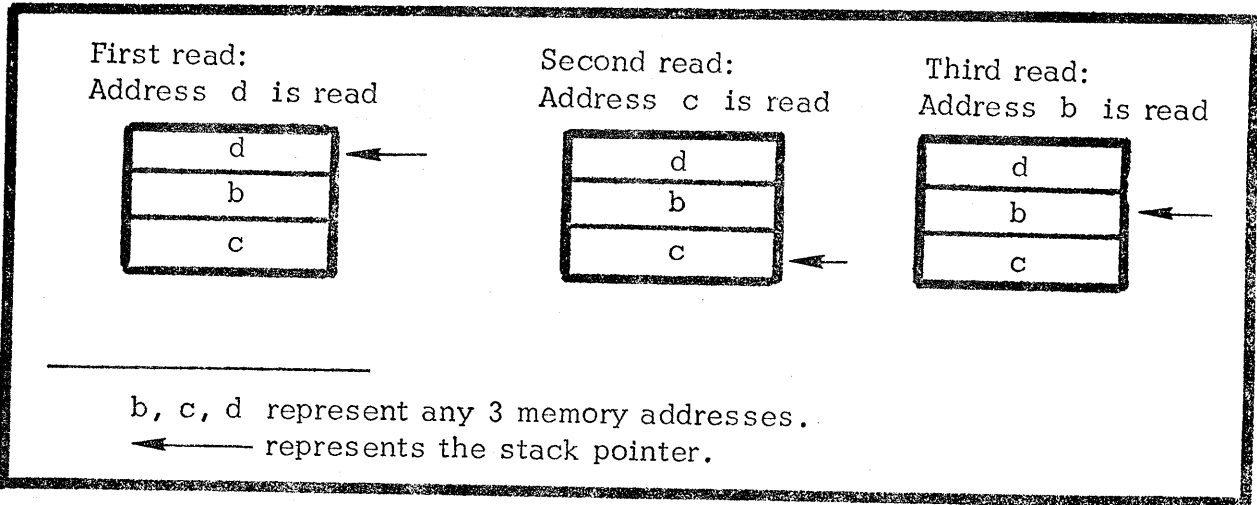

FIGURE 2-5.  
STACK READ OPERATIONS.

Section 2.7.7 describes how the stack is used by programs.

## 2.5 INPUT/OUTPUT

Programs communicate with the outside world via 4-bit input or output ports. The operation of these ports is controlled by special I/O instructions described in Section 3.

These ports are physically located on the same devices which hold ROMs and DATA RAMs; therefore, they are referred to as ROM ports or RAM ports. These are totally separate from the instruction or data locations provided in ROM or RAM, and should not be confused with them. The ports associated with RAMs may be used only for output.

## 2.6 COMPUTER PROGRAM REPRESENTATION IN MEMORY

A computer program consists of a sequence of instructions. Each instruction performs an elementary operation such as the movement of data, an arithmetic operation on data, or a change in instruction execution sequence. Instructions are described individually in Section 3.

A program will be stored in Read-Only Memory or Program Random Access Memory. It will appear as a sequence of hexadecimal digits which represent the instructions of the program. The memory address of the instruction being executed is recorded in a 12-bit register called the Program Counter, and thus it is possible to track a program as it is being executed. After each instruction is executed, the program counter is advanced to the address of the next instruction. Program execution proceeds sequentially unless a transfer-of-control instruction (jump or skip) is executed, which causes the program counter to be set to a specified address. Execution then continues sequentially from this new address in memory.

Upon examining the contents of a ROM or program RAM memory location, there is no way of telling whether a byte contains an encoded instruction or constant data. For example, the hexadecimal code F2 has been selected to represent the instruction IAC (increment accumulator). Thus, the hex value F2 stored in a memory byte could represent either the instruction IAC or the hex data value F2.

It is up to the programmer to insure that data is not misinterpreted as an instruction code, but this is simply done as follows:

Every program has a starting memory address, which is the memory address of the location holding the first instruction to be executed. Just before the first instruction is executed, the program counter will automatically be set to this address, and this procedure will be repeated for every instruction in the program. 4004 instructions may require 8 or 16 bits for their encoding; in each case the program counter is set to the corresponding address as shown in Figure 2-6.

MEMORY ADDRESS (Hexadecimal)		INSTRUCTION NUMBER	PROGRAM COUNTER CONTENTS (Hexadecimal)
13A		1	13A
13B		2	13B
13C			
13D		3	13D
13E			
13F		4	13F
140		5	140
141			

FIGURE 2-6.

PROGRAM COUNTER CONTENTS AS INSTRUCTIONS ARE EXECUTED.

In order to avoid errors, the programmer must be sure that a byte of constant data does not follow an instruction when another instruction is expected. Referring to Figure 2-6, an instruction is expected in location 13FH, since instruction 4 is to be executed after instruction 3. If location 13FH held constant data, the program would not execute correctly. Therefore, when writing a program, do not place constant data in between adjacent instructions that are to be executed consecutively.

A class of instructions (referred to as transfer-of-control instructions) cause program execution to branch to an instruction other than the next sequential instruction. The memory address specified by the transfer of control instruction must be the address of another instruction; if it is the address of a memory location holding data, the program will not execute correctly. For example, referring to Figure 2-6, suppose instruction 2 specifies a jump to location 140H, and instructions 3 and 4 were replaced by data. Then following execution of instruction 2, the program counter would be set to 140H and the program would execute correctly. But if, in error, instruction 2 were to specify a jump to 13EH, an error would result since this location now holds data. Even if instructions 3 and 4 were not altered, a jump to location 13EH would cause an error, since this is not the first byte of the instruction.

Upon reading Section 3, you will see that it is easy to avoid writing an assembly language program with jump instructions which have erroneous memory addresses. Information on this subject is given here rather to help the programmer who is debugging programs by entering hexadecimal codes directly into program RAM (Programs usually exist in ROM, and therefore cannot be altered in this manner).

## 2.7 MEMORY ADDRESSING

By now it will have become apparent that addressing specific memory bytes constitutes an important part of any computer program. There are a number of ways in which this can be done, as described in the following subsections.

### 2.7.1 DIRECT ADDRESSING

With direct addressing, as the name implies, an instruction provides an exact memory address. The following instruction provides an example of direct addressing:

"Jump to location 3A2H"

This instruction is represented by 4 hexadecimal digits in ROM or program RAM. The first digit is a 4, signifying a jump instruction, while the final 3 digits specify the address.

This instruction would appear in memory as follows:

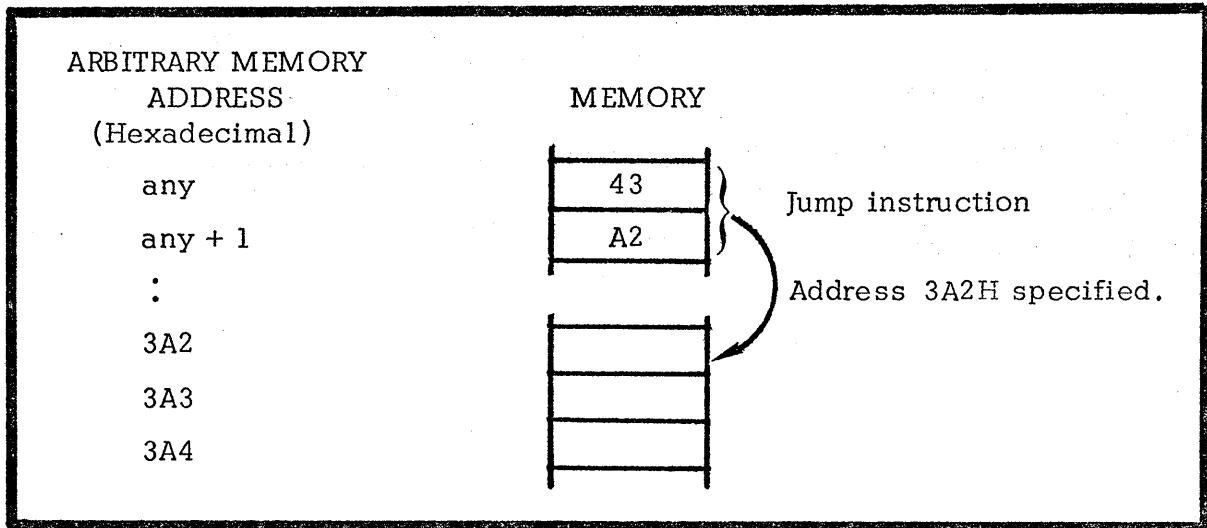

## 2.7.2 SAME PAGE ADDRESSING

Some instructions supply two hexadecimal digits which replace the lowest 8 bits of the program counter, addressing a ROM or program RAM location on the same page as the instruction being executed. (Two addresses are on the same page if the highest order hexadecimal digit of their addresses are equal. See Section 2.3.1).

The following instruction provides an example of same page addressing:

"Jump on condition 2 to location 3BH of this page."

This instruction would appear in memory as follows:

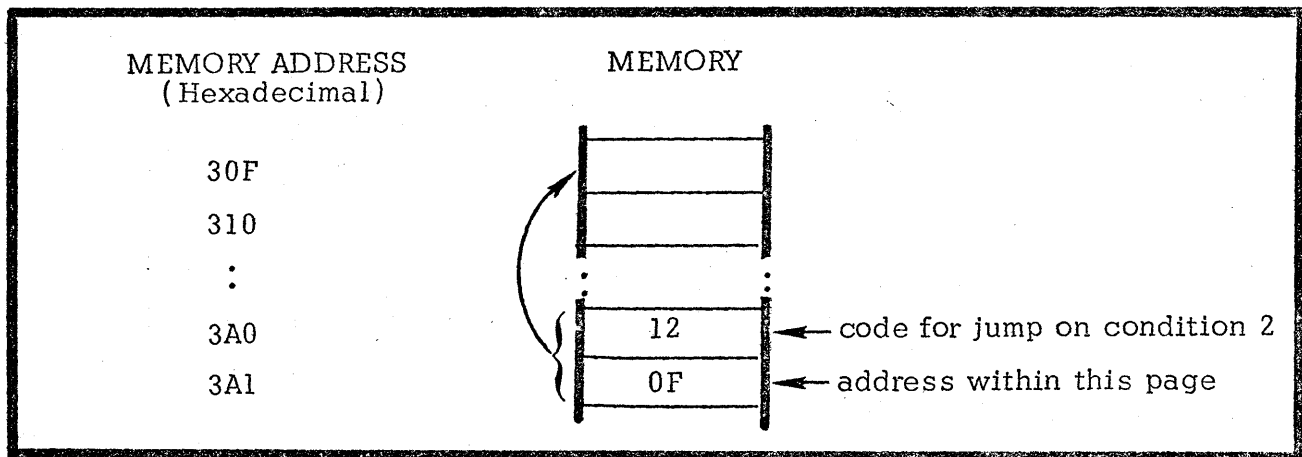

The identical encoding 120FH if located at location 501H, would cause a jump to memory address 50FH.

### 2.7.3 INDIRECT ADDRESSING

With indirect addressing, an instruction specifies a register pair which in turn holds an 8 bit value used for same page addressing (Section 2.7.2). Suppose that registers 4 and 5 hold the 4-bit hexadecimal numbers 1 and B, respectively. Then the instruction:

"Jump indirect to contents of register pair 4"

would appear as follows:

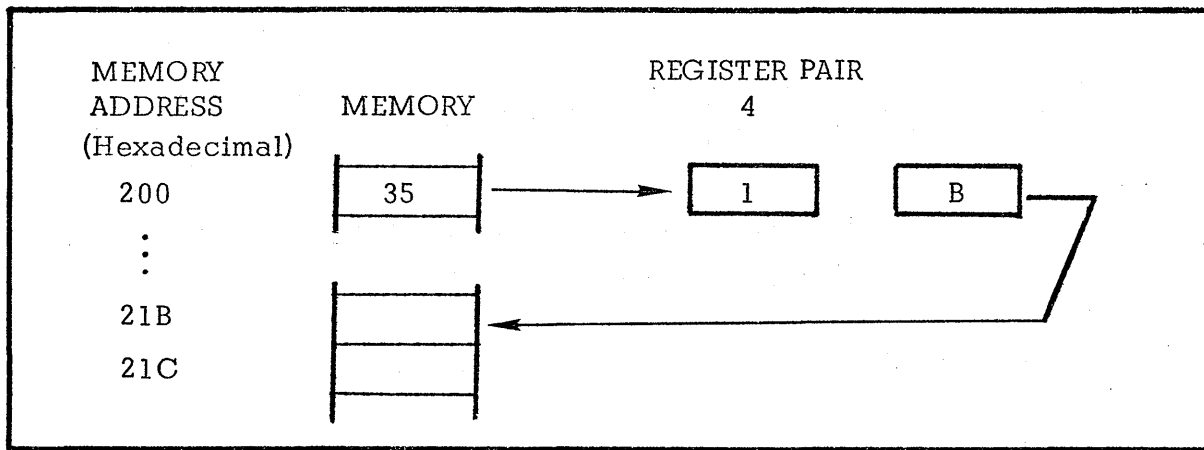

The 3 indicates a "jump indirect" instruction; the 5 indicates that the address indicated on this page is held in register pair 4. If register pair 4 had held the hex numbers 3 and C, a jump to location 23CH would have occurred.



#### 2.7.4 IMMEDIATE ADDRESSING

An immediate instruction is one that provides its own data. The following is an example of immediate addressing:

"Load the accumulator with the hexadecimal number 3".

This instruction would be coded in memory as follows:

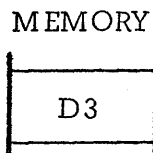

The digit D signifies a "load accumulator immediate" instruction; the digit 3 is the number to be loaded.

#### 2.7.5 PROGRAM RAM ADDRESSING

When a program stores an 8 bit value into a program RAM location a special sequence of instructions must be used as described in Section 3.11.10 (the WPM instruction).

#### 2.7.6 DATA RAM ADDRESSING

To address a location in DATA RAM, the DCL and SRC instructions must be used as described in Sections 2.3.3, 3.10.1, and 3.10.2. When the DCL has chosen a specific DATA RAM bank, the address of the specific character is held in a register pair accessed by the SRC instruction.

### 2.7.7 SUBROUTINES AND USE OF THE STACK FOR ADDRESSING

Before understanding the purpose or effectiveness of the stack, it is necessary to understand the concept of a subroutine.

Consider a frequently used operation such as addition. The 4004 provides instructions to add one character of data to another, but what if you wish to add numbers outside the range of 0 to 15 (the range of one character)? Such addition will require a number of instructions to be executed in sequence. It is quite possible that this addition routine may be required many times within one program; to repeat the identical code every time it is needed is possible, but very wasteful of memory:

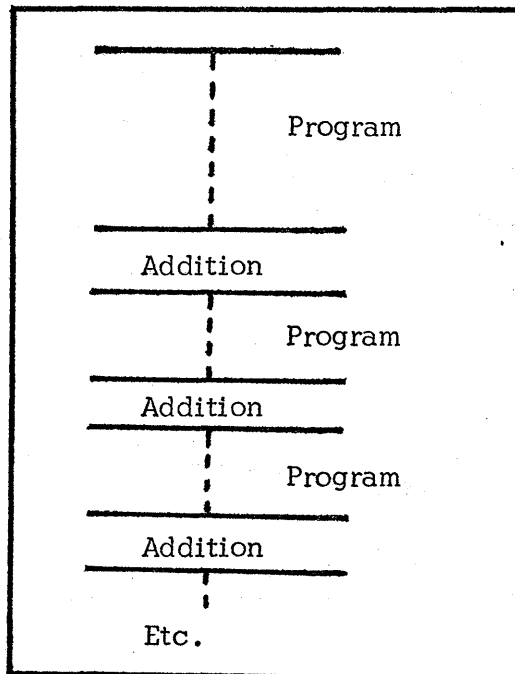

A more efficient means of accessing the addition routine would be to store it once, and find a way of accessing it when needed:

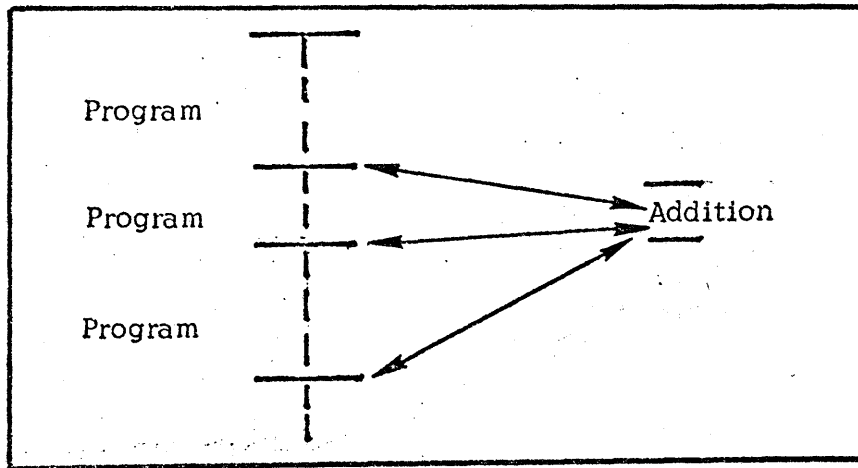

A frequently accessed routine such as the addition above is called a subroutine, and the 4004 provides instructions that call subroutines and return from subroutines.

When a subroutine is executed, the sequence of events may be depicted as follows:

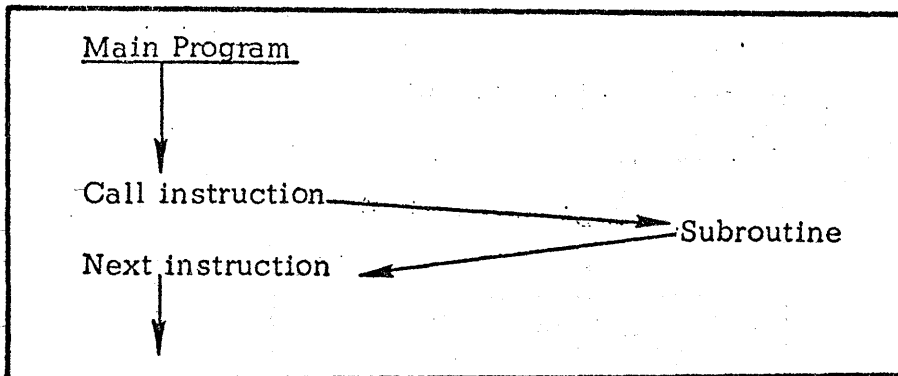

The arrows indicate the execution sequence.

When the "Call" instruction is executed, the address of the "next" instruction is written to the stack (see Section 2.4), and the subroutine is executed. The last executed instruction of a subroutine will always be a special "Return Instruction", which reads an address from the stack into the program counter, and thus causes program execution to continue at the "Next" instruction as illustrated on the next page.

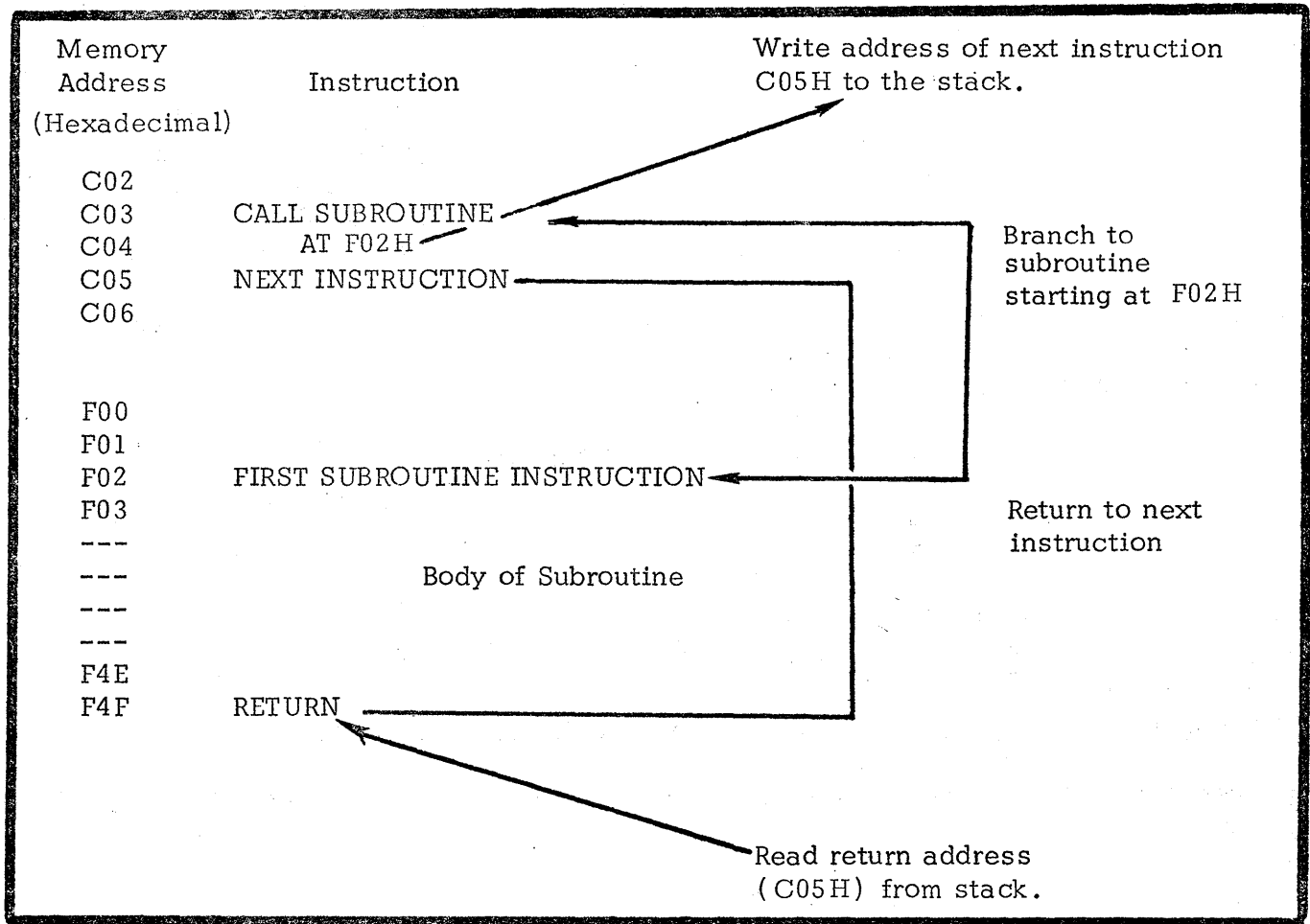

Since the stack provides three registers, subroutines may be nested up to three deep; for example, the addition subroutine could itself call some other subroutine, and so on. An examination of the sequence of write and read stack operations will show that the return path will always be identical to the call path, even if the same subroutine is called at more than one level; however, an attempt to nest subroutines to a depth of more than 3 will cause the program to fail, since some addresses will have been overwritten.

## 2.8 CARRY BIT

To make programming easier, a carry bit is provided by the 4004 to reflect the results of data operations. The descriptions of individual instructions in Section 3 specify which instructions affect the carry bit and whether the execution of the instruction is dependent in any way on the prior status of the carry bit. The carry bit is "set" if 1 and "reset" if 0.

Certain data operations can cause an overflow out of the high-order 3-bit. For example, addition of two hexadecimal digits can give rise to an answer that does not fit in one digit:

	3	2	1	0	Bit Number
A	1	0	1	0	
+7		0	1	1	
				<u>1</u>	
	1		0	0	
	└─┘				Carry = 1

An operation that results in a carry out of bit 3 will set the carry bit.

An operation that could have resulted in a carry out of bit 3 but did not will reset the carry bit.

### 3.0 THE 4004 INSTRUCTION SET

This section describes the 4004 assembly language instruction set.

For the reader who understands assembly language, Appendix A provides a complete summary of the 4004 instructions.

For the reader who is not completely familiar with assembly language, this section describes individual instructions with examples and machine code equivalents.

#### 3.1 ASSEMBLY LANGUAGE

##### 3.1.1 HOW ASSEMBLY LANGUAGE IS USED

Upon examining the contents of read-only memory or program random-access memory, a program would appear as a sequence of hexadecimal digits which are interpreted by the machine as instruction codes, addresses, or constant data. It is possible to write a program as a sequence of digits (just as they appear in memory), but that is slow and expensive. For example, several instructions reference memory to address another instruction:

<u>HEXADECIMAL MEMORY ADDRESS</u>	
332	F0
333	43
334	56
.	.
.	.
.	.
354	20
355	FF
356	60

The above program operates as follows:

Byte 332H specifies that the accumulator and carry bit are to be cleared.

Bytes 333H and 334H specify that program execution is to continue at location 356H.

Byte 356H specifies that register 0 is to be incremented.

Now suppose that an error discovered in the program logic necessitates placing a new instruction after byte 332H. Program code would have to change as follows:

<u>HEXADECIMAL MEMORY ADDRESS</u>	<u>OLD CODE</u>	<u>NEW CODE</u>
332	F0	F0
333	43	New Instruction
334	56	43
335		57
.		
.		
354	20	
355	FF	20
356	60	FF
357		60

Note that many instructions have been moved and as a result some must be changed to reflect the new addresses of instructions. The potential for making mistakes is very high and is aggravated by the complete unreadability of the program.

Writing programs in assembly language is the first and most significant step towards economical programming; it provides a readable notation for instructions, and separates the programmer from a need to know or specify absolute memory addresses.

Assembly language programs are written as a sequence of instructions which are converted to executable hexadecimal code by a special program called an ASSEMBLER.

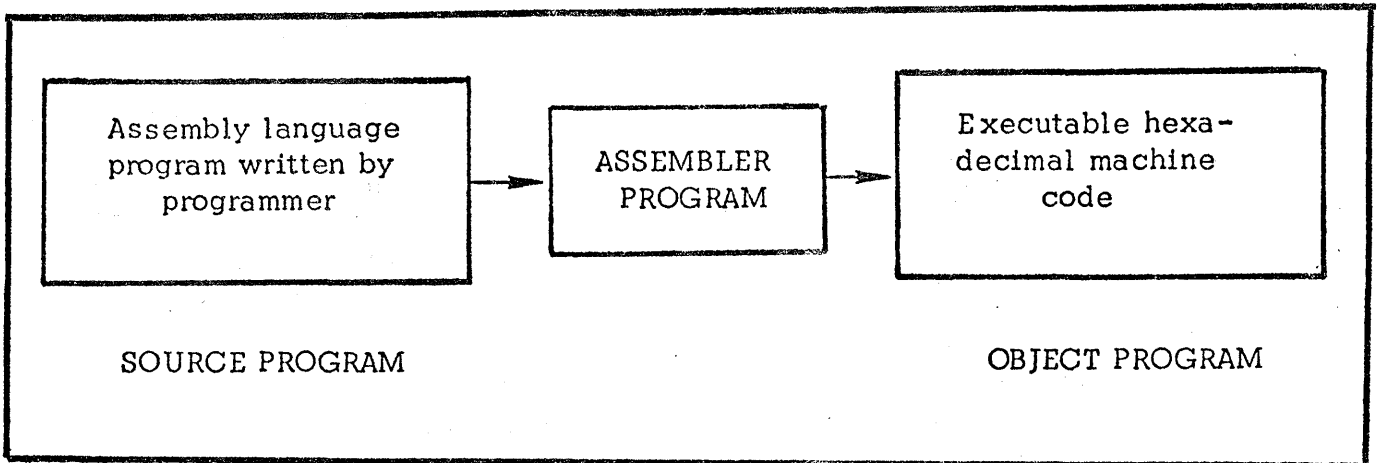

FIGURE 3-1.

ASSEMBLER PROGRAM CONVERTS ASSEMBLY LANGUAGE SOURCE PROGRAM TO HEXADECIMAL OBJECT PROGRAM

As illustrated in Figure 3-1, the assembly language program generated by a programmer is called a SOURCE PROGRAM. The assembler converts the SOURCE PROGRAM into an equivalent OBJECT PROGRAM, which consists of a sequence of hexadecimal codes that can be loaded into ROM or program RAM and executed.

For example:

<u>Source Program</u>	is converted by the Assembler to	One Possible Version of the <u>Object Program</u>
NOW, CLB		F0
JUN NXT		4356
:		:
:		:
FIM 0 255		20FF
NXT, INC 0		60



Now if a new instruction must be added, only one change is required. Even the reader who is not yet familiar with assembly language will see how simple the addition is:

```
NOW,   CLB
        (New instruction inserted here)
        JUN   NXT
        :
        FIM   0 255
NXT,   INC   0
```

The assembler takes care of the fact that a new instruction will shift the rest of the program in memory.

### 3.1.2 STATEMENT MNEMONICS

Assembly language instructions must adhere to a fixed set of rules as described in this section. An instruction has four separate and distinct parts or FIELDS.

Field 1 is the LABEL field. It is the instruction location's label or name, and it is used to reference the instruction.

Field 2 is the CODE field. It defines the operation that is to be performed by the instruction.

Field 3 is the OPERAND field. It provides any address or data information needed by the CODE field.

Field 4 is the COMMENT field. It is present for the programmer's convenience and is ignored by the assembler. The programmer uses comment fields to describe the operation and thus make the program more readable.

The assembler uses free fields; that is, any number of blanks may separate fields.

Before describing each field in detail, here are some general examples:

<u>LABEL</u>	<u>CODE</u>	<u>OPERAND</u>	<u>COMMENT</u>
CMI,	CLB		/ Clear accumulator and carry.
LAB,	INC	3	/ Increment register 3.
	JUN	CMI	/ Jump to instruction CMI.
FCH,	FIM	0P 255	/ Load hex FF (decimal 255) into / register pair 0.

### 3.1.3 LABEL FIELD

This is an optional field. If present, the first character of a label must be a letter of the alphabet. The remaining characters may be letters or decimal digits. The label field must end with a comma, immediately following the last character of the label. Labels may be any length, but should be unique in the first three characters; the assembler cannot always distinguish between labels whose first three characters are identical. If no label is present, at least one blank must begin the line.

Here are some examples of valid label fields:

```
CM0,  
NUL,  
EGO,
```

Here are some invalid labels:

```
4GE,   does not begin with a letter.  
AGE    valid label, but label field does not end with a comma.  
A/A,   contains invalid character.
```

The following label has more than 3 characters:

```
STROB
```

The assembler may not be able to differentiate this label from others beginning with the characters STR.

Since labels serve as instruction addresses, they cannot be duplicated. For example, the sequence:

NOW,	JUN	NXT
	---	
	---	
NXT,	INC	2
	---	
	---	
NXT,	CLB	

is ambiguous; the assembler cannot determine which NXT address is referenced by the JUN instruction.

#### 3.1.4 CODE FIELD

This field contains a code which identifies the machine operation (add, subtract, jump, etc.) to be performed: hence the term operation code or op-code. The instructions described in Sections 3.3 thru 3.11, are each identified by a mnemonic label which must appear in the code field. For example, since the "jump unconditionally" instruction is identified by the letters "JUN", these letters must appear in the code field to identify the instruction as "jump unconditionally".

There must be at least one space following the code field. Thus:

```
LAB, JUN AWY
```

is legal, but:

```
LAB, JUNAWY
```

is illegal.

### 3.1.5 OPERAND FIELD

This field contains information used in conjunction with the code field to define precisely the operation to be performed by the instruction. Depending upon the code field, the operand field may be absent or may consist of one item or two items separated by blanks.

There are five types of information [(a) through (e) below] that may be requested as items of an operand field, and the information may be specified in five ways [(1) through (5) below].

The five ways of specifying information are as follows:

- (1) A decimal number.

Example:

<u>LABEL</u>	<u>CODE</u>	<u>OPERAND</u>	<u>COMMENT</u>
ABC,	LDM	14	/Load accumulator with decimal /14 (1110 binary).

- (2) The current program counter. This is specified as the character '\*' and is equal to the address of the first byte of the current instruction.

Example:

<u>LABEL</u>	<u>CODE</u>	<u>OPERAND</u>
GO,	JUN	*+6

If the instruction above is being assembled at location 213, it will cause program control to be transferred to address 219.

- (3) Labels that have been assigned a decimal number by the assembler.  
(See Section 3.12.1 for the equate procedure).

Example:

Suppose label VAL has been equated to the number 42, and ZER has been equated to the number 0. Then the following instructions all load register pair zero with the hexadecimal value 2A (decimal 42):

<u>LABEL</u>	<u>CODE</u>	<u>OPERAND</u>
A1,	FIM	0 42
A2,	FIM	ZER 42
A3	FIM	ZER VAL

- (4) Labels that appear in the label field of another instruction.

Example:

<u>LABEL</u>	<u>CODE</u>	<u>OPERAND</u>	<u>COMMENT</u>
LP1,	JUN	LP2	/Jump to instruction at LP2.
	---		
	---		
LP2,	CMA		

- (5) Arithmetic expressions involving data types (1) to (4) above connected by the operators + (addition) and - (subtraction). These operators treat their arguments as 12-bit quantities, and generate 12-bit quantities as their result. If a value is generated which exceeds the number of bits available for it in an instruction, the value is truncated on the left.

For example, if VAL refers to hexadecimal address FFE, the instruction:

JUN VAL

is encoded as 4FFE<sub>H</sub>; a 4-bit operation code and 12 bit value. However, the instruction:

JUN VAL + 9

will be encoded as 4007<sub>H</sub>, where the value 1007<sub>H</sub> has been truncated on the left to 12 bits (three hex digits) giving a value of 007<sub>H</sub>.

Using some or all of the above data specifications, the following five types of information may be requested:

- (a) A register to serve as the source or destination in a data operation. Methods 1, 3, or 5 may be used to specify the register, but the specification must finally evaluate to one of the decimal numbers 0 to 15.

Example:

<u>LABEL</u>	<u>CODE</u>	<u>OPERAND</u>
I1,	INC	4
I2,	INC	R4
I3,	INC	16-12

Assuming label R4 has been equated to 4, all the above instructions will increment register 4.

- (b) A register pair to serve as the source or destination in a data operation. The specification must evaluate to one of the even decimal numbers from 0 through 14 (corresponding to register pair designators 0P through 7P).

Example:

<u>LABEL</u>	<u>CODE</u>	<u>OPERAND</u>
I1,	SRC	1P
I2,	SRC	2
I3,	SRC	RG2

Assuming label RG2 has been equated to 2, all of the above instructions refer to register pair 1P (registers 2 and 3).

- (c) Immediate data, to be used directly as a data item.

Example:

<u>LABEL</u>	<u>CODE</u>	<u>OPERAND</u>	<u>COMMENT</u>
AC1,	LDM	DATA	/Load the accumulator with /the value of DATA.

DATA could take any of the following forms:

19

12 + 72 - 3

VAL (where VAL has been equated to a number).

(d) A 12 bit address, or the label of another location in memory.

Example:

<u>LABEL</u>	<u>CODE</u>	<u>OPERAND</u>	<u>COMMENT</u>
HR,	JUN	OVR	/Jump to instruction at OVR.
	JUN	513	/Jump to hex address 201 (decimal 513).

(e) A condition code for use by the JCN (jump on condition) instruction.  
This must evaluate to a number from 0 to 15.

Example:

<u>LABEL</u>	<u>CODE</u>	<u>OPERAND</u>
	JCN	4 LOC
	JCN	2+2 LOC

The above instructions cause program control to be transferred to address LOC if condition 4 (accumulator zero) is true.

### 3.1.6 COMMENT FIELD

The only rule governing this field is that it must begin with a slash (/). It is terminated by the end of the line.

A comment field may appear alone on a line:

```
LOC,    CLB    /This is a comment  
/This is a comment line
```



## 3.2 DATA STATEMENTS

This section describes ways in which data can be specified in and interpreted by a program. Any 4 bit character in DATA RAM contains one of the 16 possible combinations of zeros and ones.

Arithmetic instructions assume that the DATA RAM characters upon which they operate are in a special format called "two's complement", and the operations performed on these bytes are called "two's complement arithmetic".

### 3.2.1 TWO'S COMPLEMENT

When a character is interpreted as a signed two's complement number, the low order 3 bits supply the magnitude of the number, while the high order bit is interpreted as the sign of the number (0 for positive numbers, 1 for negative).

The range of positive numbers that can be represented in signed two's complement notation is, therefore, from 0 to 7:

0	=	0 0 0 0 B
1	=	0 0 0 1 B
		⋮
6		0 1 1 0 B
7		0 1 1 1 B

To change the sign of a number represented in two's complement, the following rules are applied:

- (a) Invert each bit of the number (producing the so-called one's complement).
- (b) Add one to the result, ignoring any carry out of the high order bit position.

Example: Produce the two's complement representation of -6.  
Following the rules above,

+6 = 0 1 1 0 B

Invert each bit: 1 0 0 1 B

Add one : 1 0 1 0 B

Therefore, the two's complement representation of -6 is the hexadecimal number 'A'. (Note that the sign bit is set, indicating a negative number.)

Example: What is the value of the hexadecimal number 'C' interpreted as a signed two's complement number? The high order bit is set, indicating that this is a negative number. To obtain its value, again invert each bit and add one. (This is equivalent to subtracting one from the number and inverting each bit).

```

      CH   =   1 1 0 0 B
Invert each bit   :   0 0 1 1 B
Add one          :   0 1 0 0 B
  
```

Thus, the value of CH is -4.

The range of negative numbers that can be represented in signed two's complement notation is from -1 to -8.

```

-1   =   1 1 1 1 B
-2   =   1 1 1 0 B
      :
      :
-7   =   1 0 0 1 B
-8   =   1 0 0 0 B
  
```

To perform the subtraction 6-3, the following operations are performed:

Take the two's complement of 3 = 1101B

Add the result to the minuend:

```

      6 = 0 1 1 0 B
+ (-3) = 1 1 0 1 B
-----
      0 0 1 1 B = 3, the correct answer
  
```

When a data character is interpreted as an unsigned two's complement number, its value is considered positive and in the range 0 to 15.

```

0 = 0 0 0 0 B
1 = 0 0 0 1 B
  :
7 = 0 1 1 1 B
8 = 1 0 0 0 B
  :
15 = 1 1 1 1 B
  
```

Two's complement arithmetic is still valid. When performing an addition operation, the carry bit is set when the result is greater than 15. When performing subtraction, the carry bit is set when the result is positive. If the carry bit is reset, the result is negative and present in its two's complement form.

Example: Subtract 3 from 10 using unsigned two's complement arithmetic.

$$\begin{array}{r}
 10 = 1\ 0\ 1\ 0\ B \\
 -3 = \underline{1\ 1\ 0\ 1\ B} \\
 \hline
 1\ | \ 0\ 1\ 1\ 1\ B \\
 \swarrow \\
 \text{Carry} = 1
 \end{array}$$

Since the carry bit is set, the result (7) is correct and positive.

Example: Subtract 15 from 12 using unsigned two's complement arithmetic.

$$\begin{array}{r}
 12 = 1\ 1\ 0\ 0\ B \\
 -15 = \underline{0\ 0\ 0\ 1\ B} \\
 \hline
 0\ | \ 1\ 1\ 0\ 1\ B = -3 \\
 \swarrow \\
 \text{Carry} = 0
 \end{array}$$

Since the carry bit is reset, the result is negative and in its two's complement form.

### WHY TWO'S COMPLEMENT?

Using two's complement notation for negative numbers, any subtraction problem becomes a sequence of bit inversions and additions. Therefore, fewer circuits are needed to perform subtraction.

### 3.2.2 CONSTANT DATA

Eight-bit data values can be assembled into ROM or program RAM locations by writing a blank code field and an operand field beginning with a positive number. If the operand is greater than 8 bits, it will be truncated on the left.

Example: Assume that label VAL has been equated to 14, and the label LOC appears on an instruction assembled at hexadecimal location 34B.

<u>LABEL</u>	<u>CODE</u>	<u>OPERAND</u>	<u>ASSEMBLED DATA</u>
C1,		0+VAL	0E
C2,		4095	FF
C3,		0+LOC	4B

The following are invalid data statements:

<u>LABEL</u>	<u>CODE</u>	<u>OPERAND</u>	<u>COMMENT</u>
C4,		ABC	/Does not begin with a number.
C5,		-18	/Number is not positive.

### 3.3 INDEX REGISTER INSTRUCTIONS

This section describes two instructions which involve index registers or register pairs.

These instructions occupy one byte as follows:

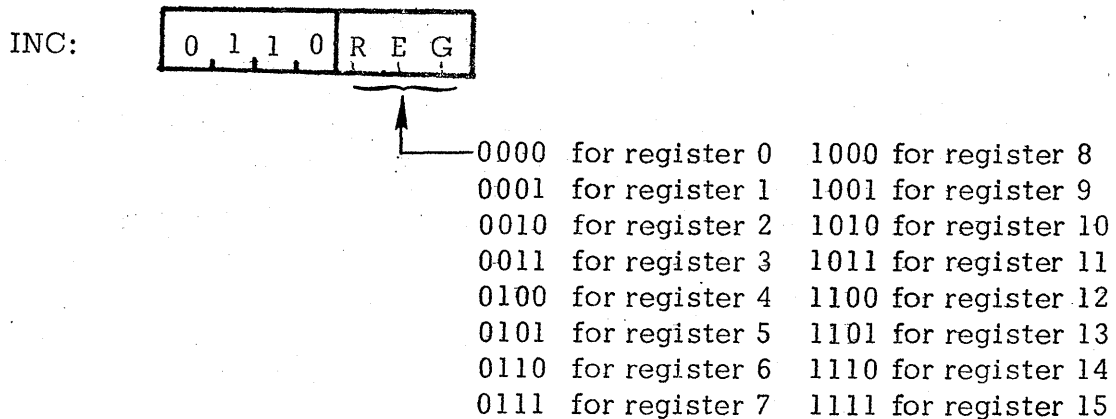
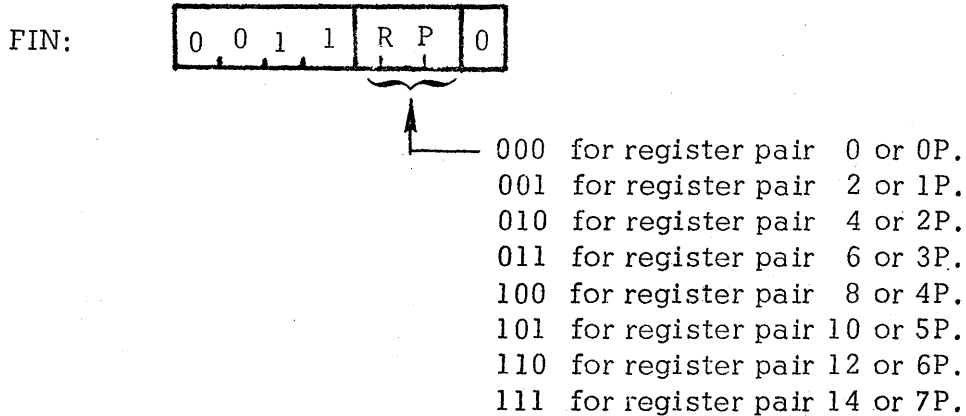

### 3.3.1 INC INCREMENT REGISTER

Format:

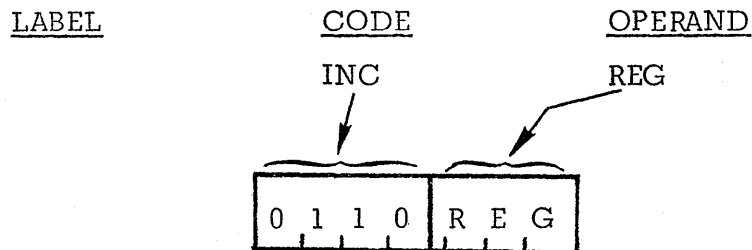

Description:

The index register indicated by REG is incremented by one.

The carry bit is not affected.

Example: If register 3 contains the number 6, the instruction:

INC 3

will cause register 3 to contain the number 7.

If register 8 contains the number 15 (1111 binary), the instruction:

INC 8

will cause register 8 to contain 0, leaving the carry bit unchanged.

### 3.3.2 FIN FETCH INDIRECT

Format:

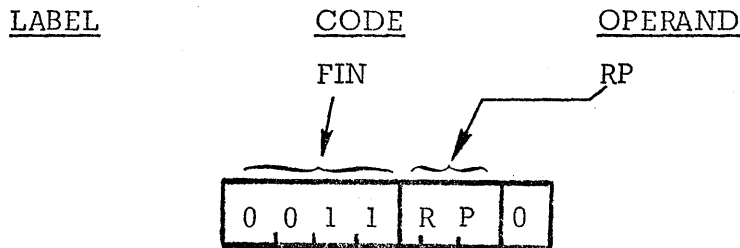

Description:

The contents of registers 0 and 1 are concatenated to form the lower 8 bits of a ROM or program RAM address. The upper 4 bits of the address are assumed equal to the upper 4 bits of the address at which the FIN instruction is located (that is, the address of the FIN instruction and the address referenced by register 0 and 1 are on the same page). The 8 bits at the designated address are loaded into the register pair specified by RP. The 8 bits at the designated address are unaffected; the contents of registers 0 and 1 are unaffected unless RP = 0.

The carry bit is not affected.

Example: Suppose a program in memory appears as follows:

DECIMAL ADDRESS	HEXADECIMAL ADDRESS	INSTRUCTION	ASSEMBLED DATA
603	25B	110	6E
⋮	⋮	⋮	⋮
681	2A9	FIN 7P	3E

If register 0 contains the hex digit 5 and register 1 contains the hex digit B when the FIN instruction is executed, the 8 bits located at hex address 25B will be loaded into register pair 7P. Thus register 14 will contain the hex digit 6 (0110 binary) and register 15 will contain the hex digit E (1110 binary).

If registers 0 and 1 had contained CH and 4 when the FIN was executed, the 8 bits at hex address 2C4 would have been loaded into registers 14 and 15.

NOTE: If a FIN instruction is located in the last location of a page, the upper 4 bits of the designated address will be assumed equal to the upper 4 bits of the next page.

Thus if the instruction:

FIN . . . 7P

is located at decimal address 511 (hex 1FF) and registers 0 and 1 contain 3 and CH, the 8 bits at hex address 23C (not 13C) will be loaded into registers 14 and 15.

This is dangerous programming practice and should be avoided whenever possible.



3.4 INDEX REGISTER TO ACCUMULATOR INSTRUCTIONS

This section describes instructions which involve an operation between an index register and the accumulator. Instructions in this class occupy one byte as follows:

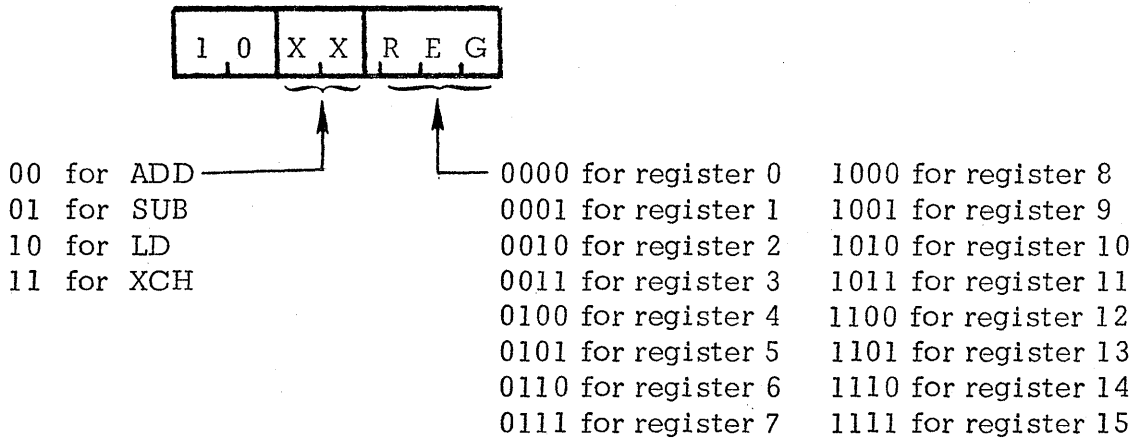

The general assembly language instruction format is:

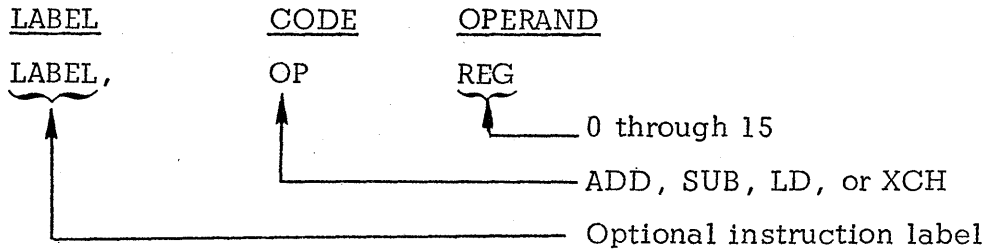

### 3.4.1 ADD ADD REGISTER TO ACCUMULATOR WITH CARRY

Format:

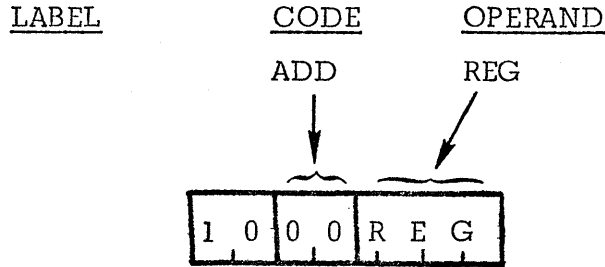

Description:

The contents of the index register REG plus the contents of the carry bit are added to the accumulator. The result is kept in the accumulator; the contents of REG are unchanged. The carry bit is set if there is a carry out of the high-order bit position, and reset if there is no carry.

Example:

Suppose the accumulator contains 6, register 14 contains 9, and the carry bit = 0.

Then the instruction:

ADD 14

will perform the following operation:

Accumulator	=	0 1 1 0 B	
Register 14	=	1 0 0 1 B	
Carry	=	0	
		0	
		1 1 1 1 B	= Result = 15
		↑	= Carry

The accumulator contains 15 and the carry bit is reset. If the carry bit had been one at the start of the previous operation, the following would have occurred:

```

Accumulator   = 0110 B
Register 14   = 1001 B
Carry         =      1
              -----
1 | 0000 B = Result = 0
↑
          = Carry

```

The accumulator would contain 0, while the carry bit would be set.

### 3.4.2 SUB SUBTRACT REGISTER FROM ACCUMULATOR WITH BORROW

Format:

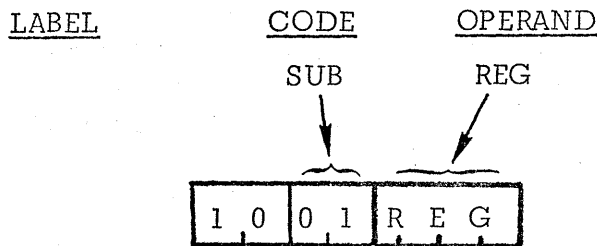

Description:

The contents of index register REG are subtracted with borrow from the accumulator. The result is kept in the accumulator; the contents of REG are unchanged. A borrow from the previous subtraction is indicated by the carry bit being equal to one at the beginning of this instruction. If the carry bit equals zero at the beginning of this instruction it is assumed that no borrow occurred from the previous subtraction.

This instruction sets the carry bit if there is no borrow out of the high order bit position, and resets the carry bit if there is a borrow.

The subtract with borrow operation is actually performed by complementing each bit of the contents of REG and adding the resulting value plus the complement of the carry bit to the accumulator.

Note: This instruction may be used to subtract numbers greater than 4 bits in length. The carry bit must be complemented by the program between each required subtraction operation. For an example of this, see Section 4.8.

Example: In order to perform a normal subtraction, the carry bit should = 0. Suppose the accumulator contains 6, register 10 contains 2, and the carry bit = 0. Then the instruction:

SUB 10

will perform the following operation:

Accumulator	=	0110 B
Register 10 = 0010		
Complemented	=	1101 B
Complement of carry	=	<u>1</u>
		1   0100 B = Result = 4

↙ Carry = 1 indicating no borrow

Had the carry bit been = 1, the operation would have produced the following:

Accumulator	10	=	0110 B
Complement of register 14		=	1101 B
Complement of carry		=	<u>0</u>
			1   0011 B Result = 3

↙ Carry = 1 indicating no borrow.

### 3.4.3 LD LOAD ACCUMULATOR

Format:

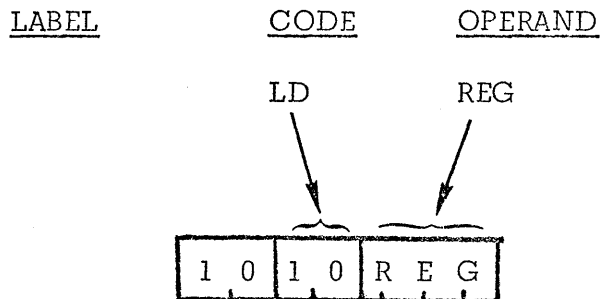

Description:

The contents of REG are stored into the accumulator, replacing the previous contents of the accumulator. The contents of REG are unchanged. The carry bit is not affected.

Example: If register 12 contains 0100 B, the instruction

LD 12

will cause the accumulator also to contain 0100 B.

### 3.4.4 XCH EXCHANGE REGISTER AND ACCUMULATOR

Format:

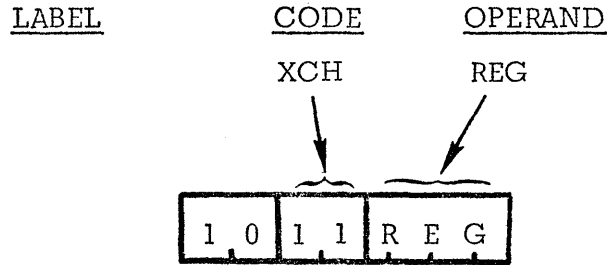

Description:

The contents of the register specified by REG are exchanged with the contents of the accumulator.

The carry bit is not affected.

Example: If the accumulator contains 1 1 0 0 B, and register 0 contains 0 0 1 1 B, then the instruction

XCH 0

will cause the accumulator to contain 0 0 1 1 B and register 0 to contain 1 1 0 0 B.

### 3.5 ACCUMULATOR INSTRUCTIONS

This section describes instructions which operate only on the contents of the accumulator and/or the carry bit.

Instructions in this class occupy one byte as follows:



- |              |              |
|--------------|--------------|
| 0000 for CLB | 0110 for RAR |
| 0001 for CLC | 0111 for TCC |
| 0010 for IAC | 1000 for DAC |
| 0011 for CMC | 1001 for TCS |
| 0100 for CMA | 1010 for STC |
| 0101 for RAL | 1011 for DAA |
|              | 1100 for KBP |

The general assembly language instruction format is:

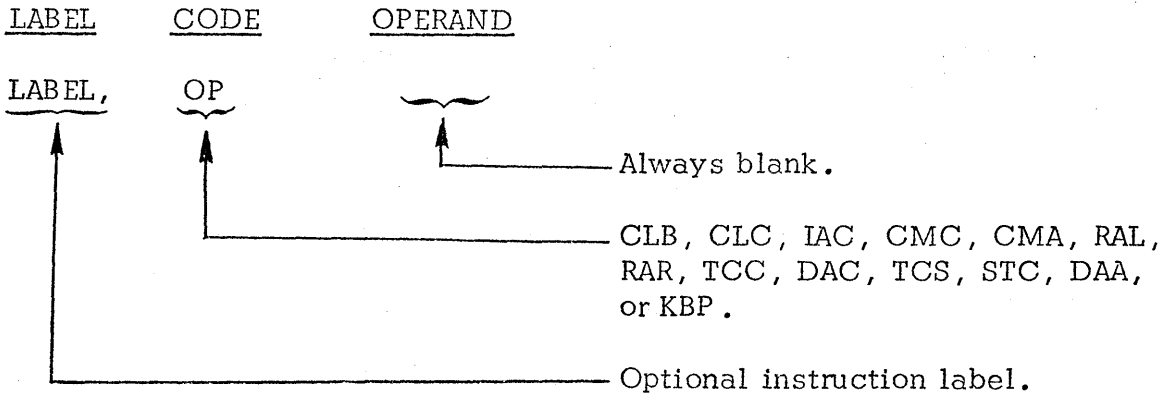

### 3.5.1 CLB CLEAR BOTH

Format:

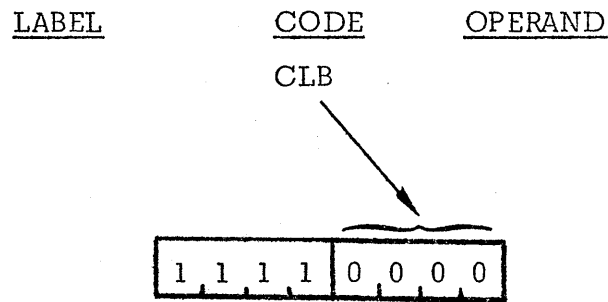

Description:

The accumulator is set to 0000 B, and the carry bit is reset.

### 3.5.2 CLC CLEAR CARRY

Format:

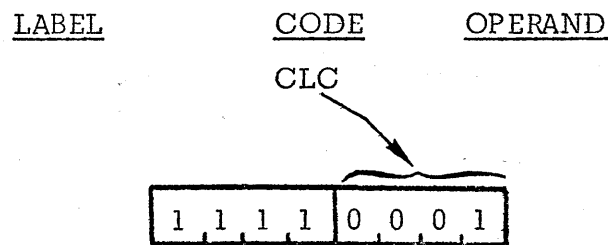

Description:

The carry bit is reset to 0.



### 3.5.3 IAC INCREMENT ACCUMULATOR

Format:

LABEL                      CODE                      OPERAND

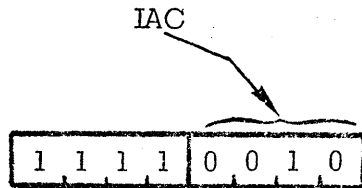

Description:

The contents of the accumulator are incremented by one. The carry bit is set if there is a carry out of the high order bit position, and reset if there is no carry.

Example: If the accumulator contains 1001B, the instruction IAC will perform the following operation:

```
Accumulator = 1001B
              + 0001B
              ---
0 | 1010B = New contents of accumulator.
    Carry = 0
```

If the accumulator contains 1111B, the instruction IAC will perform the following operation:

```
Accumulator = 1111B
              + 0001B
              ---
1 | 0000B = New contents of accumulator.
    Carry = 1
```

### 3.5.4 CMC COMPLEMENT CARRY

Format:

LABEL                      CODE                      OPERAND

CMC

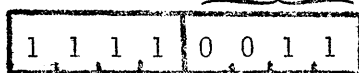

Description:

If the carry bit = 0, it is set to 1. If the carry bit is = 1, it is set to 0.

### 3.5.5 CMA COMPLEMENT ACCUMULATOR

Format:

LABEL                      CODE                      OPERAND

CMA

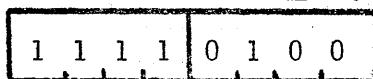

Description:

Each bit of the contents of the accumulator is complemented (producing the so-called one's complement).

The carry bit is not affected.

Example: If the accumulator contains 0110B, the instruction CMA will cause the accumulator to contain 1001B.

### 3.5.6 RAL ROTATE ACCUMULATOR LEFT THROUGH CARRY

Format:

LABEL                      CODE                      OPERAND

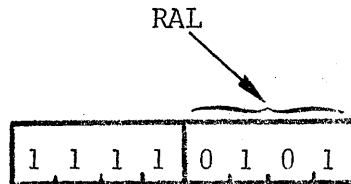

Description:

The contents of the accumulator are rotated one bit position to the left.

The high-order bit of the accumulator replaces the carry bit, while the carry bit replaces the low-order bit of the accumulator.

Example: Suppose the accumulator contains 1101 B, and the carry bit = 0.

Before RAL is executed:

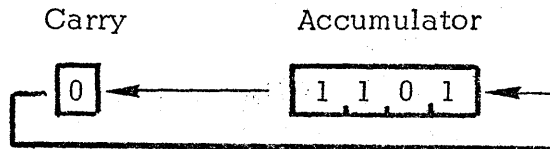

After RAL is executed:



### 3.5.7 RAR ROTATE ACCUMULATOR RIGHT THROUGH CARRY

Format:

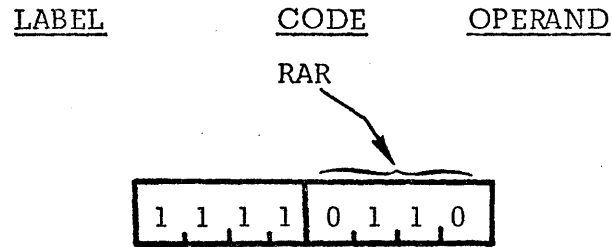

Description:

The contents of the accumulator are rotated one bit position to the right.

The low-order bit of the accumulator replaces the carry bit, while the carry bit replaces the high-order bit of the accumulator.

Example: Suppose the accumulator contains 0110B, and the carry bit = 1

Before RAR is executed:

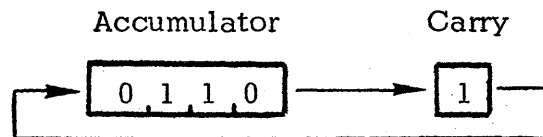

After RAR is executed:

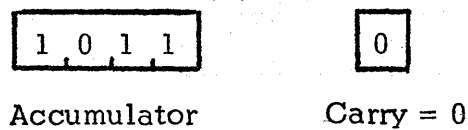

### 3.5.8 TCC TRANSMIT CARRY AND CLEAR

Format:

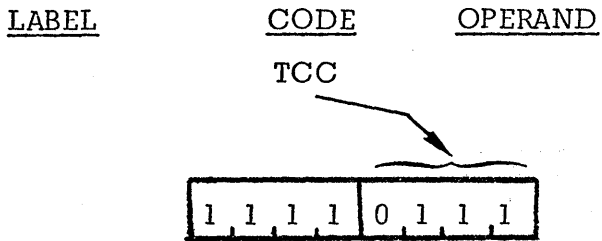

Description:

If the carry bit = 0, the accumulator is set to 0000B. If the carry bit = 1, the accumulator is set to 0001B. In either case, the carry bit is then reset.

### 3.5.9 DAC DECREMENT ACCUMULATOR

Format:

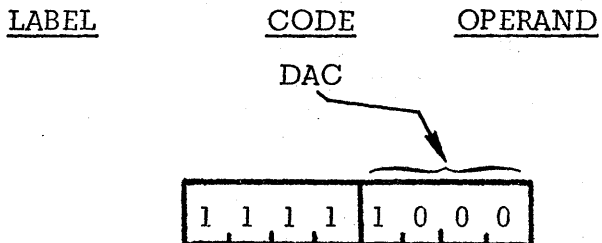

Description:

The contents of the accumulator are decremented by one. The carry bit is set if there is no borrow out of the high-order bit position, and reset if there is a borrow.

Example: If the accumulator contains 1001B, the instruction DAC will perform the following operation:

Accumulator = 1001B  
 + (-1) = 1111B  
1 | 1000B = New contents of accumulator  
 Carry = 1 indicating no borrow.

If the accumulator contains 0000, the instruction DAC will perform the following:

Accumulator = 0000B  
 + (-1) = 1111B  
0 | 1111B = New contents of accumulator  
 Carry = 0 indicating a borrow.

### 3.5.10 TCS TRANSFER CARRY SUBTRACT

Format:

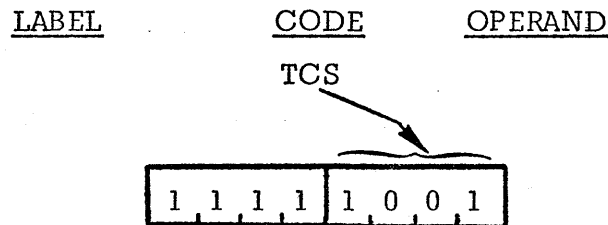

Description:

If the carry bit = 0, the accumulator is set to 9. If the carry bit = 1, the accumulator is set to 10. In either case, the carry bit is then reset.

NOTE: This instruction is used when subtracting decimal numbers greater than 4 bits in length. For an example of this, see Section 4.8.

### 3.5.11 STC SET CARRY

Format:

LABEL                      CODE                      OPERAND

STC

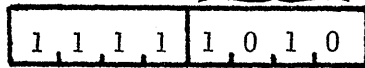

Description:

The carry bit is set to 1.

### 3.5.12 DAA DECIMAL ADJUST ACCUMULATOR

Format:

LABEL                      CODE                      OPERAND

DAA

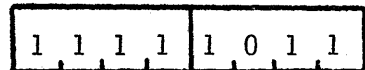

Description:

If the contents of the accumulator are greater than 9, or if the carry bit = 1, the accumulator is incremented by 6. Otherwise, the accumulator is not affected.

If the result of incrementing the accumulator produces a carry out of the high order bit position, the carry bit is set. Otherwise the carry bit is unaffected (in particular, it is not reset).

NOTE: This instruction is used when adding decimal numbers. For an example of this, see Section 4.7.

### 3.5.13 KBP KEYBOARD PROCESS

Format:

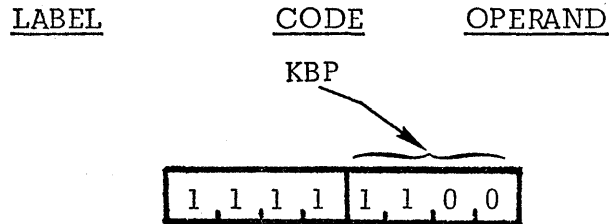

Description:

If the accumulator contains 0000B, it remains unchanged. If one bit of the accumulator is set, the accumulator is set to a number from 1 to 4 indicating which bit was set.

If more than one bit of the accumulator is set, the accumulator is set to 1111B.

This process is summarized as follows:

BINARY CONTENTS OF ACCUMULATOR BEFORE KBP	BINARY CONTENTS OF ACCUMULATOR AFTER KBP
0000	0000
0001	0001
0010	0010
0100	0011
1000	0100
0011	1111
0101	1111
0110	1111
0111	1111
1001	1111
1010	1111
1011	1111
1100	1111
1101	1111
1110	1111
1111	1111

The carry bit is not affected.



### 3.6 IMMEDIATE INSTRUCTIONS

This section describes two instructions which use data that is part of the instruction itself.

#### 3.6.1 FIM FETCH IMMEDIATE

The FIM instruction occupies two bytes.

Format:

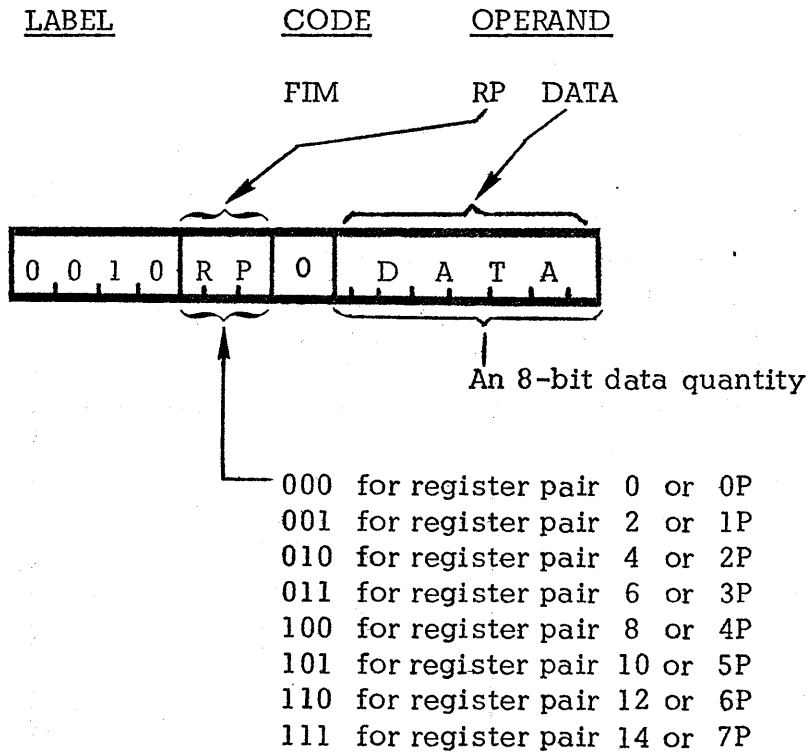

Description:

The 8 bits of immediate data are loaded into the register pair specified by RP. The carry bit is not affected.

Example: The instruction

FIM 2 254

will cause register 2 to contain 15, and register 3 to contain 14. This is because 254 decimal is encoded as FE hexadecimal; the upper four bits are loaded into register 2 and the lower four bits are loaded into register 3.

The instruction:

FIM 1P 6

will cause register 2 to contain 0, and register 3 to contain 6.

### 3.6.2 LDM LOAD ACCUMULATOR IMMEDIATE

The LDM instruction occupies one byte.

Format:

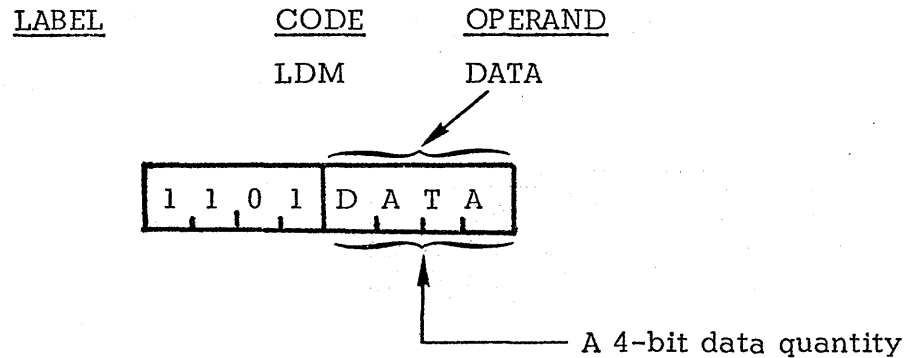

Description:

The 4 bits of immediate data are loaded into the accumulator.

The carry bit is not affected.

Example: The instruction:

LDM 0

will clear the accumulator.

The instruction:

LDM 15

will set each bit of the accumulator.

### 3.7 TRANSFER OF CONTROL INSTRUCTIONS

This section describes instructions which alter the normal execution sequence of instructions.

#### 3.7.1 JUN JUMP UNCONDITIONALLY

The JUN instruction occupies two bytes:

Format:

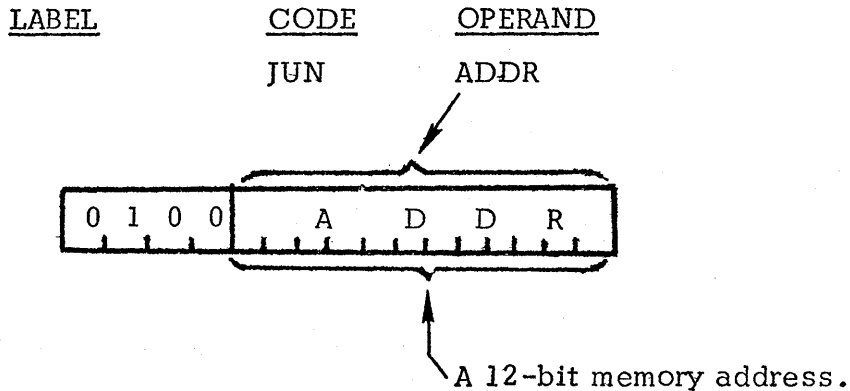

Description:

Program execution is transferred to the instruction at location ADDR, which may be anywhere in memory. (If the JUN is located in ROM, ADDR is a ROM address; if located in program RAM, ADDR is a program RAM address).

The carry bit is not affected.

NOTE: This instruction and the JMS instruction (Section 3.8.1), use a 12 bit address, and can reference any memory location. Their operation is not influenced by their position within a page of memory, whereas some other instruc-

tions are. Therefore, only a JUN or JMS instruction should be used to transfer control from one page of memory to another.

Example:

<u>Arbitrary Memory Address (Hex)</u>	<u>Label</u>	<u>Code</u>	<u>Operand</u>	<u>Assembled Data</u>
360		JUN	LRG	43E0
362	AD,	ADD	1	82
370	LAC,	LDM	3	D3
371		JUN	AD	4362
3E0	LRG,	FIM	OP 4	2004
3E2		JUN	LAC	4370

Normally, program instructions are executed sequentially. A 12-bit register called the program counter holds the address of the instruction to be executed. The JUN instruction replaces the program counter contents, causing program execution to continue at that address.

Thus the execution sequence of this example is as follows:

The JUN instruction at 360H replaces the contents of the program counter with 3E0H. The next instruction executed is the FIM at location LRG which loads register 0 with the value 0, and register 1 with the value 4. The JUN at 3E2H is then executed.

The program counter is set to 370H, and the LDM at this address loads the accumulator with the value 3. The JUN at 371H sets the program counter to 362H, where the ADD instruction adds the contents of register 1 plus the carry bit to the accumulator.

From here, normal program execution continues at location 363H.

### 3.7.2 JIN JUMP INDIRECT

The JIN instruction occupies one byte.

Format:

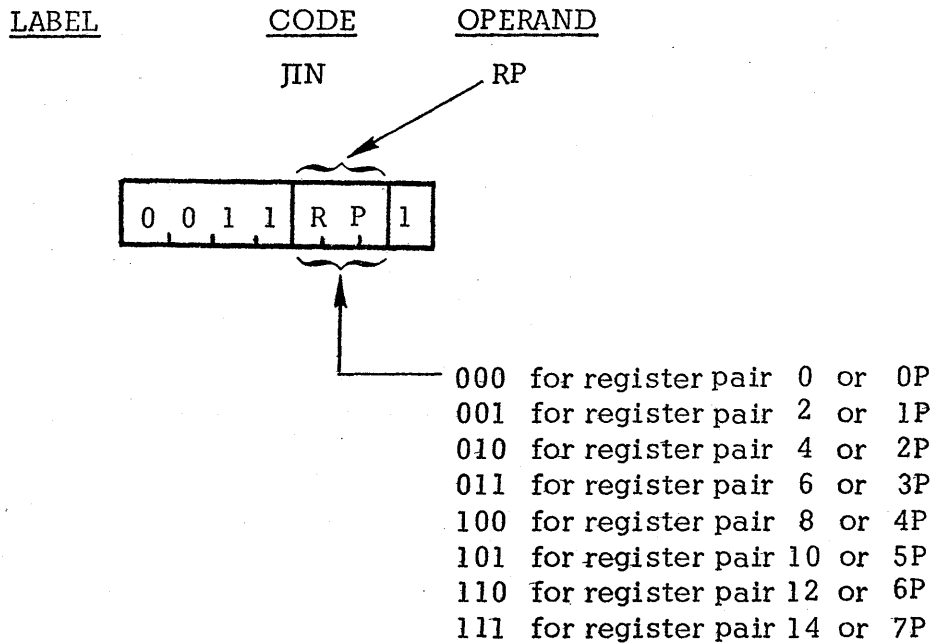

Description:

The 8 bits held in the register pair specified by RP are loaded into the lower 8 bits of the program counter. The highest 4 bits of the program counter are unchanged. Therefore, program execution continues at this address on the same page of memory in which the JIN instruction is loaded.

The carry bit is not affected.

Example:

<u>Hexadecimal Memory Address</u>	<u>Code</u>	<u>Operand</u>	<u>Assembled Data</u>
3E4	FIM	0P 21	2015
3E6	JIN	0P	

The FIM instructions loads register 0 with the value 1 and register 1 with the value 5. The JIN instruction then causes a jump to hexadecimal location 315.

NOTE: If the JIN instruction is located in the last location of a page in memory, the highest 4 bits of the program counter are incremented by one, causing control to be transferred to the corresponding location on the next page.

If the above example, the JIN had been located at address 255 decimal (0FF hexadecimal), control would have been transferred to address 115 hexadecimal, not 015 hexadecimal. This is dangerous programming practice, and should be avoided whenever possible.

### 3.7.3 JCN JUMP ON CONDITION

The JCN instruction occupies two bytes.

Format:

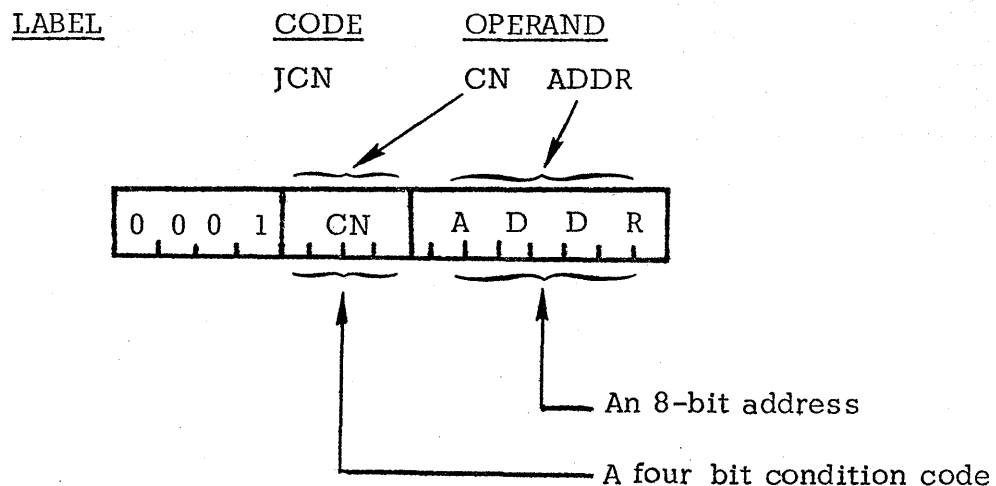

Description:

If the condition specified by CN is false, no action occurs and program execution continues with the next sequential instruction. If the condition specified by CN is true, the 8 bits specified by ADDR replace the lower 8 bits of the program counter. The highest 4 bits of the program counter are unchanged. Therefore, program execution continues at the specified address on the same page of memory in which the JCN instruction is located. The carry bit is not affected.

The condition code is specified in the assembly language statement as a decimal value from 0 to 15, which is represented in the assembled instruction as the corresponding 4 bit hexadecimal digit. Each bit of the condition code has a meaning, as follows:

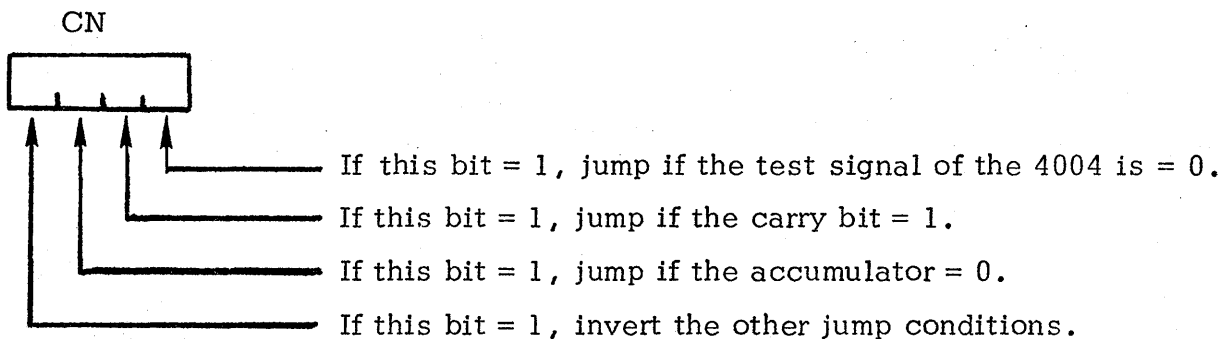

More than one condition at a time may be tested. If the leftmost bit of the condition code is zero, a jump occurs if any of the remaining specified conditions is true (an "or" condition). If the leftmost bit is one, a jump occurs if the logical inverse of the "or" condition is true. In Boolean notation, the equation for the jump condition is as follows:

$$JUMP = \overline{C_1} \cdot ((ACC = 0) \cdot C_2 + (carry = 1) \cdot C_3 + \overline{TEST} \cdot C_4) + C_1 \cdot (((ACC \neq 0) + \overline{C_2}) \cdot ((carry = 0) + \overline{C_3}) \cdot (TEST + \overline{C_4}))$$

Example:

<u>Hexadecimal Memory Address</u>	<u>Label</u>	<u>Code</u>	<u>Operand</u>	<u>Assembled Data</u>
302	LOC,	LDM	4	D4
⋮		⋮		⋮
38B		JCN	6 LOC	1602
38D		---		

The condition code is encoded as 0110B. Therefore, the JCN will cause a jump to address 302H if the accumulator = 0, or if the carry bit = 1. If neither of these is true, program execution continues with the instruction at location 38DH.

**NOTE:** If the JCN instruction is located in the last two locations of a page in memory and the jump condition is true, the highest 4 bits of the program counter are incremented by 1, causing control to be transferred to the corresponding location on the next page.

If in the above example, the JCN had been located at addresses 254 and 255 decimal (0FE and 0FF hexadecimal) a true condition would have caused jump to location 102 hexadecimal rather than 002 hexadecimal. This is dangerous programming practice, and should be avoided whenever possible.

### 3.7.4 ISZ INCREMENT AND SKIP IF ZERO

The ISZ instruction occupies two bytes.

Format:

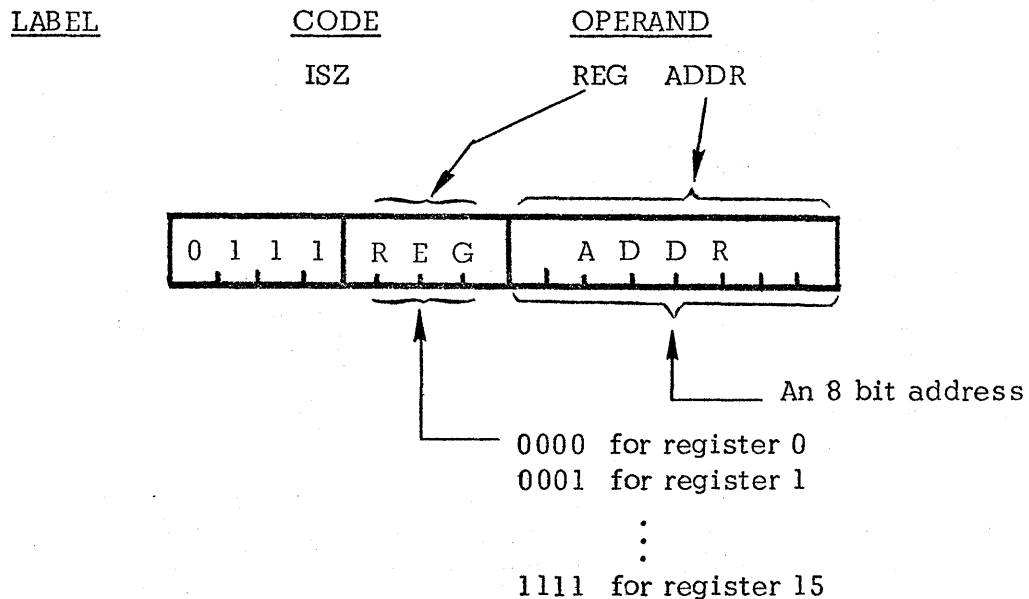

Description:

The index register specified by REG is incremented by one. If the result is 0000 B, program execution continues with the next sequential instruction. If the result does not equal 0000B, the 8 bits specified by ADDR replace the lowest 8 bits of the program counter. The highest 4 bits of the program counter are unchanged. Therefore, program execution continues at the specified address on the same page of memory in which the ISZ instruction is located.

The carry bit is not affected.



Example:

<u>Hexadecimal Memory Address</u>	<u>Label</u>	<u>Code</u>	<u>Operand</u>	<u>Assembled Data</u>
30F		FIM	0P 0	2000
311	LP,	XCH	2	B2
⋮		⋮		
31A		ISZ	0 LP	7011
31C		--		

The FIM instruction loads registers 0 and 1 with 0.

The XCH is then executed. Program execution continues until the ISZ is reached. Register 0 is incremented to contain 1, and, since this result is non-zero, program control is transferred back to location 311H. This process continues until register 0 = 1111B. Then the ISZ increments register 0 producing a result of 0000B, and execution continues with the instruction at 31CH.

NOTE: If the ISZ instruction is located in the last two locations of a page in memory and the incrementation produces a non-zero result, the highest 4 bits of the program counter are incremented by 1, causing control to be transferred to the corresponding location on the next page.

If in the above example, the ISZ had been located at decimal addresses 1022 and 1023 (3FE and 3FF hexadecimal), control would have been transferred to location 411 hexadecimal and the XCH and remaining instructions would have been executed only once. Thus, this is dangerous programming practice, and should be avoided whenever possible.

### 3.8 SUBROUTINE LINKAGE COMMANDS

This section describes the commands which call and cause return from subroutines. They cause a transfer of program control and use the address stack (see Sections 2.4 and 2.7.7).

#### 3.8.1 JMS JUMP TO SUBROUTINE

The JMS instruction occupies two bytes.

Format:

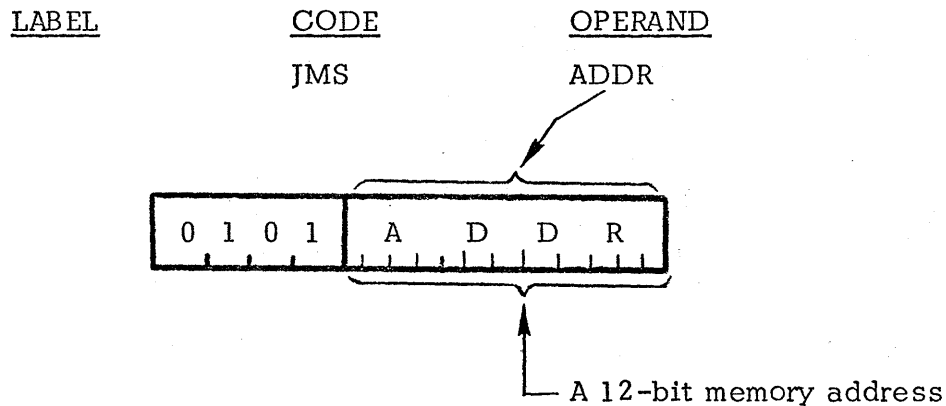

Description:

The address of the instruction immediately following the JMS is written to the address stack for later use by a BBL instruction. Program execution continues at memory address ADDR, which may be on any page.

The carry bit is not affected.

NOTE: Since the JMS uses a 12 bit memory address, it operates the same wherever it is located in memory, and can reference any address in memory. For this reason, only a JMS or JUN instruction should be used to transfer program control from one page of memory to another.

Example:

<u>Hexadecimal Memory Address</u>	<u>Label</u>	<u>Code</u>	<u>Operand</u>	<u>Assembled Data</u>
011		JMS	SUB	53A0
013		XCH	0	D0
		⋮		
3A0	SUB,	INC	1	61
		⋮		
		BBL	6	C6

The JMS instruction causes the 12 bit address 013H (the address of the instruction following the JMS) to be written to the address stack. Execution continues with the INC instruction at SUB, and proceeds sequentially from this point.

3.8.2 BBL BRANCH BACK AND LOAD

The BBL instruction occupies one byte.

Format:

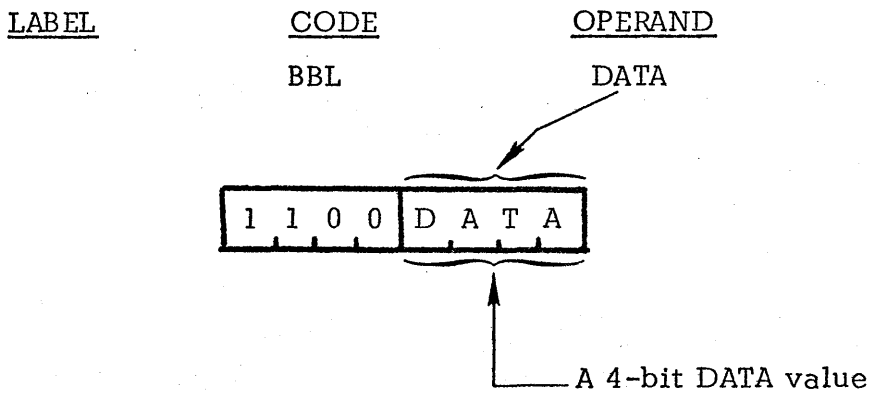

Description:

The 4 bits of immediate data encoded in the instruction are loaded into the accumulator. Then the last 12 bit address saved on the address stack (by a JMS instruction)

is read from the stack and placed in the program counter. Thus, execution continues with the instruction immediately following the last JMS instruction.

The carry bit is not affected.

Example: In the example of Section 3.8.1, the BBL instruction loads the value 6 into the accumulator. The address 013 is read into the program counter, and program execution proceeds with the XCH instruction.

### 3.9 NOP INSTRUCTION NO OPERATION

This instruction occupies one byte.

Format:

<u>LABEL</u>	<u>CODE</u>	<u>OPERAND</u>
	NOP	

0	0	0	0	0	0	0	0
---	---	---	---	---	---	---	---

Description:

No operation is performed. The program counter is incremented by one and execution continues with the next sequential instruction.

The carry bit is not affected.

### 3.10 MEMORY SELECTION INSTRUCTIONS

This section describes instructions which specify DATA RAM data and status characters, RAM output ports and ROM input and output ports to be operated on by I/O and RAM instructions described in Section 3.11.

#### 3.10.1 DCL DESIGNATE COMMAND LINE

The DCL instruction occupies one byte.

Format:

<u>LABEL</u>	<u>CODE</u>	<u>OPERAND</u>
	DCL	

1	1	1	1	1	1	0	1
---	---	---	---	---	---	---	---

Description:

As described in Section 2.3.3 there may be up to 8 DATA RAM BANKS, each of which consists of four DATA RAM units. The DCL instruction uses the rightmost 3 bits of the accumulator to determine which of the 8 DATA RAM BANKS will be referenced during subsequent operations.

The selection is made as follows:

RIGHTMOST 3 BITS OF ACCUMULATOR	DATA RAM BANK SELECTED
000	0
001	1
010	2
011	3
100	4
101	5
110	6
111	7

This choice remains in effect until the next DCL is executed, or an external RESET signal is received. A RESET causes DATA RAM BANK 0 to be selected.

The carry bit is not affected.

Example: The following instructions will select DATA RAM BANK 3:

```
LDM 3 /Load accumulator with 0011 B  
DCL
```

### 3.10.2 SRC SEND REGISTER CONTROL

The SRC instruction occupies one byte.

Format:

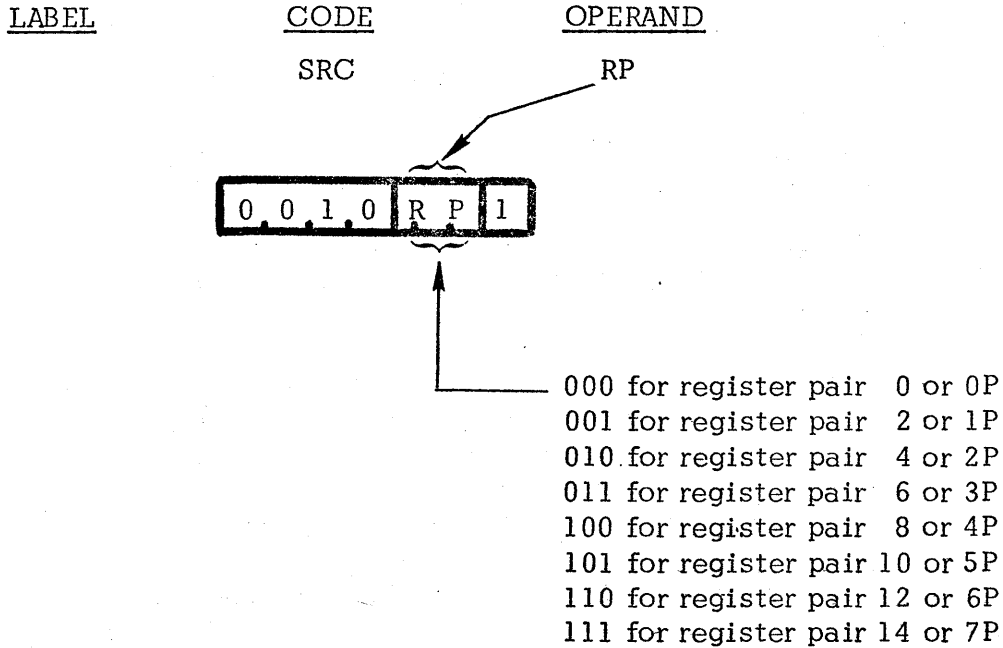

Description:

The 8 bits contained in the register pair specified by RP are used as an address. This address may designate a particular DATA RAM data character, a DATA RAM status character, a RAM output port, or a ROM input/output port. (A description of these elements appears in Section 2). In fact, the address designates all of these simultaneously; it is up to the programmer to then write the correct I/O or RAM instruction (described in Section 3.11) to access the proper entity.

The address sent by the SRC remains in effect until changed by a subsequent SRC.

The **only** DATA RAM bank which receives the SRC address is the one selected by the last previous DCL instruction.

The carry bit and the contents of the register pair are unaffected.

The 8 bits of the address sent by the SRC are interpreted as follows:

(1) When referencing a DATA RAM data character:

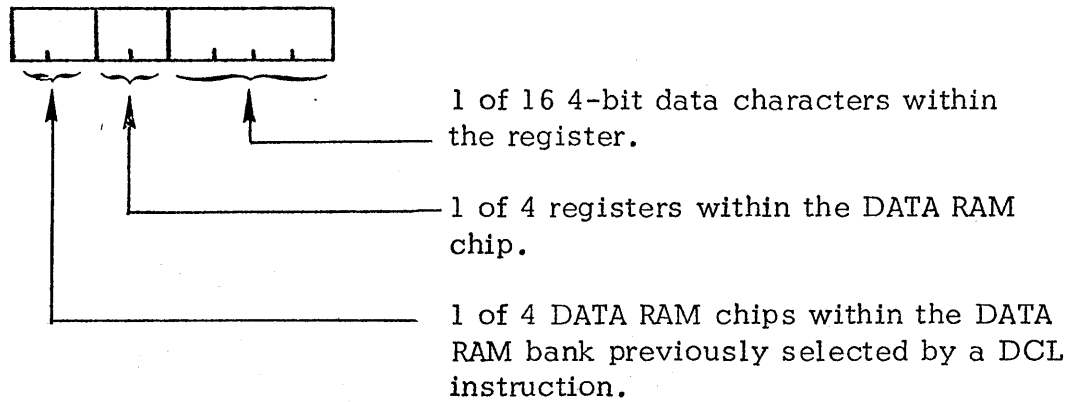

(2) When referencing a DATA RAM status character:

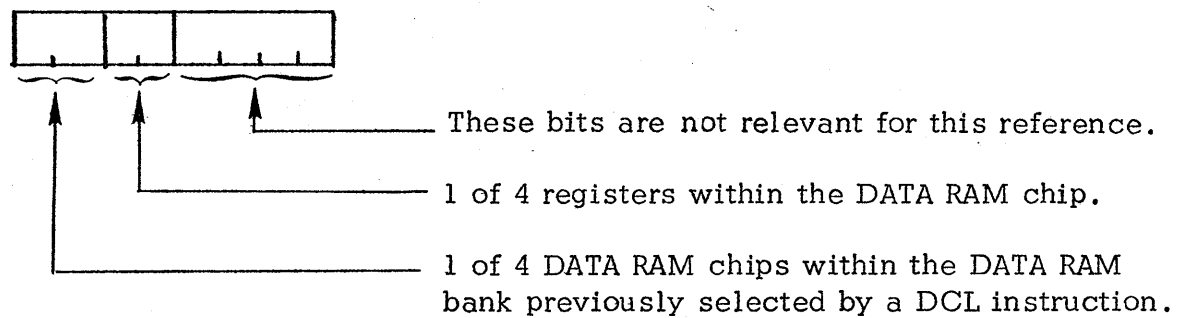

(3) When referencing a RAM output port:

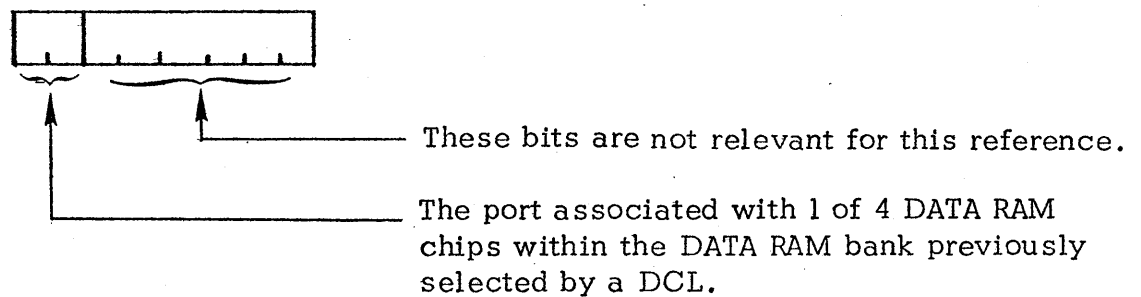



(4) When referencing a ROM input or output port:

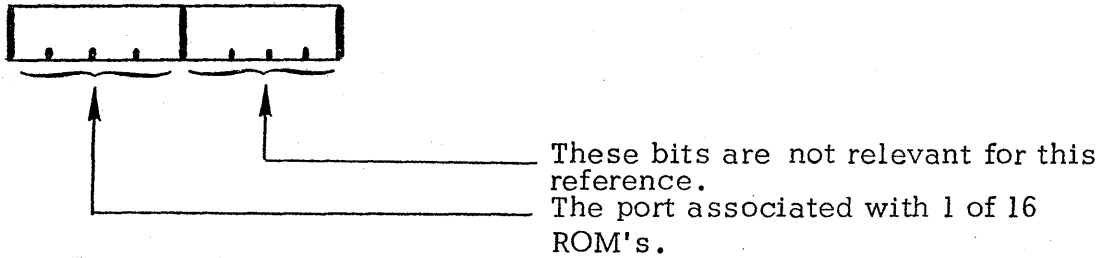

Example: The instructions:

```
FIM  1P  180
SRC   1P
```

will cause the eight bit value 10110100B to be used as an address. Subsequent instructions could then reference DATA RAM data character number 4 of register 3 of chip 2, any of the status characters associated with DATA RAM register 3 of chip 2, RAM output port number 2 (the port associated with DATA RAM chip 2), or ROM port number 11 (the port associated with ROM number 11). The address remains in effect until another SRC instruction is executed.

### 3.11 INPUT/OUTPUT AND RAM INSTRUCTIONS

This section describes instructions which access DATA RAM characters or perform input or output operations. One instruction, WPM, allows the programmer to read or write 8-bit program RAM locations. These instructions use addresses selected by the DCL and SRC instructions described in Section 3.1.0.

Instructions in this class occupy one byte as follows:

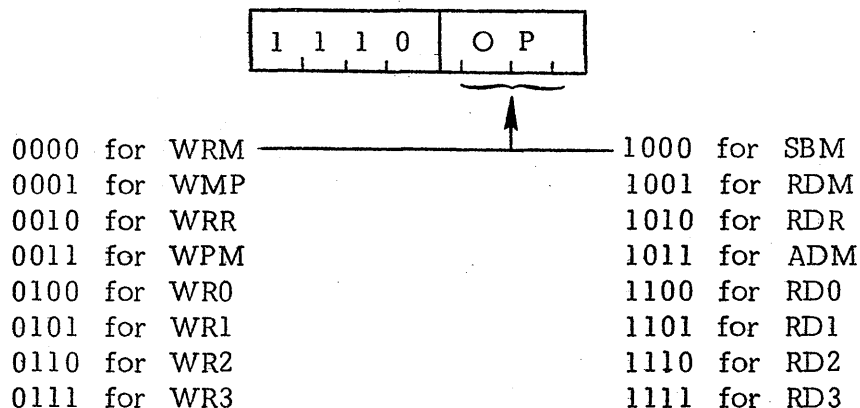

The general assembly language instruction format is:

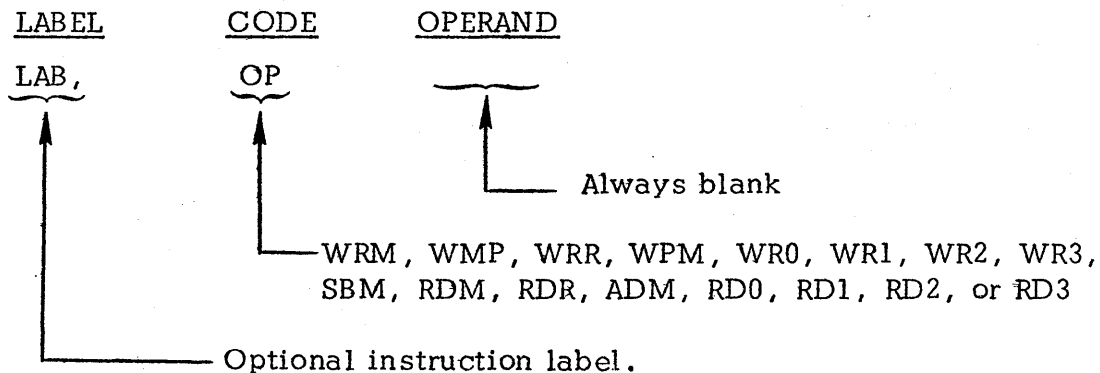

### 3.11.1 RDM READ DATA RAM DATA CHARACTER

Format:

<u>LABEL</u>	<u>CODE</u>	<u>OPERAND</u>
--------------	-------------	----------------

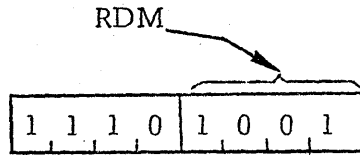

Description:

The DATA RAM data character specified by the last SRC instruction is loaded into the accumulator. The carry bit and the data character are not affected.

Example:

<u>LABEL</u>	<u>CODE</u>	<u>OPERAND</u>
	FIM	2P 5
	SRC	2P
	RDM	

The above instructions will read the contents of DATA RAM data character number 5 of register 0 of chip 0 of the currently selected DATA RAM bank into the accumulator.

### 3.11.2 RDn READ DATA RAM STATUS CHARACTER

Format:

<u>LABEL</u>	<u>CODE</u>	<u>OPERAND</u>
	RDn	

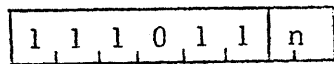

↑  
n = 0, 1, 2, or 3

Description:

The DATA RAM status character whose number from 0 to 3 is specified by n, associated with the DATA RAM register specified by the last SRC instruction, is loaded into the accumulator.

The carry bit and the status character are not affected.

Example:

<u>LABEL</u>	<u>CODE</u>	<u>OPERAND</u>
	FIM	2P 5
	SRC	2P
	RD3	

The above instructions will read the contents of DATA RAM status character 3 of register 0 of chip 0 of the currently selected DATA RAM bank into the accumulator.

3.11.3 RDR READ ROM PORT

Format:

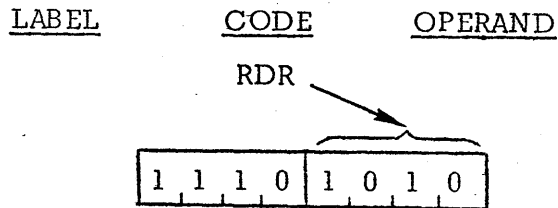

Description:

The ROM port specified by the last SRC instruction is read. When using the 4001 ROM, each of the 4 lines of the port may be an input or an output line; the data on the input lines is transferred to the corresponding bits of the accumulator. Any output lines cause either a 0 or a 1 to be transferred to the corresponding bits of the accumulator. Whether a 0 or a 1 is transferred is a function of the hardware, not under control of the programmer.

The carry bit is not affected.

Example:

<u>LABEL</u>	<u>CODE</u>	<u>OPERAND</u>
	FIM	3P 160
	SRC	3P
	RDR	

The above instructions will read the contents of the port associated with ROM number ten into the accumulator. If the leftmost I/O line is an output line and the remaining I/O lines are input lines containing 010B, the accumulator will contain either 1010B or 0010B.

NOTE: On the INTELLEC 4, a ROM port may be used for either input or output. If programs tested on the INTELLEC 4 are to be run later with a 4001 ROM, the programmer must be careful not to use one port for both functions.

3.11.4 WRM WRITE DATA RAM CHARACTER

Format:

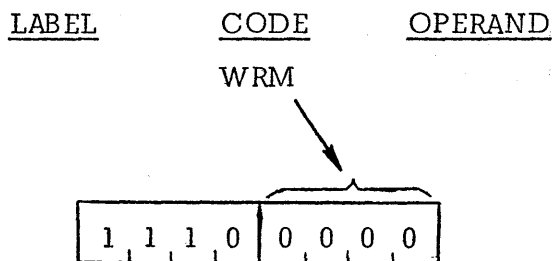

Description:

The contents of the accumulator are written into the DATA RAM data character specified by the last SRC instruction.

The carry bit and the accumulator are not affected.

Example:

<u>LABEL</u>	<u>CODE</u>	<u>OPERAND</u>
	FIM	OP 180
	SRC	OP
	LDM	15
	WRM	

The above instruction will cause DATA RAM data character number 4 of register 3 of chip 2 of the DATA RAM bank selected by the last DCL instruction to contain 15 (1111B).

3.11.5 WRn WRITE DATA RAM STATUS CHARACTER

Format:

<u>LABEL</u>	<u>CODE</u>	<u>OPERAND</u>
	WRn	

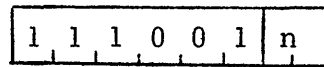

n = 0, 1, 2, or 3

Description:

The contents of the DATA RAM status character whose number from 0 to 3 is specified by n, associated with the DATA RAM register specified by the last SRC instruction, are replaced by the contents of the accumulator.

The carry bit and the accumulator are not affected.

Example:

<u>LABEL</u>	<u>CODE</u>	<u>OPERAND</u>
	FIM	0P 0
	SRC	0P
	LDM	2
	WRI	

The above instructions will write the value 2 into status character 1 of DATA RAM register 0 of chip 0 of the currently selected DATA RAM bank.

3.11.6 WMP WRITE RAM PORT

Format:

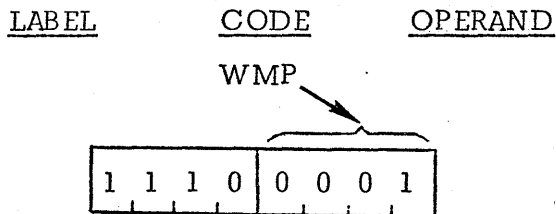

Description:

The contents of the accumulator are written to the output port associated with the DATA RAM chip selected by the last SRC instruction. This value will stay at the output port until overwritten.

The carry bit and the accumulator are unchanged.

Example:

<u>LABEL</u>	<u>CODE</u>	<u>OPERAND</u>
	FIM	3P 64
	SRC	3P
	LDM	6
	WMP	

The above instructions will write the value 6 to the output port associated with DATA RAM chip 2 of the currently selected DATA RAM bank.

### 3.11.7 WRR WRITE ROM PORT

Format:

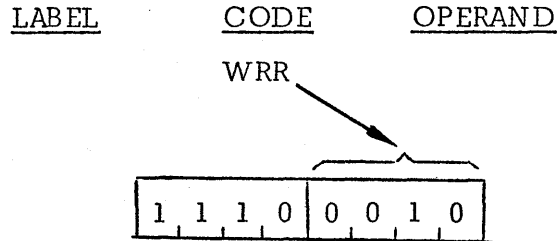

Description:

The contents of the accumulator are written to the output port associated with the ROM selected by the last SRC instruction. This value will stay at the output port until overwritten.

The carry bit and the accumulator are unchanged.

Example:

<u>LABEL</u>	<u>CODE</u>	<u>OPERAND</u>
	FIM	4P 64
	SRC	4P
	LDM	15
	WRR	

The above instructions will write the value 15 to the output port associated with ROM number 4.



### 3.11.8 ADM ADD DATA RAM TO ACCUMULATOR WITH CARRY

Format:

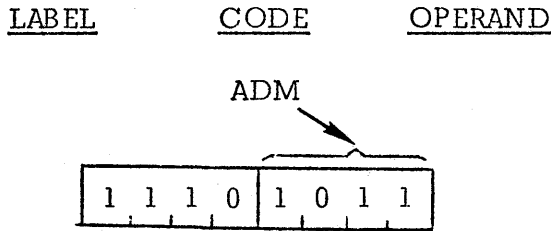

Description:

The DATA RAM data character specified by the last SRC instruction, plus the carry bit, are added to the accumulator.

The carry bit will be set if the result generates a carry, and will be reset otherwise.

The data character is not affected.

Example:

<u>LABEL</u>	<u>CODE</u>	<u>OPERAND</u>
	FIM	0P 0
	SRC	0P
	ADM	

If the carry bit = 0, the accumulator contains 10, and DATA RAM data character 0 of register 0 of chip 0 contains 7, the ADM will perform the following operation:

Accumulator	=	1 0 1 0 B	
Data character	=	0 1 1 1 B	
Carry bit	=	_____ 0	
		1   0 0 0 1 B =	New contents of accumulator.
		↙	Carry bit will be set.

### 3.11.9 SBM SUBTRACT DATA RAM FROM MEMORY WITH BORROW

Format:

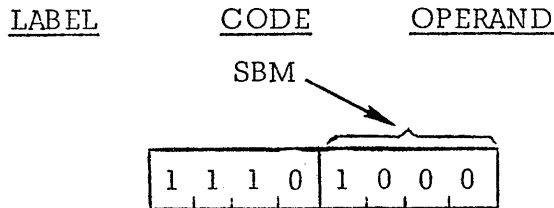

Description:

The value of the DATA RAM character specified by the last SRC instruction is subtracted from the accumulator with borrow. The data character is unaffected. A borrow from the previous subtraction is indicated by the carry bit being equal to one at the beginning of this instruction. No borrow from the previous subtraction is indicated by the carry bit being equal to zero at the beginning of this instruction.

This instruction sets the carry bit if the result generates no borrow, and resets the carry bit if the result generates a borrow.

The subtract with borrow operation is actually performed by complementing each bit of the data character and adding the resulting value plus the complement of the carry bit to the accumulator.

NOTE: When this instruction is used to subtract numbers greater than 4 bits in length, the carry bit must be complemented by the program between each required subtraction operation. For an example of this, see Section 4.8.

Example:

<u>LABEL</u>	<u>CODE</u>	<u>OPERAND</u>
	FIM	1P 1
	SRC	1P
	SBM	

If the carry bit = 1, the accumulator contains 7, and DATA RAM character 1 of register 0 of chip 0 contains 5, the SBM will perform the following operation:

Accumulator	=	0 1 1 1 B	
Data character = 0101	=	1 0 1 0 B	
Complemented	=	0	
Complement of Carry	=	0	
		0	= New contents of accumulator.
		0	Carry bit will be reset indicating a borrow.

### 3.11.10 WPM WRITE PROGRAM RAM

Format:

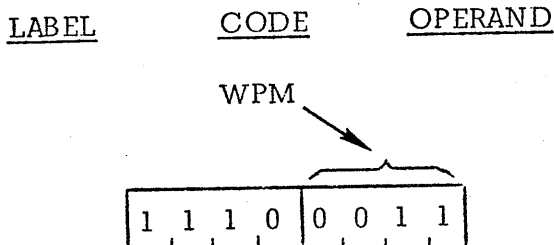

Description:

This is a special instruction which may be used to write the contents of the accumulator into a half byte of program RAM, or read the contents of a half byte of program RAM into a ROM input port where it can be accessed by a program.

The carry bit is unaffected.

NOTE: Two WPM instructions must always appear in close succession; that is, each time one WPM instruction references a half byte of program RAM as indicated by an SRC address, another WPM must access the other half byte before the SRC address is altered. An internal counter keeps track of which half-byte is being accessed. If only one WPM occurs, this counter will be out of sync with the program and errors will occur. In this situation, a RESET pulse must be used to re-initialize the machine.

NOTE: A WPM instruction requires an SRC address to access program RAM. Whenever a WPM is executed, the DATA RAM which happens to correspond to this SRC address will also be written. If data needed later in the program is being held in such a DATA RAM, the programmer must save it elsewhere before executing the WPM instruction.

Storing Data Into Program RAM:

A program must perform the following actions in order to store eight bits of data into a program RAM location:

- (1) The value 1 must be written to ROM port number 14. This is a "write enable" signal, permitting the store operation to work.
- (2) The highest 4 bits of the program RAM address to be accessed must be written to ROM port number 15.
- (3) The lowest 8 bits of the program RAM address to be accessed must be sent out by an SRC instruction.

- (4) The higher 4 bits of data to be written must be loaded into the accumulator and written with the first WPM; the lower 4 bits of data must then be loaded into the accumulator and written with the second WPM.
- (5) The value 0 must be written to ROM port number 14, clearing the "write enable".

Reading Data From Program RAM:

A program must perform the following actions in order to read eight bits of data from a program RAM location:

- (1) The highest 4 bits of the program RAM address to be accessed must be written to ROM port 15.
- (2) The lowest 8 bits of the program RAM address to be accessed must be sent out by an SRC instruction.
- (3) Two WPM instructions in succession must be executed. The first reads the leftmost 4 bits of the program RAM location into ROM port 14; the second reads the rightmost 4 bits of the program RAM location into ROM port 15.

Example: The following routines access a program RAM location whose address is held in status characters 0, 1, and 2 of DATA RAM register 0 of DATA RAM chip 0.

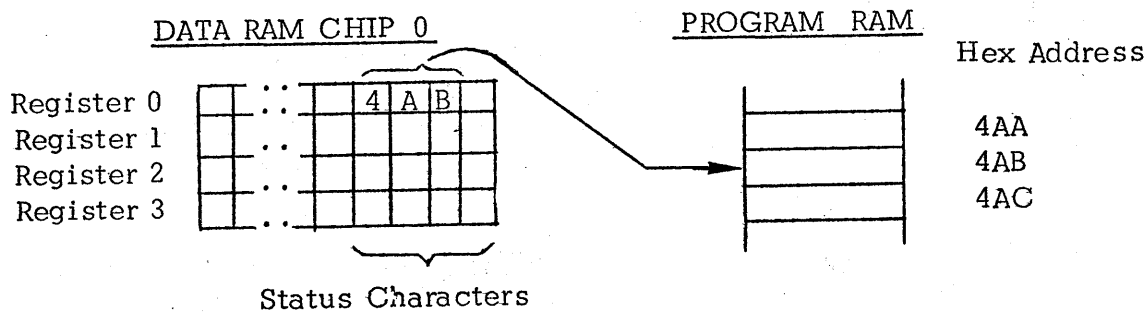

Routine STR stores the contents of registers 2 and 3 into the addressed location; routine FCH reads the contents of the addressed location into registers 2 and 3.

<u>LABEL</u>	<u>CODE</u>	<u>OPERAND</u>	<u>COMMENT</u>	
STR,	FIM	0P 224		
	SRC	0P	/ Select ROM port 14.	
	LDM	1		
	WRR		/ Turn on write enable.	
	JMS	COM	/ Routine COM sets up PRAM / address.	
	LD	2	/ High 4 data bits to accumulator.	
	WPM		/ Write to PRAM	
	LD	3	/ Low 4 data bits to accumulator.	
	WPM			
	FIM	0P 224		
	SRC	0P	/ Select ROM port 14.	
	CLB			
	WRR		/ Turn off write enable.	
	BBL	0	/ Return to program	
/				
/				
COM,	FIM	0P 0		
	SRC	0P	/ Select DATA RAM chip 0 register 0.	
	RD1		/ Read middle 4 bits of address.	
	XCH	10	/ Save in register 10.	
	RD2		/ Read lowest 4 bits of address.	
	XCH	11	/ Save in register 11.	
	RD0		/ Read highest 4 bits of address.	
	FIM	0P 240		
	SRC	0P	/ Select ROM port 15.	
	WRR		/ Write high address	
	SRC	5P	/ Write middle + low address	
	BBL	0	/ Return to STR or FCH	
	/			
	/			
FCH	JMS	COM	/ Routine COM sets up PRAM address.	
	WPM		/ PRAM data to ROM port 14.	
	WPM		/ PRAM data to ROM port 15.	
	FIM	0P 224		
	SRC	0P	/ Select port 14.	
	RDR		/ Read to accumulator.	
	XCH	2	/ Save in register 2.	
	INC	0		
	SRC	0P	/ Select port 15.	
	RDR		/ Read to accumulator	
	XCH	3	/ Save in register 3.	
	BBL	0	/ Return to program	

### 3.12 PSEUDO INSTRUCTION

This section describes the functions of the pseudo instruction recognized by the assembler. The pseudo instruction is indicated by the character = (equal sign) written in the code field of an assembler statement. No executable object code is generated by the pseudo instruction. It acts merely to provide the assembler with information to be used subsequently while generating object code.

#### 3.12.1 EQUATE FUNCTION

Format:

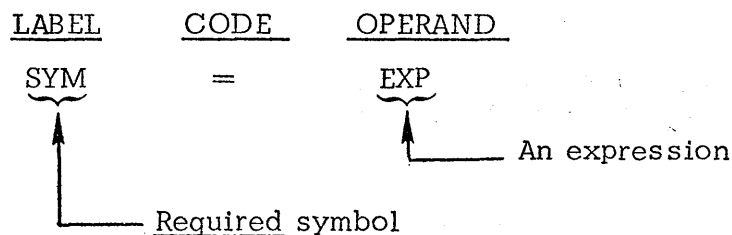

Description:

The symbol SYM is assigned the value EXP by the assembler. Whenever the symbol SYM is encountered subsequently by the assembler, this value will be used.

Example: The statements

```
CZ = 10
      JCN  CZ  ADDR
```

are equivalent to the statement

```
JCN  10  ADDR
```

The statements

```
DAT = 5
      LDM DAT
```

will load the value 5 into the accumulator.

### 3.12.2 ORIGIN FUNCTION

Format:

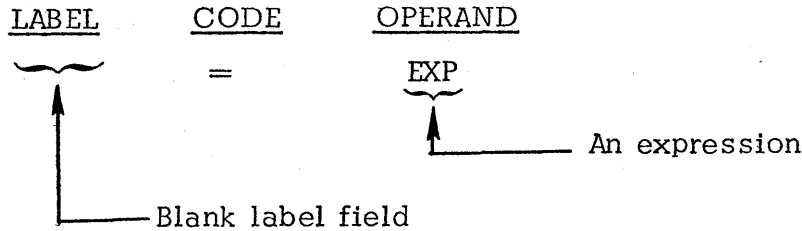

Description:

The assembler's location counter, is set to the value of EXP. The next machine instruction or data byte generated will be assembled at address EXP.

NOTE: The equal sign may appear in the first position of the line.

Example:

<u>LABEL</u>	<u>CODE</u>	<u>OPERAND</u>
=	0	
	JUN	LO
	=	512
LO,	LDM	7

The JUN instruction will be assembled in locations 0 and 1 of ROM or program RAM. The location counter is then set to 512, causing the LDM instruction to be assembled at location 512, the first location on the second memory page. The JUN will therefore cause a jump to location 512.

NOTE: The pseudo instruction also makes it possible to assemble constant data values into a program. For a description of how to do this, see Section 3.2.2.

## 4.0 PROGRAMMING TECHNIQUES

This section describes some techniques which may be of help to the programmer.

### 4.1 CROSSING PAGE BOUNDARIES

As described in Section 2, programs are held in either ROM or program RAM, both of which are divided into pages. Each page consists of 256 8-bit locations. Addresses 0 through 255 comprise the first page, 256-511 comprise the second page, and so on.

In general, it is good programming practice to never allow program flow to cross a page boundary except by using a JUN or JMS instruction. The following example will show why this is true. Suppose a program in memory appears as below:

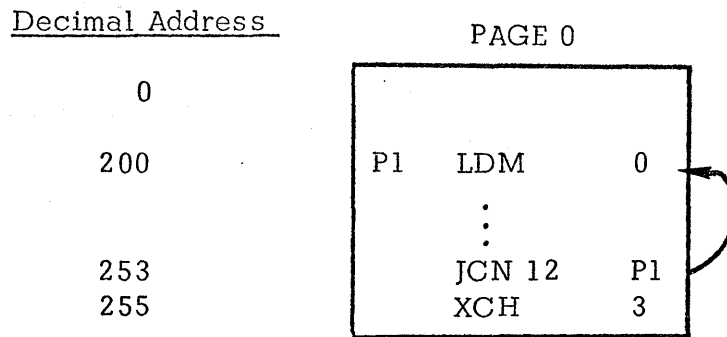

If the accumulator is non-zero when the JCN is executed, program control will be transferred to location 200, as the programmer intended.

Suppose now that an error discovered in the program requires that a new instruction be inserted somewhere between locations 200 and 253. The program would now appear as follows:



Decimal Address

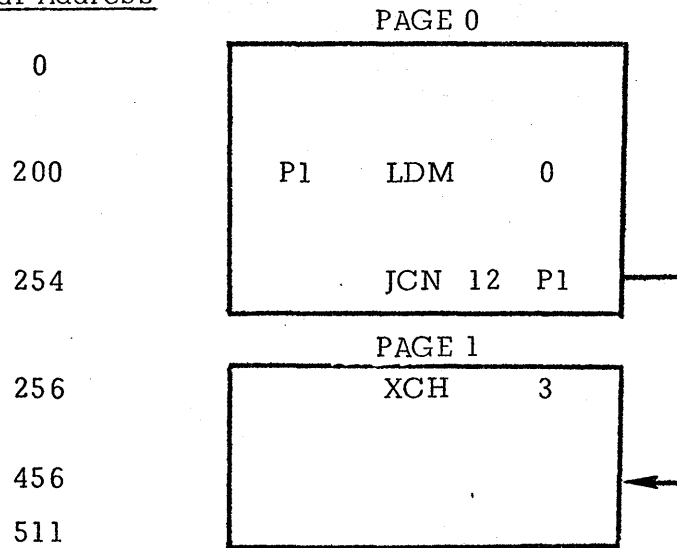

Since the JCN is now located in the last two locations of a page, it functions differently. Now if the accumulator is non-zero when the JCN is executed, program control will be erroneously transferred to location 456, causing invalid results.

Since both the JUN and JMS instructions use 12-bit addresses to directly address locations on any page of memory, only these instructions should be used to cross page boundaries.

## 4.2 SUBROUTINES

Frequently, a group of instructions must be repeated many times in a program. The group may be written "n" times if it is needed at "n" different points in a program, but better economy can be obtained by using subroutines.

A subroutine is coded like any other group of assembly language statements, and is referred to by its name, which is the label of the first instruction. The programmer references a subroutine by writing its name in the operand field of a JMS instruction. When the JMS is executed, the address of the next sequential instruction after the JMS is written to the address stack (see Section 2.4), and program execution proceeds with the first instruction of the subroutine. When the subroutine has completed its work, a BBL instruction is executed, which loads a value into the accumulator and causes an address to be read from the stack into the program counter, causing program execution to continue with the instruction following the JMS. Thus, one copy of a subroutine may be called from many different points in memory, preventing duplication of code. Note also that since the address stack and the JMS instruction use 12-bit addresses, calling programs and subroutines may be located anywhere in ROM or control program RAM (they need not be on the same page in memory).

Example: Subroutine IN increments an 8 bit number passed in index register 0 and 1 and then returns to the instruction following the last JMS instruction executed.

<u>LABEL</u>	<u>CODE</u>	<u>OPERAND</u>	
IN,	XCH	1	/ Reg 1 to Accum.
	IAC		/ Increment value and produce carry
	XCH	1	/ Restore reg 1.
	JCN	10 NC	/ Jump if Carry = 0.
	INC	0	/ Increment high order 4 bits
NC,	BBL	0	/ Return

Assume IN appears as follows:

Arbitrary Memory  
Address  
(Hex)

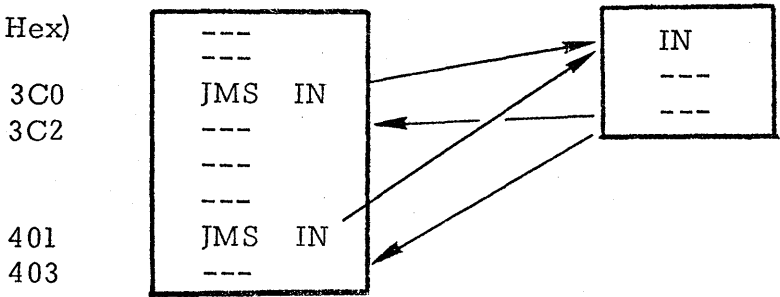

When the first JMS is executed, address 3C2H is written to the address stack, and control is transferred to IN. Execution of the BBL statement will cause the address 3C2H to be read from the stack and placed in the program counter, causing execution to continue at 3C2H (since the JMS occupies two bytes).

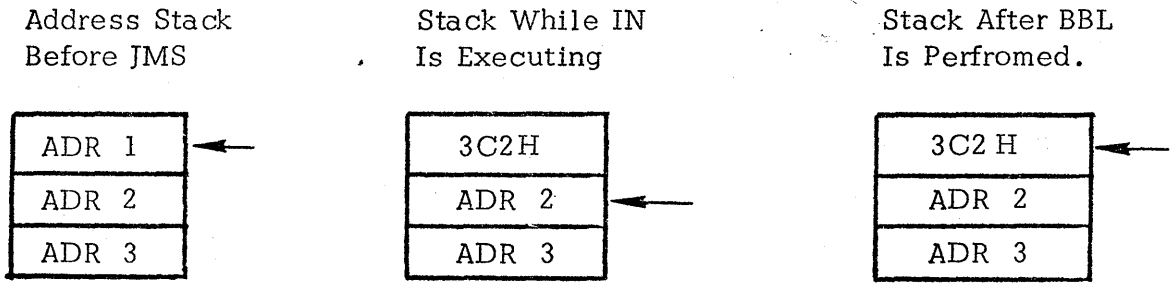

When the second JMS is executed, address 403H is written to the stack, and control is again transferred to IN. This time, the BBL will cause execution to resume at 403H.

Note that IN could have called another subroutine during its execution, causing another address to be written to the stack. This can occur only up to three levels, however, since the stack can hold only three addresses. Beyond this point, some addresses will be overwritten and BBL's will transfer program control to incorrect addresses.

### 4.3 BRANCH TABLE PSEUDOSUBROUTINE

Suppose a program consists of several separate routines, any of which may be executed depending upon some initial condition (such as a bit set in the accumulator). One way to code this would be to check each condition sequentially and branch to the routines accordingly as follows:

```
CONDITION = CONDITION 1 ?  
IF YES BRANCH TO ROUTINE 1  
CONDITION = CONDITION 2 ?  
IF YES BRANCH TO ROUTINE 2  
:  
BRANCH TO CONDITION N
```

A sequence as above is inefficient, and can be improved by using a branch table.

The logic at the beginning of the branch table program computes an index into the branch table. The branch table itself consists of a list of starting addresses for the routines to be selected. Using the table index, the branch table program loads the selected routine's starting address into a register pair and executes a "jump indirect" to that address. For example, consider a program that executes one of five routines depending upon which bit (possibly none) of the accumulator is set:

```
Jump to routine 0 if accumulator = 0000 B  
Jump to routine 1 if accumulator = 0001 B  
Jump to routine 2 if accumulator = 0010 B  
Jump to routine 3 if accumulator = 0100 B  
Jump to routine 4 if accumulator = 1000 B
```

A program that provides the above logic is given at the end of this section. The program is termed a "pseudosubroutine" because it is treated as a subroutine by the programmer, (i.e., it appears just once in memory), but it is entered via a regular "jump" instruction rather than via a JMS instruction. This is possible because the branch routines control subsequent execution, and will never return to the instruction following JMS;

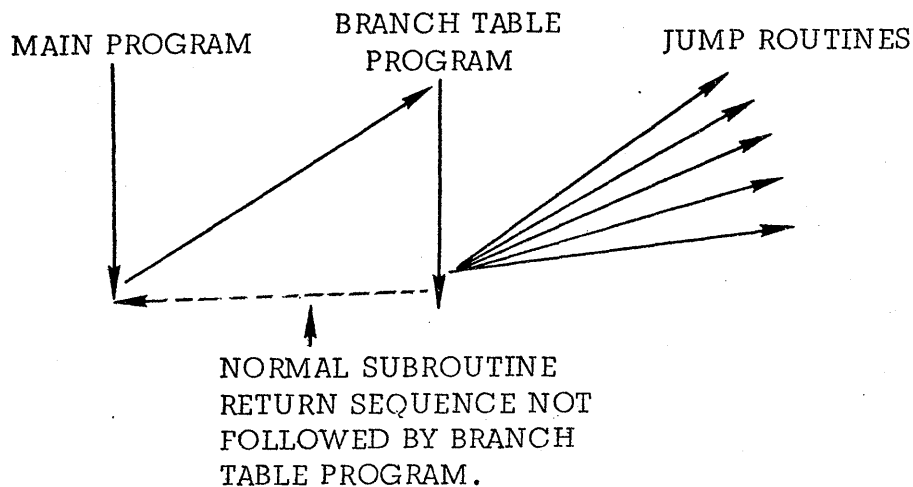

<u>LABEL</u>	<u>CODE</u>	<u>OPERAND</u>	
ST,	KBP		/ Convert Accum to branch table / index.
	IAC		/ If = 1111B, ERROR
	JCN	4 ERR	/ Jump if IAC produced zero.
	DAC		/ O.K., restore accumulator.
	FIM	0P BTL	/ Regs 0 and 1 = address of / branch table.
	CLC		/ Carry = 0
	ADD	1	/ Add index to branch table address
	XGH	1	/ Store back in reg 1
	JCN	10 NC	/ Jump if no carry
	INR	0	/ If carry, increment reg 0.
NC,	FIN	0P	/ Regs 0 and 1 = address of / routine.
	JIN	0P	/ Jump to correct routine.
	⋮		
BTL,	0 + RT0		/ Branch table. Each entry
	0 + RT1		/ is an 8-bit address
	0 + RT2		
	0 + RT3		
	0 + RT4		
	⋮		
ERR,	---		/ Error handling routine.

NOTE: Since FIM, FIN, and JIN operate with 8-bit addresses,  routines ST, BTL, and RT0 through RT4 must all reside in the same page of memory.

If the accumulator held 0100B when location ST was reached, the KBP would convert it to 0011B. The 8 bit address at BTL + 3 would therefore be loaded into registers 0 and 1, and the JIN would cause program control to be transferred to routine RT3.

## 4.4 LOGICAL OPERATIONS

This section gives three subroutines which produce the logical operations "AND", "OR", and "XOR" (exclusive -OR).

### 4.4.1 LOGICAL "AND"

The AND function of two bits is given by the following truth table:

	0	1
0	0	0
1	0	1

Since any bit ANDed with a zero produces a zero, and any bit ANDed with a one remains unchanged, the AND function is often used to zero groups of bits.

The following subroutine produces the AND, bit by bit, of the two 4-bit quantities held in index registers 0 and 1. The result is placed in register 0, while register 1 is set to 0. Index registers 2 and 3 are also used.

For example, if register 0 = 1110B and register 1 = 0011B, register 0 will be replaced with 0010B.

```
      1110 B
AND   0011 B
-----
      0010 B
```

The subroutine produces the AND of two bits by placing the bits in the leftmost position of the accumulator and register 2, respectively, and zeroing the rightmost three bits of the accumulator and register 2. Register 2 is then added to the accumulator, and the resulting carry is equal to the AND of the two bits.

<u>LABEL</u>	<u>CODE</u>	<u>OPERAND</u>		
AND,	FIM	1P	11	/ REG 2 = 0, REG 3 = 11
L1,	LDM	0		/ GET BIT OF REG 0; SET ACC = 0
	XCH	0		/ REG 0 DATA TO ACC; REG 0 = 0
	RAL			/ 1st 'AND' BIT TO CARRY
	XCH	0		/ SAVE SHIFTED DATA IN REG 0; ACC=0
	INC	3		/ DONE IF REG 3 = 0
	XCH	3		/ REG 3 TO ACC
	JCN	4	L2	/ RETURN IF ACC = 0
	XCH	3		/ OTHERWISE RESTORE ACC AND REG3
	RAR			/ BIT OF REG 0 IS ALONE IN ACC
	XCH	2		/ SAVE 1st 'AND' BIT IN REG 2
	XCH	1		/ GET BIT OF REG 1
	RAL			/ LEFT BIT TO CARRY
	XCH	1		/ SAVE SHIFTED DATA IN REG 1
	RAR			/ 2ND 'AND' BIT TO ACC
	ADD	2		/ 'ADD' GIVES 'AND' OF THE 2 BITS
	JUN	L1		/ IN CARRY
L2,	BBL	0		/ RETURN TO MAIN PROGRAM.

#### 4.4.2 LOGICAL "OR"

The OR function of two bits is given by the following truth table:

	0	1
0	0	1
1	1	1

Since any bit ORed with a one produces a one, and any bit ORed with a zero remains unchanged, the OR function is often used to set groups of bits to one.

The following subroutine produces the OR, bit by bit, of the two 4-bit quantities held in index registers 0 and 1. The result is placed in register 0, while register 1 is set to 0. Index registers 2 and 3 are also used.



For example, if register 0 = 0100B and register 1 = 0011B, register 0 will be replaced with 0111B.

```

                0100 B
OR             0011 B
                0111 B
    
```

The subroutine produces the OR of two bits by placing the bits in the leftmost position of the accumulator and register 2, respectively, and zeroing the rightmost three bits of the accumulator and register 2. Register 2 is then added to the accumulator. If the resulting carry = 1, the OR of the two bits = 1. If the resulting carry = 0, the OR of the two bits is equal to the leftmost bit of the accumulator.

<u>LABEL</u>	<u>CODE</u>	<u>OPERAND</u>	
OR,	FIM	1P 11	/ REG 2 = 0, REG 3 = 11
L1,	LDM	0	/ GET BIT OF REG 0; SET ACC = 0
	XCH	0	/ REG 0 DATA TO ACC; REG 0 = 0
	RAL		/ 1st 'OR' BIT TO CARRY
	XCH	0	/ SAVE SHIFTED DATA IN REG 0; ACC=0
	INC	3	/ DONE IF REG 3 = 0
	XCH	3	/ REG 3 TO ACC
	JCN	4 L2	/ RETURN IF ACC = 0
	XCH	3	/ OTHERWISE RESTORE ACC AND REG3
	RAR		/ BIT OF REG 0 IS ALONE IN ACC
	XCH	2	/ SAVE 1st 'OR' BIT IN REG 2
	LDM	0	/ GET BIT IN REG 1; SET ACC = 0
	XCH	1	
	RAL		/ LEFT BIT TO CARRY
	XCH	1	/ SAVE SHIFTED DATA IN REG 1
	RAR		/ 2ND 'OR' BIT TO ACC
	ADD	2	/ PRODUCE THE OR OF THE BITS
	JCN	2 L1	/ JUMP IF CARRY = 1 BECAUSE 'OR'=1
	RAL		/ OTHERWISE 'OR' = LEFT BIT OF
	JUN	L1	/ ACCUMULATOR
L2,	BBL	0	/ TRANSMIT TO CARRY BY RAL

### 4.4.3 LOGICAL "XOR" EXCLUSIVE-OR

The XOR (exclusive -OR) function of two bits is given by the following truth table:

	0	1
0	0	1
1	1	0

Since the exclusive OR of two equal bits produces a zero and the exclusive OR of two unequal bits produces a one, the exclusive OR function can be used to test two quantities for equality. If the quantities differ in any bit position, a one will be produced in the result.

The following subroutine produces the exclusive - OR of the two 4-bit quantities held in index registers 0 and 1. The result is placed in register 0, while register 1 is set to 0. Index registers 2 and 3 are also used.

For example if register 0 = 0011B and register 1 = 0010B, register 0 will be replaced with 0001B.

```
      0 0 1 1 B
XOR   0 0 1 0 B
-----
      0 0 0 1 B
```

The subroutine produces the XOR of two bits by placing the bits in the leftmost position of the accumulator and register 2, respectively, and zeroing the rightmost three bits of the accumulator and register 2. Register 2 is then added to the accumulator. The XOR of the two bits is then equal to the leftmost bit of the accumulator.

<u>LABEL</u>	<u>CODE</u>	<u>OPERAND</u>		
XOR,	FIM	1P	11	/ REG 2 = 0, REG 3 = 11
L1,	LDM	0		/ GET BIT OF REG 0; SET ACC = 0
	XCH	0		/ REG 0 DATA TO ACC; REG 0=0
	RAL			/ 1ST XOR BIT TO CARRY
	XCH	0		/ SAVE SHIFTED DATA IN REG 0; ACC = 0
	INC	3		/ DONE IF REG 3 = 0
	XCH	3		/ REG 3 TO ACC
	JCN	4	L2	/ RETURN IF ACC = 0.
	XCH	3		/ OTHERWISE RESTORE ACC & REG 3
	RAR			/ BIT OF REG 0 IS ALONE IN ACC
	XCH	2		/ SAVE 1ST XOR BIT IN REG 2
	LDM	0		/ GET BIT IN REG 1; SET ACC = 0
	XCH	1		
	RAL			/ LEFT BIT TO CARRY
	XCH	1		/ SAVE SHIFTED DATA IN REG 1
	RAR			/ 2ND 'XOR' BIT TO ACC
	ADD	2		/ PRODUCE THE XOR OF THE BITS
	RAL			/ XOR = LEFT BIT OF ACCUM; TRANSMIT
	JUN	L1		/ TO CARRY BY RAL.
L2,	BBL	0		

## 4.5 MULTI-DIGIT ADDITION

The carry bit may be used to add unsigned data quantities of arbitrary length. Consider the following addition of two 4-digit hexadecimal numbers:

$$\begin{array}{r} 381C \\ + 69F2 \\ \hline A20E \end{array}$$

This addition may be performed by setting the carry bit = 0, adding the two low-order digits of the numbers, then adding the resulting carry to the two next higher order digits, and so on:

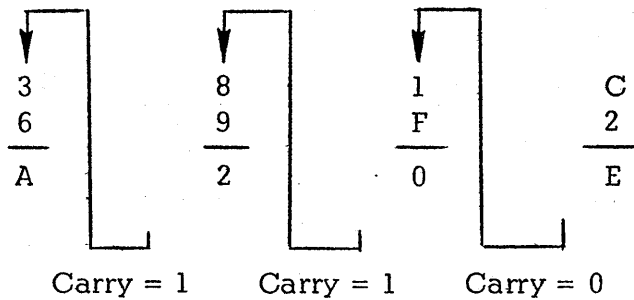

The following subroutine will perform a sixteen digit addition, making these assumptions:

The two numbers to be added are stored in DATA RAM chip 0, registers 0 and 1.

The numbers are stored with the least significant digit first (in character 0).

The result will be stored least significant digit first in register 1, replacing the contents of register 1.

Index register 8 will count the number of digits (up to 16) which have been added.

DATA RAM CHIP 0 BEFORE ADDITION

Status Chars.

Register 0	C	1	8	3	0	0	0	0	0	0	0	0	0	0	0	0	0	0				
1	2	F	9	6	0	0	0	0	0	0	0	0	0	0	0	0	0	0				
2																						
3																						

DATA RAM CHIP 0 AFTER ADDITION

Register 0	C	1	8	3	0	0	0	0	0	0	0	0	0	0	0	0	0	0				
1	E	0	2	A	0	0	0	0	0	0	0	0	0	0	0	0	0	0				
2																						
3																						

AD,	FIM	2P	0	/ REG PAIR 2P = RAM CHIP 0 OF
	FIM	3P	16	/ REG 0
	CLB			/ REG PAIR 3P = RAM CHIP 0 OF
	XCH	8		/ REG 1
AD1,	SRC	2P		/ SET CARRY = 0
	RDM			/ SET DIGIT COUNTER = 0
	SRC	3P		/ SELECT RAM REG 0
	ADM			/ SELECT RAM REG 1
	WRM			/ ADD DIGIT + CARRY TO ACCUMU-
	INC	5		/ LATOR
	INC	7		/ WRITE RESULT TO REG 1
	ISZ	8	AD1	/ ADDRESS NEXT CHAR. OF RAM
OVR,	BBL	0		/ REG 0
				/ ADDRESS NEXT CHAR OF RAM
				/ REG 1
				/ BRANCH IF DIGIT COUNTER
				< 16 (NON ZERO)

When location OVR is reached, RAM register 1 will contain the sum of the two 16 digit numbers arranged from low order digit to high order digit. (The reason multi-digit numbers are arranged this way is that it is easier to add numbers from low order to high order digit, and it is easier to increment addresses than to decrement them.)

The first time through the program loop, index register pair 2 (index register 4 and 5) contains 0 and index register pair 3 (index registers 6 and 7) contains 16, referencing the first data characters of DATA RAM registers 0 and 1, respectively.

On succeeding repetitions of the loop, index registers 5 and 7 are incremented, referencing sequential data characters, until all 16 digits have been added.

#### 4.6 MULTI-DIGIT SUBTRACTION

The carry bit may be used to subtract unsigned data quantities of arbitrary length. Consider the following subtraction of two 4-digit hexadecimal numbers:

$$\begin{array}{r} 54BA \\ - 14F6 \\ \hline 3FC4 \end{array}$$

This subtraction may be performed by first setting the carry bit = 1. Then for each pair of digits, the program must complement the carry bit and perform the subtraction. By this process, the carry bit will adjust the differences, taking into account any borrows which may have occurred.

This process applied to the above subtraction proceeds as follows:

- (1) Set carry bit = 1.
- (2) Complement carry bit. Carry now = 0.
- (3) Subtract low order digits:

$$\begin{array}{r} A = 1010B \\ \overline{6} = 1001B \\ \text{carry} = \quad 1 \\ \hline \underline{1} | 0100B = 4 \end{array}$$

(4) Complement resulting carry. Carry now = 0.

(5) Subtract next digits:

$$\begin{array}{r} B = 1011 \text{ B} \\ \overline{F} = 0000 \text{ B} \\ \hline \text{carry} = \underline{\quad 1} \\ \underline{0} \text{ | } 1100 \text{ B} = \text{CH} \end{array}$$

(6) Complement resulting carry. Carry now = 1.

(7) Subtract next digits:

$$\begin{array}{r} 4 = 0100 \text{ B} \\ \overline{4} = 1011 \text{ B} \\ \hline \text{carry} = \underline{\quad 0} \\ \underline{0} \text{ | } 1111 \text{ B} = \text{FH} \end{array}$$

(8) Complement resulting carry. Carry now = 1.

(9) Subtract next digits:

$$\begin{array}{r} 5 = 0101 \text{ B} \\ \overline{1} = 1110 \text{ B} \\ \hline \text{carry} = \underline{\quad 0} \\ \underline{1} \text{ | } 0011 \text{ B} = 3 \end{array}$$

Thus the correct result, 3FC4H, is obtained. The following subroutine will perform a sixteen digit subtraction, making these assumptions:

As in the example of Section 4.2, the two numbers are stored in DATA RAM chip 0, registers 0 and 1 (register 1 containing the subtrahend). The numbers are stored with the least significant digit in character 0, and the result is stored back into register 1. Index register 8 will count the number of digits (up to 16) which have been subtracted.

SB,	FIM	2P	0	/ REG PAIR 2P = RAM CHIP 0
				/ REG 0
	FIM	3P	16	/ REG PAIR 3P = RAM CHIP 0
				/ REG 1
	CLB			
	XCH	8		/ SET DIGIT COUNTER = 0
	STC			/ SET CARRY = 1
SBI,	CMC			/ COMPLEMENT CARRY BIT
	SRC	2P		/ SELECT RAM REG 0
	RDM			/ READ DIGIT TO ACCUMULATOR
	SRC	3P		/ SELECT RAM REG 1
	SBM			/ SUBTRACT DIGIT AND CARRY
				/ FROM ACCUMULATOR
	WRM			/ WRITE RESULT TO REG 1
	INC	5		/ ADDRESS NEXT CHAR. OF RAM
				/ REG 0
	INC	7		/ ADDRESS NEXT CHAR. OF RAM
				/ REG 1
	ISZ	8	SBI	/ BRANCH IF DIGIT COUNTER
				/ < 16 (NON-ZERO).
OV,	BBL	0		

When location OV is reached, RAM register 1 will contain the difference of the two 16 digit numbers. Note that the carry bit from the previous subtraction is complemented by the CMC instruction each time through the program loop.



## 4.7 DECIMAL ADDITION

Each 4 bit data quantity may be treated as a decimal number as long as it represents one of the decimal digits from 0 through 9, and does not contain any of the bit patterns representing the hexadecimal digits A through F. In order to preserve this decimal interpretation when performing addition, the value 6 must be added to the accumulator whenever an addition produces a result between 10 and 15. This is because each 4 bit data quantity can hold 6 more combinations of bits than there are decimal digits.

The DAA (decimal adjust accumulator) instruction is provided for this purpose. Also, to permit addition of multi-digit decimal numbers, the DAA adds 6 to the accumulator whenever the carry bit is set indicating a decimal carry from previous additions. The carry bit is unaffected unless the addition of 6 produces a carry, in which case the carry bit is set.

To perform the decimal addition:

$$\begin{array}{r} 469 \\ + \underline{329} \\ \hline 798 \end{array}$$

the process works as follows.

- (1) Clear the carry and add the lowest-order digits

$$\begin{array}{r} 9 = 1001 \text{ B} \\ 9 = 1001 \text{ B} \\ \text{carry} = \underline{0} \\ \hline 1 \mid 0010 \text{ B} \\ \swarrow \text{Carry} = 1 \end{array}$$

- (2) Perform a DAA operation, which will add 6 to the accumulator. Since no carry is produced by this operation, the carry bit is left unaffected, remaining = 1.

$$\begin{array}{r}
 \text{Accum.} = 0010 \text{ B} \\
 6 = 0110 \text{ B} \\
 \text{Carry} = \underline{\quad 0} \\
 \hline
 0 | 1000 \text{ B} = 8
 \end{array}$$

(3) Add the next two digits.

$$\begin{array}{r}
 6 = 0110 \text{ B} \\
 2 = 0010 \text{ B} \\
 \text{Carry} = \underline{\quad 1} \\
 \hline
 0 | 1001 \text{ B} = 9 \\
 \swarrow \\
 \text{Carry} = 0
 \end{array}$$

(4) Perform a DAA operation. Since the accumulator is not greater than 9 and the carry is not set, no action occurs.

(5) Add the next two digits:

$$\begin{array}{r}
 4 = 0100 \text{ B} \\
 3 = 0011 \text{ B} \\
 \text{Carry} = \underline{\quad 0} \\
 \hline
 0 | 0111 \text{ B} = 7 \\
 \swarrow \\
 \text{Carry} = 0
 \end{array}$$

(6) Perform a DAA operation. Again, no action occurs. Thus the correct decimal result 798 is generated in three 4 bit data characters.

A subroutine which adds two 16 digit decimal numbers, then, is exactly analagous to the 16 digit hexadecimal addition subroutine of Section 4.2, and may be produced by inserting the instruction DAA after the ADM instruction of that example.

## 4.8 DECIMAL SUBTRACTION

Each 4 bit data quantity may be treated as a decimal number as long as it represents one of the decimal digits 0 through 9. The TCS (transfer carry subtract) and DAA (decimal adjust accumulator) may be used to subtract two decimal numbers and produce a decimal number. In fact, the TCS instruction permits subtraction of multi-digit decimal numbers.

The process consists of generating the ten's complement of the subtrahend digit (the difference between the subtrahend digit and 10 decimal), and adding the result to the minuend digit. For instance, to subtract 2 from 7, the ten's complement of 2 ( $10-2=8$ ) is added to 7, producing 15 decimal which, when truncated to a 4 bit quantity gives 5 (the required result). If a borrow was generated by the previous subtraction, the 9's complement of the subtrahend digit is produced to compensate for the borrow.

In detail, the procedure for subtracting one multi-digit decimal number from another is as follows:

- (1) Set the carry bit = 1 indicating no borrow.
- (2) Use the TCS instruction to set the accumulator to either 9 or 10 decimal.
- (3) Subtract the subtrahend digit from the accumulator, producing either the 9's or 10's complement.
- (4) Set the carry bit = 0.
- (5) Add the minuend digit to the accumulator.
- (6) Use the DAA instruction to make sure the result in the accumulator is in decimal format, and to indicate a borrow in the carry bit if one occurred.  
Save this result.
- (7) If there are more digits to subtract, go to step 2.  
Otherwise stop,

Example: Perform the decimal subtraction

$$\begin{array}{r} 51 \\ - 38 \\ \hline 13 \end{array}$$

- (1) Set carry = 1.
- (2) TCS sets accumulator = 1010B and carry = 0.
- (3) Subtract the subtrahend digit 8 from the accumulator.

$$\begin{array}{r} \text{Accumulator} = 1010 \text{ B} \\ \underline{8} = 0111 \text{ B} \\ \text{Carry} = \quad 1 \\ \hline 0010 \text{ B} \end{array}$$

- (4) Set carry = 0.
- (5) Add minuend digit 1 to accumulator.

$$\begin{array}{r} \text{Accumulator} = 0010 \text{ B} \\ 1 = 0001 \text{ B} \\ \text{Carry} = \quad 0 \\ \hline 0 \mid 0011 \text{ B} = 3 \\ \swarrow \text{Carry} = 0 \end{array}$$

- (6) DAA leaves accumulator = 3 = first digit of result, and carry = 0, indicating that a borrow occurred.
- (7) TCS sets accumulator = 1001B and carry = 0.
- (8) Subtract the subtrahend digit 3 from the accumulator.

$$\begin{array}{r} \text{Accumulator} = 1001 \text{ B} \\ \underline{3} = 1100 \text{ B} \\ \text{Carry} = \quad 1 \\ \hline 0110 \text{ B} \end{array}$$

(9) Set carry = 0.

(10) Add minuend digit 5 to accumulator.

$$\begin{array}{r} \text{Accumulator} = 0110 \text{ B} \\ 5 = 0101 \text{ B} \\ \text{Carry} = \quad 0 \\ \hline 0 | 1011 \text{ B} \\ \swarrow \\ \text{Carry} = 0 \end{array}$$

(11) DAA adds 6 to accumulator and sets carry = 1, indicating that no borrow occurred.

$$\begin{array}{r} \text{Accumulator} = 1011 \text{ B} \\ 6 = \underline{0110} \text{ B} \\ \hline 1 | 0001 \text{ B} = 1 = \text{Second digit of result.} \\ \swarrow \\ \text{Carry} = 1 \end{array}$$

Therefore the result of subtracting 38 from 51 is 13.

The following subroutine will subtract one 16 digit decimal number from another, using the following assumptions.

The minuend is stored least significant digit first in DATA RAM chip 0, register 0.

The subtrahend is stored least significant digit first in DATA RAM chip 0, register 1.

The result will be stored least significant digit first in DATA RAM chip 0, register 0, replacing the minuend.

Index register 8 will count the number of digits (up to 16) which have been subtracted.

SD,	FIM	2P	0	/ REG PAIR 2P = RAM CHIP 0, REG 0
	FIM	3P	16	/ REG PAIR 3P = RAM CHIP 0
				/ REG 1
	CLB			
	XCH	8		/ SET DIGIT COUNTER = 0
	STC			/ SET CARRY = 1
SD1,	TCS			/ ACCUMULATOR = 9 OR 10
	SRC	3P		/ SELECT RAM REG 1
	SBM			/ PRODUCE 9's OR 10's
				/ COMPLEMENT
	CLC			/ SET CARRY = 0
	SRC	2P		/ SELECT RAM REG 0
	ADM			/ ADD MINUEND TO ACCUMU-
				/ LATOR
	DAA			/ ADJUST ACCUMULATOR
	WRM			/ WRITE RESULT TO REG 0
	INC	5		/ ADDRESS NEXT CHAR. OF RAM
				/ REG 0
	INC	7		/ ADDRESS NEXT CHAR. OF RAM
				/ REG 1
	ISZ	8	SD1	/ BRANCH IF DIGIT COUNTER < 16
				/ (NON-ZERO).
DN,	BBL	0		

#### 4.9 FLOATING POINT NUMBERS

The structure of DATA RAM chips is fully described in Section 2.3.3. One use to which a 16-character DATA RAM register and its 4 status characters can be put is to store a 16 digit decimal floating point number.

Such a number can be represented in the form:

$$\pm .\text{DDDDDDDDDDDDDDDD} * 10^{\pm EE}$$

The 16 data characters of a RAM register could then be used to store the digits of the number, two status characters could be used to hold the digits of the exponent, while the remaining two status characters would hold the signs of the number and its exponent.

If a value of one is chosen to represent minus and a value of zero is chosen to represent plus, status characters 0 and 1 hold the exponent digits, status character 2 holds the exponent sign and status character 3 holds the number's sign, then the number

$$+.1234567890812489 \times 10^{-23}$$

would appear in a RAM register as follows:

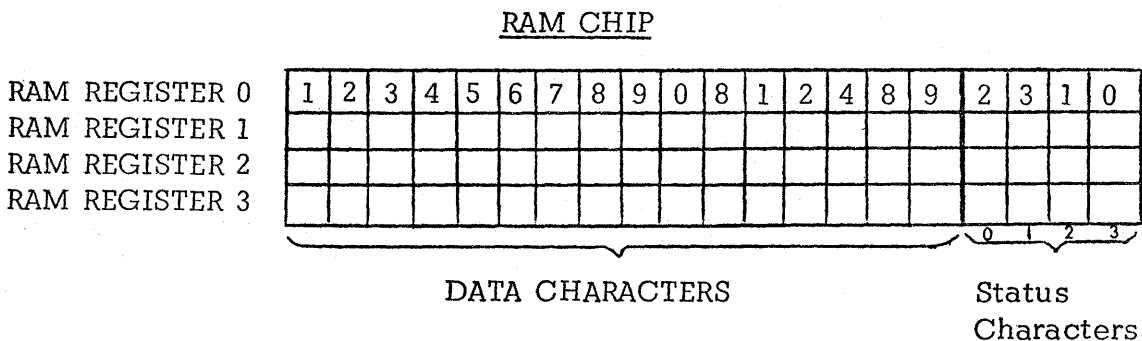

APPENDIX "A"

-- INSTRUCTION SUMMARY --

This appendix provides a summary of 4004 instructions. Abbreviations used are as follows:

ABBREVIATION	DESCRIPTION
A	The accumulator.
$A_n$	Bit n in the accumulator, where n may have any value from 0 to 3.
ADDR	A read-only memory or program random-access memory address.
carry	The carry bit.
PC	The 12 bit Program Counter.
PCH	The high-order 4 bits of the Program Counter.
PCL	The low-order 4 bits of the Program Counter.
PCM	The middle 4 bits of the Program Counter.
RAM	Random-access memory.
REG	Any index register from 0 to 15.
R0	Index register 0.
R1	Index register 1.
ROM	Read-only memory.
RP	Any index register pair from 0P to 7P.
STK	The address stack.
<u>value</u>	The number obtained by complementing each bit of value.



(Continued):

ABBREVIATION	DESCRIPTION
X:Y	The value obtained by concatenating the values X and Y.
[ ]	An optional field enclosed by brackets.
( )	Contents of register or memory enclosed by parentheses.
←	Replace value on left hand side of arrow with value on right hand side of arrow.

## A.1 INDEX REGISTER INSTRUCTIONS

### Format:

[LABEL, ]      FIN      RP  
 -- or --  
 [LABEL, ]      INC      REG

Code	Description	
FIN	$(RP) \leftarrow ((PCH:R0:R1))$	Load RP with 8 bits of ROM data addressed by register pair 0.
INC	$(REG) \leftarrow (REG) + 1$	Increment register REG.

## A.2 INDEX REGISTER TO ACCUMULATOR INSTRUCTIONS

### Format:

[LABEL, ]      CODE      REG

Code	Description	
ADD	$(A) \leftarrow (A) + (REG) + (\text{carry})$	Add REG plus carry bit to accumulator.
SUB	$(A) \leftarrow (A) + (\overline{REG}) + (\overline{\text{carry}})$	Subtract REG from accumulator with borrow.
LD	$(A) \leftarrow (REG)$	Load accumulator from REG.
XCH	$(A) \longleftrightarrow (REG)$	Exchange contents of accumulator and REG.

### A.3 ACCUMULATOR INSTRUCTIONS

Format:

[ LABEL ]      CODE

Code	Description
CLB	$(A) \leftarrow 0, (\text{carry}) \leftarrow 0$ Clear both accumulator and carry.
CLC	$(\text{carry}) \leftarrow 0$ Clear carry.
IAC	$(A) \leftarrow (A) + 1$ Increment accumulator.
CMC	$(\text{carry}) \leftarrow \overline{(\text{carry})}$ Complement carry.
CMA	$(A) \leftarrow \overline{(A)}$ Complement each bit of the accumulator.
RAL	$A_{n+1} \leftarrow A_n, (\text{carry}) \leftarrow A_3, A_0 \leftarrow (\text{carry})$ Rotate accumulator left through carry.
RAR	$A_n \leftarrow A_{n+1}, (\text{carry}) \leftarrow A_0, A_3 \leftarrow (\text{carry})$ Rotate accumulator right through carry.
TCC	$(A) \leftarrow 0, A_0 \leftarrow (\text{carry}), (\text{carry}) \leftarrow 0$ Transmit the value of the carry to the accumulator, then clear carry.
DAC	$(A) \leftarrow (A) - 1$ Decrement accumulator
TCS	If $(\text{carry}) = 0, (A) \leftarrow 9_{10}$ If $(\text{carry}) = 1, (A) \leftarrow 10_{10}$ $(\text{carry}) \leftarrow 0$ Adjust accumulator for decimal subtract.
STC	$(\text{carry}) \leftarrow 1$ Set carry.
DAA	If $(A) > 9_{10}$ or $(\text{carry}) = 1, (A) \leftarrow (A) + 6$ Adjust accumulator for decimal add.
KBP	Convert $A_3 A_2 A_1 A_0$ Convert accumulator from 1 of n code to binary value.

#### A.4 IMMEDIATE INSTRUCTIONS

Format:

```

[LABEL, ]      FIM      RP  DATA
               -- or --
[LABEL, ]      LDM      DATA
    
```

Code	Description	
FIM	(RP) ← DATA	Load 8 bit immediate DATA into register pair RP.
LDM	(A) ← DATA	Load 4-bit immediate DATA into the accumulator.

#### A.5 TRANSFER OF CONTROL INSTRUCTIONS

Format:

```

[LABEL, ]      JCN      CN  ADDR
               -- or --
[LABEL, ]      JIN      RP
               -- or --
[LABEL, ]      ISZ      REG
               -- or --
[LABEL, ]      JUN      ADDR
    
```

Code	Description
JUN	$(PCH: PCM: PCL) \leftarrow ADDR$ Jump to location ADDR.
JIN	$(PCM: PCL) \leftarrow (RP)$ Jump to the address in register pair RP.
JCN	If CN true, $(PCM: PCL) \leftarrow ADDR$ Jump to ADDR if condition true. If CN false, $(PL) \leftarrow (PL) + 2$
ISZ	$(REG) \leftarrow (REG) + 1$ Increment REG. If zero, skip. If result = 0, $(PL) \leftarrow (PL) + 2$ If non zero, jump to ADDR If result = 1, $(PCM: PCL) \leftarrow ADDR$

#### A.6 SUBROUTINE LINKAGE INSTRUCTIONS

Format:

```

[LABEL,]      JMS      ADDR
                  -- or --
[LABEL,]      BBL      DATA

```

Code	Description
JMS	$(STK) \leftarrow (PC), (PC) \leftarrow ADDR$ Call subroutine and push return address onto stack.
BBL	$(PC) \leftarrow (STK), (A) \leftarrow DATA$ Return from subroutine and load accumulator with immediate DATA.

### A.7 NOP INSTRUCTION

Format:

[LABEL,] NOP

Code	Description
NOP	----- No operation

### A.8 MEMORY SELECTION INSTRUCTIONS

Format:

[LABEL,] SRC RP

-- or --

[LABEL,] DCL

Code	Description
SRC	DATA BUS $\leftarrow$ (RP)      Contents of RP select a RAM or ROM address to be used by I/O and RAM instructions.
DCL	CPU $\leftarrow$ $A_2 : A_1 : A_0$ Select a particular RAM bank.

## A.9 I/O AND RAM INSTRUCTIONS

### Format:

[LABEL,] CODE

Code	Description
WRM	$(RAM) \leftarrow A$ Write accumulator to RAM.
WMP	RAM output port $\leftarrow (A)$ Write accumulator to RAM output port.
WRR	ROM output port $\leftarrow (A)$ Write accumulator to ROM output port.
WPM	(PRAM) $\leftarrow (A)$ Write accumulator to Program RAM.
WRn	RAM status character n $\leftarrow (A)$ Write accumulator to RAM status character n (n = 0, 1, 2 or 3).
RDM	$(A) \leftarrow RAM$ Load accumulator from RAM.
RDR	$(A) \leftarrow ROM$ input port Load accumulator from ROM input port.
RDn	$(A) \leftarrow RAM$ status character n Load accumulator from RAM status character n (n = 0, 1, 2, or 3).
ADM	$(A) \leftarrow (A) + (RAM) + (carry)$ Add RAM data plus carry to accumulator.
SBM	$(A) \leftarrow (A) + \overline{(RAM)} + \overline{(carry)}$ Subtract RAM data from accumulator with borrow.

## APPENDIX "B"

### -- INSTRUCTION MACHINE CODES --

In order to help the programmer examine memory when debugging programs, this appendix provides the assembly language instruction represented by each of the 256 possible instruction code bytes.

Where an instruction occupies two bytes, only the first (code) byte is given.



DEC	OCTAL	HEX	MNEMONIC	COMMENT
0	000	00	NOP	
1	001	01	----	
2	002	02	----	
3	003	03	----	
4	004	04	----	
5	005	05	----	
6	006	06	----	
7	007	07	----	
8	010	08	----	
9	011	09	----	
10	012	0A	----	
11	013	0B	----	
12	014	0C	----	
13	015	0D	----	
14	016	0E	----	
15	017	0F	----	
16	020	10	JCN	CN = 0
17	021	11	JCN	CN = 1
18	022	12	JCN	CN = 2
19	023	13	JCN	CN = 3
20	024	14	JCN	CN = 4
21	025	15	JCN	CN = 5
22	026	16	JCN	CN = 6
23	027	17	JCN	CN = 7
24	030	18	JCN	CN = 8
25	031	19	JCN	CN = 9
26	032	1A	JCN	CN = 10
27	033	1B	JCN	CN = 11
28	034	1C	JCN	CN = 12
29	035	1D	JCN	CN = 13
30	036	1E	JCN	CN = 14
31	037	1F	JCN	CN = 15
32	040	20	FIM	0P
33	041	21	SRC	0P
34	042	22	FIM	1P
35	043	23	SRC	1P
36	044	24	FIM	2P
37	045	25	SRC	2P
38	046	26	FIM	3P
39	047	27	SRC	3P
40	050	28	FIM	4P

DEC	OCTAL	HEX	MNEMONIC	COMMENT
41	051	29	SRC	4P
42	052	2A	FIM	5P
43	053	2B	SRC	5P
44	054	2C	FIM	6P
45	055	2D	SRC	6P
46	056	2E	FIM	7P
47	057	2F	SRC	7P
48	060	30	FIN	0P
49	061	31	JIN	0P
50	062	32	FIN	1P
51	063	33	JIN	1P
52	064	34	FIN	2P
53	065	35	JIN	2P
54	066	36	FIN	3P
55	067	37	JIN	3P
56	070	38	FIN	4P
57	071	39	JIN	4P
58	072	3A	FIN	5P
59	073	3B	JIN	5P
60	074	3C	FIN	6P
61	075	3D	JIN	6P
62	076	3E	FIN	7P
63	077	3F	JIN	7P
64	100	40	JUN	} Second hex digit is part of jump address.
65	101	41	JUN	
66	102	42	JUN	
67	103	43	JUN	
68	104	44	JUN	
69	105	45	JUN	
70	106	46	JUN	
71	107	47	JUN	
72	110	48	JUN	
73	111	49	JUN	
74	112	4A	JUN	
75	113	4B	JUN	
76	114	4C	JUN	
77	115	4D	JUN	
78	116	4E	JUN	
79	117	4F	JUN	
80	120	50	JMS	
81	121	51	JMS	

DEC	OCTAL	HEX	MNEMONIC	COMMENT
82	122	52	JMS	} Second hex digit is part of jump address.
83	123	53	JMS	
84	124	54	JMS	
85	125	55	JMS	
86	126	56	JMS	
87	127	57	JMS	
88	130	58	JMS	
89	131	59	JMS	
90	132	5A	JMS	
91	133	5B	JMS	
92	134	5C	JMS	
93	135	5D	JMS	
94	136	5E	JMS	
95	137	5F	JMS	
96	140	60	INC 0	
97	141	61	INC 1	
98	142	62	INC 2	
99	143	63	INC 3	
100	144	64	INC 4	
101	145	65	INC 5	
102	146	66	INC 6	
103	147	67	INC 7	
104	150	68	INC 8	
105	151	69	INC 9	
106	152	6A	INC 10	
107	153	6B	INC 11	
108	154	6C	INC 12	
109	155	6D	INC 13	
110	156	6E	INC 14	
111	157	6F	INC 15	
112	160	70	ISZ 0	
113	161	71	ISZ 1	
114	162	72	ISZ 2	
115	163	73	ISZ 3	
116	164	74	ISZ 4	
117	165	75	ISZ 5	
118	166	76	ISZ 6	
119	167	77	ISZ 7	
120	170	78	ISZ 8	
121	171	79	ISZ 9	
122	172	7A	ISZ 10	

DEC	OCTAL	HEX	MNEMONIC	COMMENT
123	173	7B	ISZ	11
124	174	7C	ISZ	12
125	175	7D	ISZ	13
126	176	7E	ISZ	14
127	177	7F	ISZ	15
128	200	80	ADD	0
129	201	81	ADD	1
130	202	82	ADD	2
131	203	83	ADD	3
132	204	84	ADD	4
133	205	85	ADD	5
134	206	86	ADD	6
135	207	87	ADD	7
136	210	88	ADD	8
137	211	89	ADD	9
138	212	8A	ADD	10
139	213	8B	ADD	11
140	214	8C	ADD	12
141	215	8D	ADD	13
142	216	8E	ADD	14
143	217	8F	ADD	15
144	220	90	SUB	0
145	221	91	SUB	1
146	222	92	SUB	2
147	223	93	SUB	3
148	224	94	SUB	4
149	225	95	SUB	5
150	226	96	SUB	6
151	227	97	SUB	7
152	230	98	SUB	8
153	231	99	SUB	9
154	232	9A	SUB	10
155	233	9B	SUB	11
156	234	9C	SUB	12
157	235	9D	SUB	13
158	236	9E	SUB	14
159	237	9F	SUB	15
160	240	A0	LD	0
161	241	A1	LD	1
162	242	A2	LD	2
163	243	A3	LD	3

DEC	OCTAL	HEX	MNEMONIC	COMMENT
164	244	A4	LD	4
165	245	A5	LD	5
166	246	A6	LD	6
167	247	A7	LD	7
168	250	A8	LD	8
169	251	A9	LD	9
170	252	AA	LD	10
171	253	AB	LD	11
172	254	AC	LD	12
173	255	AD	LD	13
174	256	AE	LD	14
175	257	AF	LD	15
176	260	B0	XCH	0
177	261	B1	XCH	1
178	262	B2	XCH	2
179	263	B3	XCH	3
180	264	B4	XCH	4
181	265	B5	XCH	5
182	266	B6	XCH	6
183	267	B7	XCH	7
184	270	B8	XCH	8
185	271	B9	XCH	9
186	272	BA	XCH	10
187	273	BB	XCH	11
188	274	BC	XCH	12
189	275	BD	XCH	13
190	276	BE	XCH	14
191	277	BF	XCH	15
192	300	C0	BBL	0
193	301	C1	BBL	1
194	302	C2	BBL	2
195	303	C3	BBL	3
196	304	C4	BBL	4
197	305	C5	BBL	5
198	306	C6	BBL	6
199	307	C7	BBL	7
200	310	C8	BBL	8
201	311	C9	BBL	9
202	312	CA	BBL	10
203	313	CB	BBL	11
204	314	CC	BBL	12

DEC	OCTAL	HEX	MNEMONIC	COMMENT
205	315	CD	BBL 13	
206	316	CE	BBL 14	
207	317	CF	BBL 15	
208	320	D0	LDM 0	
209	321	D1	LDM 1	
210	322	D2	LDM 2	
211	323	D3	LDM 3	
212	324	D4	LDM 4	
213	325	D5	LDM 5	
214	326	D6	LDM 6	
215	327	D7	LDM 7	
216	330	D8	LDM 8	
217	331	D9	LDM 9	
218	332	DA	LDM 10	
219	333	DB	LDM 11	
220	334	DC	LDM 12	
221	335	DD	LDM 13	
222	336	DE	LDM 14	
223	337	DF	LDM 15	
224	340	E0	WRM	
225	341	E1	WMP	
226	342	E2	WRR	
227	343	E3	WPM	
228	344	E4	WR0	
229	345	E5	WR1	
230	346	E6	WR2	
231	347	E7	WR3	
232	350	E8	SBM	
233	351	E9	RDM	
234	352	EA	RDR	
235	353	EB	ADM	
236	354	EC	RD0	
237	355	ED	RD1	
238	356	EE	RD2	
239	357	EF	RD3	
240	360	F0	CLB	
241	361	F1	CLC	
242	362	F2	IAC	
243	363	F3	CMC	
244	364	F4	CMA	
245	365	F5	RAL	

DEC	OCTAL	HEX	MNEMONIC	COMMENT
246	366	F6	RAR	
247	367	F7	TCC	
248	370	F8	DAC	
249	371	F9	TCS	
250	372	FA	STC	
251	373	FB	DAA	
252	374	FC	KBP	
253	375	FD	DCL	
254	376	FE	---	
255	377	FF	---	

APPENDIX "C"

-- ASCII TABLE --

The 4004 uses a seven-bit ASCII code, which is the normal 8 bit ASCII code with the parity (high order) bit always reset.

Graphic or Control	ASCII (Hexadecimal)
NULL	00
SOM	01
EOA	02
EOM	03
EOT	04
WRU	05
RU	06
BELL	07
FE	08
H. Tab	09
Line Feed	0A
V. Tab	0B
Form	0C
Return	0D
SO	0E
SI	0F
DCO	10
X-On	11
Tape Aux. On	12
X-Off	13
Tape Aux. Off	14
Error	15
Sync	16
LEM	17
S0	18
S1	19
S2	1A
S3	1B
S4	1C
S5	1D
S6	1E
S7	1F



## Graphic or Control

## ASCII Hexadecimal

ACK	7C
Alt. Mode	7D
Rubout	7F
	21
"	22
#	23
\$	24
%	25
&	26
'	27
(	28
)	29
*	2A
+	2B
,	2C
-	2D
.	2E
/	2F
:	3A
;	3B
<	3C
=	3D
>	3E
?	3F
[	5B
/	5C
]	5D
↑	5E
←	5F
@	40
blank	20
0	30
1	31
2	32
3	33
4	34
5	35
6	36
7	37
8	38
9	39

Graphic or Control	ASCII Hexadecimal
A	41
B	42
C	43
D	44
E	45
F	46
G	47
H	48
I	49
J	4A
K	4B
L	4C
M	4D
N	4E
O	4F
P	50
Q	51
R	52
S	53
T	54
U	55
V	56
W	57
X	58
Y	59
Z	5A

APPENDIX "D"

-- BINARY-DECIMAL-HEXADECIMAL CONVERSION TABLES --

## HEXADECIMAL ARITHMETIC

### ADDITION TABLE

0	1	2	3	4	5	6	7	8	9	A	B	C	D	E	F
1	02	03	04	05	06	07	08	09	0A	0B	0C	0D	0E	0F	10
2	03	04	05	06	07	08	09	0A	0B	0C	0D	0E	0F	10	11
3	04	05	06	07	08	09	0A	0B	0C	0D	0E	0F	10	11	12
4	05	06	07	08	09	0A	0B	0C	0D	0E	0F	10	11	12	13
5	06	07	08	09	0A	0B	0C	0D	0E	0F	10	11	12	13	14
6	07	08	09	0A	0B	0C	0D	0E	0F	10	11	12	13	14	15
7	08	09	0A	0B	0C	0D	0E	0F	10	11	12	13	14	15	16
8	09	0A	0B	0C	0D	0E	0F	10	11	12	13	14	15	16	17
9	0A	0B	0C	0D	0E	0F	10	11	12	13	14	15	16	17	18
A	0B	0C	0D	0E	0F	10	11	12	13	14	15	16	17	18	19
B	0C	0D	0E	0F	10	11	12	13	14	15	16	17	18	19	1A
C	0D	0E	0F	10	11	12	13	14	15	16	17	18	19	1A	1B
D	0E	0F	10	11	12	13	14	15	16	17	18	19	1A	1B	1C
E	0F	10	11	12	13	14	15	16	17	18	19	1A	1B	1C	1D
F	10	11	12	13	14	15	16	17	18	19	1A	1B	1C	1D	1E

### MULTIPLICATION TABLE

1	2	3	4	5	6	7	8	9	A	B	C	D	E	F
2	04	06	08	0A	0C	0E	10	12	14	16	18	1A	1C	1E
3	06	09	0C	0F	12	15	18	1B	1E	21	24	27	2A	2D
4	08	0C	10	14	18	1C	20	24	28	2C	30	34	38	3C
5	0A	0F	14	19	1E	23	28	2D	32	37	3C	41	46	4B
6	0C	12	18	1E	24	2A	30	36	3C	42	48	4E	54	5A
7	0E	15	1C	23	2A	31	38	3F	46	4D	54	5B	62	69
8	10	18	20	28	30	38	40	48	50	58	60	68	70	78
9	12	1B	24	2D	36	3F	48	51	5A	63	6C	75	7E	87
A	14	1E	28	32	3C	46	50	5A	64	6E	78	82	8C	96
B	16	21	2C	37	42	4D	58	63	6E	79	84	8F	9A	A5
C	18	24	30	3C	48	54	60	6C	78	84	90	9C	AB	B4
D	1A	27	34	41	4E	5B	68	75	82	8F	9C	A9	B6	C3
E	1C	2A	38	46	54	62	70	7E	8C	9A	AB	B6	C4	D2
F	1E	2D	3C	48	5A	69	78	87	96	A5	B4	C3	D2	E1

## POWERS OF TWO

$2^n$	$n$	$2^{-n}$
1	0	1.0
2	1	0.5
4	2	0.25
8	3	0.125
16	4	0.0625
32	5	0.03125
64	6	0.015625
128	7	0.0078125
256	8	0.00390625
512	9	0.001953125
1024	10	0.0009765625
2048	11	0.00048828125
4096	12	0.000244140625
8192	13	0.0001220703125
16384	14	0.00006103515625
32768	15	0.000030517578125
65536	16	0.0000152587890625
131072	17	0.00000762939453125
262144	18	0.000003814697265625
524288	19	0.0000019073486328125
1048576	20	0.00000095367431640625
2097152	21	0.000000476837158203125
4194304	22	0.0000002384185791015625
8388608	23	0.00000011920928955078125
16777216	24	0.000000059604644775390625
33554432	25	0.0000000298023223876953125
67108864	26	0.00000001490116119384765625
134217728	27	0.000000007450580596923828125
268435456	28	0.0000000037252902984619140625
536870912	29	0.00000000186264514923095703125
1073741824	30	0.000000000931322574615478515625
2147483648	31	0.0000000004656617873077392578125
4294967296	32	0.00000000023283064365386962890625
8589934592	33	0.00000000011641532182693481453125
17179869184	34	0.0000000000582076619134674072265625
34359738368	35	0.0000000000291038345673370361328125
68719476736	36	0.000000000014551915228366851806640625
137438953472	37	0.0000000000072759576141834259033203125
274877906944	38	0.0000000000036379780709171295166015625
549755813888	39	0.000000000001818989403545856475830078125
1099511627776	40	0.0000000000009094947017729282379150390625
2199023255552	41	0.00000000000045474735088646411895751953125
4398046511104	42	0.000000000000227373675443232059478759765625
8796093022208	43	0.0000000000001136868377216160297393798828125
17592186044416	44	0.00000000000005684341886080801486968994140625
35184372088832	45	0.000000000000028421709430404007434844970703125
70368744177664	46	0.0000000000000142108547152020037174224853515625
140737488355328	47	0.00000000000000710542735760100185871124267578125
281474976710656	48	0.000000000000003552713678800500929355621337890625
562949953421312	49	0.0000000000000017763568394002504646778106689453125
1125899906842624	50	0.00000000000000088817841970012523233890533447265625
2251799813685248	51	0.000000000000000444089209850062616169452667236328125
4503599627370496	52	0.0000000000000002220446049250313080847263336181640625
9007199254740992	53	0.00000000000000011102230246251565404236316680908203125
18014398509481984	54	0.000000000000000055511151231257827021181583404541015625
36028797018963968	55	0.000000000000000027755756156289135105907917022705078125
72057594037927936	56	0.0000000000000000138777878078145675529539585113525390625
144115188075855872	57	0.000000000000000006938893903907228377647697925567626953125
288230376151711744	58	0.0000000000000000034694469519536141888238489627838134765625
576460752303423488	59	0.00000000000000000173472347597680709441192448139190673828125
1152921504606846976	60	0.00000000000000000086736173798840354720596224069595369140625
2305843009213693952	61	0.0000000000000000004336808689942017736029811203479766845703125
4611686018427387904	62	0.00000000000000000021684043449710088680149056017398834228515625
9223372036854775808	63	0.000000000000000000108420217248550443400743280086994171142578125

TABLE OF POWERS OF SIXTEEN<sub>10</sub>

$16^n$				n	$16^{-n}$							
1				0	0.10000	00000	00000	00000	x 10			
16				1	0.62500	00000	00000	00000	x 10 <sup>-1</sup>			
256				2	0.39062	50000	00000	00000	x 10 <sup>-2</sup>			
4	096			3	0.24414	06250	00000	00000	x 10 <sup>-3</sup>			
65	536			4	0.15258	78906	25000	00000	x 10 <sup>-4</sup>			
1	048	576		5	0.95367	43164	06250	00000	x 10 <sup>-6</sup>			
16	777	216		6	0.59604	64477	53906	25000	x 10 <sup>-7</sup>			
268	435	456		7	0.37252	90298	46191	40625	x 10 <sup>-8</sup>			
4	294	967	296	8	0.23283	06436	53869	62891	x 10 <sup>-9</sup>			
68	719	476	736	9	0.14551	91522	83668	51807	x 10 <sup>-10</sup>			
1	099	511	627	776	10	0.90949	47017	72928	23792	x 10 <sup>-12</sup>		
17	592	186	044	416	11	0.56843	41886	08080	14870	x 10 <sup>-13</sup>		
281	474	976	710	656	12	0.35527	13678	80050	09294	x 10 <sup>-14</sup>		
4	503	599	627	370	496	13	0.22204	46049	25031	30808	x 10 <sup>-15</sup>	
72	057	594	037	927	936	14	0.13877	78780	78144	56755	x 10 <sup>-16</sup>	
1	152	921	504	606	846	976	15	0.86736	17379	88403	54721	x 10 <sup>-18</sup>

TABLE OF POWERS OF 10<sub>16</sub>

$10^n$				n	$10^{-n}$				
1				0	1.0000	0000	0000	0000	
A				1	0.1999	9999	9999	999A	
64				2	0.28F5	C28F	5C28	F5C3	x 16 <sup>-1</sup>
3E8				3	0.4189	374B	C6A7	EF9E	x 16 <sup>-2</sup>
2710				4	0.68DB	8BAC	710C	B296	x 16 <sup>-3</sup>
1	86A0			5	0.A7C5	AC47	1B47	8423	x 16 <sup>-4</sup>
F	4240			6	0.10C6	F7A0	B5ED	8D37	x 16 <sup>-4</sup>
98	9680			7	0.1AD7	F29A	BCAF	4858	x 16 <sup>-5</sup>
5F5	E100			8	0.2AF3	1DC4	6118	73BF	x 16 <sup>-6</sup>
3B9A	CA00			9	0.44B8	2FA0	9B5A	52CC	x 16 <sup>-7</sup>
2	540B	E400		10	0.6DF3	7F67	5EF6	EADF	x 16 <sup>-8</sup>
17	4876	E800		11	0.AFEB	FF0B	CB24	AAFF	x 16 <sup>-9</sup>
E8	D4A5	1000		12	0.1197	9981	2DEA	1119	x 16 <sup>-9</sup>
916	4E72	A000		13	0.1C25	C268	4976	81C2	x 16 <sup>-10</sup>
5AF3	107A	4000		14	0.2D09	370D	4257	3604	x 16 <sup>-11</sup>
3	8D7E	A4C6	8000	15	0.480E	BE7B	9D58	566D	x 16 <sup>-12</sup>
23	8652	6FC1	0000	16	0.734A	CA5F	6226	FOAE	x 16 <sup>-13</sup>
163	4578	5D8A	0000	17	0.8877	AA32	36A4	B449	x 16 <sup>-14</sup>
DE0	8683	A764	0000	18	0.1272	5DD1	D243	ABA1	x 16 <sup>-14</sup>
8AC7	2304	89E8	0000	19	0.1D83	C94F	B6D2	AC35	x 16 <sup>-15</sup>

### HEXADECIMAL-DECIMAL INTEGER CONVERSION

The table below provides for direct conversions between hexadecimal integers in the range 0-FFF and decimal integers in the range 0-4095. For conversion of larger integers, the table values may be added to the following figures:

<u>Hexadecimal</u>	<u>Decimal</u>	<u>Hexadecimal</u>	<u>Decimal</u>
01 000	4 096	20 000	131 072
02 000	8 192	30 000	196 608
03 000	12 288	40 000	262 144
04 000	16 384	50 000	327 680
05 000	20 480	60 000	393 216
06 000	24 576	70 000	458 752
07 000	28 672	80 000	524 288
08 000	32 768	90 000	589 824
09 000	36 864	A0 000	655 360
0A 000	40 960	B0 000	720 896
0B 000	45 056	C0 000	786 432
0C 000	49 152	D0 000	851 968
0D 000	53 248	E0 000	917 504
0E 000	57 344	F0 000	983 040
0F 000	61 440	100 000	1 048 576
10 000	65 536	200 000	2 097 152
11 000	69 632	300 000	3 145 728
12 000	73 728	400 000	4 194 304
13 000	77 824	500 000	5 242 880
14 000	81 920	600 000	6 291 456
15 000	86 016	700 000	7 340 032
16 000	90 112	800 000	8 388 608
17 000	94 208	900 000	9 437 184
18 000	98 304	A00 000	10 485 760
19 000	102 400	B00 000	11 534 336
1A 000	106 496	C00 000	12 582 912
1B 000	110 592	D00 000	13 631 488
1C 000	114 688	E00 000	14 680 064
1D 000	118 784	F00 000	15 728 640
1E 000	122 880	1 000 000	16 777 216
1F 000	126 976	2 000 000	33 554 432

	0	1	2	3	4	5	6	7	8	9	A	B	C	D	E	F
000	0000	0001	0002	0003	0004	0005	0006	0007	0008	0009	0010	0011	0012	0013	0014	0015
010	0016	0017	0018	0019	0020	0021	0022	0023	0024	0025	0026	0027	0028	0029	0030	0031
020	0032	0033	0034	0035	0036	0037	0038	0039	0040	0041	0042	0043	0044	0045	0046	0047
030	0048	0049	0050	0051	0052	0053	0054	0055	0056	0057	0058	0059	0060	0061	0062	0063
040	0064	0065	0066	0067	0068	0069	0070	0071	0072	0073	0074	0075	0076	0077	0078	0079
050	0080	0081	0082	0083	0084	0085	0086	0087	0088	0089	0090	0091	0092	0093	0094	0095
060	0096	0097	0098	0099	0100	0101	0102	0103	0104	0105	0106	0107	0108	0109	0110	0111
070	0112	0113	0114	0115	0116	0117	0118	0119	0120	0121	0122	0123	0124	0125	0126	0127
080	0128	0129	0130	0131	0132	0133	0134	0135	0136	0137	0138	0139	0140	0141	0142	0143
090	0144	0145	0146	0147	0148	0149	0150	0151	0152	0153	0154	0155	0156	0157	0158	0159
0A0	0160	0161	0162	0163	0164	0165	0166	0167	0168	0169	0170	0171	0172	0173	0174	0175
0B0	0176	0177	0178	0179	0180	0181	0182	0183	0184	0185	0186	0187	0188	0189	0190	0191
0C0	0192	0193	0194	0195	0196	0197	0198	0199	0200	0201	0202	0203	0204	0205	0206	0207
0D0	0208	0209	0210	0211	0212	0213	0214	0215	0216	0217	0218	0219	0220	0221	0222	0223
0E0	0224	0225	0226	0227	0228	0229	0230	0231	0232	0233	0234	0235	0236	0237	0238	0239
0F0	0240	0241	0242	0243	0244	0245	0246	0247	0248	0249	0250	0251	0252	0253	0254	0255

HEXADECIMAL-DECIMAL INTEGER CONVERSION (Cont.)

	0	1	2	3	4	5	6	7	8	9	A	B	C	D	E	F
100	0256	0257	0258	0259	0260	0261	0262	0263	0264	0265	0266	0267	0268	0269	0270	0271
110	0272	0273	0274	0275	0276	0277	0278	0279	0280	0281	0282	0283	0284	0285	0286	0287
120	0288	0289	0290	0291	0292	0293	0294	0295	0296	0297	0298	0299	0300	0301	0302	0303
130	0304	0305	0306	0307	0308	0309	0310	0311	0312	0313	0314	0315	0316	0317	0318	0319
140	0320	0321	0322	0323	0324	0325	0326	0327	0328	0329	0330	0331	0332	0333	0334	0335
150	0336	0337	0338	0339	0340	0341	0342	0343	0344	0345	0346	0347	0348	0349	0350	0351
160	0352	0353	0354	0355	0356	0357	0358	0359	0360	0361	0362	0363	0364	0365	0366	0367
170	0368	0369	0370	0371	0372	0373	0374	0375	0376	0377	0378	0379	0380	0381	0382	0383
180	0384	0385	0386	0387	0388	0389	0390	0391	0392	0393	0394	0395	0396	0397	0398	0399
190	0400	0401	0402	0403	0404	0405	0406	0407	0408	0409	0410	0411	0412	0413	0414	0415
1A0	0416	0417	0418	0419	0420	0421	0422	0423	0424	0425	0426	0427	0428	0429	0430	0431
1B0	0432	0433	0434	0435	0436	0437	0438	0439	0440	0441	0442	0443	0444	0445	0446	0447
1C0	0448	0449	0450	0451	0452	0453	0454	0455	0456	0457	0458	0459	0460	0461	0462	0463
1D0	0464	0465	0466	0467	0468	0469	0470	0471	0472	0473	0474	0475	0476	0477	0478	0479
1E0	0480	0481	0482	0483	0484	0485	0486	0487	0488	0489	0490	0491	0492	0493	0494	0495
1F0	0496	0497	0498	0499	0500	0501	0502	0503	0504	0505	0506	0507	0508	0509	0510	0511
200	0512	0513	0514	0515	0516	0517	0518	0519	0520	0521	0522	0523	0524	0525	0526	0527
210	0528	0529	0530	0531	0532	0533	0534	0535	0536	0537	0538	0539	0540	0541	0542	0543
220	0544	0545	0546	0547	0548	0549	0550	0551	0552	0553	0554	0555	0556	0557	0558	0559
230	0560	0561	0562	0563	0564	0565	0566	0567	0568	0569	0570	0571	0572	0573	0574	0575
240	0576	0577	0578	0579	0580	0581	0582	0583	0584	0585	0586	0587	0588	0589	0590	0591
250	0592	0593	0594	0595	0596	0597	0598	0599	0600	0601	0602	0603	0604	0605	0606	0607
260	0608	0609	0610	0611	0612	0613	0614	0615	0616	0617	0618	0619	0620	0621	0622	0623
270	0624	0625	0626	0627	0628	0629	0630	0631	0632	0633	0634	0635	0636	0637	0638	0639
280	0640	0641	0642	0643	0644	0645	0646	0647	0648	0649	0650	0651	0652	0653	0654	0655
290	0656	0657	0658	0659	0660	0661	0662	0663	0664	0665	0666	0667	0668	0669	0670	0671
2A0	0672	0673	0674	0675	0676	0677	0678	0679	0680	0681	0682	0683	0684	0685	0686	0687
2B0	0688	0689	0690	0691	0692	0693	0694	0695	0696	0697	0698	0699	0700	0701	0702	0703
2C0	0704	0705	0706	0707	0708	0709	0710	0711	0712	0713	0714	0715	0716	0717	0718	0719
2D0	0720	0721	0722	0723	0724	0725	0726	0727	0728	0729	0730	0731	0732	0733	0734	0735
2E0	0736	0737	0738	0739	0740	0741	0742	0743	0744	0745	0746	0747	0748	0749	0750	0751
2F0	0752	0753	0754	0755	0756	0757	0758	0759	0760	0761	0762	0763	0764	0765	0766	0767
300	0768	0769	0770	0771	0772	0773	0774	0775	0776	0777	0778	0779	0780	0781	0782	0783
310	0784	0785	0786	0787	0788	0789	0790	0791	0792	0793	0794	0795	0796	0797	0798	0799
320	0800	0801	0802	0803	0804	0805	0806	0807	0808	0809	0810	0811	0812	0813	0814	0815
330	0816	0817	0818	0819	0820	0821	0822	0823	0824	0825	0826	0827	0828	0829	0830	0831
340	0832	0833	0834	0835	0836	0837	0838	0839	0840	0841	0842	0843	0844	0845	0846	0847
350	0848	0849	0850	0851	0852	0853	0854	0855	0856	0857	0858	0859	0860	0861	0862	0863
360	0864	0865	0866	0867	0868	0869	0870	0871	0872	0873	0874	0875	0876	0877	0878	0879
370	0880	0881	0882	0883	0884	0885	0886	0887	0888	0889	0890	0891	0892	0893	0894	0895
380	0896	0897	0898	0899	0900	0901	0902	0903	0904	0905	0906	0907	0908	0909	0910	0911
390	0912	0913	0914	0915	0916	0917	0918	0919	0920	0921	0922	0923	0924	0925	0926	0927
3A0	0928	0929	0930	0931	0932	0933	0934	0935	0936	0937	0938	0939	0940	0941	0942	0943
3B0	0944	0945	0946	0947	0948	0949	0950	0951	0952	0953	0954	0955	0956	0957	0958	0959
3C0	0960	0961	0962	0963	0964	0965	0966	0967	0968	0969	0970	0971	0972	0973	0974	0975
3D0	0976	0977	0978	0979	0980	0981	0982	0983	0984	0985	0986	0987	0988	0989	0990	0991
3E0	0992	0993	0994	0995	0996	0997	0998	0999	1000	1001	1002	1003	1004	1005	1006	1007
3F0	1008	1009	1010	1011	1012	1013	1014	1015	1016	1017	1018	1019	1020	1021	1022	1023



HEXADECIMAL-DECIMAL INTEGER CONVERSION (Cont.)

	0	1	2	3	4	5	6	7	8	9	A	B	C	D	E	F
400	1024	1025	1026	1027	1028	1029	1030	1031	1032	1033	1034	1035	1036	1037	1038	1039
410	1040	1041	1042	1043	1044	1045	1046	1047	1048	1049	1050	1051	1052	1053	1054	1055
420	1056	1057	1058	1059	1060	1061	1062	1063	1064	1065	1066	1067	1068	1069	1070	1071
430	1072	1073	1074	1075	1076	1077	1078	1079	1080	1081	1082	1083	1084	1085	1086	1087
440	1088	1089	1090	1091	1092	1093	1094	1095	1096	1097	1098	1099	1100	1101	1102	1103
450	1104	1105	1106	1107	1108	1109	1110	1111	1112	1113	1114	1115	1116	1117	1118	1119
460	1120	1121	1122	1123	1124	1125	1126	1127	1128	1129	1130	1131	1132	1133	1134	1135
470	1136	1137	1138	1139	1140	1141	1142	1143	1144	1145	1146	1147	1148	1149	1150	1151
480	1152	1153	1154	1155	1156	1157	1158	1159	1160	1161	1162	1163	1164	1165	1166	1167
490	1168	1169	1170	1171	1172	1173	1174	1175	1176	1177	1178	1179	1180	1181	1182	1183
4A0	1184	1185	1186	1187	1188	1189	1190	1191	1192	1193	1194	1195	1196	1197	1198	1199
4B0	1200	1201	1202	1203	1204	1205	1206	1207	1208	1209	1210	1211	1212	1213	1214	1215
4C0	1216	1217	1218	1219	1220	1221	1222	1223	1224	1225	1226	1227	1228	1229	1230	1231
4D0	1232	1233	1234	1235	1236	1237	1238	1239	1240	1241	1242	1243	1244	1245	1246	1247
4E0	1248	1249	1250	1251	1252	1253	1254	1255	1256	1257	1258	1259	1260	1261	1262	1263
4F0	1264	1265	1266	1267	1268	1269	1270	1271	1272	1273	1274	1275	1276	1277	1278	1279
500	1280	1281	1282	1283	1284	1285	1286	1287	1288	1289	1290	1291	1292	1293	1294	1295
510	1296	1297	1298	1299	1300	1301	1302	1303	1304	1305	1306	1307	1308	1309	1310	1311
520	1312	1313	1314	1315	1316	1317	1318	1319	1320	1321	1322	1323	1324	1325	1326	1327
530	1328	1329	1330	1331	1332	1333	1334	1335	1336	1337	1338	1339	1340	1341	1342	1343
540	1344	1345	1346	1347	1348	1349	1350	1351	1352	1353	1354	1355	1356	1357	1358	1359
550	1360	1361	1362	1363	1364	1365	1366	1367	1368	1369	1370	1371	1372	1373	1374	1375
560	1376	1377	1378	1379	1380	1381	1382	1383	1384	1385	1386	1387	1388	1389	1390	1391
570	1392	1393	1394	1395	1396	1397	1398	1399	1400	1401	1402	1403	1404	1405	1406	1407
580	1408	1409	1410	1411	1412	1413	1414	1415	1416	1417	1418	1419	1420	1421	1422	1423
590	1424	1425	1426	1427	1428	1429	1430	1431	1432	1433	1434	1435	1436	1437	1438	1439
5A0	1440	1441	1442	1443	1444	1445	1446	1447	1448	1449	1450	1451	1452	1453	1454	1455
5B0	1456	1457	1458	1459	1460	1461	1462	1463	1464	1465	1466	1467	1468	1469	1470	1471
5C0	1472	1473	1474	1475	1476	1477	1478	1479	1480	1481	1482	1483	1484	1485	1486	1487
5D0	1488	1489	1490	1491	1492	1493	1494	1495	1496	1497	1498	1499	1500	1501	1502	1503
5E0	1504	1505	1506	1507	1508	1509	1510	1511	1512	1513	1514	1515	1516	1517	1518	1519
5F0	1520	1521	1522	1523	1524	1525	1526	1527	1528	1529	1530	1531	1532	1533	1534	1535
600	1536	1537	1538	1539	1540	1541	1542	1543	1544	1545	1546	1547	1548	1549	1550	1551
610	1552	1553	1554	1555	1556	1557	1558	1559	1560	1561	1562	1563	1564	1565	1566	1567
620	1568	1569	1570	1571	1572	1573	1574	1575	1576	1577	1578	1579	1580	1581	1582	1583
630	1584	1585	1586	1587	1588	1589	1590	1591	1592	1593	1594	1595	1596	1597	1598	1599
640	1600	1601	1602	1603	1604	1605	1606	1607	1608	1609	1610	1611	1612	1613	1614	1615
650	1616	1617	1618	1619	1620	1621	1622	1623	1624	1625	1626	1627	1628	1629	1630	1631
660	1632	1633	1634	1635	1636	1637	1638	1639	1640	1641	1642	1643	1644	1645	1646	1647
670	1648	1649	1650	1651	1652	1653	1654	1655	1656	1657	1658	1659	1660	1661	1662	1663
680	1664	1665	1666	1667	1668	1669	1670	1671	1672	1673	1674	1675	1676	1677	1678	1679
690	1680	1681	1682	1683	1684	1685	1686	1687	1688	1689	1690	1691	1692	1693	1694	1695
6A0	1696	1697	1698	1699	1700	1701	1702	1703	1704	1705	1706	1707	1708	1709	1710	1711
6B0	1712	1713	1714	1715	1716	1717	1718	1719	1720	1721	1722	1723	1724	1725	1726	1727
6C0	1728	1729	1730	1731	1732	1733	1734	1735	1736	1737	1738	1739	1740	1741	1742	1743
6D0	1744	1745	1746	1747	1748	1749	1750	1751	1752	1753	1754	1755	1756	1757	1758	1759
6E0	1760	1761	1762	1763	1764	1765	1766	1767	1768	1769	1770	1771	1772	1773	1774	1775
6F0	1776	1777	1778	1779	1780	1781	1782	1783	1784	1785	1786	1787	1788	1789	1790	1791

HEXADECIMAL-DECIMAL INTEGER CONVERSION (Cont.)

	0	1	2	3	4	5	6	7	8	9	A	B	C	D	E	F
700	1792	1793	1794	1795	1796	1797	1798	1799	1800	1801	1802	1803	1804	1805	1806	1807
710	1808	1809	1810	1811	1812	1813	1814	1815	1816	1817	1818	1819	1820	1821	1822	1823
720	1824	1825	1826	1827	1828	1829	1830	1831	1832	1833	1834	1835	1836	1837	1838	1839
730	1840	1841	1842	1843	1844	1845	1846	1847	1848	1849	1850	1851	1852	1853	1854	1855
740	1856	1857	1858	1859	1860	1861	1862	1863	1864	1865	1866	1867	1868	1869	1870	1871
750	1872	1873	1874	1875	1876	1877	1878	1879	1880	1881	1882	1883	1884	1885	1886	1887
760	1888	1889	1890	1891	1892	1893	1894	1895	1896	1897	1898	1899	1900	1901	1902	1903
770	1904	1905	1906	1907	1908	1909	1910	1911	1912	1913	1914	1915	1916	1917	1918	1919
780	1920	1921	1922	1923	1924	1925	1926	1927	1928	1929	1930	1931	1932	1933	1934	1935
790	1936	1937	1938	1939	1940	1941	1942	1943	1944	1945	1946	1947	1948	1949	1950	1951
7A0	1952	1953	1954	1955	1956	1957	1958	1959	1960	1961	1962	1963	1964	1965	1966	1967
7B0	1968	1969	1970	1971	1972	1973	1974	1975	1976	1977	1978	1979	1980	1981	1982	1983
7C0	1984	1985	1986	1987	1988	1989	1990	1991	1992	1993	1994	1995	1996	1997	1998	1999
7D0	2000	2001	2002	2003	2004	2005	2006	2007	2008	2009	2010	2011	2012	2013	2014	2015
7E0	2016	2017	2018	2019	2020	2021	2022	2023	2024	2025	2026	2027	2028	2029	2030	2031
7F0	2032	2033	2034	2035	2036	2037	2038	2039	2040	2041	2042	2043	2044	2045	2046	2047
800	2048	2049	2050	2051	2052	2053	2054	2055	2056	2057	2058	2059	2060	2061	2062	2063
810	2064	2065	2066	2067	2068	2069	2070	2071	2072	2073	2074	2075	2076	2077	2078	2079
820	2080	2081	2082	2083	2084	2085	2086	2087	2088	2089	2090	2091	2092	2093	2094	2095
830	2096	2097	2098	2099	2100	2101	2102	2103	2104	2105	2106	2107	2108	2109	2110	2111
840	2112	2113	2114	2115	2116	2117	2118	2119	2120	2121	2122	2123	2124	2125	2126	2127
850	2128	2129	2130	2131	2132	2133	2134	2135	2136	2137	2138	2139	2140	2141	2142	2143
860	2144	2145	2146	2147	2148	2149	2150	2151	2152	2153	2154	2155	2156	2157	2158	2159
870	2160	2161	2162	2163	2164	2165	2166	2167	2168	2169	2170	2171	2172	2173	2174	2175
880	2176	2177	2178	2179	2180	2181	2182	2183	2184	2185	2186	2187	2188	2189	2190	2191
890	2192	2193	2194	2195	2196	2197	2198	2199	2200	2201	2202	2203	2204	2205	2206	2207
8A0	2208	2209	2210	2211	2212	2213	2214	2215	2216	2217	2218	2219	2220	2221	2222	2223
8B0	2224	2225	2226	2227	2228	2229	2230	2231	2232	2233	2234	2235	2236	2237	2238	2239
8C0	2240	2241	2242	2243	2244	2245	2246	2247	2248	2249	2250	2251	2252	2253	2254	2255
8D0	2256	2257	2258	2259	2260	2261	2262	2263	2264	2265	2266	2267	2268	2269	2270	2271
8E0	2272	2273	2274	2275	2276	2277	2278	2279	2280	2281	2282	2283	2284	2285	2286	2287
8F0	2288	2289	2290	2291	2292	2293	2294	2295	2296	2297	2298	2299	2300	2301	2302	2303
900	2304	2305	2306	2307	2308	2309	2310	2311	2312	2313	2314	2315	2316	2317	2318	2319
910	2320	2321	2322	2323	2324	2325	2326	2327	2328	2329	2330	2331	2332	2333	2334	2335
920	2336	2337	2338	2339	2340	2341	2342	2343	2344	2345	2346	2347	2348	2349	2350	2351
930	2352	2353	2354	2355	2356	2357	2358	2359	2360	2361	2362	2363	2364	2365	2366	2367
940	2368	2369	2370	2371	2372	2373	2374	2375	2376	2377	2378	2379	2380	2381	2382	2383
950	2384	2385	2386	2387	2388	2389	2390	2391	2392	2393	2394	2395	2396	2397	2398	2399
960	2400	2401	2402	2403	2404	2405	2406	2407	2408	2409	2410	2411	2412	2413	2414	2415
970	2416	2417	2418	2419	2420	2421	2422	2423	2424	2425	2426	2427	2428	2429	2430	2431
980	2432	2433	2434	2435	2436	2437	2438	2439	2440	2441	2442	2443	2444	2445	2446	2447
990	2448	2449	2450	2451	2452	2453	2454	2455	2456	2457	2458	2459	2460	2461	2462	2463
9A0	2464	2465	2466	2467	2468	2469	2470	2471	2472	2473	2474	2475	2476	2477	2478	2479
9B0	2480	2481	2482	2483	2484	2485	2486	2487	2488	2489	2490	2491	2492	2493	2494	2495
9C0	2496	2497	2498	2499	2500	2501	2502	2503	2504	2505	2506	2507	2508	2509	2510	2511
9D0	2512	2513	2514	2515	2516	2517	2518	2519	2520	2521	2522	2523	2524	2525	2526	2527
9E0	2528	2529	2530	2531	2532	2533	2534	2535	2536	2537	2538	2539	2540	2541	2542	2543
9F0	2544	2545	2546	2547	2548	2549	2550	2551	2552	2553	2554	2555	2556	2557	2558	2559

HEXADECIMAL-DECIMAL INTEGER CONVERSION (Cont.)

	0	1	2	3	4	5	6	7	8	9	A	B	C	D	E	F
A00	2560	2561	2562	2563	2564	2565	2566	2567	2568	2569	2570	2571	2572	2573	2574	2575
A10	2576	2577	2578	2579	2580	2581	2582	2583	2584	2585	2586	2587	2588	2589	2590	2591
A20	2592	2593	2594	2595	2596	2597	2598	2599	2600	2601	2602	2603	2604	2605	2606	2607
A30	2608	2609	2610	2611	2612	2613	2614	2615	2616	2617	2618	2619	2620	2621	2622	2623
A40	2624	2625	2626	2627	2628	2629	2630	2631	2632	2633	2634	2635	2636	2637	2638	2639
A50	2640	2641	2642	2643	2644	2645	2646	2647	2648	2649	2650	2651	2652	2653	2654	2655
A60	2656	2657	2658	2659	2660	2661	2662	2663	2664	2665	2666	2667	2668	2669	2670	2671
A70	2672	2673	2674	2675	2676	2677	2678	2679	2680	2681	2682	2683	2684	2685	2686	2687
A80	2688	2689	2690	2691	2692	2693	2694	2695	2696	2697	2698	2699	2700	2701	2702	2703
A90	2704	2705	2706	2707	2708	2709	2710	2711	2712	2713	2714	2715	2716	2717	2718	2719
AA0	2720	2721	2722	2723	2724	2725	2726	2727	2728	2729	2730	2731	2732	2733	2734	2735
AB0	2736	2737	2738	2739	2740	2741	2742	2743	2744	2745	2746	2747	2748	2749	2750	2751
AC0	2752	2753	2754	2755	2756	2757	2758	2759	2760	2761	2762	2763	2764	2765	2766	2767
AD0	2768	2769	2770	2771	2772	2773	2774	2775	2776	2777	2778	2779	2780	2781	2782	2783
AE0	2784	2785	2786	2787	2788	2789	2790	2791	2792	2793	2794	2795	2796	2797	2798	2799
AF0	2800	2801	2802	2803	2804	2805	2806	2807	2808	2809	2810	2811	2812	2813	2814	2815
B00	2816	2817	2818	2819	2820	2821	2822	2823	2824	2825	2826	2827	2828	2829	2830	2831
B10	2832	2833	2834	2835	2836	2837	2838	2839	2840	2841	2842	2843	2844	2845	2846	2847
B20	2848	2849	2850	2851	2852	2853	2854	2855	2856	2857	2858	2859	2860	2861	2862	2863
B30	2864	2865	2866	2867	2868	2869	2870	2871	2872	2873	2874	2875	2876	2877	2878	2879
B40	2880	2881	2882	2883	2884	2885	2886	2887	2888	2889	2890	2891	2892	2893	2894	2895
B50	2896	2897	2898	2899	2900	2901	2902	2903	2904	2905	2906	2907	2908	2909	2910	2911
B60	2912	2913	2914	2915	2916	2917	2918	2919	2920	2921	2922	2923	2924	2925	2926	2927
B70	2928	2929	2930	2931	2932	2933	2934	2935	2936	2937	2938	2939	2940	2941	2942	2943
B80	2944	2945	2946	2947	2948	2949	2950	2951	2952	2953	2954	2955	2956	2957	2958	2959
B90	2960	2961	2962	2963	2964	2965	2966	2967	2968	2969	2970	2971	2972	2973	2974	2975
BA0	2976	2977	2978	2979	2980	2981	2982	2983	2984	2985	2986	2987	2988	2989	2990	2991
BB0	2992	2993	2994	2995	2996	2997	2998	2999	3000	3001	3002	3003	3004	3005	3006	3007
BC0	3008	3009	3010	3011	3012	3013	3014	3015	3016	3017	3018	3019	3020	3021	3022	3023
BD0	3024	3025	3026	3027	3028	3029	3030	3031	3032	3033	3034	3035	3036	3037	3038	3039
BE0	3040	3041	3042	3043	3044	3045	3046	3047	3048	3049	3050	3051	3052	3053	3054	3055
BF0	3056	3057	3058	3059	3060	3061	3062	3063	3064	3065	3066	3067	3068	3069	3070	3071
C00	3072	3073	3074	3075	3076	3077	3078	3079	3080	3081	3082	3083	3084	3085	3086	3087
C10	3088	3089	3090	3091	3092	3093	3094	3095	3096	3097	3098	3099	3100	3101	3102	3103
C20	3104	3105	3106	3107	3108	3109	3110	3111	3112	3113	3114	3115	3116	3117	3118	3119
C30	3120	3121	3122	3123	3124	3125	3126	3127	3128	3129	3130	3131	3132	3133	3134	3135
C40	3136	3137	3138	3139	3140	3141	3142	3143	3144	3145	3146	3147	3148	3149	3150	3151
C50	3152	3153	3154	3155	3156	3157	3158	3159	3160	3161	3162	3163	3164	3165	3166	3167
C60	3168	3169	3170	3171	3172	3173	3174	3175	3176	3177	3178	3179	3180	3181	3182	3183
C70	3184	3185	3186	3187	3188	3189	3190	3191	3192	3193	3194	3195	3196	3197	3198	3199
C80	3200	3201	3202	3203	3204	3205	3206	3207	3208	3209	3210	3211	3212	3213	3214	3215
C90	3216	3217	3218	3219	3220	3221	3222	3223	3224	3225	3226	3227	3228	3229	3230	3231
CA0	3232	3233	3234	3235	3236	3237	3238	3239	3240	3241	3242	3243	3244	3245	3246	3247
CB0	3248	3249	3250	3251	3252	3253	3254	3255	3256	3257	3258	3259	3260	3261	3262	3263
CC0	3264	3265	3266	3267	3268	3269	3270	3271	3272	3273	3274	3275	3276	3277	3278	3279
CD0	3280	3281	3282	3283	3284	3285	3286	3287	3288	3289	3290	3291	3292	3293	3294	3295
CE0	3296	3297	3298	3299	3300	3301	3302	3303	3304	3305	3306	3307	3308	3309	3310	3311
CF0	3312	3313	3314	3315	3316	3317	3318	3319	3320	3321	3322	3323	3324	3325	3326	3327

HEXADECIMAL-DECIMAL INTEGER CONVERSION (Cont.)

	0	1	2	3	4	5	6	7	8	9	A	B	C	D	E	F
D00	3328	3329	3330	3331	3332	3333	3334	3335	3336	3337	3338	3339	3340	3341	3342	3343
D10	3344	3345	3346	3347	3348	3349	3350	3351	3352	3353	3354	3355	3356	3357	3358	3359
D20	3360	3361	3362	3363	3364	3365	3366	3367	3368	3369	3370	3371	3372	3373	3374	3375
D30	3376	3377	3378	3379	3380	3381	3382	3383	3384	3385	3386	3387	3388	3389	3390	3391
D40	3392	3393	3394	3395	3396	3397	3398	3399	3400	3401	3402	3403	3404	3405	3406	3407
D50	3408	3409	3410	3411	3412	3413	3414	3415	3416	3417	3418	3419	3420	3421	3422	3423
D60	3424	3425	3426	3427	3428	3429	3430	3431	3432	3433	3434	3435	3436	3437	3438	3439
D70	3440	3441	3442	3443	3444	3445	3446	3447	3448	3449	3450	3451	3452	3453	3454	3455
D80	3456	3457	3458	3459	3460	3461	3462	3463	3464	3465	3466	3467	3468	3469	3470	3471
D90	3472	3473	3474	3475	3476	3477	3478	3479	3480	3481	3482	3483	3484	3485	3486	3487
DA0	3488	3489	3490	3491	3492	3493	3494	3495	3496	3497	3498	3499	3500	3501	3502	3503
DB0	3504	3505	3506	3507	3508	3509	3510	3511	3512	3513	3514	3515	3516	3517	3518	3519
DC0	3520	3521	3522	3523	3524	3525	3526	3527	3528	3529	3530	3531	3532	3533	3534	3535
DD0	3536	3537	3538	3539	3540	3541	3542	3543	3544	3545	3546	3547	3548	3549	3550	3551
DE0	3552	3553	3554	3555	3556	3557	3558	3559	3560	3561	3562	3563	3564	3565	3566	3567
DF0	3568	3569	3570	3571	3572	3573	3574	3575	3576	3577	3578	3579	3580	3581	3582	3583
E00	3584	3585	3586	3587	3588	3589	3590	3591	3592	3593	3594	3595	3596	3597	3598	3599
E10	3600	3601	3602	3603	3604	3605	3606	3607	3608	3609	3610	3611	3612	3613	3614	3615
E20	3616	3617	3618	3619	3620	3621	3622	3623	3624	3625	3626	3627	3628	3629	3630	3631
E30	3632	3633	3634	3635	3636	3637	3638	3639	3640	3641	3642	3643	3644	3645	3646	3647
E40	3648	3649	3650	3651	3652	3653	3654	3655	3656	3657	3658	3659	3660	3661	3662	3663
E50	3664	3665	3666	3667	3668	3669	3670	3671	3672	3673	3674	3675	3676	3677	3678	3679
E60	3680	3681	3682	3683	3684	3685	3686	3687	3688	3689	3690	3691	3692	3693	3694	3695
E70	3696	3697	3698	3699	3700	3701	3702	3703	3704	3705	3706	3707	3708	3709	3710	3711
E80	3712	3713	3714	3715	3716	3717	3718	3719	3720	3721	3722	3723	3724	3725	3726	3727
E90	3728	3729	3730	3731	3732	3733	3734	3735	3736	3737	3738	3739	3740	3741	3742	3743
EA0	3744	3745	3746	3747	3748	3749	3750	3751	3752	3753	3754	3755	3756	3757	3758	3759
EB0	3760	3761	3762	3763	3764	3765	3766	3767	3768	3769	3770	3771	3772	3773	3774	3775
EC0	3776	3777	3778	3779	3780	3781	3782	3783	3784	3785	3786	3787	3788	3789	3790	3791
ED0	3792	3793	3794	3795	3796	3797	3798	3799	3800	3801	3802	3803	3804	3805	3806	3807
EE0	3808	3809	3810	3811	3812	3813	3814	3815	3816	3817	3818	3819	3820	3821	3822	3823
EF0	3824	3825	3826	3827	3828	3829	3830	3831	3832	3833	3834	3835	3836	3837	3838	3839
F00	3840	3841	3842	3843	3844	3845	3846	3847	3848	3849	3850	3851	3852	3853	3854	3855
F10	3856	3857	3858	3859	3860	3861	3862	3863	3864	3865	3866	3867	3868	3869	3870	3871
F20	3872	3873	3874	3875	3876	3877	3878	3879	3880	3881	3882	3883	3884	3885	3886	3887
F30	3888	3889	3890	3891	3892	3893	3894	3895	3896	3897	3898	3899	3900	3901	3902	3903
F40	3904	3905	3906	3907	3908	3909	3910	3911	3912	3913	3914	3915	3916	3917	3918	3919
F50	3920	3921	3922	3923	3924	3925	3926	3927	3928	3929	3930	3931	3932	3933	3934	3935
F60	3936	3937	3938	3939	3940	3941	3942	3943	3944	3945	3946	3947	3948	3949	3950	3951
F70	3952	3953	3954	3955	3956	3957	3958	3959	3960	3961	3962	3963	3964	3965	3966	3967
F80	3968	3969	3970	3971	3972	3973	3974	3975	3976	3977	3978	3979	3980	3981	3982	3983
F90	3984	3985	3986	3987	3988	3989	3990	3991	3992	3993	3994	3995	3996	3997	3998	3999
FA0	4000	4001	4002	4003	4004	4005	4006	4007	4008	4009	4010	4011	4012	4013	4014	4015
FB0	4016	4017	4018	4019	4020	4021	4022	4023	4024	4025	4026	4027	4028	4029	4030	4031
FC0	4032	4033	4034	4035	4036	4037	4038	4039	4040	4041	4042	4043	4044	4045	4046	4047
FD0	4048	4049	4050	4051	4052	4053	4054	4055	4056	4057	4058	4059	4060	4061	4062	4063
FE0	4064	4065	4066	4067	4068	4069	4070	4071	4072	4073	4074	4075	4076	4077	4078	4079
FF0	4080	4081	4082	4083	4084	4085	4086	4087	4088	4089	4090	4091	4092	4093	4094	4095

**intel<sup>®</sup>**

**West:** 17291 Irvine Blvd., Suite 262/(714)838-1126, TWX: 910-595-1114/Tustin, California 92680

**Mid-America:** 800 Southgate Office Plaza/501 West 78th St./ (612)835-6722, TWX: 910-576-2867/Bloomington, Minnesota 55437

**Northeast:** 2 Militia Drive, Suite 4/(617)861-1136, Telex: 92-3493/Lexington, Massachusetts 02173

**Mid-Atlantic:** 21 Bala Avenue/(215)664-6636/Bala Cynwyd, Pennsylvania 19004

**Europe:** Intel Office/Vester Farimagsgade 7/45-1-11 5644, Telex: 19567/DK 1606 Copenhagen V

**Orient:** Intel Japan Corp./Han-Ei 2nd Building/1-1, Shinjuku, Shinjuku-Ku/03-354-8251, Telex: 781-28426/Tokyo 160

© 1973/Printed in U.S.A./MCS-030-1273-150