

intel  
386™ MicroComputer Model 300SX User's Guide

Intel 386™  
MicroComputer  
Model 300SX

## User's Guide

intel

# 300SX

Order Number:  
501329-001

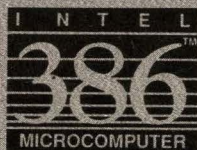



**Intel386™ MicroComputer  
Model 300SX  
User's Guide**

---



## **WARNING**

This equipment has been certified to comply with the limits for a class B computing device, pursuant to subpart J of part 15 FCC rules. (The FCC certification number is located on the back panel of the equipment.) Only peripherals (computer input/output devices, terminals, printers, etc.) certified to comply with the class B limits may be attached to this computer. Operation with non-certified peripherals is likely to result in interference to radio and TV reception.

All cables used to connect to peripherals must be shielded and grounded. Operation with cables, connected to peripherals, which are not shielded and grounded may result in interference to radio and TV reception.

This equipment meets or exceeds requirements for safety in the US (UL 478 5th Edition), Canada (CSA C22.2 No. 220), and Europe (IEC 380, IEC 435, IEC 950, and VDE 0806).

This equipment has been tested for radio frequency emissions and has been verified to meet VDE 0871 Class B.

This digital apparatus does not exceed the Class B limits for radio noise emissions set out in the radio interference regulations of the Canadian Department of Communications.

Ce dispositif digital, s'il est utilisé suivant les instructions et recommandations du constructeur, ne dépasse pas les limites de la Classe B pour le bruit des fréquences radio, établies par les Règles sur l'interférence radio du Ministère Canadien des Communications.

## RADIO FREQUENCY INTERFERENCE NOTICE

This equipment generates and uses radio frequency energy and if not installed properly, that is, in strict accordance with the manufacturer's instructions, may cause interference to radio and television reception. It has been type-tested and found to comply with the limits for a Class B computing device in accordance with the specifications in Subpart J of Part 15 FCC rules, which are designed to provide reasonable protection against interference in a residential installation. However, there is no guarantee that interference will not occur in a particular installation. If the equipment does cause interference to radio or television reception, which can be determined by turning the equipment off and on, the user is encouraged to try to correct the interference by one or more of the following measures:

- Reorient the receiving antenna.
- Relocate the system with respect to the receiver.
- Move the system away from the receiver.
- Plug the system into a different outlet so that the system and receiver are on different branch circuits.
- Move the cables connected to the system to minimize the interference.
- Tighten all screws on cables and the system housing.
- Install blank panels, originally supplied with the system, in all unused card slots.

If necessary, the user should consult the dealer or an experienced radio/television technician for additional suggestions. The user may find the following booklet prepared by the Federal Communications Commission helpful:

*How to Identify and Resolve Radio-TV Interference Problems*

This booklet is available from the U.S. Government Printing Office, Washington, D.C. 20402. Stock No. 004-00398-5.

Additional copies of this manual or other Intel literature may be obtained from:

Intel Corporation  
Literature Sales  
P.O. Box 58130  
Santa Clara, CA 95052-8130

In the U.S. and Canada call  
toll free: (800) 548-4725

Intel Corporation makes no warranty of any kind with regard to this material, including, but not limited to, the implied warranties of merchantability and fitness for a particular purpose. Intel Corporation assumes no responsibility for any errors that may appear in this document. Intel Corporation makes no commitment to update nor to keep current the information contained in this document.

Intel Corporation assumes no responsibility for the use of any circuitry other than circuitry embodied in an Intel product. No other circuit patent licenses are implied.

Intel software and firmware products are copyrighted by and shall remain the property of Intel Corporation. Use, duplication, or disclosure is subject to restrictions stated in Intel's Software License Agreement, or in the case of software delivered to the U.S. government, in accordance with the software license agreement as defined in FAR 52.227-7013.

No part of this document may be copied or reproduced in any form or by any means without prior written consent of Intel Corporation.

Intel Corporation retains the right to make changes to these specifications at any time, without notice. Contact your local sales office to obtain the latest specifications before placing your order.

The following are trademarks of Intel Corporation and its affiliates, and may be used only to identify Intel products:

Above	iMDDX	iRMX	Promware
BITBUS	iMMX	iSBC	QueX
COMMputer	Inboard	iSBX	QUEST
CREDIT	Insite	iSDM	Quick-Erase
Data Pipeline	Intel®	iSXM	Quick Pulse Programming
ETOX	int_e!®	KEPROM	Ripplemode
Genius	Intel376	Library Manager	RMX/80
i486	Intel386	MAPNET	RUPI
i860	int_e!BOS	MCS®	Seamless
⤴	Intel Certified	Megachassis	SLD
i®	Intelelevision	MICROMAINFRAME	SugarCube
!PCE	int_e!ligent Identifier	MULTIBUS	UPI
ICE	int_e!ligent Programming	MULTICHANNEL	VLSiCEL
iCEL	Intellec®	MULTIMODULE	376
ICEVIEW	Intellink	ONCE	386
iCS	iOSP	OpenNET	386SX
iDBP	iPAT	OTP	387
iDIS	iPDS	PC BUBBLE	387SX
iLBX	iPSC®	Plug-A-Bubble	4-SITE
i_m®	iRMK	PROMPT	486

MULTIBUS is a patented Intel bus.

IBM is a registered trademark of International Business Machines, Inc.

PC, XT, and AT are trademarks of International Business Machines, Inc.

Microsoft, MS-DOS, OS/2, and XENIX are registered trademarks of Microsoft Corporation.

Multiplan is a trademark of Microsoft Corporation.

UNIX is a trademark of AT&T.

Lotus 1-2-3 and Symphony are registered trademarks of Lotus Development Corporation.

Framework II and dBASE III PLUS are registered trademarks of Ashton-Tate.

MultiMate is a trademark of Ashton-Tate.

VELCRO is a registered trademark of VELCRO USA, Inc.

Princeton is a registered trademark of Princeton Graphics Systems.

Cirrus Logic is a trademark of Cirrus Logic, Inc.

Hercules is a trademark of Hercules Technology Corporation.

Amdek is a registered trademark of Amdek Corporation.

<b>REV.</b>	<b>REVISION HISTORY</b>	<b>DATE</b>
-001	Original Issue (Release 1.0)	1/90

Copyright © 1990, Intel Corporation

# Contents

---

## About This Manual

Purpose .....	xix
Library Plan.....	xix
Audience.....	xx
Organization .....	xx
How to Obtain More Information .....	xxi
Notational Conventions .....	xxii
Related Publications .....	xxiv

## 1 Introduction

1.1	Summary of System Features .....	1-1
1.2	The Basic System Configuration .....	1-2
1.2.1	System Module .....	1-4
	System Module Configurations .....	1-5
	Optional Kits .....	1-6
	System Module Controls and Indicators .....	1-6
	System Module Rear Panel Connections.....	1-7
1.2.2	System Memory .....	1-9
	RAM.....	1-9
	Conventional Memory.....	1-9
	Extended Memory .....	1-9
	Onboard RAM.....	1-10
	ROM .....	1-11
	Shadow RAM .....	1-11
1.2.3	Monitor .....	1-11
1.2.4	Keyboard .....	1-12



<b>1</b>	<b>Introduction (continued)</b>	
1.3	Expanding Your System .....	1-12
1.3.1	Numeric Coprocessor.....	1-12
1.3.2	Expanding System Onboard RAM.....	1-13
1.3.3	System Board Expansion Slots.....	1-13
1.3.4	Additional Mass Storage Peripherals.....	1-13
1.4	System Security .....	1-13
<b>2</b>	<b>Installing Your System</b>	
2.1	Selecting a Site for Your System .....	2-1
2.2	Before You Begin .....	2-2
2.2.1	Components Checklist.....	2-2
2.2.2	Equipment Log .....	2-3
2.3	Installing Optional System Components .....	2-3
2.4	System Preparation .....	2-3
2.4.1	Removing the System Module Cover .....	2-4
2.4.2	Installing the System Module Cover .....	2-6
2.5	Expansion Boards .....	2-7
2.5.1	Expansion Board Installation.....	2-9
2.5.2	Expansion Board Removal .....	2-14
2.6	Mass Storage Peripherals .....	2-14
2.6.1	Installation and Removal of a 5.25-inch Floppy Disk Drive.....	2-14
	Installing a 5.25-inch Floppy Disk Drive .....	2-15
	Removing a 5.25-inch Floppy Disk Drive .....	2-18
2.6.2	Installing and Removing 3.5-inch Mass Storage Peripherals .....	2-18
	Installing a 3.5-inch Fixed Disk Drive.....	2-19
	Removing a 3.5-inch Fixed Disk Drive .....	2-22
2.7	Adding Onboard RAM.....	2-23
2.7.1	Installing SIMMs.....	2-23
2.7.2	Removing SIMMs.....	2-24
2.8	Installing and Removing a Numeric Coprocessor.....	2-26
2.8.1	Installing a Numeric Coprocessor.....	2-26
2.8.2	Removing a Numeric Coprocessor .....	2-27

<b>2</b>	<b>Installing Your System (continued)</b>	
2.9	Setting the System Board Jumpers.....	2-28
2.9.1	Changing System Board Jumper Settings .....	2-29
2.9.2	Jumper Setting Options .....	2-31
	Monitor Type .....	2-31
	Password Enable/Clear.....	2-32
	ROM Size .....	2-32
	Video Enable/Disable .....	2-33
2.10	Connecting External Peripheral Devices .....	2-33
2.10.1	Connecting a Monitor .....	2-34
2.10.2	Connecting a Keyboard.....	2-34
2.10.3	Connecting a Mouse.....	2-35
2.10.4	Connecting Other Peripherals .....	2-35
2.11	Connecting the System to a Power Outlet .....	2-35
2.12	Setting the Line Voltage Select Switch .....	2-35
2.13	Starting the System .....	2-37
2.14	Power-on Self Test (POST).....	2-37
<b>3</b>	<b>System Configuration</b>	
3.1	Setup Program .....	3-1
3.2	Running the Setup Program.....	3-2
3.2.1	Moving Through Setup Screen 1 .....	3-4
	Setting System Time.....	3-5
	Setting System Date.....	3-5
	Setting Floppy Disk Drive Types .....	3-6
	Setting Fixed Disk Drive Types.....	3-6
	Setting Extended Memory.....	3-7
	Setting Video Display Controller Type.....	3-7
	Setting Keyboard Availability.....	3-8
	Setting CPU Effective Speed .....	3-9

### 3 System Configuration (continued)

3.2.2	Moving Through Setup Screen 2 .....	3-10
	Enter Setup.....	3-11
	Speaker .....	3-11
	Onboard Video Display Controller.....	3-11
	Onboard Video Controller.....	3-12
	Monochrome Monitor Startup Mode.....	3-12
	Video Timing Register Lock.....	3-13
	Monitor Type.....	3-13
	Onboard Video BIOS Mapping .....	3-16
	Onboard Peripherals .....	3-17
	Password.....	3-17
	Parallel Port.....	3-17
	Serial Port 1 .....	3-17
	Serial Port 2 .....	3-18
	Console Redirection to COM1 .....	3-18
3.2.3	Moving Through Setup Screen 3 .....	3-19
	Shadowing System BIOS and Video BIOS.....	3-19
	Base Memory Above 512K .....	3-20
	Offboard Video Shadow .....	3-20
	Memory Roll.....	3-21
3.2.4	Exiting the Setup Program .....	3-21

### 4 Operating Your System

4.1	System Module Controls and Indicators.....	4-2
4.1.1	Keyboard Lock.....	4-2
4.1.2	Fixed Disk Drive Access Indicator.....	4-2
4.1.3	Reset Button.....	4-3
4.1.4	Power Indicator .....	4-3
4.1.5	Power Push Button.....	4-3
4.1.6	Floppy Disk Drive Access Indicator .....	4-3
4.1.7	Floppy Disk Release Button.....	4-3
4.2	The Keyboard .....	4-3

<b>4</b>	<b>Operating Your System (continued)</b>	
4.2.1	Keyboard Sections.....	4-4
	Escape Key .....	4-6
	Alphanumeric Key Group .....	4-6
	Shift Key .....	4-6
	Caps Lock Key.....	4-6
	Enter Keys.....	4-6
	Tab Key.....	4-7
	Backspace Key.....	4-7
	Ctrl Key .....	4-7
	Alt Key.....	4-7
	Function Key Group .....	4-7
	Edit Key Group .....	4-8
	Indicator Lights .....	4-8
	Cursor Control Key Group.....	4-8
	Numeric Keypad.....	4-8
4.2.2	Keyboard Operating Procedures.....	4-9
	Ending an Entry .....	4-9
	Correcting Typing Errors .....	4-9
	Executing System Reset from the Keyboard.....	4-9
4.3	Disk Drives.....	4-10
4.3.1	3.5-Inch Floppy Disk Drives .....	4-10
4.3.2	5.25-Inch Floppy Disk Drives .....	4-11
4.3.3	Fixed Disk Drives.....	4-11
4.4	Floppy Disks .....	4-11
4.4.1	Handling Floppy Disks .....	4-11
4.4.2	Write Protection.....	4-12
	Write-protecting 3.5-inch Floppy Disks .....	4-12
	Write-protecting 5.25-inch Floppy Disks .....	4-13
4.4.3	Inserting Floppy Disks.....	4-14
	Inserting a 3.5-inch Floppy Disk .....	4-14
	Inserting a 5.25-inch Floppy Disk .....	4-16
4.5	Changing the Effective System Speed .....	4-17

## 5 Solving Problems

5.1	Identifying and Solving System Problems .....	5-1
5.1.1	Problems at Initial System Startup .....	5-2
	Remedial Actions.....	5-2
5.1.2	Problems When Running a New Application Program (Other Programs Run Correctly) .....	5-2
	Remedial Actions.....	5-3
5.1.3	Problems After the System and Software Are Running Correctly.....	5-3
	Remedial Actions.....	5-4
5.2	Additional Troubleshooting Procedures .....	5-5
5.2.1	Error Checking .....	5-5
5.2.2	Troubleshooting Guide.....	5-6
5.2.3	Specific Problems and Remedial Actions .....	5-9
	Power Supply Fan Does Not Rotate .....	5-10
	Power Indicator LED Does Not Light.....	5-10
	No Characters Appear on Screen.....	5-10
	Characters Appear on the Screen, but are Distorted or Incorrect .....	5-11
	No Beep Pattern.....	5-12
	Floppy Disk Drive Access Indicator Does Not Light .....	5-12
	Floppy Disk Drive Access Indicator Remains Lighted .....	5-12
	Fixed Disk Drive Access Indicator Does Not Light.....	5-12
	Problems With Application Software .....	5-13
	Cannot Set System Password.....	5-14

## 6 Maintaining Your System

6.1	Removing and Replacing the System Battery .....	6-1
6.1.1	Removing the Battery.....	6-1
6.1.2	Replacing the Battery.....	6-2
6.2	Cleaning the System.....	6-2
6.3	Cleaning the Screen .....	6-3
6.4	Moving the System .....	6-3
6.4.1	Packing the System.....	6-4
6.4.2	Installing the System at the New Location .....	6-4

**A Technical Characteristics**

A.1	System Specifications.....	A-1
A.1.1	System Board.....	A-2
A.1.2	Dimensions .....	A-2
A.1.3	Environment .....	A-3
A.2	System Interfaces .....	A-3
A.2.1	Floppy Disk Interface Connector .....	A-4
A.2.2	Fixed Disk Interface Connector.....	A-5
A.2.3	Serial Port Connectors .....	A-6
A.2.4	Parallel Printer Port.....	A-8
A.2.5	Expansion Slot Connectors.....	A-9
A.2.6	Video Interface Connectors.....	A-11
A.2.7	Speaker Interface .....	A-13
A.2.8	Battery Connector .....	A-13
A.2.9	Keyboard Connector.....	A-13
A.2.10	Mouse Connector .....	A-14
A.2.11	Keylock Interface.....	A-15
A.2.12	Power Supply Header .....	A-15
A.3	Power Supply.....	A-16

**B Error and Informational Messages**

B.1	Introduction.....	B-1
B.2	POST and Boot Messages.....	B-1
B.2.1	POST and Boot Error Messages.....	B-2
B.2.2	POST and Boot Informational Messages.....	B-10
B.3	Run-time Messages.....	B-11
B.4	System Board Errors .....	B-12

**C Equipment Log**

**Glossary**

**Index**

## Figures

---

### 1 Introduction

1-1	Typical Intel386™ MicroComputer Model 300SX System .....	1-3
1-2	System Module Front View .....	1-7
1-3	System Module Rear View .....	1-8
1-4	Memory Address Map .....	1-10

### 2 Installing Your System

2-1	Removing the System Module Cover .....	2-4
2-2	Locations of Internal System Components .....	2-5
2-3	Replacing the System Module Cover .....	2-6
2-4	System Board Layout .....	2-8
2-5	Removing the Expansion Slot Cover .....	2-10
2-6	Removing a Board From Its Wrapper .....	2-11
2-7	Seating the Board .....	2-12
2-8	Completing Board Installation .....	2-13
2-9	Removing a Peripheral Device Bay Cover .....	2-15
2-10	Installing a 5.25-inch Floppy Disk Drive .....	2-16
2-11	5.25-inch Floppy Disk Drive Connections .....	2-17
2-12	Removing the Peripheral Bay Bezel .....	2-19
2-13	Installing a Fixed Disk Drive .....	2-20
2-14	Fixed Disk Drive Connections .....	2-21
2-15	Installing SIMMs .....	2-24
2-16	Removing SIMMs .....	2-25
2-17	Installing a Numeric Coprocessor .....	2-27
2-18	Installing a Shorting Plug .....	2-28
2-19	System Board Jumper Locations .....	2-30
2-20	Setting the Line Voltage Select Switch .....	2-36

**3 System Configuration**

3-1	Setup Screen 1 .....	3-3
3-2	Setup Screen 2 .....	3-10
3-3	Setup Screen 3 .....	3-19

**4 Operating Your System**

4-1	Keyboard Layout and Features .....	4-5
4-2	Write Protecting a 3.5-inch Floppy Disk .....	4-13
4-3	Write Protecting a 5.25-inch Floppy Disk .....	4-14
4-4	Inserting a 3.5-inch Floppy Disk .....	4-15
4-5	Inserting a 5.25-inch Floppy Disk .....	4-16



## Tables

---

### 2 Installing Your System

2-1	Color/Monochrome Monitor Jumpers .....	2-31
2-2	Password Enable/Clear Jumpers.....	2-32
2-3	ROM Size Jumpers.....	2-33
2-4	Video Enable/Disable Jumpers .....	2-33

### 3 System Configuration

3-1	Video Options Summary.....	3-14
-----	----------------------------	------

### A Technical Characteristics

A-1	AC Input Power Requirements .....	A-3
A-2	Floppy Disk Interface Connector J18 Pinouts .....	A-4
A-3	Fixed Disk Interface Connector J19 Pinouts .....	A-5
A-4	Serial Port Connectors J2A and J2B Pinouts .....	A-6
A-5	Serial Port Header J13 Pinouts.....	A-7
A-6	Parallel Port Connector J1 Pinouts.....	A-8
A-7	Parallel Port Header J11 Pinouts.....	A-9
A-8	Intel ISA Bus 8-bit Connector Pin Assignments.....	A-10
A-9	Intel ISA Bus 16-bit Connector Pin Assignments.....	A-11
A-10	Video Connector J5 Pinouts .....	A-12

**A Technical Characteristics (continued)**

A-11	Video Connector J6 Pinouts .....	A-12
A-12	Speaker Header J12 Pinouts.....	A-13
A-13	Keyboard Connector J3B Pinout.....	A-14
A-14	Mouse Connector J4 Pinouts .....	A-14
A-15	Keylock Header J24 Pinouts.....	A-15
A-16	Power Supply Header J12 Pinouts.....	A-16
A-17	System Input Power Requirements .....	A-16

**B Error and Informational Messages**

B-1	Beep Codes for Fatal Errors.....	B-13
B-2	Beep Codes for Non-fatal Errors.....	B-14



## About This Manual

---

### PURPOSE

This manual shows you how to install, set up, and operate the Intel386™ MicroComputer Model 300SX System. The goal is to familiarize you with all aspects of the system. The manual first describes the key features of the system. Next, it guides you through installation and operation of the system. The manual then describes routine maintenance procedures and gives guidelines to help you troubleshoot the system should problems occur. The manual concludes with appendices which contain reference information such as system specifications and error messages.

### LIBRARY PLAN

The Intel386™ MicroComputer Model 300SX System is fully described in a set of three manuals. A brief description of these manuals is as follows:

- *Intel386™ MicroComputer Model 300SX User's Guide*. This manual is written for an end-user. It describes all system features, installation and operation of the system, how to install or remove system components, and basic troubleshooting procedures should problems occur.

- *Intel386™ MicroComputer Model 300SX System Technical Reference Manual.* This manual and its companion volume, *Intel386™ MicroComputer Model 300SX Board Technical Reference Manual*, are written primarily for an Original Equipment Manufacturer (OEM), system integration engineer, or hardware or software designer. The system manual describes the major elements contained in the system module chassis. This manual provides a general description of the system, a brief overview of the 300SX board, all internal interfaces to other components, and all external interfaces. Basic installation and removal procedures for system components and peripheral devices are also included.
- *Intel386™ MicroComputer Model 300SX Board Technical Reference Manual.* This manual and its companion volume, *Intel386™ MicroComputer Model 300SX System Technical Reference Manual*, are written primarily for an OEM, system integration engineer, hardware or software designer. This manual provides a detailed description of the 300SX board, including the CPU core, onboard DRAM, ROM, ISA bus, DMA, BIOS, jumper settings, and keyboard controller, etc. This manual is written for engineers who design system accessories and for programmers who require information on hardware and firmware specifications.

## AUDIENCE

This manual is written for an end user. It assumes that the reader is familiar with the general terminology associated with personal computers.

## ORGANIZATION

This manual is organized as follows:

- |           |  |
|-----------|--|
| Chapter 1 | System Description — provides a system overview and introduction to major system components and system configurations. |
| Chapter 2 | Installing Your System — explains how to install and connect system peripherals and options.                           |

Chapter 3	System Configuration — explains how to use the setup program to configure the system for use.
Chapter 4	Operating Your System — explains how to operate the system.
Chapter 5	Solving Problems — gives guidelines for solving problems that may arise after setting up the system.
Chapter 6	Caring for Your System — explains how to care for your system and how to prepare it for relocation.
Appendix A	Technical Characteristics — gives technical specifications for the system.
Appendix B	Error and Informational Messages — lists system error messages and recommends corrective action.
Appendix C	Equipment Log — describes how to prepare and maintain an equipment log.
Glossary	Glossary — defines the standard acronyms and technical terms used in the field of personal computing.
Index	Index — provides important terms arranged in alphabetical order for quick reference.

## HOW TO OBTAIN MORE INFORMATION

You may be interested in obtaining further information about products and services relating to the Intel386™ MicroComputer Model 300SX System. Or you may require more detailed information about this system than is provided in this manual.

Please contact your local Intel Sales Office if you desire additional information.

## NOTATIONAL CONVENTIONS

Certain notational conventions are used throughout this manual and others in the library. Refer to the glossary for specific definitions. Notational conventions include:

- system            Throughout this manual, the terms "system" and "300SX System" apply to the Intel386™ MicroComputer Model 300SX System.
- board             Throughout this manual, the term "300SX board" or "board" applies to the Intel386™ MicroComputer Model 300SX System Board.
- F1**                A letter, number, symbol, or word enclosed in a double rectangle, and printed in small type represents a key on your keyboard. For example, the instruction "press **F1**" means press the key labeled "F1" on your keyboard.
- Backspace**       This manual refers to most keys by the symbol, letter, or name printed on the key. The exception is the **Backspace** key. The **Backspace** key is called Backspace to distinguish it from the left arrow key.
- Enter**            This manual uses Enter to refer to the two **Enter** keys. Other manuals refer to the **Enter** keys as RETURN, CARRIAGE RETURN, or use an arrow. All these terms are interchangeable.
- x** + **y**            Two or three key names with plus signs between them indicate multiple-key entries. For example, **Ctrl** + **Alt** + **Del** means hold down the **Ctrl** and **Alt** keys and press the **Del** key.
- \*
- H                  An asterisk (\*) following a signal name indicates an active low signal; for example, IOCHECK\*.
- H                  An H suffix to a numerical value denotes a hexadecimal number. For example, 0F8H means 0F8 (hexadecimal).

- K** A K (upper case) suffix to a numerical value is used to indicate size in kilobytes; i.e., 7168K, 640K, etc. Note that while a kilobyte is defined as 1024 bytes, the lower case k prefix used in other measurements indicates a quantity of 1,000. The K suffix is synonymous with KB or Kbyte. See the Glossary.
- Kb** A Kb suffix to a numerical value indicates size in kilobits. For example: 512Kb. (One kilobit is defined as 1024 bits.)
- M** An M suffix to a numerical value is used to indicate size in megabytes; i.e., 1M, 256M, etc. Note, however, that while a megabyte is defined as 1,048,576 bytes the M prefix used in other measurements indicates a quantity of 1,000,000. The M suffix is synonymous with MB or megabyte. See Glossary.
- Mb** An Mb suffix to a numerical value indicates size in megabits. For example: 4Mb. (One megabit is defined as 1,048,576 bits.)

An italicized word or phrase is used to represent a variable, a publication title, or occasionally, to lend emphasis in textual descriptions. Where shown, DOS, UNIX or XENIX files, path names and directories are also italicized.

Three kinds of special notices are used throughout the text to emphasize specific information. Examples of each kind of admonishment are as follows:



**Note**

Notes are used to provide the reader with important or explanatory information.



**WARNING**

WARNING indicates the presence of a hazard that *can* cause death or severe personal injury if the hazard is not avoided.



**CAUTION**

CAUTION indicates the presence of a hazard that *can or will* cause minor personal injury or damage to hardware or software.



## RELATED PUBLICATIONS

Refer to the following publications for additional information relating to the Intel386™ MicroComputer Model 300SX System and its operating environment.

- *Intel386™ MicroComputer Model 300SX Board Technical Reference Manual* (Intel order number 459941-001)
- *Intel386™ MicroComputer Model 300SX System Technical Reference Manual* (Intel order number 459940-001)
- *Introduction to the 80386* (Intel order number 231252-001)
- *80386 Programmer's Reference Manual* (Intel order number 230985-001)
- *80386 Hardware Reference Manual* (Intel order number 231732-003)
- *80386 System Software Writer's Guide* (Intel order number 231499-001)
- *Microprocessor and Peripheral Handbook* (Intel order number 230843-006)

## Introduction

# 1

---

This chapter introduces the features and capabilities of the Intel386 MicroComputer 300SX System. Before installing the 300SX System, read this chapter and familiarize yourself with the following:

- Important system features
- The system configuration

### 1.1 SUMMARY OF SYSTEM FEATURES

The Intel386 MicroComputer Model 300SX System is a cost-effective 32-bit computer platform based on the low-cost Intel 386SX™ 16 MHz microprocessor. The system's AT-compatible architecture features up to 4M of onboard DRAM and Phoenix Technologies' ROM BIOS. The Intel 387SX™ numeric coprocessor is also supported to significantly enhance the performance of math-intensive applications.

The system contains onboard support for all standard graphics monitors (VGA, EGA, CGA, monochrome, and Hercules). It also provides a floppy disk controller and an embedded Intelligent Drive Electronics (IDE)-AT fixed disk interface on the system board.

The system has been designed to allow OEMs to add their own unique value by customizing the system with off-the-shelf boards, peripheral devices, operating systems, and application software.

The 300SX System is compatible with a large base of existing DOS software, and has been tested under a number of operating environments, including PC-DOS, MS-DOS, MS-OS/2, UNIX, iRMX™, and XENIX. Application software that runs within those environments has also been tested. Contact your Intel Representative for a current list of tested software.

### 1.2 THE BASIC SYSTEM CONFIGURATION

The 300SX System consists of three major modules illustrated in Figure 1-1.

- The system module
- The keyboard — optional
- The monitor — optional

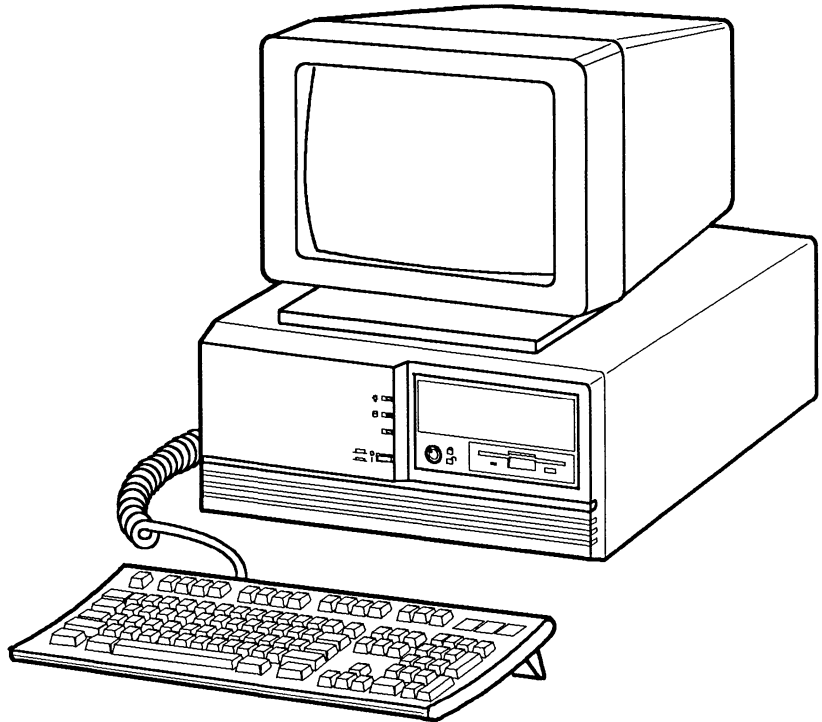

OM-00079

---

**Figure 1-1. Typical Intel386™ MicroComputer Model 300SX System**

## 1.2.1 System Module

The system module contains the system board, internal magnetic peripherals, a power supply, and slots for expansion boards.

The standard features of the 300SX System include:

- A 16 MHz CPU system board with support circuitry
- Socket for a 16 MHz 387SX numeric coprocessor
- Zero or two megabytes of onboard DRAM (user expandable to 4M)
- An AT-compatible Phoenix Technologies ROM BIOS that can be downloaded into DRAM
- Four 16-bit expansion slots
- Seven direct memory access (DMA) channels
- Support for fifteen interrupts
- Sixty-four bytes of CMOS RAM with lithium battery backup for permanent storage of system clock/calendar and configuration data
- One 9-pin TTL (digital) monitor connector and one 15-pin analog monitor connector
- Peripheral expansion capability for up to two (one 3.5-inch and one 5.25-inch) half-height peripheral devices and one 3.5-inch third-height peripheral device
- A keylock to electrically lock out the keyboard
- A chassis-mounted speaker for sound generation
- Light-emitting diode (LED) indicators for power and fixed disk drive access
- A 145 watt nonswitching power supply

- A recessed reset switch
- A recessed power switch
- One configurable AT-compatible 25-pin parallel printer port
- Two configurable AT-compatible RS-232C 9-pin serial communications ports
- AT-compatible keyboard interface
- PS/2 mouse port
- Onboard video subsystem (Cirrus Logic) with support for super VGA, VGA, CGA, MGA, and Hercules graphics standards
- Onboard floppy disk controller with support for 5.25-inch and 3.5-inch floppy disk drives
- 40-pin IDE-AT fixed disk drive interface

### **SYSTEM MODULE CONFIGURATIONS**

The 300SX System is offered in several different configurations. These configurations include 0 or 2M of onboard RAM and a 1.44M (3.5-inch) floppy disk drive either by itself or with a fixed disk drive. The system module configurations available include:

- Zero or two megabytes of onboard RAM and no mass storage devices
- Zero or two megabytes of onboard RAM and one 1.44M, 3.5-inch floppy disk drive
- Zero or two megabytes of onboard RAM, one 1.44M, 3.5-inch floppy disk drive, and one 40M fixed disk drive
- Zero or two megabytes of onboard RAM, one 1.44M, 3.5-inch floppy disk drive, and one 80M fixed disk drive

## OPTIONAL KITS

Optional features available for the system include:

- 40M fixed disk drive (with embedded IDE-AT interface)
- 80M fixed disk drive (with embedded IDE-AT interface)
- AT-compatible 101-key enhanced keyboard
- Two-megabyte memory upgrade

## SYSTEM MODULE CONTROLS AND INDICATORS

Figure 1-2 shows the front panel and the location of the following controls and indicators:

- **Keyboard lock.** Turn the key to the locked position to disable the keyboard.
- **Fixed disk drive access indicator.** This indicator lights (amber) when the fixed disk drive is accessed.
- **Reset button.** Use the reset button to reset the system module without turning off the power.
- **Power indicator.** This indicator lights (green) when the system module power is on.
- **Power push button.** Use the power push button to turn the system module on or off.
- **Floppy disk drive access indicator.** This indicator lights (amber) when the floppy disk drive is accessed.
- **Floppy disk drive release button.** Push this button to eject a floppy disk from the floppy disk drive.

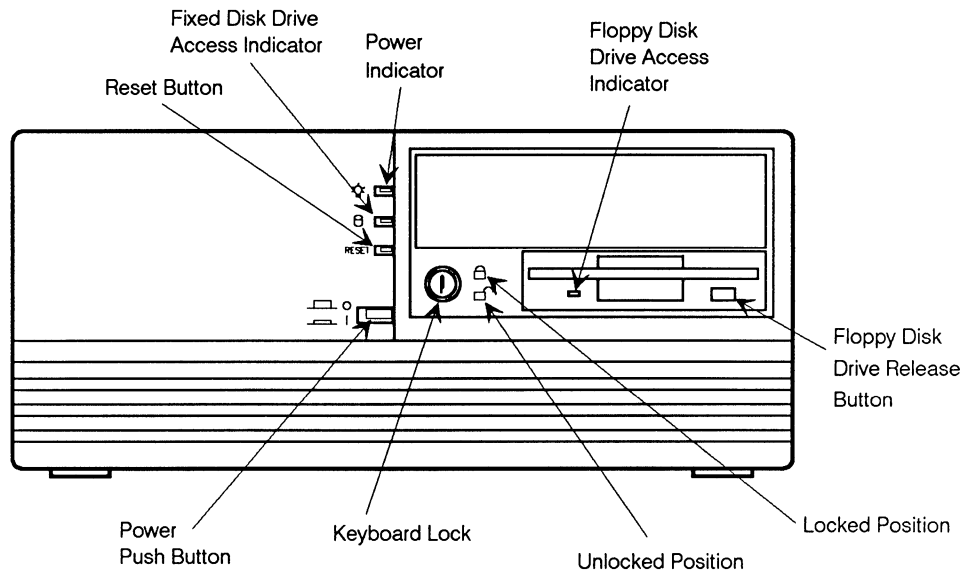

OM-00080

**Figure 1-2. System Module Front View**

## SYSTEM MODULE REAR PANEL CONNECTIONS

Figure 1-3 shows the system rear panel and the location of the following connectors and switches:

- AC line connector
- Line voltage selection switch
- Switched peripheral power outlet
- Expansion slots



- Parallel port connector
  - Serial port connectors
  - Keyboard connector
  - Mouse connector
  - Analog video connector
  - Digital (TTL) video connector
- 

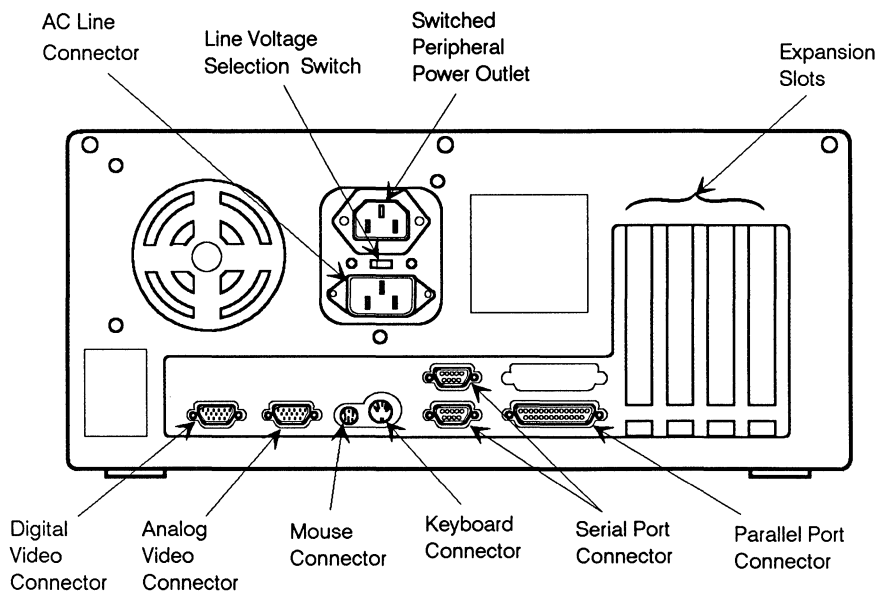

OM-00081-2

---

**Figure 1-3. System Module Rear View**

## 1.2.2 System Memory

The 300SX System provides two types of memory: random access memory (RAM) and read-only memory (ROM).

### RAM

RAM exists in two modes: conventional (base memory) and extended memory.

### Conventional Memory

Conventional memory is located within an address range of 000000H to 09FFFFH (640K of memory) (see Figure 1-4).



#### Note

Some versions of DOS cannot address more than 640K of conventional memory.

### Extended Memory

Extended memory is memory above one megabyte (100000H). Extended memory can only be accessed when the CPU is operating in protected mode.



#### Note

The protected mode of the 386SX microprocessor enables it to provide advanced features such as accessing large amounts of memory. Current versions of DOS do not support this mode.

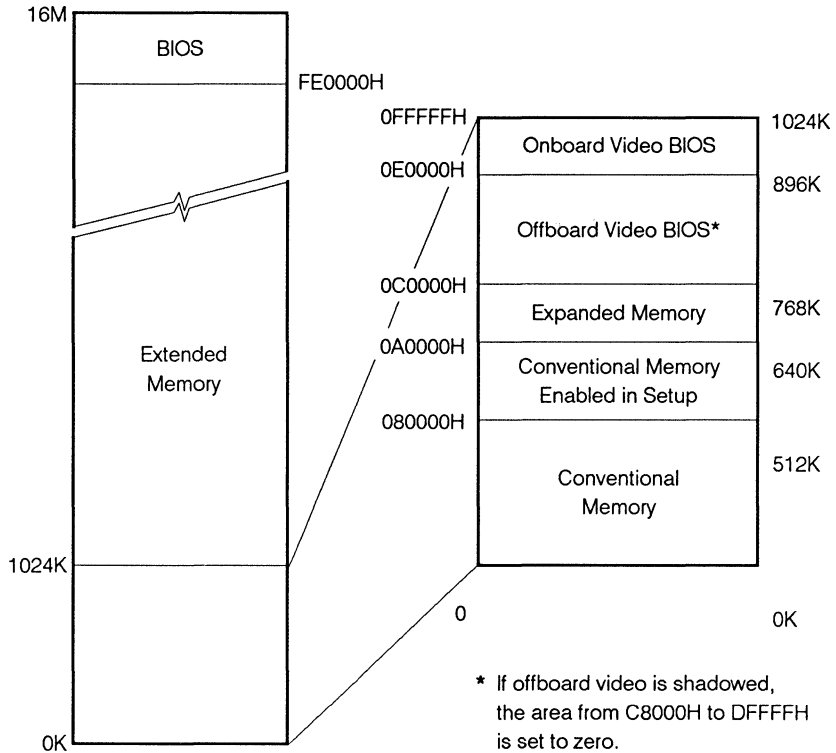

OM-00156

**Figure 1-4. Memory Address Map**

### Onboard RAM

Single in-line memory modules (SIMMs) make up the onboard system RAM. These SIMMs are small memory boards containing nine DRAM chips. SIMMs are installed in rows of sockets on the system board.

The 300SX System is configured with either 0 or 2M of RAM (two 1M SIMMs). You can expand these configurations to 4M by adding two or four additional 1M SIMMs.

 **Note**

The 300SX System can accommodate 256K SIMMs. However, 256K and 1M SIMMs cannot be mixed in the same system.

### **ROM**

The system board ROM contains the system BIOS, onboard video BIOS, setup program, and power-on self test (POST).

### **SHADOW RAM**

An option is available that allows the system BIOS and onboard video BIOS (stored in onboard ROM) to be copied into onboard RAM for faster access. This option is referred to as "shadowing."

When the ROM BIOS is copied into RAM, the CPU accesses the BIOS at the same speed it accesses other onboard RAM. The system board architecture makes sure that the ROM BIOS copied into the RAM is write-protected. This prevents inadvertent overwriting of BIOS information.

### **1.2.3 Monitor**

The 300SX System onboard video subsystem supports Super VGA, VGA, EGA, CGA, MGA, and Hercules graphics and compatible monitors. These monitors provide high resolution text and graphics modes. An instruction booklet, packed with the monitor, shows the location of all controls, including the screen brightness and contrast controls.

### 1.2.4 Keyboard

The system keyboard allows you to interact with the 300SX System by entering data or commands. Chapter 4, "Operating Your System," describes the layout of the keyboard and explains how to use the different groups of keys.

## 1.3 EXPANDING YOUR SYSTEM

You can expand the 300SX System by adding memory, peripherals, and other options. The system provides the following expansion capabilities:

- A socket for a 16 MHz 387SX numeric coprocessor
- Sockets on the system board for an additional 2M or 4M of onboard RAM
- Four 16-bit expansion slots (These slots also accommodate all 8-bit expansion boards except drop cards.)
- Three expansion bays:
  - One half-height, 5.25-inch form factor (externally accessible)
  - One half-height, 3.5-inch form factor (internal)
  - One third-height, 3.5-inch form factor (externally accessible)

### 1.3.1 Numeric Coprocessor

Adding a 387SX numeric coprocessor increases the numeric processing speed of the 300SX System. The numeric coprocessor plugs directly into a socket on the system board. The numeric coprocessor performs mathematical computations many times faster than the 386SX microprocessor, resulting in higher performance for numerical applications such as spreadsheets and graphics.

### **1.3.2 Expanding System Onboard RAM**

You can expand system onboard RAM by installing an additional 2M of SIMM RAM in the system board memory sockets.

### **1.3.3 System Board Expansion Slots**

The system board contains four 16-bit expansion slots. These slots (J7, J8, J9, and J10) accept any 16-bit or 8-bit expansion board except drop cards. These expansion slots operate at 8 MHz.

### **1.3.4 Additional Mass Storage Peripherals**

You can add additional mass storage peripherals to the system module to increase its storage capacity and flexibility. The following mass storage peripherals are available:

- A 3.5-inch floppy disk drive
- A 5.25-inch floppy disk drive
- 40M and 80M fixed disk drives

## **1.4 SYSTEM SECURITY**

Your system contains the following security features:

- A built-in system password (stored in CMOS RAM)
- A keyboard lock

Refer to Chapter 4, "Operating Your System," for instructions on using these system security features.



## Installing Your System

# 2

---

This chapter provides instructions for installing and setting up the 300SX System. Instructions include:

- Selecting a site for the system
- Installing optional system components
- Setting the system board jumpers
- Connecting peripheral devices to the system
- Connecting the system to a power outlet
- Starting the system

### 2.1 SELECTING A SITE FOR YOUR SYSTEM

The 300SX System operates reliably in a typical office or home environment. Choose a site that is:

- Near a grounded power outlet
- Clean and dust-free
- Well ventilated and away from sources of heat
- Isolated from strong electromagnetic fields produced by electrical devices (such as air conditioners, large fans, large electric motors, radio and TV transmitters, and high frequency security devices)



## 2.2 BEFORE YOU BEGIN

Before installing the system, remove all components from the shipping containers and have the following tools available:

- A flat-blade screwdriver (medium)
- A Phillips screwdriver (medium)
- A pen or pencil
- A 3/16-inch nutdriver (recommended)
- An antistatic wrist strap (recommended)

### Note

Make sure you save all boxes and packing material for future use.

### 2.2.1 Components Checklist

After unpacking the system, check that all components you ordered are present and appear to be in good condition. Check for the following:

- System module
- Two keys for the keyboard lock
- System module power cord

If any component is damaged or missing, contact your authorized dealer.

### **2.2.2 Equipment Log**

Use the form provided in Appendix C to record the model and serial number of the system, all installed options, and any other pertinent information specific to the system. You will need this information during the setup process. For more information, refer to Appendix C, "Equipment Log."

## **2.3 INSTALLING OPTIONAL SYSTEM COMPONENTS**

Optional system components consist of the following devices:

- Onboard RAM
- Numeric coprocessor
- Expansion boards
- Mass storage peripherals

If you plan to install any of the optional system devices listed, refer to the following instructions. However, if you plan to connect only external peripheral devices, refer to section 2.10.

## **2.4 SYSTEM PREPARATION**

The cover must be removed from the system module before you can access any internal components.

## 2.4.1 Removing the System Module Cover



### WARNING

Unplug the system before performing the following procedure. Failure to disconnect power before opening the system module can result in personal injury or equipment damage.

- 1 Shut off power to all peripheral devices connected to the system. Push the system power button.
- 2 Disconnect all cables to the system and identify with tags or labels to facilitate accurate reconnection.
- 3 Fully loosen the three captive cover mounting screws.
- 4 Slide the cover off the system module by moving it toward the front of the chassis, as shown in Figure 2-1. Make sure the cover does not catch on any ribbon cables or wires.

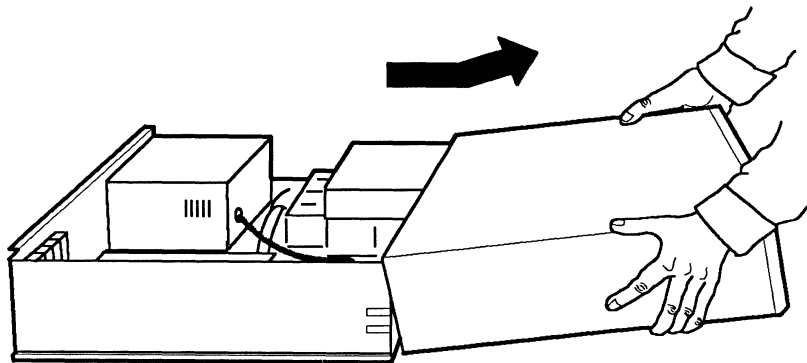

OM-00149-2

---

**Figure 2-1. Removing the System Module Cover**

Figure 2-2 shows the locations of the major internal components of the system.

---

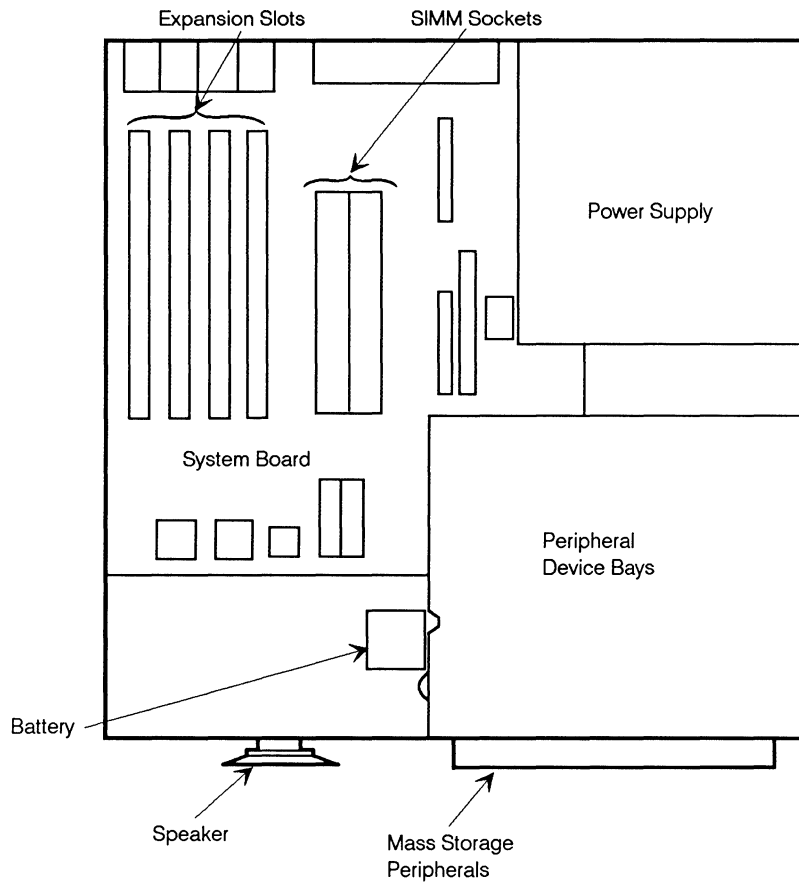

OM-00160

---

**Figure 2-2. Locations of Internal System Components**

## 2.4.2 Installing the System Module Cover

Reinstall the cover as follows:

- 1 Make sure no tools or loose parts have been inadvertently left in the interior of the chassis and that all interior cables are properly connected and secure. Make sure all expansion boards are firmly seated in their respective slots.
- 2 Carefully fold or coil the ribbon cables and press them down into the area between the power supply and the peripheral device bays. The cables should not project above the level of the power supply.
- 3 Position the cover over the front of the chassis, as shown in Figure 2-3. Carefully slide the cover a short distance under the rail on the frame, then lift it up against the rail and slide it onto the chassis to approximately the mid-point.

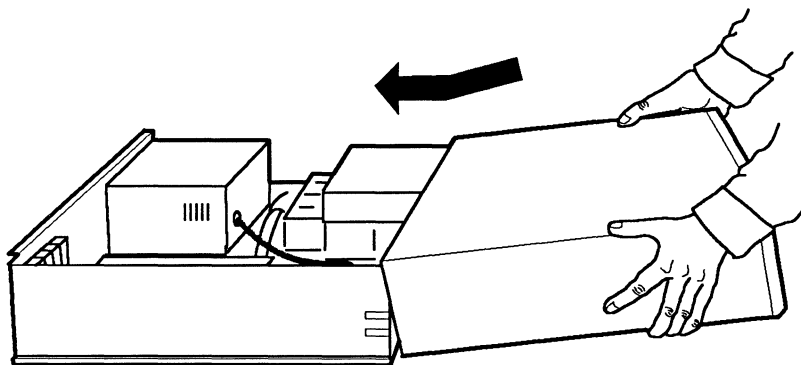

OM-00149-3

---

**Figure 2-3. Replacing the System Module Cover**

- 4 Make sure the ribbon cables are clear as you continue sliding the cover over the chassis. As the rear of the cover approaches the rear chassis vertical plate, it may be necessary to slightly lift up the cover at the rear to easily clear the plate.
- 5 Tighten the three captive cover mounting screws.
- 6 Connect all previously removed cables.

## 2.5 EXPANSION BOARDS

This section describes how to install expansion boards in the 300SX System. Procedures are provided for installing and removing 8-bit or 16-bit standard boards.

### Note

Be sure to record the expansion board manufacturer's model and serial number in the equipment log in Appendix C.

The system board contains four 16-bit expansion slots, J7 through J10 (see Figure 2-4). These expansion slots can accept any expansion board that is compatible with the IBM AT. In addition, they can accommodate all 8-bit PC/XT-compatible boards, except for drop cards. The expansion slots operate at 8 MHz.

### Note

Some older 6 MHz expansion boards may not operate properly at 8 MHz. Check the board manufacturer's instructions to verify operation at 8 MHz.

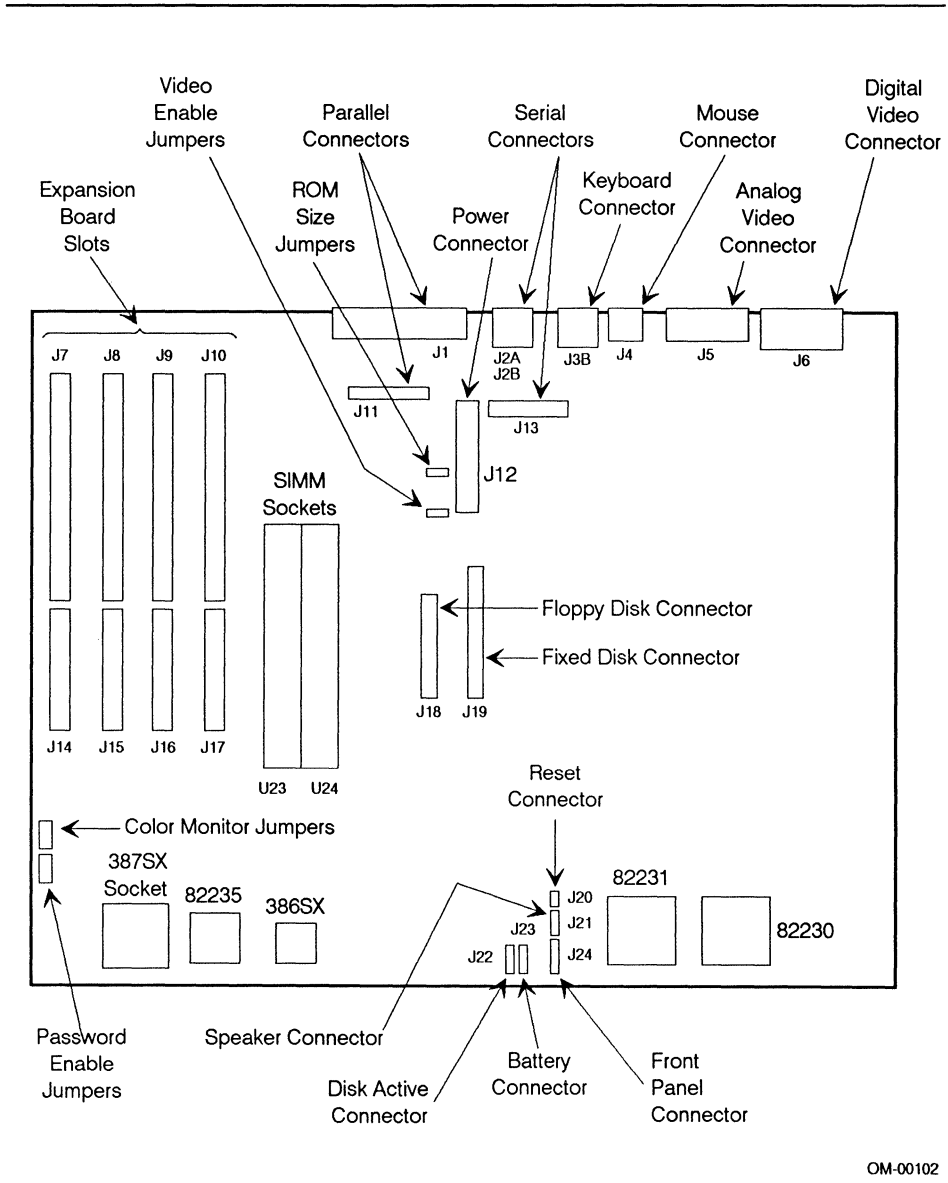

OM-00102

Figure 2-4. System Board Layout



### CAUTION

Do not overload the 300SX board power connectors by installing expansion boards that may draw excessive current. Refer to the applicable section in the *Intel386™ MicroComputer Model 300SX System Technical Reference Manual* for expansion slot current limitations.

Expansion boards can be extremely sensitive to electrostatic discharge (ESD) and always require careful handling. The precautions included in the following instructions are to ensure that the boards are installed or removed without being damaged.

## 2.5.1 Expansion Board Installation



### CAUTION

Do not remove the board from its protective wrapper unless you are in an ESD-protected environment. We strongly recommend that you perform all board installations at an ESD workstation. If such a workstation is not available, you can provide a minimum of ESD protection by wearing a static control wrist strap and attaching it to chassis ground when handling any internal system part.

During removal or installation procedures, place boards flat on a grounded, static-free surface, component-side up; put the board on a conductive foam pad if available. Do not slide boards over any surface. Clear the work area of plastic, vinyl, and Styrofoam objects.

The following general procedure can be used to install any expansion board.

- 1 Prepare the system as described in section 2.4.1.
- 2 Select the slot in which to install the board.
- 3 Remove and save the expansion slot cover and screw (see Figure 2-5).
- 4 Make sure your workstation is properly grounded. Then bring yourself to zero voltage potential by wearing an ESD wrist strap connected to ground.



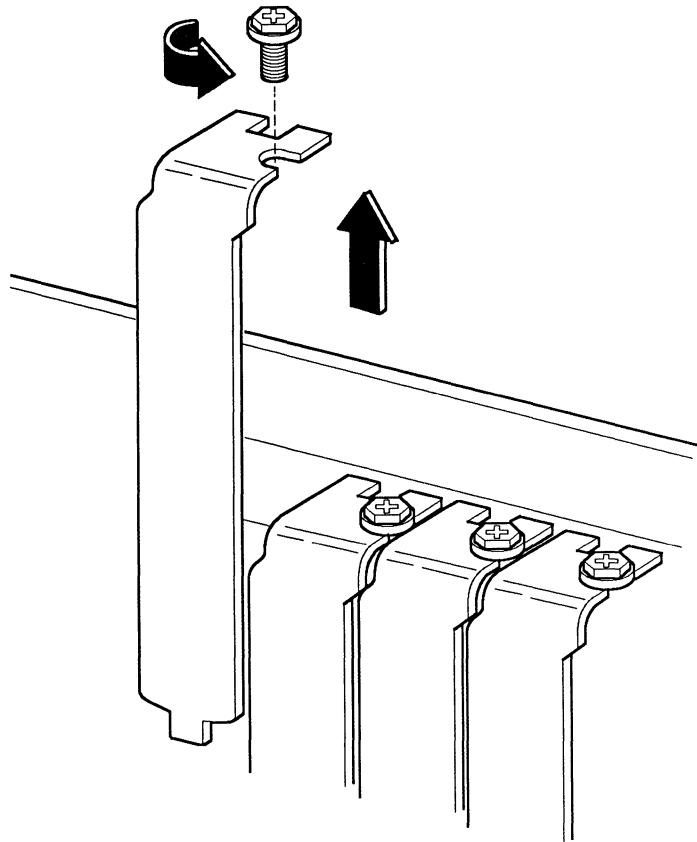

OM-00150

**Figure 2-5. Removing the Expansion Slot Cover**

- 5 Record the board's serial number in the equipment log (as described in Appendix C).
- 6 Remove the board from its wrapper, holding the board by the edges only. Avoid touching the board elements and the gold connectors (see Figure 2-6).

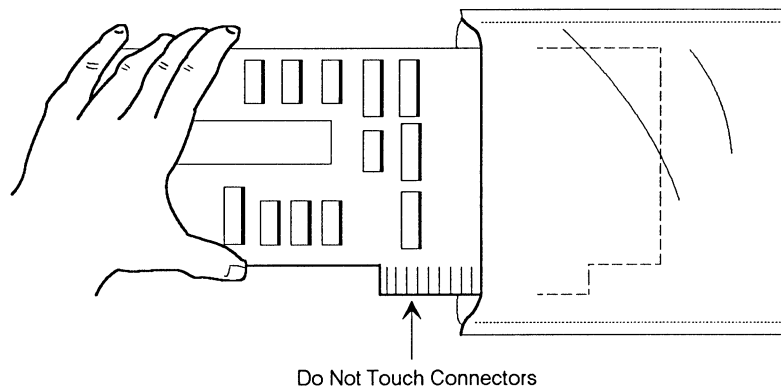

OM-00151

---

**Figure 2-6. Removing a Board From Its Wrapper**



### CAUTION

Do not lay the board on an ungrounded surface after removing it from its protective wrapper. This includes laying it on the wrapper itself, which can contain voltage on its outer surface.

- 7 Insert the board's connectors into the expansion slot by firmly pressing the board into the slot while holding the board by its top edge or upper corners (see Figure 2-7).

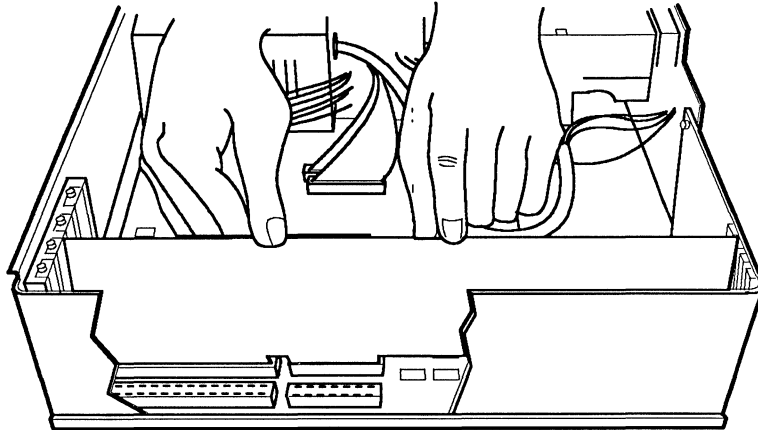

OM-00082

---

**Figure 2-7. Seating the Board**



**Note**

The foot of the expansion board retaining bracket must fit into the slot in the bottom of the chassis. Do not use excessive force to fit the bracket in place.

- 8 Align the hole in the board retaining bracket with the screw slot in the expansion slot frame. The card retaining bracket fits into the space that was previously occupied by the expansion slot cover.

- 9 Insert the screw (see Figure 2-8), making certain that the bracket screw slot is pushed all the way against the screw before tightening. If this is not done, the expansion board bracket may interfere with an adjacent bracket.
- 10 Reinstall the cover and reconnect cables as detailed in section 2.4.2.

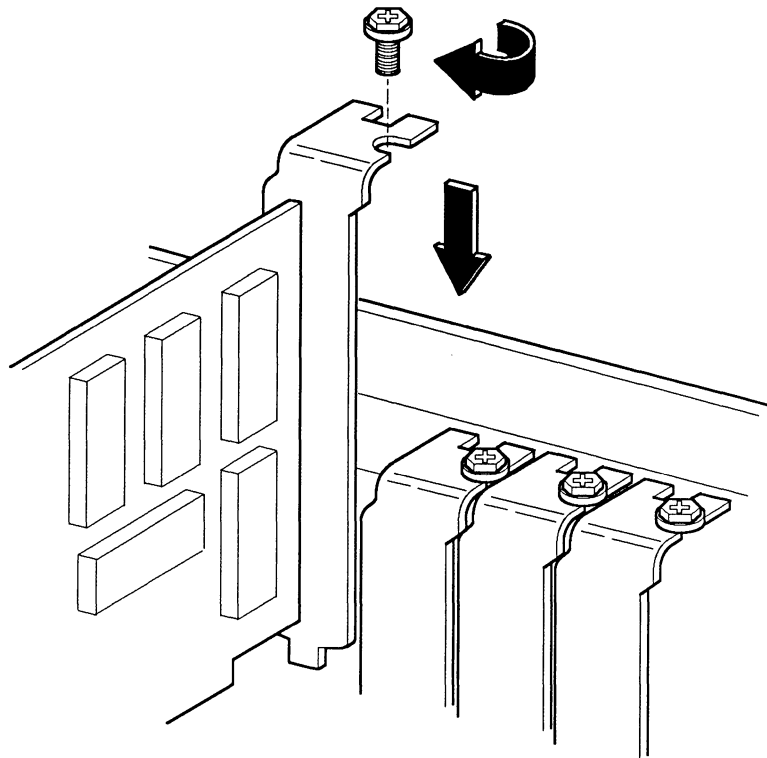

OM-00152

---

**Figure 2-8. Completing Board Installation**

## 2.5.2 Expansion Board Removal

Expansion board removal is essentially the reverse order of installation.

- 1 Prepare the system as described in section 2.4.1.
- 2 Remove the screw holding the expansion bracket to the chassis (see Figure 2-5).
- 3 Disconnect any cables or connectors from the expansion board to be removed.
- 4 Ensure that you are properly grounded by wearing an ESD wrist strap connected to ground.
- 5 Grasp the board at each end and carefully, but firmly, rock it slightly until the edge connectors pull free. Take care not to scrape the board against other components.
- 6 Store the board in an antistatic protective wrapper.
- 7 Install an expansion slot cover over the vacant expansion slot using the screw that was previously removed.

## 2.6 MASS STORAGE PERIPHERALS

This section describes how to install mass storage devices (floppy and fixed disk drives) in the peripheral bays. Procedures are also provided in the event any of these devices have to be removed or replaced. Be sure to record the model and serial number of all installed magnetic peripherals in the equipment log.

### 2.6.1 Installation and Removal of a 5.25-inch Floppy Disk Drive

The following sections describe how to install or remove a 5.25-inch floppy disk drive in the top peripheral device bay.

## INSTALLING A 5.25-INCH FLOPPY DISK DRIVE

- 1 Remove the system module cover as described in section 2.4.1.
- 2 Remove the two screws holding the top peripheral device bay cover (see Figure 2-9). Retain the screws for later use.
- 3 Carefully slide the drive all the way into the peripheral device bay.

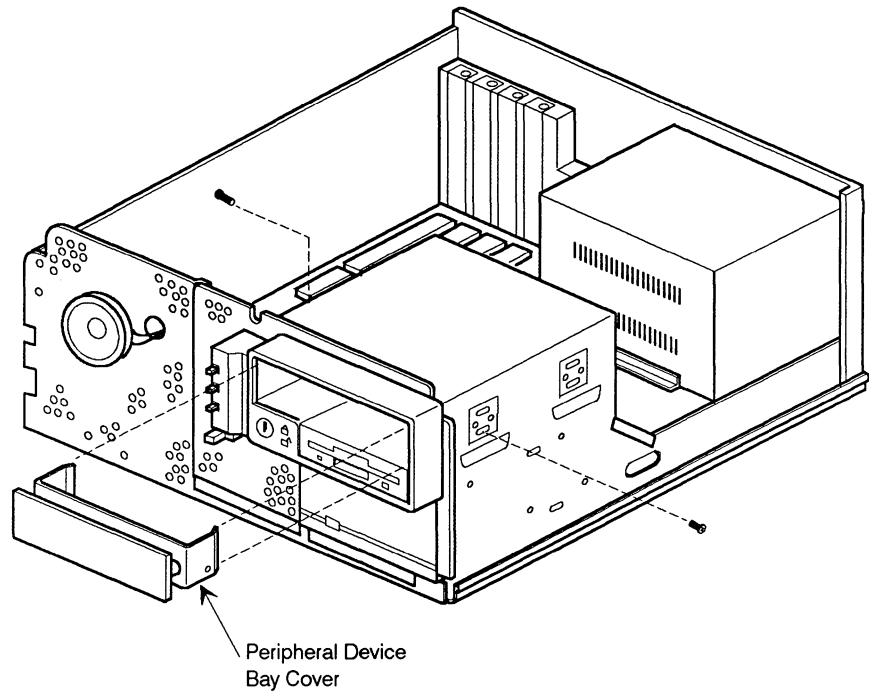

OM-00084

---

**Figure 2-9. Removing a Peripheral Device Bay Cover**

- 4 Secure the drive by inserting the screws provided with the installation kit through the four holes on the side of the top peripheral device bay (see Figure 2-10). Tighten the screws.
- 5 Ground the drive chassis by attaching one of the spare ground wires from the grounding point (on the right side of the peripheral subassembly) to the ground standoff on the drive (if applicable).

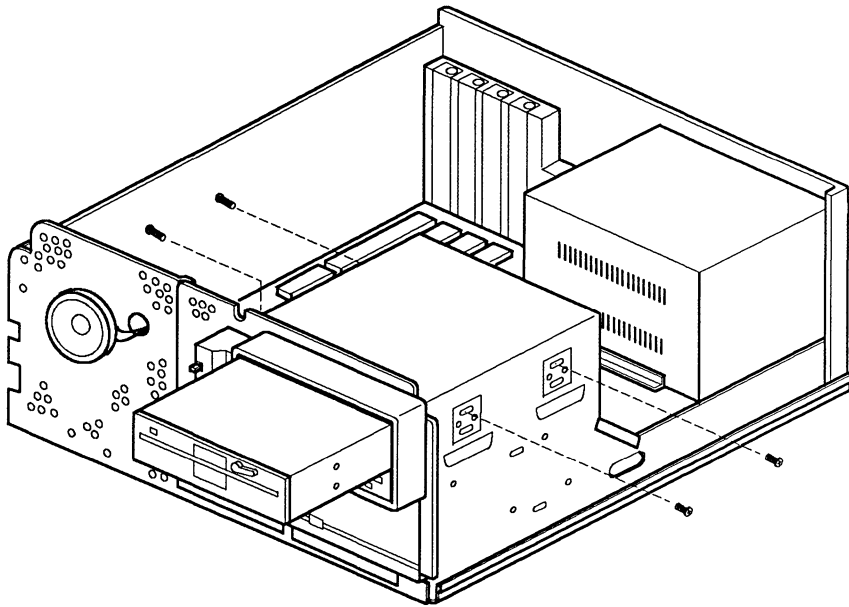

OM-00085

---

**Figure 2-10. Installing a 5.25-inch Floppy Disk Drive**

- 6 Plug in one of the spare power supply connectors (PS3 - PS5) into the mating power connector at the rear of the drive (see Figure 2-11).
- 7 Attach the top connector of the ribbon cable from connector J18 on the system board to the connector at the rear of the drive (see Figure 2-11). Make sure the connector seats properly and the pin orientation is correct.

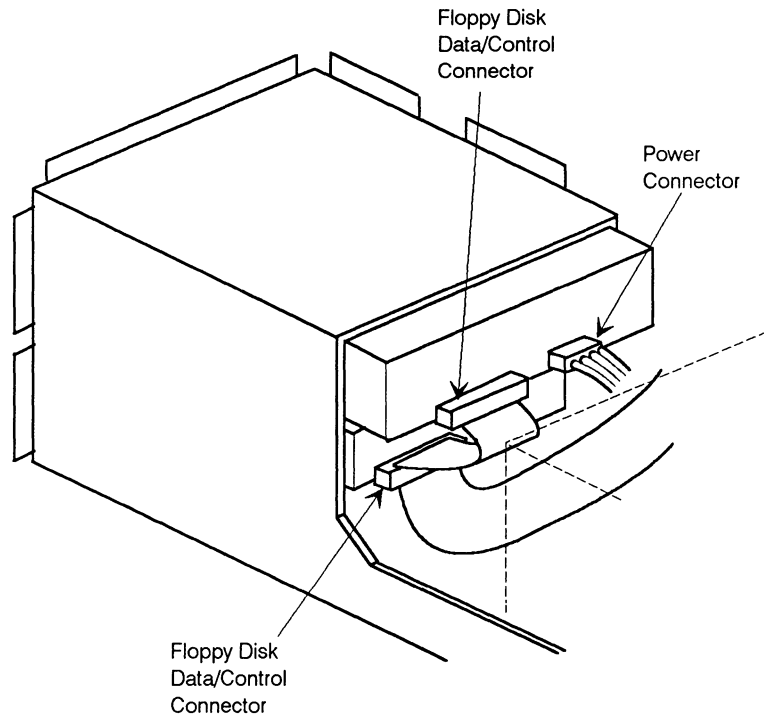

OM-00086

---

**Figure 2-11. 5.25-inch Floppy Disk Drive Connections**



## REMOVING A 5.25-INCH FLOPPY DISK DRIVE

- 1 Remove the cover as explained in section 2.4.1.
- 2 Remove all cables and connectors from the floppy disk drive and tag them for identification (see Figure 2-11).
- 3 Remove the four screws that secure the floppy disk drive to the peripheral device bay.
- 4 Carefully slide the floppy disk drive out of the peripheral device bay.
- 5 If a replacement drive is to be installed, refer to the previous section.
- 6 Reinstall the peripheral device bay cover.
- 7 Reinstall the chassis top cover and reconnect the external system cables as detailed in section 2.4.2.
- 8 Run the setup program if the removed drive was not replaced or if the replacement drive is a different type.

### 2.6.2 Installing and Removing 3.5-inch Mass Storage Peripherals

The installation and removal procedures for 3.5-inch floppy disk drives and 3.5-inch fixed disk drives are virtually identical. The main difference is that 3.5-inch drive floppy disk drives are installed in the middle peripheral device bay while 3.5-inch fixed disk drives are installed in the bottom peripheral device bay. The following sections describe how to install and remove a 3.5-inch fixed disk drive.

### INSTALLING A 3.5-INCH FIXED DISK DRIVE

- 1 Remove the cover as described in section 2.4.1.
- 2 Remove the peripheral bay bezel by pressing inward on the three retaining tabs and pulling the bezel toward you (see Figure 2-12).
- 3 Insert the fixed disk drive into the peripheral subassembly and line the drive up with the four mounting screw holes (see Figure 2-13).
- 4 Secure the fixed disk drive to the peripheral subassembly using the four mounting screws provided with the installation kit.

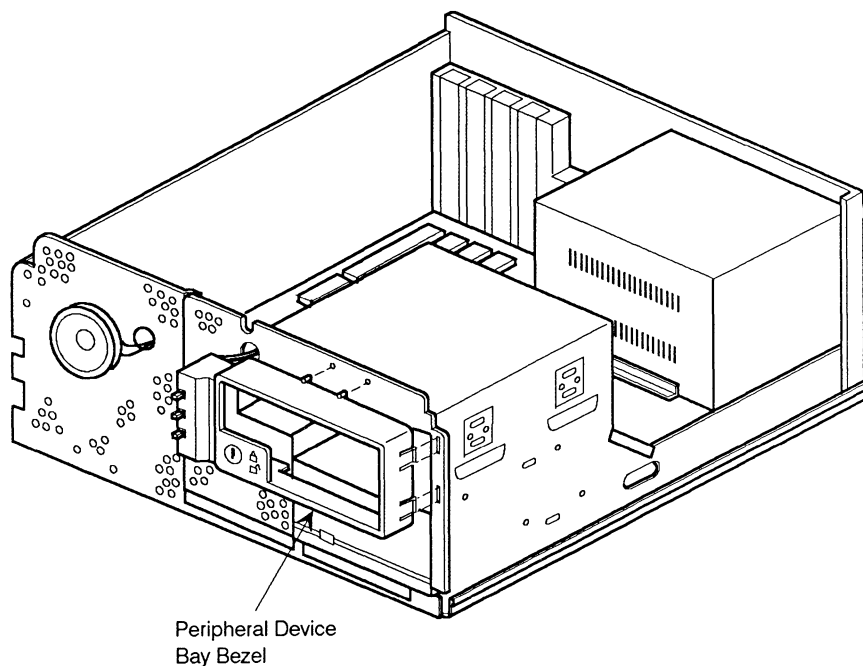

OM-00083

---

**Figure 2-12. Removing the Peripheral Bay Bezel**

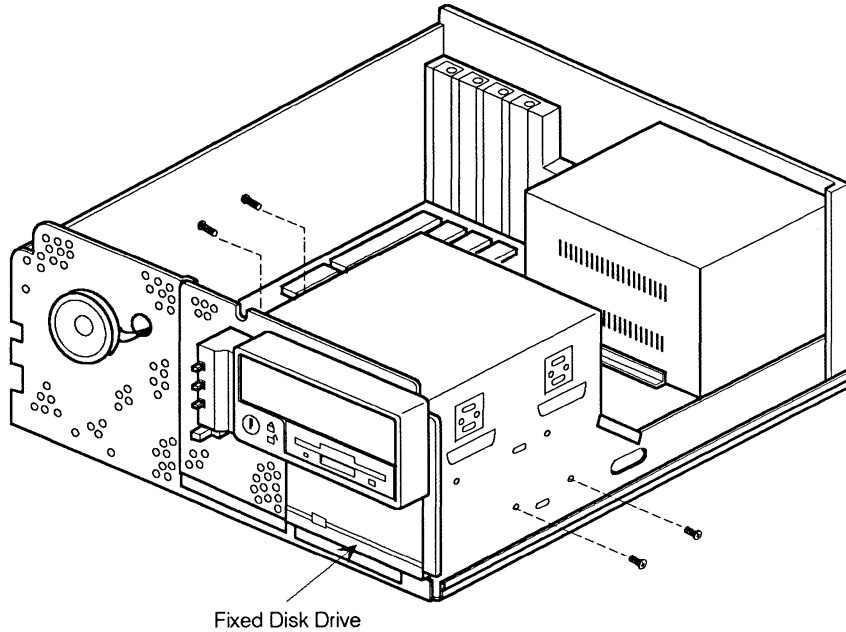

OM-00087

---

**Figure 2-13. Installing a Fixed Disk Drive**

- 5 Install all fixed disk drive cables and connectors (see Figure 2-14).
- 6 Reinstall the bezel.
- 7 Reinstall the cover and reconnect the external system cables as detailed in section 2.4.2.
- 8 Run the setup program if the installed fixed disk drive is an addition to the system or if it replaces a different type of drive.

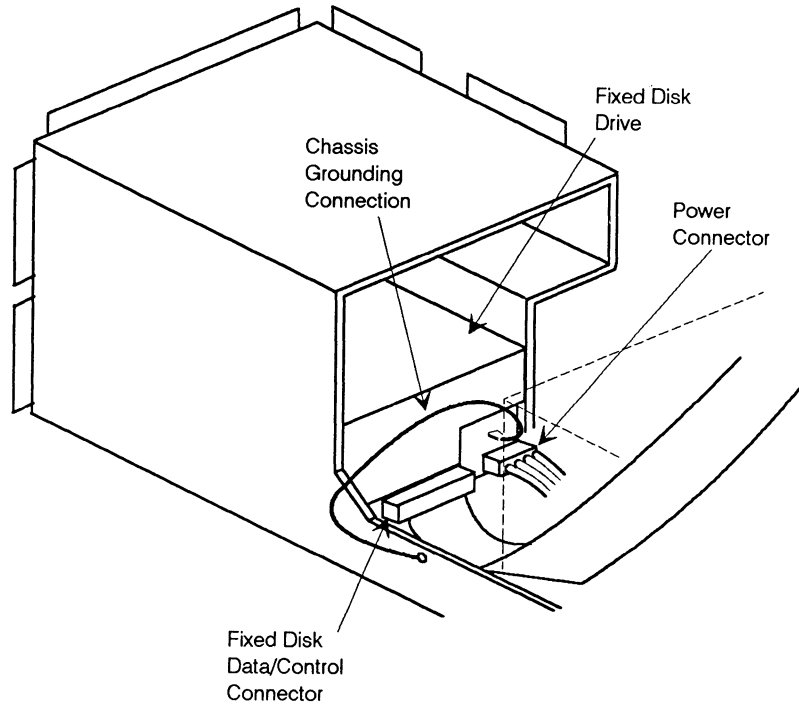

OM-00088

---

**Figure 2-14. Fixed Disk Drive Connections**

## REMOVING A 3.5-INCH FIXED DISK DRIVE

- 1 Remove the cover as explained in section 2.4.1.
- 2 Remove the bezel as described in section 2.6.2.
- 3 Remove all cables and connectors from the fixed disk drive and tag them for identification (see Figure 2-14).
- 4 Remove the four mounting screws that secure the fixed disk drive to the peripheral subassembly (see Figure 2-13).
- 5 Carefully slide the fixed disk drive out of the peripheral subassembly.
- 6 If a replacement fixed disk drive is to be installed, refer to the previous section.
- 7 Reinstall the bezel.
- 8 Reinstall the cover and reconnect the external system cables as detailed in section 2.4.2.
- 9 Run the setup program if the removed fixed disk drive was not replaced or if the replacement fixed disk drive is a different type.

## 2.7 ADDING ONBOARD RAM

### 2.7.1 Installing SIMMs

Installing SIMMs requires inserting two modules each in sockets U23 and U24. For each socket, insert the first SIMM into the left-hand slot and the second SIMM into the right-hand slot. To install SIMMs, perform the following:

 **CAUTION**

Do not touch any electronic component unless you are properly grounded. Proper grounding can be established by wearing a grounded wrist strap or touching an exposed metal part of the system module chassis. A static discharge from your fingers can result in permanent damage to the electronic component.

 **CAUTION**

Use extreme care when installing or removing SIMMs. The plastic retaining clips on the sockets are easily broken by using too much force.

- 1 Holding the SIMMs only by the edges, remove them from their antistatic package.
- 2 Position the SIMM correctly (see Figure 2-15) and insert the bottom edge into the socket slot, beginning with the empty slot farthest to the left. Press down firmly while maintaining the angle of insertion.
- 3 Make sure the SIMM seats correctly. If not, gently spread the retaining clips just enough to permit the top edge of the SIMM to be pulled away from the clips and reseal the SIMM.
- 4 When the SIMM seats correctly, hold it at each end, and gently push the top edge toward the slot retaining clips until it snaps into place.
- 5 Repeat steps one through four and install the remaining SIMMs into the socket slots, working from left to right.

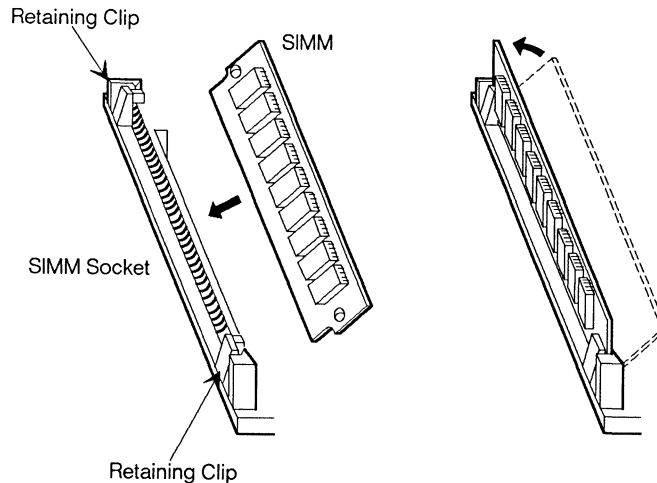

OM-00261

**Figure 2-15. Installing SIMMs**

## 2.7.2 Removing SIMMs

Use the following procedures to remove SIMMs from the system board.

When removing SIMMs, remove them one at a time from right to left. That is, remove the right-hand SIMM first, and the left-hand SIMM last.



### CAUTION

Apply only enough pressure on the retaining clips to release the module. Too much pressure can break the clips or damage the socket slot.



### CAUTION

Do not touch any electronic component unless you are properly grounded. Proper grounding can be established by wearing a grounded wrist strap or touching an exposed metal part of the system module chassis. A static discharge from your fingers can result in permanent damage to the electronic component.

To remove a SIMM:

- 1 Locate the SIMM in the right-hand slot of the right-most socket of the group to be removed (see Figure 2-16).
- 2 Gently spread the retaining clips just enough to pull the top edge of the SIMM away from the retaining clips.
- 3 Carefully lift the SIMM away from the socket and store it in a suitable static-free protective wrapper.
- 4 Repeat steps 2 and 3, as necessary, to remove and store SIMMs from the remaining sockets.

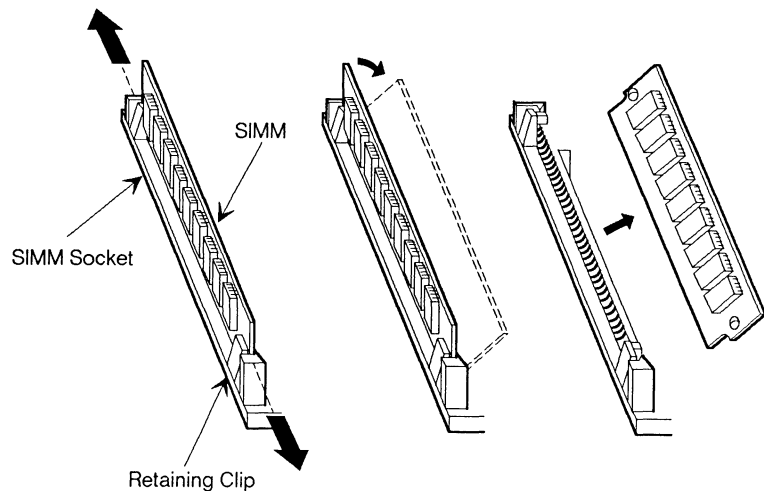

OM-00262

---

**Figure 2-16. Removing SIMMs**



## 2.8 INSTALLING AND REMOVING A NUMERIC COPROCESSOR



### CAUTION

Do not touch any electronic component unless you are properly grounded. Proper grounding can be established by wearing a grounded wrist strap or touching an exposed metal part of the system module chassis. A static discharge from your fingers can result in permanent damage to the electronic component.



### Note

Refer to the *387SX Installation Guide*™, included with your 387SX™ numeric coprocessor, for complete installation instructions.

### 2.8.1 Installing a Numeric Coprocessor



### CAUTION

To avoid damaging the numeric coprocessor, make sure the circled indentation on the chip is positioned at the top left of the socket looking from the front of the board to the back.

The numeric coprocessor plugs directly into the socket on the board. Follow these steps to install the numeric coprocessor:

- 1 Remove the numeric coprocessor from its antistatic package, being careful not to touch the pins on the chip.
- 2 Align the numeric coprocessor's pins with the socket contacts.
- 3 Position the numeric coprocessor's pins in the socket receptacles. Press the chip down firmly until it seats (see Figure 2-17). Be careful not to bend the pins.

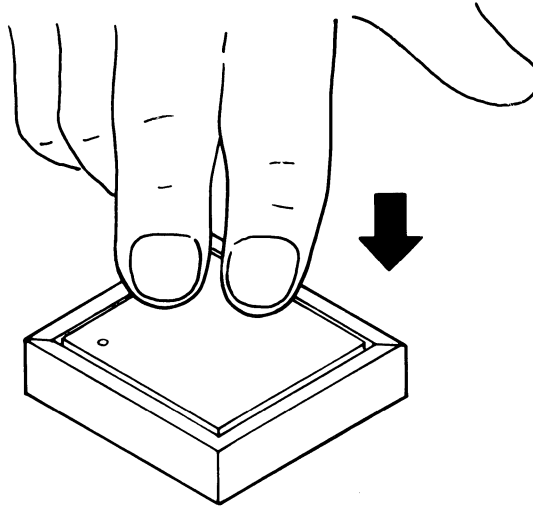

OM-00159

---

**Figure 2-17. Installing a Numeric Coprocessor**

## 2.8.2 Removing a Numeric Coprocessor

Use the following procedure to remove the numeric coprocessor from the system board:

- 1 Remove the numeric coprocessor from its socket on the board using a 68-pin grid array device extraction tool. Be careful not to touch the device pins.
- 2 Place the numeric coprocessor in an antistatic container to protect the device from static electricity.

## 2.9 SETTING THE SYSTEM BOARD JUMPERS

System board jumpers provide specific system configuration information. Setting a system board jumper requires placement of a shorting plug over two adjacent pins to connect them electrically (see Figure 2-18). Each pin is labeled on the system board by the letter E and a number. For example, E2.

Make sure the jumper settings match the default settings given in the following sections, unless a particular option requires modification of the default settings.

---

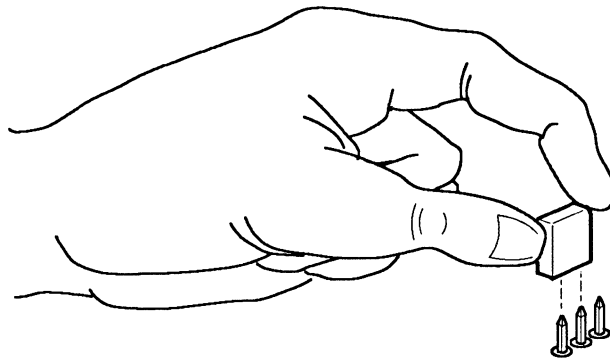

OM-00108

---

**Figure 2-18. Installing a Shorting Plug**

## 2.9.1 Changing System Board Jumper Settings



### **WARNING**

Unplug the system before performing the following procedure. Failure to disconnect power before opening the system module can result in personal injury or equipment damage.



### **CAUTION**

Do not touch any electronic component unless you are properly grounded. Proper grounding can be established by wearing a grounded wrist strap or touching an exposed metal part of the system module chassis. A static discharge from your fingers can result in permanent damage to the electronic component.

To change a system board jumper setting, remove the jumper from its current location and position it over the two pins designated for the desired setting. Press the jumper down evenly onto the pins. Do not bend the pins.

Figure 2-19 shows the location of the system board jumpers.

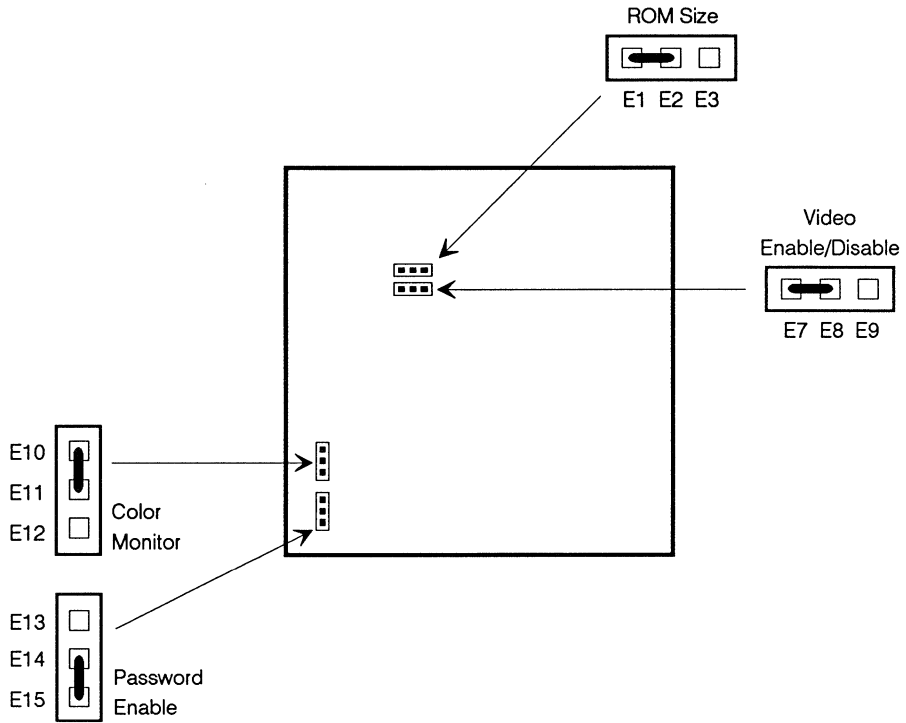

OM-00103

---

**Figure 2-19. System Board Jumper Locations**

## 2.9.2 Jumper Setting Options

Jumpers provide the following system configuration information for the system:

- Monitor type (monochrome/color)
- Password (enable/clear)
- ROM size (512Kb/256Kb)
- Video (enable/disable)

### MONITOR TYPE

The monitor type jumper allows you to indicate the type of monitor connected to the system's TTL video output connector. If the monitor is one of those listed below, the jumper must be set to monochrome monitor as indicated in Table 2-1:

- Princeton Graphics MAX-12
- Amdek 310A
- IBM 5151

If you are connecting any other video display, the jumper should be set to color. If the TTL connector is not used, the jumper should be set to color.

**Table 2-1. Color/Monochrome Monitor Jumpers**

<b>Video Monitor Type</b>	<b>Jumper Pin Setting</b>
Color	E10 to E11 *
Monochrome	E11 to E12

\* Default setting

### PASSWORD ENABLE/CLEAR

This jumper enables or clears the password function. If the password is enabled, a password may be entered into the board ROM using the setup program.

To clear the system password, first turn off the system and remove its cover. Place the password jumper in the CLEAR position. Replace the system cover and boot the system. The password will be cleared as soon as POST completes.

To re-enable the password function, turn off the system and remove its cover. Place the password jumper in the password ENABLE position. Replace the cover.

The jumper settings are listed in Table 2-2.

**Table 2-2. Password Enable/Clear Jumpers**

<b>Option</b>	<b>Jumper Pin Setting</b>
Enable Clear	E13 to E14 E14 to E15*

\* Default setting

### ROM SIZE

If the onboard video subsystem is being used, the ROM size jumper must be set to 512 to indicate 512Kb devices. If the onboard video subsystem is disabled, the ROM size jumper should be set to 256Kb devices to disable the onboard video BIOS. The jumper settings are shown in Table 2-3.

**Table 2-3. ROM Size Jumpers**

Option	Jumper Pin Setting
512Kb devices 256Kb devices	E1 to E2* E2 to E3

\* Default setting

### VIDEO ENABLE/DISABLE

If an offboard video controller is installed in one of the expansion slots, the onboard video controller must be disabled to prevent a conflict between the two controllers. The jumper settings are listed in Table 2-4.

**Table 2-4. Video Enable/Disable Jumpers**

Option	Jumper Pin Setting
Onboard video enabled Onboard video disabled	E7 to E8* E8 to E9

\* Default setting

 **Note**

To completely disable the onboard video circuitry, the ROM size jumper should be set to 256Kb devices if you disable onboard video.

## 2.10 CONNECTING EXTERNAL PERIPHERAL DEVICES

Install all optional system components and replace the system module cover before connecting the monitor, keyboard, and other peripherals. (Refer to section 2.3 for instructions on installing optional system components.)





**CAUTION**

Do not connect or remove I/O devices or cables from the system module when the power cable is connected to an AC source. Connecting or disconnecting I/O cables while the power cable is connected can damage the system module or I/O devices.



**Note**

If your system normally operates without a monitor or keyboard (for example as a network server), you must temporarily install a monitor and keyboard to perform the setup procedure. You may remove both after running the setup program. Refer to Chapter 3, "System Configuration."

### 2.10.1 Connecting a Monitor

Connect a monitor as follows:

- 1 Connect the monitor cable between either of the monitor connectors (TTL or analog) on the system module and the monitor. Refer to the monitor manual for connection details.
- 2 Connect the monitor power cord from the power connector on the monitor and to the switched peripheral power outlet on the system module. This outlet is controlled by the system module power switch. This feature lets you turn on the system module and monitor with a single switch.
- 3 Tighten screws on all connections.

### 2.10.2 Connecting a Keyboard

Connect a keyboard by inserting the keyboard cable connector into the socket at the rear of the system module. Make sure the keyway on the keyboard cable connector faces up.

### 2.10.3 Connecting a Mouse

Connect a mouse by inserting the mouse cable connector into the socket at the rear of the system module.

### 2.10.4 Connecting Other Peripherals

Connect other external peripheral devices such as a printer or modem by following the instructions included with the peripheral device.

## 2.11 CONNECTING THE SYSTEM TO A POWER OUTLET

The standard power cord supplied with the system is detachable and plugs into the input power connector at the rear of the chassis. The input end terminates in a standard three-prong plug for 115VAC operation.

#### Note

It is recommended that a surge protection device be placed between the system input power connector and the 115VAC outlet.

## 2.12 SETTING THE LINE VOLTAGE SELECT SWITCH

#### CAUTION

If the line voltage select switch is not set correctly, severe damage to the system can result.

If you are connecting your system to a 230VAC power outlet, you must ensure that the line voltage select switch is correctly set. See Figure 2-20 for switch details.

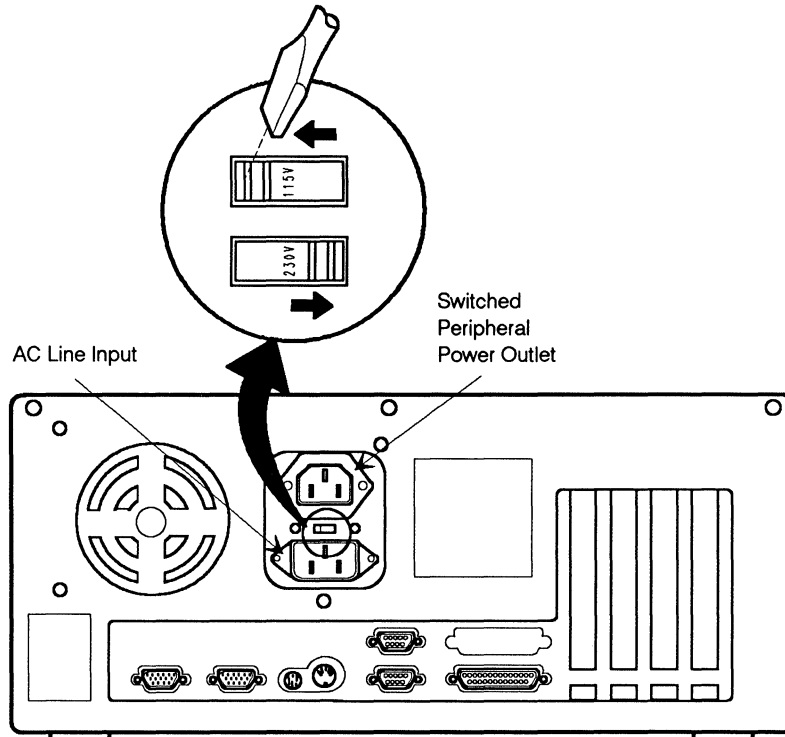

0M-00081-4

**Figure 2-20. Setting the Line Voltage Select Switch**

If you are changing AC input power sources, you must be sure to use the correct power cord. A standard 115VAC power cord is supplied with the system. If 230VAC input power is to be used, a suitable power cord and connector (not supplied) must be used.



**WARNING**

Do not attempt to modify or use the external 115VAC power cord for 230VAC input power.

Use the following procedure to connect the system to a power outlet:

- 1 Make sure the power switch is in the off position and the voltage select switch is in the proper position.
- 2 Connect the female end of the power cord to the connector at the rear of the system module.
- 3 Connect the male end of the power cord to an AC power source.

### 2.13 STARTING THE SYSTEM

Start the system by performing the following:

- 1 Remove the drive protection card (if present) from the floppy disk drive.
- 2 Turn on the monitor. (Refer to the monitor manual for instructions.)
- 3 Depress the system module power switch to the on position.
- 4 Adjust the monitor to obtain a readable screen display. (Refer to the monitor manual for instructions.)



#### Note

If you are unable to obtain a readable screen display, the monitor type option may be set incorrectly. Hold down the **Ctrl** and **Alt** keys and press **4** on the numeric keypad to force the default video monitor type to VGA. Reboot the system. If there are still no characters on the screen, contact your dealer for assistance.

### 2.14 POWER-ON SELF TEST (POST)

Each time the system is turned on or reset, the power-on self test (POST) runs automatically and checks the CPU, keyboard, monitor, memory, and most installed peripheral devices.

During the POST memory test, the amount of memory being tested is displayed on the screen. Depending on the amount of extended memory installed, the POST memory test takes 3 to 15 seconds to complete. During a soft boot (**Ctrl** + **Alt** + **Del**), the system executes all POST tests except memory.

**⇒ Note**

If the system halts before completing the entire POST routine, a fatal system error has occurred requiring immediate attention. Note the screen display and write down the beep code emitted (if any). Contact your dealer for assistance.

When POST is complete the system beeps once, if no configuration errors are detected, and displays a message similar to the following:

```
Phoenix 80386 ROM BIOS PLUS Version x.xx yy F0B  
Copyright (c) 1985-1989 Phoenix Technologies Ltd.  
All Rights Reserved
```

```
640K Base Memory, 01024K Extended
```

If configuration errors are detected, the system beeps twice and displays the following message:

```
Invalid configuration information -  
  please run the SETUP program  
  Strike the F1 key to continue, F2 to run the setup utility
```

**⇒ Note**

It is normal for this message to appear the first time you start the system.

If you press **F1** to continue, the system will operate correctly, but not at full potential.

Refer to Chapter 3 for a description of the setup program.

Once the 300SX System has been installed (refer to Chapter 2), the setup program can be run. This chapter describes the setup program. Once the setup program has been correctly run, the system is ready for use (refer to Chapter 4).

### **3.1 SETUP PROGRAM**

Included in the system board ROM BIOS is a setup program that stores system configuration information. This information takes effect when the system is rebooted. The setup program stores system configuration settings in the battery-backed CMOS RAM. You can change system settings at any time by running the setup program. The stored information includes the following:

- Date and time
- Number and capacity of floppy disk drives
- Number and type of fixed disk drives
- Amount of base memory
- Amount of extended memory
- Availability and type of primary video display controller
- Availability of keyboard
- CPU effective speed

- Availability of numeric coprocessor
- Shadow or do not shadow the system BIOS and video BIOS
- Shadow or do not shadow the offboard video BIOS
- Enable/Disable onboard peripherals
- Enable/Disable COM1, COM2, LPT1, and LPT2
- Set the power-on password
- Enable/disable console redirection
- Enable/disable rolled memory

When the system boots, the POST checks the stored information against the hardware configuration. If the data does not agree, the POST displays an invalid configuration message. If such a message appears, you can run the setup program to enter the correct configuration parameters.

The setup program performs the following operations:

- Displays date, time, and current values for system options.
- Allows you to accept current (default) values or enter different values for time, date, and system options.
- Provides instructions on booting the system so new settings take effect.

### 3.2 RUNNING THE SETUP PROGRAM

The setup program is permanently stored in ROM, and can be run with or without an operating system present.

To run the setup program, wait for POST to complete (you'll hear a short beep), then immediately press **Ctrl** + **Alt** + **Ins**.

## System Configuration

---

The setup program starts by displaying a screen similar to that shown in Figure 3-1. The screen shows the current settings for the system. Because it reflects the exact configuration of your system, the actual display may not match this example.

---

System Configuration Setup Version x.xx xx

Time: 08:20:20

Date: Mon Jul 10, 1989

Diskette A: 3.5 Inch, 1.44 MB

Diskette B: Not Installed

Hard Disk 1: Type 33

Cyl	Hd	Pre	LZ	Sec	Size(MB)
965	5	-1	1	17	40

Hard Disk 2: Not Installed

Base Memory: 640 KB

Extended Memory: 1024 KB

Display: VGA/EGA

Keyboard: Installed

CPU Speed: Turbo

Coprocessor: Not Installed

PgDn for advanced options. Up/Down Arrow to select. Left/Right Arrow to change.  
F10 to exit and save changes. Esc to reboot for changes to take effect.

---

**Figure 3-1. Setup Screen 1**



To change options, use the **↑** or **↓** key to move the cursor to a selected option. (The cursor moves only to the options that can be changed.) Change the selected option by pressing the **←** or **→** key. Each time you press one of these keys, the setup program displays one of the possible values for the selected option. You cannot set the base memory, extended memory, or disk parameters using the **←** or **→** key. Instead, you must enter the numeric values using the number keys at the top of the keyboard. If you enter an incorrect number, you can correct the entry by using the **Backspace** key. The fixed disk parameter table can be displayed by selecting "Hard Disk 1" or "Hard Disk 2" and pressing the **F1** key.

The screen shown in Figure 3-1 is the first of three screens displaying the current settings for the system. Press the **Page Down** key to view the second setup screen.



When you finish setting options, exit the setup program by pressing the **F10** key or the **Esc** key. You can exit Setup from either screen.

Press **F10** to exit the setup program without booting the system. Changes are saved, but only the date and time information take effect. The other changes take effect when the system boots. Press the **Esc** key to save the setup changes and boot the system.











### 3.2.1 Moving Through Setup Screen 1

Make sure the first setup screen is displayed (refer to Figure 3-1). If it is not, press the **Page Up** key.



### SETTING SYSTEM TIME

If the time is incorrect, use the  or  key to move the cursor to the time option fields on the setup screen.

**Time:**                    08:20:20





The time option contains three fields: hours, minutes, and seconds. Set the hours and minutes fields using the  or  key. Pressing the gray  key moves the clock forward. Pressing the gray  key moves the clock backward. Holding down the  or  key causes the value to increase or decrease continuously. Set the hour field first and then press the  key to move to the minutes field. Set the minutes field using the  or  key. Reset the seconds field to 00 by selecting this field and pressing either the  or  key.

### SETTING SYSTEM DATE

If the date is incorrect, use the  or  key to move the cursor to the date option fields on the setup screen.

**Date:**                    Tue May 23, 1989

The date option contains four fields: day of the week, month, day of the month, and year. You can set all fields except the day of the week. When any of the other three fields are changed, the setup program automatically resets the day of the week accordingly.

Increase or decrease the date fields using the  or  key. When one field is set, press the  or  key to move to a different field.

## SETTING FLOPPY DISK DRIVE TYPES

The setup program maintains information about two floppy disk drives (drive A and drive B). If the information about either of these floppy disk drives is incorrect, use the **F1** or **F2** keys to move the cursor to the appropriate field.

Diskette A: 3.5 Inch, 1.44 MB  
Diskette B: Not Installed

Change the floppy disk options by pressing the **←** or **→** keys. The allowable floppy disk options are as follows:

3.5 Inch, 1.44 MB  
3.5 Inch, 720 KB  
5.25 Inch, 1.2 MB  
5.25 Inch, 360 KB  
Not Installed

If only one floppy disk drive is installed, it is always drive A. Set drive B to Not Installed. You cannot change the individual fields within the options.

## SETTING FIXED DISK DRIVE TYPES

The setup program maintains drive type information for two fixed disk drives (drive 1 and drive 2).

Hard Disk 1: Type 33  
Hard Disk 2: Not Installed

If the drive type for either of these disks is incorrect, use the **F1** or **F2** key to move the cursor to the appropriate field.

If you know the drive type associated with the fixed disk, press the **←** or **→** key until the drive type appears on the screen.

The fixed disk parameter table can be displayed by selecting "Hard Disk 1" or "Hard Disk 2" and pressing the **F1** key. Compare this list with the specifications of your disk drive to determine the correct drive type.



### CAUTION

It is essential to specify the correct fixed disk drive type because the setup program cannot independently verify this information. Specifying an incorrect drive type may damage the disk.

If the list does not include the drive type in the system, choose the user-configurable disk type. Set the number of cylinders, number of heads, and disk capacity parameters to match the specifications of the fixed disk.



If only one fixed disk drive is installed, it is always drive 1.

### SETTING EXTENDED MEMORY



Extended memory is RAM above 1024K (1M). The first 1M of memory is used for base and dedicated RAM. To compute extended memory, this amount must be subtracted from the total amount of onboard RAM in the system.

If the POST indicates "Invalid configuration information," when the setup program is executed, it will attempt to correct the error if it is due to an invalid memory configuration.

### SETTING VIDEO DISPLAY CONTROLLER TYPE

The type of video display controller installed in the system must be correctly specified for POST to function correctly. If the information listed on the setup screen is incorrect, use the  or  key to move the cursor to the display field.

Display:           VGA/EGA

Change the display options by pressing the  or  key.





### Note

Set the display to VGA/EGA even if another controller board is present and designated as the primary controller. This enables the POST to properly configure the onboard VGA controller.



The following video display controller selections are available:

VGA/EGA	video graphics array (VGA) or enhanced graphics adapter (EGA)
CGA40	color/graphics adapter in 40-column mode
CGA80	color/graphics adapter in 80-column mode
MONO	monochrome video display controller
Not Installed	No display attached. Use this setting to suppress errors relating to the monitor. This permits systems such as network servers to operate without monitors. If a monitor is attached, it will operate in the CGA80 mode.

### SETTING KEYBOARD AVAILABILITY

The presence or absence of a keyboard must be correctly specified for the POST to function correctly. If the information listed on the setup screen is not correct, use the  or  key to move the cursor to the display field.

Keyboard:        Installed

The keyboard option can be changed by pressing the  or  key. The following choices are available:

Installed	Keyboard attached.
Not Installed	Keyboard not present. Use this setting to prevent the POST from pausing when it detects the absence of the keyboard and reports an error. This permits systems such as network servers to operate without keyboards. If a keyboard is attached, it will operate correctly.

## SETTING CPU EFFECTIVE SPEED

The CPU effective speed setting determines the speed used by the system each time you turn on the power. If the information listed in the setup screen is not correct, use the **↑** or **↓** key to move the cursor to the display field.

CPU Speed: Turbo

Change the CPU effective speed option by pressing the **←** or **→** key. The following choices are available:

- |         |   |
|---------|---|
| Turbo   | Turbo (16 MHz) is the normal setting for the CPU effective speed.   |
| Deturbo | Deturbo (8 MHz) is used to simulate a reduced CPU speed to be compatible with some applications programs. If a program does not run correctly at 16 MHz, change the CPU effective speed to deturbo. |

### 3.2.2 Moving Through Setup Screen 2

Press the **Page Down** key. A screen display similar to the one shown in Figure 3-2 appears.

---

```
System Configuration Setup
Additional Options

Time:                                08:20:20
Date:                                Mon Jul 10, 1989

Enter Setup:                          Pre-boot
Speaker:                               Enabled
Onboard Video Display:                 Primary
Onboard Video Controller:              VGA
Monochrome Startup Mode                 Color Mode (3+)
Video Timing Register Lock:            Normal
Monitor Type                           VGA Display
Onboard Video BIOS Mapping:            To E0000H
Onboard Peripherals:                   Onboard floppy &
                                         winchester enabled

Password:                              Not Installed. Depress
                                         <cr> to enter

Parallel Port:                          LPT1
Serial Port 1:                           COM1
Serial Port 2:                           COM2
Console Redirection to COM1:            Disabled COM2: 9600 Baud
```

PgUp for main menu and PgDn for additional options. Up/Down Arrow to select. Left/Right Arrow to change. F10 to exit and save changes. Esc to reboot for changes to take effect.

---

**Figure 3-2. Setup Screen 2**

These options are preset to the recommended choice. In most cases they need not be changed.

### ENTER SETUP

Two options are available in the Enter Setup selection. You can always enter the setup program (from the DOS prompt) or from a pre-boot. Set either option using the  or  key to move the cursor to the display field.

Enter Setup:    Pre-boot

Change the option by pressing the  or  key.

### SPEAKER

To enable or disable the speaker, use the  or  key to move the cursor to the display field.

Speaker:        Enabled

Change the option by pressing the  or  key.

### ONBOARD VIDEO DISPLAY CONTROLLER

You can use the two available options to set the onboard video display controller to either the primary or secondary controller. To change the onboard video display controller option, use the  or  key to move the cursor to the display field.

Onboard Video Display:    Primary

Change the option by pressing the  or  key.





## ONBOARD VIDEO CONTROLLER

The onboard video controller selection is used to set up the onboard video display controller. The following onboard video display controller options are available:

Auto	Automatic mode. In this mode the setup program attempts to configure automatically.
CGA	Color/graphics adapter mode
MGA	Monochrome/graphics adapter mode
EGA	Enhanced graphics array mode
VGA	Video graphics array mode

Change the option by pressing the  or  key.



## MONOCHROME MONITOR STARTUP MODE

This selection allows you to set the startup mode for a VGA monochrome monitor to monochrome or color (displayed as 64 shades of gray). To change the monochrome monitor startup mode option, use the  or  key to move the cursor to the display field.

Monochrome Startup Mode: Color Mode (3+)

Change the option by pressing the  or  key.

## VIDEO TIMING REGISTER LOCK

This selection has two options: Normal and Protected. Normal allows programs to write data to the timing registers of the CRT controller while Protected inhibits programs from writing to the CRT controller registers. To change the video timing register lock option, use the  or  key to move the cursor to the display field.



Video Timing Register Lock: Normal

Change the option by pressing the  or  key.

## MONITOR TYPE

This selection allows you to choose from the following five video monitor types:

- VGA
- Analog multi-frequency
- Monochrome
- Color display
- EGA color display

To change the monitor type option, use the  or  key to move the cursor to the display field.

Monitor Type: VGA

Change the option by pressing the  or  key.

Table 3-1 summarizes the various video controller and monitor options and describes their effect on the video displayed.

**Table 3-1. Video Options Summary**

<b>Display Setting</b>	<b>Monitor Type Setting</b>	<b>Onboard Video Controller Setting</b>	<b>Active Video Port</b>	<b>Video Monitor Action</b>
Not installed	Don't care	Don't care		POST fails.
Mono	Don't care	Don't care		POST fails.
CGA80	Don't care	Don't care		POST fails.
CGA40	Don't care	Don't care		POST fails.
VGA/EGA	Monochrome	Auto	Digital	Functions as an MGA monitor.
VGA/EGA	Monochrome	MGA	Digital	Functions as an MGA monitor.
VGA/EGA	Monochrome	CGA	Digital	Functions as an MGA monitor.
VGA/EGA	Monochrome	EGA	Digital	Functions as an MGA monitor.
VGA/EGA	Monochrome	VGA	Digital	Functions as an MGA monitor.
VGA/EGA	Color display	Auto	Digital	Functions as a CGA or MGA monitor.
VGA/EGA	Color display	MGA	Digital	Functions as an MGA monitor.
VGA/EGA	Color display	CGA	Digital	Functions as a CGA monitor.



**Table 3-1. Video Options Summary (continued)**

<b>Display Setting</b>	<b>Monitor Type Setting</b>	<b>Onboard Video Controller Setting</b>	<b>Active Video Port</b>	<b>Video Monitor Action</b>
VGA/EGA	Color display	EGA	Digital	Functions as a CGA monitor.
VGA/EGA	Color display	VGA	Digital	Functions as a CGA monitor.
VGA/EGA	EGA color display	Auto	Digital	Functions as EGA, CGA, or MGA monitor depending on video mode.
VGA/EGA	EGA color display	MGA	Digital	Functions as an MGA monitor.
VGA/EGA	EGA color display	CGA	Digital	Functions as a CGA monitor.
VGA/EGA	EGA color display	EGA	Digital	Functions as an EGA monitor.
VGA/EGA	EGA color display	VGA	Digital	Functions as an EGA monitor.
VGA/EGA	VGA	Auto	Analog	Functions as a VGA, EGA, CGA, or MGA monitor depending on video mode.
VGA/EGA	VGA	MGA	Analog	Functions as an MGA monitor.
VGA/EGA	VGA	CGA	Analog	Functions as a CGA monitor.

**Table 3-1. Video Options Summary (continued)**

Display Setting	Monitor Type Setting	Onboard Video Controller Setting	Active Video Port	Video Monitor Action
VGA/EGA	VGA	EGA	Analog	Functions as an EGA monitor.
VGA/EGA	VGA	VGA	Analog	Functions as a VGA monitor.
VGA/EGA	Analog multi-frequency	Auto	Analog	Functions as a VGA, EGA, CGA, or MGA monitor depending on the video mode.
VGA/EGA	Analog multi-frequency	MGA	Analog	Functions as an MGA monitor.
VGA/EGA	Analog multi-frequency	CGA	Analog	Functions as a CGA monitor.
VGA/EGA	Analog multi-frequency	EGA	Analog	Functions as an EGA monitor.
VGA/EGA	Analog multi-frequency	VGA	Analog	Functions as a VGA monitor.



## ONBOARD VIDEO BIOS MAPPING



The video BIOS is normally mapped to memory location E0000H, however, some application programs require the video BIOS to be located at C0000H also. To change the onboard video BIOS mapping option, use the  or  key to move the cursor to the display field.

Onboard Video BIOS Mapping:      To E0000H

Change the option by pressing the  or  key.



### ONBOARD PERIPHERALS

To enable or disable the onboard peripherals option, use the  or  key to move the cursor to the display field.

**Onboard Peripherals:** On-board floppy and winchester enabled  
Change the option by pressing the  or  key.



### PASSWORD

Set the system password by performing the following:

1. Use the  or  key to highlight the display field.
2. Follow on-screen procedures.

After validation, the setup program stores the password in CMOS RAM.



### PARALLEL PORT

Three options are available in the parallel port selection: LPT1, LPT2, and Disabled. To change the parallel port option, use the  or  key to move the cursor to the display field.

**Parallel Port:** LPT1

Change the option by pressing the  or  key.



### SERIAL PORT 1

Three options are available in the serial port 1 selection: COM1, COM2, and Disabled. To change the serial port 1 option, use the  or  key to move the cursor to the display field.

**Serial Port 1:** COM1

Change the option by pressing the  or  key.

## SERIAL PORT 2

Three options are available in the serial port 2 selection: COM1, COM2, and Disabled. To change the serial port 2 option, use the  or  key to move the cursor to the display field.



Serial Port 2: COM2

Change the option by pressing the  or  key.

### Note

Setup allows serial port 2 to be set to the same value as serial port 1. However, the POST will automatically change the serial port 2 setting to the opposite setting when the system is rebooted.

## CONSOLE REDIRECTION TO COM1

Three options are available in the console redirection to COM1 selection. You can set COM1 at 9600 baud, 1200 baud, or disable COM1. You can also set COM2 using the same options. You can set any of the three options using the  or  key to move the cursor to the display field.

Console Redirect. to COM1: Disabled COM2:9600 Baud

Change the option by pressing the  or  key.

### 3.2.3 Moving Through Setup Screen 3

Press the **Page Down** key. A screen display similar to the one shown in Figure 3-3 appears.

---

System Configuration Setup  
Additional Options

Time: 08:20:20  
Date: Mon Jul 10, 1989

Shadow BIOS ROM: System and on-board Video BIOS  
Base Memory Above 512K: Enabled  
Offboard Video Shadow: Disabled  
Memory Roll: Enabled

PgUp for main menu and PgDn for additional options. Up/Down Arrow to select.  
Left/Right Arrow to change. F10 to exit and save changes. Esc to reboot for changes to take effect.

---

**Figure 3-3. Setup Screen 3**

These options are preset to the recommended choice. In most cases they need not be changed.

### SHADOWING SYSTEM BIOS AND VIDEO BIOS

The system board reserves an area of RAM for a copy of the system BIOS and video BIOS. This memory, called shadow memory, is write-protected and has the same addresses as the ROM locations. If you select the shadow option, the system copies the system BIOS and the video BIOS to this area and disables the ROM. System I/O performance increases significantly, because the information is maintained in fast RAM instead of ROM.



Setup screen 3 presents the shadow BIOS ROM option. It is recommended that you select the system and onboard video BIOS option.



**Shadow BIOS ROM: System and on-board video BIOS**

If the system and onboard video BIOS option is selected, the system copies both the system BIOS and video BIOS into their corresponding RAM locations on power-up. Programs then access the information from the RAM copy.

### **Note**

Some high resolution plug-in video display controllers do not work properly when video BIOS shadowing is enabled. If you have a high resolution video display controller installed and you experience monitor problems, set the shadow option to disabled.



## **BASE MEMORY ABOVE 512K**

To enable or disable the memory between 512K and 640K, use the  or  key to move the cursor to the display field.

**Base Memory Above 512K: Enabled**

Change the option by pressing the  or  key.

## **OFFBOARD VIDEO SHADOW**

To enable or disable the offboard video BIOS shadow option, use the  or  key to move the cursor to the display field.

**Offboard Video Shadow: Disabled**

### **Note**

Enabling this option shadows the offboard video BIOS from C0000H to DFFFFH, not just from C0000H to C8000H. Therefore, use this option with caution.

Change the option by pressing the  or  key.

## Operating Your System

# 4

---

This chapter provides information on how to operate the 300SX System. This chapter explains:

- The controls on the system module
- How to use the keyboard
- How to use disk drives
- How to use floppy disks

If the system does not operate as described in this chapter, follow the instructions in Chapter 5, "Solving Problems." If error messages appear on the screen, refer to Appendix B, "Error and Informational Messages" for possible causes and suggested solutions.

## 4.1 SYSTEM MODULE CONTROLS AND INDICATORS

The controls and indicators on the system module include the following (see Figure 1-2):

- Keyboard lock
- Fixed disk drive access indicator
- Reset button
- Power indicator
- Power on/off button
- Floppy disk drive access indicator
- Floppy disk release button

### 4.1.1 Keyboard Lock

The keyboard lock is located in the center of the system module front panel. The lock disables the keyboard so that commands cannot be entered into the system.

Two identical keys are shipped with the system. Be sure to record the key number and store the extra key in a safe place.

### 4.1.2 Fixed Disk Drive Access Indicator

The fixed disk drive access indicator lights (amber) when a fixed disk drive is in use.

### **4.1.3 Reset Button**

The reset button, located on the front panel, resets the system and causes POST to execute. Use the reset button to restart the system without turning the power off.

### **4.1.4 Power Indicator**

The power indicator lights (green) when the system module power is on.

### **4.1.5 Power Push Button**

The power push button, located on the front of the system module, turns the system power off or on.

### **4.1.6 Floppy Disk Drive Access Indicator**

Each floppy disk drive has an access indicator. The location of the indicator depends on the type of drive installed. The access indicator lights (amber) when the drive is in use.

### **4.1.7 Floppy Disk Release Button**

The 3.5-inch floppy disk drive has a release button. Pressing the floppy disk release button ejects the floppy disk.

## **4.2 THE KEYBOARD**

The keyboard allows you to communicate with the system by entering data or commands. The keyboard contains a microprocessor that communicates with the system module. Each time a key is pressed or released, the keyboard sends a coded message to the system module. These messages are interpreted by software running in the system module.

### 4.2.1 Keyboard Sections

Figure 4-1 illustrates the layout of the keyboard and identifies the following features:

- Escape key
- Alphanumeric key group
- Function key group
- Edit key group
- Indicator lights
- Cursor control key group
- Numeric keypad

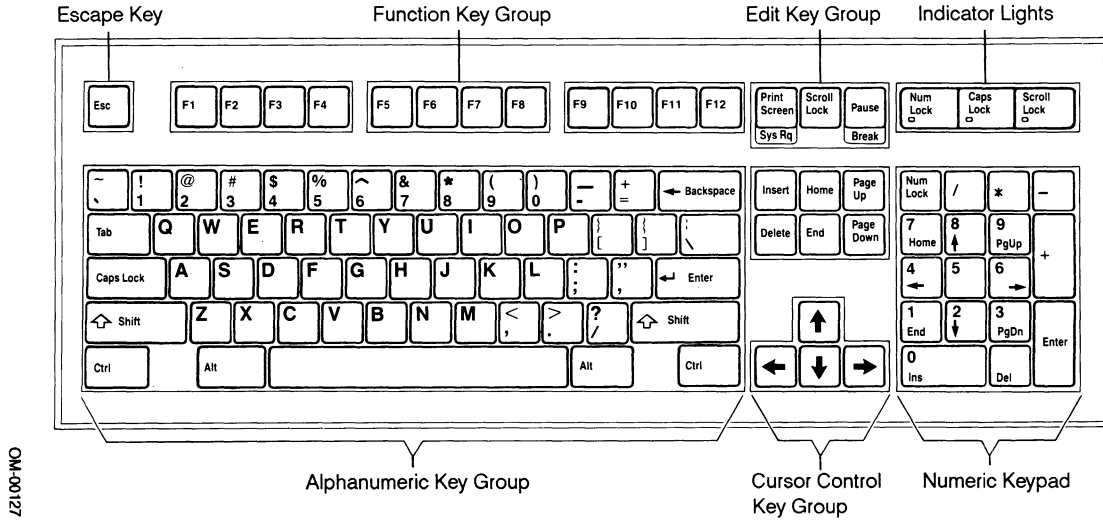

OM-00127

Figure 4-1. Keyboard Layout and Features

### ESCAPE KEY

The software or operating system determines the function of the  key. Refer to your operating system and software manuals for an explanation of this key.



### ALPHANUMERIC KEY GROUP

The alphanumeric keys are similar to the keys on a typewriter. They include alphabetic characters, numerals, punctuation marks, and the spacebar.

#### Note

The keyboard automatically repeats most alphanumeric key group keystrokes when the key or keys are held down.

### Shift Key

The keyboard has two  keys. Use these keys to select uppercase alphabetic characters or the upper label on the numeric or character keys. To use, hold down the  key, then press the desired key.

### Caps Lock Key

The  key locks the alphabetic keys in uppercase mode. Press the key again to unlock.

### Enter Keys

After typing a command or a response to a prompt, press either  key to execute the command or send the response to the system.

### Tab Key

The **Tab** key moves the cursor forward to the next tab stop on a line. To tab backwards, hold down the **Shift** key and press the **Tab** key.

### Backspace Key

The **Backspace** key moves the cursor back one space. Depending on your software, it may or may not erase the character it passes over.

### Ctrl Key

The keyboard has two **Ctrl** (control) keys. These keys are usually interchangeable, but some software programs differentiate between the right control key and the left control key.

The software or operating system determines the function of the **Ctrl** key. Typically, the **Ctrl** key forms part of a key combination activating special functions of the operating system or software program. To perform a specific function, hold down the **Ctrl** key and press the desired key.

### Alt Key

The keyboard has two **Alt** (alternate) keys (right and left). Typically, the **Alt** key forms part of a key combination activating special functions of the operating system or software program. To perform a specific function, hold down the **Alt** key and press the desired key.

### FUNCTION KEY GROUP

The software program or operating system determines the action of the twelve function keys (**F1** to **F12**) located at the top of the keyboard.



### EDIT KEY GROUP

The top three keys in this group perform software-defined control functions. These keys are labeled **Print Scrn**, **Scroll Lock**, and **Pause**.

The six keys located above the cursor control keys perform software-defined functions often related to data editing. These keys are labeled **Insert**, **Delete**, **Home**, **End**, **Page Up**, and **Page Down**.

Refer to your software or operating system documentation for more information on the use of these keys.

### INDICATOR LIGHTS

Separate indicator lights show the current settings of the **Num Lock**, **Caps Lock**, and **Scroll Lock** functions. When a light is on, the corresponding function is enabled.

### CURSOR CONTROL KEY GROUP

The keyboard has two sets of arrow keys. The first set is to the right of the alphanumeric keys. The second set is on the numeric keypad. Use either set to move the cursor in the direction of the arrow. To use the second set, **Num Lock** must be off.

### NUMERIC KEYPAD

The numeric and math function keys have a calculator-style arrangement. These keys perform numeric functions and software-defined functions, including cursor control. Use the **Num Lock** key to toggle between numeric functions and software-defined functions. The Num Lock light indicates the numeric keypad status. If the Num Lock light is on, numeric functions are selected. If the light is off, software-defined functions, including cursor control, are activated.

## 4.2.2 Keyboard Operating Procedures

Some common keyboard operating procedures are described in the following paragraphs. Refer to your operating system and software documentation for more information about using the keyboard.

### ENDING AN ENTRY

The keyboard sends all keystrokes to the system module as you type. Some software collects these characters without processing them until you end the entry by pressing the **Enter** key.

### CORRECTING TYPING ERRORS

Most software applications allow you to correct typing errors by using the **Backspace** key. Refer to your software documentation for additional information on correcting typing errors.

### EXECUTING SYSTEM RESET FROM THE KEYBOARD



#### CAUTION

The keyboard reset (or the reset button) ends the currently running program without saving the contents of system memory. Execute a reset only if you are sure your software has failed.

To execute a system reset from the keyboard, hold down the **Ctrl** and **Alt** keys and then press the **Del** key. This operation is sometimes called a soft boot. A soft boot executes a subset of the normal power-on sequence. Use this operation to restart the system after a software failure. Some software failures prevent the soft boot from working correctly. If the soft boot does not work, press the reset button.

## 4.3 DISK DRIVES

The 300SX System uses floppy disk drives and fixed disk drives to store information. The system supports both 3.5-inch and 5.25-inch floppy disk drives. Fixed disk drives are available in two capacities: 40M and 80M.

Floppy and fixed disk drives are used to read and write to disks. Fixed disk media is permanently installed in fixed disk drives and cannot be removed. Floppy disks are inserted and removed as needed.

The system can accommodate up to three mass storage peripherals as follows:

- Drive — One half-height 5.25-inch drive (externally accessible)
- Drive B — One third-height 3.5-inch drive (externally accessible)
- Drive C — One half-height 3.5-inch drive (internal)

### Note

300SX floppy disk drive-based systems are shipped with a 3.5-inch floppy disk drive installed as drive B. The system is configured with drive B as the default disk drive.

### 4.3.1 3.5-Inch Floppy Disk Drives

The 300SX System supports both 720K and 1.44M 3.5-inch floppy disk drives.

### Note

720K floppy disk drives cannot read or write floppy disks formatted for 1.44M.

### 4.3.2 5.25-Inch Floppy Disk Drives

The 300SX System supports both 360K and 1.2M 5.25-inch floppy disk drives.

 **Note**

You can use a 1.2M floppy disk drive to write information on a 360K floppy disk, but some 360K drives may not be able to read the disk due to the narrow track written by the 1.2M drives.

### 4.3.3 Fixed Disk Drives

The 300SX System supports 40M and 80M IDE-AT fixed disk drives. Both fixed disk drives are random access storage devices using nonremovable 3.5-inch diameter magnetic disks for data storage.

## 4.4 FLOPPY DISKS

The 300SX System is shipped with a 3.5-inch floppy disk drive. A 5.25-inch floppy disk may be installed as an option.

### 4.4.1 Handling Floppy Disks

Preserve the life of floppy disks by observing the following guidelines:

- Do not put heavy objects on the floppy disk.
- Store floppy disks in a temperature range between 50 and 125 degrees Fahrenheit (10 and 51 degrees Celsius).
- Keep floppy disks away from magnetic fields.

In addition, observe the following guidelines when handling 5.25-inch floppy disks:

- Do not touch or scratch any exposed portion of the magnetic surface, or allow dust or moisture to collect on the disk.
- Do not bend the floppy disk.
- When the floppy disk is removed from the disk drive, place it in its protective envelope.
- Use only felt-tipped pens to write on the disk labels and press very lightly. Ball point pens or pencils can damage the disk.

#### **4.4.2 Write Protection**

Write protection prevents inadvertent writing or deleting of data on floppy disks. If a floppy disk is write-protected, the floppy disk drive cannot write to it.

#### **WRITE-PROTECTING 3.5-INCH FLOPPY DISKS**

To write-protect a 3.5-inch floppy disk, turn the floppy disk over and slide the write-protect switch so the hole is visible (see Figure 4-2). To write data on the floppy disk, slide the write-protect switch up to cover the hole.

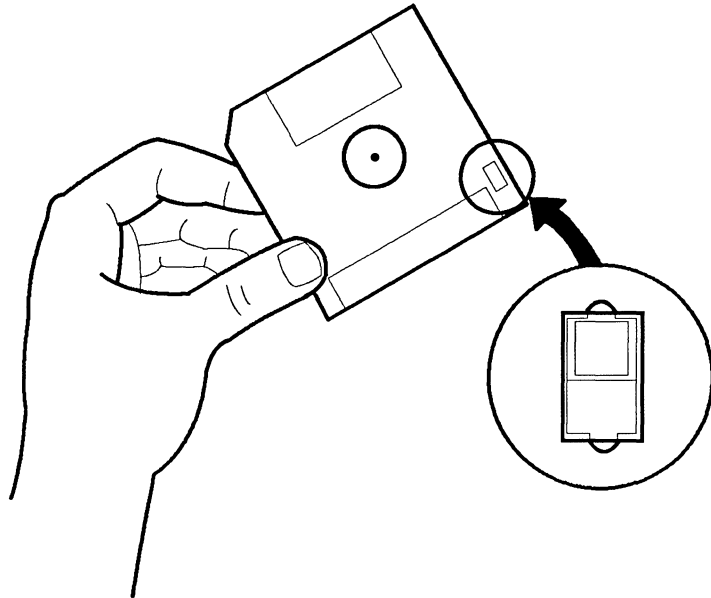

OM-00121

---

**Figure 4-2. Write Protecting a 3.5-inch Floppy Disk**

### **WRITE-PROTECTING 5.25-INCH FLOPPY DISKS**

Most 5.25-inch floppy disks have a write-protect notch on the right side. If the notch is uncovered, you can write data on the floppy disk. If the notch is covered with a write-protect tab (see Figure 4-3), the floppy disk is write-protected and data cannot be written to it. Floppy disks without a notch are permanently write-protected.

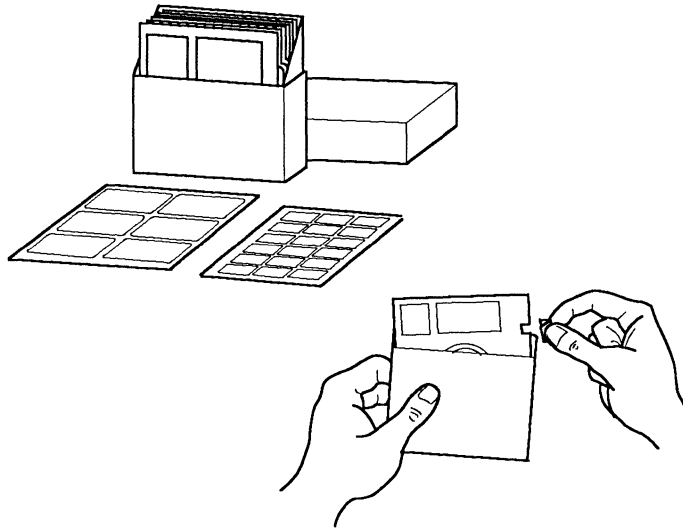

OM-00123

---

**Figure 4-3. Write Protecting a 5.25-inch Floppy Disk**

### 4.4.3 Inserting Floppy Disks

#### INSERTING A 3.5-INCH FLOPPY DISK

Hold the floppy disk by the edge and insert it (label side up) into the floppy disk drive until it clicks and locks into place (see Figure 4-4). The release button pops out to indicate the floppy disk is inserted properly.

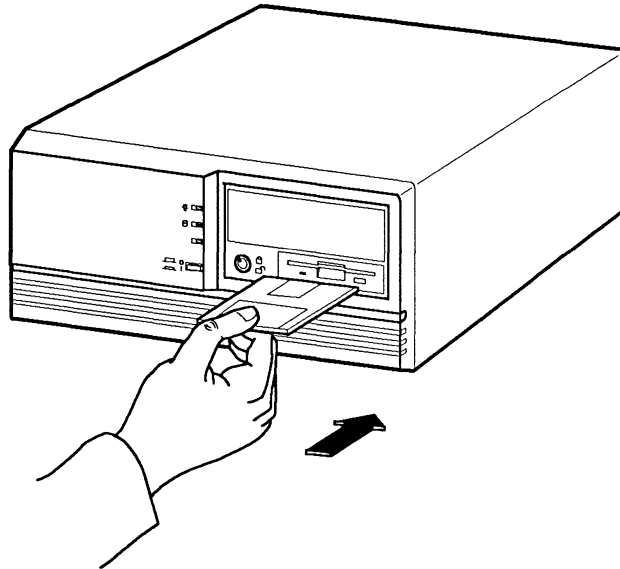

OM-00153

---

**Figure 4-4. Inserting a 3.5-inch Floppy Disk**

**Note**

The 3.5-inch floppy disks are protected by a hard plastic case. The spring-plate cover of the head aperture closes automatically when you remove the floppy disk from the floppy disk drive.

**CAUTION**

Do not remove a floppy disk from the drive when the access indicator is on. Removing the floppy disk while the access indicator is on can damage the disk.

To remove the floppy disk from the floppy disk drive, press the release button after the access light goes out. The floppy disk pops out.



### INSERTING A 5.25-INCH FLOPPY DISK

Hold the floppy disk by the top edge. With the label side up, insert the floppy disk gently into the drive until the floppy disk clicks in place (see Figure 4-5). Turn the lever clockwise (downwards) to close the drive door.



#### CAUTION

Do not remove a floppy disk from the drive when the access indicator is on. Removing the floppy disk while the access indicator is on can damage the disk.

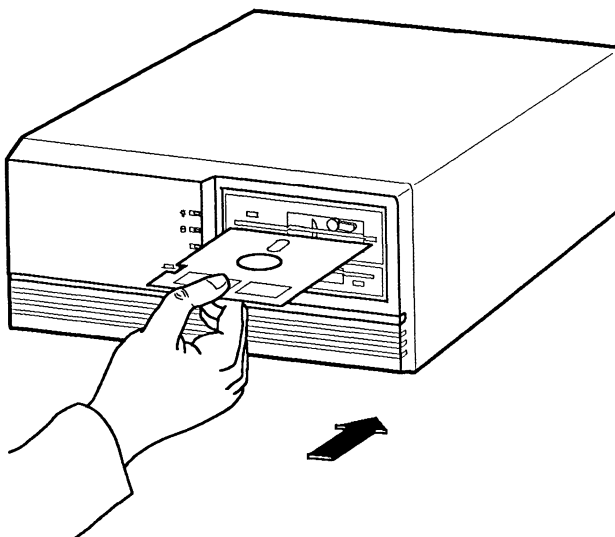

OM-00154

---

**Figure 4-5. Inserting a 5.25-inch Floppy Disk**

To release the floppy disk from the floppy disk drive, turn the lever counterclockwise (upwards). Pull the floppy disk out of the drive.

## 4.5 CHANGING THE EFFECTIVE SYSTEM SPEED

The 386SX CPU runs at a clock speed of 16 MHz, resulting in system clock cycles of 625 ns. However, there are some applications (such as those installing some copy-protected software), that cannot operate at a clock speed of 16 MHz, and instead require slower operation. To meet this requirement, a special mode can be initiated which enables the board to effectively operate at a slower speed to simulate the performance of a 8 MHz IBM AT. This special mode of operation is called *deturbo* mode. The opposite of *deturbo* mode (normal system operation) is sometimes referred to as *turbo* mode. *Deturbo* mode can be enabled in the setup program, or from the keyboard. Conversely, the normal or *turbo* mode can be enabled in the same manner.

*Deturbo* mode does not actually affect the clock rate of the 386SX microprocessor nor the 387SX numeric coprocessor. *Deturbo* mode inserts CPU wait states between each instruction, resulting in an effective CPU clock speed of 8 MHz.

If the system is put in *deturbo* mode, it will remain in *deturbo* mode even after warm reboots (**Ctrl** + **Alt** + **Delete**) or other software resets. However, a power reset will put the CPU back into normal 16 MHz operation.

The following keystroke sequences can be used to set the CPU effective speed.

**Ctrl** + **Alt** + **1**      Hold down the **Ctrl** and **Alt** keys and press **1** on the numeric keypad to place the system in *deturbo* mode.

**Ctrl** + **Alt** + **2**      Hold down the **Ctrl** and **Alt** keys and press **2** on the numeric keypad to place the system in *turbo* mode.

An audible tone occurs when you change the CPU effective speed via the keyboard. A low-pitched tone will be emitted when the system is placed into *deturbo* mode. A high-pitched tone will be emitted when the system is returned to normal operation.

Refer to Chapter 3 for instructions on changing the system effective speed using the setup program.



## Solving Problems

# 5

---

This chapter helps you identify and solve problems that might occur while using the 300SX System. Refer to section 5.1 for a quick troubleshooting checklist and section 5.2 for more detailed information.

This chapter contains the following sections:

- Identifying and Solving System Problems — identifies common problems and provides suggestions on how to solve them.
- Additional Troubleshooting Procedures — provides detailed step-by-step procedures to help you troubleshoot the system.
- Power-on Self Test (POST) — provides a general description of the power-on self test performed automatically at system power up.

### 5.1 IDENTIFYING AND SOLVING SYSTEM PROBLEMS

This section describes how to identify and solve problems that occur:

- At initial system startup
- When running a new application program after other programs have been running correctly
- During system operation after hardware and software have been running correctly

### 5.1.1 Problems at Initial System Startup

Problems occurring at initial system startup are usually caused by incorrect installation or configuration. Hardware failure is a less frequent cause.

#### REMEDIAL ACTIONS

- Are all floppy and fixed disk cables correctly connected and secure?
- Are all jumper and switch settings on expansion boards and peripheral devices correct? Refer to Chapter 2 for installation information. Also, refer to the documentation shipped with expansion boards or peripheral devices to check jumper and switch settings.
- Are all SIMMs installed correctly? Refer to Chapter 2, "Installing Your System," for installation instructions.
- Are all boards and drives installed correctly? Refer to Chapter 2, "Installing Your System," for installation instructions.
- Are system option values correct? (Run the setup program to review the values.) Refer to Chapter 3 for complete details on running the setup program.
- Is the operating system compatible with the system and loaded properly? (Refer to your operating system documentation.)

If these items are correct and the problem recurs, or if you experience a problem making it impossible to complete the checklist, refer to the detailed troubleshooting instructions described later in this chapter.

### 5.1.2 Problems When Running a New Application Program (Other Programs Run Correctly)

Problems occurring when running a new application program are usually software related. Faulty equipment is much less likely, especially if other programs run normally.

## REMEDIAL ACTIONS

- Does the system meet the hardware requirements for the program, such as minimum memory, disk storage, and monitor capabilities? (Refer to the software documentation.)
- Is the software an authorized copy? Unauthorized copies often do not work. Use only an authorized copy of the software.
- If you are using the program from a floppy disk, is it a good copy?
- If you are using the program from a fixed disk, was the program installed correctly? Were all necessary procedures followed and files installed?
- Are the correct device drivers installed?
- Is the program configured correctly for the system?
- Are you using the program correctly?

If problems persist, please contact the software vendor's customer service representative.

### 5.1.3 **Problems After the System and Software Are Running Correctly**

Problems occurring after system hardware and software are running often indicate an equipment failure. However, a number of easy-to-correct situations can also cause problems.

If a problem occurs while running a program from a floppy disk, try another copy of the program. If the new floppy disk works, make another copy of the program.

If a problem occurs while running a program from a fixed disk, try running the program from a floppy disk. If the program runs correctly, there may be a problem with the copy of the program on the fixed disk drive. Copy the program to the fixed disk drive according to the instructions supplied with the program. Make sure all necessary files are installed.

If the problem recurs, the fixed disk drive may need to be reformatted or the drive, drive controller, or system board may be faulty.

Intermittent problems can result from a loose cable, dirt in the keyboard (if keyboard input is incorrect), an overloaded power supply, or other random component failures.

If you receive any error messages, refer to Appendix B, "Error and Informational Messages," for an explanation of the messages and suggested corrective actions.

### REMEDIAL ACTIONS

- Has a transient voltage spike occurred on a power line? (To check, reload the software and attempt the operation again.)
- Has a power outage or brownout occurred? (This condition requires the same remedial procedures as those described for power line transients.)

#### Note

Voltage spikes can occasionally cause data corruption. If you are experiencing voltage surges or spikes on the power line, install a surge suppressor between the power outlet and the system module power cord.

If the problem recurs after all of these items have been checked and corrected, or the problem makes it impossible to complete the checklist, follow the additional troubleshooting procedures described below.

## 5.2 **ADDITIONAL TROUBLESHOOTING PROCEDURES**

This section provides a more detailed approach to identifying a problem and locating its source.

### 5.2.1 **Error Checking**

The 300SX System has considerable error checking ability, including POST and operating system error checking.

POST activates each time you power up the system, and POST checks certain functions of the system memory, system board, video display controller, floppy disk and fixed disk drives, controllers, and peripheral devices.

If an error is encountered, an error message appears on the screen. If there is a problem with the monitor, you may not see the error message. However, in addition to the screen messages, various beep codes inform you of problems. The beep codes consist of a pattern of long and short beeps. One short beep indicates the system passed POST.

Refer to Tables B-1 and B-2 in Appendix B for a list of items to check for each error code, and an explanation of the error beep codes.

Operating systems have varying degrees of error checking capability. Refer to the operating system documentation for a list of possible error messages.



## 5.2.2 Troubleshooting Guide

Use the following step-by-step troubleshooting procedure to help you identify a problem. This general procedure leads you through the following process:

- Prepare the system for diagnostic testing
- Verify proper operation of key system indicators
- Monitor POST execution
- Confirm operating system loading

To prepare the system for testing, perform the following steps:



### CAUTION

Turn off the system module power, as well as the power to any peripheral devices, before disconnecting peripheral cables from the system module. Failure to do so can cause permanent equipment damage.

- 1 First, press the system module power push button to off and switch off the power to external peripherals. Then, disconnect all external system peripherals, excluding the keyboard and monitor, from the system module. These devices can include printers, plotters, and modems.
- 2 Make sure the monitor and keyboard are correctly connected to the system module. Turn the monitor power switch to the on position. Turn the monitor brightness and contrast controls to at least two-thirds of the maximum (refer to the documentation shipped with the monitor).
- 3 Make sure the system module is connected to a properly grounded power outlet.
- 4 If the operating system typically loads from the fixed disk drive, make sure there is no floppy disk in drive B. Otherwise, place a floppy disk containing the operating system files in drive B.

After preparing the system module for testing, according to the previous procedures, press the system module power push button to on and check for the following indications:

- The system module power supply fan rotates. If not, refer to "Power Supply Fan Does Not Rotate" later in this section.
- The power-on LED is lighted. If not, refer to "Power Indicator LED Does Not Light" later in this section.
- The monitor power-on indicator is lighted. If not, check the power connection to the system module. If the power connection is tight, contact your service representative to repair the monitor.

If these system indicators are functioning, monitor POST as it executes to determine if the problem is due to a faulty system board, keyboard circuitry, or improper configuration.

When POST is complete, the system beeps once if no configuration errors are detected, and presents a screen display similar to the following:

```
Phoenix 80386 ROM BIOS PLUS Version x.xx yy FOB  
Copyright (c) 1985-1989 Phoenix Technologies Ltd.  
All Rights Reserved
```

```
640K Base Memory, 01024K Extended
```

If the screen does not appear, is unreadable, or of poor quality, refer to "No Characters Appear on Screen" or "Characters Appear on the Screen, But Are Distorted or Incorrect" later in this section.

If the system halts before completing the entire POST routine, a fatal system error has occurred requiring immediate attention. If a fatal system error occurs, note the screen display and write down the beep code emitted (if any). This information will be useful to your service representative.

As POST determines the system configuration, a test is performed on each magnetic peripheral installed in the system module to determine its presence. As each magnetic peripheral is checked, its access indicator should light briefly. Check for the following:

- The floppy disk drive B access indicator lights briefly. If not, refer to "Floppy Disk Drive Access Indicator Light Does Not Light" later in this section.
- If a second floppy disk drive A is installed, its access indicator lights briefly. If not, refer to "Floppy Disk Drive Access Indicator Light Does Not Light" later in this section.
- The fixed disk drive access indicator lights briefly. If not, refer to "Fixed Disk Drive Access Indicator Light Does Not Light" later in this section.

If configuration errors are detected, the system beeps twice and displays a message similar to the following:

```
Invalid configuration information -  
  please run the SETUP program  
  Strike the F1 key to continue
```

If no errors are detected, the system beeps once. If no beep or more than one beep sounds, refer to "No Beep Pattern or Incorrect Beep Pattern" later in this section.

### **Note**

Depending on the type of errors detected, different beep codes occur. Refer to Appendix B, "Error and Informational Messages," and Tables B-1 and B-2 for an explanation of each beep code and suggested remedial actions.

If a system password has not been initialized, POST turns system control over to the bootstrap routine. Otherwise, a prompt appears requesting the entry of the system password. If this prompt appears, enter the correct system password to complete the boot process.

Once the boot process has completed, the operating system prompt appears on the screen. This will vary in appearance, depending on the operating system setup. If the operating system prompt does not appear, refer to "Operating System Does Not Load From Fixed Disk Drive" later in this section.

If you did not have time to note all of these items, press the reset button, and repeat this step as many times as necessary.

### 5.2.3 Specific Problems and Remedial Actions

This section provides possible solutions for problems identified in the "Troubleshooting Guide." The following is a list of the specific problems covered:

- Power supply fan does not rotate
- Power indicator LED does not light
- No characters appear on screen
- Characters appear on the screen, but are distorted or incorrect
- No beep pattern
- Floppy disk drive access indicator does not light
- Fixed disk drive access indicator does not light
- Problems with application software
- Cannot set system password

Try the solutions in the order given. After taking any corrective action, return to "Troubleshooting Guide" step 1 in this section. If you cannot correct the problem, contact your service representative or authorized dealer for assistance.

### **POWER SUPPLY FAN DOES NOT ROTATE**

Check the following items:

- The power outlet is working and voltage is correct for the system module.
- The power cord is properly connected at both ends.
- If you are using a power strip with a switch, make sure the switch is turned on.

If all connections are tight and the power outlet is functioning, the power supply is probably defective. Contact your service representative or authorized dealer for assistance.

### **POWER INDICATOR LED DOES NOT LIGHT**

Check the following items:

- If the system is operating normally, the LED is probably disconnected or defective.
- If the system has other problems, check the items listed under "Power Supply Fan Does Not Rotate."

If all items are correct and problems persist, contact your service representative or authorized dealer for assistance.

### **NO CHARACTERS APPEAR ON SCREEN**

Check the following items:

- The monitor power switch is turned on.
- The monitor brightness and contrast controls are adjusted properly.
- The monitor signal cable and power cable connections are installed properly.

The monitor type option may be set incorrectly. Hold down the **Ctrl** and **Alt** keys and press **4** on the numeric keypad to force the default video monitor type to VGA. Reboot the system. If there are still no characters on the screen, contact your service representative or authorized dealer for assistance.

POST emits one long beep and four short beeps or a long-short-long-short beep pattern to indicate a possible problem with the onboard video display controller. If you do not receive a beep pattern and characters do not appear, the monitor or onboard video display controller may be defective. Contact your service representative or authorized dealer for assistance.

### **CHARACTERS APPEAR ON THE SCREEN, BUT ARE DISTORTED OR INCORRECT**

Check the following items:

- The monitor brightness and contrast controls are turned up. (Refer to the documentation shipped with the video display.)
- The monitor signal and power cable connections are installed correctly.

If the problem still persists after checking the monitor controls and connections, contact your service representative or authorized dealer for assistance.

### **NO BEEP PATTERN**

If there was no beep, but the system operates normally, the speaker may be defective or disconnected. Contact your service representative or authorized dealer for assistance.

### **FLOPPY DISK DRIVE ACCESS INDICATOR DOES NOT LIGHT**

Check the following items:

- The floppy disk drive power and signal cable connections are installed correctly and secure.
- All related switches and jumpers are correct.

If the problem persists, there may be a problem with the floppy disk drive, system board, drive signal cable, or LED connector. Contact your service representative or authorized dealer for assistance.

### **FLOPPY DISK DRIVE ACCESS INDICATOR REMAINS LIGHTED**

Check the following:

- The floppy disk drive power and signal cables are installed correctly.

### **FIXED DISK DRIVE ACCESS INDICATOR DOES NOT LIGHT**

Check the following items:

- The fixed disk drive power, LED, and signal cable connections are installed correctly and secure.
- All related switches and jumpers are correct.

If you received error messages, refer to Appendix B, "Error and Informational Messages," for an explanation of the messages. If you did not receive error messages, check the following items:

- Run the setup program (refer to Chapter 3) and make sure the fixed disk drive is configured correctly with the correct drive type, the drive is correctly initialized and partitioned, and the operating system is installed correctly on the boot partition.
- Make sure all related switches and jumpers are correct.

If the problem persists, there may be a problem with the fixed disk drive, system board, drive signal cable, or LED connector. Contact your service representative or authorized dealer for assistance.

### **PROBLEMS WITH APPLICATION SOFTWARE**

Check the following items:

- Make sure the software is properly configured for the system. Refer to the software installation and operation documentation for instructions on setting up and using the software.
- Try a different copy of the software to see if the problem is with the copy you are using.
- Check the system board and video display controller switch and jumper settings. Make sure all cable connections are installed correctly.
- Try running the software in a different speed mode. (Refer to section 4.5 for information on changing effective system speed.)
- If other programs run correctly on the system, contact your authorized dealer for the software program that is malfunctioning.

If the problem persists, contact your service representative or authorized dealer for assistance.



## **CANNOT SET SYSTEM PASSWORD**

Check the following item:

- Make sure that the password jumper is set to password enable (refer to Chapter 2).

---

## Maintaining Your System

# 6

---

This chapter describes how to:

- Replace the system battery
- Clean the outside of the system
- Clean the screen
- Prepare the system for moving

### 6.1 REMOVING AND REPLACING THE SYSTEM BATTERY

The following procedures are provided in the event that the system battery fails.

#### 6.1.1 Removing the Battery

A lithium battery provides power for the CMOS RAM which holds the system configuration information entered during system setup. Disconnecting the battery from the system board clears the system configuration information stored in CMOS RAM. After restoring battery power to the system board, run the setup program to initialize system parameters. Use the following procedure to replace the system battery.

To remove the battery, do the following:

- 1 Prepare the system module as described in section 2.4.1.
- 2 Disconnect the battery from connector J23 (marked "battery").
- 3 Lift the battery from the VELCRO mounting pad located on the chassis floor.



### **WARNING**

The battery may explode if mistreated. Do not recharge, disassemble, or dispose of in fire. Dispose of used batteries promptly. Keep away from children.

## 6.1.2 Replacing the Battery



### **WARNING**

Replace the battery with a Panasonic Model BR-E3. Use of another battery may present a risk of fire or explosion.

To install a new battery, do the following:

- 1 Place the replacement battery on the VELCRO mounting pad located on the chassis floor.
- 2 Attach the battery connector to the 300SX board at J23 (marked "battery").

## 6.2 CLEANING THE SYSTEM



### **CAUTION**

Be sure to turn the system off before performing any cleaning operations. When using a moistened cloth for cleaning, do not allow any excess fluid to leak into the system module, keyboard, or monitor. In addition, wait until the monitor screen is completely dry before reapplying power.

Clean the outside of the system with a soft cloth. Use a cloth lightly moistened with a mild detergent solution. Do not use solvents or abrasive cleaners.

### 6.3 CLEANING THE SCREEN

If the monitor screen gets dirty, clean it with a sponge or chamois cloth lightly dampened with a mild detergent solution. Do not use solvents or abrasive cleaners. Allow the system to thoroughly dry before reapplying power.

### 6.4 MOVING THE SYSTEM

Perform the following if you are shipping the system or moving it by vehicle or handcart:

- 1 Back up all files stored on fixed disk drives.
- 2 Turn off the power and disconnect the power cord.
- 3 Disconnect the keyboard cable from the system module.
- 4 Turn off the monitor power switch and disconnect the monitor power cord from the power outlet.
- 5 Disconnect the monitor signal cable from the system module.
- 6 Disconnect any other external peripheral devices such as printers and modems.
- 7 Insert a drive protection card in the 5.25-inch floppy disk drive (if applicable). If you do not have a drive protection card, use a blank floppy disk.
- 8 Pack the system as described in section 6.4.1.

### **6.4.1 Packing the System**

If you are moving the system a short distance (from one room to another in the same building), you do not have to pack the system. If you are shipping the system or moving it by vehicle, pack the system modules to avoid damage.

Pack each module in the original packing material and box. If you did not save the boxes and material, use a sturdy carton and cushion the modules with packing material to avoid damage.

### **6.4.2 Installing the System at the New Location**

After moving the system to the new location, follow the instructions in Chapter 2, "Installing Your System" to reinstall the system.

## Technical Characteristics

# A

---

This appendix provides information about the technical characteristics of the 300SX System. Information includes:

- System specifications
- System board connectors
- Power supply connectors

### A.1 SYSTEM SPECIFICATIONS

The following sections describe the major system module specifications.

### A.1.1 System Board

CPU:	386SX microprocessor
Word Size:	16 bits
Clock Rate:	16 MHz
Bus Speed:	8 MHz
Data Path:	8, 16 bits
System Onboard Memory:	2M (expandable to 4M)
System Memory:	16M (maximum addressable)
Memory Speed:	100 ns
System ROM:	128K
Expansion Slots:	Four 16-bit slots (also accept 8-bit boards)

### A.1.2 Dimensions

Width:	14.0 inches (36 cm)
Height: *	6.25 inches (16 cm)
Depth:	15.75 inches (40 cm)
Weight:	27 pounds (12.2 kg) approximate

\* with rubber feet attached

### A.1.3 Environment

Operating Temperature:	10 °C to 40 °C (50 °F to 104 °F)
Storage Temperature:	-40 °C to 60 °C (-40 °F to 140 °F)
Operating Humidity:	20% to 80%, noncondensing
Storage Humidity:	5% to 92%, noncondensing
Altitude:	10,000 feet (3050 m), maximum
Noise:	45 dBA, maximum

Table A-1 specifies the AC input power requirements.

**Table A-1. AC Input Power Requirements**

Voltage Selected	Maximum Range	Input Current	Frequency Limits
115VAC	90 - 132VAC	6.0A	47 - 63 Hz
230VAC	176 - 264VAC	4.0A	47 - 63 Hz

### A.2 SYSTEM INTERFACES

The system board contains one floppy disk interface connector, one fixed disk interface connector, two serial port connectors, one parallel printer port connector, four expansion slot connectors, one TTL video interface connector, one analog video interface connector, one speaker connector, one battery connector, one keyboard connector, one mouse connector, and one keylock interface connector.



## A.2.1 Floppy Disk Interface Connector

Table A-2 lists the pinouts for floppy disk interface connector J18.

**Table A-2. Floppy Disk Interface Connector J18 Pinouts**

Pin	Signal	Function
1	GROUND	Ground
2	LD*	Head Load
3	GROUND	Ground
4	NC	No connect
5	GROUND	Ground
6	NC	No connect
7	GROUND	Ground
8	INDEX*	Beginning of track
9	GROUND	Ground
10	MOTENA*	Motor Enable A
11	GROUND	Ground
12	DRVSELB*	Drive Select B
13	GROUND	Ground
14	DRVSELA*	Drive Select A
15	GROUND	Ground
16	MOTENB*	Motor Enable B
17	GROUND	Ground
18	DIR*	Direction select
19	GROUND	Ground
20	STEP*	Motor step
21	GROUND	Ground
22	WRDATA*	Write data strobe
23	GROUND	Ground
24	FLPYWE*	Floppy disk write enable
25	GROUND	Ground
26	TRACK0*	Track 0 indicator
27	GROUND	Ground
28	WP*	Write protect
29	GROUND	Ground
30	RDDATA*	Read data strobe
31	GROUND	Ground
32	HDSEL*	Head Select
33	GROUND	Ground
34	DSKCHNG*	Drive door open

## A.2.2 Fixed Disk Interface Connector

Table A-3 lists the pinouts for fixed disk interface connector J19.

**Table A-3. Fixed Disk Interface Connector J19 Pinouts**

Pin	Signal	Function
1	HOST RESET*	Reset signal from CPU
2	GROUND	Ground
3	HOST DATA 7	Data bit 7
4	HOST DATA 8	Data bit 8
5	HOST DATA 6	Data bit 6
6	HOST DATA 9	Data bit 9
7	HOST DATA 5	Data bit 5
8	HOST DATA 10	Data bit 10
9	HOST DATA 4	Data bit 4
10	HOST DATA 11	Data bit 11
11	HOST DATA 3	Data bit 3
12	HOST DATA 12	Data bit 12
13	HOST DATA 2	Data bit 2
14	HOST DATA 13	Data bit 13
15	HOST DATA 1	Data bit 1
16	HOST DATA 14	Data bit 14
17	HOST DATA 0	Data bit 0
18	HOST DATA 15	Data bit 15
19	GROUND	Ground
20	KEY	No connection
21	HOST IO CHRDY*	I/O channel ready
22	GROUND	Ground
23	HOST IOW*	I/O write
24	GROUND	Ground
25	HOST IOR*	I/O read
26	GROUND	Ground
27	HOST IO CHRDY*	I/O channel ready
28	HOST ALE	Address latch enable
29	RESERVED	No Connection
30	GROUND	Ground
31	HOST IRQ14	IRQ14
32	HOST IO CS16*	Drive register enabled
33	HOST ADDR 1	Address bit 1
34	RESERVED	No connection

*(continued)*

**Table A-3. Fixed Disk Interface Connector J19 Pinouts** *(continued)*

Pin	Signal	Function
35	HOST ADDR 0	Address bit 0
36	HOST ADDR 2	Address bit 2
37	HOST CS0*	Reg. access chip select 0
38	HOST CS1*	Reg. access chip select 1
39	DISK ACTIVE*	Disk activity indicator
40	GROUND	Ground

### A.2.3 Serial Port Connectors

Connectors J2A and J2B provide signals for serial I/O ports COM1 and COM2. COM1 signals connect to DB9 RS-232 male connector J2B. COM2 signals connect to DB9 RS-232 male connector J2A. COM1 and COM2 signals are also available at J13, a 2 × 13 header. Table A-4 lists the pinouts for connectors J2A and J2B and Table A-5 lists the pinouts for header J13.

**Table A-4. Serial Port Connectors J2A and J2B Pinouts**

Pin	Signal	Function
1	DCD	Carrier detect
2	RXD	Receive data
3	TXD	Transmit data
4	DTR	Data terminal ready
5	Ground	
6	DSR	Data set ready
7	RTS	Request to send
8	CTS	Clear to send
9	RI	Ring indicator

**Table A-5. Serial Port Header J13 Pinouts**

<b>Pin</b>	<b>Signal</b>	<b>Function</b>
1	DCD1	Carrier detect (COM1)
2	DSR1	Data set ready (COM1)
3	RXD1	Receive data (COM1)
4	RTS1	Request to send (COM1)
5	TXD1	Transmit data (COM1)
6	CTS1	Clear to send (COM1)
7	DTR1	Data terminal ready (COM1)
8	RI1	Ring indicator (COM1)
9	Ground	
10	DCD2	Carrier detect (COM2)
11	DSR2	Data set ready (COM2)
12	RXD2	Receive data (COM2)
13	RTS2	Request to send (COM2)
14	TXD2	Transmit data (COM2)
15	CTS2	Clear to send (COM2)
16	DTR2	Data terminal ready (COM2)
17	RI2	Ring indicator (COM2)
18	Ground	

Refer to the *Intel386™ MicroComputer Model 300SX Board Technical Reference Manual* for a detailed description of the serial communications ports.

### A.2.4 Parallel Printer Port

The parallel printer port, connector J1, provides a one-way interface to a printer. Connector J1 is a 25-pin D-subminiature female connector. J11, a 2 × 13 header, is provided for connecting to ribbon cables. Table A-6 lists the pinouts for connector J1 and Table A-7 lists the pinouts for header J11.

**Table A-6. Parallel Port Connector J1 Pinouts**

Pin	Signal	Function
1	STROBE*	
2	PRTD0	Data bit 0
3	PRTD1	Data bit 1
4	PRTD2	Data bit 2
5	PRTD3	Data bit 3
6	PRTD4	Data bit 4
7	PRTD5	Data bit 5
8	PRTD6	Data bit 6
9	PRTD7	Data bit 7
10	ACK*	Acknowledge
11	BUSY	
12	PE	Paper end
13	SLCT	Select
14	AUTOFDXT*	Auto feed
15	ERROR*	
16	INIT*	
17	SLCTIN*	Select input
18-25	Ground	

**Table A-7. Parallel Port Header J11 Pinouts**

Pin	Signal	Function
1	STROBE*	
2	AUTOFDXT*	Auto feed
3	PRTD0	Data bit 0
4	ERROR*	
5	PRTD1	Data bit 1
6	INIT*	
7	PRTD2	Data bit 2
8	SLCTIN*	Select
9	PRTD3	Data bit 3
10	Ground	
11	PRTD4	Data bit 4
12	Ground	
13	PRTD5	Data bit 5
14	Ground	
15	PRTD6	Data bit 6
16	Ground	
17	PRTD7	Data bit 7
18	Ground	
19	ACK*	Acknowledge
20	Ground	
21	BUSY	
22	Ground	
23	PE	Paper end
24	Ground	
25	SLCT	Select

Refer to the *Intel386™ MicroComputer Model 300SX Board Technical Reference Manual* for a detailed description of the parallel printer port.

## A.2.5 Expansion Slot Connectors

Tables A-8 and A-9 list the pin assignments for the Intel ISA bus 8-bit and 16-bit connectors, respectively.

**Table A-8. Intel ISA Bus 8-bit Connector Pin Assignments**

Pin No.	Signal	Pin No.	Signal
B1	Ground	A1	IOCHCK
B2	RSTDEV	A2	D07
B3	+5V	A3	D06
B4	IRQ09	A4	D05
B5	-5V	A5	D04
B6	DRQ2	A6	D03
B7	-12V	A7	D02
B8	SRDY	A8	D01
B9	+12 V	A9	D00
B10	Ground	A10	IOCHRDY*
B11	MEMW*	A11	AEN
B12	MEMR*	A12	A19
B13	IOWC*	A13	A18
B14	IORC*	A14	A17
B15	DACK3*	A15	A16
B16	DRQ3	A16	A15
B17	DACK1*	A17	A14
B18	DRQ1	A18	A13
B19	MEMREF*	A19	A12
B20	SYCLK	A20	A11
B21	IRQ07	A21	A10
B22	IRQ06	A22	A09
B23	IRQ05	A23	A08
B24	IRQ04	A24	A07
B25	IRQ03	A25	A06
B26	DACK2*	A26	A05
B27	TC	A27	A04
B28	BUSALE	A28	A03
B29	+5V	A29	A02
B30	84OSC	A30	A01
B31	Ground	A31	A00

**Table A-9. Intel ISA Bus 16-bit Connector Pin Assignments**

Pin No.	Signal	Pin No.	Signal
D1	MCS16*	C1	SBHE*
D2	IOCS16*	C2	LA23
D3	IRQ10	C3	LA22
D4	IRQ11	C4	LA21
D5	IRQ12	C5	LA20
D6	IRQ15	C6	LA19
D7	IRQ14	C7	LA18
D8	DACK0*	C8	LA17
D9	DRQ0	C9	MEMR*
D10	DACK5*	C10	MEMW*
D11	DRQ5	C11	D08
D12	DACK6*	C12	D09
D13	DRQ6	C13	D10
D14	DACK7*	C14	D11
D15	DRQ7	C15	D12
D16	+5V	C16	D13
D17	SECMAS1*	C17	D14
D18	Ground	C18	D15

## A.2.6 Video Interface Connectors

The 300SX board has two video interface connectors, J5 and J6. Connector J5 is a 15-pin female connector intended for use with an analog (VGA) monitor. Connector J6 is a 9-pin female connector intended for use with a digital (TTL) monitor. Table A-10 lists the pinouts of connector J5. Table A-11 lists the pinouts of connector J6.

### Note

Pin 1 of connector J5 is located in the upper left-hand corner of the connector. Pin 15 is at the lower right-hand corner.



**Table A-10. Video Connector J5 Pinouts**

Pin	Function
1	Red video
2	Green video
3	Blue video
4	Monitor identification bit 2
5	Ground
6	Red return (ground)
7	Green return (ground)
8	Blue return (ground)
9	Key position (no pin)
10	Sync return (ground)
11	Monitor identification bit 0
12	Monitor identification bit 1
13	Horizontal sync
14	Vertical sync
15	Not used

 **Note**

Monochrome monitors use green video for all video input and ignore red and blue video.

**Table A-11. Video Connector J6 Pinouts**

Pin	Function
1	Ground
2	Red video
3	Intensified red video
4	Intensified green video
5	Intensified blue video
6	Green video
7	Blue video
8	Horizontal sync
9	Vertical sync

### A.2.7 Speaker Interface

A high current analog driver provides audible tone generation for the speaker. The speaker drive signal is gated on and off by bit 0 (ENABLE SPEAKER) of port 61H. Bit 1 (SPEAKER DATA) supplies the data for sounding the speaker. A 1 × 4 speaker header (J21) provides the connection between the speaker and the system (refer to Table A-12).

**Table A-12. Speaker Header J21 Pinouts**

Pin	Signal/Function
1	SPKOUT speaker drive out
2	Key (pin missing)
3	Ground
4	+5VDC

### A.2.8 Battery Connector

The 300SX system board includes connector J23 for installing a battery. The battery backs up CMOS RAM to retain system configuration and password information when AC power is removed.

### A.2.9 Keyboard Connector

The keyboard connects to 5-pin DIN connector J3B. Table A-13 lists the pinouts for the keyboard connector.

**Table A-13. Keyboard Connector J3B Pinouts**

Pin	Signal/Function
1	KBD CLK
2	KBD DATA
3	Reserved
4	Ground
5	+5VDC

### A.2.10 Mouse Connector

The mouse connects to 6-pin mini-DIN connector J4. Table A-14 lists the pinouts for the mouse connector.

**Table A-14. Mouse Connector J4 Pinouts**

Pin	Signal/Function
1	Data
2	Reserved
3	Ground
4	+5V
5	Clock
6	Reserved

### A.2.11 Keylock Interface

The keylock interface locks out all data from the keyboard. The keyboard is locked out anytime the system board receives the KEYLOCK\* signal. A 1 × 5 keylock header (J24) provides the connection between the system and the controller (refer to Table A-15). Header J24 also connects to the power-on indicator LED.

**Table A-15. Keylock Header J24 Pinouts**

Pin	Signal/Function
1	Power for power-on LED
2	Key (pin missing)
3	Ground
4	KEYLOCK*
5	Ground

### A.2.12 Power Supply Header

Header J12, located on the system board, receives power from power supply connectors PS1 and PS2. This power is then distributed to the system board components and four expansion slots.

Header J12 can carry a maximum of 18A at +5V to the system board. While each of the 12 pins in header J12 can accommodate 5A, the power supply's capacity limits the +5V-supply current drain to a maximum of 18A.

**Table A-16. Power Supply Header J12 Pinouts**

Pin	Signal/Function
1	SYSRST*
2	+5V
3	+12V
4	-12V
5	Ground
6	Ground
7	Ground
8	Ground
9	-5V
10	+5V
11	+5V
12	+5V

### A.3 POWER SUPPLY

The power supply provides four DC voltages: +12V, -12V, +5V, and -5V. These voltages are used by the various components within the system module. Table A-17 lists the input power requirements.

**Table A-17. System Input Power Requirements**

Voltage Selected	Maximum Range	Input Current	Frequency Limits
115VAC	90 - 132VAC	6.0A	47 - 63 Hz
230VAC	176 - 264VAC	4.0A	47 - 63 Hz

Power supply connectors PS1 and PS2 mate with system board header J12. Power supply connector PS1 supplies +12V, -12V, and +5V, and mates with pins 1 through 6 on header J12. Power supply connector PS2 supplies +5V and -5V and mates with pins 7 through 12 on header J12.

The remaining power supply connectors, PS3 - PS5, supply power to peripheral devices mounted in the peripheral device bays.

## Error and Informational Messages

# B

---

### B.1 INTRODUCTION

This appendix describes the various system screen messages and error beep codes. Information is grouped as follows:

- POST and boot error messages
- POST and boot informational messages
- Run-time messages
- System board errors
- Beep codes for fatal errors
- Beep codes for non-fatal errors

### B.2 POST AND BOOT MESSAGES

The POST displays messages to indicate errors in hardware, software, or firmware, or to provide other information.

If the POST can display a message on the monitor screen, it will beep the speaker twice as the message appears. However, when an error occurs before the monitor is initialized, the POST cannot display messages on the screen. POST sounds a series of beeps instead.

The next three sections provide a general grouping of messages, with each group arranged in alphabetical order. Each message is accompanied by a short paragraph describing the message and gives a recommended solution to the problem.

Italics indicate variable parts of a message such as memory addresses. These variable parts of the message may differ at each occurrence.

### B.2.1 POST and Boot Error Messages

Message:            *Coprocessor failed*

Possible Cause:   Coprocessor not correctly seated in its socket or the coprocessor has failed.

Solution:           Reseat the coprocessor chip. Rerun the setup program. If the coprocessor still fails, call your service representative.

Message:           *Diskette drive 0 seek failure*

Possible Cause:   Drive A has either failed or is missing.

Solution:           Make sure drive A is present and the floppy disk is inserted properly. If they are, then drive A may have failed.

Message:           *Diskette drive 1 seek failure*

Possible Cause:   Drive B has either failed or is missing.

Solution:           Make sure drive B is present and the floppy disk is inserted properly. If they are, then drive B may have failed.

Message:           *Diskette read failure -  
strike F1 to retry boot*

Possible Cause:   The two most likely causes for this condition are: (1) the floppy disk is not bootable, and (2) the floppy disk is defective.

Solution:           Replace the floppy disk with a bootable floppy disk and try again. Clean the drive heads if necessary.

Message:           Diskette subsystem reset failed  
Possible Cause:    The floppy disk adapter cable has failed.  
Solution:           Check the floppy disk adapter cable.

Message:           Display adapter failed; using alternate  
Possible Cause:    The monitor type jumpers are set incorrectly or the primary video adapter failed.  
Solution:           Make sure the monitor type jumpers are set correctly.  
                    Check the primary video adapter.

 **Note**

The following basic message precedes any of the possible errors numbered 1 through 6. These errors can only occur when the setup program is run.

Message:           Errors have been found during the power on self test in your system. The errors were:

- 1 Clock chip lost power
- 2 CMOS checksum invalid
- 3 Incorrect configuration data in CMOS
- 4 Memory size in CMOS invalid
- 5 Disk C: failed initialization
- 6 Time or Date in CMOS is invalid

Hit any key to continue

Possible Cause:    The configuration information stored in the real-time clock CMOS memory chip does not agree with the hardware configuration of the system.

Solution:           Make sure the jumper settings on the system board agree with the hardware configuration. Run the setup program and reenter data accounting for the indicated error.



Message:	Gate A20 failure
Possible Cause:	The system cannot switch into protected mode.
Solution:	Call your service representative.
Message:	Hard disk configuration error
Possible Cause:	The specified configuration is incorrect.
Solution:	Run the setup program and enter the correct fixed disk drive type.
Message:	Hard disk controller failure
Possible Cause:	The fixed disk controller has failed.
Solution:	Check the controller cable connections. If the message recurs, replace the fixed disk controller.
Message:	Hard disk failure
Possible Cause:	The fixed disk is defective.
Solution:	Check the system configuration and drive type, and run the setup program. Check the controller cable. If the message recurs, replace the fixed disk drive.
Message:	Hard disk read failure - strike F1 to retry boot
Possible Cause:	The fixed disk is defective.
Solution:	Check the system configuration and drive type, and run the setup program. Check the controller cable. If the message recurs, replace the fixed disk drive.
Message:	<i>hex-value</i> Optional ROM bad checksum = <i>hex-value</i>
Possible Cause:	A peripheral card contains a defective ROM or its address conflicts with another card.
Solution:	Replace the ROM or the peripheral card, or correct the address conflict.

- Message:** Invalid configuration information - please run Setup program
- Possible Cause:** The memory size is incorrect, the display is configured incorrectly, or the number of floppy disk drives is incorrect.
- Solution:** Check the system configuration and run the setup program.
- 
- Message:** Keyboard clock line failure
- Possible Cause:** Either the keyboard or the keyboard cable connection is defective.
- Solution:** Check the keyboard connection. If connection is good, the keyboard may have failed.
- 
- Message:** Keyboard controller failure
- Possible Cause:** The keyboard controller has failed.
- Solution:** Call your service representative.
- 
- Message:** Keyboard data line failure
- Possible Cause:** Either the keyboard or the keyboard cable connection is defective.
- Solution:** Check the keyboard connection. If connection is good, the keyboard may have failed.
- 
- Message:** Keyboard is locked - please unlock - Strike the F1 key to continue
- Possible Cause:** The keyboard lock (located at the front of the system) is activated.
- Solution:** Unlock the keyboard and try again.
- 
- Message:** Keyboard stuck key failure
- Possible Cause:** One or more of the keys is pressed.
- Solution:** Release the key or keys and try again.

- Message:** Memory address line failure at *hex-value*, read *hex-value* expecting *hex-value*
- Possible Cause:** One of the SIMMs or associated circuitry has failed.
- Solution:** Check for defective SIMM and replace if necessary. If the message repeats, contact your service representative.
- 
- Message:** Memory data line failure at *hex-value*, read *hex-value*, expecting *hex-value*
- Possible Cause:** One of the SIMMs or associated circuitry has failed.
- Solution:** Check for defective SIMM and replace if necessary. If the message repeats, contact your service representative.
- 
- Message:** Memory double word logic failure at *hex-value*, read *hex-value* expecting *hex-value*
- Possible Cause:** One of the SIMMs or associated circuitry has failed.
- Solution:** Check for defective SIMM and replace if necessary. If the message repeats, contact your service representative.
- 
- Message:** Memory high address line failure at *hex-value*, read *hex-value* expecting *hex-value*
- Possible Cause:** One of the SIMMs or associated circuitry has failed.
- Solution:** Check for defective SIMM and replace if necessary. If the message repeats, contact your service representative.
- 
- Message:** Memory odd/even logic failure at *hex-value*, read *hex-value* expecting *hex-value*
- Possible Cause:** One of the SIMMs or associated circuitry has failed.
- Solution:** Check for defective SIMM and replace if necessary. If the message repeats, contact your service representative.

- Message:** Memory parity failure at *hex-value*, read *hex-value* expecting *hex-value*
- Possible Cause:** One of the SIMMs or associated circuitry has failed.
- Solution:** Check for defective SIMM and replace if necessary. If the message repeats, contact your service representative.
- 
- Message:** Memory write/read failure at *hex-value*, read *hex-value* expecting *hex-value*
- Possible Cause:** One of the SIMMs or associated circuitry has failed.
- Solution:** Check for defective SIMM and replace if necessary. If the message repeats, contact your service representative.
- 
- Message:** No boot device available - strike F1 to retry boot
- Possible Cause:** If booting from a floppy disk, it is a non-bootable type or the floppy disk drive is defective. If booting from a fixed disk, it may not be formatted or the disk drive is defective. The problem could also be in the disk controller.
- Solution:** Make sure the floppy disk in drive A contains an operating system. If applicable, make sure the fixed disk drive contains an operating system. Check the disk controller.
- 
- Message:** No boot sector on hard disk - strike F1 to retry boot
- Possible Cause:** The fixed disk is not formatted as a system disk.
- Solution:** Format the disk with the /S option.
- 
- Message:** No timer tick interrupt
- Possible Cause:** The timer chip on the system board may have failed.
- Solution:** Contact your service representative.

- Message:** Not a boot diskette -  
strike F1 to retry boot
- Possible Cause:** The floppy disk in drive A is not formatted as a system disk.
- Solution:** Replace the floppy disk with a bootable system floppy disk and try again.
- 
- Message:** Shadow of System BIOS failed - Executing from ROM  
-  
Strike the F1 key to continue
- Possible Cause:** System RAM is defective.
- Solution:** Check SIMMs and replace defective module.
- 
- Message:** Shadow of Video BIOS failed - Executing from ROM -  
Strike the F1 key to continue
- Possible Cause:** System RAM is defective or the video BIOS cannot be shadowed.
- Solution:** Check for defective SIMMs. If none are found, run the setup program and turn shadowing of the video BIOS off.
- 
- Message:** Shutdown failure
- Possible Cause:** The keyboard controller or its associated logic has failed.
- Solution:** Call your service representative.

Message: Time-of-day clock stopped

Possible Cause: The external battery for the clock is probably dead.

Solution: Replace the battery.

Message: Time-of-day not set -  
Please run SETUP program

Possible Cause: The date and time information is not set in the real-time clock.

Solution: Run the setup program and set the date and time.

Message: Timer chip counter 2 failed

Possible Cause: The timer chip on the system board may have failed.

Solution: Contact your service representative.

Message: Timer or interrupt controller bad

Possible Cause: The timer chip or the interrupt controller on the system board may have failed.

Solution: Contact your service representative.

Message: Unexpected interrupt in protected mode

Possible Cause: The system received an interrupt when in protected mode - probably while testing memory.

Solution: Contact your service representative.

## B.2.2 POST and Boot Informational Messages

These messages do not indicate error conditions.

Message: *Hex-valuek* Base Memory

Meaning: Indicates amount of base memory tested successfully.

Message: *Hex-valuek* extended

Meaning: Indicates amount of extended memory tested successfully.

Message: *Hex-valuek* of unshadowed memory added to extended memory and removed from dedicated memory.

Meaning: Indicates the amount of unused memory from 80000H to F0000H that has been added to the end of extended memory.

Message: Decreasing available memory

Meaning: Follows any memory error message. Informs you available memory size is adjusted to avoid use of the failed memory.

Message: Memory test terminated by keystroke

Meaning: The spacebar was pressed during the memory test. Reboot the system if you want to run the POST.

Message: Strike the F1 key to continue.

Meaning: The POST detected an error prior to boot. Pressing the  key lets the system try to boot.

### B.3 RUN-TIME MESSAGES

Run-time messages are displayed if an error occurs after the boot process is complete.

Message: I/O card parity interrupt at address *hex-value*.  
Type (S)hut off NMI, (R)eboot, other keys to  
continue

Possible Cause: A peripheral card has failed.

Solution: Type S to shut off the nonmaskable interrupt (NMI). This will temporarily allow you to continue. Replace the peripheral card.

Message: Memory parity interrupt at address *hex-value*.  
Type (S)hut off NMI, (R)eboot, other keys to  
continue

Possible Cause: One or more memory chips has failed.

Solution: Type S to shut off the nonmaskable interrupt (NMI). This will temporarily allow you to continue. Check the seating of the SIMMs and replace any defective SIMM.

Message: Unexpected HW interrupt at address *hex-value*.  
Type (R)eboot, other keys to continue

Possible Cause: This could be any hardware-related problem.

Solution: Check the hardware or call your service representative.

Message: Unexpected SW interrupt at address *hex-value*.  
Type (R)eboot, other keys to continue

Possible Cause: There is an error in the software program.

Solution: Try turning the system off and then on again. If that does not work, check the program.



Message:	Unexpected type 02 interrupt at address <i>hex-value</i> . Type (S)hut off NMI, (R)eboot, other keys to continue
Possible Cause:	There is an error in the software program.
Solution:	Try turning the system off and then on again. If that does not work, check the program.

### B.4 SYSTEM BOARD ERRORS

If the POST finds an error and cannot display a message on the monitor, the POST issues a series of beeps indicating the error and places a value in I/O port 80H.

For example, a failure of bit 3 in the first 64K of RAM is indicated by a 2-1-4 beep code (a burst of two beeps, a single beep, and a burst of four beeps). In addition, the POST writes a value to I/O port 80H to enable debugging tools to identify the area of failure.

Tables B-1 and B-2 list the beep codes and the values that the POST writes to I/O port 80H when it encounters error conditions. Table B-1 lists fatal errors (errors that halt the system). Table B-2 lists the non-fatal errors (errors that are not serious enough to halt the system). Both tables list other conditions that have no beep codes.

One beep code is not listed in Tables B-1 or B-2: a long beep followed by one or more short beeps indicates a video controller failure. No beep code is sounded if a test is aborted while in progress.

**Table B-1. Beep Codes for Fatal Errors**

Beep Code	Description of Error	Contents of I/O Port 80H
None	386SX CPU register test in progress	01H
1-1-3	Real-time clock write/read failure	02H
1-1-4	ROM BIOS checksum failure	03H
1-2-1	Programmable interval timer failure	04H
1-2-2	DMA initialization failure	05H
1-2-3	DMA page register write/read failure	06H
1-3-1	RAM refresh verification failure	08H
None	1st 64K RAM test in progress	09H
1-3-3	1st 64K RAM chip or data line failure multi-bit	0AH
1-3-4	1st 64K RAM odd/even logic failure	0BH
1-4-1	1st 64K RAM address line failure	0CH
1-4-2	1st 64K RAM parity test in progress or failure	0DH
2-1-1	Bit 0 1st 64K RAM failure	10H
2-1-2	Bit 1 1st 64K RAM failure	11H
2-1-3	Bit 2 1st 64K RAM failure	12H
2-1-4	Bit 3 1st 64K RAM failure	13H
2-2-1	Bit 4 1st 64K RAM failure	14H
2-2-2	Bit 5 1st 64K RAM failure	15H
2-2-3	Bit 6 1st 64K RAM failure	16H
2-2-4	Bit 7 1st 64K RAM failure	17H
2-3-1	Bit 8 1st 64K RAM failure	18H
2-3-2	Bit 9 1st 64K RAM failure	19H
2-3-3	Bit A 1st 64K RAM failure	1AH
2-3-4	Bit B 1st 64K RAM failure	1BH
2-4-1	Bit C 1st 64K RAM failure	1CH
2-4-2	Bit D 1st 64K RAM failure	1DH
2-4-3	Bit E 1st 64K RAM failure	1EH
2-4-4	Bit F 1st 64K RAM failure	1FH
3-1-1	Slave DMA register failure	20H
3-1-2	Master DMA register failure	21H
3-1-3	Master interrupt mask register failure	22H
3-1-4	Slave interrupt mask register failure	23H
None	Interrupt vector loading in progress	25H
3-2-4	Keyboard controller test failure	27H
None	Real-time clock power failure or checksum failure	28H

**Table B-2. Beep Codes for Non-fatal Errors**

<b>Beep Code</b>	<b>Description of Error</b>	<b>Contents of I/O Port 80H</b>
None	Real-time clock configuration	29H
3-3-4	Screen memory test failure	2BH
3-4-1	Screen initialization failure	2CH
3-4-2	Screen retrace test failure	2DH
None	Search for video ROM in progress	2EH
None	Screen running with video ROM	30H
None	Monochrome display operable	31H
None	Color display (40 column) operable	32H
None	Color display (80 column) operable	33H

## Equipment Log

# C

---

Use the equipment log forms in this appendix to record pertinent information about your system. You will need some of this information if you are running the setup program. The equipment log is also very useful in the event your system needs servicing. Be sure to update the equipment log when you add options.

The equipment log is also helpful if equipment is lost, stolen or damaged. The equipment log can serve as a warranty record of when the equipment was placed in service, and the dates of all equipment upgrades and configuration changes.

Record the model and serial numbers of the system components, dates of component removal and/or replacement, and the name of the vendor from whom the component or system was purchased. Be sure to include the same information for any components added to the system, such as fixed disk and floppy disk drives, expansion boards, or printers, etc.

Record the model and serial number of the system module, keylock keys, and 300SX board. The model and serial number of the system module is recorded on a label attached to the rear cover. The key for the keylock has a serial number engraved on it. The serial number of the 300SX board is located on the edge of the board next to the system jumpers.

The location of serial numbers on expansion boards, fixed and floppy disk drives, and external equipment (monitors, printers, etc.), varies from one manufacturer to another. Literature accompanying these products should illustrate or describe the location of model and serial numbers.

**Equipment Log Form**

<b>Component</b>	<b>Manufacturer Name and Model No.</b>	<b>Serial No.</b>	<b>Date Installed</b>
System Module			
System Board			
Monitor			
Keyboard			
Floppy Disk Drive 1			
Floppy Disk Drive 2			
Fixed Disk Drive 1			
Fixed Disk Drive 2			

**Equipment Log Form** (*continued*)

**Equipment Log Form** *(continued)*

<b>Component</b>	<b>Manufacturer Name and Model No.</b>	<b>Serial No.</b>	<b>Date Installed</b>
Key			



## Glossary

---

### A

#### A

Ampere.

#### AC

Alternating current. A current that periodically reverses its direction of flow.

#### accuracy

In scientific measurements, accuracy is the degree of conformity to an absolute standard. For example, a specification of  $+5V \pm 10\%$ , signifies how accurate  $+5V$  is with respect to the absolute volt as defined by the U.S. National Bureau of Standards or other governing standards organizations. Do not confuse accuracy with precision. Contrast with precision.

#### active high

Designates a signal that has to go high to produce an effect.

#### active low

Designates a signal that has to go low to produce an effect.

#### adapter

1. An auxiliary device or unit used to extend the operation of another system.
2. An electronic part used to connect two dissimilar parts or machines.

#### address

1. A name, label, or number identifying a location in storage, a device in a network, or any other data source.
2. A number that identifies the location of data in memory.

#### address bus

One or more conductors used to carry the binary-coded address from the processor throughout the rest of the system.

#### algorithm

A finite set of well-defined rules for the solution of a problem in a finite number of steps.



**ampere(A)**

The basic unit of electric current.

**analog**

Pertaining to data in the form of continuously variable physical quantities. Contrast with digital.

**application**

A program or set of programs used to do work on the computer. Some categories of application programs are word processors, database managers, spreadsheet managers, and project managers. Specific examples of application programs are MultiMate, dBase III PLUS, Lotus 1-2-3, Framework II, and Symphony.

**array**

An arrangement of elements in one or more dimensions.

**ASCII**

American Standard Code for Information Interchange. The code developed by ANSI for information interchange among data processing systems, data communications systems, and associated equipment. The ASCII character set consists of 7-bit control characters and symbolic characters.

**asynchronous**

In data communications, a method of transmission in which the bits included in a character or block of characters occur during a specific time interval. However, the start of each character or block of characters can occur at any time during this interval. Contrast with synchronous.

**AUTOEXEC.BAT**

A special-purpose batch file. When you turn on your computer, or restart it by pressing the **Ctrl** + **Alt** + **Del** combination, DOS searches the system disk for the AUTOEXEC.BAT file. If DOS finds one, it executes the commands in the file.

---

## B

**base address**

The beginning address for resolving symbolic references to locations in storage.

**base memory**

Up to 640K of memory accessible to DOS. This is also referred to as conventional memory. Contrast with expanded memory and extended memory.

**base register**

A general purpose register that the programmer chooses to contain a base address.

**BASIC**

A programming language that uses common English words.

**basic input/output system**

The feature of a computer that provides a basic level of control of the major I/O devices, and relieves programmers of having to learn about system hardware device characteristics.

See BIOS.

**batch file**

A file that saves time and effort and which is identified by the .BAT extension following the file name. If you use a sequence of DOS commands frequently, you can create a batch file containing the commands, and then execute the entire sequence by typing the name of the file. This reduces the number of keystrokes needed to execute a sequence of commands.

**binary**

1. Involving a choice of two conditions, such as on-off or yes-no.
2. Pertaining to a fixed radix numeration system having a radix of 2, wherein the binary digits are 0 and 1.

**BIOS**

The feature of a computer that provides a basic level of control of the major I/O devices, and relieves programmers of having to learn about system hardware device characteristics.

Acronym for basic input/output system.

**bit**

Synonym for binary digit. Either of the binary digits 0 or 1 used in computers to store information. (see also byte)

**bits per second (bps)**

A unit of measurement representing the number of discrete binary digits transmitted by a device in one second.

**board**

A rectangular piece of fiberglass that has pins on one side and electronic parts on the other; also called a card, PC board or PCB (printed circuit board). The system is always supplied with a system board. Other boards can include a video adapter board, a disk controller board, a network communication board, memory boards, and multifunction boards.

**boot**

(see bootstrap)

**bootstrap**

A technique or device designed to bring itself into a desired state by means of its own action; for example, a machine routine whose first few instructions are sufficient to bring the rest of itself into the computer from an input device. For example, a computer that runs DOS boots itself by causing the computer to read the first few of its instructions from disk. Those instructions are sufficient to read in the rest of DOS from disk.

**bps**

Bits per second.

**buffer**

1. An area of storage that is temporarily reserved for use in performing an input/output operation into which data is written or from which data is read. Synonymous with I/O area.
2. A portion of memory storage for temporarily holding input or output data.

**bus**

One or more conductors used for transmitting signals or power.

**byte**

1. A sequence of eight adjacent binary digits that are operated upon as a unit.
  2. A binary character operated upon as a unit.
  3. The amount of storage used to represent one character.
- 

## C

**C**

1. Celsius (centigrade).
2. A programming language.

**cache memory**

A small, high-speed memory block that improves CPU performance by minimizing the number of memory accesses on the bus. This action is accomplished by storing the CPU's most recently used data/instructions in the cache memory rather than main memory.

**card**

(see Board)

**CAS**

Column address strobe; a signal that latches the column addresses in a memory chip.

**Cathode ray tube (CRT)**

A vacuum tube in which a stream of electrons is projected onto a fluorescent screen producing a luminous spot. The location of the spot can be controlled. A CRT is the main element in a video display or monitor.

**Celsius (C)**

A temperature scale; also called Centigrade. Contrast with Fahrenheit .

**Central processing unit (CPU)**

Term for processing unit; i.e. 80386.

**CFR Part 15 Subpart J**

Federal Communications Commission Specification for EMI suppression.

**channel**

A path along which signals can be sent; for example, data channel, output channel.

**character**

A letter, digit, or other symbol.

**character generator**

1. In computer graphics, a functional unit that converts the coded representation of a graphics character into the shape of the character for display.
2. In word processing, the means within equipment for generating visual characters or symbols from coded sets.

**character key**

A keyboard key that allows the user to enter the character shown on the key. Compare with function key.

**character set**

A group of characters used for a specific reason; for example, the set of characters a printer can print or a keyboard can support.

**Class A device**

Broadly defined, a Class A device complies with the various regulatory agencies that certify equipment for operation in a commercial (office or factory) environment.

**Class B device**

Broadly defined, a Class B device complies with the various regulatory agencies that certify equipment for operation in a home or residential environment.

**CMOS**

Complementary metal oxide semiconductor. A logic circuit family that uses very little power. It works with a wide range of power supply voltages.

**COM1, COM2, COM3, COM4**

These are the names DOS assigns to the serial communications port(s). Some systems only provide one serial port; others provide two.

**CONFIG.SYS file**

A special-purpose file that provides DOS with information about the special kinds of hardware or software used with the computer. Whenever the computer is turned on or rebooted by pressing **Ctrl** + **Alt** + **Del**, DOS searches the system disk for the CONFIG.SYS file. If DOS finds one, it reads the commands from the file and uses them to prepare the computer for operation.

**configuration**

1. The arrangement of a computer system or network as defined by the nature, number, and chief characteristics of its functional units. More specifically, the term configuration may refer to a hardware configuration or a software configuration.
2. The devices and programs that make up a system, subsystem or network.

**connector**

A device allowing the connection of various electrical elements. See edge connector.

**conventional memory**

(see base memory)

**cps**

Characters per second.

**CPU**

Central processing unit.

**CRT**

Cathode ray tube.

**CSA 22.2 # 220**

Canadian Standards Association Standard for Safety of Information Processing and Business Equipment.

**cursor**

1. In computer graphics, a movable marker that is used to indicate position on a display.
2. A displayed symbol that acts as a marker to help the user locate a point in text, in a system command, or in storage.
3. A movable spot of light on the screen of a display device, usually indicating where the next character is to be entered, replaced, or deleted.

**cycle time**

Defines the minimum amount of time in which subsequent accesses to a DRAM device can occur.

**cylinder**

All fixed disk or diskette tracks that can be read or written without moving the disk drive or diskette drive read/write mechanism

---

## D

**data base**

A collection of data that can be immediately accessed and operated upon by a data processing system for a specific purpose.

**dB**

(see Decibel)

**DC**

Direct current.

**decibel**

1. A unit that expresses the ratio of two power levels on a logarithmic scale.
2. A unit for measuring relative power.

**Deutsche Industrie Norm (DIN)**

1. German Industrial Norm.
2. The committee that sets German dimension standards.

**diagnostic**

Pertaining to the detection and isolation of a malfunction or mistake.

**digital**

Pertaining to data in the form of digits. Contrast with analog.

**DIN**

Deutsche Industrie Norm.

**DIN connector**

One of the connectors specified by the DIN committee.

**DIP**

Dual in-line package. DIPs have pins in two parallel rows. The pins are spaced 1/10 inch apart. (See also DIP switch.)

**DIP switch**

One of a set of small switches mounted in a dual in-line package.

**direct current (dc)**

A current that always flows in one direction.

**direct memory access (DMA)**

A method of transferring data between main storage and I/O devices that does not require processor intervention.

**disable**

To stop the operation of a circuit or device; specifically applied to communications ports.

**disabled**

Pertaining to a state of a processing unit that prevents the occurrence of certain types of interruptions. Synonymous with masked.

**disk**

Loosely, a magnetic disk.

**disk drive**

A device for storing data on and retrieving data from a fixed disk or diskette.

**diskette**

A thin, flexible magnetic disk, permanently sealed in a protective jacket, that is used to store information. Synonymous with floppy and flexible disk. Most commonly available in 5.25-inch and 3.5-inch sizes.

**display**

1. A visual presentation of data.
2. A device for visual presentation of information on any temporary character imaging device.
3. To present data visually.
4. See cathode ray tube.

**DMA**

Direct memory access.

**DOS**

Disk Operating System. (see operating system)

**double precision**

Pertaining to the use of two computer words to represent a number in accordance with the required precision. Contrast with single precision.

**DRAM**

Dynamic RAM. A type of RAM comprised of capacitive cells that require periodic refresh to maintain data. While the DRAM is a slower than the SRAM, its cell is much smaller. This enables the DRAM to be a higher density device and generally less expensive.

**drop card**

Drop cards are expansion boards that gain extra surface area by dropping down immediately after the 8-bit edge connector. Drop cards are not compatible in 16-bit and 32-bit expansion slots because the dropped portion of the card interferes with the unused connectors in these longer slots.

**dual in-line package (DIP)**

A widely used container for an integrated circuit.

**dynamic memory**

Random access memory (RAM). Read/write memory. See DRAM.

---

## E

**edge connector**

A terminal block with a number of contacts attached to the edge of a printed-circuit board to facilitate plugging into a foundation circuit.

**EIA**

Electronic Industries Association.

**EMI**

Electromagnetic Interference.

**enable**

To initiate the operation of a circuit or device; specifically applied to communications ports.

**EPROM**

Erasable programmable read-only memory. A PROM that allows the user to change its code.

**E<sup>2</sup>PROM**

Electrically erasable programmable read-only memory. An EPROM which allows the user to change its code by means of appropriate electrical signals.

**ESDI**

Enhanced Small Device Interface, which achieves faster throughput than standard fixed-disk controllers by shifting functionality to the fixed-disk drive.

**expanded memory**

Certain expansion boards can provide additional memory to a personal computer. Expanded memory is distinguished from conventional memory in that it cannot be addressed directly by DOS but must be accessed through the expanded memory manager. It is used directly by application programs such as Symphony and Framework. Contrast with extended memory.

**expansion slot**

A series of connectors mounted on the system board into which expansion boards can be inserted. Depending upon the system model, the type and number of expansion slots will vary.

**extended memory**

Memory whose addresses start at 1M and which can be accessed only when the processor is running in protected mode. Extended memory can be used by operating systems, such as UNIX, that run in protected mode, and by certain DOS programs, such as the RAMDRIVE.SYS virtual disk, that switch in and out of protected mode to perform special operations. Ordinary DOS applications cannot directly access extended memory.

---

## F

**Fahrenheit (F)**

A temperature scale. Contrast with Celsius (C).

**falling edge**

Synonym for negative-going edge.



**fast paged mode**

A dynamic memory mode of operation that allows successive addresses to the same DRAM page (defined by the row addresses strobed (RAS) into the devices by simply changing the column addresses. In this mode, RAS is held active and the various accesses are initiated by strobing the new column addresses with the falling edge of CAS. The mode is available in CMOS parts and allows fewer cycle times.

**FCC**

Federal Communications Commission.

**field**

1. In a record, a specified area used for a particular category of data.
2. In a data base, the smallest unit of data that can be referred to by name.

**firmware**

1. Instructions or programs stored permanently in read-only memory (ROM) and unchangeable.
2. Internal connections that permanently determine the function of a device or system.

**fixed disk**

A nonflexible, flat, circular plate with a magnetizable surface layer on which data can be stored by magnetic recording. Synonymous with hard disk. Fixed disks are permanently mounted within a fixed-disk drive.

**fixed disk drive**

A computer unit that consists of nonremovable magnetic disks, and a device for storing and retrieving data from the disks. Synonymous with hard disk drive.

**flexible disk**

See diskette.

**floppy disk**

Synonym for flexible disk. See diskette.

**floppy disk drive**

A computer unit that can store and retrieve data from floppy disks. See diskette.

**function keys**

Keys that request actions but do not display or print characters. Included are the keys that normally produce a printed character, but when used with the code key produce a function instead. Compare with character key.

---

## G

### G

A symbol used to represent the prefix giga. When describing computer storage capacity, common usage has made G synonymous with GB, G-byte or gigabyte.

**GB**

Abbreviation for gigabyte.

**giga**

A prefix normally used to indicate a quantity of 1,000,000,000. However, when referring to computer storage capacity, the prefix giga represents a quantity of 1,073,741,824 or 2 raised to the 30th power.

**gigabyte**

A term used when referring to computer storage capacity. A gigabyte is defined as 1,073,741,824 bytes.

**gram (g)**

A unit of weight equivalent to 0.035 ounces.

**graphics**

A type of data created from fundamental drawing units such as lines, splines, curves, polygons, and so forth.

---

## H

**hard disk**

(See fixed disk.)

**hardware**

1. Physical equipment used in data processing, as opposed to programs, procedures, rules, and associated documentation.
2. Contrast with software.

**head**

A device that reads, writes, or erases data on a storage medium; for example, a small electromagnet used to read, write, or erase data on a magnetic disk.

**header**

A connector located on the system board. Usually consisting of one or more rows of evenly-spaced pins.

**Hertz (Hz)**

A unit of frequency equal to one cycle per second.

**hex**

Common abbreviation for hexadecimal.

### **hexadecimal**

1. Pertaining to a selection, choice, or condition that has 16 possible different values or states. These values or states are usually symbolized by the ten digits 0 through 9, and the six letters A through F.
2. Pertaining to a fixed radix numeration system having a radix of 16.

### **Hz**

See Hertz.

---

## **I**

### **icon**

Icon is a term used to describe graphic display symbols commonly used on video displays. A small symbol that can be easily identified with a device or function; e.g., a graphics symbol of a printer or keyboard. Selecting the icon will allow you to access the device or function it represents.

### **IEC 435**

TUV certified in accordance with International Electrotechnical Commissions Standard for Safety of Information Technology Equipment.

### **IEC 950**

TUV certified in accordance with International Electrotechnical Commissions Standard for Safety of Information Technology Equipment including Electrical Business Equipment.

### **input/output (I/O)**

1. Pertaining to a device or to a channel that may be involved in an input process and, at a different time, in an output process. Input/output may be used in place of input/output data, input/output signal, and input/output terminals, when such usage is clear in a given context.
2. Pertaining to a device whose parts can be performing an input process and an output process at the same time.
3. Pertaining to either input or output, or both.

### **instruction**

A statement that specifies an operation to be performed by the computer, along with the values or locations of operands, if any exist. This statement represents the programmer's request to the processor to perform a specific operation.

### **instruction set**

The set of instructions of a computer, of a programming language, or of the programming languages in a programming system.

### **interface**

A device that alters or converts actual electrical signals between distinct devices, programs, or systems.

**interleave**

To arrange parts of one sequence of things or events so that they alternate with parts of one or more other sequences of the same nature and so that each sequence retains its identity.

**interrupt**

1. A suspension of a process, such as the execution of a computer program, caused by an event external to that process and performed in such a way that the process can be resumed.
2. In a data transmission, to take an action at a receiving station that causes the transmitting station to terminate a transmission.
3. Synonymous with interruption.

**I/O**

Input/Output.

---

## K

**K**

A symbol used to represent kilobyte, a computer storage quantity representing 1024 bytes, wherein 1024 is equal to 2 raised to the 10th power. Common usage has made it synonymous with KB, Kbyte or kilobyte. See kilobyte. Contrast with k.

**k**

A symbol used to represent the prefix kilo; 1,000.

**KB**

Abbreviation for kilobyte.

**Kb**

A symbol used to represent kilobit, a computer storage quantity representing 1024 bits, wherein 1024 is equal to 2 raised to the 10th power.

**keylock**

A device that can deactivate a keyboard (if implemented) and locks the cover on for security.

**kilo**

A prefix used to indicate a quantity of 1000. Abbreviation symbol k. Contrast with K.

**kilobyte**

A term used when referring to computer storage capacity. A kilobyte is defined as 1024 bytes. *Note that in all other usages, the prefix kilo (k) indicates a quantity of 1,000.*

**kilogram (kg)**

1000 grams.

**kilohertz (kHz)**

1000 Hertz.

---

### L

**leading edge**

The first occurring edge of a pulse.

**LIM**

Lotus/Intel/Microsoft Expanded Memory Manager specification.

**LED**

Light-emitting diode.

**LPT1, LPT2, LPT3**

These are the names DOS assigns to the parallel printer ports in a system. The three names reflect the fact that DOS permits as many as three parallel printer ports in a system.

---

### M

**M**

A symbol used to represent the prefix mega. When describing computer storage capacity, common usage has made M synonymous with MB, Mbyte or megabyte. See mega.

**m**

1. Prefix milli; 0.001.
2. Meter.

**mA**

Milliampere; 0.001 ampere.

**machine language**

A language that can be used directly by a computer without intermediate processing.

**magnetic disk**

A flat circular plate with a magnetizable surface layer on which data can be stored by magnetic recording.

**main storage**

1. Program-addressable storage from which instructions and other data can be loaded directly into registers for subsequent execution or processing.
2. Contrast with mass storage.

**mapping**

Pertaining to the geographic location for a resource within the address space.

**masked**

Synonym for disabled.

**mass storage**

Auxiliary storage in a computer system as differentiated from RAM. Mass storage most commonly refers to floppy and fixed disks and magnetic tape.

**MB**

Abbreviation for megabyte.

**Mb**

A symbol used to represent megabit, a computer storage quantity representing 1,048,576 bits, wherein 1,048,576 is equal to 2 raised to the 20th power.

**mega**

A prefix normally used to indicate a quantity of 1,000,000. However, when referring to computer storage capacity, the prefix mega represents a quantity of 1,048,576 or 2 raised to the 20th power.

**megabyte**

A term used when referring to computer storage capacity. A megabyte is defined as 1,048,576 bytes.

**memory**

Storage on electric memory such as random access memory (RAM), read-only memory (ROM), or CPU registers.

**MFM**

Modified frequency modulation.

**MHz**

Megahertz; 1,000,000 Hertz.

**micro ( $\mu$ )**

Prefix 0.000 001.

**microprocessor**

An integrated circuit that accepts coded instructions for execution; the instructions may be entered, integrated, or stored internally.

**microsecond ( $\mu$ s)**

0.000 001 second.

**modified frequency modulation (MFM)**

The process of varying the amplitude and frequency of the write signal. MFM pertains to the number of bytes of storage that can be stored on the recording media. The number of bytes is twice the number contained in the same unit area of recording media at single density. MFM recording is commonly used on floppy- and fixed-disk drives.

**monitor**

1. A device for visual presentation of information as temporary images. A video display.
  2. Synonym for cathode ray tube display (CRT display).
- 

## N

**nanosecond (ns)**

0.000 000 001 second.

**negative-going edge**

The edge of a pulse or signal changing in a negative direction. Synonymous with falling edge.

**negative true**

Synonym for active low.

**network**

A group of computers connected and configured such that they can share resources.

**nonrecoverable error**

An error that makes recovery impossible without the use of recovery techniques external to the computer program run.

**ns**

nanosecond; 0.000 000 001 second.

---

## O

**OEM**

Original Equipment Manufacturer.

**offline**

Pertaining to the operation of a functional unit without the continual control of a computer.

**online**

Pertaining to the operation of a functional unit under the continual control of a computer.

**operating system**

Software that controls the execution of programs; an operating system may provide services such as resource allocation, scheduling, input/output control, and data management.

## P

### **paged mode**

The same basic functionality as fast paged-mode, except that the access time is the same as a normal RAS/CAS access. This mode is a feature on NMOS-type DRAM parts.

### **PAL**

Program array logic

### **parallel**

1. Pertaining to the concurrent or simultaneous operation of two or more devices, or to the concurrent performance of two or more activities.
2. Pertaining to the concurrent or simultaneous occurrence of two or more related activities in multiple devices or channels.
3. Pertaining to the simultaneity of two or more processes.
4. Pertaining to the simultaneous processing of the individual parts of a whole, such as the bits of a character and the characters of a word, using separate facilities for the various parts.
5. An alternative to serial.

### **parameter**

1. A variable that is given a constant value for a specified application and that may denote the application.
2. A name in a procedure that is used to refer to an argument passed to that procedure.

### **pel**

Picture element.

### **picture element (pel)**

In computer graphics, the smallest element of a display space that can be independently assigned color and intensity. Synonymous with pixel.

### **pixel**

The smallest displayable unit on a monitor or picture tube element. Synonymous with pel.

### **platform system**

A basic OEM product-line system which combines computers or computer subsystems with special, unique, and proprietary hardware and/or software for added value.

### **port**

An access point for data entry or exit.

### **positive-going edge**

The edge of a pulse or signal changing in a positive direction. Synonymous with rising edge.

### **positive true**

Synonym for active high.



### **POST**

Acronym for power-on self test.

### **power-on self test**

A series of diagnostic tests that are run each time the computer's power is turned on. See POST.

### **power supply**

A device that produces the power needed to operate electronic equipment.

### **precision**

In science, a measure of the ability to differentiate quantities; the degree of agreement of repeated measurements of a quantity. Not to be confused with accuracy.

### **printed circuit**

A pattern of conductors (corresponding to the wiring of an electronic circuit) formed on a board of insulating material.

### **printed-circuit board**

Usually a copper-clad fiberglass board used to make a printed circuit. Also, refers to a board on which a printed circuit has been made.

### **processing unit**

A functional unit that consists of one or more processors and all or part of internal memory.

### **processor**

1. In a computer, a functional unit that interprets and executes instructions.
2. A functional unit, a part of another unit such as a terminal or processing unit, that interprets and executes instructions. (see microprocessor)

### **program**

A file containing a set of instructions conforming to a particular programming language syntax.

### **PROM**

Programmable read-only memory. A type of ROM that contains a programmed set of code. A PROM code cannot be changed once programmed. See also EPROM, E<sup>2</sup>PROM and ROM.

### **protected mode**

A mode of the 80386 microprocessor enabling it to provide advanced features, such as accessing large amounts of memory and enforcing hardware protection of memory segments. Current versions of DOS do not support protected mode operation, except for special utilities such as the RAMDRIVE.SYS virtual disk.

---

## R

### **RAM**

Random access memory. Read/write memory.

**RAS**

Row address strobe; a technique used in dynamic RAM addressing.

**RAS/CAS**

A mode of DRAM operation where every access is begun by strobing the row addresses with RAS and column addresses with CAS.

**raster**

In computer graphics, a predetermined pattern of lines that provides uniform coverage of a display space.

**read**

To acquire or interpret data from a storage device, from a data medium, or from another source.

**read-only memory (ROM)**

A storage device whose contents cannot be modified. The memory is retained when power is removed.

**recoverable error**

An error condition that allows continued execution of a program.

**register**

1. A storage device, having a specified storage capacity such as a bit, a byte, or a computer word, and usually intended for a special purpose.
2. A storage device in which specific data is stored.

**reverse video**

A form of highlighting a character, field, or cursor by reversing the color of the character, field, or cursor with its background; for example, changing a red character on a black background to a black character on a red background.

**RFI**

Radio frequency interference.

**ROM**

Read-only memory. See also PROM, EPROM, and E<sup>2</sup>PROM.

**ROM BIOS**

The ROM resident basic input/output (BIOS) system which controls the major I/O devices in a computer system.

**RS-232C**

A standard by the Electronics Industries Association (EIA) for serial communication between computers and external equipment.

### S

#### **scratch disk**

A scratch disk is usually a formatted floppy disk that can be used for test purposes. A floppy disk that contains no information of value. If data on a scratch disk is lost or destroyed during tests, it is of no consequence.

#### **sector**

That part of a track or band on a magnetic drum, a magnetic disk, or a disk pack that can be accessed by the magnetic heads in the course of a predetermined rotational displacement of the particular device.

#### **serial**

1. Pertaining to the sequential performance of two or more activities in a single device. The modifiers serial and parallel usually refer to devices, as opposed to sequential and consecutive, which refer to processes.
2. Pertaining to the sequential or consecutive occurrence of two or more related activities in a single device or channel.
3. Pertaining to the sequential processing of the individual parts of a whole, using the same facilities for successive parts.
4. An alternative to parallel.

#### **setup**

1. In a computer that consists of an assembly of individual computing units, the arrangement of interconnections between the units, and the adjustments needed for the computer to operate.
2. The preparation of the system for normal operation.

#### **shadow memory**

A portion of RAM to which selected BIOS information is copied from ROM. This ROM-to-RAM copying technique is referred to as shadowing. Shadow memory is write-protected and often has the same addresses as the original ROM locations. Shadowing greatly enhances system performance because ROM information is available from fast 32-bit RAM chips instead of the slower ROM chips.

#### **signal**

A variation of physical quantity, used to convey data.

#### **SIMM**

Single in-line memory module. A small plug-in board containing nine DRAM chips. A SIMM DRAM chip is organized in a specific configuration; i.e. 256Kb × 1 or 1M × 1 organization. For example, eight 256Kb × 1 DRAM devices combine to form 256K of memory. The ninth device provides parity checking.

**single precision**

Pertaining to the use of one computer word to represent a number in accordance with the required precision. Contrast with double precision and precision.

**software**

1. Computer programs, procedures, and rules concerned with the operation of a data processing system.
2. Contrast with hardware.

**SRAM**

Static RAM. RAM comprised of static RAM chips. Unlike DRAMs, SRAMs require no refresh and are faster devices. The SRAM cell is larger than the DRAM cell and for this reason, SRAMs are lower density devices.

**static column**

A mode of operation of DRAM operation that allows successive accesses to the same DRAM page (defined by the row addresses initially strobed into the devices) by simply changing the column addresses. This mode differs from fast paged-mode because both RAS and CAS are held active, whereas CAS is strobed in fast paged-mode. The access time is limited to the address access time of the part as new column addresses are presented.

**static memory**

RAM using flip-flops as the memory elements. Data is retained as long as power is applied to the flip-flops. Contrast with dynamic memory.

**storage**

1. A storage device.
2. A device, or part of a device that can retain data.
3. The retention of data in a storage device.
4. The placement of data into a storage device.

**synchronization**

The process of adjusting the corresponding significant instants of two signals to obtain the desired phase relationship between these instants.

**synchronous**

1. Data transmission in which the time of transmission occurrence of each signal representing a bit is related to a fixed time frame.
2. Data transmission in which the sending and receiving devices are operating continuously at substantially the same frequency and are maintained in a desired phase relationship by means of correction.

Contrast with asynchronous.

### T

#### T

A symbol used to represent the prefix tera. When describing computer storage capacity, common usage has made T synonymous with TB, Tbyte or terabyte.

#### TB

Abbreviation for terabyte.

#### tera

A prefix normally used to indicate a quantity of 1,000,000,000,000. However, when referring to computer storage capacity, the prefix tera represents a quantity of 1,099,571,627,300 or 2 raised to the 40th power.

#### terabyte

A term used when referring to computer storage capacity. A terabyte is defined as 1,099,571,627,300 bytes.

#### tpi

Tracks per inch. A specification used in formatting floppy disks and fixed disks.

#### TTL

Transistor-transistor logic. A popular logic circuit family that uses multiple-emitter transistors.

#### track

1. The path or one of the set of paths, parallel to the reference edge on a data medium, associated with a single reading or writing component as the data medium moves past the component.
2. The portion of a moving data medium such as a drum, or disk, that is accessible to a given reading head position.

#### trailing edge

The second edge of a pulse.

#### TUV

Technischer Ueberwachungs-Verein. TUV is an testing organization that evaluates and certifies electronic data processing equipment to specific International safety standards.

#### typematic key

A key that repeats its function multiple times when held down.

---

## U

### **UL 478**

Underwriter Laboratories Standard for Safety of Information Processing and Business Equipment.

---

## V

### **v**

Volt.

### **VAC**

Volts (alternating current).

### **VDE 0806/IEC 380**

TUV certified in accordance with International Electrotechnical Commissions Standard for Safety of Electrical Energized Office Machines.

### **VDE 0871**

Verband Deutscher Electrotechnikes Specification for EMI Suppression.

### **VDC**

Volts (direct current).

### **video**

Computer data or graphics displayed on a CRT, monitor, or display.

### **video adapter**

A special board that provides a suitable interface between a computer and a video display device such as a CRT or monitor. A video controller.

### **video controller**

A special board that provides a suitable interface between a computer and a video display device such as a CRT or monitor. A video adapter.

### **video display**

A device for visual presentation of information as temporary images. A monitor. See also CRT.

### **virtual address**

A 32-bit address on the internal bus intended to be translated by memory management.

### **volt**

The basic unit of electric pressure. The potential that causes electrons to flow through a circuit.

## W

### W

Watt.

### **Watt (W)**

The basic unit of electric power.

### **word**

A character string or bit string considered as an entity in computer architecture.

### **write**

To make a permanent or transient recording of data in a storage device or on data medium.

### **write precompensation**

The varying of the timing of the head current from the outer tracks to the inner tracks of the diskette to keep a constant write signal.

# Index

---

16-bit expansion slots 1-13, 2-7  
speed 1-13  
387SX numeric coprocessor  
installing 2-26

---

## A

Analog monitor connector J5 A-11

---

## B

Battery connector J23 A-13  
Beep codes B-12  
BIOS  
shadow option 3-19  
BIOS mapping 1-11

---

## C

COM1 A-6  
COM2 A-6

CPU clock speed 4-17  
changing with keyboard 4-17  
slowing to 8 MHz 4-17

---

## D

Deturbo mode 4-17  
Digital (TTL) monitor  
connector J6 A-11  
Disk drive installation  
fixed 2-18  
Disk drives  
fixed 2-19, 2-20, 2-22, 4-10  
floppy 2-15, 4-10

---

## E

Equipment  
log 2-3, C-1  
log form C-2  
serial numbers C-1  
Error checking 5-5



- Expansion board
    - expansion slot cover 2-9
    - handling precautions 2-11
    - installation 2-9
    - insertion 2-12
    - recording serial number 2-11
  - Expansion slots
    - 16-bit 1-13, 2-7
    - connectors A-9
    - cover removal 2-14
    - locations 1-13
    - selection 1-13
    - types 1-13
  - Extended memory 1-9
- 

## F

- Fixed disk interface
  - connector J19 A-5
- Fixed disk drive
  - access indicator 4-2
  - boot partition 5-13
  - drive type 3-6
  - installation 2-19, 2-20
  - removal 2-22
  - troubleshooting 5-13
- Floppy disk drive
  - access indicator 4-3
  - installation 2-15
  - release button 4-3
  - removal 2-18
  - troubleshooting 5-12
- Floppy disk interface
  - connector J18 A-4
- Floppy disks
  - care and handling 4-11
  - insertion and removal
    - 3.5-inch 4-14
    - 5.25-inch 4-16
  - write protection 4-12

---

## I

- ISA bus connectors A-9
- 

## J

- J1 parallel port connector A-8
  - J2A serial port connector A-6
  - J2B serial port connector A-6
  - J3B keyboard connector A-13
  - J4 mouse connector A-14
  - J5 video interface connector A-11
  - J6 video interface connector A-11
  - J11 parallel port header A-8
  - J12 power supply header A-7
  - J13 serial port header A-7
  - J18 floppy disk interface
    - connector A-4
  - J19 fixed disk interface connector A-5
  - J21 speaker interface header A-13
  - J23 battery connector A-13
  - J24 keylock header A-15
  - Jumpers
    - changing settings 2-29
    - settings 2-31
- 

## K

- Keyboard 1-12
  - alphanumeric key group 4-6
  - alt key 4-7
  - backspace key 4-7
  - caps lock key 4-6
  - configuration 3-8
  - connection 2-34
  - connector J3B A-13
  - ctrl key 4-7

- cursor keys 4-8
- edit keys 4-8
- enter key 4-6
- escape key 4-6
- function keys 4-7
- indicator lights 4-8
- layout 4-4
- numeric keypad 4-8
- operating procedures 4-9
- sections 4-4
- shift key 4-6
- system reset 4-9
- tab key 4-7
- Keyboard lock 1-13
  - keys 4-2
- Keylock interface header J24 A-15

---

## M

- Maintenance 6-1
  - cleaning 6-3
  - monitor screen 6-3
  - moving 6-3
  - packing 6-4
- Mass storage peripherals 1-13
- Memory
  - base memory configuration 3-20
  - battery-backed 3-1
  - configuration 1-11
  - conventional 1-9
  - extended 1-9
- Monitor connection 2-34
- Monitor type jumper 2-31
- Monochrome monitors 2-31
- Mouse connection 2-35
- Mouse connector J4 A-14

---

## N

- Network server 2-34
- Numeric coprocessor 2-26
  - removal 2-27

---

## O

- Onboard RAM 1-10

---

## P

- Parallel port
  - connector J1 A-8
  - header J11 A-8
- Password
  - enable/clear jumper 2-32
  - initialization 3-17
- PC/AT expansion slots 2-7
- POST 2-37, 3-2
  - bootup screen 5-7
  - configuration error message 5-8
  - configuration errors 2-38
  - error beep codes 5-5
  - error messages 5-5
  - monitor error messages 5-11
  - no beep pattern or incorrect beep pattern 5-12
  - memory test 2-38
  - reboot routine 2-38
  - startup message 2-38
- POST and boot error messages
  - clock chip lost power B-3
  - CMOS checksum invalid B-3
  - disk C: failed initialization B-3
  - diskette drive 1 seek failure B-2
  - diskette read failure ... B-2

diskette subsystem reset failed B-3  
display adapter failed  
    using alternate B-3  
floppy disk drive 0 seek failure B-2  
gate A20 failure B-4  
hard disk configuration error B-4  
hard disk controller failure B-4  
hard disk failure B-4  
hard disk read failure ... B-4  
hex-value optional ROM bad  
    checksum = hex-value B-4  
incorrect configuration data in  
    CMOS B-3  
invalid configuration  
    information ... B-5  
keyboard clock line failure B-5  
keyboard controller failure B-5  
keyboard data line failure B-5  
keyboard is locked ... B-5  
keyboard stuck key failure B-5  
memory address line  
    failure at ... B-6  
memory data line failure at ... B-6  
memory double word logic  
    failure at ... B-6  
memory high address line  
    failure at ... B-6  
memory odd/even logic  
    failure at ... B-6  
memory parity failure at ... B-7  
memory size in CMOS invalid B-3  
memory write/read failure at ... B-7  
no boot device available ... B-7  
no boot sector on hard disk ... B-7  
no timer tick interrupt B-7  
not a boot floppy disk ... B-8  
shadow of system BIOS  
    failed ... B-8  
shadow of video BIOS failed ... B-8  
shutdown failure B-8  
time or date in CMOS is invalid B-3  
timer chip counter 2 failed B-9  
timer or interrupt controller bad B-9  
time-of-day clock stopped B-9  
time-of-day not set ... B-9

unexpected interrupt in protected  
    mode B-9  
POST and boot informational  
    messages  
        decreasing available memory B-10  
        hex-value base memory B-10  
        hex-value extended B-10  
        memory test terminated by  
        keystroke B-10  
        strike the F1 key to  
        continue, ... B-10  
POST and boot messages B-1  
POST error messages B-1  
Power  
    surge suppressor 5-4  
    voltage surges 5-4  
Power supply A-16  
    header J12 A-15  
Power-on self test 2-37

---

## R

RAM modes 1-9  
ROM 1-11  
Run-time messages  
    I/O card parity interrupt at address  
        hex-value ... B-11  
    Memory parity interrupt at address  
        hex-value ... B-11  
    unexpected HW interrupt at  
        address hex-value ... B-11  
    unexpected SW interrupt at address  
        hex-value ... B-11  
    unexpected type 02 interrupt at  
        address hex-value ... B-12

---

## S

- Serial port
  - connectors A-6
  - header J13 A-6
- Setup program 2-20, 3-1
  - change options 3-4
  - date option 3-5
  - display options 3-7
  - drive type 3-6
  - enter Setup selection 3-11
  - exit 3-4, 3-21
  - fixed disk drives 3-6
  - floppy disk options 3-6
  - keyboard option 3-8
  - memory above 512K 3-20
  - onboard video display
    - controller 3-11
  - operations 3-2
  - POST 3-2
  - running 3-2
  - Screen 1 3-3
  - Screen 2 3-10
  - Screen 3 3-19
  - shadowing options 3-19
  - speaker 3-11
  - stored information 3-1
  - system password 3-17
  - time option 3-5
- Shadow memory 3-19
- SIMM sockets 1-10
- SIMMs 1-10
  - installing 2-23
- Site selection 2-1
- Speaker interface header J21 A-13
- Surge protection 2-35
- System
  - BIOS 1-11
  - bootup prompts 5-8
  - error messages B-1
  - initial operation 2-37
  - keyboard 4-3
  - optional features 1-6
  - password 1-13
  - reboot procedure 2-38
  - specifications A-1
- System board
  - connectors A-1
  - errors B-12
  - jumper settings 2-28
  - operating systems 1-2
  - ROM 1-11
  - serial number C-1
- System components 2-2
- System configuration 3-1
- System cover
  - installing 2-6
- System module
  - controls and indicators 4-2
  - disk drives 4-10
  - keyboard lock 4-2
  - power cord 2-35
  - power indicator 4-3
  - power push button 4-3
  - reset button 4-3
  - security features 1-13
  - serial number C-1

---

## T

- Tools 2-2
- Troubleshooting 5-1
  - application programs 5-2
  - equipment failure 5-3
  - general procedures 5-6
  - initial system startup 5-2
  - power problems 5-4
  - problem solving 5-1
  - remedial actions 5-9
- Turbo mode 4-17

---

**V**

- Video display controller
  - configuration 3-8
  - video difficulties 5-11
- Video interface connectors A-11
- Voltage surges 5-4



INTEL CORPORATION  
3065 Bowers Avenue  
Santa Clara, CA 95052-8130