

2100

CONTENTS

SECTION 4 THEORY

SECTION 5 MAINTENANCE

5.1 INTRODUCTION

5.2 SERVICE AND MAINTENANCE INFORMATION

5.3 CALIBRATION PROCEDURE

SECTION 6 REPLACEABLE PARTS

6.1 INTRODUCTION

6.2 MANUFACTURERS CODE

PARTS LIST

SECTION 7 SCHEMATICS

SECTION 8 OPTIONS

NOTE

SECTION 1 GENERAL INFORMATION

SECTION 2 PREPARATION FOR USE

SECTION 3 OPERATION

ARE FOUND IN THE "OPERATION MANUAL" SHIPPED  
WITH THE MODEL 2100

## THEORY OF OPERATION

The Model 2100 circuits are divided among four main circuit boards. They are:

- 1) The front panel board
- 2) The microprocessor board
- 3) The RF/IF board
- 4) The power supply board

In addition, the LCD display boards are mounted on the front panel metalwork and communicate with the microprocessor board via a ribbon cable.

The rear panel location of the power transformer and five volt regulator aids in heat dissipation.

The microprocessor board monitors the front panel keypad for new entry data. Valid entries are evaluated by the software on the microprocessor board which in turn programs the circuits on the RF/IF board and controls the front panel visual indicators.

## RF/IF BOARD

Refer to the RF/IF board schematic in Section 7. In receive mode, RF arriving at the antenna input is coupled to the U203 and mixer MX202. U203 is a divide by 256 circuit whose output is sent to the RF counter circuitry. Mixer MX202 combines the RF input with a signal between 1 and 1023 MHz provided by a single oscillator or by two oscillators, depending on the frequency setting programmed on the front panel.

In the receive mode, when frequencies higher than 492 MHz are programmed, oscillator 1 (CR229, CR230, and related circuitry) is set to be 16 MHz above the RF setting (in even 1 MHz steps) and MX202 mixes the two signals to produce a first IF between 16 and 17 MHz. Below 492 MHz oscillator 3 (fixed at 1024 MHz) is added to the first oscillator via mixer MX203 to extend the frequency downward so the 16 to 17 MHz IF can be maintained in the low frequency range of the instrument.

Bandpass filter Q209 removes the unwanted products of the combined signals and the result is mixed with a 5.545 to 6.5449 MHz signal from oscillator 2 at MX201.

Oscillator 2 (CR201, U201 and related circuitry) provides 100 Hz step size increments. It's frequency is calculated to produce a 10.455 kHz second IF frequency when mixed with the 16 to 17 MHz first IF. Bandpass amplifier Q207 and Q208 filters and boosts this signal before driving the receive chip U202. The receive chip performs numerous functions which include demodulating and squelching the audio, providing a frequency error signal and indicating the signal strength.

## THEORY OF OPERATION

The Model 2100 circuits are divided among four main circuit boards. They are:

- 1) The front panel board
- 2) The microprocessor board
- 3) The RF/IF board
- 4) The power supply board

In addition, the LCD display boards are mounted on the front panel metal-work and communicate with the microprocessor board via a ribbon cable.

The rear panel location of the power transformer and five volt regulator aids in heat dissipation.

The microprocessor board monitors the front panel keypad for new entry data. Valid entries are evaluated by the software on the microprocessor board which in turn programs the circuits on the RF/IF board and controls the front panel visual indicators.

## RF/IF BOARD

Refer to the RF/IF board schematic in Section 7. In receive mode, RF arriving at the antenna input is coupled to the U203 and mixer MX202. U203 is a divide by 256 circuit whose output is sent to the RF counter circuitry. Mixer MX202 combines the RF input with a signal between 1 and 1023 MHz provided by a single oscillator or by two oscillators, depending on the frequency setting programmed on the front panel.

In the receive mode, when frequencies higher than 492 MHz are programmed, oscillator 1 (CR229, CR230, and related circuitry) is set to be 16 MHz above the RF setting (in even 1 MHz steps) and MX202 mixes the two signals to produce a first IF between 16 and 17 MHz. Below 492 MHz oscillator 3 (fixed at 1024 MHz) is added to the first oscillator via mixer MX203 to extend the frequency downward so the 16 to 17 MHz IF can be maintained in the low frequency range of the instrument.

Bandpass filter Q209 removes the unwanted products of the combined signals and the result is mixed with a 5.545 to 6.5449 MHz signal from oscillator 2 at MX201.

Oscillator 2 (CR201, U201 and related circuitry) provides 100 Hz step size increments. It's frequency is calculated to produce a 10.455 kHz second IF frequency when mixed with the 16 to 17 MHz first IF. Bandpass amplifier Q207 and Q208 filters and boosts this signal before driving the receive chip U202. The receive chip performs numerous functions which include demodulating and squelching the audio, providing a frequency error signal and indicating the signal strength.

When the instrument is powered from the AC mains, the fuse/line voltage assembly on the rear panel must be configured for the proper primary windings selection and fuse size. CR1, CR2, C1, and C2 form a half-wave rectifier which provides approximately 18 volts to voltage regulator U1 and its related transistor via diode CR4. When the power switch is on, this is converted to + and -15 volts by the DC to DC converter and to +5 volts by regulator U2.

A regulator uses current from the line voltage rectifier to charge the (optional) internal battery. In the "RUN" mode, limiting resistor R3 allows for a trickle charge. In the "CHARGE" mode, a lower value resistor (R2) is switched in parallel with R3 and the battery is fast charged.

Diode CR5 isolates the internal battery from the external DC input. When the external voltage is sufficiently high enough (depending on battery option and state of battery), CR5 is forward biased and the external voltage drives the DC to DC converter and the 5 volt regulator.

The (optional) internal battery powers the instrument through CR6 when no line voltage or external DC voltage is connected to the instrument.

#### FRONT PANEL DESCRIPTION

The Model 2100 front panel holds the keyboard, the various analog controls, the indicator LEDs and the LCD display assemblies.

Each LCD assembly is modular in construction and is replaced as a unit, should failure occur. The remaining circuitry consist of passive controls or indicators. Refer to the microprocessor board schematic or the RF/IF board schematics in Section 7 for specific details.

5.1 INTRODUCTION

This section provides information for disassembling, testing, calibrating and troubleshooting the Model 2100 Service Monitor. Measurements and adjustments will be facilitated by placing the instrument so that the front panel faces the user.

5.2 SERVICE AND MAINTENANCE INFORMATION

5.2.1 In-Field Service

Should the Model 2100 require service, contact the Customer Service Department at (800) 245-6356 for assistance.

5.2.2 Disassembly Information

**WARNING**

To reduce the risk of electrical shock, turn off the instrument and remove the AC main supply before disassembly.

Removal of the top cover allows access to all parts inside the Model 2100.

**NOTE**

Not all harness connectors are keyed. Note connector orientations before disconnecting any harnesses.

To remove the instrument top cover, remove the six screws (three on each side) securing the top cover and lift the cover off.

To remove the individual circuit boards, remove the hardware (typically phillips head screws) that attach the boards to the studs in the metal work. Removal of the front panel board requires removal of the control knobs.

TABLE OF CONTENTS

5.3.1 INTRODUCTION

5.3.2 REQUIRED TEST EQUIPMENT

5.3.3 CALIBRATION PROCEDURE

- I Power Supply
- II Audio Synthesizer
- III SINAD Meter
- IV Voltmeter
  - a) DC Voltmeter
  - b) AC Voltmeter
- V Markers
  - a) 5 kHz
  - b) 600 Hz
- VI Generate
  - a) Spurs
  - b) Flatness
  - c) Pads and RF Level Pot
  - d) Residual
  - e) Modulation
  - f) Bandwidth
- VII Receiver
  - a) Time Base
  - b) Sensitivity
  - c) Receive Level
  - d) Modulation
- VIII Counter
  - a) Audio Thru Receiver
  - b) Subtone
  - c) Audio
  - d) Subtone
  - e) Frequency Error
  - f) RF Counter
- IX Wattmeter

5.3.4 CALIBRATION TEST RECORD

### 5.3.1 INTRODUCTION

The purpose of the calibration procedure in this section is to verify that the Service Monitor meets its published specifications (Section 1.2). Individual tests describe the method of testing, a list of equipment required, and a brief test procedure.

Critical specifications for each item of test equipment are listed in Section 5.3.2, Recommended Test Equipment. Except as detailed, settings of test equipment apply to calibration test procedures. All other test equipment operating details are omitted.

Before applying power to the Service Monitor, see Section 2 for details of electrical installation. The line voltage should be maintained at 115 or 230 volts  $\pm 10\%$ , 50 to 60 Hz  $\pm 5\%$  throughout the test. The performance test procedures are begun after a 15-minute minimum warmup of the Service Monitor in a  $+20$  degree to  $+30$  degree C ambient temperature range.

A copy of the Calibration Test Record is provided at the end of this section for convenience in recording the performance of the Service Monitor. It can be filled out and used as a permanent record for incoming inspection, or it can be used as a guide for routine performance testing. The Calibration Test Record lists the section, test, and specification limits. All tests refer to this record.

### 5.3.2 REQUIRED TEST EQUIPMENT

#### A. At the Bench

The following equipment is required by the technician during the Calibration Test Procedure.

1. Signal Generator: A Wavetek Model 3010 (or equivalent) referenced to 10 MHz house standard.
2. DVM: A Fluke Model 8010 or equivalent type DVM.
3. Variable frequency audio function generator: Wavetek Model 180/182 or equivalent.
4. SINAD Test Set: Helper Instruments Model S101 and accompanying interconnect devices.
5. Oscilloscope: Tektronix 2213 or equivalent.

B. Additional Test Equipment

The following equipment should be available to the technician with appropriate cables.

1. Spectrum Analyzer: Hewlett Packard Model 8558 or equivalent.
2. Modulation Analyzer: Hewlett Packard Model 8901 or equivalent.
3. RF Power Source: VHF and UHF high and low power source and wattmeter.
4. Audio Analyzer: HP 8903A or equivalent.



I Power Supply

Turn on Unit. Using DVM, measure power supply voltages at the top connector of the Power Supply Board and record.

+ 5V \_\_\_\_\_ ( $\pm 0.2$ VDC)  
 -15V \_\_\_\_\_ ( $\pm 0.2$ VDC)  
 +15V \_\_\_\_\_ ( $\pm 0.2$ VDC)

Check DC-to-DC converter voltage on lower leg of R44 (micro board) and adjust if necessary using R9 on power supply board and record. Larger (Semiconductor Circuits, Inc.) DC-to-DC converter requires 16.0V  $\pm 0.1$ V. Smaller (Conversion Devices, Inc.) requires 13.5V  $\pm 0.1$ V.

Smaller +13.5V, Larger +16.0 \_\_\_\_\_ ( $\pm 0.1$ VDC)

Turn Unit off and switch rear-panel switch to CHG position. Turn Unit on and measure voltage on anode side of CR3. If necessary, adjust R6 on power supply board for 15V and record.

+15V \_\_\_\_\_ ( $\pm 0.2$ VDC)

Turn Unit off, switch R/P switch back to OPER position. Remove AC line cord. Remove one of the external battery clip leads. Plug battery into EXT plug on rear panel. Reconnect external battery terminal lead. Turn Unit on and check that it powers up. Turn unit off. Remove external battery terminal lead and the external plug from the rear panel. Plug AC line cord in. Turn Unit back on.

Ext Batt Check \_\_\_\_\_ (X)

II AUDIO SYNTH

Unit in GEN, AUDIO SYNTH on. Set Rate to 1 kHz, adjust AUDIO SYNTH Level Pot fully clockwise. Set Deviation Control Knob halfway, cable AUDIO SYNTH OUT to 0-scope. Cable SCOPE TRIGGER out from rear panel of 2100 to EXT SYNC input on scope and adjust scope sync. Check for 1 kHz signal of 3.9V p-p on scope and record.

3.9V p-p \_\_\_\_\_ ( $\pm 0.3$ )

Change AUDIO SYNTH frequency to 10 Hz. Check that level stays within  $\pm 0.3V$  p-p tolerance. Repeat for 10 kHz.

10 Hz & 10 kHz      3.9V p-p ( $\pm 0.3$ ) \_\_\_\_\_ (X)

### III SINAD Meter

Activate 1 kHz SOURCE, cable DEMOD OUT to O-scope. Adjust Level Pot for 1V p-p signal on scope, cable DEMOD OUT to SINAD/AUDIO IN, press SINAD button twice, and check notch for  $>30$  dB reading. If necessary, adjust R101 and R104 on the microprocessor board for  $>30$  dB reading.

Notch  $>30$  dB \_\_\_\_\_ (X)

Press DEV button, activate 1 kHz SOURCE, adjust 1 kHz LEVEL POT for 5 kHz deviation. Turn Off 1 kHz SOURCE and turn AUDIO SYNTH On, set AUDIO SYNTH frequency to 3333 Hz and adjust AUDIO SYNTH LEVEL for 1240 Hz deviation on Unit. Cable DEMOD OUT to SINAD/AUDIO IN and activate 1 kHz AUDIO button. Activate SINAD button and check for 12 dB reading and record. Adjust R111 on micro board if necessary. (Set at 10 dB for a cold Unit, 11 dB for a warm unit without cover.)

12 dB  $\pm 1$  dB \_\_\_\_\_ (X)

### IV Voltmeter

#### A) DC Voltmeter

Turn off 1 kHz AUDIO and AUDIO SYNTH, activate VOLTS button. Connect BNC cable with alligator clips on other end to AUDIO IN connector. Clip leads to power supply voltages on RF Board and compare readings with those recorded in step I. Adjust R66 (gain) and R71 (offset) on the Microprocessor Board if necessary. Record readings.

15V \_\_\_\_\_ ( $\pm 0.75VDC$ )

#### B) AC Voltmeter

Cable External Function Generator to Digital Voltmeter, set Digital Voltmeter to read AC Volts, set Function Generator frequency to 1 kHz at 7.07 volts RMS as read on the Digital Voltmeter. Cable the Frequency Generator Output to AUDIO IN on the Unit, press the VOLTS button on the Unit twice to read AC volts peak. Unit should read 10 volts peak  $\pm 0.5V$ . Check Unit voltmeter with a 10 Hz frequency and a 10 kHz frequency applied. If necessary, adjust Gain pot (R66) on Microprocessor Board to bring AC and DC volts into spec. If R66 adjusted, then recheck DC voltmeter Step IV A. Record 10 kHz reading.

10 kHz & 10V peak \_\_\_\_\_ ( $\pm 0.5V$ )

V Markers

A) 5 kHz

Unit in GEN, 1 kHz AUDIO SOURCE on, 5 kHz markers on, cable DEMOD OUT on Unit to O-scope, set Vertical on O-scope to 0.2V/Div. Adjust 1 kHz modulation source level for 5 kHz deviation. Adjust R49 and R51 so that markers are coincident with  $\pm$  peaks of demod signal. Markers should be  $\pm 0.7V \pm 0.05$  from zero reference line.

+0.7  $\pm$  0.05V \_\_\_\_\_ (X)  
-0.7  $\pm$  0.05V \_\_\_\_\_ (X)

Dev Button

B) 600 Hz

Press Marker Button to turn on 600 Hz MARKERS, adjust 1kHz modulation source until peaks touch markers. The deviation display should read 600 Hz  $\pm 60$  Hz. Record.

600 Hz \_\_\_\_\_ (  $\pm 60$  Hz)

NO ADJUST.

VI Generate

A) Spurs

Set Unit to X1 mV, Max RF level, no modulation, Generate. Cable RF OUT to Spectrum Analyzer. Check for spurs from Carrier Frequency to  $\pm 300$  kHz at 150.5 MHz, 480.5 MHz, and 812.5 MHz. Spurs must be 35 dB below carrier.

150.5 MHz \_\_\_\_\_  $< -35$  dBc  
480.5 MHz \_\_\_\_\_  $< -35$  dBc  
812.5 MHz \_\_\_\_\_  $< -35$  dBc

B) Flatness

Set Unit to X1 mV, Max RF level, GEN, No modulation. Cable RF OUT to Spectrum Analyzer. Set up Spectrum Analyzer to view 1 MHz to 1000 MHz span. Set RF STEP on 2100 to 10 MHz per increment, step RF output frequency across band, using and starting at 1 MHz. RF level must stay within  $\pm 3$  dB. Repeat for X.1 mV and X10  $\mu$ V.

X1.0 mV \_\_\_\_\_ (X)  
X0.1 mV \_\_\_\_\_ (X)  
X10  $\mu$ V \_\_\_\_\_ (X)

C) Pads and RF Level Pot (20 dB Drop)

Place knob pointer on Indicator dot when pot fully CW, tighten down with Allen head driver. Adjust trim pot on back side of front panel for 20 dB drop over full range of pot as seen on \BP Spectrum Analyzer. Check the X1 mV, X.1 mV, X10  $\mu$ V pads and the RF Level Pot for 20 dB drop  $\pm 2$  dB at 150.5 MHz, 480.5 MHz and 812.5 MHz.

X1 mV	+2 dB	_____	(X)
X.1 mV	+2 dB	_____	(X)
X10 uV	+2 dB	_____	(X)
RF Level Pot	+2 dB	_____	(X)
Knob Fastened		_____	(X)

D) Residual

Unit in Gen, 150.5 MHz, 10 mV RF OUT, cable RF IN/OUT connector to Modulation Analyzer. Enable 300 Hz and 3 kHz filters on the Modulation Analyzer front panel. Set Modulation Analyzer to read FM and press AVG Deviation button. Record FM residual. Check at 480.5 and 812.5 MHz.

150.5	_____	< 100 Hz
480.5	_____	< 100 Hz
812.5	_____	< 100 Hz

E) Modulation

Dev  
Button →

Set Unit to 150.4550 MHz. Turn on AUDIO SYNTH, set to 5 kHz deviation at a rate of 1 kHz. Cable RF IN/OUT to Modulation Analyzer set to FM, AVG Deviation, 300 Hz and 3 kHz filters On. Reading should be (3.54kHz). Adjust FM GEN pot (R301) on RF board, if necessary.

Dev Button

R370

150.455 \_\_\_\_\_ 3.54 kHz

Activate Relative dB button on Modulation Analyzer, set Unit to 150.4551 MHz, and check relative dB reading.

150.4551 \_\_\_\_\_ (+0.5 dB)

Set Unit to 150 MHz, program 150 MHz into Modulation Analyzer, and check relative dB reading.

150.00 \_\_\_\_\_ (+0.5 dB)

F) Bandwidth

Unit in GEN, 150.455 MHz, AUDIO SYNTH on, Audio Rate set to 1 kHz, RF OUT Cabled to Modulation Analyzer, 300 Hz and 3 kHz filters off, 15 kHz filter on, Relative dB off, AVG dB on. Adjust AUDIO SYNTH for 5 kHz Dev as read on Unit. Press Relative dB button on Modulation Analyzer to zero reading. Set AUDIO SYNTH Frequency Rate to 10 Hz and adjust Deviation on Unit for 5 kHz Dev. Record reading on Modulation Analyzer, reading should be 0 ±1.5 dB. Set Unit AUDIO SYNTH to 10 kHz and check Relative dB reading on Modulation Analyzer.

Repeat step, using Function Generator in place of 2100 Audio Synthesizer by turning Unit AUDIO SYNTH off and EXT on. Cable Function Generator Out to MOD IN on Unit.

10 Hz - 10 kHz AUDIO SYNTH \_\_\_\_\_ / \_\_\_\_\_ (+1.5 dB)  
10 Hz - 10 kHz EXT Source \_\_\_\_\_ / \_\_\_\_\_ (+1.5 dB)

VII Receiver

A) Time Base

Set Sig Gen for 999.5 MHz, no modulation, 1 mV RF Out. Cable Sig Gen RF Out to Unit ANTENNA, Unit in REC, 999.5 MHz, FREQ ERROR on, adjust TCXO for 0 Hz error  $\pm 20$  Hz.

Frequency Error \_\_\_\_\_ (0  $\pm 100$  Hz) [Unit Spec.]

B) Automatic Gain Control (AGC)

Clip voltmeter on pin 1 or U230, set Sig Gen to 150.5 MHz, 2.7mV RF level, cable Sig Gen to unit antenna, unit set to 150.5 MHz, Rec, adjust R367 (2k pot) so that AGC circuit is just at the threshold of activation as seen on the voltmeter. Voltmeter will read  $>14V$  when AGC circuit is not activated. Adjust 2k pot to the point where the AGC voltage just begins to drop. Set Sig Gen to 600 Hz Dev, 1 kHz rate. Demod out to O-scope 600 Hz markers on. Check pin 1 of U230 on the RF board for  $>14V$ . Increase RF output of Sig Gen to 10 mV. Check pin 1 of U230 for  $<14v$ . Increase RF output of Sig Gen to 1V. Check that 600 Hz Dev signal does not distort to  $>750$  Hz Dev. Repeat for 480.5 Mhz and 812.5 MHz.

AGC  $>14V$  \_\_\_\_\_ (X)  
AGC  $<14V$  \_\_\_\_\_ (X)  
 $<750$  Hz \_\_\_\_\_ (X)

C) Sensitivity

Unit in Rec, 150.5 MHz, connect External Sinad meter to DEMOD OUT, set Sig Gen for 5 kHz Deviation, using the Sig Gen's Internal 1 kHz Source. Cable Sig Gen RF Out to the Unit's ANTENNA, lower RF Level of Sig Gen to result in 10 dB of Sinad on the external sinad meter. Sig Gen RF level should be less than 2uV. Check at 480.5 MHz and 812.5 MHz.

150.5 MHz \_\_\_\_\_  $< 2.0$  uV  
480.5 MHz \_\_\_\_\_  $< 2.0$  uV  
812.5 MHz \_\_\_\_\_  $< 2.0$  uV

D) Receive level 10 uV - 3 mV

Unit in Rec, 480.5 MHz, REC LEVEL Enabled, Set Sig Gen to 480.5 MHz, 10uV RF Output. Cable Sig Gen to Unit ANTENNA and adjust (10 uV) Signal Strength pot (R297) on RF board for 10 uV. Set Sig Gen to 3 mV RF Output level and adjust 3 mV pot (R293) for 2984uV-3148uV, recheck 10 uV level. Repeat for 150.5 MHz and 812.5 MHz.

10 - 3 mV \_\_\_\_\_  
Check  $<14$  @ 10 uV,  $<4500$  @ 3 mV  $\pm 1$  dB 480.5 MHz \_\_\_\_\_ (X)  
Check  $> 7$  @ 10 uV,  $>2100$  @ 3 mV  $\pm 3$  dB 150.5 MHz \_\_\_\_\_ (X)  
 $\pm 3$  dB 812.5 MHz \_\_\_\_\_ (X)

E) Modulation  
1) Unit in REC, AUDIO SYNTH On, AUDIO SYNTH frequency set to 1 kHz, cable AUDIO SYNTH OUT to Sig Gen Ext Audio In. Set Sig Gen to 480.5 MHz, 1 mV RF OUT. Cable RF Out to Modulation Analyzer, 300 Hz and 3 kHz filters on. Adjust Deviation level on Sig Gen for 5 kHz dev (3.54) as read on Modulation Analyzer. Cable Sig Gen RF OUT to Unit. Set Unit to 480.5 MHz, DEV Enabled, Cable Demod out to scope, FM markers on. Adjust Receive Level pot (R289 on RF board) for 5 kHz Dev. Attach Scope probe to center tap of R289 and adjust FM offset pot (R268) to achieve a centered trace.

5 kHz \_\_\_\_\_  $\pm 200$  Hz

2) Repeat for 10 kHz deviation (7.07 on Modulation Analyzer)

10 kHz \_\_\_\_\_  $\pm 1000$  Hz on Unit

3) Bandwidth  
Unit in REC, 480.5 MHz, AUDIO SYNTH on, AUDIO FREQUENCY set to 10 Hz, AUDIO SYNTH OUT cabled to Sig Gen. Sig Gen at 1 mV RF Out, adjust Sig Gen Deviation for 3.54 on Modulation Analyzer. Mod Analyzer in Avg dB mode, 300 Hz and 3 kHz filters off, 15 kHz filter on. Cable Sig Gen RF Out to Unit ANTENNA, check Receiver Deviation, Unit should read  $>3500$  Hz Dev or ( $\pm 30\%$ ). Change AUDIO SYNTH frequency to 10 kHz, repeat above procedure and record results.

10 Hz - 10 kHz, 5 kHz DEV \_\_\_\_\_  $\pm 1100$  Hz

#### VIII Counter

A) Audio Through Receiver  
Unit in REC, AUDIO SYNTH On, Cable AUDIO SYNTH OUT to Sig Gen Ext Mod In, Sig Gen at 480.5 MHz, 1 mV RF Out, 3 kHz Dev, Set Audio Synth on 2100 to 270 Hz, AUDIO FREQUENCY COUNTER On, Record Unit Audio Counter. Repeat with AUDIO SYNTH set to 10 kHz.

**NOTE:** It is difficult to change AUDIO SYNTH Frequency with the Audio Frequency Counter On.

270 Hz - 10 kHz  
<1 kHz \_\_\_\_\_  $\pm 3$  Hz  
>1 kHz \_\_\_\_\_  $\pm 1$  Hz

B) Subtone (through receiver)  
Unit REC, AUDIO SYNTH On, Cable AUDIO SYNTH OUT to Sig Gen Ext Mod In, Sig Gen at 480.5 MHz, 1 mV, 600 Hz Dev, Set AUDIO SYNTH on 2100 to 60 Hz. Turn on SUBTONE COUNTER and Record Unit Subtone Counter reading. Repeat with AUDIO SYNTH set to 240 Hz.

60 Hz - 240 Hz \_\_\_\_\_  $\pm 0.4$  Hz

C) Audio (through Audio In)  
Unit in GEN. AUDIO SYNTH on, set AUDIO SYNTH LEVEL to 0.5v p-p, cable AUDIO SYNTH OUT into AUDIO IN, AUDIO COUNT Enabled. Vary AUDIO SYNTH from 10 Hz to 20 kHz. (Use an external source to obtain 20 kHz.) Record Unit Audio Counter.

270 Hz - 20 kHz \_\_\_\_\_  $\pm 1$  Hz

D) Subtone (through Audio In)  
Unit in Gen. AUDIO SYNTH on, set AUDIO SYNTH to 1.0v p-p, 60 Hz rate, cable AUDIO SYNTH OUT into AUDIO IN, AUDIO COUNT On. Record Unit Subtone Count. Repeat with AUDIO SYNTH rate set to 250 Hz.

60 Hz - 250 Hz \_\_\_\_\_  $\pm 0.4$  Hz

E) Frequency Error  
Set Sig Gen for 999.5 MHz, 10 mV, no modulation. Cable Sig Gen to Unit. Unit set to 999.5 MHz, Rec, FREQ ERROR Enabled. Offset Sig Gen carrier frequency from 100 Hz to 10 kHz in successive steps. Unit should track frequency error  $\pm 200$  Hz. Record results.

100 Hz - 10 kHz \_\_\_\_\_  $\pm 200$  Hz

F) RF Counter  
Unit in REC, RF COUNTER Enabled, Set Sig Gen to 999.5 MHz at 100mV RF level. Cable Sig Gen to Unit ANTENNA. Record RF frequency Count. Repeat for 30.5 MHz.

999.5 MHz, 30.5 MHz \_\_\_\_\_  $\pm 1$  kHz

#### IX Wattmeter

##### A) High Power Setup

1) Set Power source to 151 MHz, high power setting, connect power source output through test wattmeter to 100W load. Adjust bias voltage for 90 watts as read on the test wattmeter. Dekey the radio. Connect power source output through the test wattmeter to the 2100 front-panel "RF IN/OUT". Connect the 2100 antenna port to the 50 ohm load. Key the radio. Read the level on the 2100 wattmeter and the test wattmeter simultaneously. The 2100 should read  $\pm 9$  W of what the test wattmeter reads.

2) During setup at 151 MHz, adjust R276 on the 2100 RF board to read 90 watts.

##### B) Low Power Setup

1) Set power source to 151 MHz, Low Power Setting, turn bias voltage down until 2100 is reading in 10W range (X.X Watt), then adjust bias voltage so 2100 reads 9.5W, test wattmeter

should be 9.5W  $\pm$ 1.4W. NOTE: Unit will switch into high power mode if Unit reads more than 10 watts. Measurements and adjustments need to be made with Unit reading less than 10 watts.

- 2) During setup at 151 MHz turn R278 on the 2100 RF board fully counterclockwise. Key power and adjust to 9.5 watts as read on the test wattmeter. Adjust R278 for 9.5 watts as read on the 2100 wattmeter.
- C) Repeat A1 and B1 for 445 MHz.
- D) Repeat A1 and B1 for 857 MHz with the power source set for 80 watts on the test wattmeter. The reading on the 2100 should be 80  $\pm$ 16 watts. For low power testing at 857 MHz, the reading should be 9.5  $\pm$ 1.9 watts.

151 MHz	90 W	_____	$\pm$ 9 W
445 MHz	90 W	_____	$\pm$ 9 W
857 MHz	80 W	_____	$\pm$ 16 W
151 MHz	9.5 W	_____	$\pm$ 1.4 W
445 MHz	9.5 W	_____	$\pm$ 1.4 W
857 MHz	9.5 W	_____	$\pm$ 1.9 W



2100 CALIBRATION RECORD

DATE \_\_\_\_\_  
 TECH \_\_\_\_\_  
 SERIAL # \_\_\_\_\_

I. Power Supply

+ 5v	+ 5v ±0.2v	_____
-15v	-15v ±0.2v	_____
+15v	+15v ±0.2v	_____
DC-DC Converter Voltage	Lg. Version 16.0v ±0.1v	_____
	Sm. Version 13.5v ±0.1v	_____
Battery Charge Voltage	15v ±0.2v	_____
Battery Check		_____ (X)

II. Audio Synth

Output Voltage (1kHz, Gen)	1 kHz 3.9v pp ±0.3v	_____
Audio Band Width	10 Hz & 10 kHz 3.9v pp ±0.3v	_____
10 Hz & 10 kHz		

III. Sinad Meter

A. Notch (1kHz @ 1v p-p, Demod Out => Sinad/Audio In)	>30dB	_____
B. Sinad (1kHz @ 5kHz Dev, Audio Synth 3333Hz, 1240 Dev)	12dB ±1dB	_____ (X)

IV. Voltmeter

A. DC Voltmeter (=> Sinad/Audio)	+15v ±0.75v	_____
B. AC Voltmeter (20v p-p = 7.07vrms, Check 10Hz-10kHz) Record 10kHz Reading	10v peak ±0.5v	_____

V. Markers

A. Markers ±0.7v 0-scope at 0.2v/div	+0.7v ±0.05v _____ (X)
	-0.7v ±0.05V _____ (X)
B. 600Hz	600Hz ± 60Hz _____

(10)

VI. Generate

- A. Spurs <35dBc  $\pm$ 300kHz  
 150.5MHz \_\_\_\_\_  
 480.5MHz \_\_\_\_\_  
 812.5MHz \_\_\_\_\_
- B. Flatness  
 x 1.0mV  $\pm$ 3dB \_\_\_\_\_ (X)  
 x 0.1mV  $\pm$ 3dB \_\_\_\_\_ (X)  
 x10.0uV  $\pm$ 3dB \_\_\_\_\_ (X)
- C. Pads and RF Level Pot (20dB drop)  
 x 1.0mV  $\pm$ 2dB \_\_\_\_\_ (X)  
 x 0.1mV  $\pm$ 2dB \_\_\_\_\_ (X)  
 x10.0uV  $\pm$ 2dB \_\_\_\_\_ (X)  
 RF Level Pot  $\pm$ 2dB \_\_\_\_\_ (X)  
 Knob Fastened \_\_\_\_\_ (X)
- D. Residual FM  
 150.5MHz <100Hz \_\_\_\_\_  
 480.5MHz <100Hz \_\_\_\_\_  
 812.5MHz <100Hz \_\_\_\_\_
- E. Modulation  
 Audio Synth On, 5kHz  
 Dev @ 1kHz, RF Out => Mod Analyzer  
 Avg Dev 150.455 MHz \_\_\_\_\_  
 Relative dBm 150.455MHz  $\pm$ 0.5dB \_\_\_\_\_  
 Relative dBm 150MHz  $\pm$ 0.5dB \_\_\_\_\_
- F. Bandwidth 150.455 MHz @ 5kHz Dev  
 10Hz-10kHz Audio Synth  $\pm$ 1.5dB \_\_\_\_\_/  
 10Hz-10kHz Ext Source  $\pm$ 1.5dB \_\_\_\_\_/

VII. Receiver

- A. Time Base  
 Frequency Error @ 999.9MHz, 1 mV 0Hz  $\pm$ 100 Hz \_\_\_\_\_
- B. Automatic Gain Control  
 Sig Gen 150.5MHz, 600Hz Dev, 1kHz  
 1. AGC voltage @ 3mV RF level AGC >14v \_\_\_\_\_ (X)  
 2. AGC voltage @ 10mV RF level AGC <14v \_\_\_\_\_ (X)  
 3. Demod signal distortion @ 1v RF level <750Hz \_\_\_\_\_ (X)
- C. Sensitivity  
 1. 2uV-5kHz Dev  
 150.5MHz <2uV \_\_\_\_\_  
 480.5MHz <2uV \_\_\_\_\_  
 812.5MHz <2uV \_\_\_\_\_
- D. Rec Level  
 Set 10uV-3mV  $\pm$ 3dB 480.5MHz \_\_\_\_\_ (X)  
 Check for <14 @ 10uV, <4500 @ 3mV  $\pm$ 3dB 150.5MHz \_\_\_\_\_ (X)  
 Check for >7 @ 10uV, >2100 @ 3mV  $\pm$ 3dB 812.5MHz \_\_\_\_\_ (X)

E. Modulation Audio Synth @ 1kHz => Sig Gen 480.5MHz,  
5kHz Dev, 1mV

- |                                     |                  |       |
|-------------------------------------|------------------|-------|
| 1. 1kHz Rate                        | 5kHz Dev ± 200Hz | _____ |
| 2. 1kHz Rate                        | 10kHz Dev ± 1kHz | _____ |
| 3. 10Hz-10kHz,<br>Record 10kHz Rate | 5kHz Dev ±1100Hz | _____ |

VIII. Counter

- |   |                             |       |
|---|-----------------------------|-------|
| A. Audio (thru receiver) 480.5MHz, 3kHz Dev, 1mV RF             | <1kHz ±3Hz                  | _____ |
|   | >1kHz ±1Hz                  | _____ |
| B. Subtone (thru receiver) 480.5MHz, 600Hz dev. 1mV RF          | ±0.4Hz                      | _____ |
|   | 60Hz-240Hz                  |       |
| C. Audio (Audio Synth => Audio In) 0.5v p-p, Gen                | ±1Hz                        | _____ |
|   | 270Hz-20kHz (SHIFT 7 ENTER) |       |
| D. Subtone (Audio Synth => Audio In) 1.0v p-p, Gen              | ±0.4Hz                      | _____ |
|   | 60Hz-250Hz                  |       |
| E. Frequency Error 999.5 MHz, 10uV,<br>Freq. Er. 100Hz to 10kHz | ±200Hz                      | _____ |
| F. Counter 999.5MHz and 30.5MHz @ 100mV                         | ±1 kHz                      | _____ |

IX. Wattmeter

151MHz	90W ±	9W	_____
445MHz	90W ±	9W	_____
857MHz	80W ±	16W	_____
151MHz	9.5W ±	1.4W	_____
445MHz	9.5W ±	1.4W	_____
857MHz	9.5W ±	1.9W	_____

## REPLACEABLE PARTS

## 6.1 INTRODUCTION

This section contains lists of all replaceable parts for the instrument.

For an assembly containing one or more subassemblies, the assembly list appears first and is followed by the subassembly lists. The lists appear in the following order.

PARTS LIST	ASSEMBLY
1010-70-0006	2100 Serv. Monitor
1111-70-0009	Chassis Assy., 2100
1111-70-0010	Cabinet Assy., 2100
1118-70-0012	FP Assy., 2100
1110-70-0103	U Processor Board, 2100
1110-70-0102	Mother (RF) Board, 2100
1110-70-0104	Power Supply Board, 2100
1118-70-0013	RP Assy., 2100
1111-70-0016	Sub-Chassis Assy., 2100
1219-70-0074	XFMR Assy., 2100

## 6.2 MANUFACTURERS CODE

The following is a list of codes used on the parts list to identify the manufacturer.

A-B	ALLEN-BRADLEY	MILWAUKEE	WI
ACI	ADVANCE COMPONENTS, INC.	CENTERBROOK	CT
AER	AVX CERAMICS	MYRTLE BEACH	SC
AMD	ADVANCED MICRO DEVICES INC.	SUNNYVALE	CA
AMP	AMP, INC.	HARRISBURG	PA
APL	AMPHENOL CONNECTOR SYSTEMS	BROADVIEW	IL
ARC	ARCO ELECTRIC PRODUCTS	SHELBYVILLE	IN
ASE	AIRCO SPEER ELECTRONICS	ST. MARYS	PA
ATC	AMERICAN TECHNICAL CERAMICS	HUNTINGTON STATION	NY
BEK	BECKMAN INDUSTRIES INC.	FULLERTON	CA
BEL	BELDEN CORP.	GENEVA	IL
BER	BERG ELECTRONICS	NEW CUMBERLAND	PA
BOU	BOURNS, INC.	RIVERSIDE	CA
BUCK	BUCKEYE STAMPING CO.	COLUMBUS	OH
BURND	BURNDY CORP.	NORWALK	CT
C-D	CORNELL DUBLIER ELECT. DIV.	NEWARK	NJ
C-K	C & K COMPONENTS, INC.	WATERTOWN	MA
C-L	CENTRALAB DIV.	MILWAUKEE	WI
CBLWV	CABLEWAVE SYSTEMS, INC.	NORTH HAVEN	CT
CCM	CORCOM, INC.	CHICAGO	IL
CFI	CIRCUIT FUNCTIONS INC.	NEWBURY	CA
CHOM	CHOMERICS INC.	WOBURN	MA
CII	COMPONENTS IMPORTS INC.		
CONV	CONVERSION DEVICES		
CRYTK	CRYSTEK	FT. MEYES	FL
CTL	CENTRALAB INC.	MILWAUKEE	WI

13

CTS	CHICAGO TELEPHONE SYSTEMS	CHICAGO	IL
CTSYS	CT SYSTEMS, INC.	BEECH GROVE	IN
DAL	DALE TECHNOLOGY CORP.	HARTSDALE	NY
DEL	DELEVAN DIV.	EAST AURORA	NY
ELNA	ELNA	CARSON	CA
ETP	ERIE TECHNOLOGICAL PRODUCTS	ERIE	PA
F-S	FEDERAL SCREW	CHICAGO	IL
FCD	FAIRCHILD	MOUNTAIN VIEW	CA
FRXC	FERROXCUBE DIVISION	SAUGERTIES	NY
G-E	GENERAL ELECTRIC	INDIANAPOLIS	IN
G-I	GEN'L. INSTRUMENT SEMICONDUCTOR	HICKSVILLE	NY
H-P	HEWLETT-PACKARD	INDIANAPOLIS	IN
HHS	HERMAN H. SMITH, INC.	BROOKLYN	NY
HIT	HITACHI AMERICA, LTD.	SAN FRANCISCO	CA
ISTMP	ISOTEMP RESEARCH, INC.	CHARLOTTESVILLE	VA
JEF	JEFFERS	DUBOIS	PA
KEMET	KEMET UCC	GREENVILLE	SC
KMYO	KAMAYA OHM		JAPAN
LIT	LITTELFUSE, INC.	DES PLAINES	IL
LLC	LSI LOCIG CO.	MILPITAS	CA
MILSP	MILITARY SPECIFICATION	WASHINGTON	DC
MIN-C	MINI-CIRCUITS	BROOKLYN	NY
MOL	MOLEX PRODUCTS	LISLE	IL
MOT	MOTOROLA SEMI. PROD.	INDIANAPOLIS	IN
MOUS	MOUSER ELECTRONICS	LAKESIDE	CA
MSI	MSI ELECTRONICS, INC.	WOODSIDE	NY
MURA	MURA	WESTBURY	NY
MURGA	MURATA-GEORGIA	MARIETTA	GA
NAT	NATIONAL SEMICONDUCTOR CORP.	SANTA CLARA	CA
NEC	NIPPON ELECTRIC CO.	TOKYO	JAPAN
NICHN	NICHICON (AMERICA) CORP.	SCHAUMBURG	IL
OHM	OHMITE MFG. CO.	SKOKIE	IL
P-C	POWER COMPONENTS	WOODLAND HILLS	CA
PACCOM		REDMOND	WA
PAND	PANDUIT CORP.	TINLEY PARK	IL
PHC	PHILADELPHIA HANDLE CO.	CAMDEN	NJ
PLSSY	PLESSEY ENG.	SCHILLER PARK	IL
PNSNC	PANASONIC		
PRSN	PRECISION TUBE CO., INC.	NORTH WALES	PA
Q-C	QUALITY COMPONENTS	ST. MARYS	PA
QUAM		CHICAGO	IL
RCA	RCA	CAMDEN	NJ
S-I	SWITCHCRAFT, INC.	CHICAGO	IL
S-T	SARKES TARZIAN	BLOOMINGTON	IN
SIEM	SIEMENS	ISELIN	NJ
SIG	SIGNETICS CORPORATION	SUNNYVALE	CA
SOART	STATE OF THE ART, INC.	STATE COLLEGE	PA
SPR	SPRAGUE ELECTRIC CO.	INDIANAPOLIS	IN
SSS	SOLID STATE SCIENTIFIC	MONTGOMERYVILLE	PA
TI	TEXAS INSTRUMENTS	DALLAS	TX
TELRY	TELEDYNE RELAYS	HAWTHORNE	CA
THMSN	THOMPSON		FRANCE
UNCAR	UNION CARBIDE COMPONENTS	GREENVILLE	SC
USMFS	USM FASTENER DIV.	UPPER DARBY	PA

REFERENCE DESIGNATORS	PART DESCRIPTION	ORIG-MFGR-PART-NO	MFGR	WAVETEK NO.	QTY
NA	HANDLE	8002-529-LESS END CAP	PHC	2810-07-0013	1.000
NA	RUBBER FEET	SJ5012	MRRUB	2810-08-0012	4.000
NA	SCW;P,82 F U CUT HD 4-40X1/4,STNLS	PER DESC2810-23-0083	F-S	2810-23-0083	6.000
NA	SCW,PFH,6-32X1/4	18242NP	F-S	2810-52-6104	6.000
NA	SCW,POH,10-32X5/8,BK	19287-BK OXIDE	F-S	2810-64-0110	2.000
NA	FUSE ENVELOPE W/ TAG WIRE	3010-10-0002	W-I	3010-10-0002	1.000
NA	INTERCONNECT DWG,2100	2100 INTERCONNECT DWG	W-I	0714-20-0010	1.000
NA	ENV.TEST PROC.,2100	2100 ENVIRON. TEST	W-I	0716-10-0007	1.000
NA	FINAL TEST, 2100	2100 FINAL TEST	W-I	0716-10-0008	1.000
NA	CHASSIS ASSY, 2100	1111-70-0009	W-I	1111-70-0009	1.000
NA	HANDLE END CAPPER B/P	1410-01-4120	W-I	1410-01-4120	2.000
NA	TOP COVER, 2100REV E	1417-60-0620	W-I	1417-60-0620	1.000
NA	FUSE,3AG,SB,3/8A250V	MDL-3/8	BUS	2410-05-0031	1.000

**WAVETEK**  
PARTS LIST

2100 SERV MONITOR

1010-70-0006

PAGE: 1

E

REV

REFERENCE DESIGNATORS	PART DESCRIPTION	ORIG-MFGR-PART-NO	MFGR	WAVETEK NO.	QTY
NA	RF-POWER CABLE,2100	1219-70-0066	W-I	1219-70-0066	1.000
NA	DISPLAY CABLE,2100	1219-70-0068	W-I	1219-70-0068	1.000
NA	UP-FP CABLE,2100 (FINAL LENGTH-8.5)	1219-70-0069	W-I	1219-70-0069	1.000
NA	COUNTER CABLE,2100	1219-70-0070	W-I	1219-70-0070	1.000
NA	HARNESS, SPEAKER2100	1219-70-0075	W-I	1219-70-0075	1.000
NA	(O)CHASSIS,2100	1417-60-0810	W-I	1417-60-0810	1.000
NA	CABLE TIE,3-1/2	SSTIM-M	PAND	2810-00-0001	2.000
NA	BAIL,7 IN,W/FEET HH103-000	40008-2	BUCK	2810-08-0005	1.000
NA	NUT,6-32X1/4HN101-600	8005NP	F-S	2810-14-6100	4.000
NA	NUT,KEPS,4	71500	F-S	2810-16-0026	5.000
NA	NUT,KEPS,6	9225	F-S	2810-16-0027	5.000
NA	INT,LOWASHER,6 HW101-600	1304ZP	F-S	2810-24-6000	14.000
NA	SCW,PPH,6-32X3/8	19044NP	F-S	2810-55-6106	9.000
NA	SCW,PPH,6-32X1/2	19046NP	F-S	2810-55-6108	6.000
NA	SCW,PPH,6-32X3/8,BK	19044-BKOXIDE	F-S	2810-65-6106	2.000
NA	SPEAKER	30A05Z8	QUAM	3010-11-0005	1.000
NA	ASY,UPROC BD,2100, POST WAVE PTS KT	2100-UPROCESSOR BD	W-I	1110-70-0103	1.000
NA	ASY,PS BD,2100, POST WAVE PTS KT	2100-PWR SUPPLY	W-I	1110-70-0104	1.000
NA	FP ASSY, 2100	1118-70-0012	W-I	1118-70-0012	1.000
NA	RP ASSY, 2100	1118-70-0013	W-I	1118-70-0013	1.000
NA	UP-POWER CABLE,2100	1219-70-0065	W-I	1219-70-0065	1.000
U02	128K(16X8)CMOS UV ERASABLE PROM	MBM27C128-20	FJTSU	8002-71-2810	1.000

**WAVETEK**  
PARTS LIST

CHASSIS ASSY, 2100

1111-70-0009

PAGE: 1

J

REV

REFERENCE DESIGNATORS	PART DESCRIPTION	ORIG-MFGR-PART-NO	MFGR	WAVETEK NO.	QTY
NA	HANDLE END CAPPER B/P	1410-01-4120	W-I	1410-01-4120	2.000
NA	TOP COVER, 2100REV E	1417-60-0620	W-I	1417-60-0620	1.000
NA	HANDLE	8002-529-LESS END CAP	PHC	2810-07-0013	1.000
NA	SCW;P,82 F U CUT HD 4-40X1/4,STNLS	PER DESC2810-23-0083	F-S	2810-23-0083	6.000
NA	SCW,PFH,6-32X1/4	18242NP	F-S	2810-52-6104	6.000
NA	SCW,POH,10-32X5/8,BK	19287-BK OXIDE	F-S	2810-64-0110	2.000

TOP

SIDE

<b>WAVETEK</b>	CABINET ASSY, 2100	1111-70-0010	A
PARTS LIST		PAGE: 1	REV

14



REFERENCE DESIGNATORS	PART DESCRIPTION	ORIG-MFGR-PART-NO	MFGR	WAVETEK NO.	QTY
NA	ASY, FP BD, 2100, POST WAVE PTS KT	FP PC, 2100	W-I	1110-70-0101	1.000
NA	BRACKET, RT. ANGLE	612	KEY	2810-09-0019	6.000
NA	NUT, 2-56, HN101-200	8000NP	F-S	2810-14-2100	8.000
NA	NUT, KEPS, 4	71500	F-S	2810-16-0026	6.000
NA	LOWASHER, INT 2	1330NP	F-S	2810-24-2000	16.000
NA	FILM, COATED CLEAR ALTAIR 20, 5 MIL RFI SHIELD	905-2003	S-W	3010-00-0005	0.100
NA	ELASTOFOAM, .062X.250 ADHESIVE BACKED	88-13127	TEKNT	3210-99-0060	12.000
NA	CABLE ASSY 10 IN 2100 ANT/RF IN OUT	1217-70-0121	W-I	1217-70-0121	2.000
NA	FRONT PANEL, 2100	1417-60-0610	W-I	1417-60-0610	1.000
NA	HEADER, 14-PINSTRT REF: 2112-07-0000	65501-414	BER	2112-07-0031	2.000
NA	KNOB, LT GY, BK LN	SSN50L(L)-1LTGY BKLN	BUCK	2410-01-0055	5.000
NA	KNOB, LT GRY W/CLEAR SKIRT W/BLACK LINE	5S70RNJ2B91TC	BUCK	2410-01-2031	1.000
NA	DISPLAY, LCD, 1X16 DOT MATRIX	LM054	HIT	2410-03-0030	2.000
NA	DECAL, FP, 2100, OVLAY	2417-14-0008	W-I	2417-14-0008	1.000
NA	SPACER, RND .091ID X .188OD X 3/16LG	9208-8091	AMATM	2810-04-2003	8.000
<b>WAVETEK</b>		FP ASSY, 2100		1118-70-0012	D
PARTS LIST				PAGE: 1	REV

REFERENCE DESIGNATORS	PART DESCRIPTION	ORIG-MFGR-PART-NO	MFGR	WAVETEK NO.	QTY
NA	uP BD COMP LAYOUT, 2100	2100 uP BD LAYOUT	W-I	0712-50-0113	1.000
NA	SCHEMATIC,uP BD,2100	2100 uP SCHEMATIC	W-I	0714-40-0031	1.000
NA	uP TEST PROC.,2100	2100 uP TEST	W-I	0716-10-0004	1.000
U1	IC, 78C10G-36	78C10G-36	NEC	8000-78-1000	1.000
U4	2K x 8 ZEROPOWER RAM	MK48202B15	SGS-A	8000-48-0215	1.000
TLO 84	7000-00-8400	39/1254			
DG 411C	7000-04-1100	300/531			
<b>WAVETEK</b>		ASY,UPROC BD,2100, POST WAVE PTS KT		1110-70-0103	I
PARTS LIST				PAGE: 1	REV

15

REFERENCE DESIGNATORS	PART DESCRIPTION	ORIG-MFGR-PART-NO	MFGR	WAVETEK NO.	QTY
1	RF SHIELD, 2100 MOTHER BD.	1417-01-0380	W-I	1417-01-0380	1.000
2	BOX CM&CM4	1417-30-0400	W-I	1417-30-0400	1.000
3	BOX, CM1&4 BOTTOM2100	1417-30-0500	W-I	1417-30-0500	1.000
4	CABLE, S-RIG, 50, .047	CA50047	PRSN	6011-40-0021	9.350
* G201	TCXO, 10 MHZ, .5PPM 0-50 C, BURNED IN, SINEWAVE	TCX050-17A	ISTMP	2311-00-0007	1.000
K201	RELAY, DPDT, 26.5 V	712-26	TELRV	4510-00-0018	1.000
L233 L234 L235 L236 L244 L250	TOROID, 6 TURN FROM: 1813-00-0007	1810-05-0017	W-I	1810-05-0017	6.000
L245 L246 L247 L253 L257	TOROID, 4T, 1-1/4L REF 0012-00-0194	LA009-004-1	W-I	1810-05-0003	5.000
T201	RF XFMR, BIFILAR	11210-43-0011	W-I	1814-00-0021	1.000
U213	WIDEBAND AMP, MAR-6	MAR-6	MIN-C	7000-00-0006	1.000
U219	WIDEBAND AMP, MAR-8	MAR-8	MIN-C	7000-00-0008	1.000
<b>WAVETEK</b>		ASY, MOTHER BD, 2100, POST WAVE PTS KT		1110-00-2363	c
PARTS LIST				PAGE: 1	REV

REFERENCE DESIGNATORS	PART DESCRIPTION	ORIG-MFGR-PART-NO	MFGR	WAVETEK NO.	QTY
C331	CAP, ALM, 2200uF, 35V 20%, AXL. 64'' Dx 1.7'' L	TL2200MF35V	ELNA	1510-24-1222	1.000
J201 J202 J206	CONN, RF, STR, JACK	09-1450-00C	PALCO	2110-08-0006	3.000
P201	HDR, STRT, 50-PIN, DBL	2-102973-5	AMP	2112-07-0037	1.000
P202	PLUG, LKG, STRT, 4-PIN	26-51-0042	MOL	2112-06-0001	1.000
P203	HDR, LATCHING, 3-PIN	69167-103	BER	2112-43-0003	1.000
P204	PLUG, 3-CKT	3100-8-203-01	METH	2112-05-0008	1.000
<b>WAVETEK</b>		(U)ASY, MOTHER BD, 2100, MASK/MECH	1219-00-0931		
PARTS LIST			PAGE: 1		REV

16

REFERENCE DESIGNATORS	PART DESCRIPTION	ORIG-MFGR-PART+NO	MFGR	WAVETEK NO.	QTY
C201 C203 C209 C211 C214 C216 C235 C277 C285 C364 C365 C367 C369 C372	(P)CAP,TNT,.1uF,50V +/-20%,CHP,T/R, 1206 CASE	TAJA104M050R	AVX	1510-27-9104	14.000
C205 C207 C218 C227 C278 C279 C283 C287 C288 C289 C290 C315 C316 C317 C318 C319 C321 C328 C334 C336 C337 C338 C339 C340 C341 C342 C344 C347 C348 C349 C350 C351 C352 C353 C354 C356 C357 C358 C359 C360 C361 C377 C381	(P)CAP,CER,470PF,50V 5%,CHIP,NPO,+/-30PPM 0805,T/R,VALUE MARKD	500R15N471JV3E	JHSN	1510-06-5471	43.000
C213	(P)CAP,CER,2.2PF,50V +/- .5PF,CHIP,NPO 0805,T/R,VALUE MARKD	C2012COG1H2R2DT	TDK	1510-06-5229	1.000
C280 C320 C322 C335 C343 C370 C382	(P)CAP,CER,.001uF 100V,20%,CHP,X7R 0805,T/R,VALUE MARKD	08051C102MAT050M	AVX	1510-06-7102	7.000
C296	(P)CAP,CER,3.9PF,50V +/- .5PF,CHIP,NPO 0805,T/R,VALUE MARKD	C2012COG1H3R9DT	TDK	1510-06-5399	1.000
C355	(P)CAP,CER,4.7PF,50V +/- .5PF,CHIP,NPO 0805,T/R,VALUE MARKD	C2012COG1H4R7DT	TDK	1510-06-5479	1.000
C368	CAP,TANT,10 UF,25V SURFACE MOUNT,T/R	NRD106M25R12	NEC	1510-27-9106	1.000
C371 C379	(P)CAP,CER,68PF,50V 1%,CHIP,NPO,+/-30PPM 0805,T/R,VALUE MARKD	C2012COG1H680FT	TDK	1510-06-5680	2.000
CR210 CR211 CR212 CR213 CR214 CR215 CR218 CR219 CR220 CR221 CR229 CR230 CR231 CR232 CR233 CR234 CR235 CR238 CR239 CR241 CR243	DIODE,PIN,GP,ODS-07 V=100V,CJ=0.4pF *SS*,T/R	HSMP3800L31	H-P	4805-02-0016	21.000
L218 L219 L220 L221 L223 L224 L226 L228 L258 L259 L260 L261 L262 L265	INDUCTOR CHIP, FIXED 22UH+/-10% MINSRF 16 MHZ,DCR 250 OHM,T/R	LCM1812-220K	INDSP	1816-00-0223	14.000
L242 L249	CHOKE,CHIP,0.22UH 20%,MOLDED,.18''L X .12''W,T/R	GLBR2220	SPR-G	1816-02-0221	2.000
Q207	ANALOG,SILCON N CHAN MOSFET DUAL GATE SOT 143,PLAS PK,*SS*	BF989	PHLPS	7000-09-8900	1.000
Q209	MOSFET,BF998 TETRODE N-CHANNEL,SILICON (MO)*SS*	BF998	SIEM	4902-00-9980	1.000
Q214 Q216 Q217	PNP,SOT-23,MED PWR F=200m,V=40,P=350m, hFE=40,*SS*,T/R	BSR18A-TRL	APX	4902-00-0800	3.000
<b>WAVETEK</b>	HYBRID PTS KIT, MOTHER BD,2101	1219-00-0819			B
PARTS LIST		PAGE: 1			REV

REFERENCE DESIGNATORS	PART DESCRIPTION	ORIG-MFGR-PART+NO	MFGR	WAVETEK NO.	QTY
R241 R252 R259 R353	(S) RES, CH, 237, 1%, 1/8W, TC=100PPM, T/R 1206	RK73H2B2370F	KOA	4711-03-2370	4.000
R253 R254	RES, CHP, 787, 1% 1/8W, TC=100ppm, T/R 1206	RMC18787RFT	KMYO	4711-03-7870	2.000
R255 R256 R260 R261 R345 R346 R373	(S) RES, CHP, 61.9, 1% 1/8W, TC=100ppm, T/R 1206	RMC186198FT	KMYO	4711-03-6199	7.000
R264	RES, CH, 3W, 5%, 1K	2512-1001FSWB-3W	ETF-T	4711-55-1001	1.000
R266 R281 R282 R310 R311 R316	(S) RES, CHP, 51.1, 1% 1/8W, TC=100ppm, T/R 1206 CASE	RMC185118FT	KMYO	4711-03-5119	6.000
R269 R362	(S) RES, CHP, 75, 1% 1/8W, TC=100ppm, T/R 1206	RMC187508FT	KMYO	4711-03-7509	2.000
R313 R348 R356	(S) RES, CHP, 1.50K, 1%, 1/8W, TC=100ppm, T/R, 1206	RMC181501FT	KMYO	4711-03-1501	3.000
R315	RES, CHP, 866, 1% 1/8W, TC=100ppm, T/R 1206	BCK8660FB	A-B	4711-03-8660	1.000
R329 R330 R331 R332	RES, CHP, 604, 1% 1/8W, TC=100ppm, T/R 1206	RMC18604RFT	KMYO	4711-03-6040	4.000
R333 R343 R352	(P) RES, CHP, 3.01K, 1% 1/8W, TC=100ppm, T/R 1206	RMC183011FT	KMYO	4711-03-3011	3.000
R334	(P) RES, CHP, 100, 1% 1/8W, TC=100ppm, T/R 1206	RMC18100RFT	KMYO	4711-03-1000	1.000
R335 R340	(S) RES, CHP, 475, 1% 1/8W, 1206, TC=100 PPM T/R	RK73H2B4750F	KOA	4711-03-4750	2.000
R336 R337 R338 R339	(S) RES, CHP, 2.21K, 1% 1/8W, TC=100ppm, T/R 1206	RMC182211FT	KMYO	4711-03-2211	4.000
R344	(S) RES, CHP, 200, 1%, 1/8W, TC=100ppm, T/R, 1206	RMC18200RFT	KMYO	4711-03-2000	1.000
R347	RES, CHP, 4.99K, 1% 1/8W, TC=100ppm, T/R 1206	RMC184991FT	KMYO	4711-03-4991	1.000
R354 R355	(P) RES, CHP, 100K, 1% 1/8W, TC=100ppm, T/R 1206	RMC181003FT	KMYO	4711-03-1003	2.000
R360 R361	(P) RES, CHP, 9.09K, 1% 1/8W, TC=100ppm, T/R 1206	RMC189091FT	KMYO	4711-03-9091	2.000
<b>WAVETEK</b> PARTS LIST	HYBRID PTS KIT, MOTHER BD, 2101	1219-00-0819 PAGE: 2			B REV

17

REFERENCE DESIGNATORS	PART DESCRIPTION	ORIG-MFGR-PART-NO	MFGR	WAVETEK NO.	QTY
U214 U216	PPL,W/PRESCALER 1.1GHZ,PLAS,SO-16*SS*	MB1501PF	FJTSU	7000-15-0100	2.000
U223	2.5GHZ DIVIDE BY 2	UPB584	NEC	8000-05-8400	1.000
U224	.5-2.5GHZ,DIV BY 4 PRESCALER SOB 30MA, *SS*	UPB585G	NEC	8000-05-8500	1.000
U225	1 GHZ PRESCALER	UPB587G	NEC	8000-05-8700	1.000
U226	BCD DECADE COUNTER, SO-16 HIGH SPEED,*SS*	74HC162D	MOT	8007-41-6213	1.000
U227	HEX INV,SCHMITT TRIG PLAS SO-14,CMOS*SS* 150 MIL PKG	MH74HC14M	NAT	8000-74-1412	1.000
<b>WAVETEK</b>		HYBRID PTS KIT, MOTHER BD,2101		1219-00-0819	B
PARTS LIST				PAGE: 3	REV

REFERENCE DESIGNATORS	PART DESCRIPTION	ORIG-MFGR-PART-NO	MFGR	WAVETEK NO.	QTY
2	NUT, HEX, 0-80X3/64	67000	F-S	2810-16-0021	4.000
3	SCREW, 0-80 X 1/4 IN, FILLISTER HD SLOTTED	64045	F-S	2810-39-0109	4.000
4	KEYPAD, 4X4 MATRIX RIGHT SIDE, 2100	SL-16-02	SHIN	5108-00-0011	1.000
5	KEYPAD, 4X4 MATRIX LEFT SIDE, 2100	SL-16-01	SHIN	5108-00-0024	1.000
6	PLATE, BEZEL 2100 REV C	1417-30-0360	W-I	1417-30-0360	1.000
C1 C2	CAP, ALM, 220uF, 16V 20%, RAD .25'' Dx. 49'' L, T/R	RE 16V 221M	ELNA	1510-23-5221	2.000
C3	CAP, MON, 50V, 15PF	RPE110COG150J50V	MURGA	1510-11-8150	1.000
C4 C5 C6	CAP, CER, .001uF 50V, 5%, RAD, NPO .25'' H, .20'' LS	RPE122COG102J50N	MURGA	1510-11-8102	3.000
CR1 CR2 CR3 CR4 CR5 CR6 CR7 CR8 CR9 CR10 CR11 CR12 CR13 CR14 CR15 CR16 CR17 CR18 CR19	LED, RED, T1 LOW PROFILE	HLMP-1350	H-P	4810-02-0020	19.000
J1 J2 J3 J4	BNC-J(F), STR, 50, PC MOUNT	28JR299-3	S-C	2110-01-1036	4.000
L1 L2 L3 L4	10T TOROID, 32GA, 1/8 TINNING	1810-05-0038	W-I	1810-05-0038	4.000
NA	F.P. BD COMP LAYOUT 2100	2100 FP COMP LAYOUT	W-I	0712-50-0114	1.000
NA	SCHEMATIC, FP BD, 2100	2100 FP BD SCHEMATIC	W-I	0714-20-0011	1.000
NA	F.P. TEST PROC., 2100	2100 FP TEST	W-I	0716-10-0005	1.000
P1	HDR, DBL, STRT, 50-PIN	2-103186-5	AMP	2112-07-0118	1.000
R01 R03 R04 R10 R11	POT, PCB, MT, LINEAR, 12.5MM SQ, 20%, 3/4 IN SHAFT	51CAD-D24-B15	BOU	4610-50-9103	5.000
R2	POT, 10K, 20%, LINEAR	91A1AB28B15	BOU	4610-02-6113	1.000
R5	TRM, CM, L, 2K, 10%, PC 25T, PN, CW, .395H, .24W .375L, SA, TC=100PPM	68XR2K	BEK	4619-90-0004	1.000
<b>WAVETEK</b> PARTS LIST		ASY, FP BD, 2100, POST WAVE PTS KT	1110-70-0101 PAGE: 1		F REV

(18)



REFERENCE DESIGNATORS	PART DESCRIPTION	ORIG-MFGR-PART-NO	MFGR	WAVETEK NO.	QTY
6	RTV	3145	DOWCG	1610-03-0011	0.001
8	WIRE, BUSS, 22GA.	8021	BEL	6010-92-2000	1.000
L1 L3	INDUCTOR, 100UH, 2.5A, W/MOUNT KIT	92102K	PULSE	1810-13-0007	2.000
NA	P. S. BD COMP LAYOUT, 2100	2100 PS COMP LAYOUT	W-I	0712-50-0112	1.000
NA	SCHEMATIC, P. S. BD2100	2100 PS BD SCHEMATIC	W-I	0714-20-0009	1.000
NA	P. S. TEST PROC., 2100	2100 PS TEST	W-I	0716-10-0006	1.000
R2 R7	RES, WW, 5W, 5%, .1	45JR10	OHM	4702-65-1007	2.000
X1	DC-DC CONVERTER 12V, IN, 15V OUT	TA23-120-18 1 210,75	SCI	4010-00-0047	1.000
<b>WAVETEK</b>		ASY, PS BD, 2100, POST WAVE PTS KT		1110-70-0104	F
PARTS LIST		PAGE: 1		REV	

REFERENCE DESIGNATORS	PART DESCRIPTION	ORIG-MFGR-PART-NO	MFGR	WAVETEK NO.	QTY
C6 C7	CAP, CER, .1uF, 50V 20% RAD, Z5U .26" H, .10" LS	C320C104M5U5CA	KEMET	1510-11-3104	2.000
J2	RECEPT., DC	722-A	S-I	2112-32-0008	1.000
NA	SCOPE-TRIGGER CABLE 2100	1219-70-0067	W-I	1219-70-0067	1.000
NA	GROUND LUG, #6, INT HG102-600	38-111	F-S	2112-03-0003	1.000
NA	SOLDER LUG	1497	HHS	2112-03-0026	1.000
NA	TERMINAL, FEMALE	61454-1	AMP	2113-22-0011	1.000
NA	FUSEHDR/LINE RECEPT	6VJ1	CCM	2410-05-0017	1.000
NA	FUSE, 3AG, SB, 3/4A250V	1900-0001	SSI	2410-05-0019	1.000
NA	DECAL, REAR PANEL2100	2417-14-0016	W-I	2417-14-0016	1.000
NA	CABLE TIE, 3-1/2	SSTIM-M	PAND	2810-00-0001	5.000
NA	MTG INSULATOR TIP 32	60-12 5791 1674	CHOM	2810-11-0007	3.000
NA	HARNESS, PWR SW, 2100/ 2500	1219-70-0071	W-I	1219-70-0071	1.000
NA	NUT, 2-56, HN101-200	8000NP	F-S	2810-14-2100	2.000
NA	LOWASHER, INT 2	1330NP	F-S	2810-24-2000	2.000
NA	INT, LOWASHER, 6 HW101-600	1304ZP	F-S	2810-24-6000	3.000
NA	SH WASHERHW110-400	7721-7PPS	THR	2810-27-0001	3.000
NA	RIVET, AL, 1/8X1/8	AD42ABS	USMFS	2810-30-0015	2.000
NA	SCW, PPH, 2-56X1/4	19002NP	F-S	2810-55-2104	2.000
NA	SCW, PPH, 4-40X1/4	19022NP	F-S	2810-55-4104	3.000
NA	TRANSISTOR, POWER*SS*	TIP31	MOT	4902-00-0311	1.000
NA	HARNESS, TIP RP/PS 2100	1219-70-0072	W-I	1219-70-0072	1.000
NA	SLEEVING, SHRINKABLE, BLACK, 3/32 IN.	FIT-221-3/32	AWC	6011-20-1500	15.000
NA	SLEEVING, SHRINKABLE, BLACK, 1/8 IN.	FIT-221-1/8	AWC	6011-20-2000	1.000
NA	VOLT REG, FIXED, 5Vdc PLAS, 3 PIN(TO-220) 40Vdc, .3%, 750mA, *SS*	UA7805CKC	T-I	7000-78-0523	1.000
NA	HARNESS, PS/RP2100	1219-70-0073	W-I	1219-70-0073	1.000
NA	XFMR ASSY2100, 2300	1219-70-0074	W-I	1219-70-0074	1.000
NA	PLATE, RS232, 2100	1417-01-0400	W-I	1417-01-0400	1.000
<b>WAVETEK</b> PARTS LIST		RP ASSY, 2100	1118-70-0013 PAGE: 1		I REV

REFERENCE DESIGNATORS	PART DESCRIPTION	ORIG-MFGR-PART-NO	MFGR	WAVETEK NO.	QTY
NA	REAR PANEL, 2100	1417-60-0660	W-I	1417-60-0660	1.000
NA	CONN,BNC-F,50,PANEL UG-1094/U	31-221	APL	2110-01-1022	1.000
S1	SWITCH,SLIDE,DPDT	1201-M1-Z3-Q-E	C-K	5105-00-0026	1.000
U1	ADJ REG,1.2V-37V PLAS,TO-220,1.5A=Io 15W,0.1%,*SS*	LM317T	NAT	7000-03-1700	1.000
<b>WAVETEK</b>		RP ASSY, 2100	1118-70-0013		I
PARTS LIST			PAGE: 2		REV

REFERENCE DESIGNATORS	PART DESCRIPTION	ORIG-MFGR-PART-NO	MFGR	WAVETEK NO.	QTY
NA	RP ASSY, 2100	1118-70-0013	W-I	1118-70-0013	1.000
NA	(O)CHASSIS,2100	1417-60-0810	W-I	1417-60-0810	1.000
NA	BAIL, 7 IN, W/FEET HH103-000	40008-2	BUCK	2810-08-0005	1.000
NA	NUT, KEPS, 6	9225	F-S	2810-16-0027	5.000
NA	INT, LOWASHER, 6 HW101-600	13042P	F-S	2810-24-6000	10.000
NA	SCW, PPH, 6-32X3/8	19044NP	F-S	2810-55-6106	9.000
NA	SCW, PPH, 6-32X1/2	19046NP	F-S	2810-55-6108	4.000
NA	SCW, PPH, 6-32X3/8, BK	19044-BKOXIDE	F-S	2810-65-6106	2.000
<b>WAVETEK</b>		SUB-CHASSIS ASSY 2100		1111-70-0016	
PARTS LIST				PAGE: 1	REV

20

REFERENCE DESIGNATORS	PART DESCRIPTION	ORIG-MFGR-PART-NO	MFGR	WAVETEK NO.	QTY
NA	CONN, FEMALE, 8-PIN	09-50-3081	MOL	2113-06-0027	1.000
NA	TERM, LOOP, WIRE CRIMP 18-24GA	08-50-0106	MOL	2113-07-0002	8.000
NA	TERMINAL, FEMALE	61454-1	AMP	2113-22-0011	7.000
NA	WIRE, 18, BLK, PVC, 1KV 80C, 16X30 STRAND MIL-W-76B TYPE MW	6012-31-8000	ANY	6012-31-8000	6.000
NA	WIRE, 18, RED, PVC, 1KV 80C, 16X30 STRAND MIL-W-076B TYPE MW	6012-31-8222	ANY	6012-31-8222	6.000
NA	WIRE, 18, BLU, PVC, 1KV 80C, 16X30 STRAND MIL-W-76B TYPE MW	6012-31-8666	ANY	6012-31-8666	6.000
NA	WIRE, 18, VIO, PVC, 1KV 80C, 16X30 STRAND MIL-W-76B TYPE MW	6012-31-8777	ANY	6012-31-8777	6.000
NA	WIRE, 18, GRAY, PVC, 1KV 80C, 16X30 STRAND MIL-W-76B TYPE MW	6012-31-8888	ANY	6012-31-8888	6.000
T1	POWER XFMR, 2300	511-P-4B	CMAG	5610-00-0080	1.000
<b>WAVETEK</b>		XFMR ASSY 2100, 2300		1219-70-0074	A
PARTS LIST				PAGE: 1	REV

## 7.1 INTRODUCTION

This section contains all schematics for the instrument. A schematic index is given in paragraph 7.3.

## 7.2 SCHEMATIC NOTES

The following notes and abbreviations pertain to all schematics. Additional notes pertaining to specific schematics are included on each schematic if required.

All values are shown in the following units unless otherwise specified.

<u>Components</u>	<u>Units</u>
Resistor	ohms
Capacitor	picofarads
Inductor	microphenries

 Denotes DC voltage reading in volts unless otherwise specified.

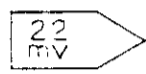
 Denotes high impedance crystal detector reading in volts unless otherwise specified.

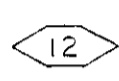
 Denotes 50 ohm crystal detector reading in volts unless otherwise specified.

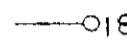
 Signal or voltage source.

 Connects to indicated signal or voltage source.

 Arrow indicates clockwise rotation of wiper.

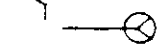
 Coaxial jack.

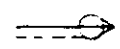
 Coaxial plug.

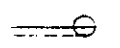
 Coaxial cable.

\* Factory adjusted part.

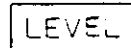
 Denotes a front-panel device.

 Denotes a rear-panel device.

LEVEL Denotes a PC board adjustment or accessible module adjustment.

(LEVEL) Denotes an internal module adjustment not accessible without removing module cover.

## GENERAL

A	ampere
AC	alternating current
CW	continuous wave
cw	clockwise
ccw	counterclockwise
dB	decibel
dBm	decibel referred to 1 mW
dBmV	decibel referred to 1 mV
DC	direct current
DS	indicating device, lamp
F	farad
F.P.	front panel
H	henry
Har	harmonic
Hz	hertz
IF	intermediate frequency
	ohm
pp	peak-to-peak
RF	radio frequency
RMS	root-mean-square
R.P.	rear panel
TP	test point
V	volt
VA	voltampere
W	watt

## SCHEMATIC REFERENCES

A	assembly	OC	opto-coupler
C	capacitor	P	plug
CR	diode	Q	transistor
F	fuse	R	resistor
U	integrated circuit	S	switch
J	jack	T	transformer
K	relay	V	vacuum tube
L	inductor	W	cable assembly
M	meter	X	crystal

## SCIENTIFIC PREFIXES

G = giga	k = kilo	m = milli
M = mega	c = centi	u = micro
		p = pico

## 7.3 SCHEMATIC INDEX

The schematics appear following the parts layout, when applicable, in the following order:

Interconnection Diagram  
Front Panel Board  
u Processor Board  
Mother Board  
Power Supply Board  
RS-232 Board

RS-232 OPERATION

The following pages define basic instructions for operating the Model 2100 via RS-232 serial interface. The operator can control all the keypad functions, audio synthesizer level, 1 kHz level, audio out level, and RF level by the host computer.

The characteristics of the external controlling device must be set as follows to communicate with the 2100:

BAUD RATE:	1200
PARITY:	NONE
DATA:	8 bits
STOP BITS:	1

The following is a list of 2100 functions, their RS-232 command equivalents and the command field available. To get into the RS-232 mode on the 2100, type "SHIFT 8 ENTER".



OUTPUT COMMANDS

MODEL 2100 FUNCTION	RS-232 COMMAND	VALUE FIELD	EXAMPLES
ENTER	F	All functions that normally require an ENTER in normal operation must be followed by an "F".	G12.345FX A+1000FX
GEN	G	Sets unit to Generate mode .4 - 999.9999 MHz	G57.365FX GX
REC	R	Sets unit to Receive .4 - 999.9999 MHz	R123.56FX RX
AUDIO SYNTHESIZER	A+, A- A+????FX	A+ = Audio on, A- = Audio off 10 - 10000 HZ A+????FX changes Audio freq.	A+X, A-X A+1525FX
1 kHz	K+, K-	K+ = 1 kHz on, K- = 1 kHz off	K+X K-X
EXTERNAL	E+, E-	E+ = Ext on, E- = Ext off	E+X K-X
AUDIO MODULATION LEVEL	AM????X	Sets audio modulation level 10 - 9999 Hz dev	AM9999X AM15X
1 kHz MODULATION LEVEL	KD????X	Sets 1 kHz modulation level 10 - 9999 Hz dev	KD7356X KD25X
AUDIO OUT LEVEL	AO????X	Sets Audio Out level 10 - 9999	A01234X A010X
MARKERS	MS, MF, M-	MS = $\pm 600$ Hz, MF = $\pm 5$ kHz, M- = off	MSX, MFX, M-X
STEP SIZE	P, PU, PD	Sets RF step size 1 - 999.6 PU=Step Up PD=Step Down	P25.7FX PUX, PDX
RECALL	U, UU, UD	Sets recall # 0 - 19 UU - Recall Up, UD - Recall Down	U7FX, UUX, UDX
RF LEVEL	T	Set RF level .1 - 9999uV	T9.37X
SQUELCH	Q+, Q-	Opens or Closes the Squelch	Q+X, Q-X
RECEIVE IMAGE	IR	Shifts the Rec. Frequency to the Image Frequency	IRX
LOCAL OPERATION	Z	Return unit back to normal operation	ZX

INPUT COMMANDS

The following commands will set the 2100 to the proper mode and then return the results back to the host device.

MODEL 2100 FUNCTION	RS-232 COMMAND	VALUE RETURNED	EXAMPLE
DEVIATION	D	Returns the deviation of modulation source.	DX
VOLTS	VD, VA	Returns the DC or AC reading. VD = DC, VA = AC	VDX, VAX
SINAD	SD, SP	Returns the SINAD or distortion reading. SD = SINAD, SP = dist.	SDX, SPX
WATTS	W	Returns the watts reading	WX
RECEIVE LEVEL	L	Returns the Rec Level reading	LX
COUNTING	CA, CE CF, C-	CA = count audio frequency CE = count frequency error CF = count RF frequency C- = turns count off	CAX CEX CFX C-X
SUBTONE	B+, B-	Counts subtone B+ = subtone, B- = off	B+X B-X

## NOTES

- To put the 2100 into the RS-232 mode, key in "SHIFT 8 ENTER" on the 2100 front panel. This will lock out the 2100 front panel.
- Any entry that requires an "ENTER" in normal keyboard operation must be followed by an "F" in RS-232 operation. EX: G32.7FX, A+5000FX
- All entry strings must be terminated with an "X". EX: K+A+X, G32FX, DX, RWX.
- A string can contain more than one function, but must not exceed 11 characters. EX: G32FK+MSX, R152.7FMFX, GA+E+K+T99X.
- All number entries do not require leading zeros. EX: G7FX, AM73X, KD100X, T.9X
- It is not possible to switch from generate to receive or vice versa while in the COUNT mode.

## NORMAL OPERATION

The Model 2100 powers up under front panel (local) control. When in remote operation, local control is returned by transmitting a "ZX" from the host computer. This returns control of the instrument back to the front panel.

## LEVEL CONTROL

When transferring control to the RS-232 interface, the 1 kHz modulation level, audio synthesizer level, audio "out" level, and RF level pots on the front panel continue to control their respective levels. This condition remains until the levels are changed by the host computer. This is done by the AM??X, AO??X, KD??X, T??X functions. Once each specific level is changed by the controlling device, it will no longer be affected by its respective front panel control.

## CONNECTIONS

These are the connections for an AT Computer to the CT Systems Model 2100. Both ends of the cable are 9 pin connectors.

<u>9 PIN ON AT (FUNC.)</u>		<u>2100 SIDE (FUNC.)</u>	
1	DCD	1	N.C.
2	Rxd	3	Txd
3	Txd	2	Rxd
4	DTR	4	N.C.
5	GND	5	GND
6	DSR	6	N.C.
7	RTS	7	N.C. CTS
8	CTS	8	N.C. RTS
9	N.C.	9	N.C.

## REMOTE PROGRAMS

The disc provided has programs which contain basic information on the disc, a program to control the 2100 by remote, and a basic wiring diagram for the cable between the host computer and the Model 2100. This will display the names and brief descriptions of the other two programs.

To load the program, enter "GWBASIC", or "BASIC". Then load "JFBCOM.BAS" or "RS232.BAS" and then RUN.

REFERENCE DESIGNATORS	PART DESCRIPTION	ORIG-MFGR-PART-NO	MFGR	WAVETEK NO.	QTY
NA	SH WASHERHW110-400	7721-7PPS	THR	2810-27-0001	2.000
NA	TEST PROC,RS232 OPT, 2100	RS232 OPT. TEST PROC	W-I	0716-10-0011	1.000
NA	RS232 BD. ASSY	1110-70-0125	W-I	1110-70-0125	1.000
NA	RS232 INTFCE HARNESS	RS232 INTERFACE HARN	W-I	1219-70-0079	1.000
NA	RS232 RF LEVEL HARN	RS232 RF LEVEL HARN	W-I	1219-70-0080	1.000
NA	SPACER,4-40X13/16 M-F, HEX	9733-B-0440-3	AMATM	2810-05-0068	4.000
NA	SCREWLOCK,PAIR,F	205817-1	AMP	2810-09-0022	1.000
NA	L,NUT,4-40 1/4X.076	9040	F-S	2810-15-0009	2.000
<b>WAVETEK</b>		OPT, RS232 INTERFACE BD., 2100		1019-70-0022	B
PARTS LIST				PAGE: 1	REV

REFERENCE DESIGNATORS	PART DESCRIPTION	ORIG-MFGR-PART-NO	MFGR	WAVETEK NO.	QTY
C1 C2	CAP, MON, 50V, 10PF	C312C100J2G5CA	KEM	1510-11-8100	2.000
C3	CAP, CER, 1uF, 50V 20%, RAD, Z5U .36''H, .20''LS	CZ30C105M	C-L	1510-11-3105	1.000
C4	CAP, MON, 100V, 39PF +/-5%, RAD	C312C390J2G5CA	KEMET	1510-11-8390	1.000
C5 C6 C7 C8 C10 C11 C12 C13 C18 C19 C22 C24 C27 C28 C29 C30 C31 C16 C26	CAP, CER, .1uF, 50V 20%, RAD, Z5U .26''H, .10''LS	C320C104M5U5CA	KEMET	1510-11-3104	19.000
C9	CAP, CER, .015uF, 50V 5%, RAD, NPO .36''H, .20''LS	SR301A153JAA	AVX	1510-13-2153	1.000
C14 C15 C20 C23 C25	CAP, ALM, 220uF, 16V 20%, RAD .25''Dx.49''L, T/R	RE 16V 221M	ELNA	1510-23-5221	5.000
C17 C21	CAP, CER, .0015UF, 200V 5%, RAD, NPO .2''X.26''X.1''LS	SR201A152JAA	AVX	1510-13-0152	2.000
CR1	DIODE, SIGNAL, GP AXIAL, V=75V, IO=10mA CT=4pF, *SS*	1N914	G-E	4807-01-0914	1.000
NA	RS232 BD COMP LAYOUT 2100	2100 RS232 BD LAYOUT	W-I	0712-50-0116	1.000
NA	BOARD, P.C. RS232 INTERFACE	1717-00-0131	W-I	1717-00-0131	1.000
NA	IC SKT, PC, 14 PIN MC000-073	2-641261-1	AMP	2112-00-0011	2.000
NA	IC SKT, 16 PIN MC000-074	DILB-16P-108	BURND	2112-00-0012	7.000
NA	IC SOCKET, 20-PIN	IC0-203-S8A-T-ROBNU	R-N	2112-00-0020	6.000
NA	IC, SKT, 28-PIN	2-641267-1	AMP	2112-00-0023	1.000
NA	SOCKET, IC 64-PIN, QUIP	C5W64-11	T-I	2112-00-0110	1.000
NA	SOCKET, 19-PIN, ELEVATED STRIP	ESW-119-44-T-S	SMTC	2112-00-0111	1.000
NA	SCHEMATIC, RS232 BD, 2100	RS232 SCHEMATIC, 2100	W-I	0714-25-0007	1.000
NA	TEST PROC., RS232 PC ASSY, 2100	RS232 PC ASSY TEST	W-I	0716-10-0010	1.000
P1 P5	HEADER, STRT, 2 PIN REF: 2112-07-0000	65501-402	BER	2112-07-0007	2.000
P2	HEADER, 6-PIN, STR. REF: 2112-07-0000	65501-406	BER	2112-07-0008	1.000
R1 R2 R4	(P) RES, MF, 20K, 1% 1/4W, AXL, TC=100ppmT/R	MF55D2002FL	KOA	4701-03-2002	3.000

**WAVETEK**  
PARTS LIST

RS232 BD. ASSY

1110-70-0125

B

PAGE: 1

REV

REFERENCE DESIGNATORS	PART DESCRIPTION	ORIG-MFGR-PART-NO	MFGR	WAVETEK NO.	QTY
R3	(S)RES,MF,475K,1% 1/4W,AXL,TC=100ppmT/R	MF55D4753FL	KOA	4701-03-4753	1.000
R5 R6 R7 R9 R11 R13 R17 R19 R23 R25 R26	(P)RES,MF,10K,1% 1/4W,AXL,TC=100ppmT/R	MF55D1002FL	KOA	4701-03-1002	11.000
R8 R10 R16 R22 R88	POT,20K,3/8 IN SQ, IT,CERMET,TRM	3386W-1-203	BOU	4610-02-0203	5.000
R12 R15 R18 R21 R24 R27	POT,10K	3386W-1-103	BOU	4610-02-0103	6.000
R14 R20	(S)RES,MF,33.2K,1% 1/4W,AXL,TC=100ppmT/R	MF55D3322FL	KOA	4701-03-3322	2.000
R30 R29	(P)RES,MF,1K,1% 1/4W,AXL,TC=100ppmT/R	MF55D1001FL	KOA	4701-03-1001	2.000
R50	(S)RES,MF,10,1% 1/4W,AXL,TC=100ppmT/R	MF55D1009FL	KOA	4701-03-1009	1.000
U1	IC, 78C10G-36	78C10G-36	NEC	8000-78-1000	1.000
U2	128K(16KX8)CMOS UV ERASABLE PROM	MBM27C128-20	FJTSU	8002-71-2810	1.000
U3	LATCH,OCT 3-ST,N-INV PLAS,DIP-20 H SPD CMOS,*SS*	MM74HC373N	NAT	8007-43-7311	1.000
U4 U5 U6 U7	FF,OCT,D,3-ST,N-INV PLAS DIP-20,H-SPD CMOS *SS*	MM74HC374N	NAT	8007-43-7412	4.000
U8 U9 U10 U11	DAC.8-BIT*SS*	DAC-08EQ	AMD	8000-00-0800	4.000
U12 U16	OP AMP,JFET-INPUT PLAS,DIP-14, 13V/US=SLEW RT,*SS*	TL084CP	T-I	7000-00-8400	2.000
U13 U14 U15	ANALOG SWITCH,QUAD, SPST,CMOS,DIP-16, PLAS *SS*	DG411DJ	SCX	7000-04-1100	3.000
U17	RS232 DRIVER/RECVR	RS233NG	MAX	8000-02-3300	1.000
Y1	CRYSTAL, 14.31818MHZ	CY14A	CRYTK	2310-00-1431	1.000

**WAVETEK**  
PARTS LIST

RS232 BD. ASSY

1110-70-0125

PAGE: 2

B

REV

REFERENCE DESIGNATORS	PART DESCRIPTION	ORIG-MFGR-PART-NO	MFGR	WAVETEK NO.	QTY
NA	CABLE ASSY, 36 IN	WXKIT-1	W-I	1217-80-0078	2.000
NA	ADPTR,BNC-UHF	KC-94-13	KINGS	2110-00-2005	1.000
NA	BOX, BLACK TUTONE MA001-001	2140	CPKG	3010-10-0001	1.000
NA	PROBE,X1	4503-2	PMAS	3010-16-0017	1.000
NA	TEST LEADS, BNC TO TEST CLIPS	2630	POH	6012-00-0005	1.000
<b>WAVETEK</b> PARTS LIST		ACCESSORY KIT FOR 2100	1019-70-0012 PAGE: 1		B REV



REFERENCE DESIGNATORS	PART DESCRIPTION	ORIG-MFGR-PART-NO	MFGR	WAVETEK NO.	QTY
NA	BATTERY CABLE,2100	1219-70-0064	W-I	1219-70-0064	1.000
NA	BRACKET, BATT MTG. 2100	1417-60-0670	W-I	1417-60-0670	1.000
NA	INT,LOWASHER,6 HW101-600	13042P	F-S	2810-24-6000	4.000
NA	BATTERY, 12V, RECHARGABLE	NP4-12	YUASA	4010-00-0030	1.000
<b>WAVETEK</b>		OPT, 2100 BATTERY	1019-70-0020		
PARTS LIST			PAGE: 1		REV

# Black Blob

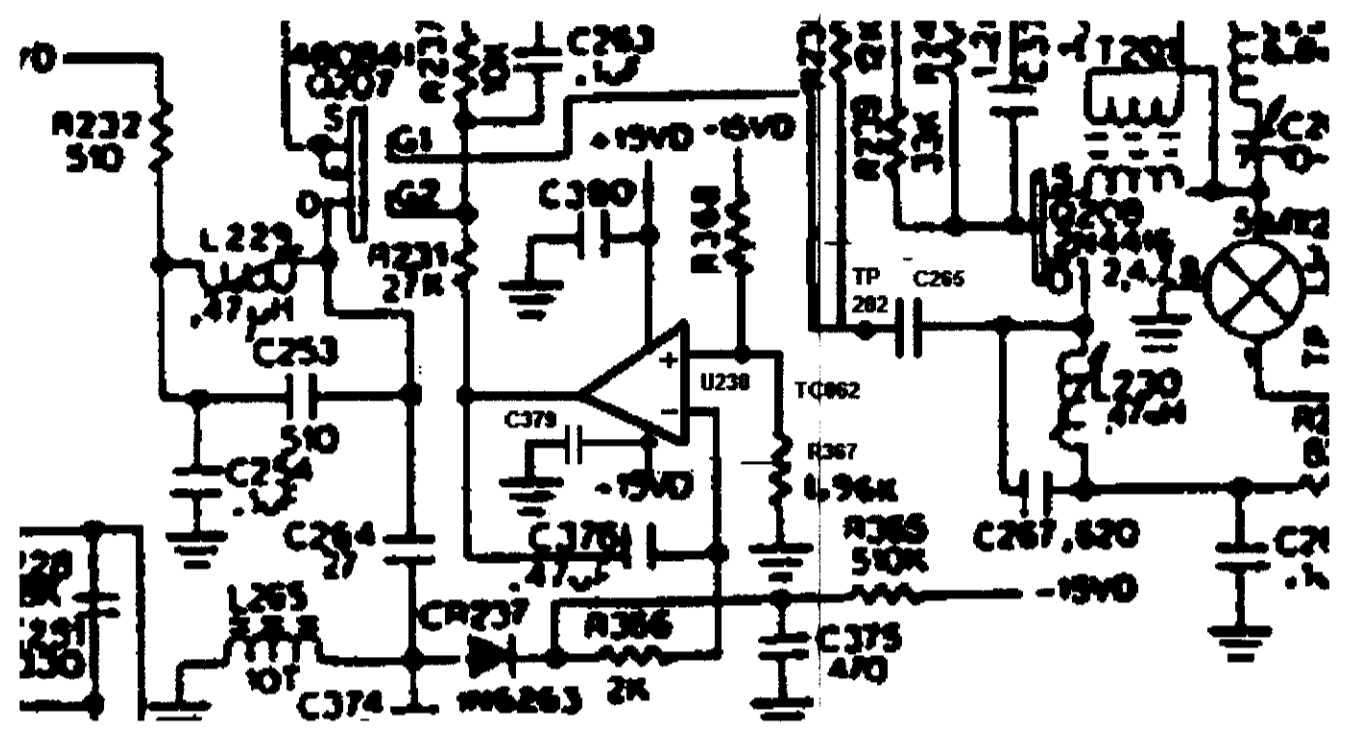

## TA Series Ordering Information

Input Voltage Range	Output Voltage	Output Current	Model Number
9-36 Vdc	5 Vdc	350mA	TA11-350-18
20-72 Vdc	5 Vdc	350mA	TA11-350-48
9-36 Vdc	12 Vdc	150mA	TA12-150-18
20-72 Vdc	12 Vdc	150mA	TA12-150-48
9-36 Vdc	15 Vdc	120mA	TA13-120-18
20-72 Vdc	15 Vdc	120mA	TA13-120-48
9-36 Vdc	±12 Vdc	±75mA	TA22-150-18
20-72 Vdc	±12 Vdc	±75mA	TA22-150-48
9-36 Vdc	±15 Vdc	±60mA	TA23-120-18
20-72 Vdc	±15 Vdc	±60mA	TA23-120-48
9-36 Vdc	+5 / ±12Vdc	2000 / ±310mA	TA34-260-18
20-72 Vdc	+5 / ±12Vdc	2000 / ±310mA	TA34-260-48
9-36 Vdc	+5 / ±15Vdc	2000 / ±260mA	TA35-250-18
20-72 Vdc	+5 / ±15Vdc	2000 / ±260mA	TA35-250-48

## Dimensions and Connections

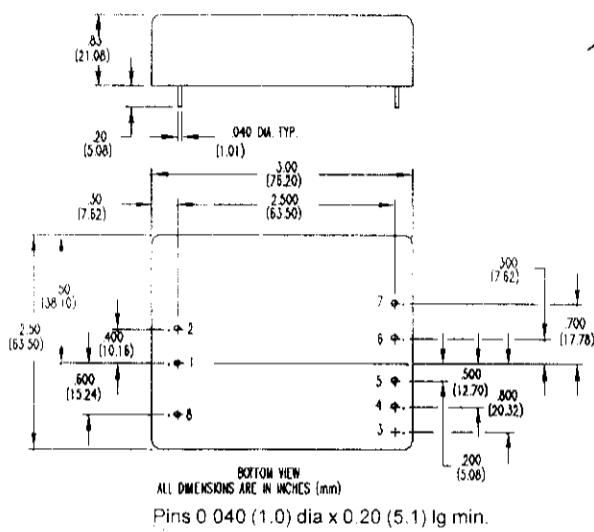

**NOTES:**

1. Ripple measured with a 3.3 mf tantalum capacitor across each output.
2. Load regulation from full load to minimum load with all other outputs at rated load.
3. Minimum current required on 5V out only.
4. Maximum total power from all outputs is 18 Watts and no output is to exceed its maximum rated current.

External Output Trimming: Output may be externally trimmed ±10% (Single output only).

Remote ON/Off Control (pin 8) common referenced to Minus input (pin 2).  
On greater than 4 Vdc or open circuit  
Off less than 1.2 Vdc

11/01/2001

# TA Series

SEMICONDUCTOR  
CIRCUITS, INC.

TA SERIES

18 WATTS

# DC/DC

## 18 Watts

Single/Dual/Triple Outputs

- 4:1 ultra wide input range  
9-36 Vdc  
20-72 Vdc
- Remote shutdown
- 100kHz switching frequency
- Continuous short circuit protection
- Six-sided shielding

The 18-Watt TA series operates over an ultra wide input range of 9-36 Vdc or 20-72 Vdc. Efficiencies of 77% are typical over varying load conditions of 25% to 100%. Additional features include input reverse polarity protection, remote on/off control, logic compatible with CMOS or open collector TTL, short circuit protection with auto restart, overvoltage protection, and an operating temperature range of -25°C to +71°C with no derating. Units are packaged in a six-sided continuous shielded case for EMI/RFI protection and measure 2.5" x 3.0" x 0.83".

### Applications

These units are ideally suited for telecommunications and applications having a widely varying input voltage such as automotive test equipment, process control, minicomputers and geosurvey equipment.

## Specifications

### INPUT

Voltage Range	9-36Vdc 20-72Vdc
Filtering	All Models
Reverse Polarity Protected	To Nominal Input Current External Fuse Required
Remote On/Off Control	All Models

### OUTPUT

Voltage Tolerance	± 1% Main ± 3% Auxiliary
Ripple and Noise	50mV pk-pk
Short Circuit Protection	Continuous Power Cycle
Temperature Coefficient	0.02% / °C

### GENERAL

Regulation:	Main	Aux
Line	0.5%	3.0%
Load	1.0%	3.0%
Efficiency	77% (typ)	
I/O Isolation	500 Vdc	
Switching Frequency	100kHz (typ)	

### ENVIRONMENTAL

Operating Temperature	-25°C to +71°C No Derating
Storage Temperature	-25°C to +105°C
Cooling	Free-air Convection

All specifications are typical at nominal line and full load at 25°C unless otherwise noted and are subject to change without notice.



SEMICONDUCTOR  
CIRCUITS, INC.

888-438-3232 888.GET.DCDC

1

REVISIONS			DATE	APPROVED
ZONE	LTR	DESCRIPTION	DATE	APPROVED

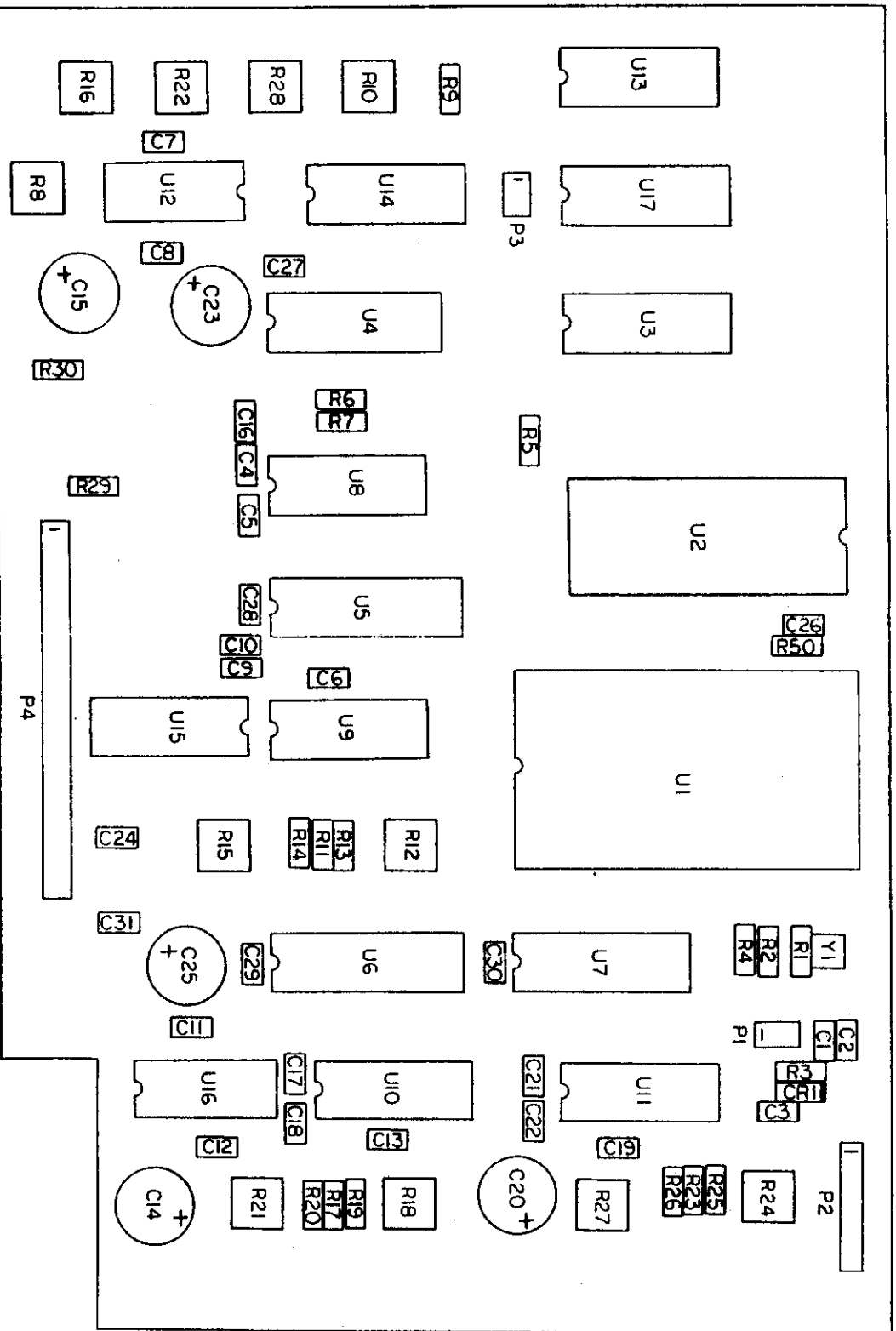

UNLESS OTHERWISE SPECIFIED DIMENSIONS ARE IN INCHES FRACTIONAL DIMENSIONS ANGLES TOLERANCES ARE: FRACTIONAL DIMENSIONS ANGLES DECIMAL DIMENSIONS ANGLES TOLERANCES ARE: FRACTIONAL DIMENSIONS ANGLES TOLERANCES ARE:		CONTRACT NO.	
DRAWN J.D. CLINGER		DATE 1-30-69	APPROVALS
CHECKED		RELEASED	
MATERIAL			
2100			
LONDON			
NEXT ASSEMBLY			
SIZE		CODE IDENT. NO.	DRAWING NO.
C	4J835	10712-50-0116	2100
CT SYSTEMS, INC.			
RS232 BD COMP LAYOUT			
SHEET 1 OF 1			

REV.	DATE	DESCRIPTION	APPROVED
1			
2			
3			
4			
5			
6			
7			
8			

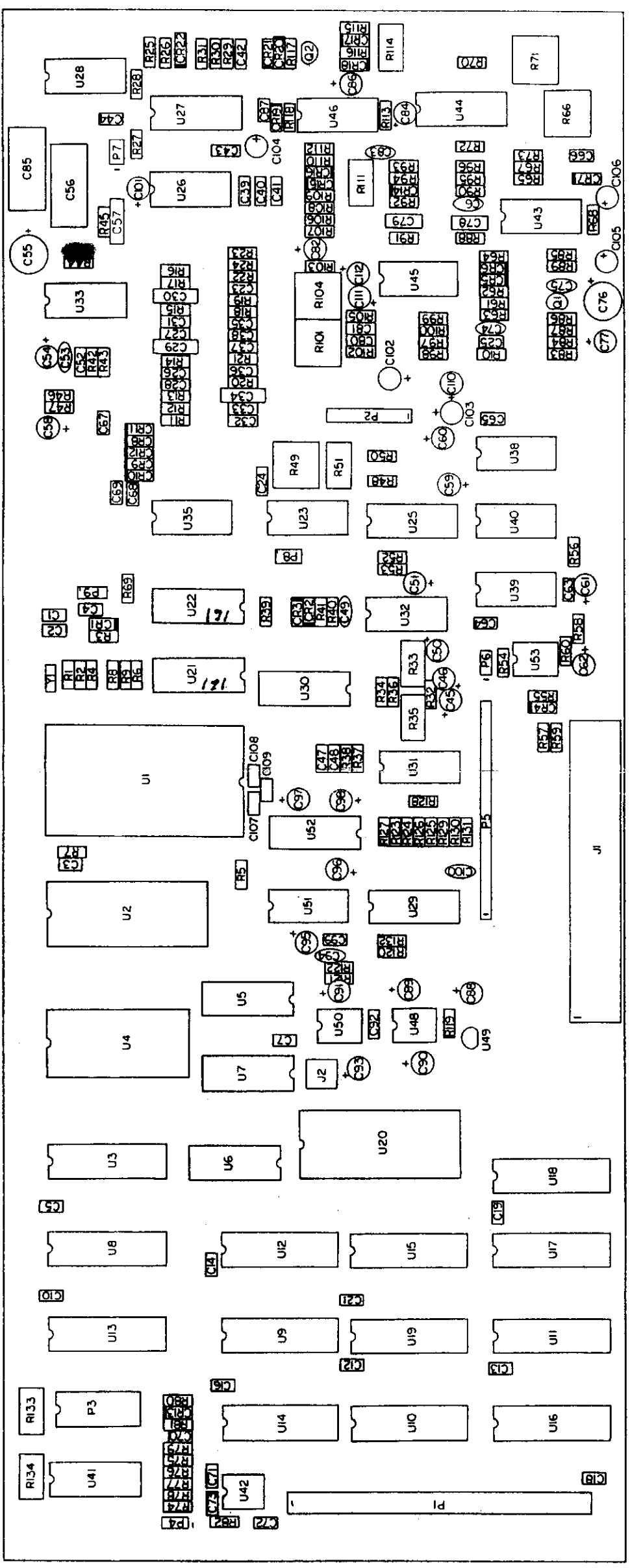

CT SYSTEMS, INC.	
CONTRACT NO.	DATE
DRAWING NO.	
PROCESSOR BD COMP LAYOUT	
2100	
SIZE	D
CODE	4J835
DRAWING NO.	10712-50-0113
SCALE	2:1
SHEET 1 OF 1	

NO.	DESCRIPTION	QUANTITY	UNIT
1			
2			
3			
4			
5			
6			
7			
8			
9			
10			
11			
12			
13			
14			
15			
16			
17			
18			
19			
20			
21			
22			
23			
24			
25			
26			
27			
28			
29			
30			
31			
32			
33			
34			
35			
36			
37			
38			
39			
40			
41			
42			
43			
44			
45			
46			
47			
48			
49			
50			
51			
52			
53			
54			
55			
56			
57			
58			
59			
60			
61			
62			
63			
64			
65			
66			
67			
68			
69			
70			
71			
72			
73			
74			
75			
76			
77			
78			
79			
80			
81			
82			
83			
84			
85			
86			
87			
88			
89			
90			
91			
92			
93			
94			
95			
96			
97			
98			
99			
100			

ZONE	LIN	REVISIONS	DESCRIPTION	DATE	APPROVED

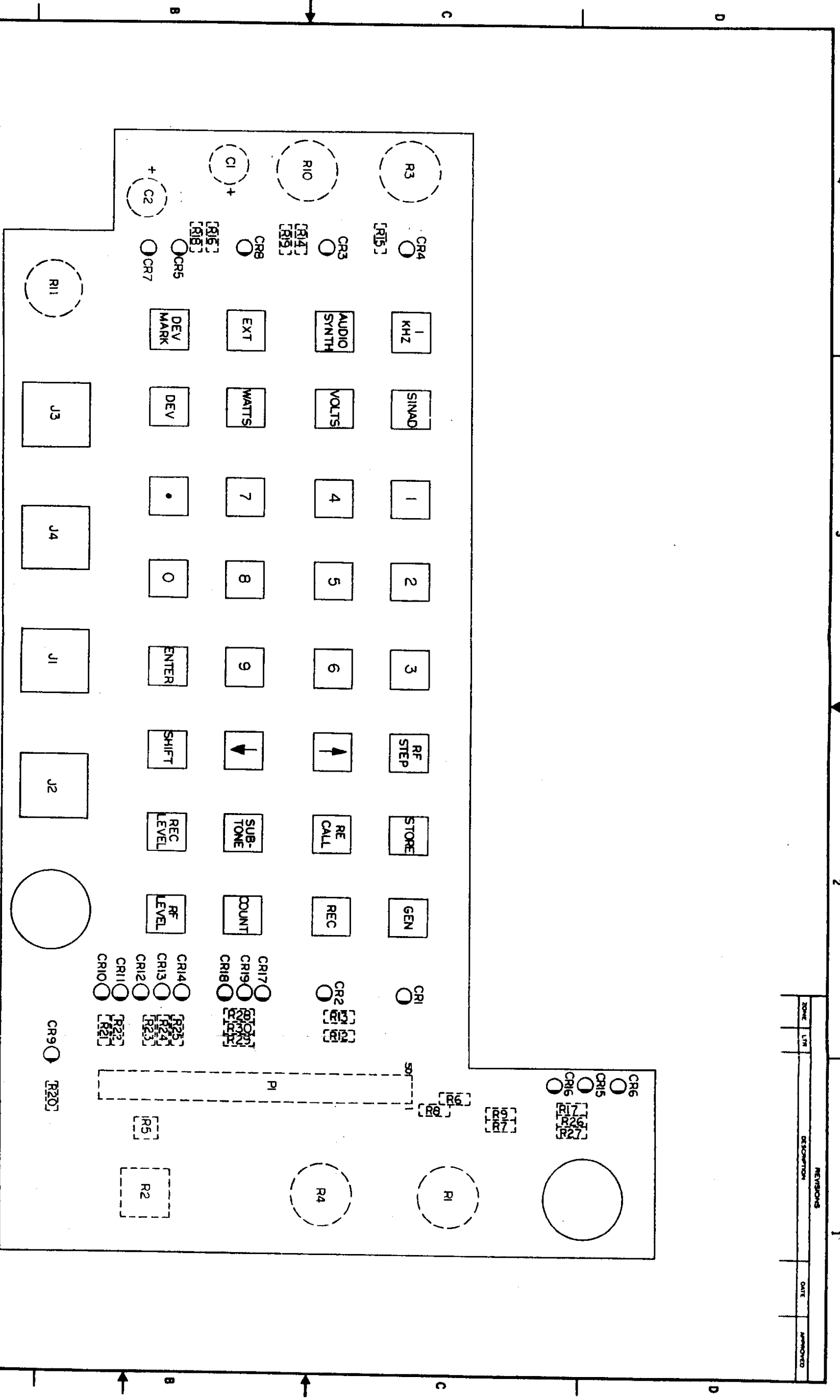

<b>CT SYSTEMS, INC.</b> FRONT PANEL BD COMP LAYOUT 2100		CONTRACT NO. DATE 1-21-67	CHECKED RELEASED
SIZE <b>C 4J835</b>	CODE IDENT. NO. 10712-50-0114	DRAWING NO.	SCALE 1:1
UNLESS OTHERWISE SPECIFIED DIMENSIONS ARE IN INCHES FRACTIONS DECIMALS ANGLES 1/16 32 45 90	INTERNAL 2001008	APPROVALS DATE 1-21-67	THE APPLICABLE SPECIFICATIONS ARE TO BE USED IN CONNECTION WITH THIS DRAWING.
NEXT DRAW APPLICATION	USED ON P7581	DO NOT SCALE DRAWING	RELEASED

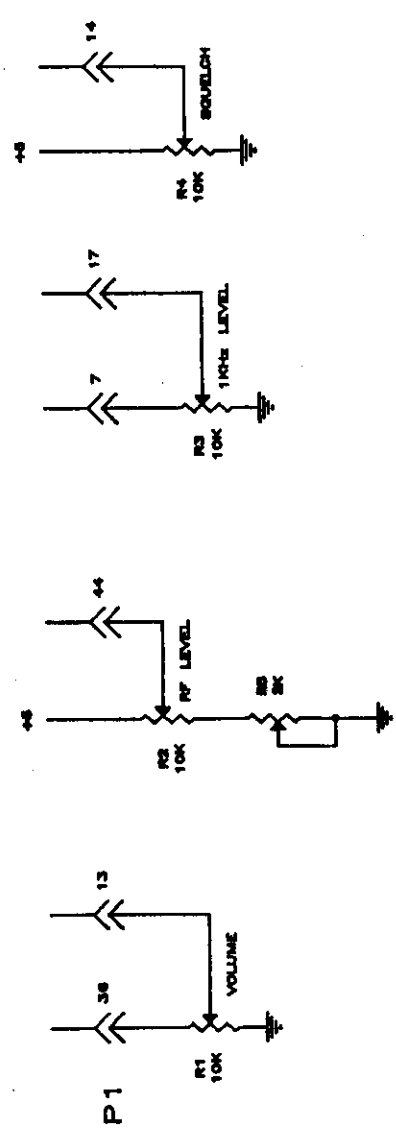
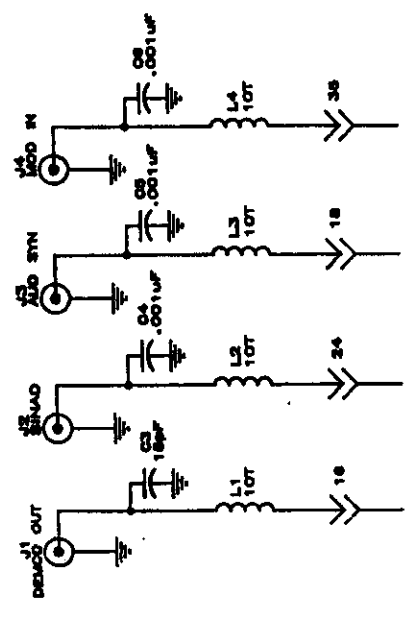
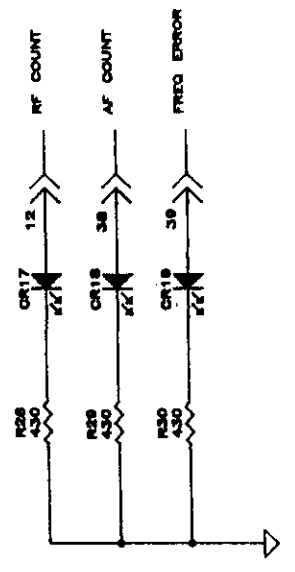
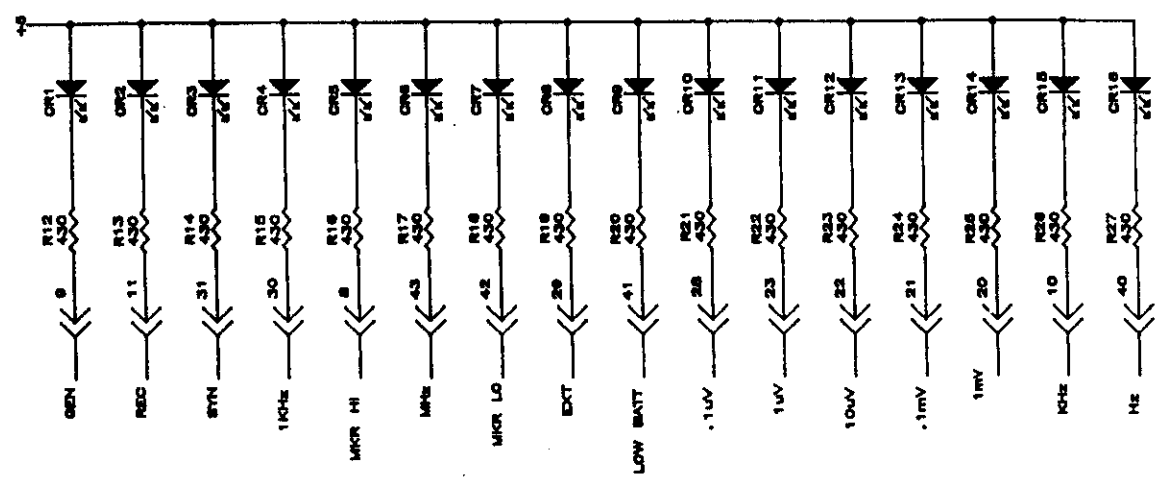
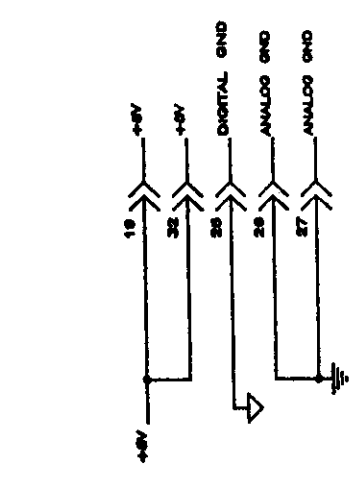

KEYPAD

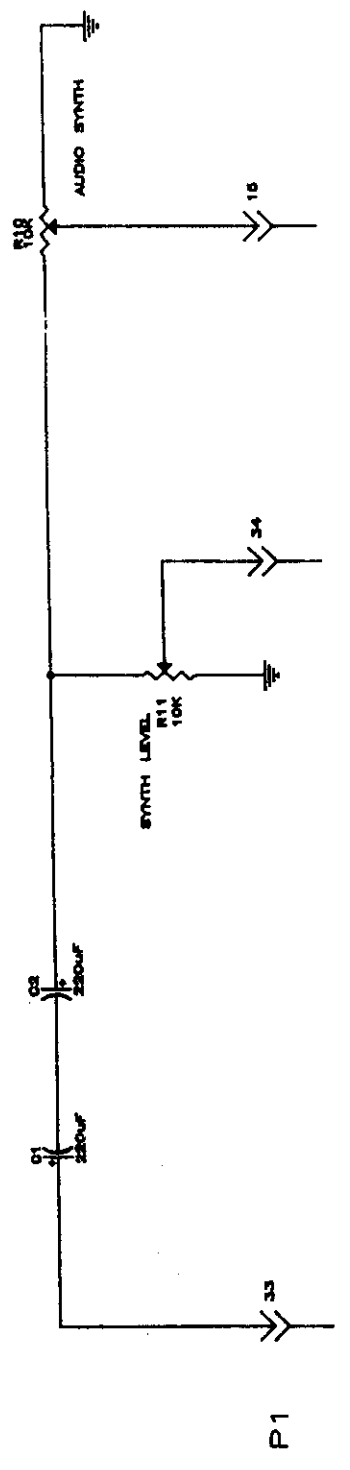
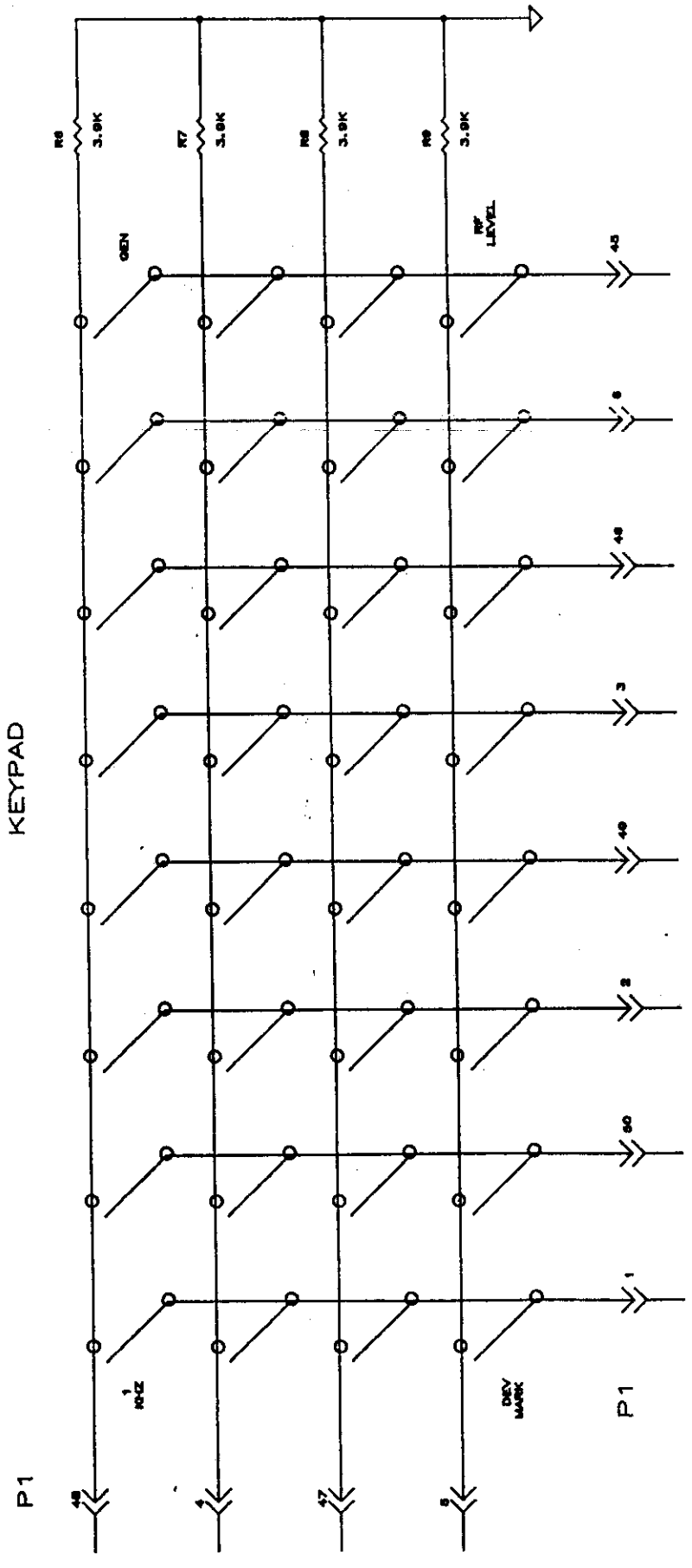



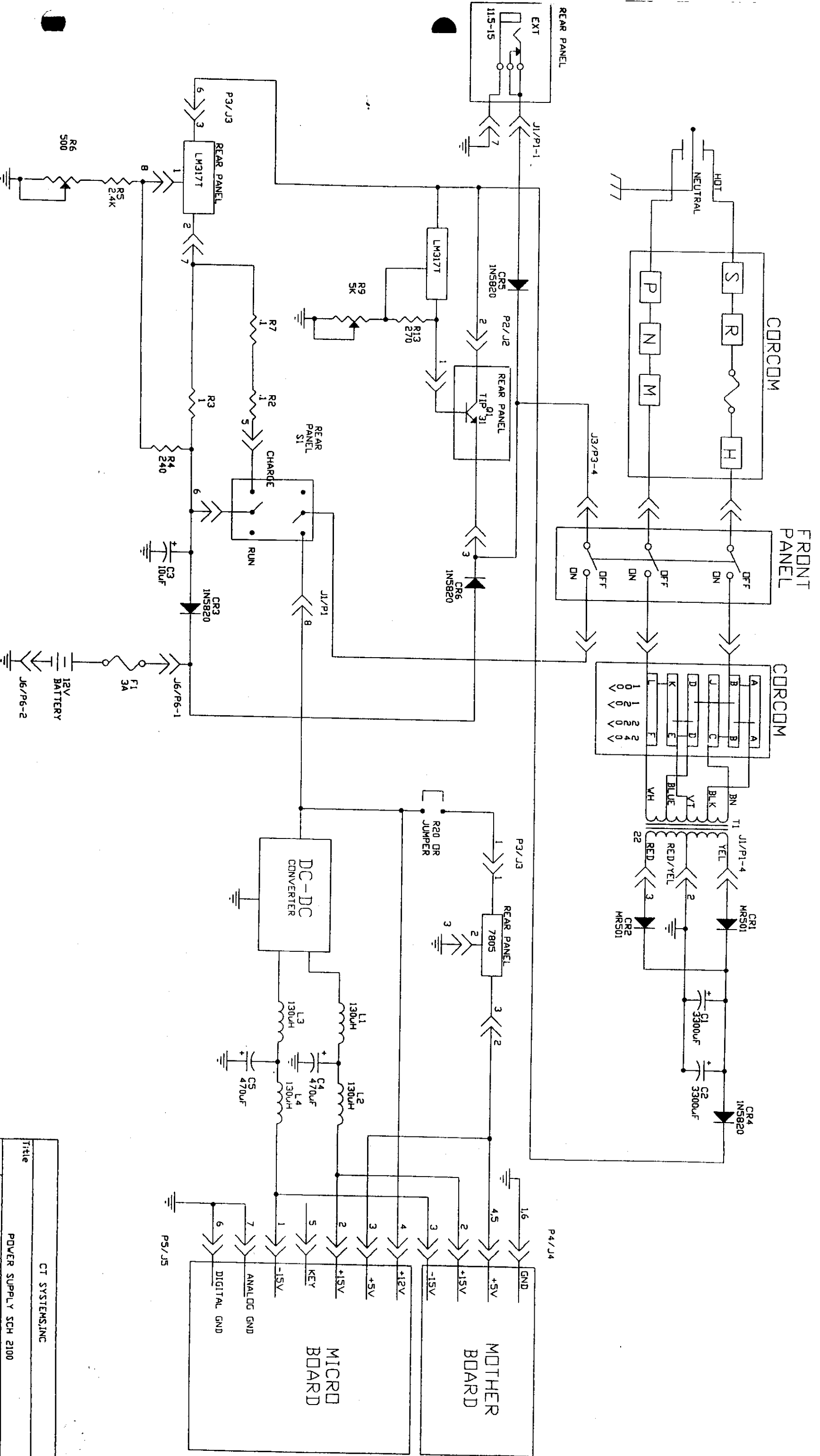

Title	POWER SUPPLY SCH 2100		
Size	Document Number	10714-20-0109	Sheet 1 of 1
Date:	March 1, 1989		

CT SYSTEMS, INC

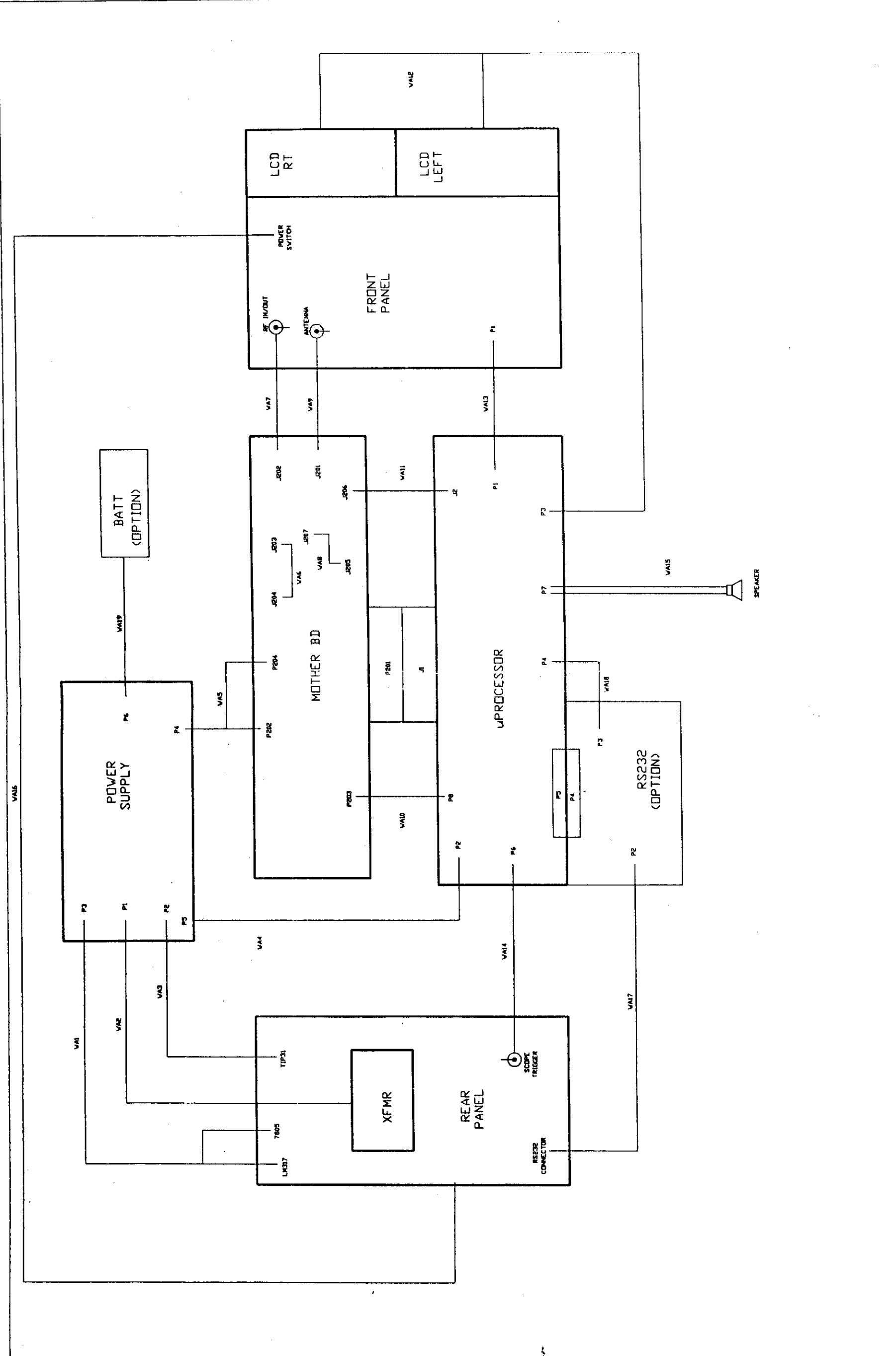

Title	CT SYSTEMS INC
Document Number	INTERCONNECTION DIAGRAM 2106
REV	C
Date	MAR 22 1989
Sheet	1 of 1

REVISIONS		DATE	APPROVED
ZONE	LINE	DESCRIPTION	

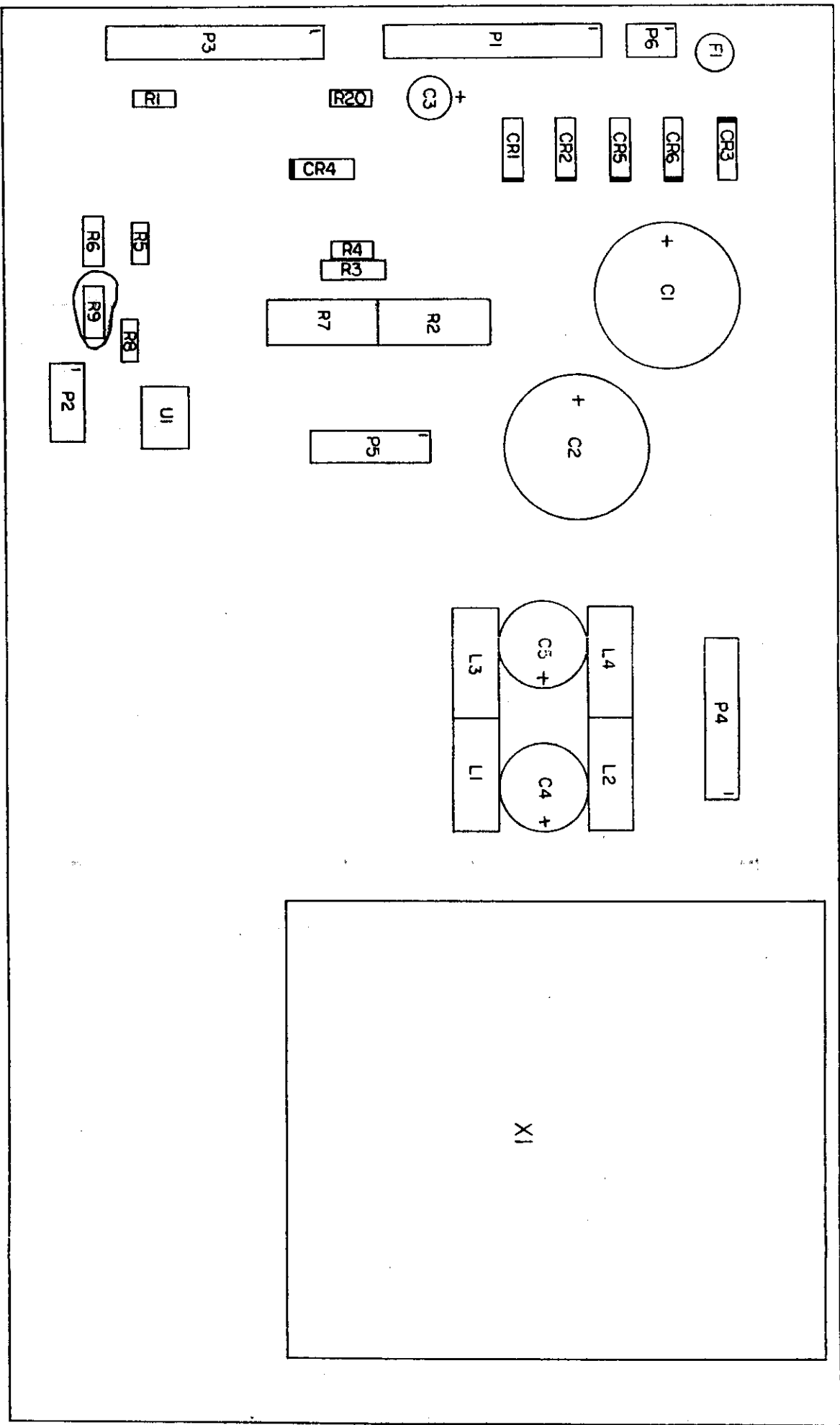

UNLESS OTHERWISE SPECIFIED DIMENSIONS ARE IN INCHES TOLERANCES ARE: ANGLES ± 1° 20' DIMENSIONS ± 0.005		CONTRACT NO.	
DATE	APPROVALS	DATE	APPROVALS
1-26-79	JDC		
DESIGNED	DRAWN	CHECKED	INCHES
CT SYSTEMS, INC.		DRAWING NO.	
PWR SUPPLY COMPONENT		10712-50-0112	
LAYOUT		2100	
SIZE	CODE IDENT. NO.	NEXT DRAWING	
C	4J835	2100	

(D)

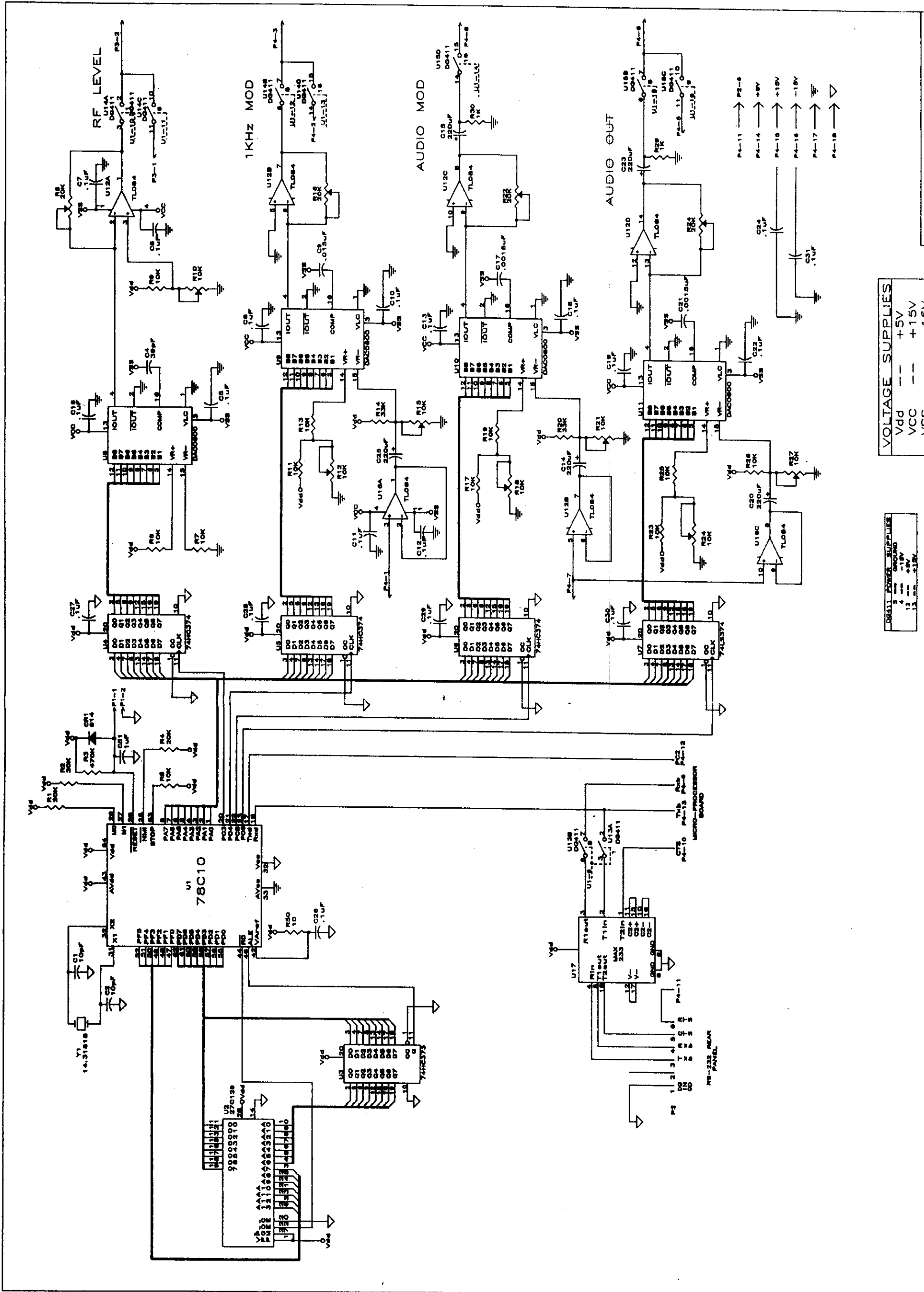

**VOLTAGE SUPPLIES**

Vdd	+	+5V
VCC	+	+15V
VSS	-	-15V

**DRILL POWER SUPPLIES**

1	GROUND
2	+5V
3	+15V
4	-15V

C.T. SYSTEMS  
 MODEL ALGO SE-28 BOARD  
 10714-25-0007  
 REV A



ITEM	REF	DES
1	C335	
2	C338	
3	C377	
4	C352	
5	C315	
6	C317	
7	C348	
8	C319	
9	C321	
10	R315	
11	C320	
12	C322	
13	R316	
14	C324	
15	C339	
16	C323	
17	CR231	
18	CR232	
19	R327	
20	R328	
21	CR233	
22	CR234	
23	C381	
24	C340	
25	C349	
26	R345	
27	R344	
28	C348	
29	R346	
30	R352	
31	C354	
32	C361	
33	C343	
34	C360	
35	C345	
36	C342	
37	C344	
38	R266	
39	C284	
40	CR221	
41	R264	
42	R261	
43	R259	
44	CR215	
45	R260	
46	CR220	
47	C286	
48	CR218	
49	R255	
50	R254	
51	CR214	
52	R256	
53	CR219	
54	C282	
55	C281	
56	CR213	
57	C280	
58	CR210	
59	CR211	
60	CR212	
61	R252	
62	C283	
63	C279	
64	C278	
65	R326	

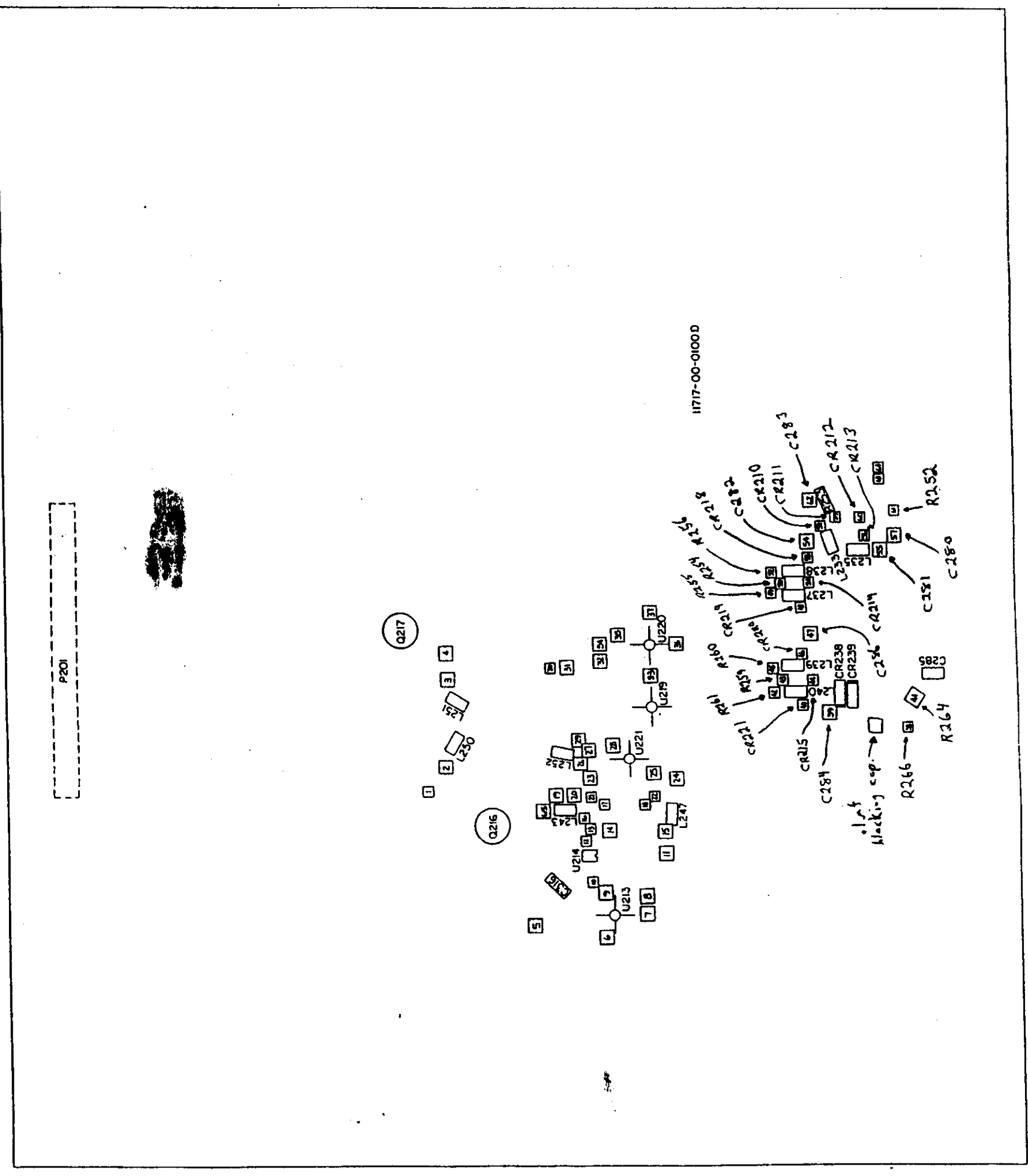

**CT SYSTEMS, INC.**  
 MOTHER BD COMP LAYOUT  
 2100  
**D 4J835** 10712-50-0115  
 SCALE 2:1 SHEET 2 OF 2

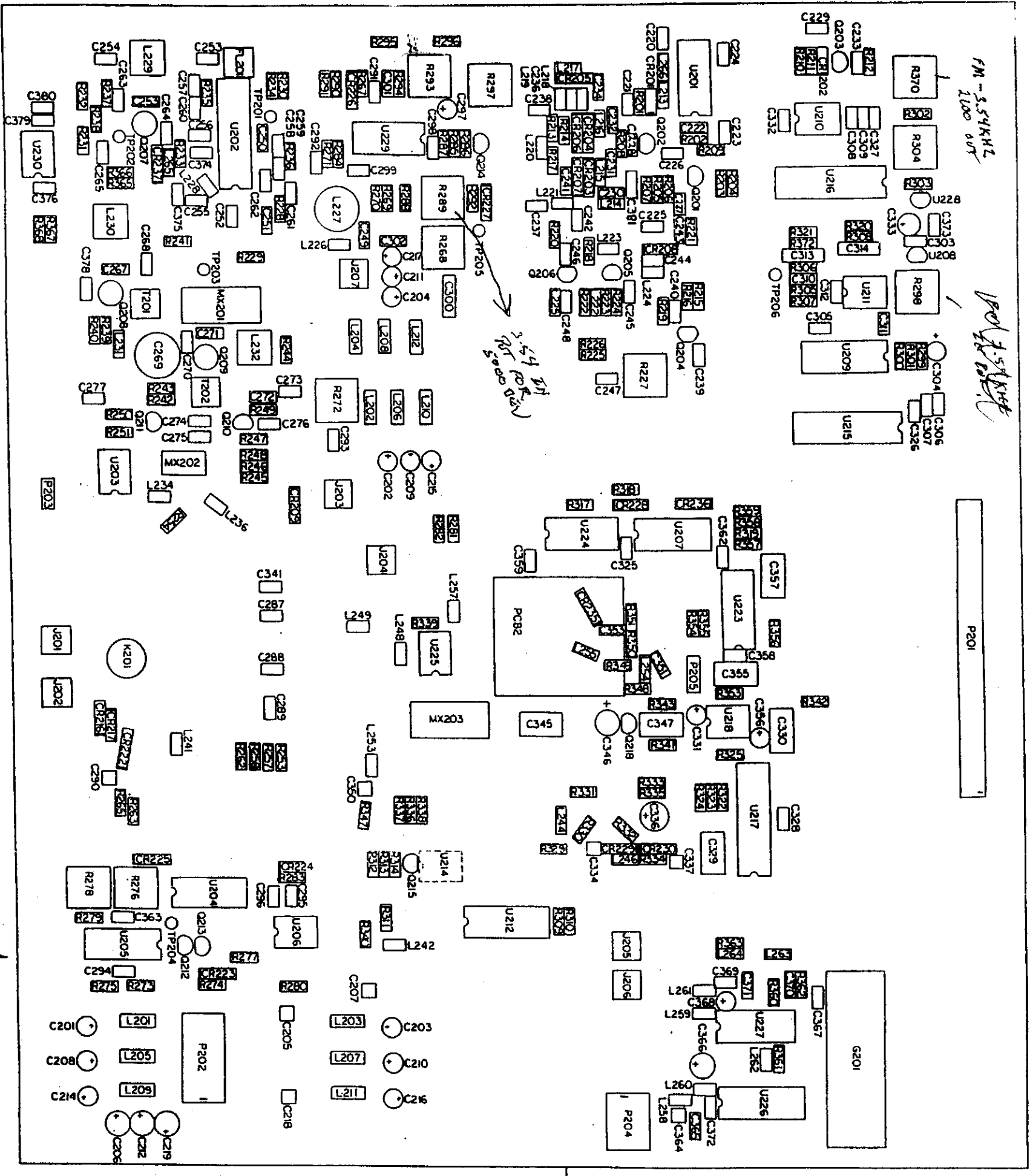

CT SYSTEMS, INC.	
MOTHER BD COMP LAYOUT	
DATE: 6-13-81	DRAWING NO: 89066
DESIGNER: [Name]	CHECKED: [Name]
DATE: 6-13-81	DATE: 6-13-81
SCALE: 1" = 1"	SHEET: 2 OF 2

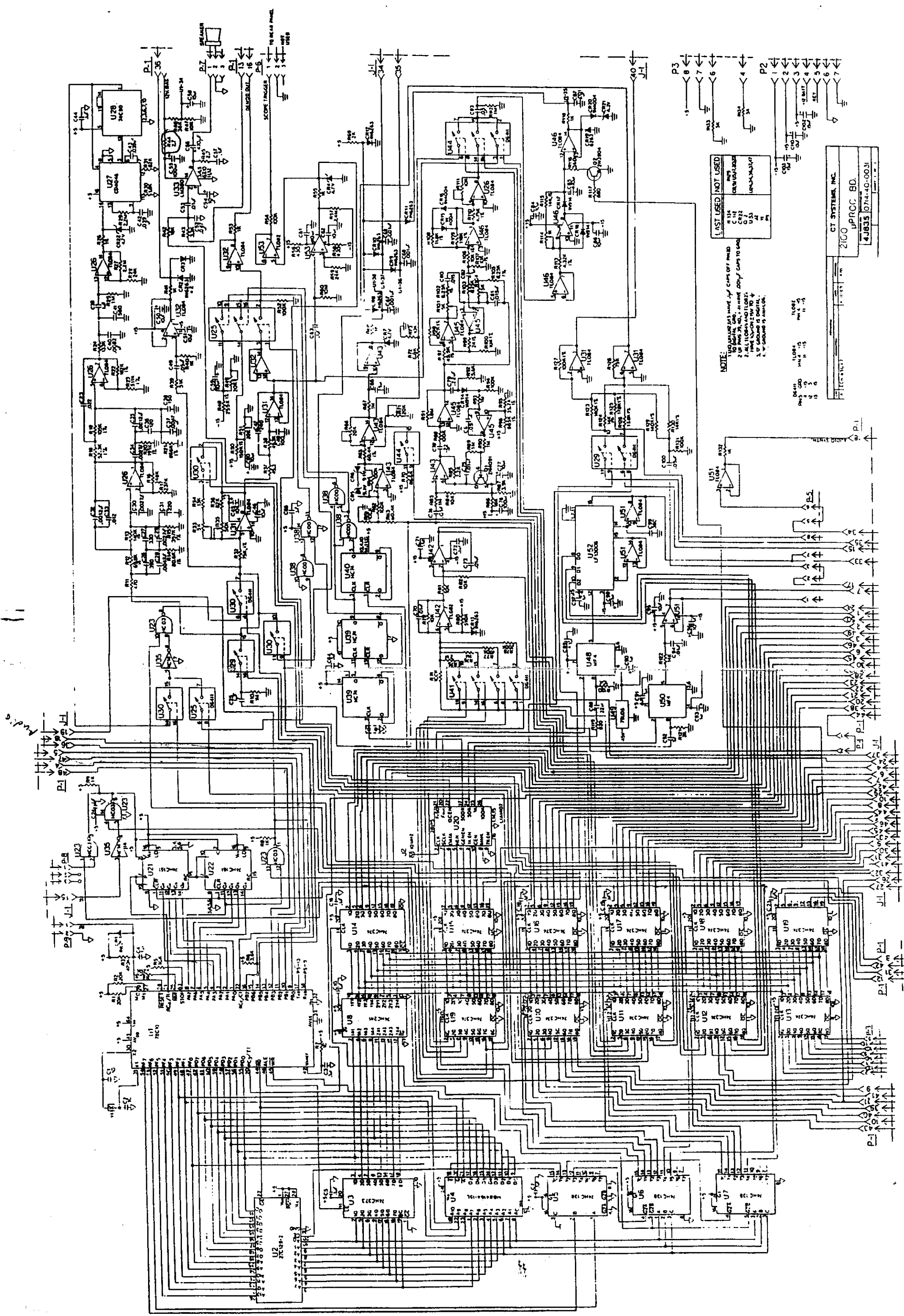

NOTE: 1. ALL PARTS MUST BE OF THE QUALITY SPECIFIED IN THIS LIST. 2. IN THIS LIST, ALL PARTS ARE LISTED AS TO BE USED UNLESS OTHERWISE SPECIFIED. 3. ALL PARTS ARE LISTED AS TO BE USED UNLESS OTHERWISE SPECIFIED.

LAST USED NOT USED	
U14	✓
U15	✓
U16	✓
U17	✓
U18	✓
U19	✓
U20	✓
U21	✓
U22	✓
U23	✓
U24	✓
U25	✓
U26	✓
U27	✓
U28	✓
U29	✓
U30	✓
U31	✓
U32	✓
U33	✓
U34	✓
U35	✓
U36	✓
U37	✓
U38	✓
U39	✓
U40	✓
U41	✓
U42	✓
U43	✓
U44	✓
U45	✓
U46	✓
U47	✓
U48	✓
U49	✓
U50	✓
U51	✓
U52	✓

U14 U15 U16 U17 U18 U19 U20 U21 U22 U23 U24 U25 U26 U27 U28 U29 U30 U31 U32 U33 U34 U35 U36 U37 U38 U39 U40 U41 U42 U43 U44 U45 U46 U47 U48 U49 U50 U51 U52

CT SYSTEMS, INC.  
2100  
UPROCC. BD.  
4J835 (D714-40-003)